

Middle Channel

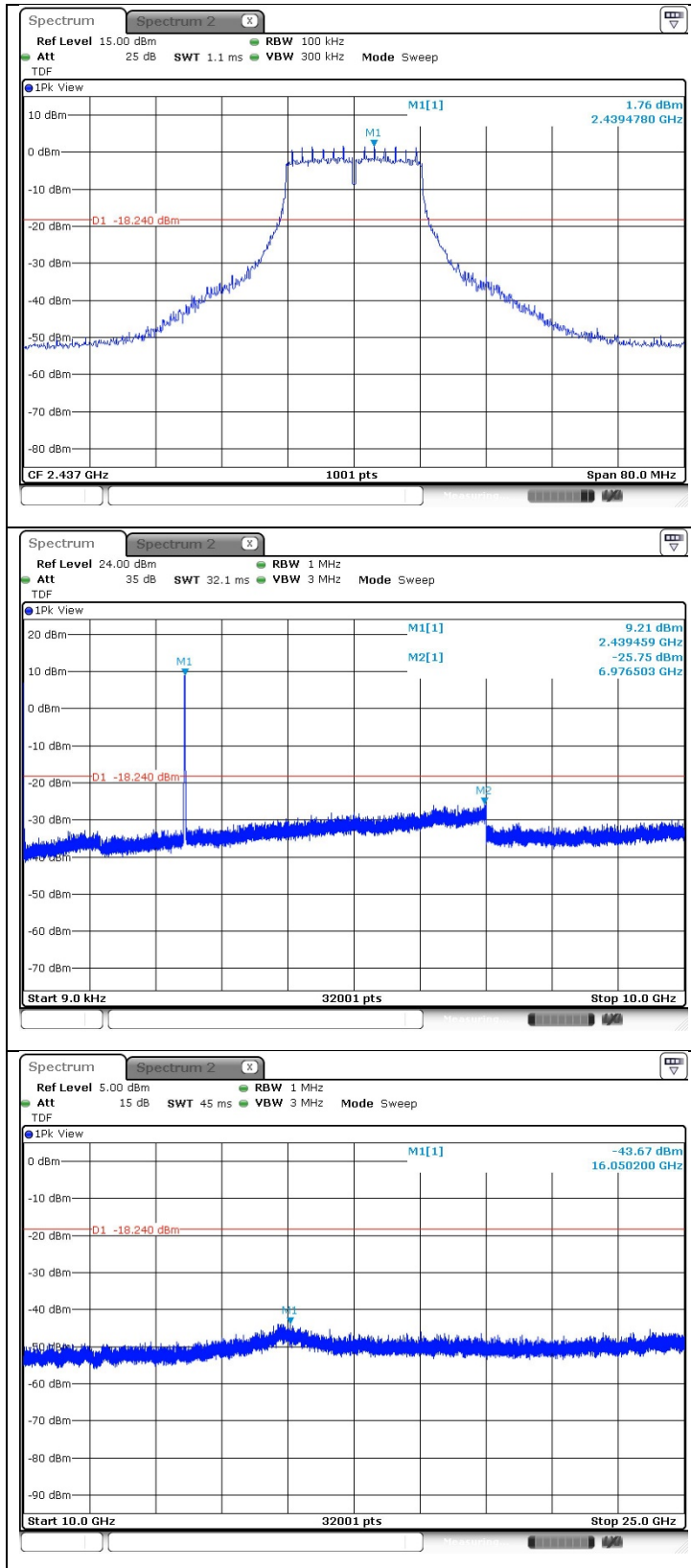

High Channel

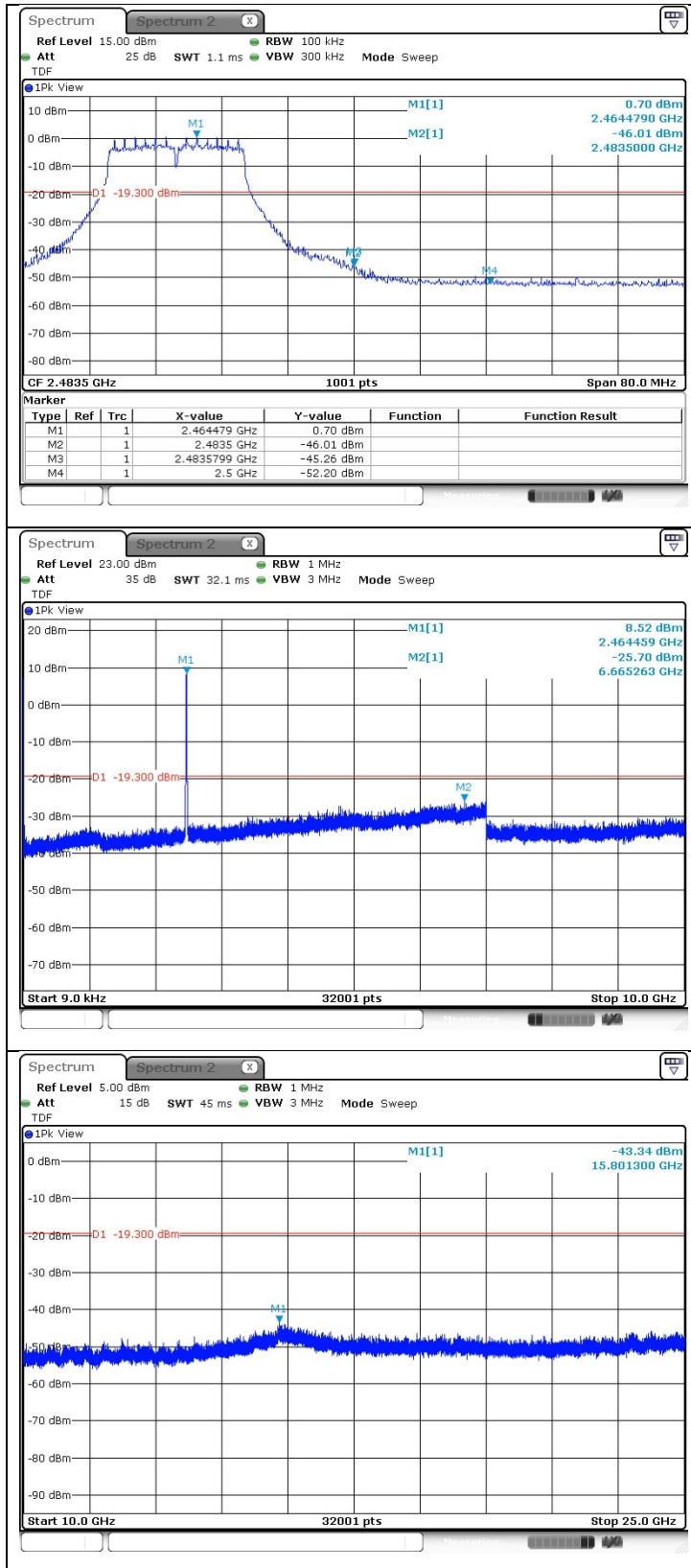

OFDM: 11n_HT20

Low Channel

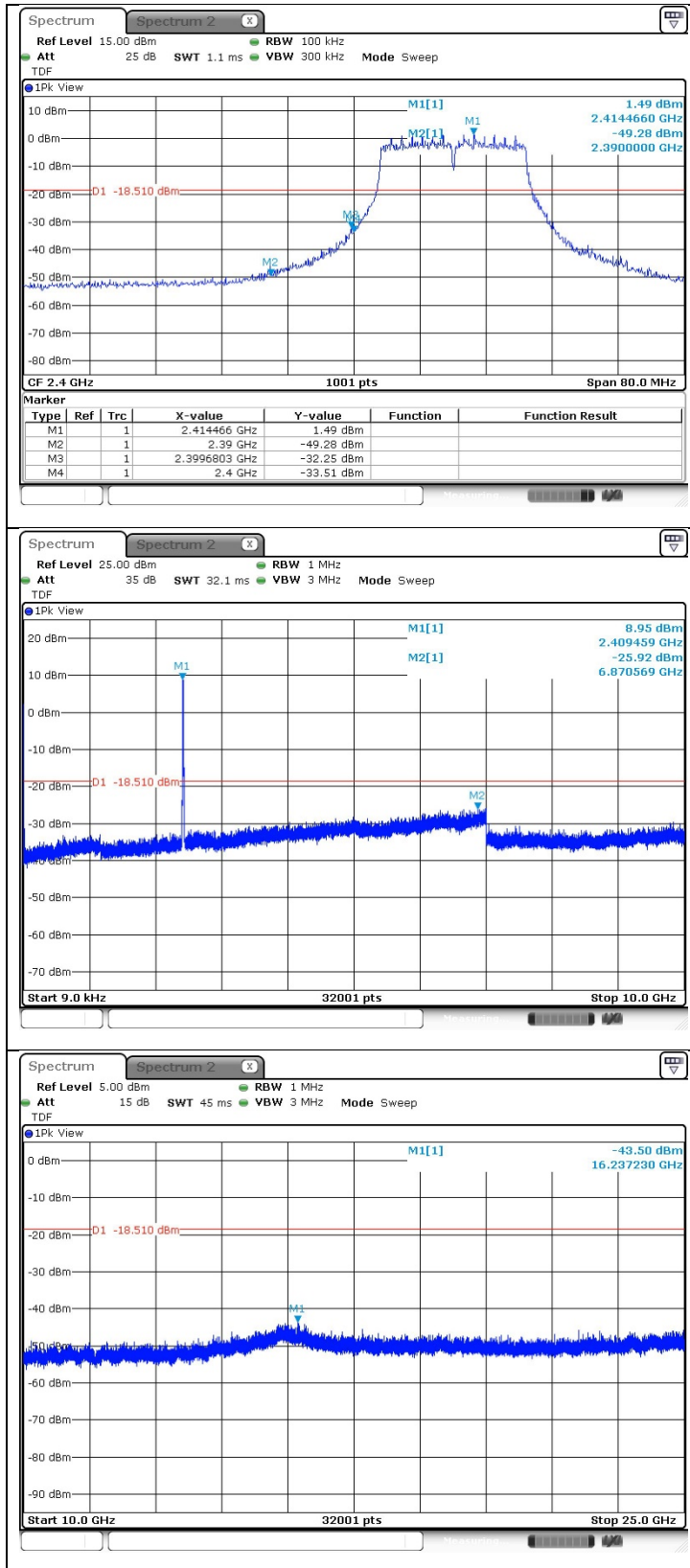

Middle Channel

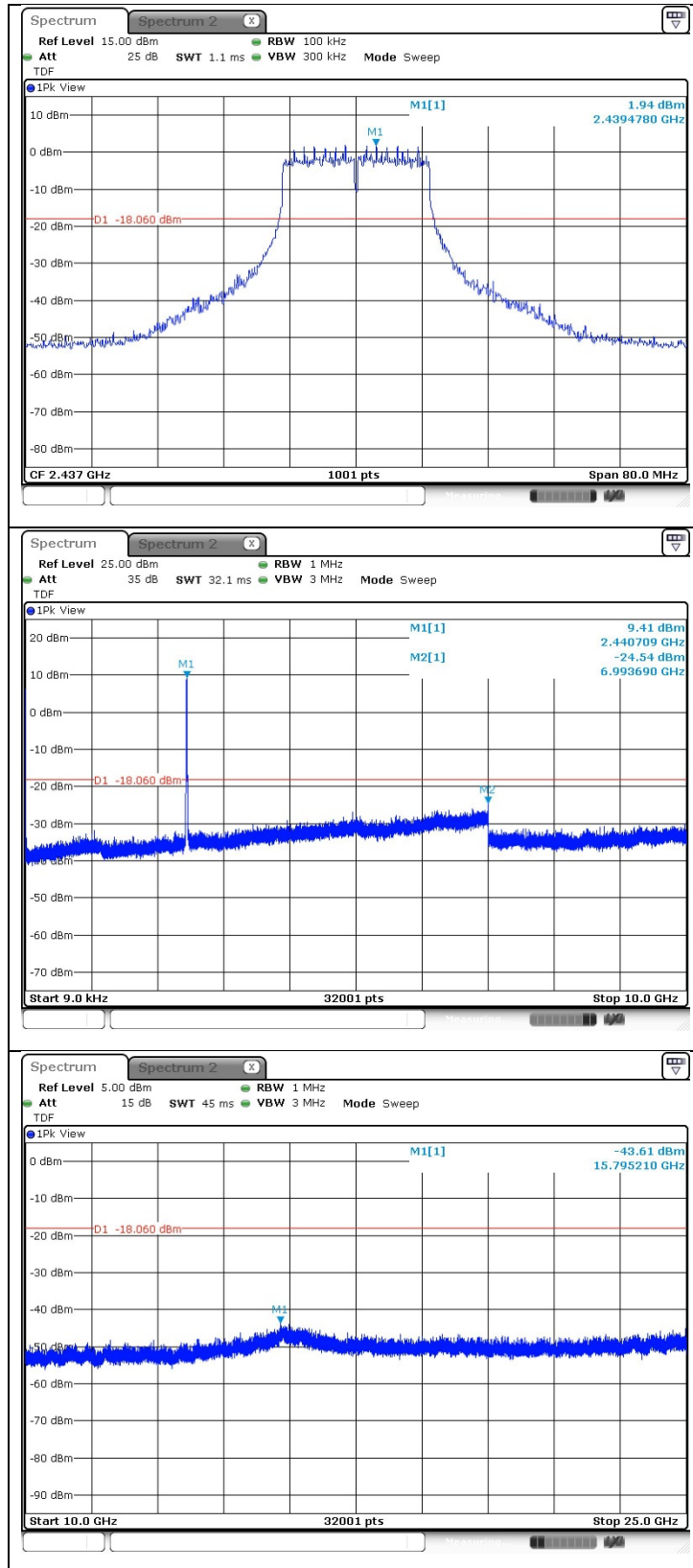

High Channel

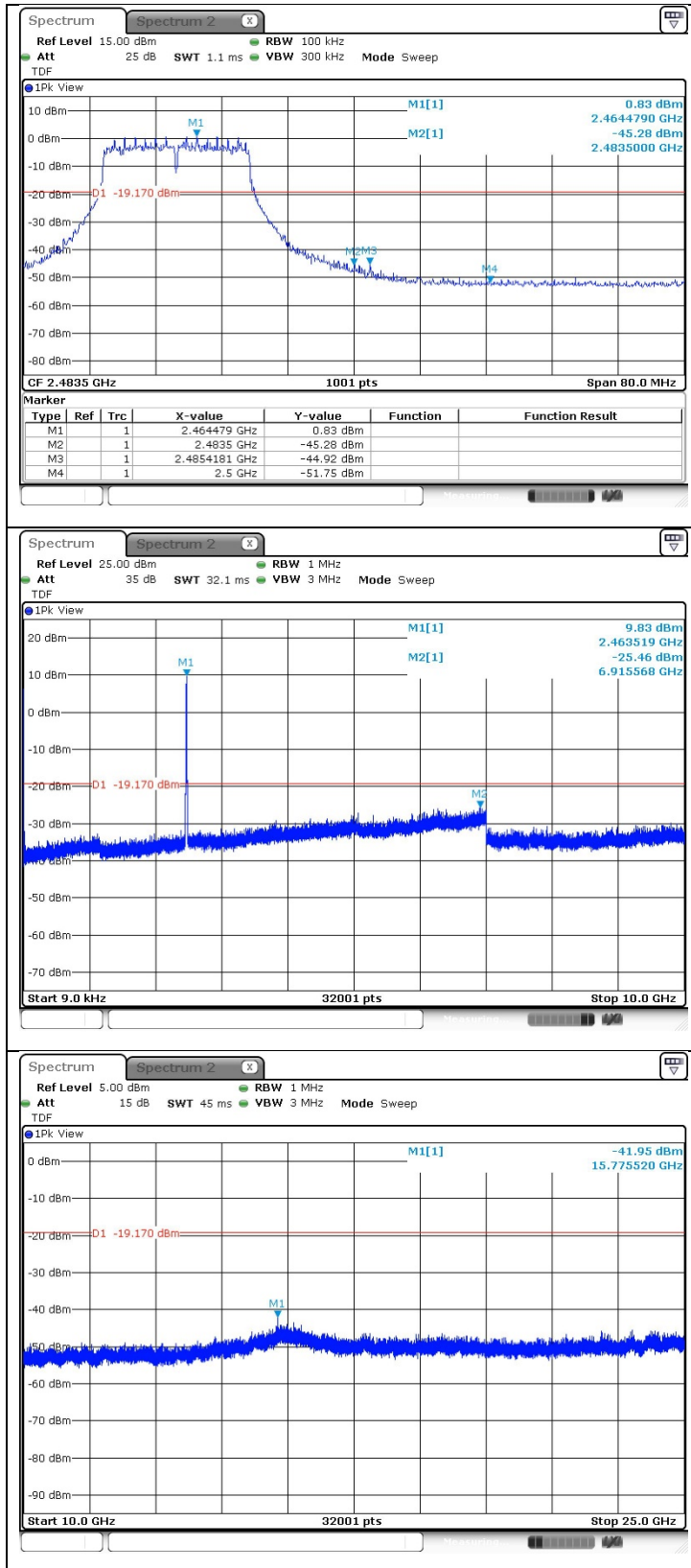

3. 6 dB Bandwidth and 99 % Bandwidth

3.1. Test Setup



3.2. Limit

3.2.1. FCC

According to §15.247(a)(2), systems using digital modulation techniques may operate in the 902-928 MHz, 2 400-2 483.5 MHz, and 5 725-5 850 MHz bands. The minimum 6 dB bandwidth shall be at least 500 kHz.

3.2.2. IC

According to RSS-247 Issue 2, 5.2(a), the minimum 6 dB bandwidth shall be 500 kHz.

3.3. Test Procedure

3.3.1. 6 dB Bandwidth

The test follows section 11.8 DTS bandwidth of ANSI C63.10-2013.

Tests performed using section 11.8.1 Option 1.

- Option 1:

1. Set RBW to = 100 kHz.
2. Set the VBW \geq [3 x RBW].
3. Detector = peak.
4. Trace mode = max hold.
5. Sweep = auto couple.
6. Allow the trace to stabilize.
7. Measure the maximum width of the emission that is constrained by the frequencies associated with the two outermost amplitude points (upper and lower frequencies) that are attenuated by 6 dB relative to the maximum level measured in the fundamental emission.

3.3.2. 99 % Bandwidth

- The span of the spectrum analyzer shall be set large enough to capture all products of the modulation process, including the emission skirts, around the carrier frequency, but small enough to avoid having other emissions (e.g. on adjacent channels) within the span.
- The detector of the spectrum analyzer shall be set to "Sample". However, a peak, or peak hold, may be used in place of the sampling detector since this usually produces a wider bandwidth than the actual bandwidth (worst-case measurement). Use of a peak hold (or "Max Hold") may be necessary to determine the occupied / x dB bandwidth if the device is not transmitting continuously.
- The resolution bandwidth (RBW) shall be in the range of 1 % to 5 % of the actual occupied / x dB bandwidth and the video bandwidth (VBW) shall not be smaller than three times the RBW value. Video averaging is not permitted.

Note: It may be necessary to repeat the measurement a few times until the RBW and VBW are in compliance with the above requirement.

For the 99 % emission bandwidth, the trace data points are recovered and directly summed in linear power level terms. The recovered amplitude data points, beginning at the lowest frequency, are placed in a running sum until 0.5 % of the total is reached, and that frequency recorded. The process is repeated for the highest frequency data points (starting at the highest frequency, at the right side of the span, and going down in frequency). This frequency is then recorded. The difference between the two recorded frequencies is the occupied bandwidth (or the 99 % emission bandwidth).

3.4. Test Results

Ambient temperature : (23 ± 1) °C
 Relative humidity : 47 % R.H.

Mode	Channel	Frequency (MHz)	6 dB Bandwidth (MHz)	Minimum Bandwidth (kHz)
DSSS (11b)	Low	2 412	9.071	500
	Middle	2 437	9.031	
	High	2 462	8.991	
OFDM (11g)	Low	2 412	16.384	
	Middle	2 437	16.384	
	High	2 462	16.384	
OFDM (11n_HT20)	Low	2 412	17.742	
	Middle	2 437	17.742	
	High	2 462	17.702	

Mode	Channel	Frequency (MHz)	99 % Bandwidth (MHz)	Limit (MHz)
DSSS (11b)	Low	2 412	14.066	-
	Middle	2 437	14.186	
	High	2 462	14.106	
OFDM (11g)	Low	2 412	16.983	
	Middle	2 437	17.103	
	High	2 462	17.143	
OFDM (11n_HT20)	Low	2 412	17.982	
	Middle	2 437	17.902	
	High	2 462	17.942	

- Test plots

6 dB Bandwidth

DSSS: 11b

Low Channel

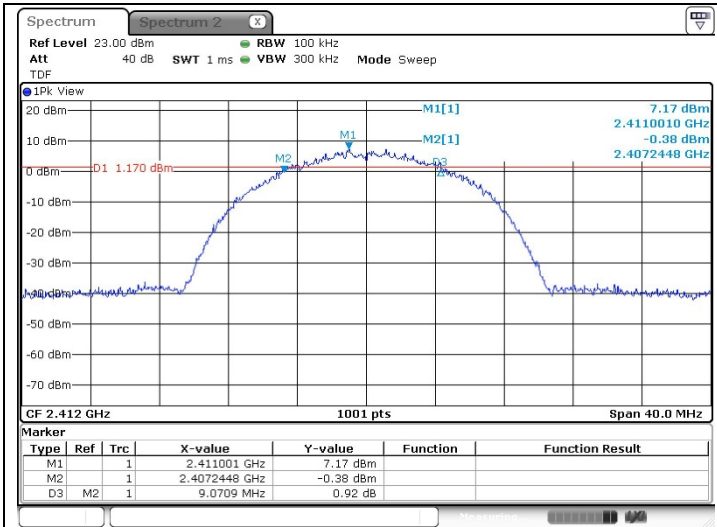

Middle Channel

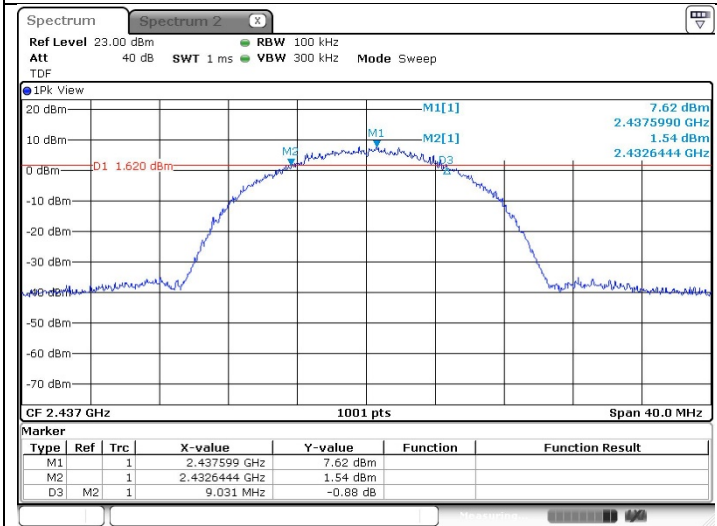

High Channel

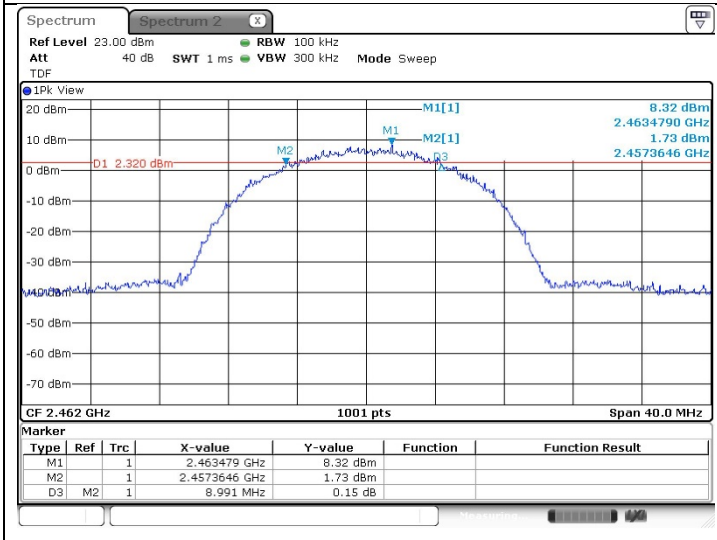

OFDM: 11g

Low Channel

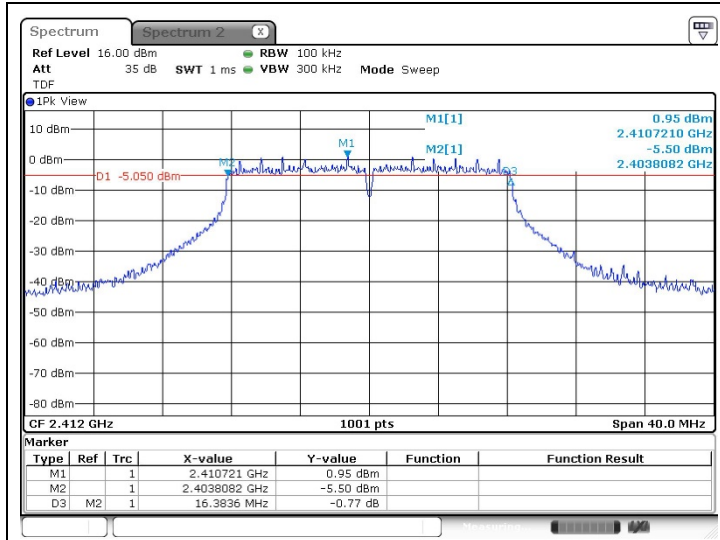

Middle Channel

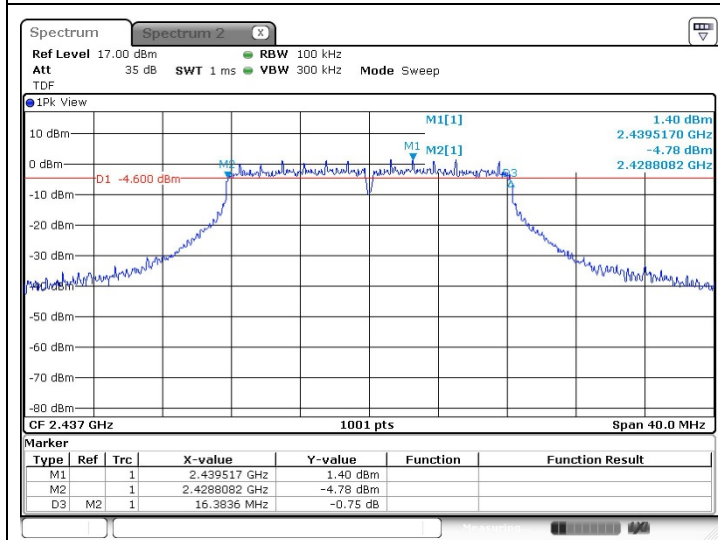

High Channel

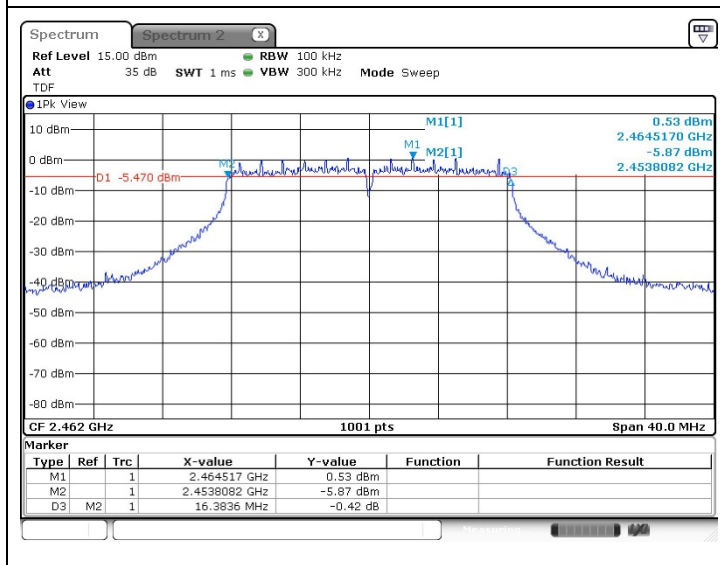

OFDM: 11n_HT20

Low Channel

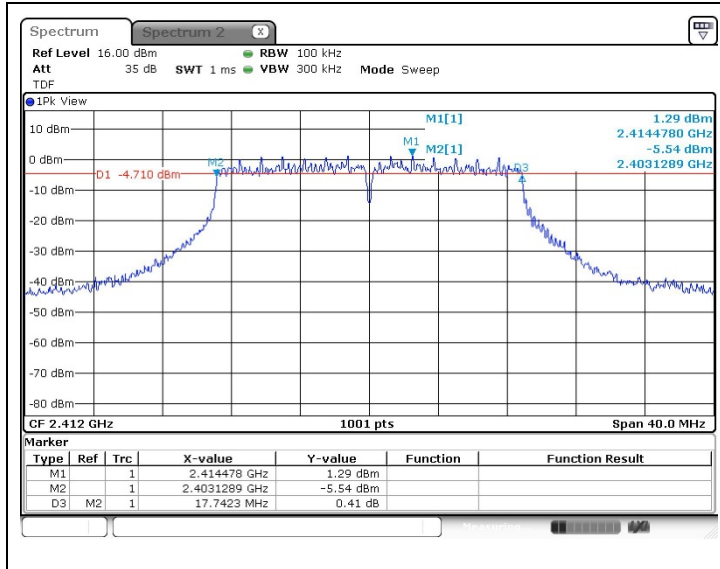

Middle Channel

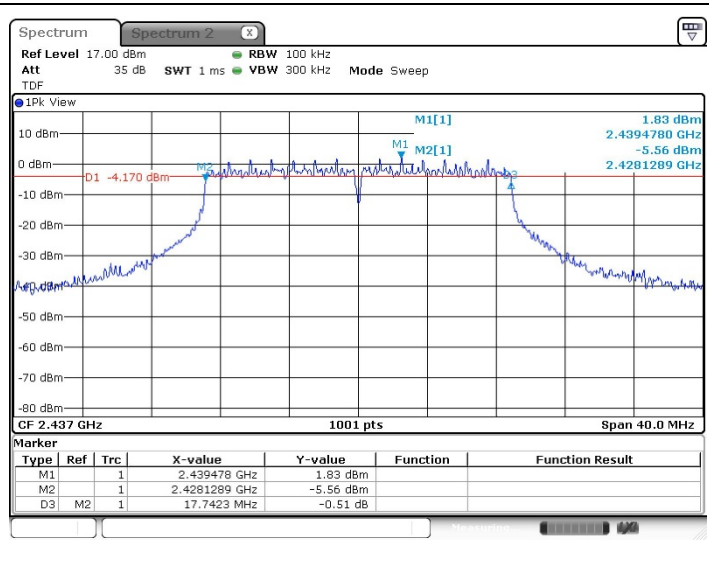

High Channel

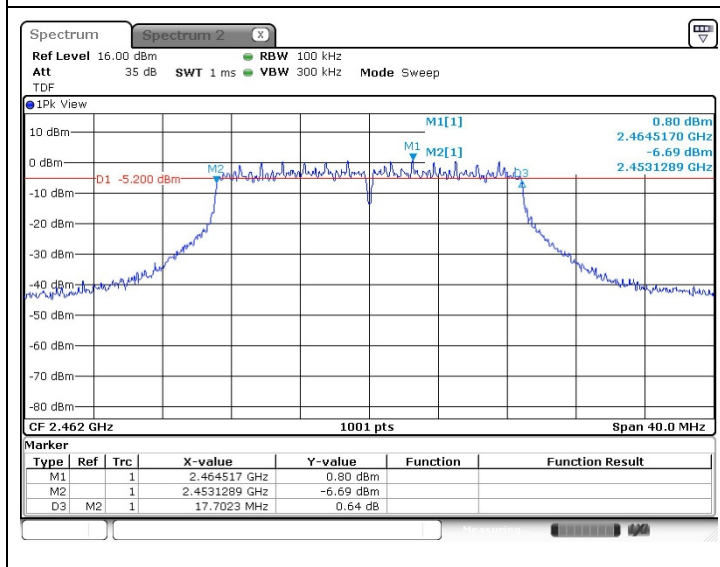

99 % Bandwidth

DSSS: 11b

Low Channel

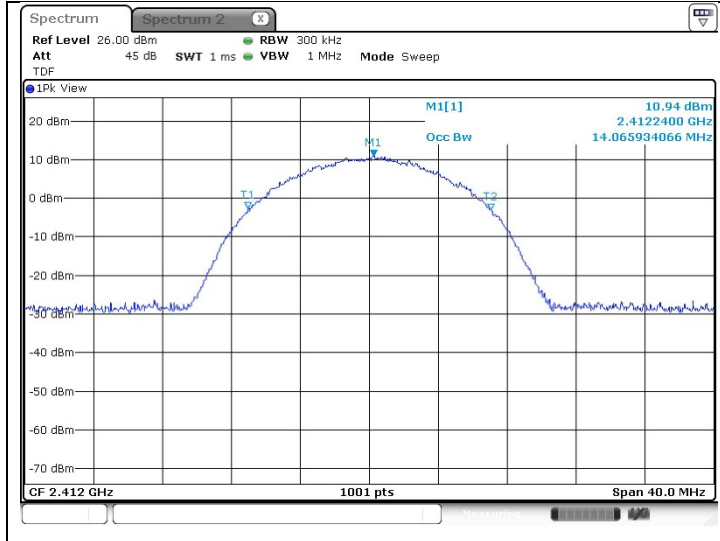

Middle Channel

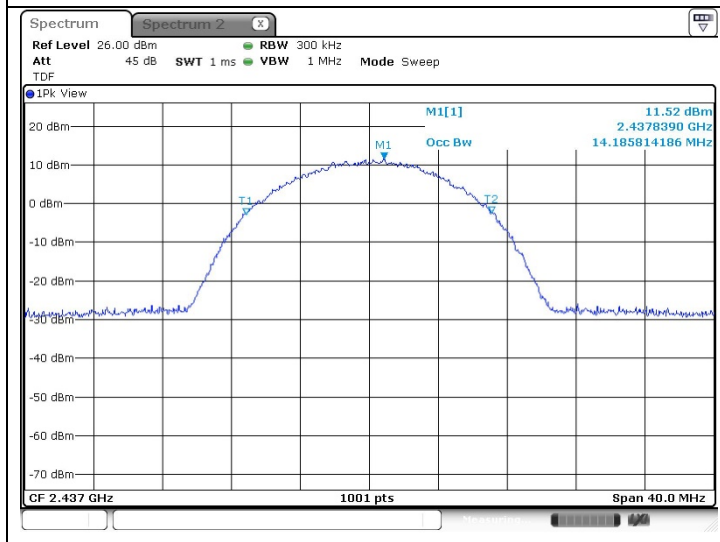

High Channel

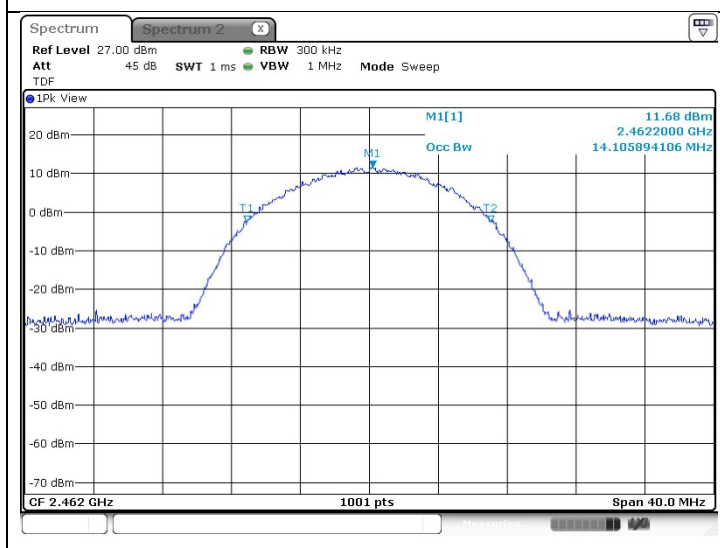

OFDM: 11g

Low Channel

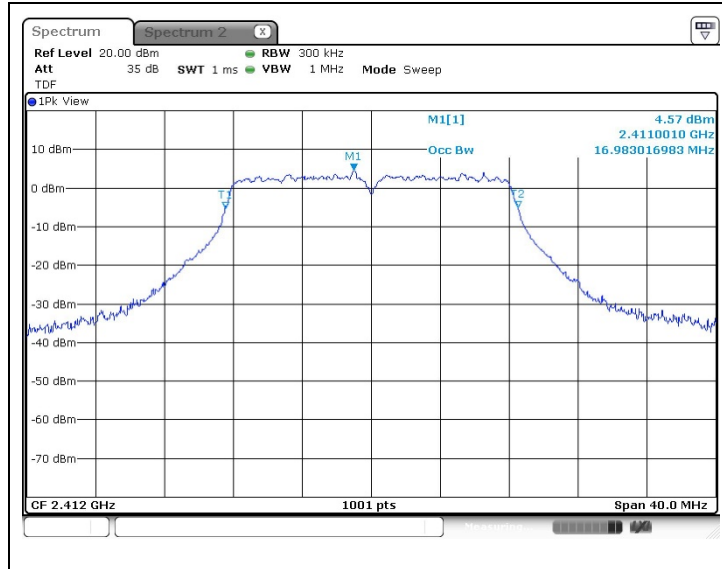

Middle Channel

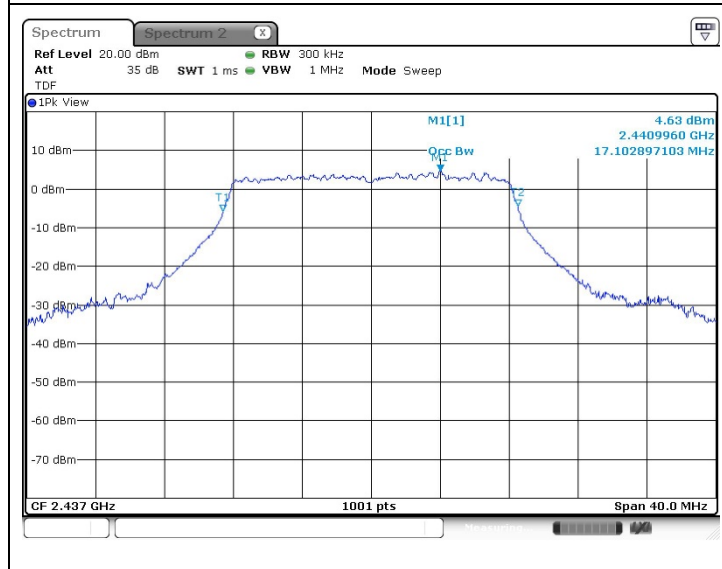

High Channel

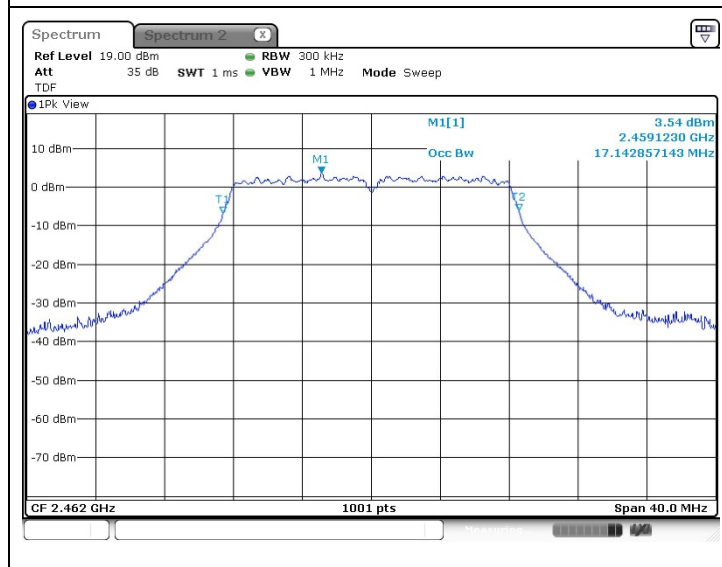

OFDM: 11n_HT20

Low Channel

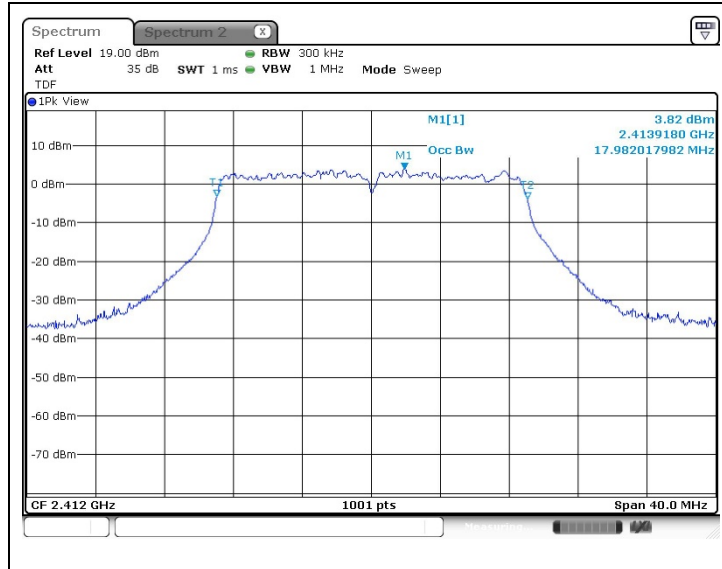

Middle Channel

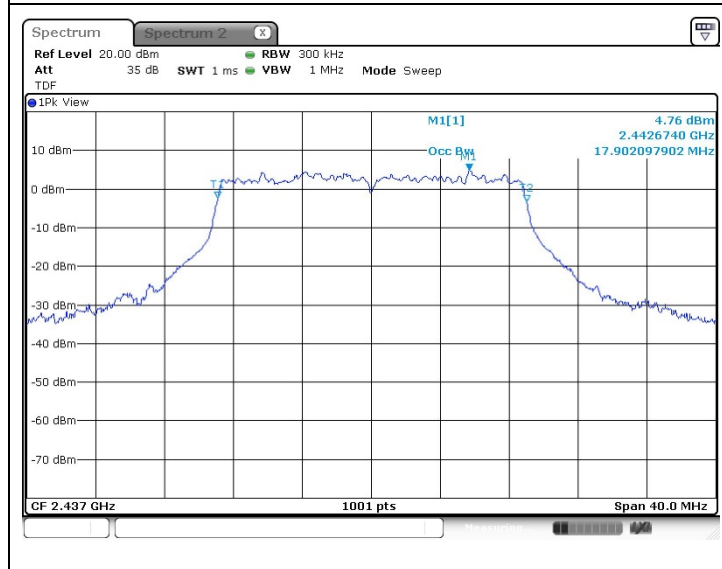

High Channel

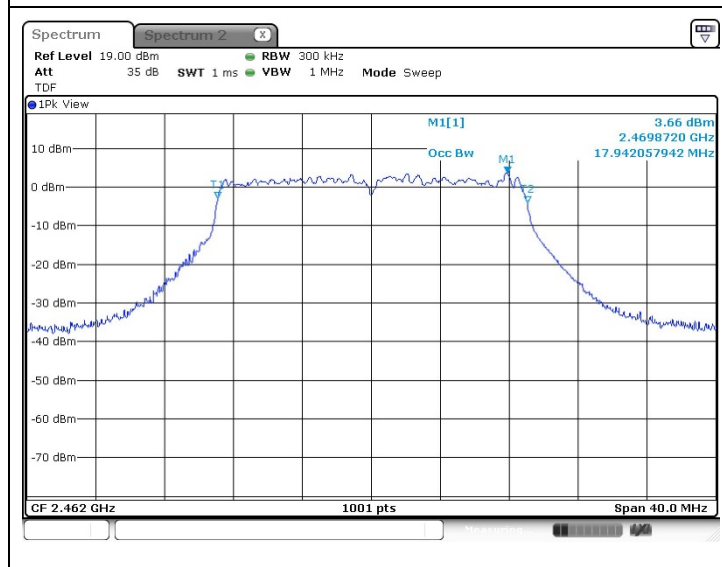

4. Maximum Peak Conducted Output Power

4.1. Test Setup

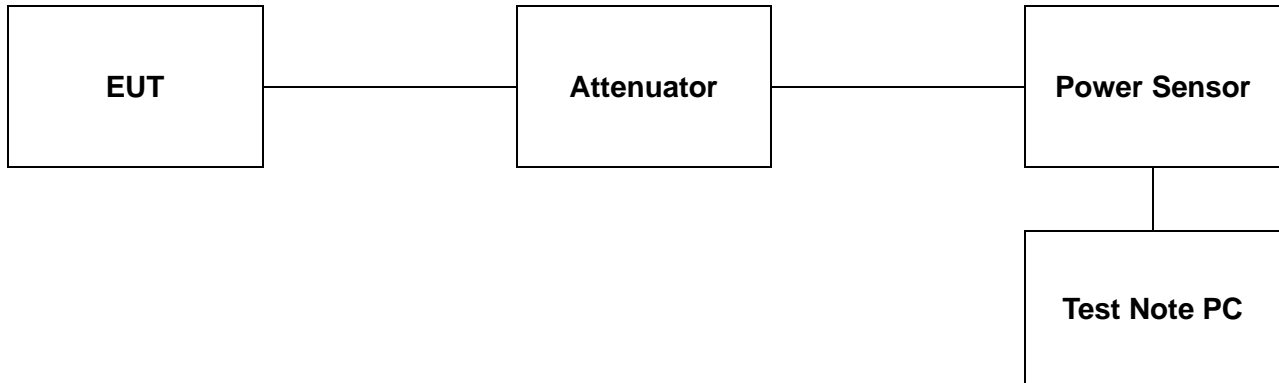

4.2. Limit

4.2.1. FCC

According to §15.247(b)(3), for systems using digital modulation in the 902-928 MHz, 2 400-2 483.5 MHz, and 5 725-5 850 MHz bands: 1 Watt. As an alternative to a peak power measurement, compliance with the one Watt limit can be based on a measurement of the maximum conducted output power. Maximum Conducted Output Power is defined as the total transmit power delivered to all antennas and antenna elements averaged across all symbols in the signaling alphabet when the transmitter is operating at its maximum power control level. Power must be summed across all antennas and antenna elements. The average must not include any time intervals during which the transmitter is off or is transmitting at a reduced power level. If multiple modes of operation are possible (e.g., alternative modulation methods), the maximum conducted output power is the highest total transmit power occurring in any mode.

According to §15.247(b)(4), the conducted output power limit specified in paragraph (b) of this section is based on the use of antennas with directional gains that do not exceed 6 dBi. Except as shown in paragraph (c) of this section, if transmitting antennas of directional gain greater than 6 dBi are used, the conducted output power from the intentional radiator shall be reduced below the stated values in paragraph (b)(1), (b)(2), and (b)(3) of this section, as appropriate, by the amount in dB that the directional gain of the antenna exceeds 6 dBi.

4.2.2. IC

According to RSS-247 Issue 2, 5.4(d), for DTSs employing digital modulation techniques operating in the bands 902-928 MHz and 2 400-2 483.5 MHz, the maximum peak conducted output power shall not exceed 1 W. The e.i.r.p. shall not exceed 4 W, except as provided in section 5.4(e),

As an alternative to a peak measurement, compliance can be based on a measurement of the maximum conducted output power. The maximum conducted output power is the total transmit power delivered to all antennas and antenna elements, averaged across all symbols in the signalling alphabet when the transmitter is operating at its maximum power control level. Power must be summed across all antennas and antenna elements. The average must not include any time intervals during which the transmitter is off or transmitting at a reduced power level. If multiple modes of operation are implemented, the maximum conducted output power is the highest total transmit power occurring in any mode.

4.3. Test Procedure

The test follows section 11.9.1.3 of ANSI C63.10-2013.

PKPM1 Peak-reading power meter method

- The maximum peak conducted output power may be measured using a broadband peak RF power meter. The power meter shall have a video bandwidth that is greater than or equal to the DTS bandwidth and shall utilize a fast-responding diode detector.

The test follows section 11.9.2.3.2 of ANSI C63.10-2013.

Method AVGPM-G (Measurement using a gated RF average-reading power meter)

- Alternatively, measurements may be performed using a wideband gated RF power meter provided that the gate parameters are adjusted such that the power is measured only when the EUT is transmitting at its maximum power control level. Since this measurement is made only during the ON time of the transmitter, no duty cycle correction is required.

Test program: (S/W name: R&S Power Viewer, Version: 3.2.0)

1. Initially overall offset for attenuator and cable loss is measured per frequency.
2. Measured offset is inserted in test program in advance of measurement for output power.
3. Power for each frequency (channel) of device is investigated as final result.
4. Final result reported on this section from R&S power viewer program includes with several factors and test program shows only final result.

4.4. Test Results

Ambient temperature : (23 ± 1) °C
 Relative humidity : 47 % R.H.

Mode	Channel	Frequency (MHz)	Average Power Result (dB m)	Peak Power Result (dB m)	Limit (dB m)
DSSS (11b)	Low	2 412	16.46	19.98	30
	Middle	2 437	<u>17.60</u>	<u>21.11</u>	
	High	2 462	17.18	20.51	
OFDM (11g)	Low	2 412	13.09	21.74	
	Middle	2 437	<u>14.02</u>	<u>23.64</u>	
	High	2 462	12.59	21.77	
OFDM (11n_HT20)	Low	2 412	13.40	23.02	
	Middle	2 437	<u>13.71</u>	<u>23.21</u>	
	High	2 462	12.44	21.65	

5. Power Spectral Density

5.1. Test Setup

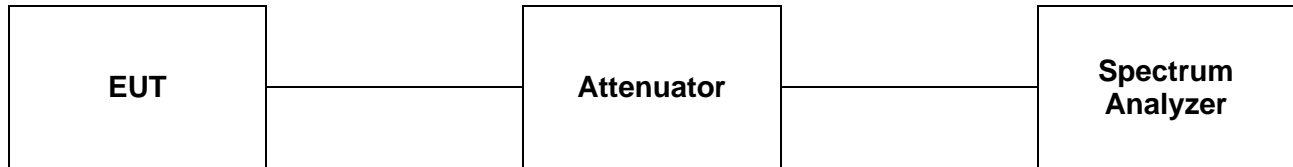

5.2. Limit

5.2.1 FCC

According to §15.247(e), for digitally modulated systems, the power spectral density conducted from the intentional radiator to the antenna shall not be greater than 8 dBm in any 3 kHz band during any time interval of continuous transmission. This power spectral density shall be determined in accordance with the provisions of paragraph (b) of this section. The same method of determining the conducted output power shall be used to determine the power spectral density.

5.2.2 IC

According to RSS-247 Issue 2, 5.2(b), the transmitter power spectral density conducted from the transmitter to the antenna shall not be greater than 8 dBm in any 3 kHz band during any time interval of continuous transmission. This power spectral density shall be determined in accordance with the provisions of section 5.4(d), (i.e. the power spectral density shall be determined using the same method as is used to determine the conducted output power).

5.3. Test Procedure

The measurements are recorded using the PKPSD measurement procedure in section 11.10.2 of ANSI C63.10-2013.

- This procedure shall be used if maximum peak conducted output power was used to demonstrate compliance, and is optional if the maximum conducted (average) output power was used to demonstrate compliance.

1. Set analyzer center frequency to DTS channel center frequency.
2. Set the span to 1.5 times the DTS bandwidth.
3. Set the RBW to $3 \text{ kHz} \leq \text{RBW} \leq 100 \text{ kHz}$.
4. Set the VBW $\geq [3 \times \text{RBW}]$.
5. Detector = peak.
6. Sweep time = auto couple.
7. Trace mode = max hold.
8. Allow trace to fully stabilize.
9. Use the peak marker function to determine the maximum amplitude level within the RBW.
10. If measured value exceeds requirement, then reduce RBW (but no less than 3 kHz) and repeat.

5.4. Test Results

Ambient temperature : (23 ± 1) °C
 Relative humidity : 47 % R.H.

Mode	Channel	Frequency (MHz)	Measured PSD (dB m/3 kHz)	Limit (dB m/3 kHz)
DSSS (11b)	Low	2 412	-4.69	8
	Middle	2 437	-1.23	
	High	2 462	-2.75	
OFDM (11g)	Low	2 412	-13.02	
	Middle	2 437	-11.67	
	High	2 462	-13.33	
OFDM (11n_HT20)	Low	2 412	-12.96	
	Middle	2 437	-13.25	
	High	2 462	-12.96	

- Test plots

DSSS: 11b

Low Channel

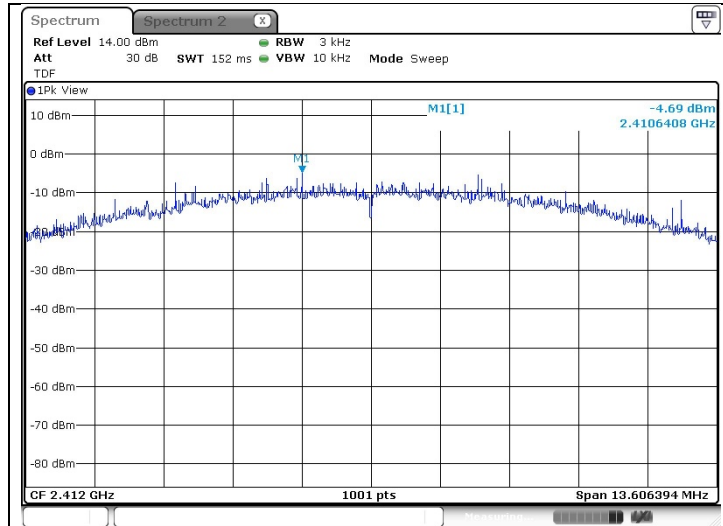

Middle Channel

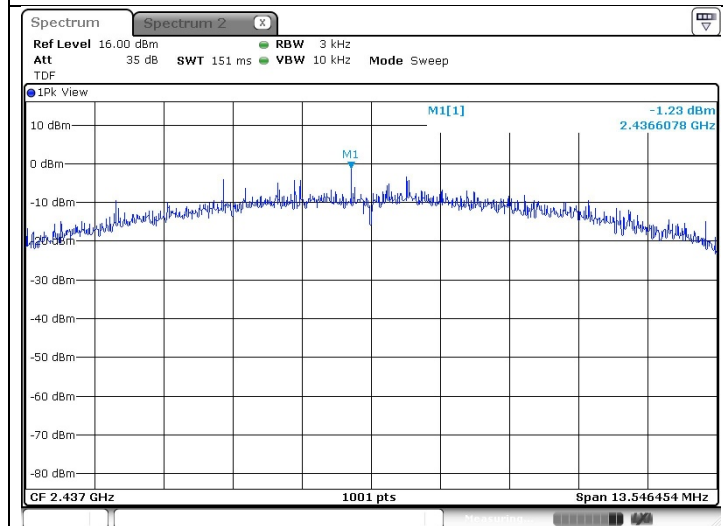

High Channel

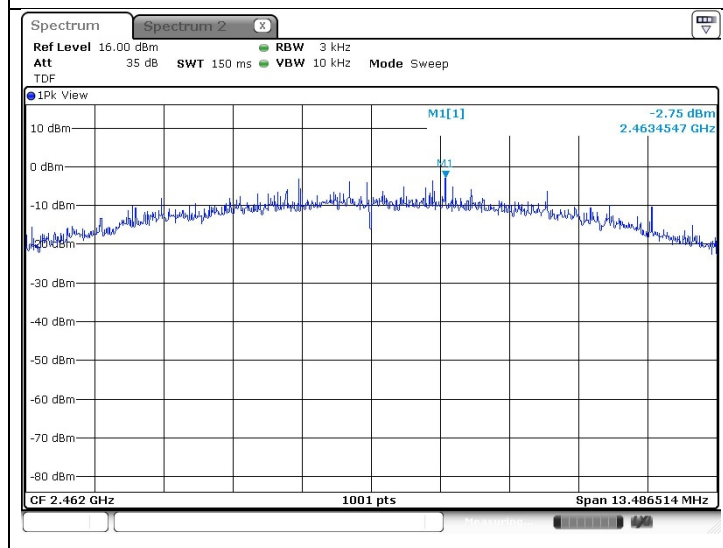

OFDM: 11g

Low Channel

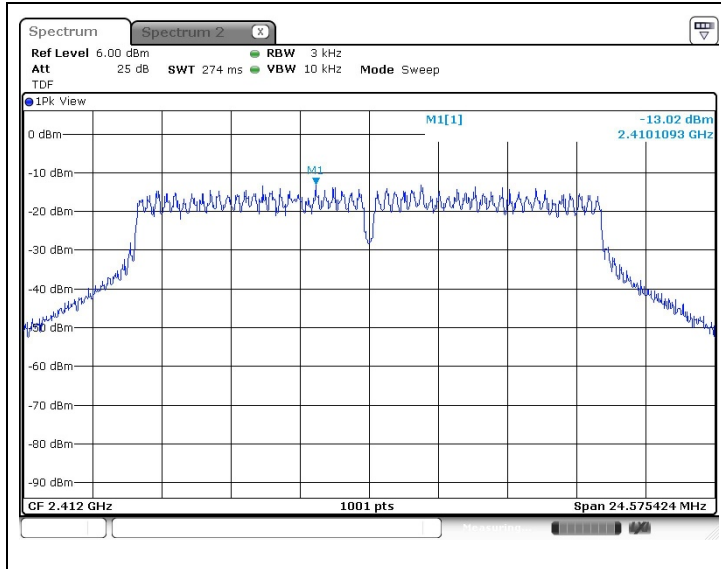

Middle Channel

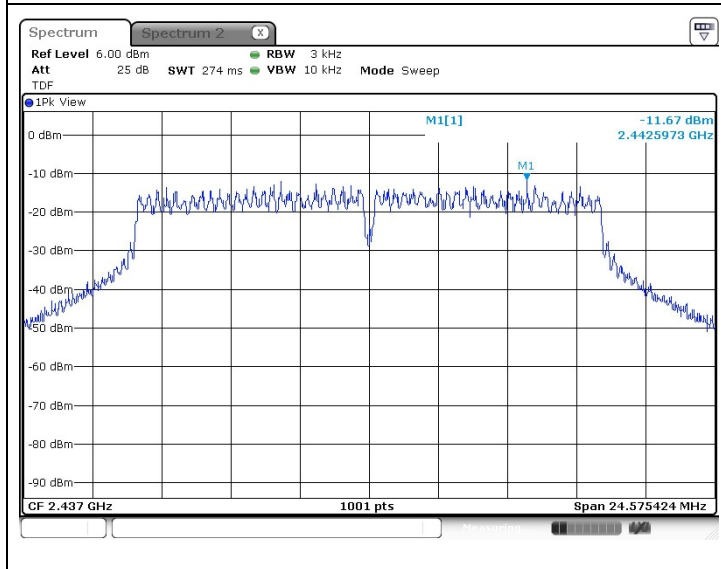

High Channel

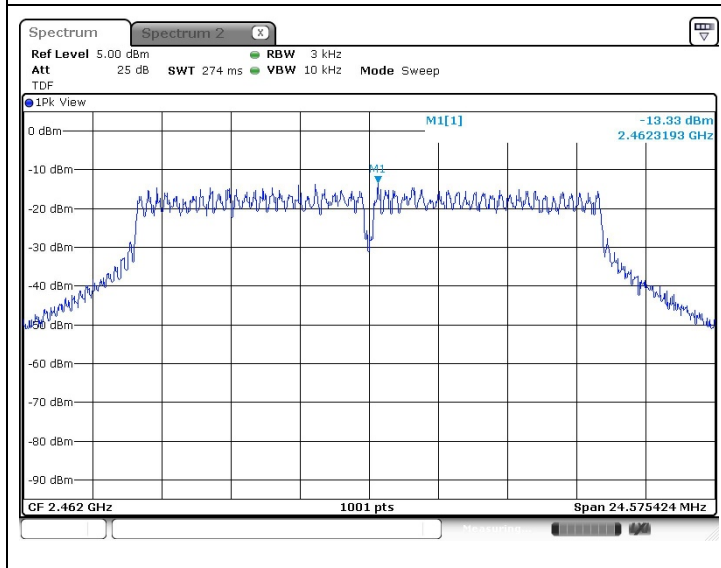

OFDM: 11n_HT20

Low Channel

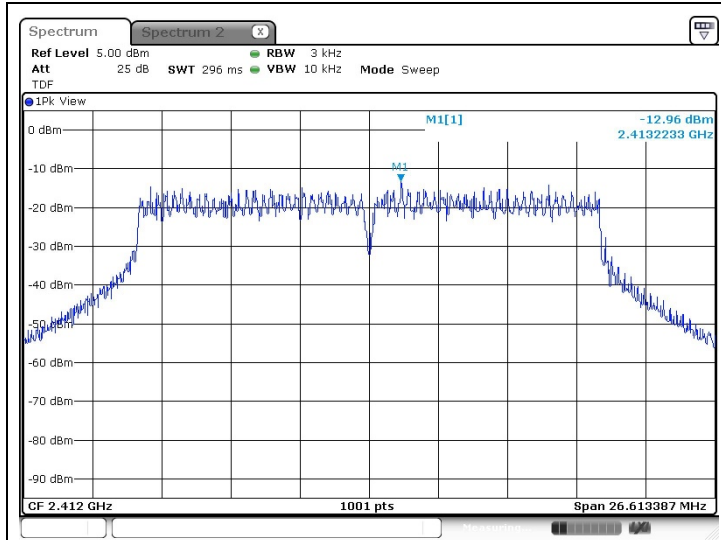

Middle Channel

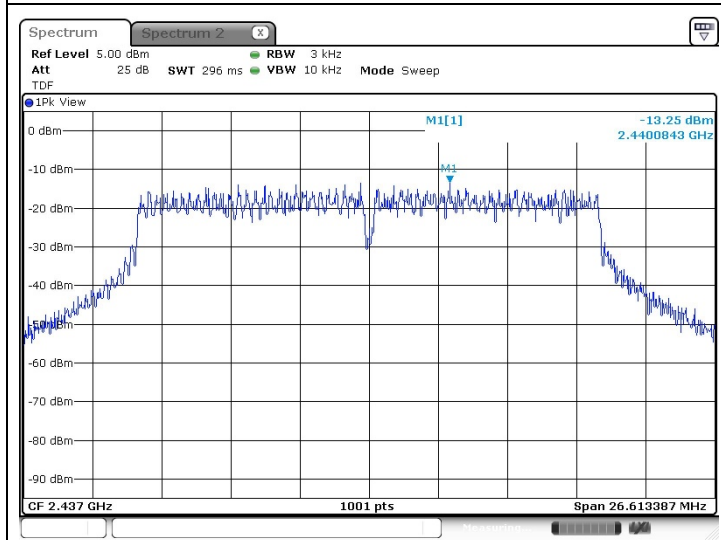

High Channel

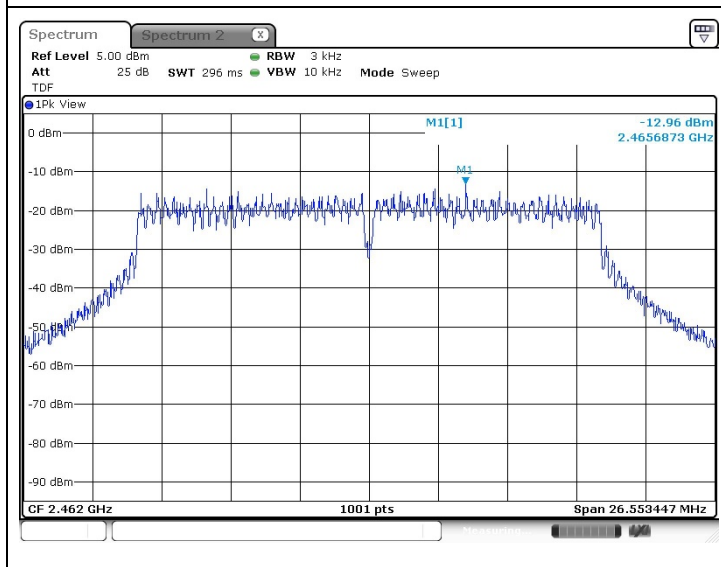

6. AC Power Line Conducted Emission

6.1. Test Setup

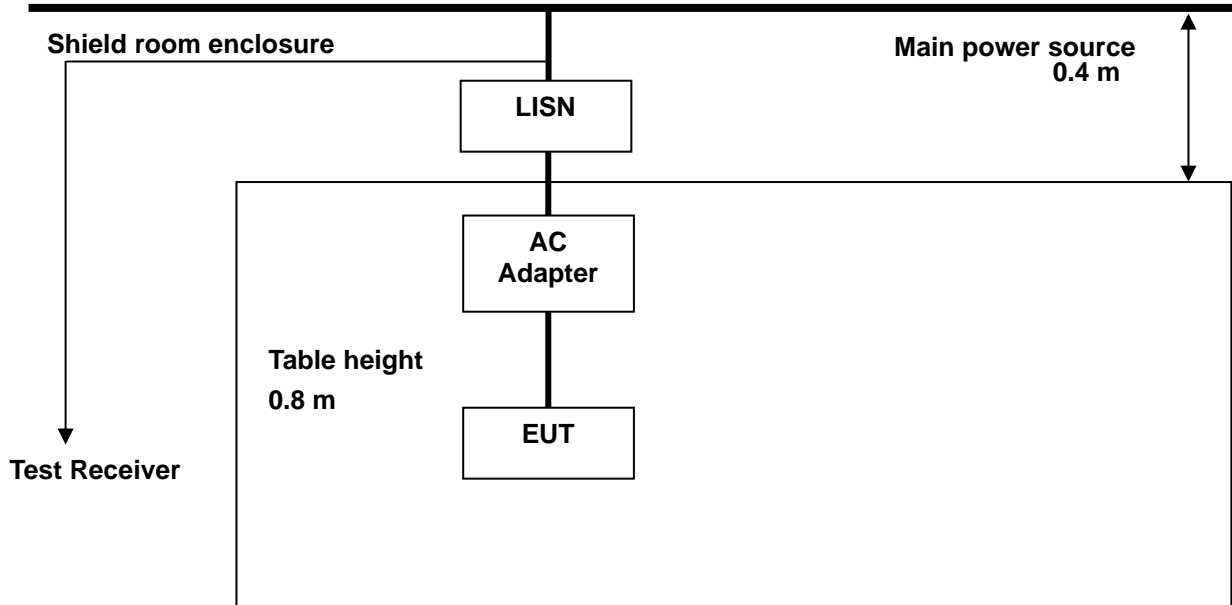

6.2. Limit

6.2.1. FCC

According to §15.207(a), for an intentional radiator that is designed to be connected to the public utility (AC) power line, the radio frequency voltage that is conducted back onto the AC power line on any frequency or frequencies, within the band 150 kHz to 30 MHz, shall not exceed the limits in the following table, as measured using a 50 μ H / 50 ohms line impedance stabilization network (LISN).

Compliance with the provision of this paragraph shall be based on the measurement of the radio frequency voltage between each power line and ground at the power terminal. The lower limit applies at the boundary between the frequency ranges.

Frequency of emission (MHz)	Conducted limit (dB μ V)	
	Quasi-peak	Average
0.15-0.5	66 to 56*	56 to 46*
0.5-5	56	46
5-30	60	50

* Decreases with the logarithm of the frequency.

6.2.2. IC

RSS-Gen Issue 5, 8.8, unless stated otherwise in the applicable RSS, for radio apparatus that are designed to be connected to the public utility AC power network, the radio frequency voltage that is conducted back onto the AC power line on any frequency or frequencies within the range 150 kHz to 30 MHz shall not exceed the limits in table 4, as measured using a 50 μH / 50 Ω line impedance stabilization network. This requirement applies for the radio frequency voltage measured between each power line and the ground terminal of each AC power-line mains cable of the EUT.

For an EUT that connects to the AC power lines indirectly, through another device, the requirement for compliance with the limits in table 4 shall apply at the terminals of the AC power-line mains cable of a representative support device, while it provides power to the EUT. The lower limit applies at the boundary between the frequency ranges. The device used to power the EUT shall be representative of typical applications.

Table 4 - AC power-line conducted emissions limits

Frequency (MHz)	Conducted limit (dBμV)	
	Quasi-peak	Average
0.15-0.5	66 to 56 ¹	56 to 46 ¹
0.5-5	56	46
5-30	60	50

Note 1: The level decreases linearly with the logarithm of the frequency.

For an EUT with a permanent or detachable antenna operating between 150 kHz and 30 MHz, the AC power-line conducted emissions must be measured using the following configurations:

- (a) Perform the AC power-line conducted emissions test with the antenna connected to determine compliance with the limits of table 4 outside the transmitter's fundamental emission band.
- (b) Retest with a dummy load instead of the antenna to determine compliance with the limits of table 4 within the transmitter's fundamental emission band. For a detachable antenna, remove the antenna and connect a suitable dummy load to the antenna connector. For a permanent antenna, remove the antenna and terminate the RF output with a dummy load or network that simulates the antenna in the fundamental frequency band.

6.3. Test Procedures

AC conducted emissions from the EUT were measured according to the dictates of ANSI C63.10-2013.

1. The test procedure is performed in a 6.5 m × 3.5 m × 3.5 m (L × W × H) shielded room. The EUT along with its peripherals were placed on a 1.0 m (W) × 1.5 m (L) and 0.8 m in height wooden table and the EUT was adjusted to maintain a 0.4 meter space from a vertical reference plane.
2. The EUT was connected to power mains through a line impedance stabilization network (LISN) which provides 50 ohm coupling impedance for measuring instrument and the chassis ground was bounded to the horizontal ground plane of shielded room.
3. All peripherals were connected to the second LISN and the chassis ground also bounded to the horizontal ground plane of shielded room.
4. The excess power cable between the EUT and the LISN was bundled. The power cables of peripherals were unbundled. All connecting cables of EUT and peripherals were moved to find the maximum emission.

6.4. Test Results

The following table shows the highest levels of conducted emissions on both phase of Hot and Neutral line.

Ambient temperature : (23 ± 1) °C
 Relative humidity : 47 % R.H.

 Frequency range : 0.15 MHz - 30 MHz
 Measured Bandwidth : 9 kHz

Freq. (MHz)	Level (dB μ V)		Line	Limit (dB μ V)		Margin (dB)	
	Quasi-peak	Average		Quasi-peak	Average	Quasi-peak	Average
0.18	42.70	43.00	N	64.49	54.49	21.79	11.49
0.36	28.80	29.00	N	58.73	48.73	29.93	19.73
0.53	23.10	22.80	N	56.00	46.00	32.90	23.20
13.08	38.50	35.40	N	60.00	50.00	21.50	14.60
24.74	35.80	33.80	N	60.00	50.00	24.20	16.20
29.19	37.70	36.00	N	60.00	50.00	22.30	14.00
0.18	43.30	43.60	H	64.49	54.49	21.19	10.89
0.36	30.20	30.40	H	58.73	48.73	28.53	18.33
0.53	26.30	26.30	H	56.00	46.00	29.70	19.70
13.25	34.40	29.60	H	60.00	50.00	25.60	20.40
25.09	36.20	34.50	H	60.00	50.00	23.80	15.50
29.18	37.30	34.50	H	60.00	50.00	22.70	15.50

Remark;

1. Line (H): Hot, Line (N): Neutral.
2. All modes and channels were investigated and the worst-case emissions were reported using **11g / 6Mbps / Middle channel.**
3. The limit for Class B device(s) from 150 kHz to 30 MHz are specified in Section of the Title 47 CFR.
4. Traces shown in plot were made by using a Quasi-peak detector and average detector.
5. Deviations to the Specifications: None.