

2023.08.10

RA-N2308-01

# APPROVAL SHEET

MODEL : T302  
**Antenna layout**

Review	Consent	Approval

**Messrs. Ohsung Technology Co.,Ltd**



**RadiNa Co. ,Ltd**

TEL:+82-2-463-0373

FAX:+82-2-463-0374

	PRODUCT APPROVAL SHEET		GRO82310WF89			
	MODEL NAME	T302	REV.	1.0	Page	2 / 8

## Table of contents

1. Revision History
2. Product Information
  - 2.1 General Features
  - 2.2 Electrical Specifications
3. Pattern Specifications
4. Matching Network
5. Measurement Process
  - 5.1 Calibration Date
  - 5.2 SWR / Return loss
  - 5.3 Gain
  - 5.4 Gain test block diagram

	PRODUCT APPROVAL SHEET		GRO82310WF89			
	MODEL NAME	T302	REV.	1.0	Page	3 / 8

### 1. Revision History

NO.	Before	After	Reason	Date
1				
2				
3				
4				
5				
6				
7				
8				
9				
10				
11				
12				
13				

	PRODUCT APPROVAL SHEET		GRO82310WF89			
	MODEL NAME	T302	REV.	1.0	Page	4 / 8

## 2. Product Information

### 2.1 General Features

PART NUMBER	GradiANT
ANTENNA TYPE	PCB Pattern Antenna
APPLICATIONS	WiFi

### 2.2 Electrical Specifications

Frequency Range1 (TX)		2400MHz~2485MHz	
Frequency Range1 (RX)		2400MHz~2485MHz	
IMPEDANCE		50 Ω	
V.S.W.R	TX	2400MHz	2485MHz
		3 ↓	3 ↓
	RX	2400MHz	2485MHz
		3 ↓	3 ↓
RADIATION PATTERN		Omni-directional	
POLARIZATION		Linear	

**RADINA. Co., LTD / CONFIDENTIAL**

This Document contains confidential and proprietary information, cannot discourse to third party without the prior written Authorization.

	PRODUCT APPROVAL SHEET		GRO82310WF89			
	MODEL NAME	T302	REV.	1.0	Page	5 / 8

### 3. Pattern Specifications

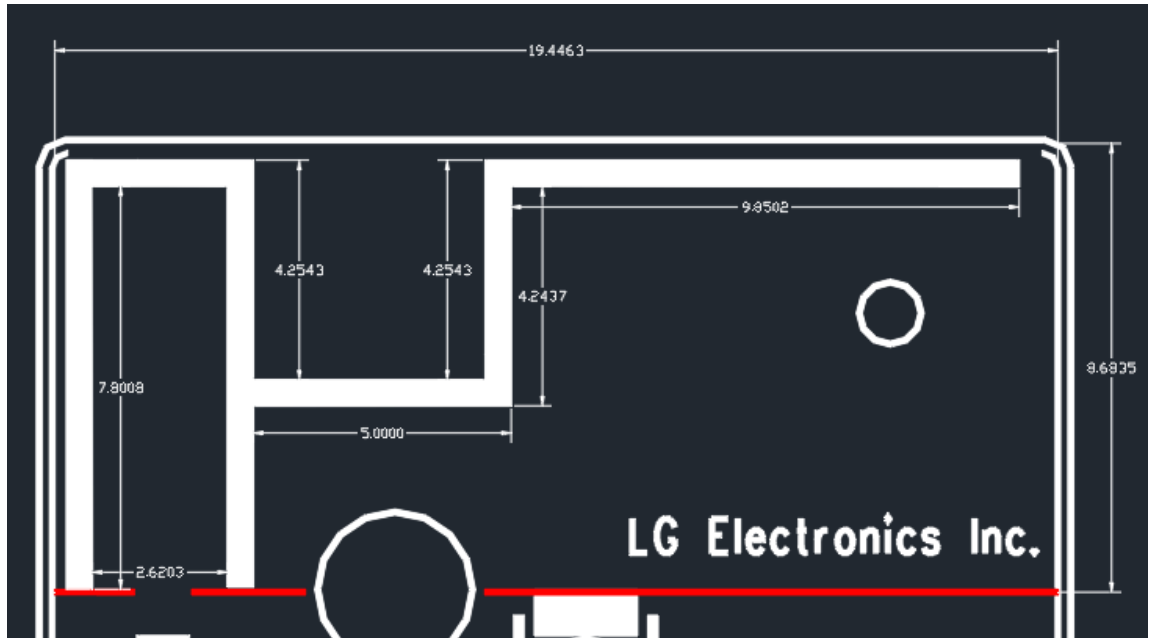

### 4. Matching Network

Capacitor value can be changed depending on different situation

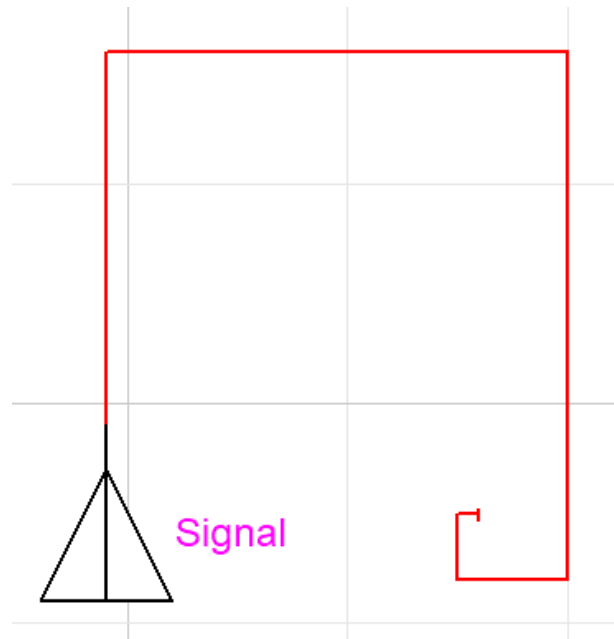

**RADINA. Co., LTD / CONFIDENTIAL**

This Document contains confidential and proprietary information, cannot discourse to third party without the prior written Authorization.

	PRODUCT APPROVAL SHEET		GRO82310WF89			
	MODEL NAME	T302	REV.	1.0	Page	6 / 8

## 5. Measurement Process

5.1 Calibration Date  
2023. 03. 27

5.2 SWR / Return loss

	Set Condition
Network Analyzer	Agilent 8753ES
Cable	Semi-rigid (40mm, 60mm)
Test condition	

	PRODUCT APPROVAL SHEET		GRO82310WF89			
	MODEL NAME	T302	REV.	1.0	Page	7 / 8

### 5.3 Gain

Antenna gain is measured in the anechoic chamber of this company.



5.4 Gain test block diagram

Active test Sysetm

- TRP, NHPRP, UHRP
- TIS, NHPIS, UHIS
- Relative Sensitivity

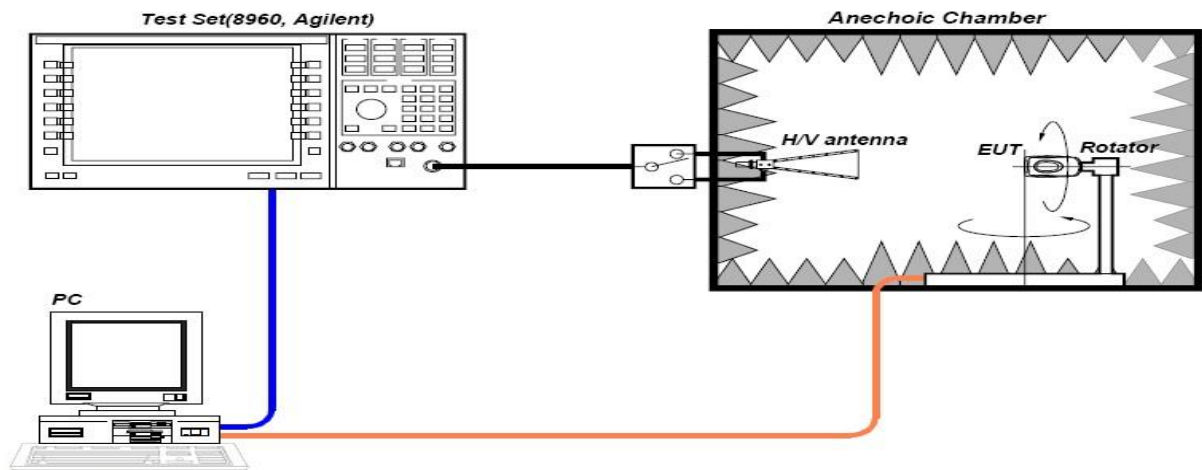

Passiver test Sysetm

- Efficiency
- Peak Gain, Avg, Gain
- Min, Max PWR

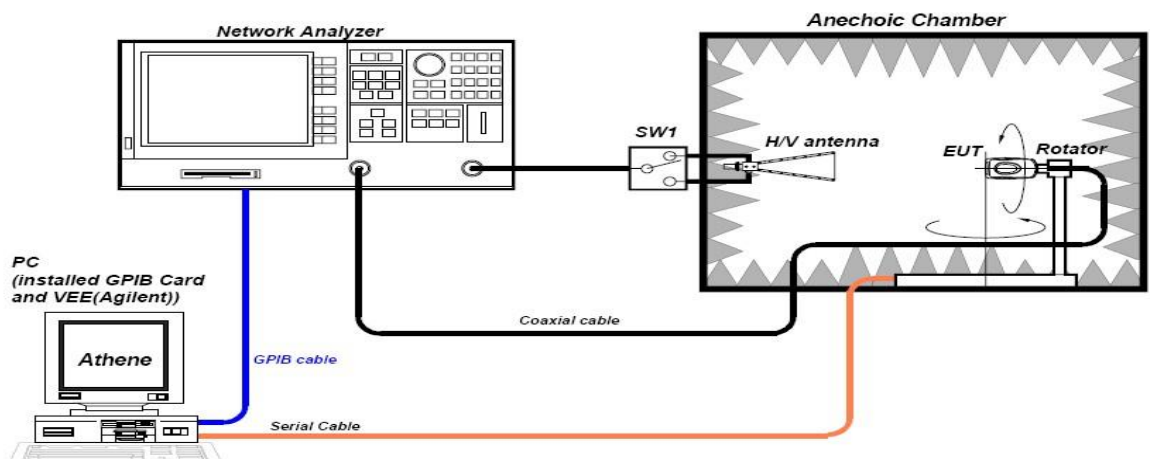



# 13. Antenna Specification

## 13.1 Passive Measurement Data

### 13.1.1 Network Analyzer measurement data

#### S11

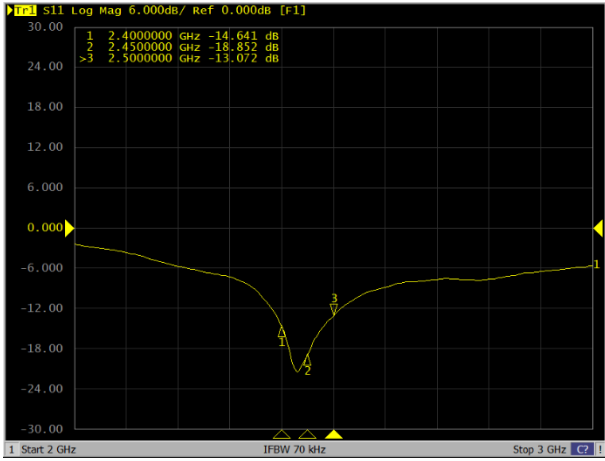

#### SMITH CHART

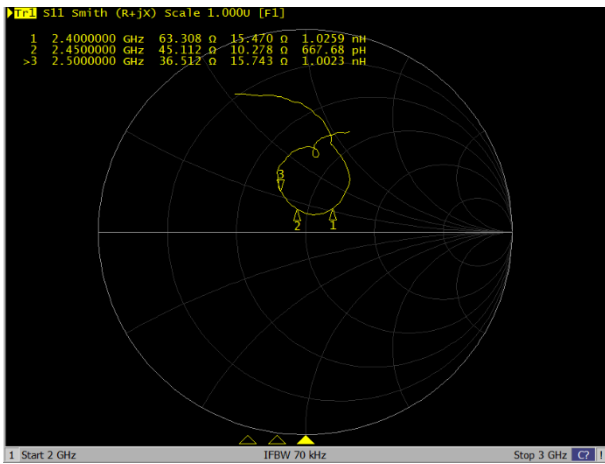

#### SWR

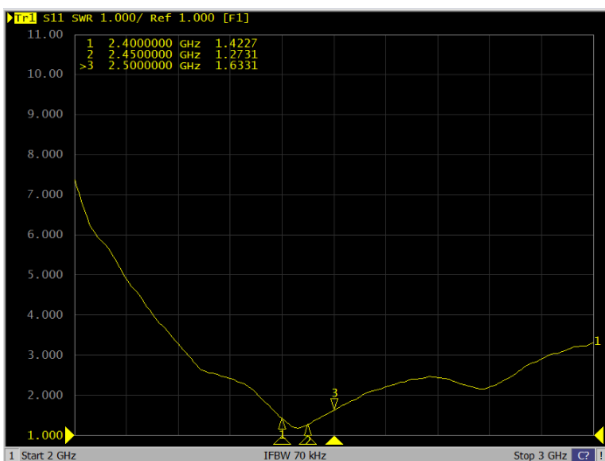

### 13.1.2 Radiation Pattern

2400MHz

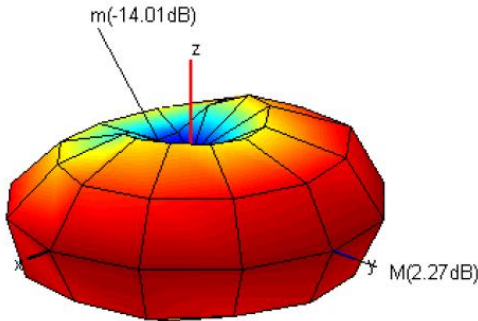

2445MHz

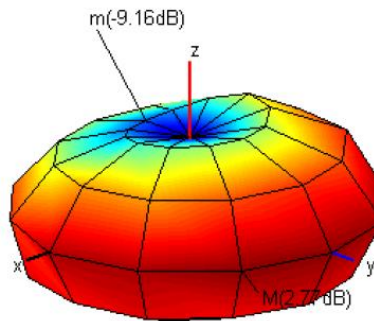

2485MHz

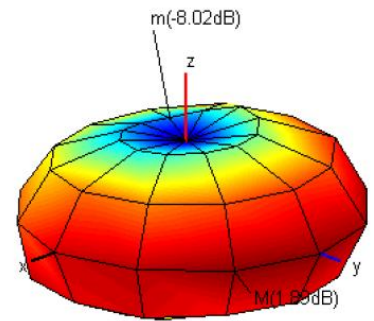

### 13.1.3 Efficiency

	1	2	3	4	5	6	7	8	9	10	11	12	13	14	15	16	17	18	19	20
Frequency [MHz]	2400	2405	2410	2415	2420	2425	2430	2435	2440	2445	2450	2455	2460	2465	2470	2475	2480	2485	2490	2497
Efficiency [dB]	-1.99	-1.99	-1.84	-1.87	-1.86	-2.12	-1.72	-1.95	-1.97	-1.63	-1.61	-1.59	-1.90	-1.91	-1.79	-1.67	-1.41	-1.81	-2.18	-2.01
Efficiency [%]	63.2	63.2	65.5	65.1	65.1	61.3	67.3	63.9	63.6	68.7	69.1	69.3	64.6	64.3	66.3	68.1	72.2	65.9	60.6	63.0
TRG <sub>g</sub> [dB]	-2.35	-2.35	-2.20	-2.24	-2.24	-2.53	-2.11	-2.35	-2.38	-2.05	-2.03	-2.02	-2.33	-2.37	-2.23	-2.12	-1.86	-2.28	-2.64	-2.47
Gain <sub>g Peak</sub> [dB]	1.08	1.08	1.44	1.17	1.30	0.91	1.44	0.97	0.95	1.51	1.52	1.56	1.27	1.16	1.23	1.23	1.62	0.91	0.74	0.84
Gain <sub>g Min</sub> [dB]	-25.71	-25.71	-23.70	-25.24	-22.23	-23.28	-23.14	-22.94	-21.09	-21.13	-20.88	-17.54	-19.73	-20.14	-18.00	-16.32	-15.20	-16.25	-17.14	-19.14
TRG <sub>p</sub> [dB]	-13.00	-13.00	-12.77	-12.68	-12.63	-12.64	-12.67	-12.51	-12.35	-12.00	-11.96	-11.90	-12.07	-11.94	-11.96	-11.73	-11.51	-11.73	-12.07	-12.00
Gain <sub>p Peak</sub> [dB]	-6.56	-6.56	-6.15	-6.09	-6.05	-6.08	-6.02	-5.84	-5.80	-5.51	-5.32	-5.28	-4.87	-5.59	-5.23	-5.04	-4.48	-5.08	-5.36	-4.98
Gain <sub>p Min</sub> [dB]	-30.79	-30.79	-35.55	-38.51	-37.26	-34.38	-34.52	-30.93	-30.72	-27.68	-27.56	-26.85	-26.38	-30.12	-27.82	-25.43	-23.53	-25.81	-25.38	-30.55
UHRG [dB]	-5.39	-5.39	-5.25	-5.27	-5.28	-5.52	-5.15	-5.38	-5.41	-5.06	-5.04	-5.03	-5.29	-5.34	-5.23	-5.11	-4.89	-5.31	-5.70	-5.58
UHRG/TRG [%]	45.7	45.7	45.5	45.7	45.6	45.7	45.4	45.3	45.2	45.4	45.3	45.3	45.8	45.5	45.2	45.3	44.9	44.7	44.4	43.9
H-Plane	-0.45	-0.45	-0.26	-0.36	-0.33	-0.63	-0.22	-0.39	-0.51	-0.22	-0.12	-0.14	-0.47	-0.48	-0.41	-0.27	0.00	-0.41	-0.82	-0.65
E1-Plane, AVG [dB]	-3.50	-3.50	-3.31	-3.38	-3.38	-3.70	-3.37	-3.51	-3.57	-3.26	-3.25	-3.14	-3.42	-3.56	-3.39	-3.23	-3.00	-3.26	-3.81	-3.59
E2-Plane, AVG [dB]	-3.41	-3.41	-3.27	-3.29	-3.24	-3.57	-3.09	-3.47	-3.45	-3.07	-2.98	-3.00	-3.32	-3.37	-3.25	-3.14	-2.81	-3.42	-3.72	-3.53
Peak Gain [dB]	1.25	1.25	1.62	1.35	1.45	1.11	1.61	1.12	1.12	1.70	1.65	1.69	1.35	1.29	1.37	1.40	1.72	1.00	0.81	0.90
Directivity [dB]	3.24	3.24	3.45	3.22	3.31	3.23	3.33	3.07	3.08	3.34	3.26	3.28	3.25	3.21	3.15	3.06	3.13	2.81	2.99	2.91
Minimum Gain [dB]	-18.00	-18.00	-18.61	-17.93	-18.12	-17.78	-18.24	-18.19	-17.35	-16.03	-14.70	-14.00	-14.97	-13.62	-14.14	-12.70	-11.98	-11.99	-13.73	-13.40
Test Condition	FS																			
Antenna Type																				
Average Efficiency	-1.62 dB 68.80 %																			