

InterLab[®]
Final Report on
SARA-U260
FCC ID: XPYSARAU260
IC: 8595A-SARAU260

According to:

FCC Part 22, Subpart H and FCC Part 24, Subpart E

Report Reference: MDE_UBLOX_1404_FCCa

Date: May 20, 2014

Test Laboratory:

7Layers AG
Borsigstr. 11
40880 Ratingen
Germany



Note:

The following test results relate only to the devices specified in this document. This report shall not be reproduced in parts without the written approval of the test laboratory.

7Layers AG
Borsigstrasse 11
40880 Ratingen, Germany
Phone: +49 (0) 2102 749 0
Fax: +49 (0) 2102 749 350
www.7Layers.com

Aufsichtsratsvorsitzender •
Chairman of the Supervisory Board:
Peter Mertel
Vorstand • Board:
Dr. H.-J. Meckelburg
Dr. H. Ansoerge

Registergericht • registered in:
Düsseldorf, HRB 44096
USt-IdNr • VAT No.:
DE 203159652
TAX No. 147/5869/0385

1 Administrative Data

1.1 Project Data

Project Responsible: Patrick Lomax
Date Of Test Report: 2014/05/20
Date of first test: 2014/04/23
Date of last test: 2014/05/08

1.2 Applicant Data

Company Name: u-blox Italia S.p.A.
Street: Via Stazione di Prosecco, 15
34010 Sgonico (Trieste)
Country: Italy
Contact Person: Giulio Comar
Function: Wireless Products Certification
Department: Wireless R&D center
Phone: +39 040 2529 400
Fax: +39 040 2529 394
E-Mail: giulio.comar@u-blox.com

1.3 Test Laboratory Data

The following list shows all places and laboratories involved for test result generation:

7 layers DE

Company Name : 7 layers AG
Street : Borsigstrasse 11
City : 40880 Ratingen
Country : Germany
Contact Person : Mr. Michael Albert
Phone : +49 2102 749 201
Fax : +49 2102 749 444
E Mail : michael.albert@7Layers.de

Laboratory Details

<i>Lab ID</i>	<i>Identification</i>	<i>Responsible</i>	<i>Accreditation Info</i>
Lab 1	Radiated Emissions	Mr. Robert Machulec Mr. Andreas Petz	DAkKS-Registration no. D-PL-12140-01-01
Lab 2	Radio Lab	Mr. Robert Machulec Mr. Andreas Petz	DAkKS-Registration no. D-PL-12140-01-01

1.4 Signature of the Testing Responsible

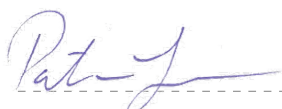

Patrick Lomax
responsible for tests performed in: Lab 1, Lab 2

1.5 Signature of the Accreditation Responsible

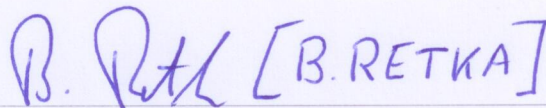

Accreditation scope responsible person
responsible for Lab 1, Lab 2

2 Test Object Data

2.1 General OUT Description

The following section lists all OUTs (Object's Under Test) involved during testing.

OUT: SARA-U260

Type / Model / Family:	SARA-U260 FCC ID: XPYSARAU260 IC:8595A-SARAU260
Product Category:	Module
Manufacturer:	
Company Name:	Please see applicant data
Contact Person:	-

Parameter List:

Parameter name	Value
Parameter for Scope FCC_v2:	
AC Power Supply	120V/60Hz
highest channel	251 (848.8MHz) for GSM850, 810 (1909.8MHz) for GSM1900, 4233 (846.6MHz) for FDD5, 9538 (1907.6MHz) for FDD2
lowest channel	128 (824.2MHz) for GSM850, 512 (1850.2MHz) for GSM1900, 4132 (826.4MHz) for FDD5, 9262 (1852.4MHz)for FDD2 (MHz)
mid channel	190 (836.6MHz) for GSM850, 661 (1880.0MHz) for GSM1900, 4183 (836.6MHz) for FDD5, 9400 (1880MHz) for FDD2

2.2 Detailed Description of OUT Samples

Sample : AH02

<i>OUT Identifier</i>	SARA-U260		
<i>Sample Description</i>	Protocol Sample		
<i>Serial No.</i>	352253060002929		
<i>HW Status</i>	188BA1		
<i>SW Status</i>	23.05		
<i>Date of Receipt</i>	2014/04/16		
<i>Low Voltage</i>	3.3 V	<i>Low Temp.</i>	-20 °C
<i>High Voltage</i>	4.4 V	<i>High Temp.</i>	55 °C
<i>Nominal Voltage</i>	3.8 V	<i>Normal Temp.</i>	25 °C

2.3 OUT Features

Features for OUT: SARA-U260

<i>Designation</i>	<i>Description</i>	<i>Allowed Values</i>	<i>Supported Value(s)</i>
Features for scope: FCC_v2			
AC	The OUT is powered by or connected to AC Mains		
Dant	removable antenna supplied and type tested with the radio equipment, designed as an example part of the equipment		
EDGE850	EUT supports EDGE in the band 824 MHz - 849 MHz		
EDGE1900	EUT supports EDGE in the band 1850 MHz - 1910 MHz		
FDD2	EUT supports UMTS FDD2 in the band 1850 MHz - 1910 MHz		
FDD5	EUT supports UMTS FDD5 in the band 824 MHz - 849 MHz		
GSM850	EUT supports GSM850 band 824MHz - 849MHz		
HSDPA-FDD2	EUT supports UMTS FDD2 HSDPA in the band 1850 MHz - 1910 MHz		
HSDPA-FDD5	EUT supports UMTS FDD5 HSDPA in the band 824 MHz - 849 MHz		
HSUPA-FDD2	EUT supports UMTS FDD2 HSUPA in the band 1850 MHz - 1910 MHz		
HSUPA-FDD5	EUT supports UMTS FDD5 HSUPA in the band 824 MHz - 849 MHz		
PantC	permanent fixed antenna connector, which may be built-in, designed as an indispensable part of the equipment		
PCS1900	EUT supports PCS1900 band 1850MHz - 1910MHz		

3.2 List of the Applicable Body

(Bodies for Scope: FCC_v2)

<i>Designation</i>	<i>Description</i>
FCC47CFRChIPART22PUBLIC MOBILE SERVICES	Part 22, Subpart H - Cellular Radiotelephone Service
FCC47CFRChIPART24PERSONAL COMMUNICATIONS SERVICES	Part 24, Subpart E - Broadband PCS

3.3 List of Test Specification

<i>Test Specification:</i>	FCC part 2 and 22
<i>Version</i>	10-1-12 Edition
<i>Title:</i>	PART 2 - GENERAL RULES AND REGULATIONS PART 22 - PUBLIC MOBILE SERVICES
<i>Test Specification:</i>	FCC part 2 and 24
<i>Version</i>	10-1-12 Edition
<i>Title:</i>	PART 2 - GENERAL RULES AND REGULATIONS PART 24 - PERSONAL COMMUNICATIONS SERVICES

3.4 Summary

<i>Test Case Identifier / Name</i> <i>Test (condition)</i>	<i>Result</i>	<i>Date of Test</i>	<i>Lab</i> <i>Ref.</i>	<i>Setup</i>
Test Specification: FCC part 2 and 22				
22.1 RF Power Output §2.1046, §22.913				
22.1; Frequency Band = 850 / FDD5	Passed	2014/05/07	Lab 2	S_AH02
22.2 Frequency stability §2.1055				
22.2; Frequency Band = 850 / FDD5	Passed	2014/04/30	Lab 2	S_AH02
22.3 Spurious emissions at antenna terminals §2.1051, §22.917				
22.3; Frequency Band = 850, Mode = GSM, Channel = 128, Frequency = 824.2MHz,	Passed	2014/05/06	Lab 2	S_AH02
22.3; Frequency Band = 850, Mode = GSM, Channel = 190, Frequency = 836.6MHz	Passed	2014/05/06	Lab 2	S_AH02
22.3; Frequency Band = 850, Mode = GSM, Channel = 251, Frequency = 848.8MHz	Passed	2014/05/06	Lab 2	S_AH02
22.3; Frequency Band = FDD5, Mode = HSDPA, Channel = 4132, Frequency = 826.4MHz	Passed	2014/05/07	Lab 2	S_AH02
22.3; Frequency Band = FDD5, Mode = HSDPA, Channel = 4183, Frequency = 836.6MHz	Passed	2014/05/07	Lab 2	S_AH02
22.3; Frequency Band = FDD5, Mode = HSDPA, Channel = 4233, Frequency = 846.6MHz	Passed	2014/05/07	Lab 2	S_AH02
22.3; Frequency Band = FDD5, Mode = HSUPA, Channel = 4132, Frequency = 826.4MHz	Passed	2014/05/07	Lab 2	S_AH02
22.3; Frequency Band = FDD5, Mode = HSUPA, Channel = 4183, Frequency = 836.6MHz	Passed	2014/05/07	Lab 2	S_AH02
22.3; Frequency Band = FDD5, Mode = HSUPA, Channel = 4233, Frequency = 846.6MHz	Passed	2014/05/07	Lab 2	S_AH02
22.3; Frequency Band = FDD5, Mode = W-CDMA, Channel = 4132, Frequency = 826.4MHz	Passed	2014/05/07	Lab 2	S_AH02
22.3; Frequency Band = FDD5, Mode = W-CDMA, Channel = 4183, Frequency = 836.6MHz	Passed	2014/05/07	Lab 2	S_AH02
22.3; Frequency Band = FDD5, Mode = W-CDMA, Channel = 4233, Frequency = 846.6MHz	Passed	2014/05/07	Lab 2	S_AH02
22.4 Field strength of spurious radiation §2.1053, §22.917				
22.4; Frequency Band = 850, Mode = GSM, Channel = 190, Frequency = 836.6MHz	Passed	2014/04/23	Lab 1	S_AH02_RSE
22.4; Frequency Band = FDD5, Mode = HSDPA, Channel = 4183, Frequency = 836.6MHz	Passed	2014/05/02	Lab 1	S_AH02_RSE
22.4; Frequency Band = FDD5, Mode = HSUPA, Channel = 4183, Frequency = 836.6MHz	Passed	2014/05/08	Lab 1	S_AH02_RSE
22.4; Frequency Band = FDD5, Mode = W-CDMA, Channel = 4183, Frequency = 836.6MHz	Passed	2014/04/26	Lab 1	S_AH02_RSE
22.5 Emission and Occupied Bandwidth §2.1049, §22.917				
22.5; Frequency Band = 850 / FDD5	Passed	2014/05/06	Lab 2	S_AH02
22.6 Band edge compliance §2.1053, §22.917				
22.6; Frequency Band = 850 / FDD5	Passed	2014/05/06	Lab 2	S_AH02

Test Specification: FCC part 2 and 24

<i>Test Case Identifier / Name</i> <i>Test (condition)</i>	<i>Result</i>	<i>Date of Test</i>	<i>Lab</i> <i>Ref.</i>	<i>Setup</i>
24.1 RF Power Output §2.1046, §24.232				
24.1; Frequency Band = 1900 / FDD 2	Passed	2014/05/07	Lab 2	S_AH02
24.2 Frequency stability §2.1055, §24.235				
24.2; Frequency Band = 1900 / FDD2	Passed	2014/04/30	Lab 2	S_AH02
24.3 Spurious emissions at antenna terminals §2.1051, §24.238				
24.3; Frequency Band = 1900, Mode = GSM, Channel = 512, Frequency = 1850.2MHz	Passed	2014/05/07	Lab 2	S_AH02
24.3; Frequency Band = 1900, Mode = GSM, Channel = 661, Frequency = 1880.0MHz	Passed	2014/05/07	Lab 2	S_AH02
24.3; Frequency Band = 1900, Mode = GSM, Channel = 810, Frequency = 1909.8MHz	Passed	2014/05/07	Lab 2	S_AH02
24.3; Frequency Band = FDD2, Mode = HSDPA, Channel = 9262, Frequency = 1852.4MHz	Passed	2014/05/07	Lab 2	S_AH02
24.3; Frequency Band = FDD2, Mode = HSDPA, Channel = 9400, Frequency = 1880MHz	Passed	2014/05/07	Lab 2	S_AH02
24.3; Frequency Band = FDD2, Mode = HSDPA, Channel = 9538, Frequency = 1907.6MHz	Passed	2014/05/07	Lab 2	S_AH02
24.3; Frequency Band = FDD2, Mode = HSUPA, Channel = 9262, Frequency = 1852.4MHz	Passed	2014/05/07	Lab 2	S_AH02
24.3; Frequency Band = FDD2, Mode = HSUPA, Channel = 9400, Frequency = 1880MHz	Passed	2014/05/07	Lab 2	S_AH02
24.3; Frequency Band = FDD2, Mode = HSUPA, Channel = 9538, Frequency = 1907.6MHz	Passed	2014/05/07	Lab 2	S_AH02
24.3; Frequency Band = FDD2, Mode = W-CDMA, Channel = 9262, Frequency = 1852.4MHz	Passed	2014/05/07	Lab 2	S_AH02
24.3; Frequency Band = FDD2, Mode = W-CDMA, Channel = 9400, Frequency = 1880MHz	Passed	2014/05/07	Lab 2	S_AH02
24.3; Frequency Band = FDD2, Mode = W-CDMA, Channel = 9538, Frequency = 1907.6MHz	Passed	2014/05/07	Lab 2	S_AH02
24.4 Field strength of spurious radiation §2.1053, §24.238				
24.4; Frequency Band = 1900, Mode = GSM, Channel = 661, Frequency = 1880.0MHz	Passed	2014/04/26	Lab 1	S_AH02_RSE
24.4; Frequency Band = FDD2, Mode = HSDPA, Channel = 9400, Frequency = 1880MHz	Passed	2014/05/02	Lab 1	S_AH02_RSE
24.4; Frequency Band = FDD2, Mode = HSUPA, Channel = 9400, Frequency = 1880MHz	Passed	2014/05/08	Lab 1	S_AH02_RSE
24.4; Frequency Band = FDD2, Mode = W-CDMA, Channel = 9400, Frequency = 1880MHz	Passed	2014/04/25	Lab 1	S_AH02_RSE
24.5 Emission and Occupied Bandwidth §2.1049, §24.238				
24.5; Frequency Band = 1900 / FDD2	Passed	2014/05/06	Lab 2	S_AH02
24.6 Band edge compliance §2.1053, §24.238				
24.6; Frequency Band = 1900 / FDD2	Passed	2014/05/06	Lab 2	S_AH02

3.5 Detailed Results

3.5.1 22.1 RF Power Output §2.1046, §22.913

Test: 22.1; Frequency Band = 850 / FDD5

<i>Result:</i>	Passed
<i>Setup No.:</i>	S_AH02
<i>Date of Test:</i>	2014/05/07 8:38
<i>Body:</i>	FCC47CFRChIPART22PUBLIC MOBILE SERVICES
<i>Test Specification:</i>	FCC part 2 and 22

Detailed Results:

Band	Mode	Modulation	Channel	Frequency (MHz)	Average Conducted power	RMS Conducted power	Peak Conducted power	FCC EIRP limit (W)	IC EIRP limit per SRSP-503 (W)	Maximum antenna gain (dBi)	Verdict	
850	GSM/GPRS	GFSK	Low	824,2	32.5	32.51	32.89	11.48	11.5	8.09	Pass	
			Mid	836,6	32.57	32.59	32.93			8.01	Pass	
			High	848,8	32.72	32.72	33.08			7.88	Pass	
Band	Mode	Modulation	Channel	Frequency (MHz)	Average Conducted power	RMS Conducted power	Peak Conducted power	FCC EIRP limit (W)	IC EIRP limit per SRSP-503 (W)	Maximum antenna gain (dBi)	Verdict	
FDD 5	W-CDMA	QPSK	Low	826.4	21.47	21.7	27.19	11.48	11.5	18.9	Pass	
			Mid	836.6	21.68	21.9	27.44			18.7	Pass	
			High	846.6	21.88	22.12	27.86			18.48	Pass	
FDD 5	HSDPA	Subtest 1	QPSK	Low	826.4	21.41	21.64	27.04	11.48	11.5	18.96	Pass
				Mid	836.6	21.56	21.84	27.19			18.76	Pass
				High	846.6	21.71	21.98	27.57			18.62	Pass
FDD 5	HSDPA	Subtest 2	QPSK	Low	826.4	19.45	20.22	28.12	11.48	11.5	20.38	Pass
				Mid	836.6	19.85	20.38	27.7			20.22	Pass
				High	846.6	19.78	20.49	28.37			20.11	Pass
FDD 5	HSDPA	Subtest 3	QPSK	Low	826.4	18.73	19.5	28.12	11.48	11.5	21.1	Pass
				Mid	836.6	18.85	19.9	27.7			20.7	Pass
				High	846.6	18.82	20.03	27.79			20.57	Pass
FDD 5	HSDPA	Subtest 4	QPSK	Low	826.4	18.09	19.25	27.32	11.48	11.5	21.35	Pass
				Mid	836.6	18.54	19.43	27.32			21.17	Pass
				High	846.6	18.61	19.55	27.99			21.05	Pass
FDD 5	HSUPA	Subtest 1	QPSK	Low	826.4	20.39	20.81	27.57	11.48	11.5	19.79	Pass
				Mid	836.6	20.44	20.85	27.86			19.75	Pass
				High	846.6	20.72	21.15	28.9			19.45	Pass
FDD 5	HSUPA	Subtest 2	QPSK	Low	826.4	18.25	19.18	27.32	11.48	11.5	21.42	Pass
				Mid	836.6	18.47	19.32	27.19			21.28	Pass
				High	846.6	18.6	19.52	27.99			21.08	Pass
FDD 5	HSUPA	Subtest 3	QPSK	Low	826.4	19.4	20.11	28.24	11.48	11.5	20.49	Pass
				Mid	836.6	19.59	20.33	28.24			20.27	Pass
				High	846.6	19.75	20.52	29.28			20.08	Pass
FDD 5	HSUPA	Subtest 4	QPSK	Low	826.4	18.69	19.6	27.32	11.48	11.5	21	Pass
				Mid	836.6	18.87	19.8	27.44			20.8	Pass
				High	846.6	19.01	19.95	27.99			20.65	Pass
FDD 5	HSUPA	Subtest 4	QPSK	Low	826.4	19.86	20.23	27.04	11.48	11.5	20.37	Pass
				Mid	836.6	19.99	20.35	27.04			20.25	Pass
				High	846.6	20.18	20.58	27.57			20.02	Pass

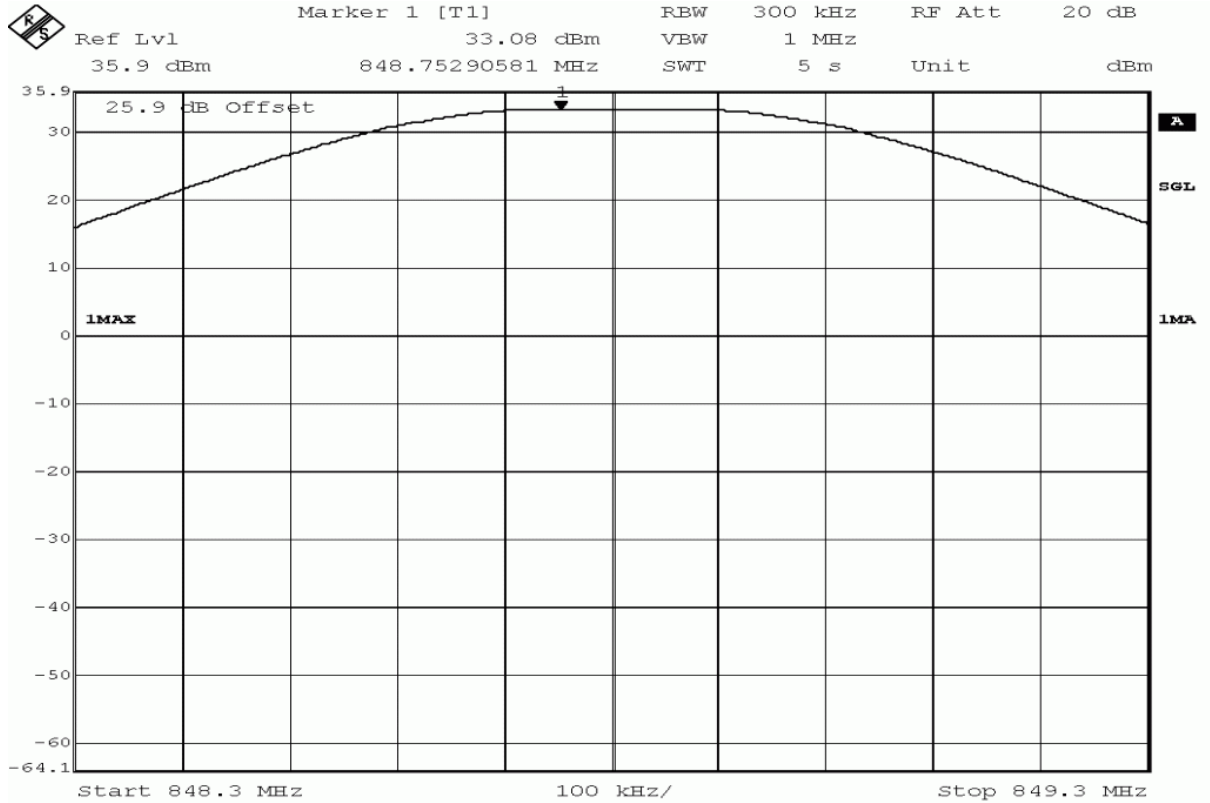

Title: output power measurement
 Comment A: DE1015001, GSM850, output power, channel 251, (848.8MHz)
 Date: 6.MAY.2014 23:37:03

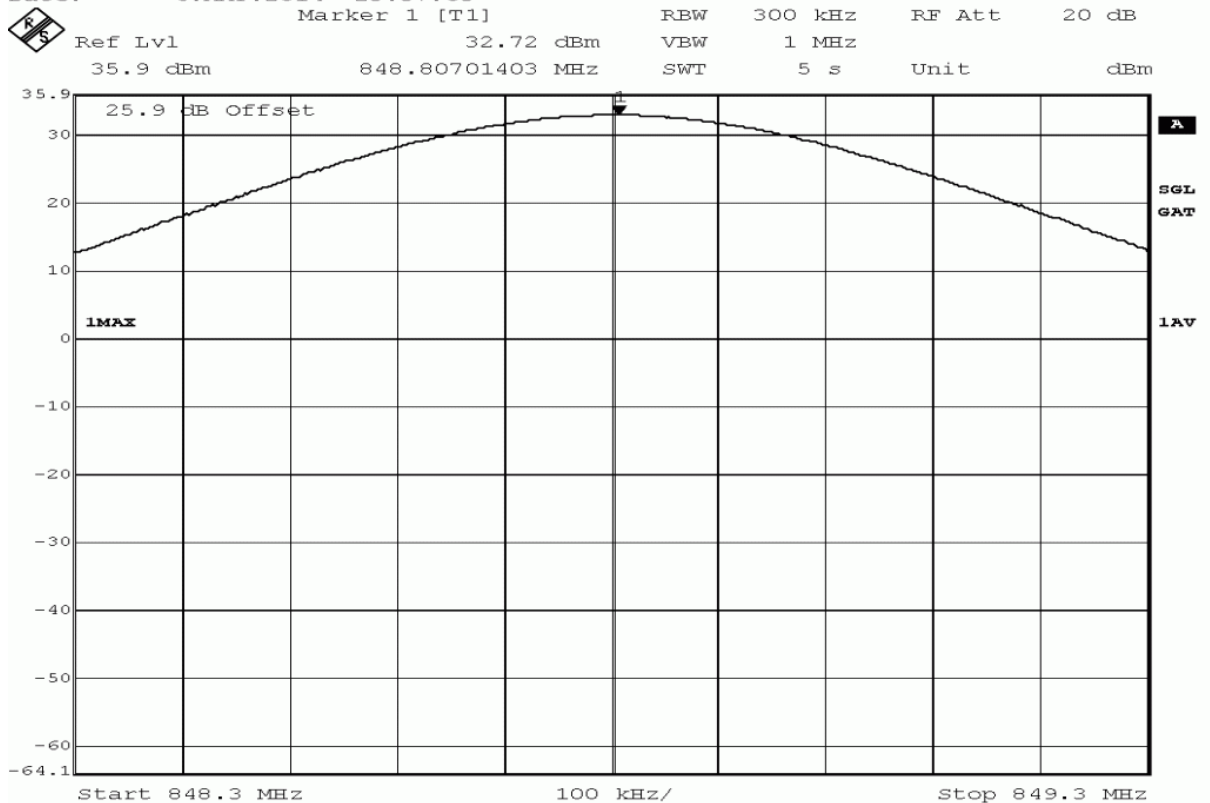

Title: output power measurement
 Comment A: DE1015001, GSM850, output power, channel 251, (848.8MHz)
 Date: 6.MAY.2014 23:37:59

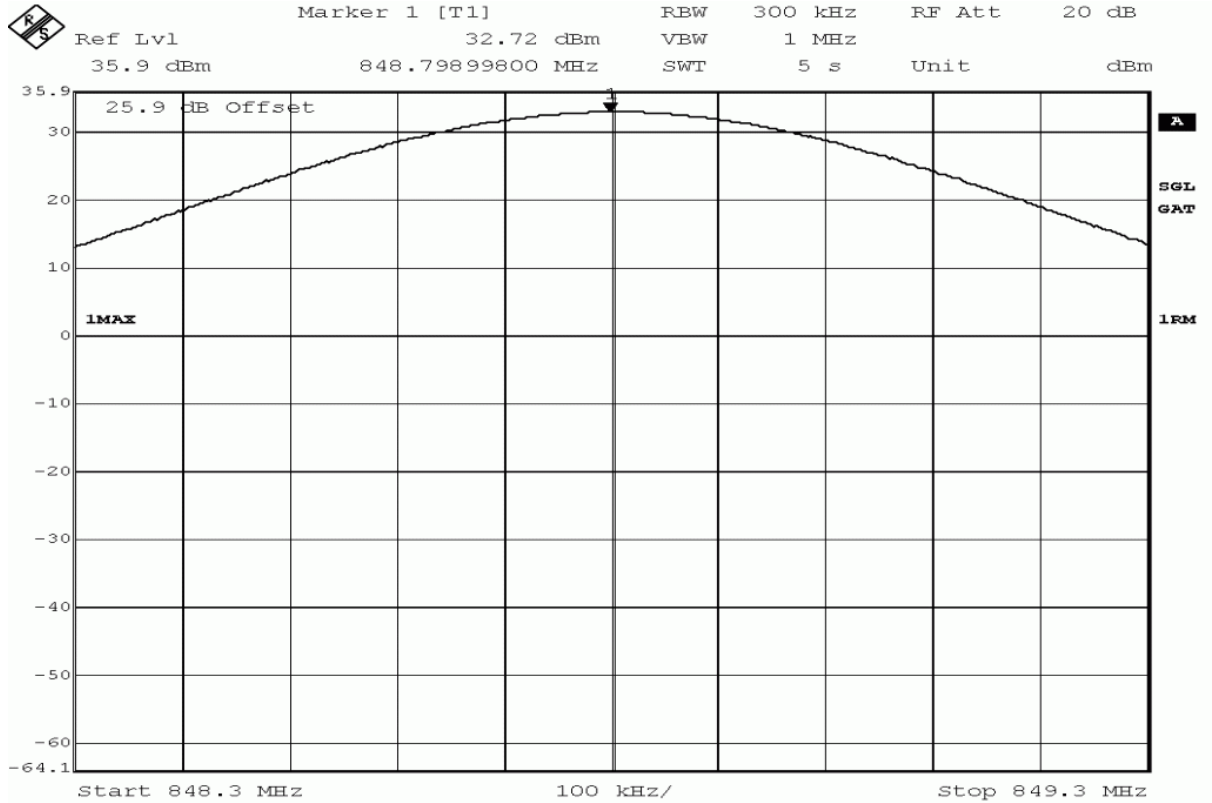

Title: output power measurement
 Comment A: DE1015001, GSM850, output power, channel 251, (848.8MHz)
 Date: 6.MAY.2014 23:38:54

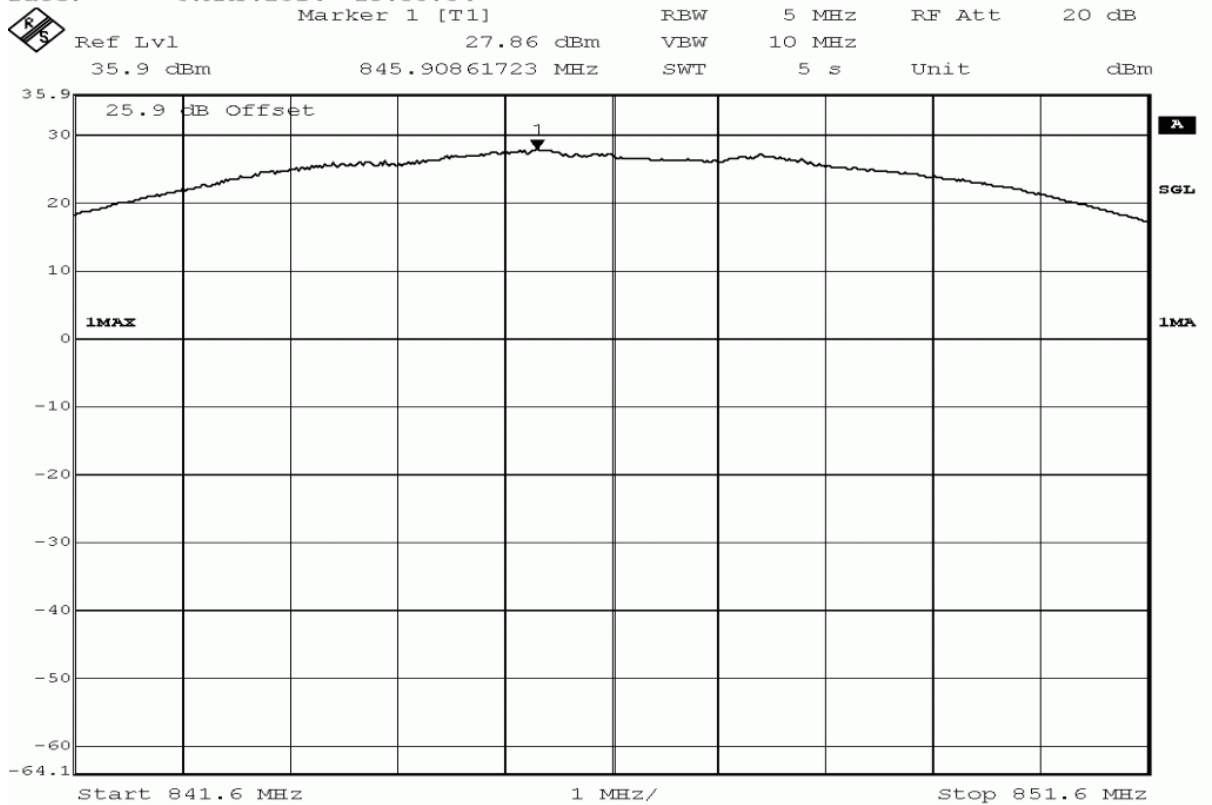

Title: output power measurement
 Comment A: DE1015001, FDD V, output power, channel 4233 (846.6MHz)
 Date: 6.MAY.2014 22:41:20

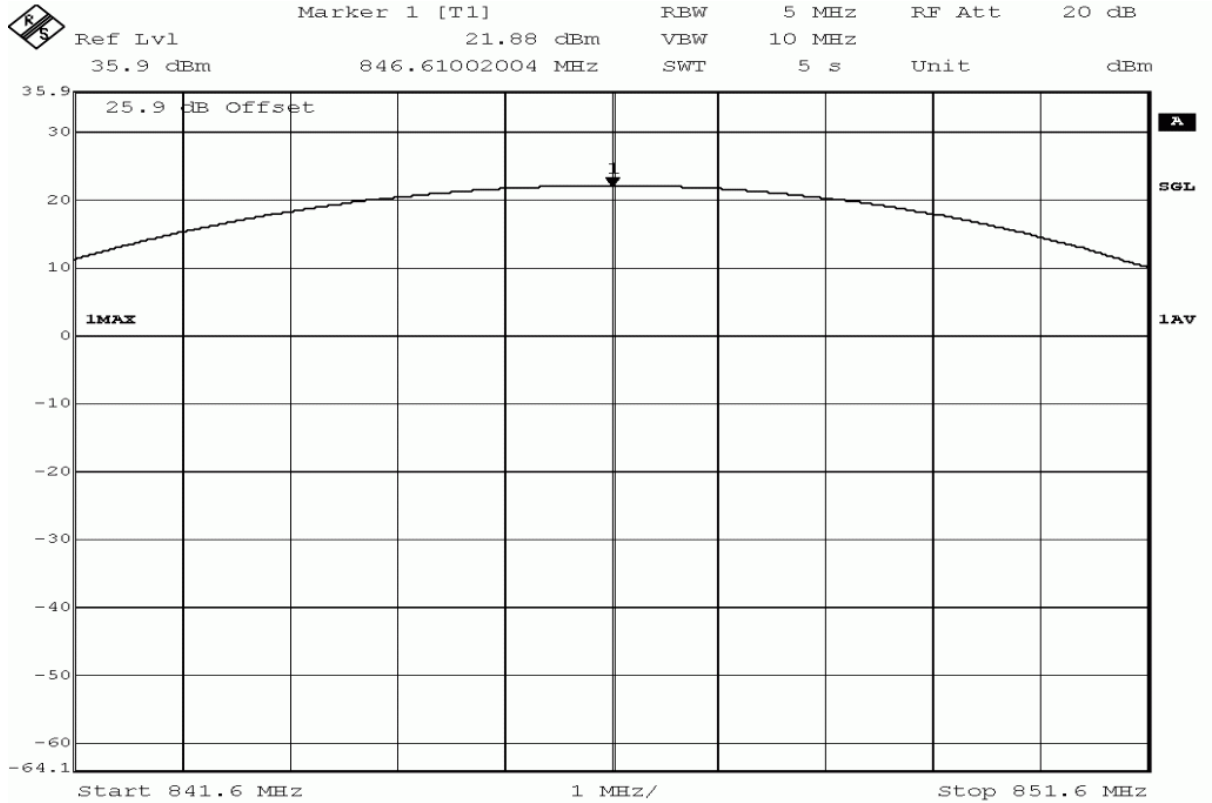

Title: output power measurement
 Comment A: DE1015001, FDD V, output power,
 channel 4233 (846.6MHz)
 Date: 6.MAY.2014 22:41:37

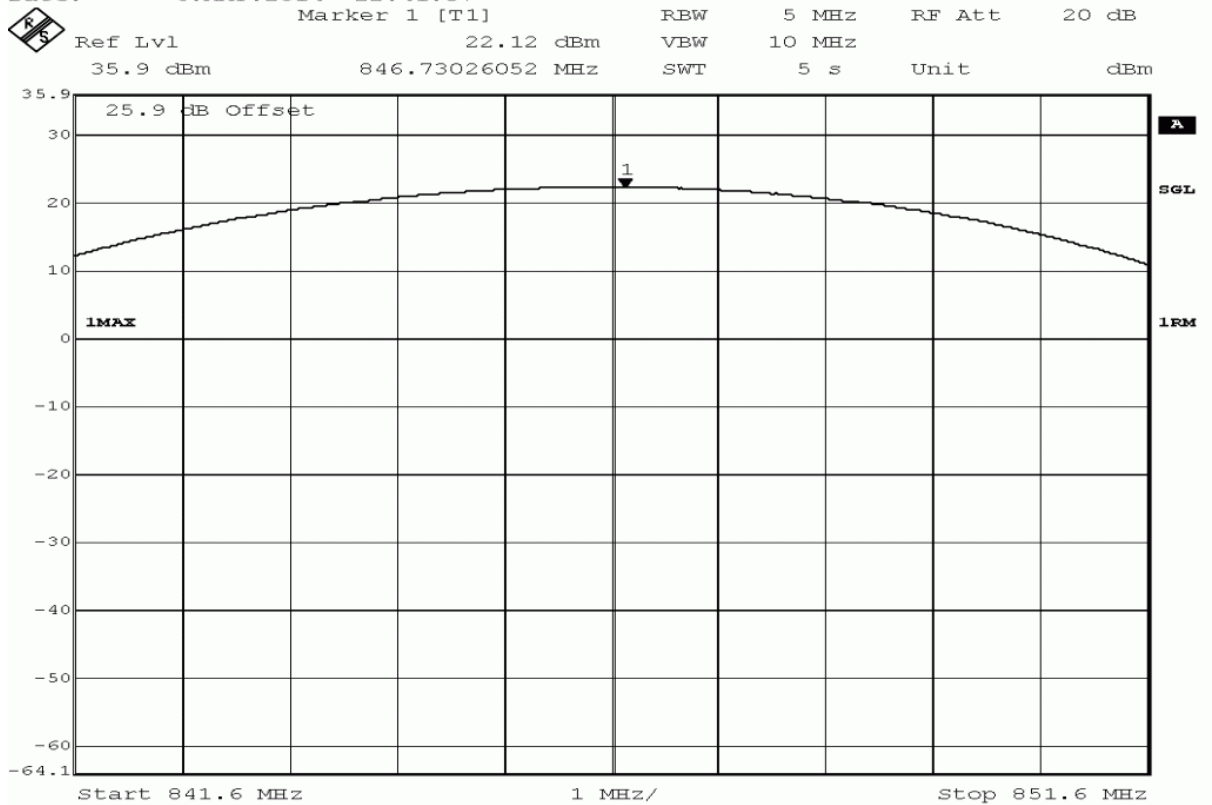

Title: output power measurement
 Comment A: DE1015001, FDD V, output power,
 channel 4233 (846.6MHz)
 Date: 6.MAY.2014 22:41:54

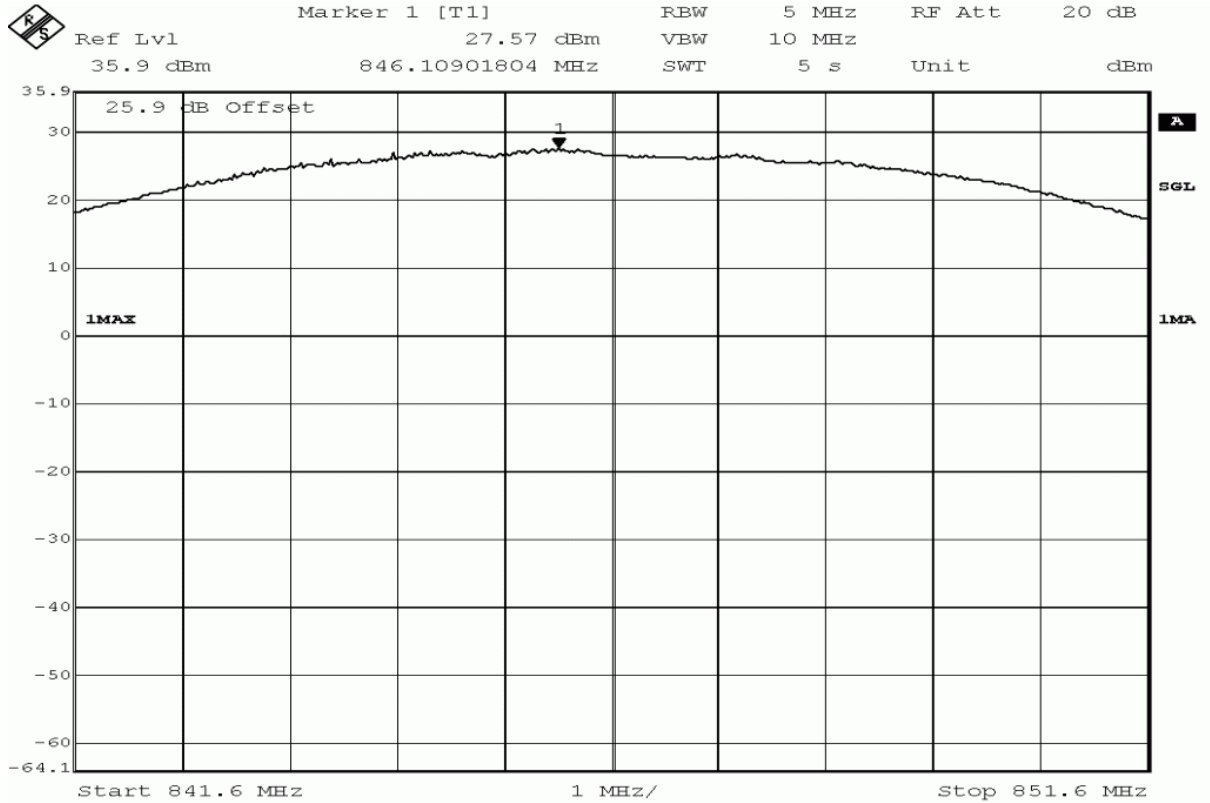

Title: output power measurement
 Comment A: DE1015001, subtest 1 HSDPA FDD V, output power, channel 4233 (846.6MHz)
 Date: 6.MAY.2014 21:54:19

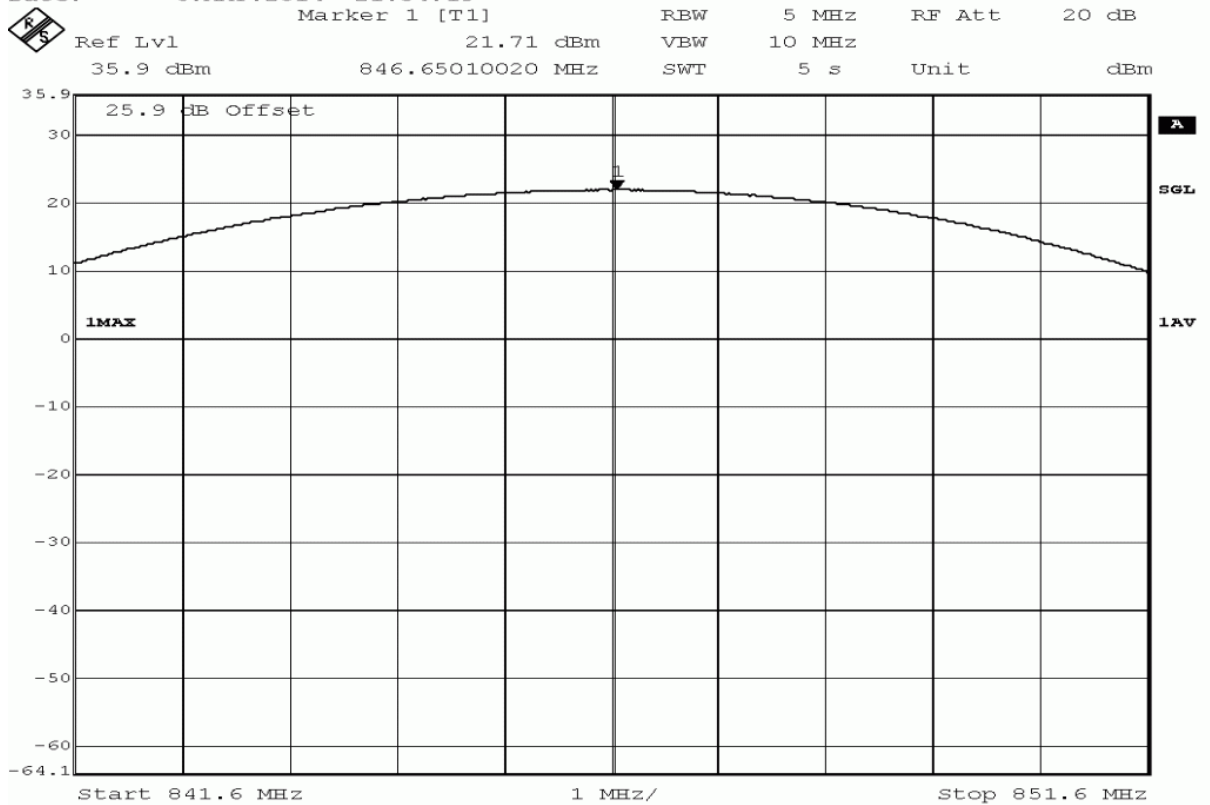

Title: output power measurement
 Comment A: DE1015001, subtest 1 HSDPA FDD V, output power, channel 4233 (846.6MHz)
 Date: 6.MAY.2014 21:54:36

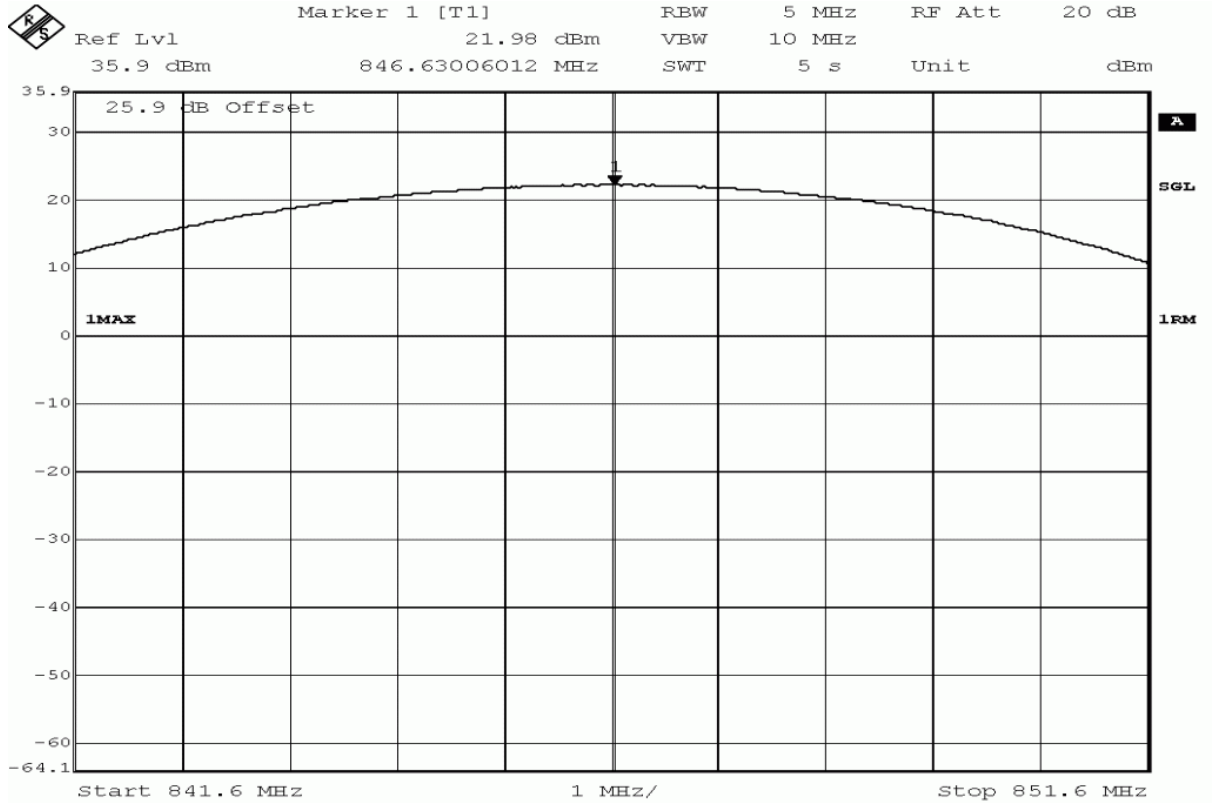

Title: output power measurement
 Comment A: DE1015001, subtest 1 HSDPA FDD V, output power, channel 4233 (846.6MHz)
 Date: 6.MAY.2014 21:54:53

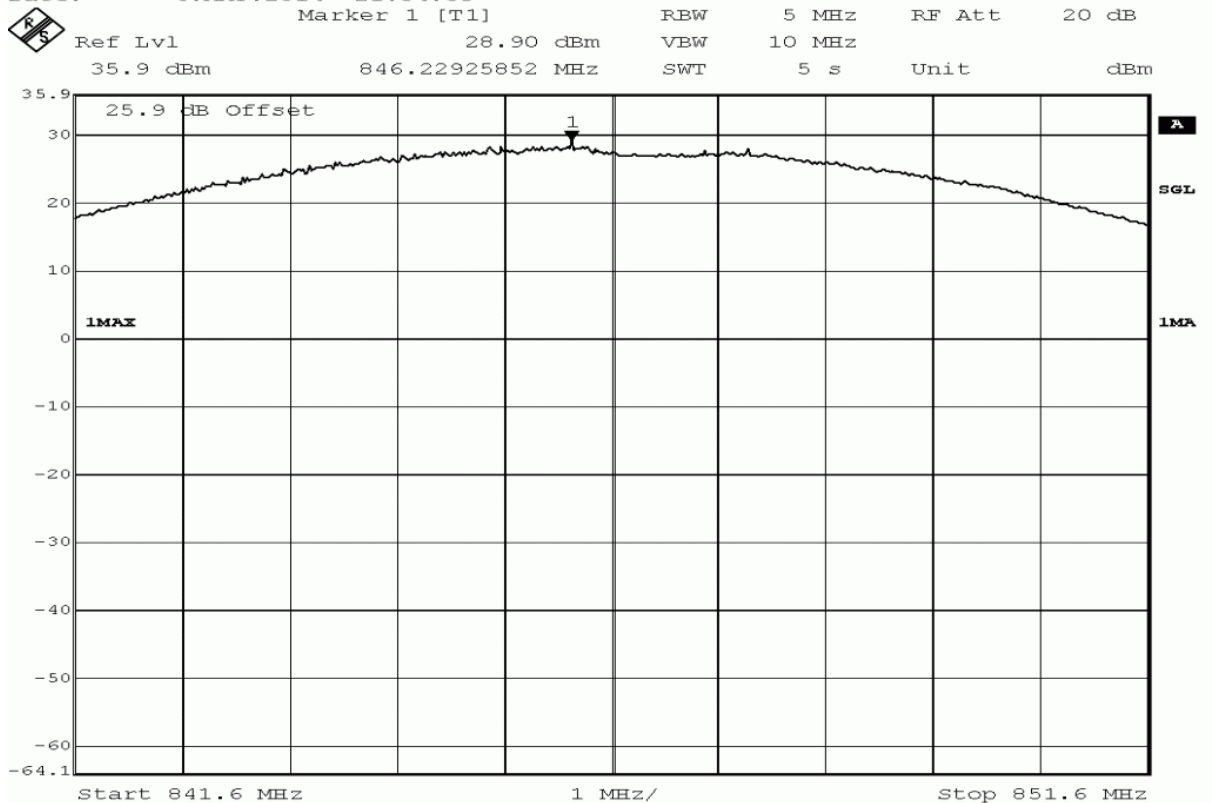

Title: output power measurement
 Comment A: DE1015001, subtest 1 HSUPA FDD V, output power, channel 4233 (846.6MHz)
 Date: 6.MAY.2014 19:54:32

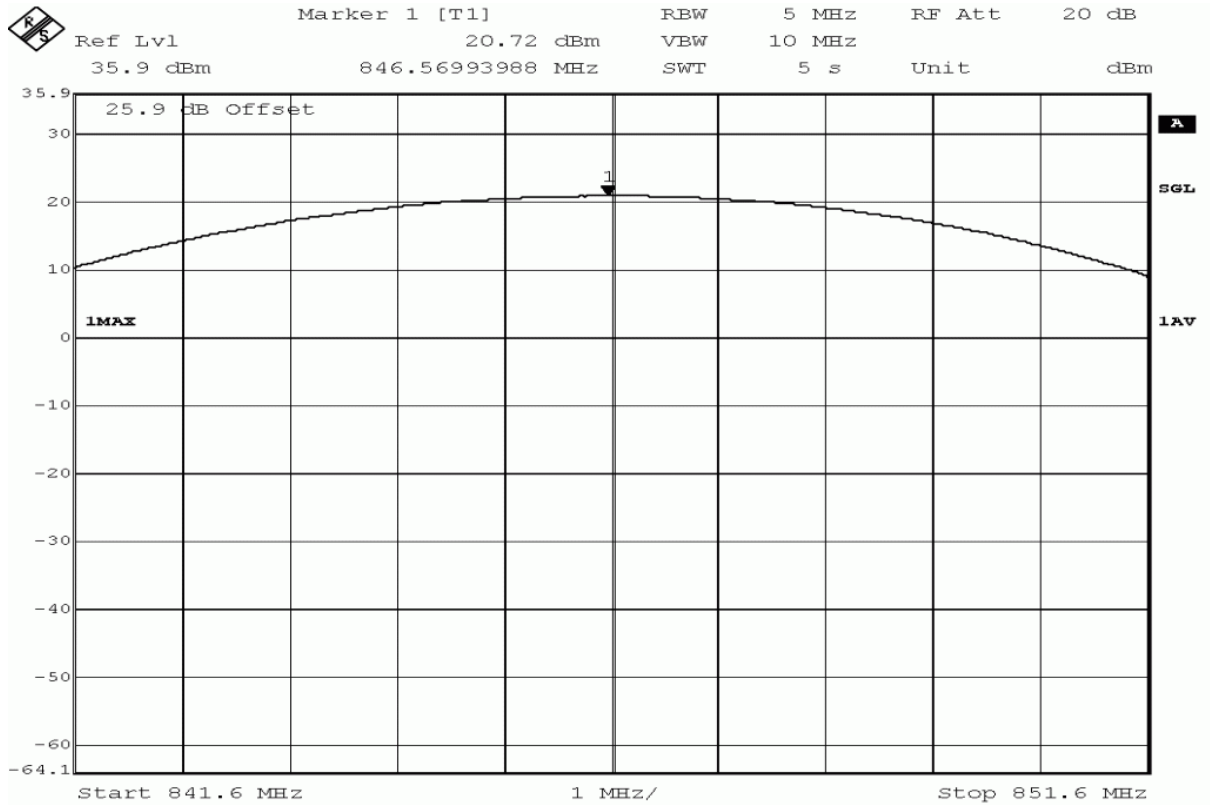

Title: output power measurement
 Comment A: DE1015001, subtest 1 HSUPA FDD V, output power, channel 4233 (846.6MHz)
 Date: 6.MAY.2014 19:54:49

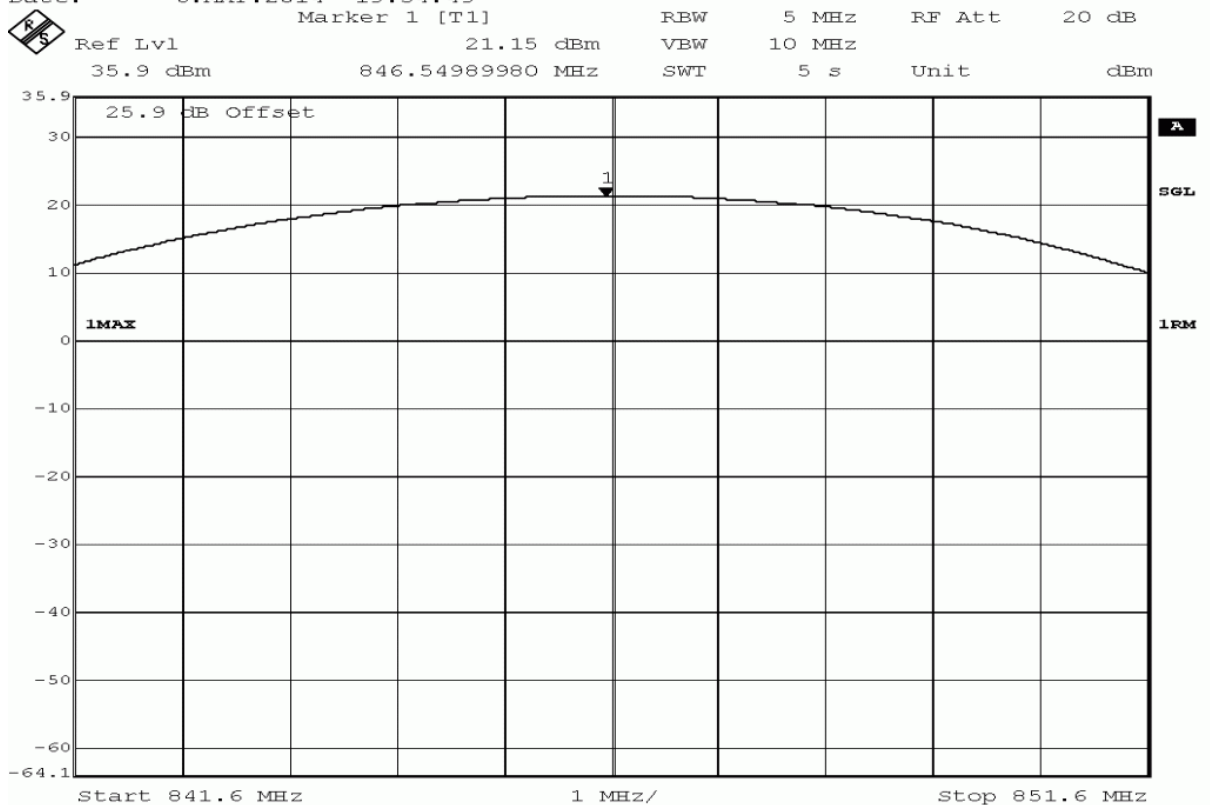

Title: output power measurement
 Comment A: DE1015001, subtest 1 HSUPA FDD V, output power, channel 4233 (846.6MHz)
 Date: 6.MAY.2014 19:55:06

3.5.2 22.2 Frequency stability §2.1055

Test: 22.2; Frequency Band = 850 / FDD5

<i>Result:</i>	Passed
<i>Setup No.:</i>	S_AH02
<i>Date of Test:</i>	2014/04/30 9:13
<i>Body:</i>	FCC47CFRChIPART22PUBLIC MOBILE SERVICES
<i>Test Specification:</i>	FCC part 2 and 22

Detailed Results:

GSM 850 Freq Stability

Temp. °C	Duration min	Voltage	Limit Hz	Freq. error Average (Hz)	Freq. error Max. (Hz)	Verdict
-30	0	normal	2095.5	6	14	passed
-30	5			3	15	passed
-30	10			5	14	passed
-20	0	normal	2095.5	3	9	passed
-20	5			2	19	passed
-20	10			3	12	passed
-10	0	normal	2095.5	6	11	passed
-10	5			4	12	passed
-10	10			1	12	passed
0	0	normal	2095.5	3	8	passed
0	5			4	11	passed
0	10			1	9	passed
10	0	normal	2095.5	3	10	passed
10	5			6	12	passed
10	10			4	14	passed
20	0	low	2095.5	-1	-11	passed
20	5			-1	-10	passed
20	10			-3	-8	passed
20	0	normal = high ¹⁾	2095.5	2	12	passed
20	5			4	12	passed
20	10			1	5	passed
20	0	high	2095.5	-2	-12	passed
20	5			1	9	passed
20	10			6	10	passed
30	0	normal	2095.5	1	9	passed
30	5			4	27	passed
30	10			7	11	passed
40	0	normal	2095.5	2	5	passed
40	5			4	13	passed
40	10			2	11	passed
50	0	normal	2095.5	5	11	passed
50	5			6	14	passed
50	10			6	13	passed

Battery operating end point voltage ²⁾						
Temp. °C	Duration min	Voltage V	Limit Hz	Freq. error Average (Hz)	Freq. error Max. (Hz)	Verdict
20	0	3.2	2095.5	-12	-24	passed
20	5			-5	-11	passed
20	10			-4	-11	passed

1) The manufacturer declared that normal voltage is equivalent with high voltage.

2) The call is established at high voltage and the voltage is then reduced to the battery operating end.

WCDMA FDD5 Freq Stability

Temp. °C	Duration min	Voltage	Limit Hz	Freq. error Average (Hz)	Freq. error Max. (Hz)	Verdict
-30	0	normal	2095.5	19	53	passed
-30	5			9	54	passed
-30	10			8	84	passed
-20	0	normal	2095.5	-13	-36	passed
-20	5			-1	-26	passed
-20	10			3	-26	passed
-10	0	normal	2095.5	-16	-28	passed
-10	5			-3	-35	passed
-10	10			-14	-35	passed
0	0	normal	2095.5	-28	-55	passed
0	5			-17	-55	passed
0	10			-13	-55	passed
10	0	normal	2095.5	-18	-50	passed
10	5			-10	-50	passed
10	10			-6	-50	passed
20	0	low	2095.5	-16	-26	passed
20	5			-15	-24	passed
20	10			23	26	passed
20	0	normal = high ¹⁾	2095.5	-20	-24	passed
20	5			-18	-21	passed
20	10			-11	-16	passed
20	0	high	2095.5	-12	-23	passed
20	5			-13	-16	passed
20	10			-2	-5	passed
30	0	normal	2095.5	-19	-28	passed
30	5			-9	-24	passed
30	10			-18	-22	passed
40	0	normal	2095.5	-17	-35	passed
40	5			-12	-48	passed
40	10			-18	-48	passed
50	0	normal	2095.5	10	-29	passed
50	5			19	30	passed
50	10			16	30	passed

Battery operating end point voltage ²⁾						
Temp. °C	Duration min	Voltage V	Limit Hz	Freq. error Average (Hz)	Freq. error Max. (Hz)	Verdict
20	0	3.2	2095.5	-18	-27	passed
20	5			16	18	passed
20	10			-23	-27	passed

- 1) The manufacturer declared that normal voltage is equivalent with high voltage.
- 2) The call is established at high voltage and the voltage is then reduced to the battery operating end.

3.5.3 22.3 Spurious emissions at antenna terminals §2.1051, §22.917

Test: 22.3; Frequency Band = 850, Mode = GSM, Channel = 128, Frequency = 824.2MHz,

Result: Passed
Setup No.: S_AH02
Date of Test: 2014/05/06 23:00
Body: FCC47CFRChIPART22PUBLIC MOBILE SERVICES
Test Specification: FCC part 2 and 22

Detailed Results:

detector	trace	resolution bandwidth /kHz	frequency /MHz	peak value /dBm	margin to limit /dB	limit /dBm	verdict
peak	maxhold	3	823.8938	-31.5	18.5	-13.0	passed
peak	maxhold	3	823.9178	-28.6	15.6	-13.0	passed
peak	maxhold	3	823.9359	-22.3	9.3	-13.0	passed
peak	maxhold	3	823.9519	-21.3	8.3	-13.0	passed
peak	maxhold	3	823.9619	-18.4	5.4	-13.0	passed
peak	maxhold	3	823.9840	-16.6	3.6	-13.0	passed
peak	maxhold	3	823.9980	-13.1	0.1	-13.0	passed

no further values have been found with a margin of less than 20 dB

* Emission shown in list is the carrier and not a spurious emission

Test: 22.3; Frequency Band = 850, Mode = GSM, Channel = 190, Frequency = 836.6MHz

Result: Passed
Setup No.: S_AH02
Date of Test: 2014/05/06 23:17
Body: FCC47CFRChIPART22PUBLIC MOBILE SERVICES
Test Specification: FCC part 2 and 22

Detailed Results:

detector	trace	resolution bandwidth /kHz	frequency /MHz	peak value /dBm	margin to limit /dB	limit /dBm	verdict
peak	maxhold	100	1673.347	-33.39	20.39	-13	passed

no further values have been found with a margin of less than 20 dB

* Emission shown in list is the carrier and not a spurious emission

Test: 22.3; Frequency Band = 850, Mode = GSM, Channel = 251, Frequency = 848.8MHz

Result: Passed
Setup No.: S_AH02
Date of Test: 2014/05/06 23:31
Body: FCC47CFRChIPART22PUBLIC MOBILE SERVICES
Test Specification: FCC part 2 and 22

Detailed Results:

detector	trace	resolution bandwidth /kHz	frequency /MHz	peak value /dBm	margin to limit /dB	limit /dBm	verdict
peak	maxhold	3	849.0020	-15.8	2.8	-13.0	passed
peak	maxhold	3	849.0080	-15.6	2.6	-13.0	passed
peak	maxhold	3	849.0281	-15.1	2.1	-13.0	passed
peak	maxhold	3	849.0501	-18.3	5.3	-13.0	passed
peak	maxhold	3	849.0641	-23.5	10.5	-13.0	passed
peak	maxhold	3	849.0762	-24.9	11.9	-13.0	passed
peak	maxhold	3	849.0882	-28.1	15.1	-13.0	passed
peak	maxhold	3	849.1022	-32.7	19.7	-13.0	passed
peak	maxhold	100	1697.39	-32.9	19.9	-13.0	passed

no further values have been found with a margin of less than 20 dB

Test: 22.3; Frequency Band = FDD5, Mode = HSDPA, Channel = 4132, Frequency = 826.4MHz

Result: Passed
 Setup No.: S_AH02
 Date of Test: 2014/05/07 16:20
 Body: FCC47CFRChIPART22PUBLIC MOBILE SERVICES
 Test Specification: FCC part 2 and 22

Detailed Results:

detector	trace	resolution bandwidth /kHz	frequency /MHz	peak value /dBm	margin to limit /dB	limit /dBm	verdict
rms	maxhold	50	824.00	-30.1	17.1	-13.0	passed

no further values have been found with a margin of less than 20 dB

Test: 22.3; Frequency Band = FDD5, Mode = HSDPA, Channel = 4183, Frequency = 836.6MHz

Result: Passed
 Setup No.: S_AH02
 Date of Test: 2014/05/07 16:28
 Body: FCC47CFRChIPART22PUBLIC MOBILE SERVICES
 Test Specification: FCC part 2 and 22

Detailed Results:

detector	trace	resolution bandwidth /kHz	frequency /MHz	peak value /dBm	margin to limit /dB	limit /dBm	verdict
peak	maxhold	100	6983.968	-34.38	21.38	-13	passed

no further values have been found with a margin of less than 20 dB

Test: 22.3; Frequency Band = FDD5, Mode = HSDPA, Channel = 4233, Frequency = 846.6MHz

Result: Passed
 Setup No.: S_AH02
 Date of Test: 2014/05/07 16:32
 Body: FCC47CFRChIPART22PUBLIC MOBILE SERVICES
 Test Specification: FCC part 2 and 22

Detailed Results:

detector	trace	resolution bandwidth /kHz	frequency /MHz	peak value /dBm	margin to limit /dB	limit /dBm	verdict
rms	maxhold	50	849.14	-30.8	17.8	-13.0	passed

no further values have been found with a margin of less than 20 dB

Test: 22.3; Frequency Band = FDD5, Mode = HSUPA, Channel = 4132, Frequency = 826.4MHz

Result: Passed
 Setup No.: S_AH02
 Date of Test: 2014/05/07 15:57
 Body: FCC47CFRChIPART22PUBLIC MOBILE SERVICES
 Test Specification: FCC part 2 and 22

Detailed Results:

detector	trace	resolution bandwidth /kHz	frequency /MHz	peak value /dBm	margin to limit /dB	limit /dBm	verdict
rms	maxhold	50	824.00	-31.1	18.1	-13.0	passed

no further values have been found with a margin of less than 20 dB

Test: 22.3; Frequency Band = FDD5, Mode = HSUPA, Channel = 4183, Frequency = 836.6MHz

Result: Passed
 Setup No.: S_AH02
 Date of Test: 2014/05/07 16:03
 Body: FCC47CFRChIPART22PUBLIC MOBILE SERVICES
 Test Specification: FCC part 2 and 22

Detailed Results:

detector	trace	resolution bandwidth /kHz	frequency /MHz	peak value /dBm	margin to limit /dB	limit /dBm	verdict
peak	maxhold	100	6993.988	-34.23	21.23	-13	passed

no further values have been found with a margin of less than 20 dB

Test: 22.3; Frequency Band = FDD5, Mode = HSUPA, Channel = 4233, Frequency = 846.6MHz

Result: Passed
 Setup No.: S_AH02
 Date of Test: 2014/05/07 16:12
 Body: FCC47CFRChIPART22PUBLIC MOBILE SERVICES
 Test Specification: FCC part 2 and 22

Detailed Results:

detector	trace	resolution bandwidth /kHz	frequency /MHz	peak value /dBm	margin to limit /dB	limit /dBm	verdict
rms	maxhold	50	849.11	-31.7	18.7	-13.0	passed

no further values have been found with a margin of less than 20 dB

Test: 22.3; Frequency Band = FDD5, Mode = W-CDMA, Channel = 4132, Frequency = 826.4MHz

Result: Passed
 Setup No.: S_AH02
 Date of Test: 2014/05/07 17:10
 Body: FCC47CFRChIPART22PUBLIC MOBILE SERVICES
 Test Specification: FCC part 2 and 22

Detailed Results:

detector	trace	resolution bandwidth /kHz	frequency /MHz	peak value /dBm	margin to limit /dB	limit /dBm	verdict
rms	maxhold	50	824.00	-30.5	17.5	-13.0	passed

no further values have been found with a margin of less than 20 dB

Test: 22.3; Frequency Band = FDD5, Mode = W-CDMA, Channel = 4183, Frequency = 836.6MHz

Result: Passed
 Setup No.: S_AH02
 Date of Test: 2014/05/07 17:13
 Body: FCC47CFRChIPART22PUBLIC MOBILE SERVICES
 Test Specification: FCC part 2 and 22

Detailed Results:

detector	trace	resolution bandwidth /kHz	frequency /MHz	peak value /dBm	margin to limit /dB	limit /dBm	verdict
peak	maxhold	100	6993.988	-34.32	21.32	-13	passed

no further values have been found with a margin of less than 20 dB

Test: 22.3; Frequency Band = FDD5, Mode = W-CDMA, Channel = 4233, Frequency = 846.6MHz

Result: Passed
Setup No.: S_AH02
Date of Test: 2014/05/07 17:15
Body: FCC47CFRChIPART22PUBLIC MOBILE SERVICES
Test Specification: FCC part 2 and 22

Detailed Results:

detector	trace	resolution bandwidth /kHz	frequency /MHz	peak value /dBm	margin to limit /dB	limit /dBm	verdict
rms	maxhold	50	849.11	-30.8	17.8	-13.0	passed

no further values have been found with a margin of less than 20 dB

3.5.4 22.4 Field strength of spurious radiation §2.1053, §22.917

Test: 22.4; Frequency Band = 850, Mode = GSM, Channel = 190, Frequency = 836.6MHz

Result: Passed
 Setup No.: S_AH02_RSE
 Date of Test: 2014/04/23 23:26
 Body: FCC47CFRChIPART22PUBLIC MOBILE SERVICES
 Test Specification: FCC part 2 and 22

Detailed Results:

detector	trace	resolution bandwidth /kHz	frequency /MHz	peak value /dBm	limit /dBm	margin to limit /dB	azimuth /°	antenna polarization	EUT orientation	verdict
peak	maxhold	1000	9519.0	-42.00	-13.00	29.00	0.0	horizontal	vertical	passed

no further values have been found with a margin of less than 20 dB

Test: 22.4; Frequency Band = FDD5, Mode = HSDPA, Channel = 4183, Frequency = 836.6MHz

Result: Passed
 Setup No.: S_AH02_RSE
 Date of Test: 2014/05/02 16:19
 Body: FCC47CFRChIPART22PUBLIC MOBILE SERVICES
 Test Specification: FCC part 2 and 22

Detailed Results:

detector	trace	resolution bandwidth /kHz	frequency /MHz	peak value /dBm	limit /dBm	margin to limit /dB	azimuth /°	antenna polarization	EUT orientation	verdict
peak	maxhold	1000	881.6	-27.07	-13.00	14.07	90.0	horizontal	vertical	passed

no further values have been found with a margin of less than 20 dB

Test: 22.4; Frequency Band = FDD5, Mode = HSUPA, Channel = 4183, Frequency = 836.6MHz

Result: Passed
 Setup No.: S_AH02_RSE
 Date of Test: 2014/05/08 22:32
 Body: FCC47CFRChIPART22PUBLIC MOBILE SERVICES
 Test Specification: FCC part 2 and 22

Detailed Results:

detector	trace	resolution bandwidth /kHz	frequency /MHz	peak value /dBm	limit /dBm	margin to limit /dB	azimuth /°	antenna polarization	EUT orientation	verdict
peak	maxhold	1000	823.0	-38.49	-13.00	25.49	0.0	horizontal	vertical	passed

no further values have been found with a margin of less than 20 dB

Test: 22.4; Frequency Band = FDD5, Mode = W-CDMA, Channel = 4183, Frequency = 836.6MHz

Result: Passed
Setup No.: S_AH02_RSE
Date of Test: 2014/04/26 0:04
Body: FCC47CFRChIPART22PUBLIC MOBILE SERVICES
Test Specification: FCC part 2 and 22

Detailed Results:

detector	trace	resolution bandwidth /kHz	frequency /MHz	peak value /dBm	limit /dBm	margin to limit /dB	azimuth /°	antenna polarization	EUT orientation	verdict
peak	maxhold	1000	42.7	-42.25	-13.00	29.25	-90.0	vertical	vertical	passed

no further values have been found with a margin of less than 20 dB

3.5.5 22.5 Emission and Occupied Bandwidth §2.1049, §22.917

Test: 22.5; Frequency Band = 850 / FDD5

<i>Result:</i>	Passed
<i>Setup No.:</i>	S_AH02
<i>Date of Test:</i>	2014/05/06 9:57
<i>Body:</i>	FCC47CFRChIPART22PUBLIC MOBILE SERVICES
<i>Test Specification:</i>	FCC part 2 and 22

Detailed Results:

Band	Mode	Modulation	Channel	Frequency (MHz)	26 dB Bandwidth (KHz)	99% Bandwidth (KHz)	Detector	RBW (KHz)	Verdict
850	GSM / GPRS	GFSK	Low	824,2	308.6	250.5	Peak	3	Pass
			Mid	836,6	314.6	246.5			Pass
			High	848,8	306.6	240.5			Pass
FDD 5	W-CDMA	QPSK	Low	826.4	4669.3	4088.2	Peak	100	Pass
			Mid	836.6	4649.3	4088.2			Pass
			High	846.6	4649.3	4068.1			Pass
FDD 5	HSDPA	QPSK	Low	826.4	4649.3	4068.1	Peak	100	Pass
			Mid	836.6	4669.3	4068.1			Pass
			High	846.6	4649.3	4068.1			Pass
FDD 5	HSUPA	QPSK	Low	826.4	4669.3	4108.2	Peak	100	Pass
			Mid	836.6	4649.3	4088.2			Pass
			High	846.6	4649.3	4088.2			Pass

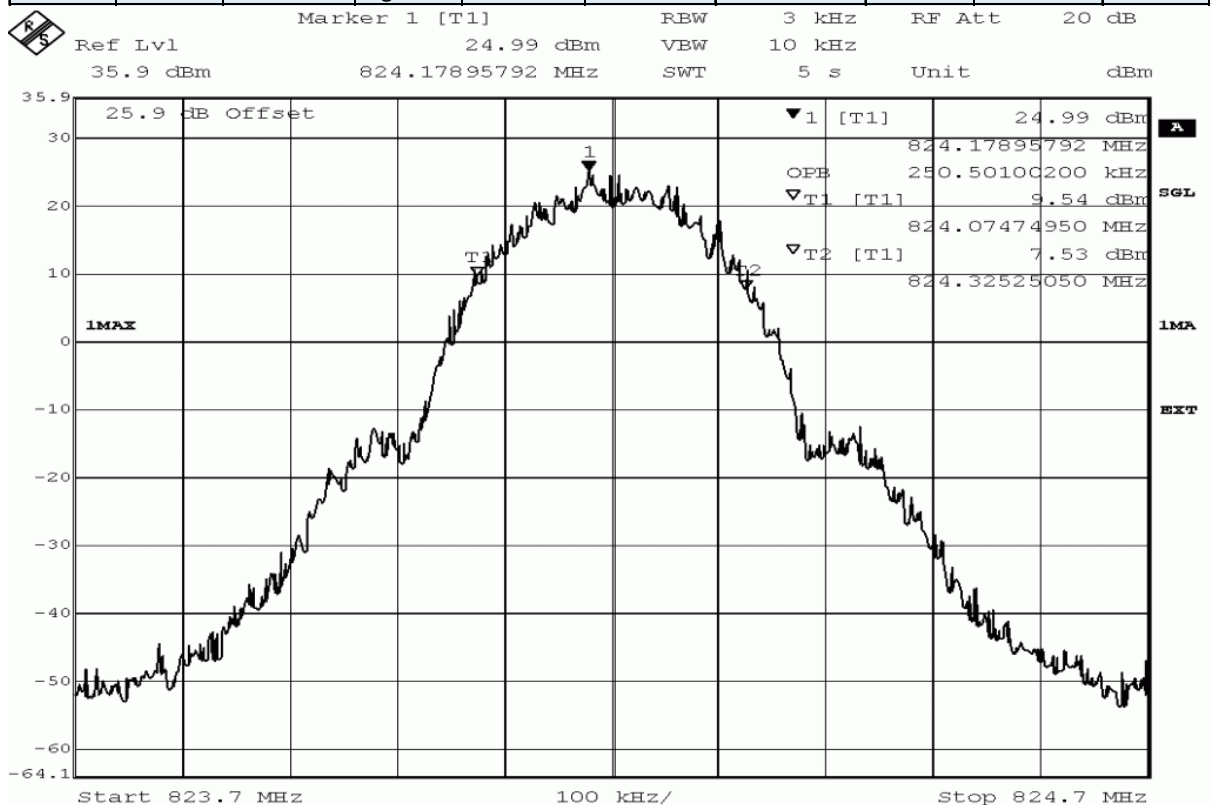

Title: bandwidth measurement
 Comment A: DE1015001, GSM850, occupied bandwidth (99%), channel 128 (824.2MHz)
 Date: 6.MAY.2014 23:19:08

99% Bandwidth GSM Low channel

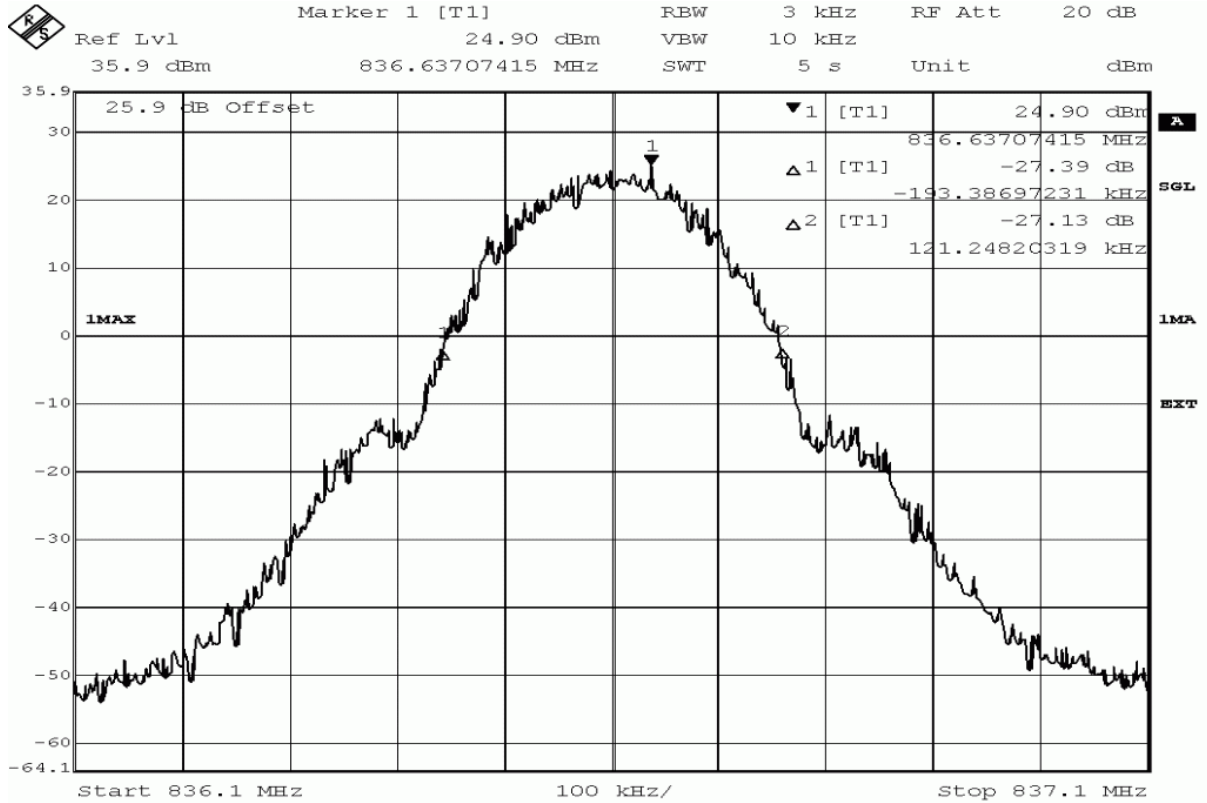

Title: bandwidth measurement
 Comment A: DE1015001, GSM850, 26dB bandwidth, channel 190 (836.6MHz)
 Date: 6.MAY.2014 23:35:56

26dB Bandwidth Mid channel

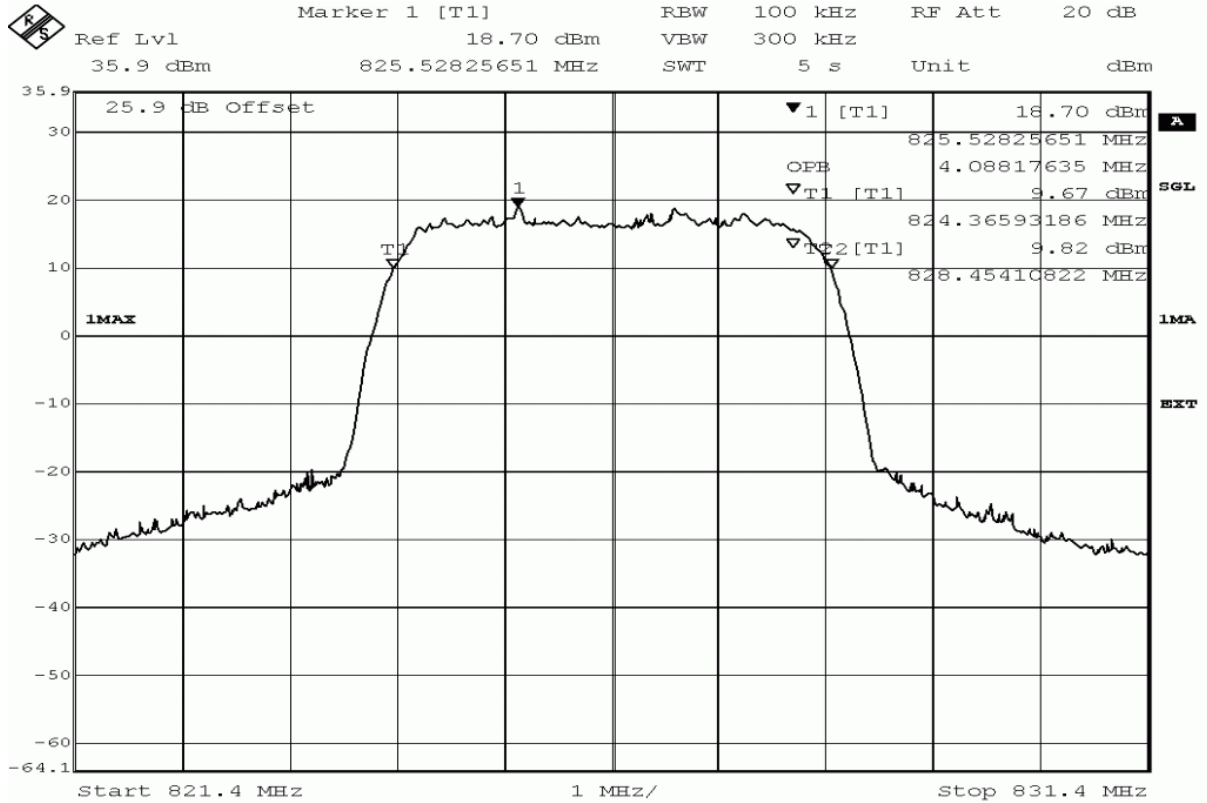

Title: bandwidth measurement
 Comment A: DE1015001, FDD V, occupied bandwidth (99%),
 channel 4132 (826.4MHz)
 Date: 6.MAY.2014 22:33:54

WCDMA 99% Bandwidth Low channel

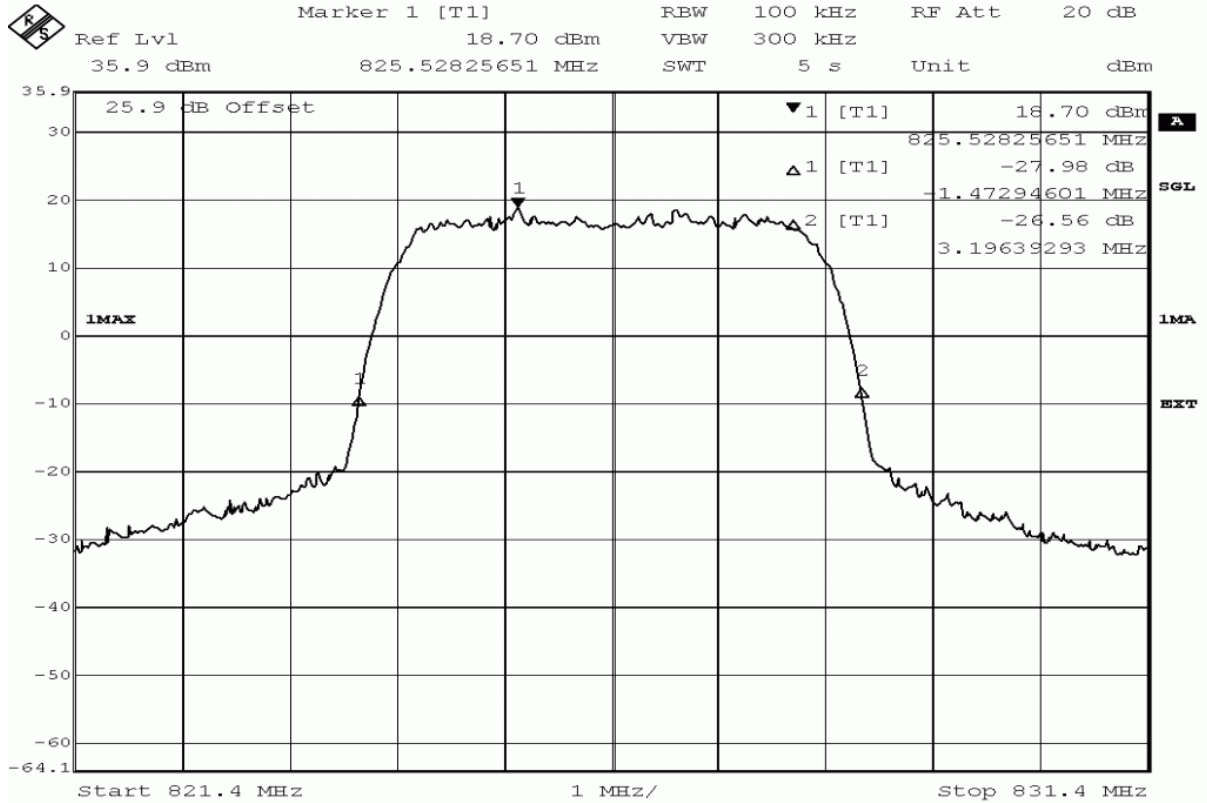

Title: bandwidth measurement
 Comment A: DE1015001, FDD V, 26dB bandwidth, channel 4132 (826.4MHz)
 Date: 6.MAY.2014 22:33:31

WCDMA 26dB Bandwidth Low channel

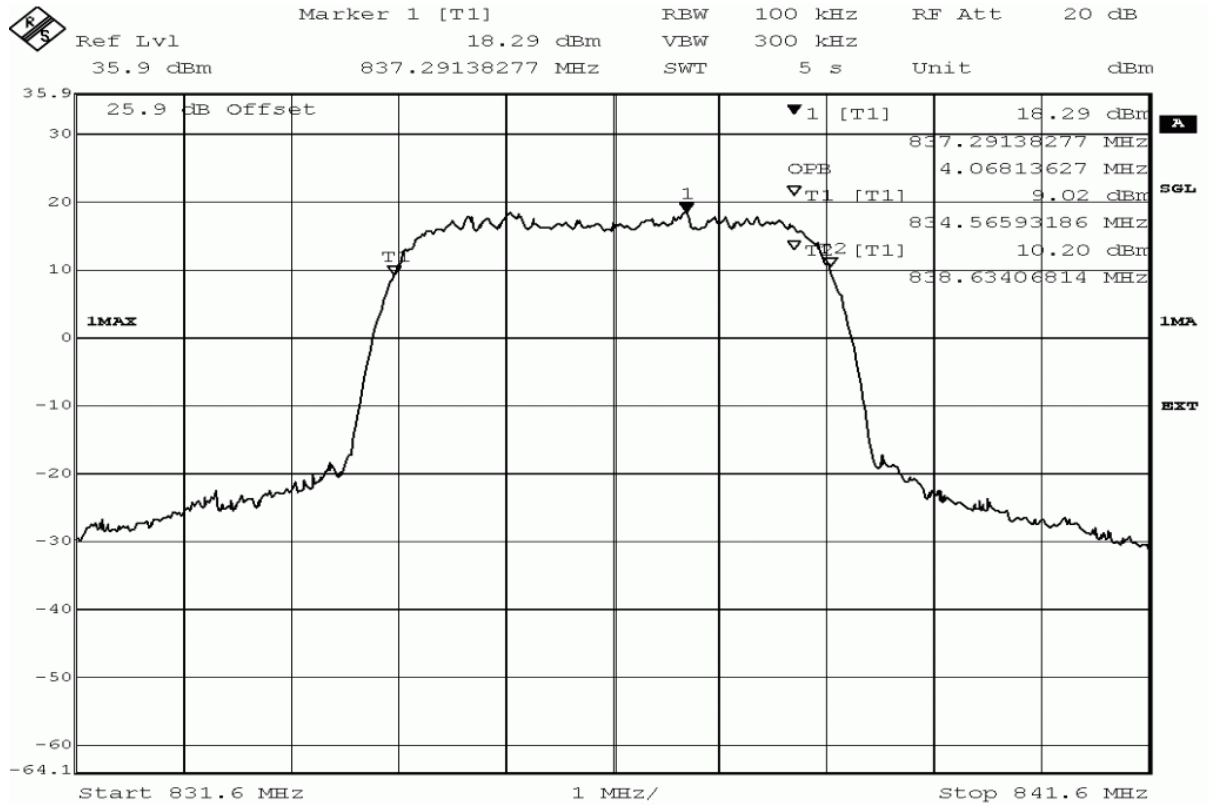

Title: bandwidth measurement
 Comment A: DE1015001, FDD V, occupied bandwidth (99%),
 channel 4183 (836.6MHz)
 Date: 6.MAY.2014 21:53:27

HSDPA 99% Bandwidth Mid channel

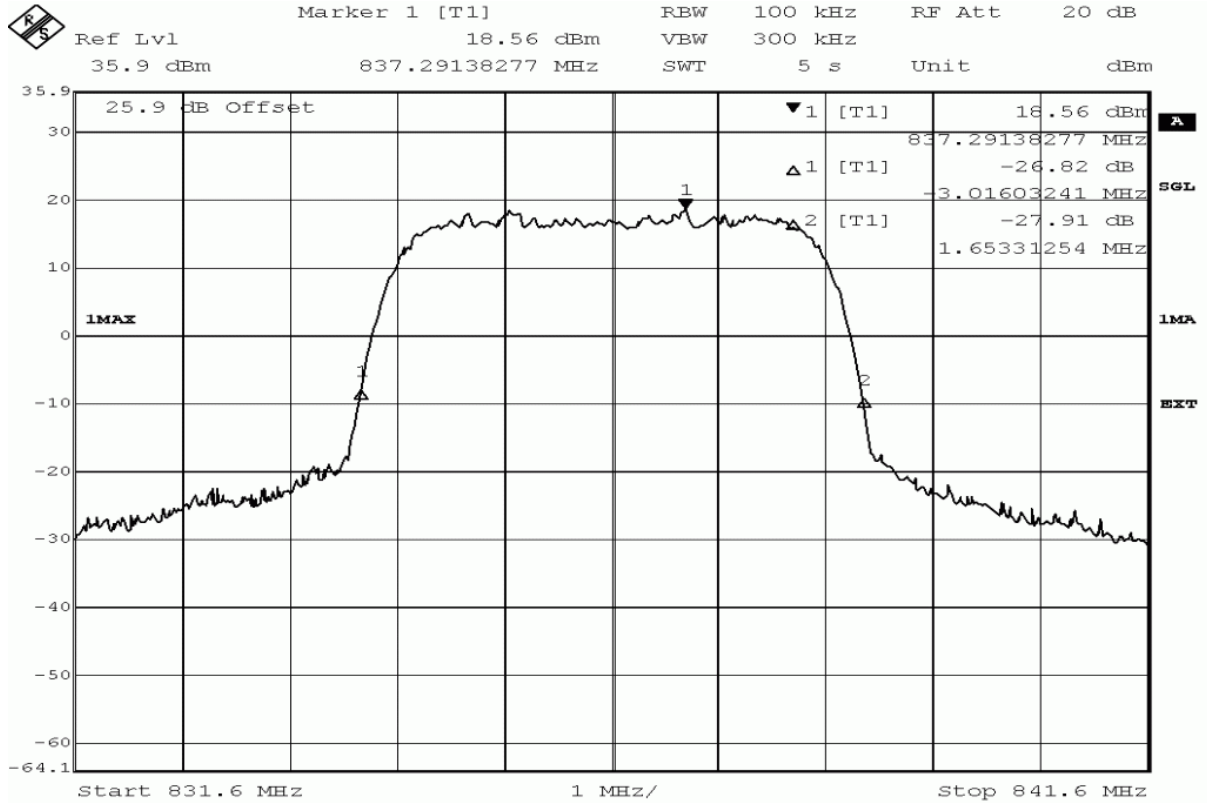

Title: bandwidth measurement
 Comment A: DE1015001, FDD V, 26dB bandwidth, channel 4183 (836.6MHz)
 Date: 6.MAY.2014 21:53:04

HSDPA 26dB Bandwidth Mid channel

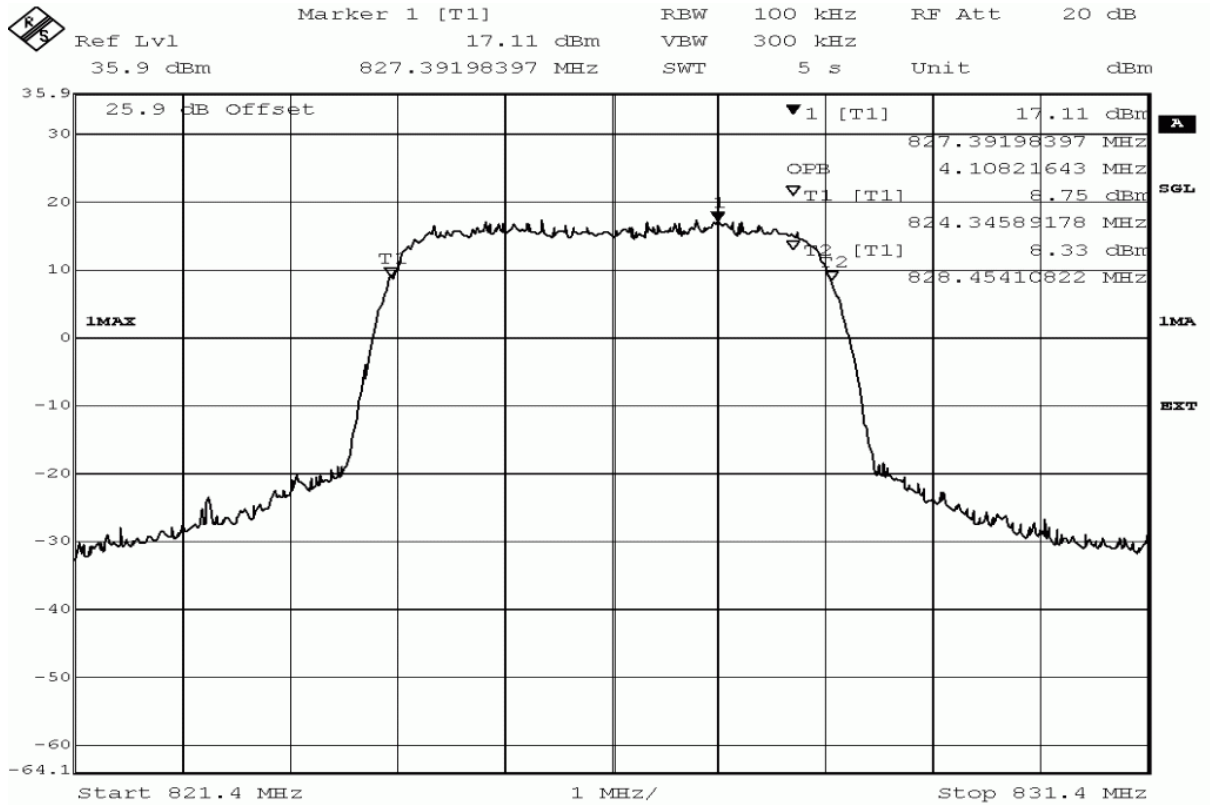

Title: bandwidth measurement
 Comment A: DE1015001, FDD V, occupied bandwidth (99%),
 channel 4132 (826.4MHz)
 Date: 6.MAY.2014 20:43:49

HSUPA 99% Bandwidth Low channel

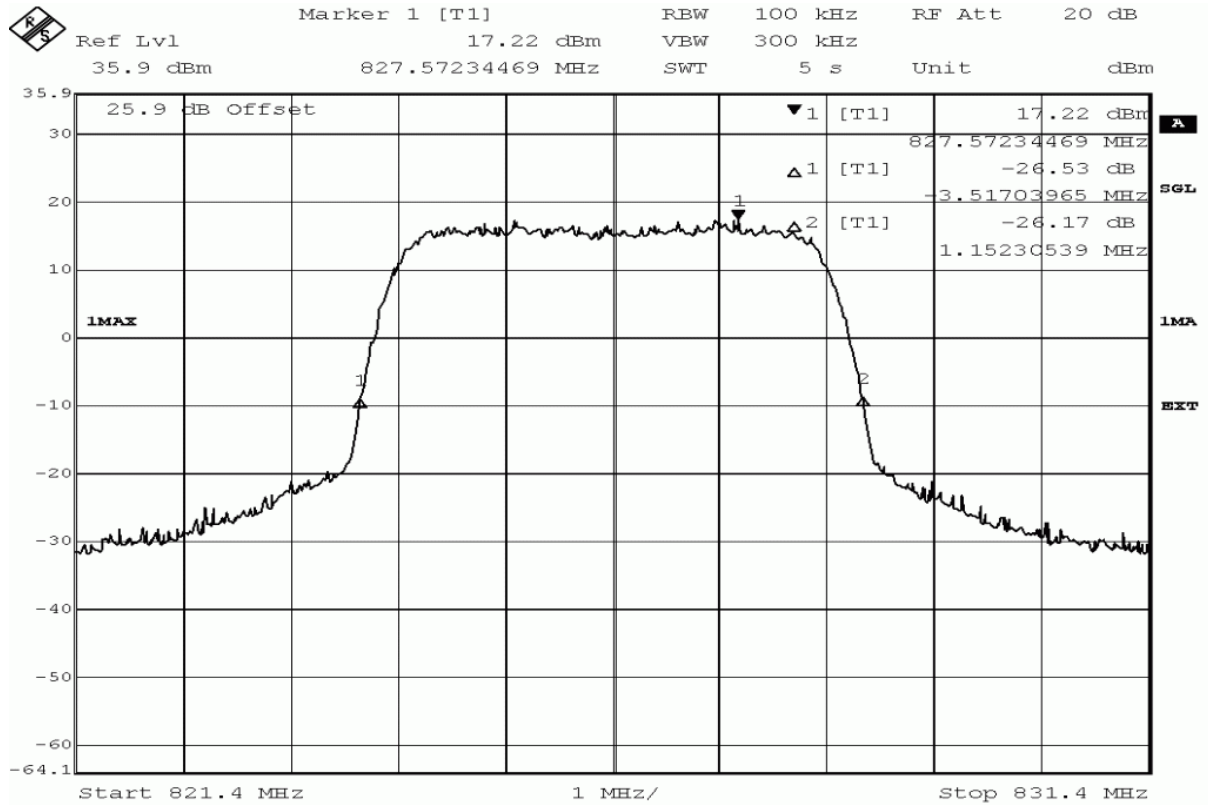

Title: bandwidth measurement
 Comment A: DE1015001, FDD V, 26dB bandwidth,
 channel 4132 (826.4MHz)
 Date: 6.MAY.2014 20:43:26

HSUPA 26dB Bandwidth Low channel

3.5.6 22.6 Band edge compliance §2.1053, §22.917

Test: 22.6; Frequency Band = 850 / FDD5

<i>Result:</i>	Passed
<i>Setup No.:</i>	S_AH02
<i>Date of Test:</i>	2014/05/06 9:43
<i>Body:</i>	FCC47CFRChIPART22PUBLIC MOBILE SERVICES
<i>Test Specification:</i>	FCC part 2 and 22

Detailed Results:

Band	Mode	Modulation	Detector	Frequency (MHZ)	peak value /dBm	margin to limit /dB	limit /dBm	Verdict
850	GSM / GPRS	GFSK	peak	823.993	-15.76	2.76	-13.0	passed
			average	823.979	-34.09	21.09	-13.0	passed
			rms	823.979	-26.41	13.41	-13.0	passed
			peak	849.015	-14.06	1.06	-13.0	passed
			average	849.007	-34.56	21.56	-13.0	passed
			rms	849.018	-27.00	14.00	-13.0	passed
Band	Mode	Modulation	Detector	Frequency (MHZ)	peak value /dBm	margin to limit /dB	limit /dBm	Verdict
FDD 5	W-CDMA	QPSK	peak	823.988	-22.66	9.66	-13.0	Pass
			average	824.000	-30.12	17.12	-13.0	Pass
			rms	824.000	-29.56	16.56	-13.0	Pass
			peak	849.140	-21.33	8.33	-13.0	Pass
			average	849.105	-31.04	18.04	-13.0	Pass
			rms	849.105	-30.12	17.12	-13.0	Pass
	HSDPA		peak	824.000	-21.74	8.74	-13.0	Pass
			average	824.000	-30.12	17.12	-13.0	Pass
			rms	824.000	-29.30	16.30	-13.0	Pass
			peak	849.093	-21.33	8.33	-13.0	Pass
			average	849.082	-31.37	18.37	-13.0	Pass
			rms	849.093	-30.42	17.42	-13.0	Pass
	HSUPA		peak	824.000	-21.97	8.97	-13.0	Pass
			average	824.000	-30.72	17.72	-13.0	Pass
			rms	824.000	-29.84	16.84	-13.0	Pass
			peak	849.163	-20.81	7.81	-13.0	Pass
			average	849.082	-31.71	18.71	-13.0	Pass
			rms	849.093	-30.72	17.72	-13.0	Pass

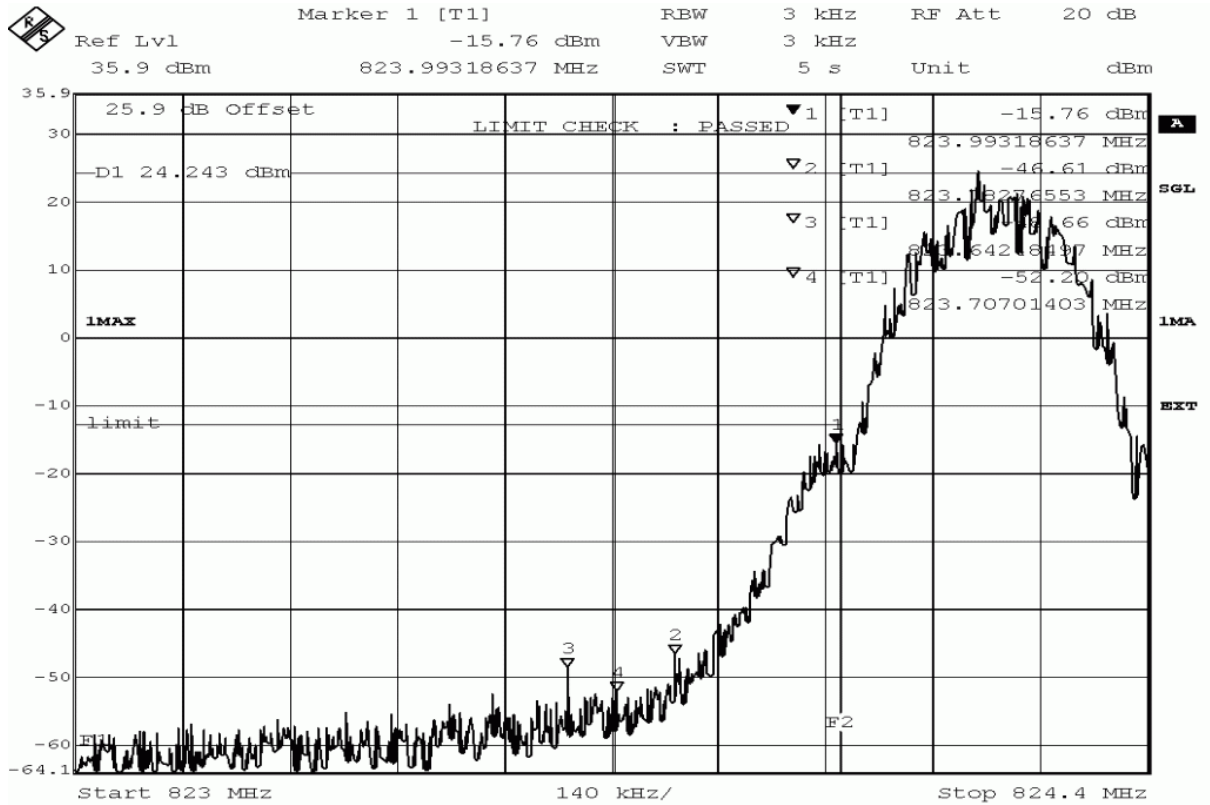

Title: band edge compliance measurement
 Comment A: DE1015001, GSM850, band edge compliance,
 channel 128 (824.2MHz)
 Date: 6.MAY.2014 23:21:11

GSM Low channel

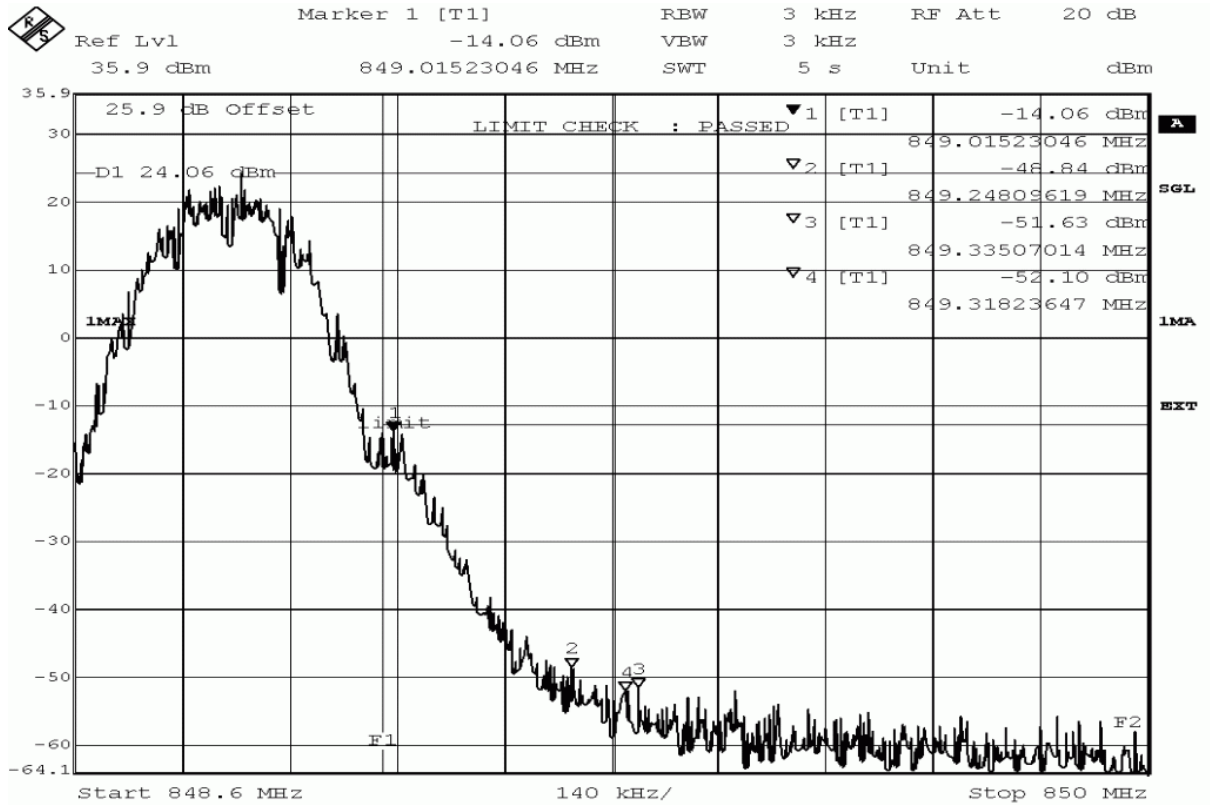

GSM High channel

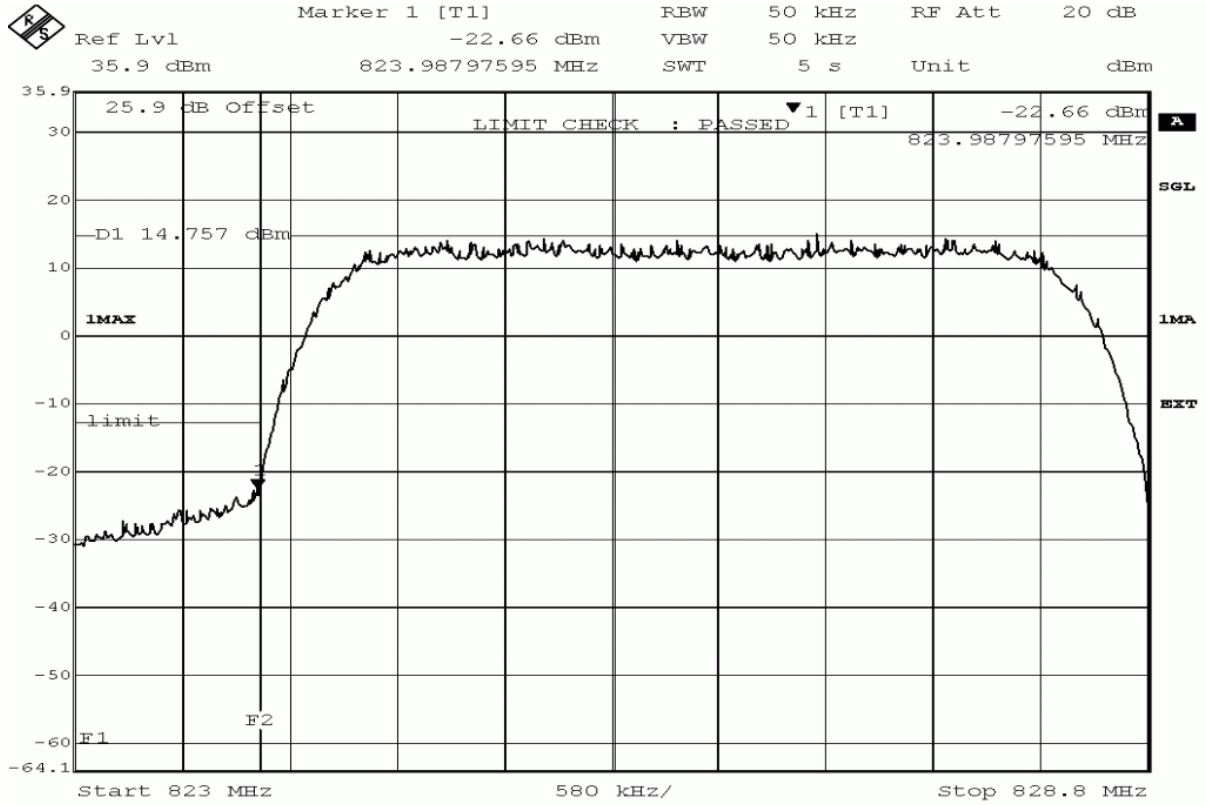

Title: band edge compliance measurement
 Comment A: DE1015001, FDD V, band edge compliance,
 channel 4132 (826.4MHz)
 Date: 6.MAY.2014 22:34:17

WCDMA Low channel

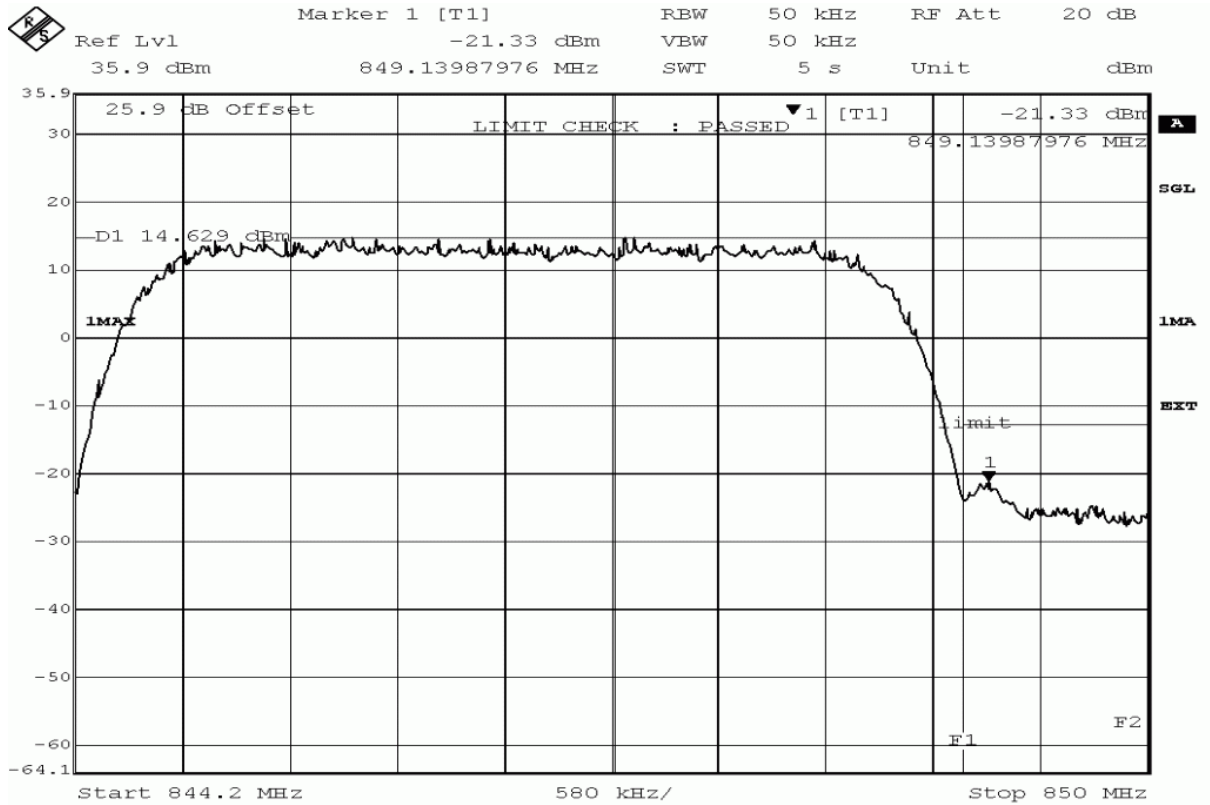

Title: band edge compliance measurement
 Comment A: DE1015001, FDD V, band edge compliance,
 channel 4233 (846.6MHz)
 Date: 6.MAY.2014 22:46:25

WCDMA High channel

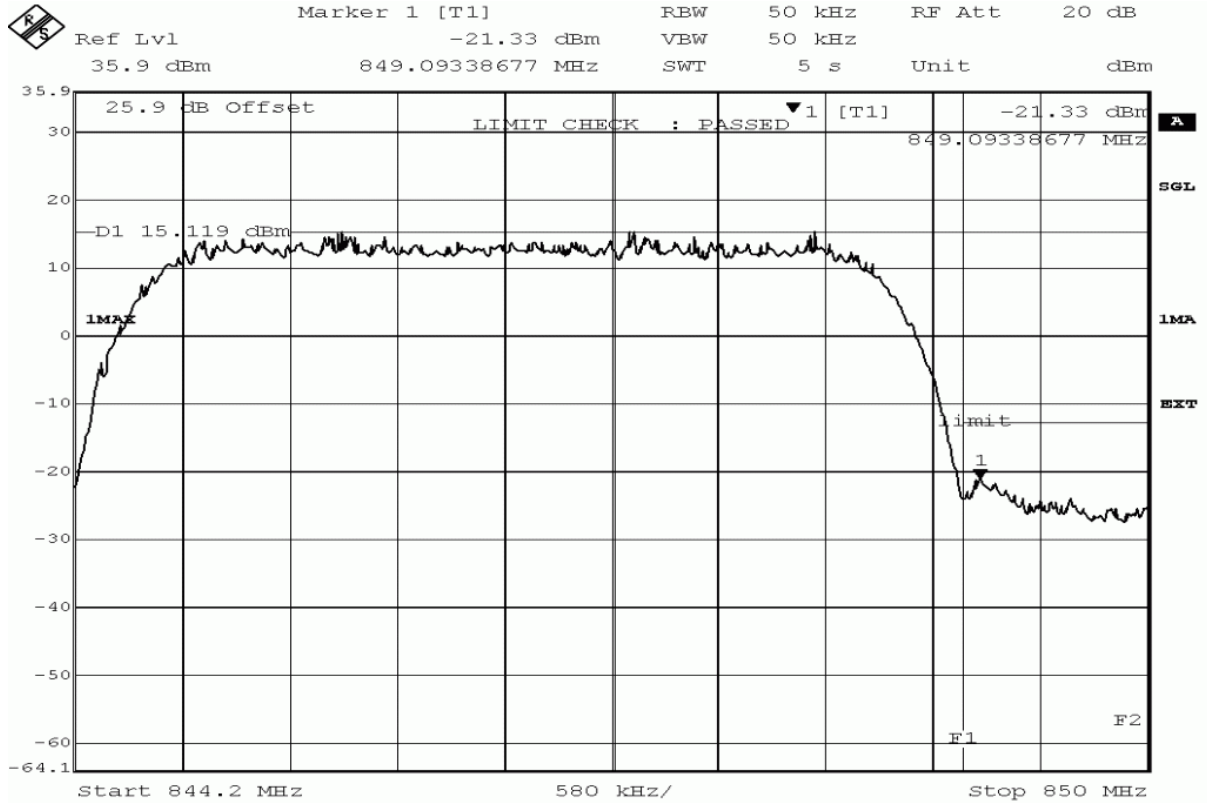

Title: band edge compliance measurement
 Comment A: DE1015001, FDD V, band edge compliance,
 channel 4233 (846.6MHz)
 Date: 6.MAY.2014 21:59:18

HSDPA High Channel

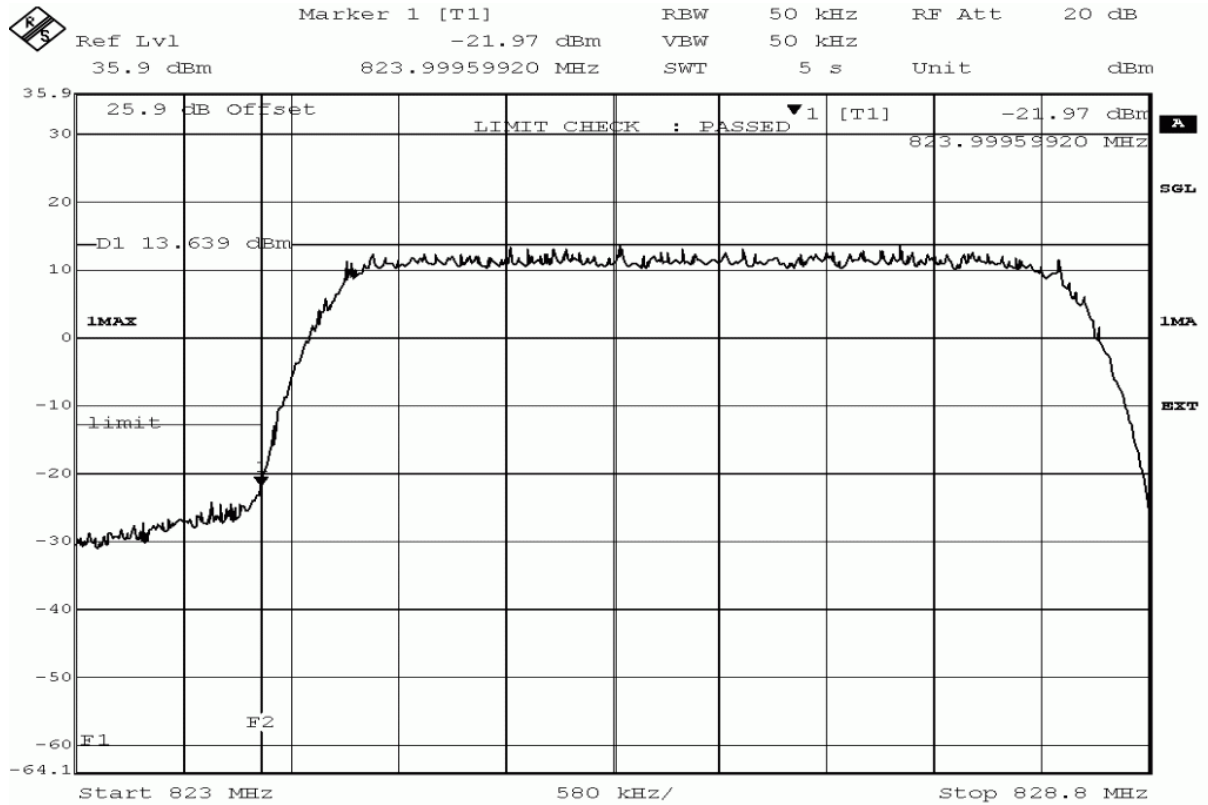

Title: band edge compliance measurement
 Comment A: DE1015001, FDD V, band edge compliance,
 channel 4132 (826.4MHz)
 Date: 6.MAY.2014 20:44:12

HSUPA Low Channel

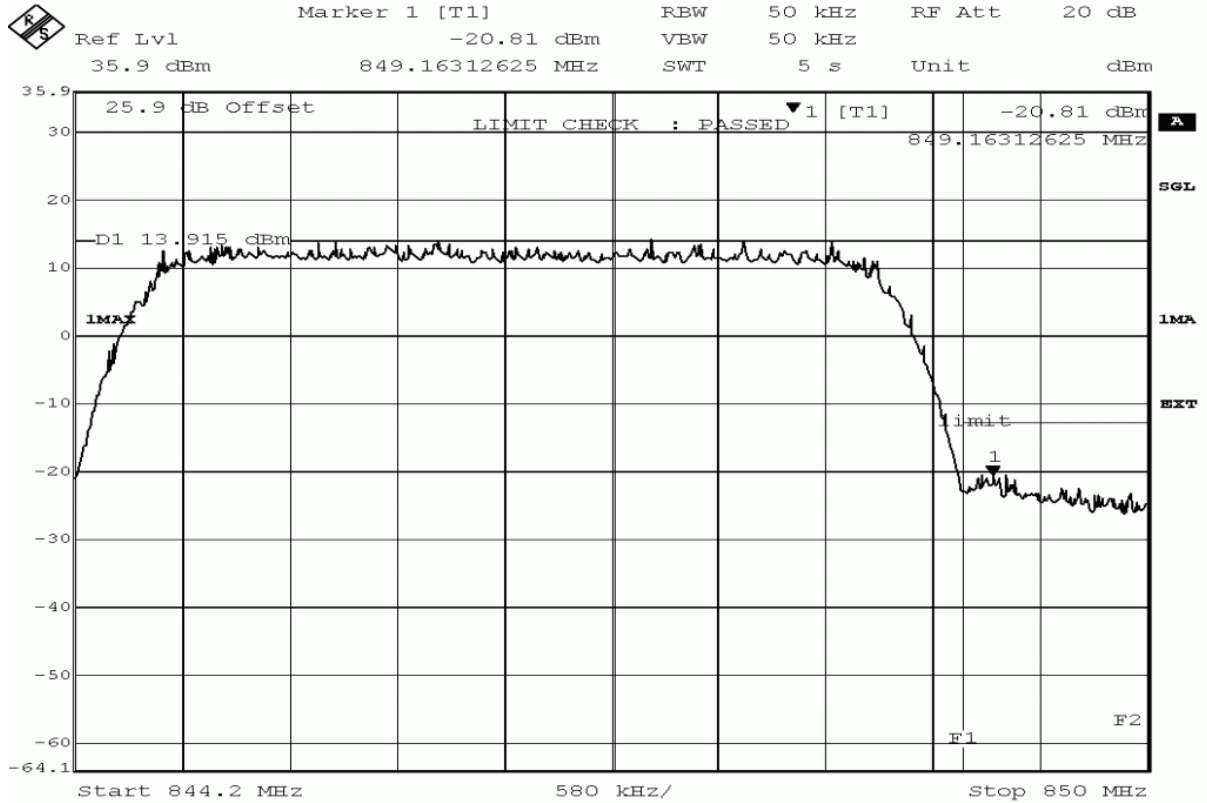

Title: band edge compliance measurement
 Comment A: DE1015001, FDD V, band edge compliance,
 channel 4233 (846.6MHz)
 Date: 6.MAY.2014 21:04:20

HSUPA High Channel

3.5.7 24.1 RF Power Output §2.1046, §24.232

Test: 24.1; Frequency Band = 1900 / FDD 2

<i>Result:</i>	Passed
<i>Setup No.:</i>	S_AH02
<i>Date of Test:</i>	2014/05/07 8:49
<i>Body:</i>	FCC47CFRChIPART24PERSONAL COMMUNICATIONS SERVICES
<i>Test Specification:</i>	FCC part 2 and 24

Detailed Results:

Band	Mode	Modulation	Channel	Frequency (MHZ)	Average Conducted power	RMS Conducted power	Peak Conducted power	FCC EIRP limit (W)	IC EIRP limit per SRSP-503 (W)	Maximum antenna gain (dBi)	Verdict
1900	GSM / GPRS	GFSK	Low	1850.2	29.9	29.9	30.27	2	2	3.1	Pass
			Mid	1880	29.55	29.57	29.93			3.43	Pass
			High	1909.8	29.34	29.36	29.73			3.64	Pass
Band	Mode	Modulation	Channel	Frequency (MHZ)	Average Conducted power	RMS Conducted power	Peak Conducted power	FCC EIRP limit (W)	IC EIRP limit per SRSP-503 (W)	Maximum antenna gain (dBi)	Verdict
FDD 2	W-CDMA	QPSK	Low	1852.4	22	22.28	27.59	2	2	10.72	Pass
			Mid	1880	21.94	22.18	27.84			10.82	Pass
			High	1907.6	21.37	21.63	27.22			11.37	Pass
FDD 2	HSDPA Subtest 1	QPSK	Low	1852.4	21.84	22.09	27.59	2	2	10.91	Pass
			Mid	1880	21.77	22.03	27.59			10.97	Pass
			High	1907.6	21.17	21.42	26.95			11.58	Pass
FDD 2	HSDPA Subtest 2	QPSK	Low	1852.4	19.96	20.75	28.89	2	2	12.25	Pass
			Mid	1880	19.76	20.56	28.52			12.44	Pass
			High	1907.6	19.44	20.17	27.84			12.83	Pass
FDD 2	HSDPA Subtest 3	QPSK	Low	1852.4	19.23	20.23	28.52	2	2	12.77	Pass
			Mid	1880	19.11	20.04	28.39			12.96	Pass
			High	1907.6	18.68	19.53	27.72			13.47	Pass
FDD 2	HSDPA Subtest 4	QPSK	Low	1852.4	18.75	19.75	27.72	2	2	13.25	Pass
			Mid	1880	18.56	19.68	28.26			13.32	Pass
			High	1907.6	18.17	19.31	27.84			13.69	Pass
FDD 2	HSUPA Subtest 1	QPSK	Low	1852.4	20.77	21.18	28.64	2	2	11.82	Pass
			Mid	1880	20.52	20.92	28.26			12.08	Pass
			High	1907.6	20.01	20.45	27.72			12.55	Pass
FDD 2	HSUPA Subtest 2	QPSK	Low	1852.4	18.74	19.65	28.1	2	2	13.35	Pass
			Mid	1880	18.53	19.46	28.1			13.54	Pass
			High	1907.6	18.18	19.1	27.44			13.9	Pass
FDD 2	HSUPA Subtest 3	QPSK	Low	1852.4	19.99	20.77	29.02	2	2	12.23	Pass
			Mid	1880	19.89	20.69	29.17			12.31	Pass
			High	1907.6	19.39	20.17	28.39			12.83	Pass
FDD 2	HSUPA Subtest 4	QPSK	Low	1852.4	19.25	20.19	28.1	2	2	12.82	Pass
			Mid	1880	19.08	20.02	27.97			12.98	Pass
			High	1907.6	18.57	19.52	27.31			13.48	Pass
FDD 2	HSUPA Subtest 4	QPSK	Low	1852.4	20.36	20.74	27.97	2	2	12.26	Pass
			Mid	1880	20.56	20.96	28.1			12.04	Pass
			High	1907.6	20.13	20.58	27.72			12.42	Pass

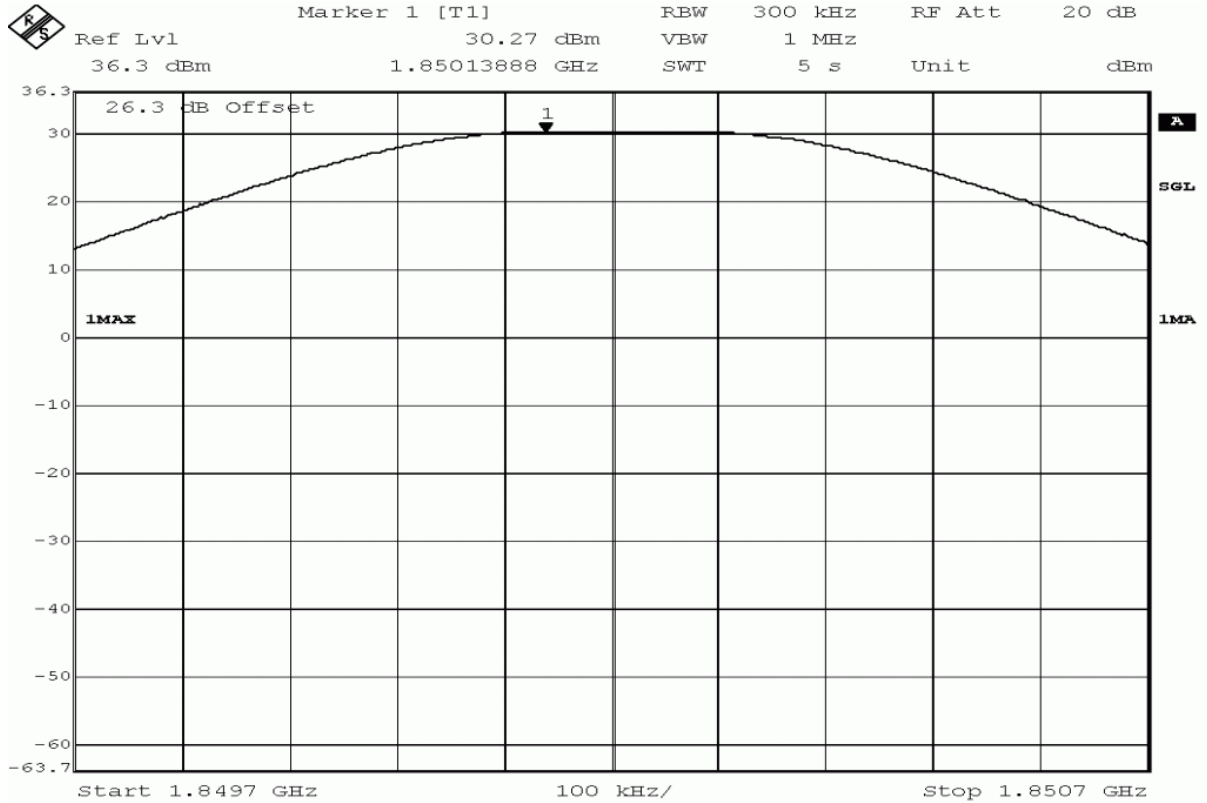

Title: output power measurement
 Comment A: DE1015001, GSM1900, output power, channel 512 (1850.2MHz)
 Date: 7.MAY.2014 12:13:38

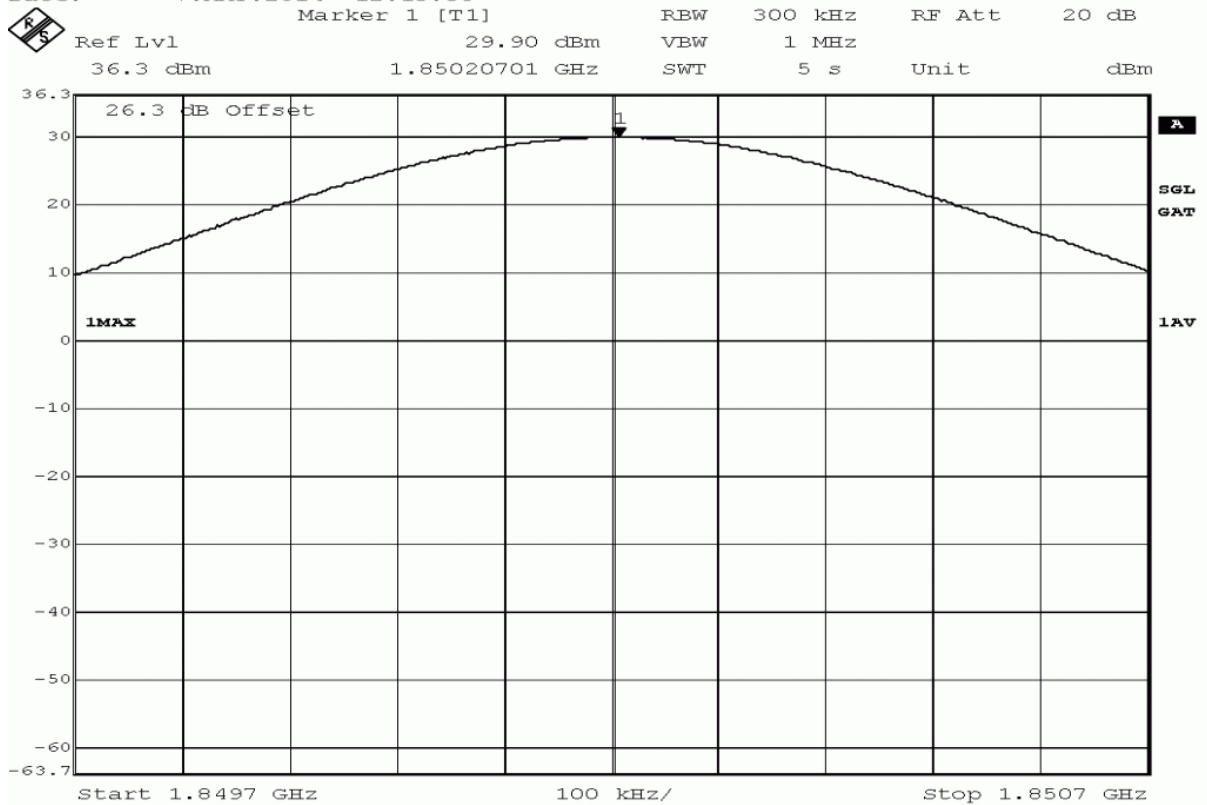

Title: output power measurement
 Comment A: DE1015001, GSM1900, output power, channel 512 (1850.2MHz)
 Date: 7.MAY.2014 12:14:33

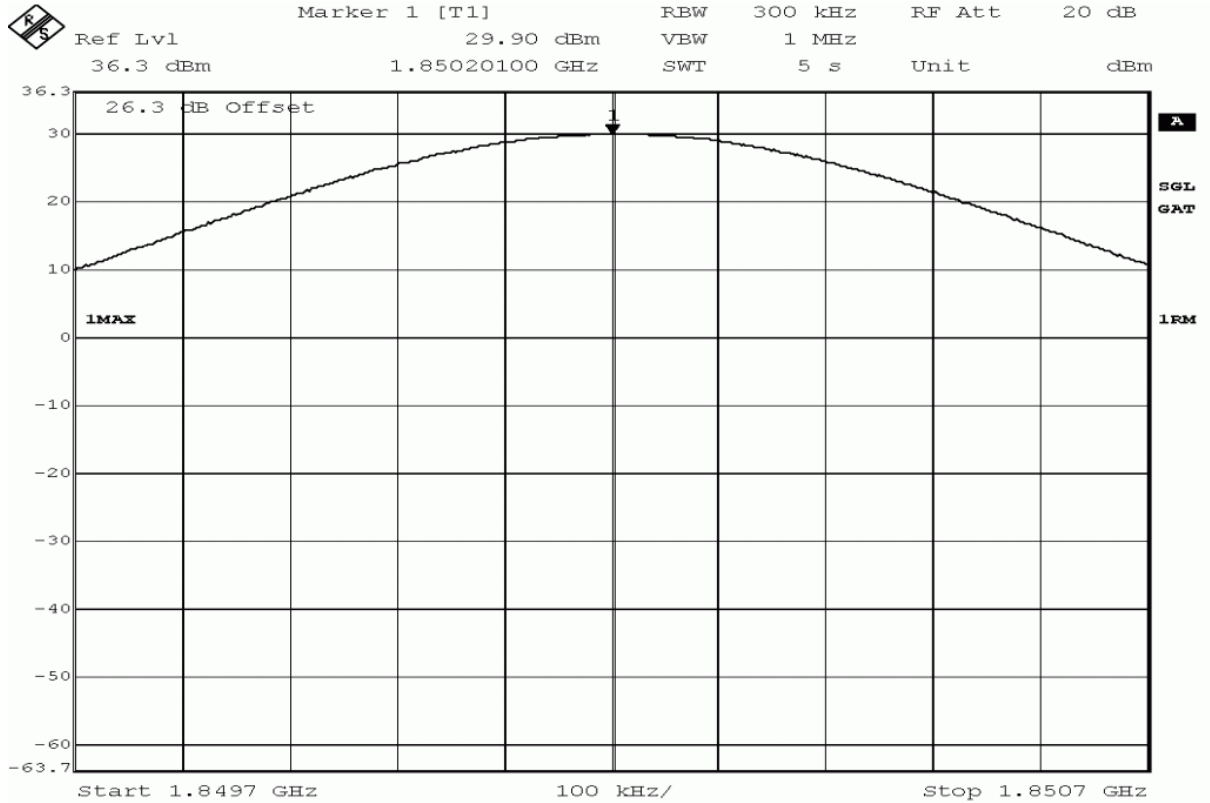

Title: output power measurement
 Comment A: DE1015001, GSM1900, output power, channel 512 (1850.2MHz)
 Date: 7.MAY.2014 12:15:29

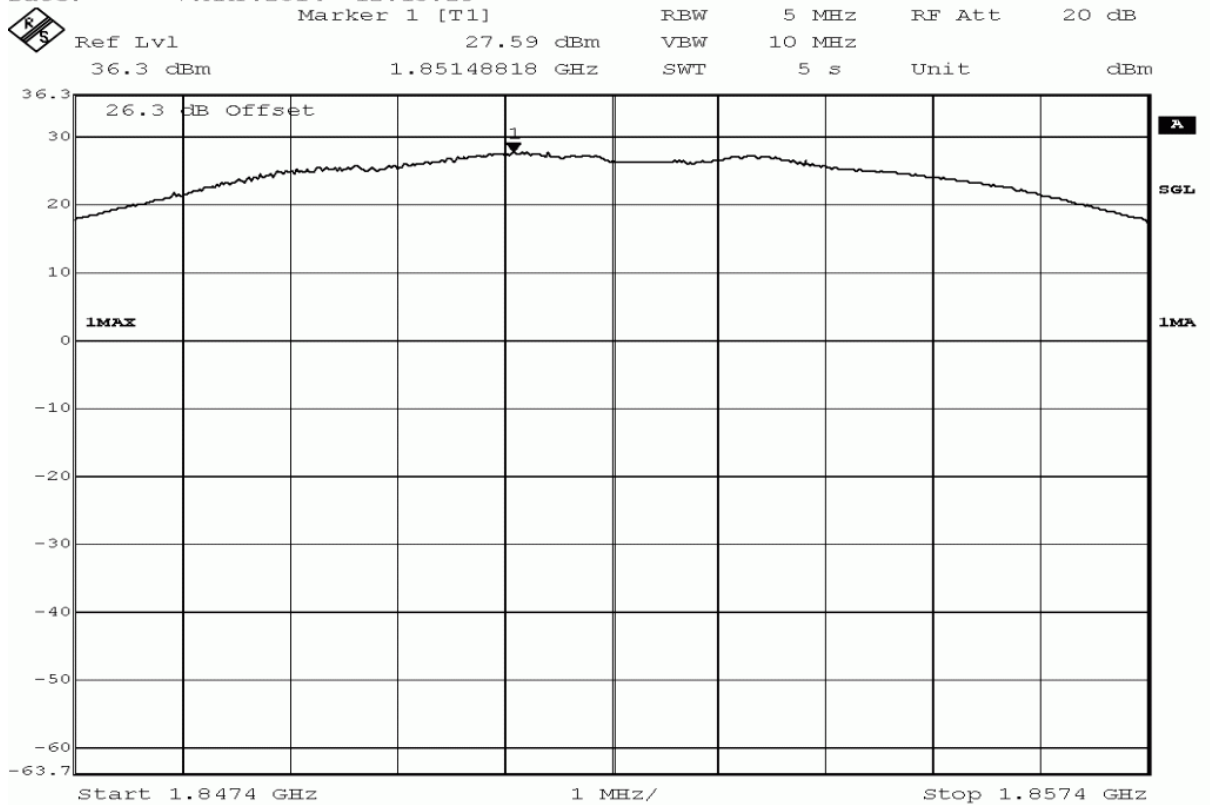

Title: output power measurement
 Comment A: DE1015001, FDD II, output power, channel 9262 (1852.4MHz)
 Date: 6.MAY.2014 23:53:45

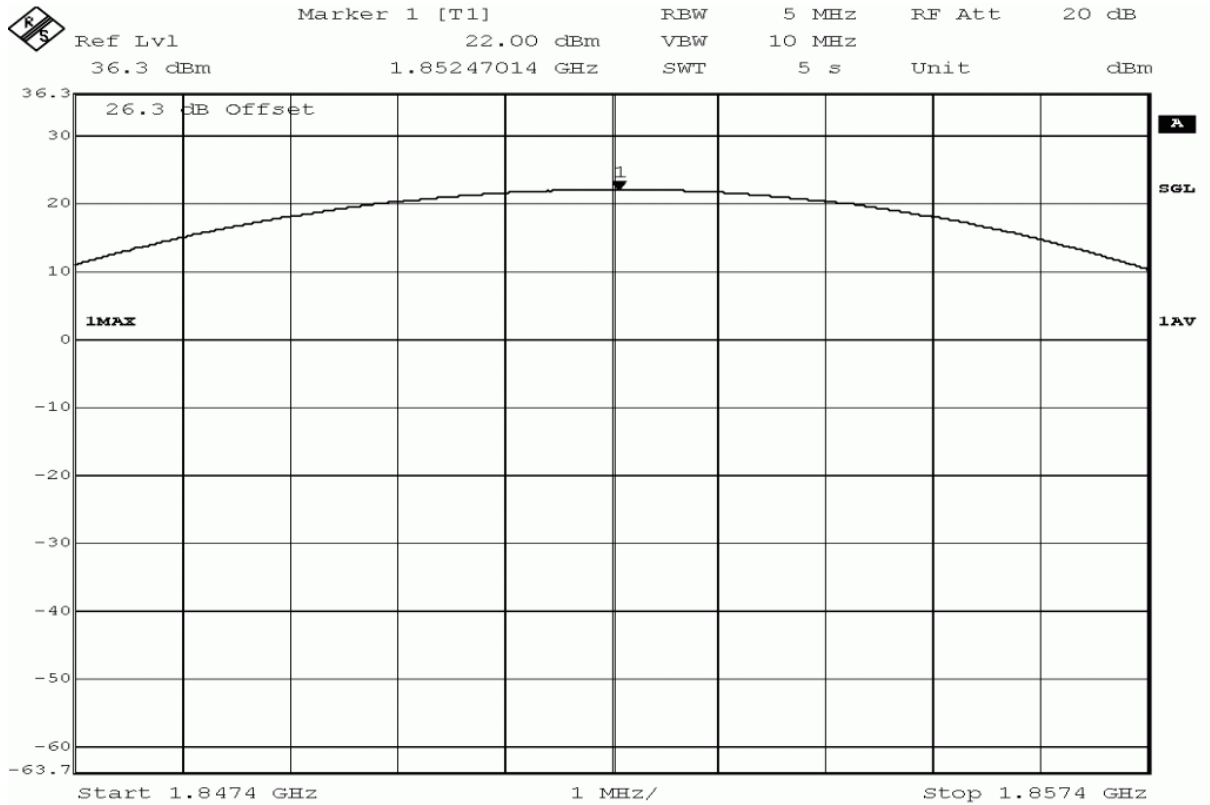

Title: output power measurement
 Comment A: DE1015001, FDD II, output power,
 channel 9262 (1852.4MHz)

Date: 6.MAY.2014 23:54:02

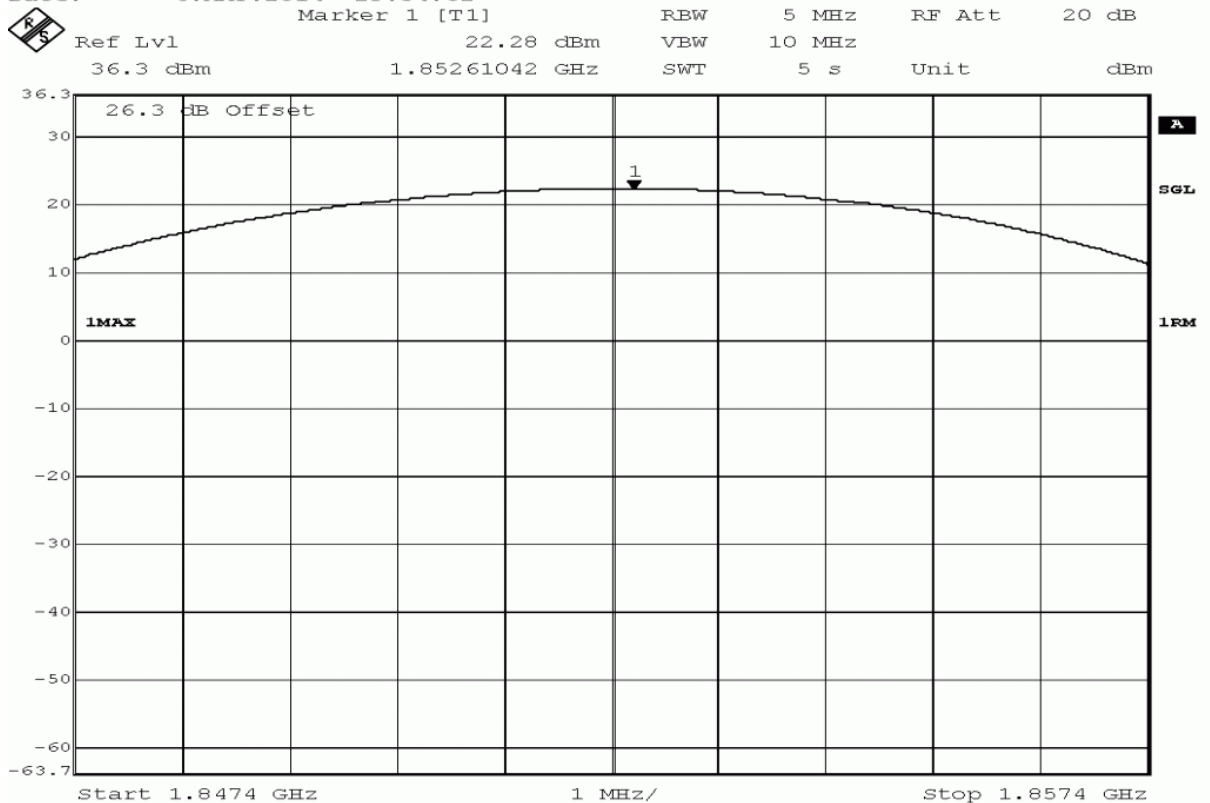

Title: output power measurement
 Comment A: DE1015001, FDD II, output power,
 channel 9262 (1852.4MHz)

Date: 6.MAY.2014 23:54:19

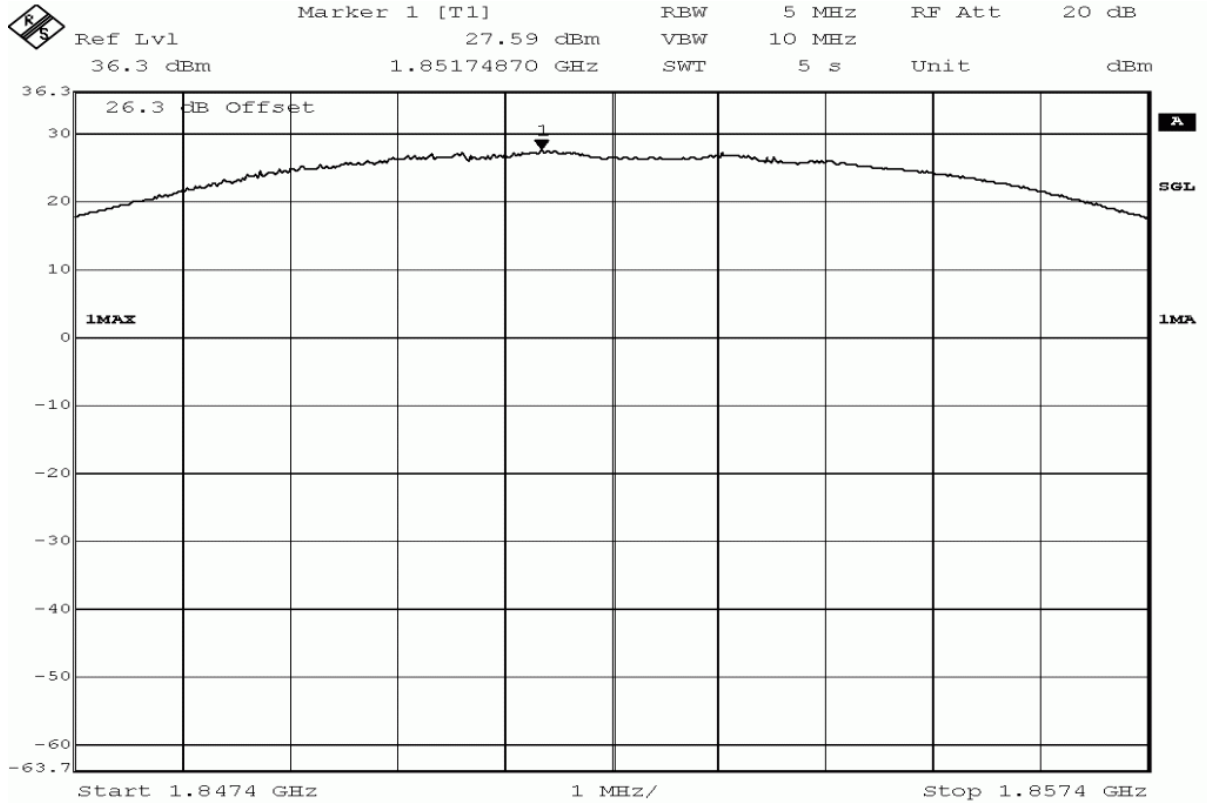

Title: output power measurement
 Comment A: DE1015001, subtest 1 HSDPA FDD II, output power, channel 9262 (1852.4MHz)
 Date: 6.MAY.2014 21:23:57

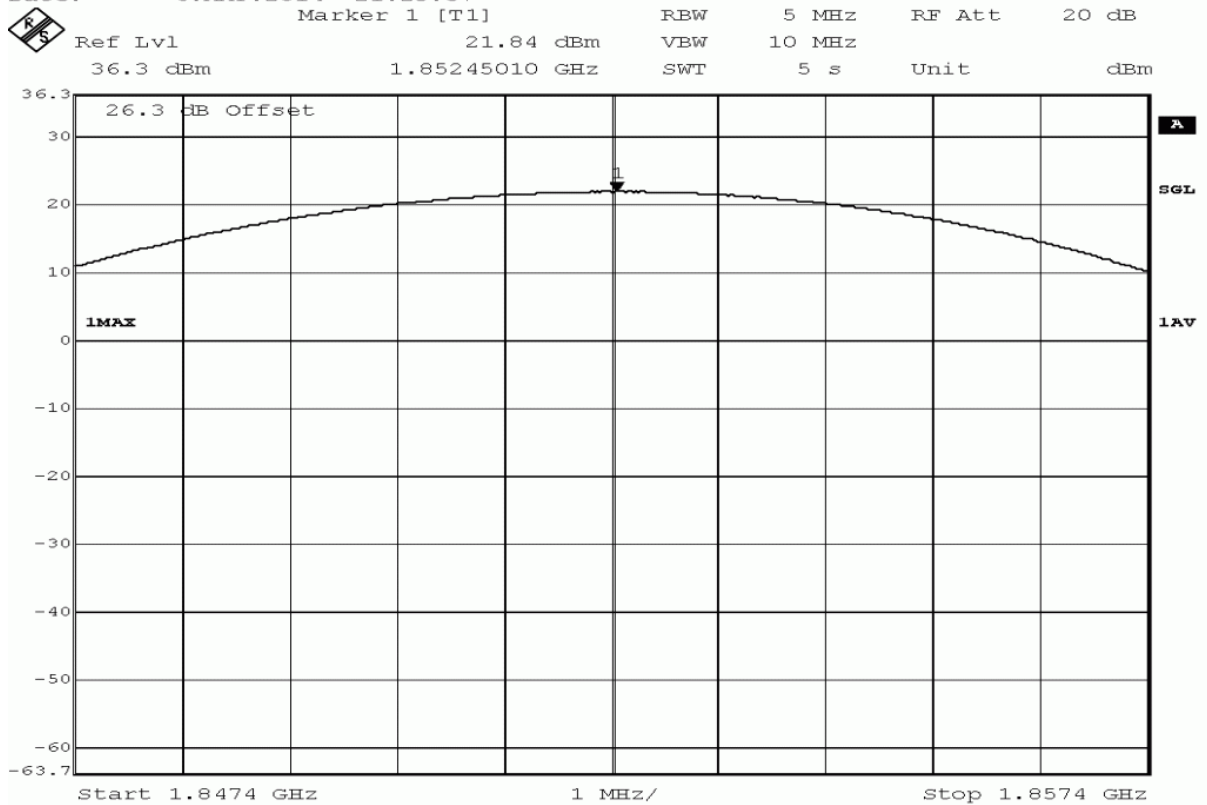

Title: output power measurement
 Comment A: DE1015001, subtest 1 HSDPA FDD II, output power, channel 9262 (1852.4MHz)
 Date: 6.MAY.2014 21:24:14

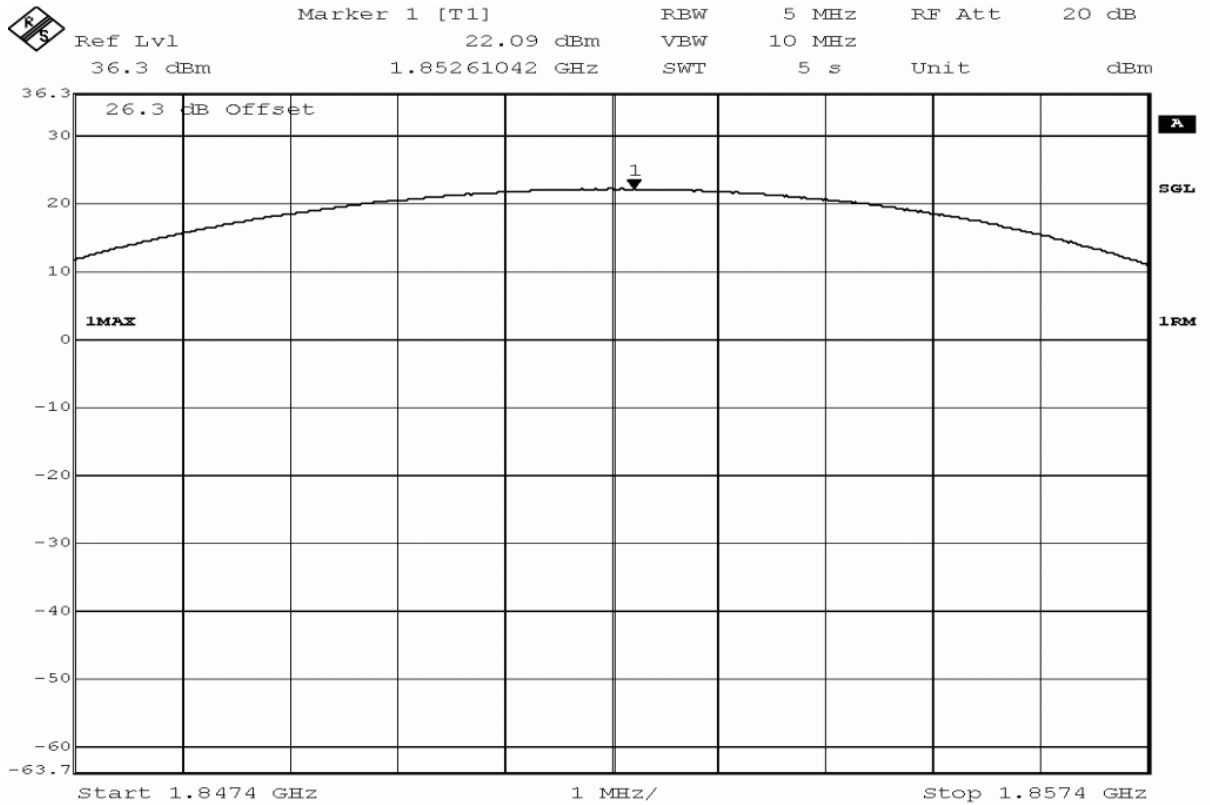

Title: output power measurement
 Comment A: DE1015001, subtest 1 HSDPA FDD II, output power,
 channel 9262 (1852.4MHz)
 Date: 6.MAY.2014 21:24:31

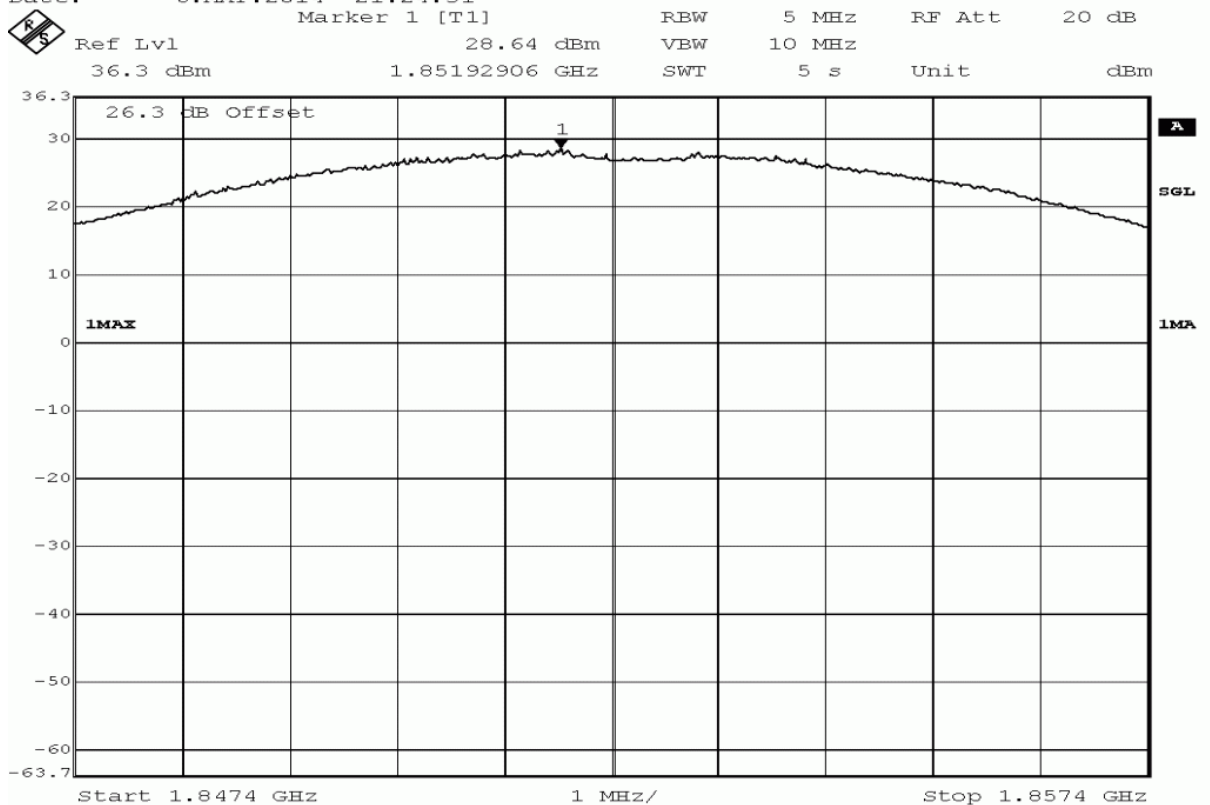

Title: output power measurement
 Comment A: DE1015001, subtest 1 HSUPA FDD II, output power,
 channel 9262 (1852.4MHz)
 Date: 6.MAY.2014 19:48:13

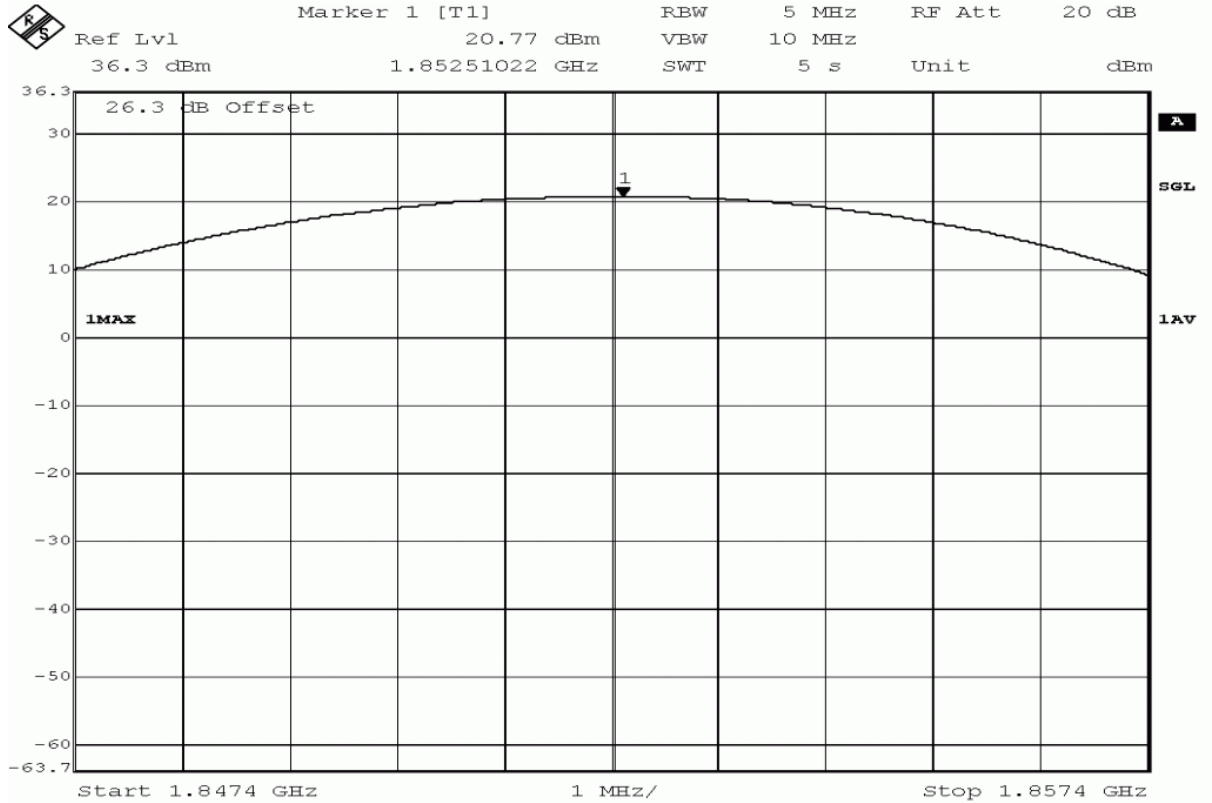

Title: output power measurement
 Comment A: DE1015001, subtest 1 HSUPA FDD II, output power, channel 9262 (1852.4MHz)
 Date: 6.MAY.2014 19:48:30

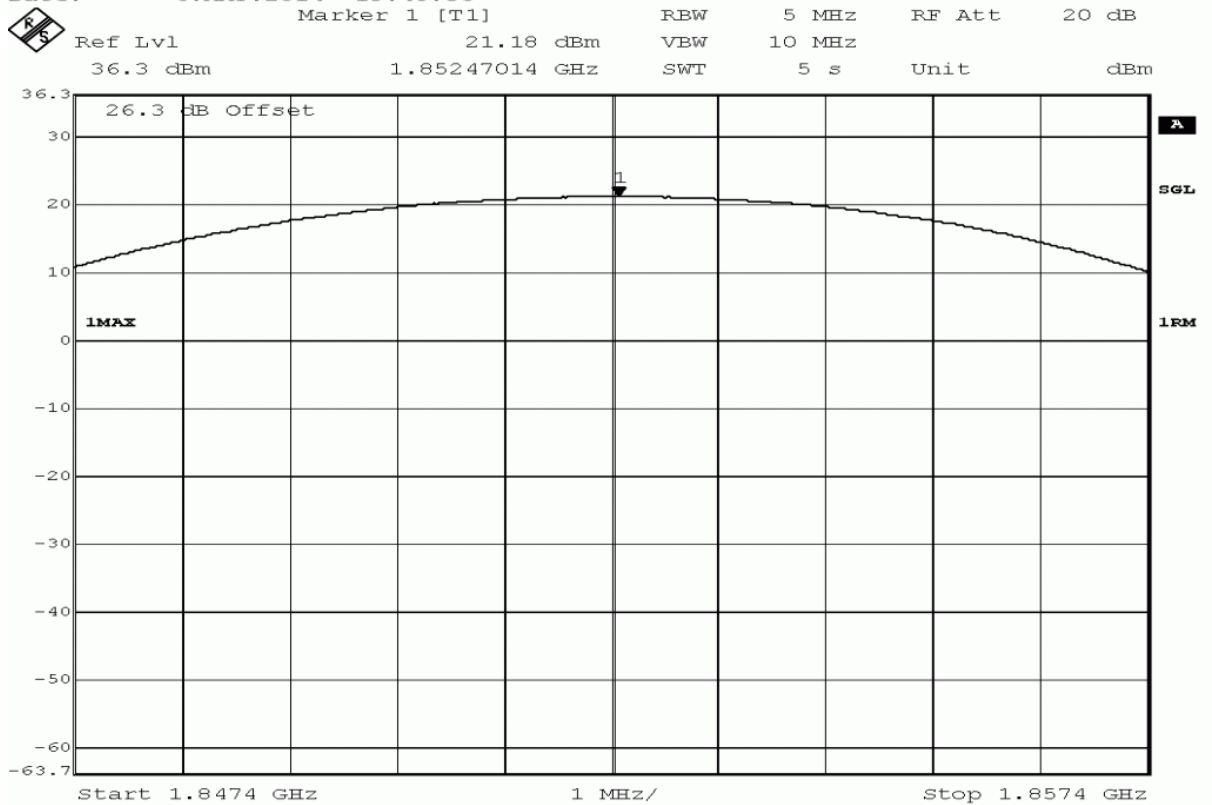

Title: output power measurement
 Comment A: DE1015001, subtest 1 HSUPA FDD II, output power, channel 9262 (1852.4MHz)
 Date: 6.MAY.2014 19:48:47

3.5.8 24.2 Frequency stability §2.1055, §24.235

Test: 24.2; Frequency Band = 1900 / FDD2

<i>Result:</i>	Passed
<i>Setup No.:</i>	S_AH02
<i>Date of Test:</i>	2014/04/30 9:15
<i>Body:</i>	FCC47CFRChIPART24PERSONAL COMMUNICATIONS SERVICES
<i>Test Specification:</i>	FCC part 2 and 24

Detailed Results:

GSM 1900 Freq Stability

Temp. °C	Duration min	Voltage	Limit Hz	Freq. error Average (Hz)	Freq. error Max. (Hz)	Verdict
-30	0	normal	4700	20	38	passed
-30	5			9	22	passed
-30	10			8	29	passed
-20	0	normal	4700	13	30	passed
-20	5			4	25	passed
-20	10			6	27	passed
-10	0	normal	4700	13	23	passed
-10	5			7	16	passed
-10	10			6	26	passed
0	0	normal	4700	5	21	passed
0	5			5	23	passed
0	10			6	28	passed
10	0	normal	4700	4	20	passed
10	5			4	22	passed
10	10			11	27	passed
20	0	low	4700	8	23	passed
20	5			10	15	passed
20	10			11	23	passed
20	0	normal = high ¹⁾	4700	11	28	passed
20	5			13	23	passed
20	10			5	13	passed
20	0	high	4700	1	20	passed
20	5			9	16	passed
20	10			17	83	passed
30	0	normal	4700	3	-23	passed
30	5			12	19	passed
30	10			11	23	passed
40	0	normal	4700	5	24	passed
40	5			5	25	passed
40	10			9	24	passed
50	0	normal	4700	6	28	passed
50	5			14	23	passed
50	10			-1	29	passed

Battery operating end point voltage ²⁾						
Temp. °C	Duration min	Voltage V	Limit Hz	Freq. error Average (Hz)	Freq. error Max. (Hz)	Verdict
20	0	3.2	4700	-2	26	passed
20	5			11	28	passed
20	10			11	21	passed

1) The manufacturer declared that normal voltage is equivalent with high voltage.

2) The call is established at high voltage and the voltage is then reduced to the battery operating end.

WCDMA FDD2 Freq Stability

Temp. °C	Duration min	Voltage	Limit Hz	Freq. error Average (Hz)	Freq. error Max. (Hz)	Verdict
-30	0	normal	4700	36	78	passed
-30	5			2	56	passed
-30	10			4	56	passed
-20	0	normal	4700	31	72	passed
-20	5			-35	-54	passed
-20	10			-18	-54	passed
-10	0	normal	4700	-16	-64	passed
-10	5			-23	-67	passed
-10	10			16	-67	passed
0	0	normal	4700	-44	-109	passed
0	5			-51	-109	passed
0	10			-13	-109	passed
10	0	normal	4700	-40	-107	passed
10	5			-27	-107	passed
10	10			21	-107	passed
20	0	low	4700	-23	-53	passed
20	5			-38	-42	passed
20	10			-25	-35	passed
20	0	normal = high ¹⁾	4700	-27	-54	passed
20	5			-32	-51	passed
20	10			-29	-33	passed
20	0	high	4700	-33	-60	passed
20	5			-29	-52	passed
20	10			1	5	passed
30	0	normal	4700	-34	-44	passed
30	5			-29	-32	passed
30	10			-32	-48	passed
40	0	normal	4700	-24	-84	passed
40	5			21	52	passed
40	10			11	-79	passed
50	0	normal	4700	-32	-64	passed
50	5			9	-64	passed
50	10			2	-64	passed

Battery operating end point voltage ²⁾						
Temp. °C	Duration min	Voltage V	Limit Hz	Freq. error Average (Hz)	Freq. error Max. (Hz)	Verdict
20	0	3.2	4700	-15	-55	passed
20	5			-15	-21	passed
20	10			-32	-36	passed

- 1) The manufacturer declared that normal voltage is equivalent with high voltage.
- 2) The call is established at high voltage and the voltage is then reduced to the battery operating end.

3.5.9 24.3 Spurious emissions at antenna terminals §2.1051, §24.238

Test: 24.3; Frequency Band = 1900, Mode = GSM, Channel = 512, Frequency = 1850.2MHz

Result: Passed
 Setup No.: S_AH02
 Date of Test: 2014/05/07 12:01
 Body: FCC47CFRChIPART24PERSONAL COMMUNICATIONS SERVICES
 Test Specification: FCC part 2 and 24

Detailed Results:

detector	trace	resolution bandwidth /kHz	frequency /MHz	peak value /dBm	margin to limit /dB	limit /dBm	verdict
peak	maxhold	1000	1769.3	-30.9	17.9	-13.0	passed
peak	maxhold	100	1846.19	-28.8	15.8	-13.0	passed
peak	maxhold	3	1849.9198	-29.6	16.6	-13.0	passed
peak	maxhold	3	1849.9359	-24.8	11.8	-13.0	passed
peak	maxhold	3	1849.9699	-19.5	6.5	-13.0	passed
peak	maxhold	3	1849.9820	-19.6	6.6	-13.0	passed
peak	maxhold	3	1849.9980	-16.2	3.2	-13.0	passed
peak	maxhold	1000	1912.1	-32.3	19.3	-13.0	passed
peak	maxhold	1000	4248.5	-29.8	16.8	-13.0	passed
peak	maxhold	1000	6973.9	-25.7	12.7	-13.0	passed
peak	maxhold	1000	14569.1	-26.7	13.7	-13.0	passed
peak	maxhold	1000	18917.8	-23.7	10.7	-13.0	passed

no further values have been found with a margin of less than 20 dB

Test: 24.3; Frequency Band = 1900, Mode = GSM, Channel = 661, Frequency = 1880.0MHz

Result: Passed
 Setup No.: S_AH02
 Date of Test: 2014/05/07 12:15
 Body: FCC47CFRChIPART24PERSONAL COMMUNICATIONS SERVICES
 Test Specification: FCC part 2 and 24

Detailed Results:

detector	trace	resolution bandwidth /kHz	frequency /MHz	peak value /dBm	margin to limit /dB	limit /dBm	verdict
peak	maxhold	1	0.0095	-32.8	19.8	-13.0	passed
peak	maxhold	1	0.0113	-32.4	19.4	-13.0	passed
peak	maxhold	1	0.0142	-32.8	19.8	-13.0	passed
peak	maxhold	1000	1643.1	-31.0	18.0	-13.0	passed
peak	maxhold	1000	1913.0	-32.5	19.5	-13.0	passed
peak	maxhold	1000	3184.4	-30.1	17.1	-13.0	passed
peak	maxhold	1000	6984.0	-25.5	12.5	-13.0	passed
peak	maxhold	1000	14779.6	-26.6	13.6	-13.0	passed
peak	maxhold	1000	18937.9	-23.4	10.4	-13.0	passed

no further values have been found with a margin of less than 20 dB

Test: 24.3; Frequency Band = 1900, Mode = GSM, Channel = 810, Frequency = 1909.8MHz

Result: Passed
 Setup No.: S_AH02
 Date of Test: 2014/05/07 12:23
 Body: FCC47CFRChIPART24PERSONAL COMMUNICATIONS SERVICES
 Test Specification: FCC part 2 and 24

Detailed Results:

detector	trace	resolution bandwidth /kHz	frequency /MHz	peak value /dBm	margin to limit /dB	limit /dBm	verdict
peak	maxhold	1000	1636.3	-31.6	18.6	-13.0	passed
peak	maxhold	3	1910.0000	-20.6	7.6	-13.0	passed
peak	maxhold	3	1910.0060	-20.3	7.3	-13.0	passed
peak	maxhold	3	1910.0160	-16.4	3.4	-13.0	passed
peak	maxhold	3	1910.0361	-18.5	5.5	-13.0	passed
peak	maxhold	3	1910.0721	-24.7	11.7	-13.0	passed
peak	maxhold	100	1911.02	-27.8	14.8	-13.0	passed
peak	maxhold	1000	1942.4	-32.2	19.2	-13.0	passed
peak	maxhold	1000	4230.5	-30.5	17.5	-13.0	passed
peak	maxhold	1000	6994.0	-25.0	12.0	-13.0	passed
peak	maxhold	1000	10631.3	-27.0	14.0	-13.0	passed
peak	maxhold	1000	18927.9	-24.0	11.0	-13.0	passed

no further values have been found with a margin of less than 20 dB

Test: 24.3; Frequency Band = FDD2, Mode = HSDPA, Channel = 9262, Frequency = 1852.4MHz

Result: Passed
 Setup No.: S_AH02
 Date of Test: 2014/05/07 16:35
 Body: FCC47CFRChIPART24PERSONAL COMMUNICATIONS SERVICES
 Test Specification: FCC part 2 and 24

Detailed Results:

detector	trace	resolution bandwidth /kHz	frequency /MHz	peak value /dBm	margin to limit /dB	limit /dBm	verdict
peak	maxhold	1000	1804.6	-31.7	18.7	-13.0	passed
rms	maxhold	100	1848.59	-20.9	7.9	-13.0	passed
rms	maxhold	50	1849.84	-30.6	17.6	-13.0	passed
peak	maxhold	1000	1934.0	-19.4	6.4	-13.0	passed
peak	maxhold	1000	4128.3	-30.0	17.0	-13.0	passed
peak	maxhold	1000	6994.0	-26.0	13.0	-13.0	passed
peak	maxhold	1000	14799.6	-28.0	15.0	-13.0	passed
peak	maxhold	1000	18907.8	-24.7	11.7	-13.0	passed

no further values have been found with a margin of less than 20 dB

Test: 24.3; Frequency Band = FDD2, Mode = HSDPA, Channel = 9400, Frequency = 1880MHz

Result: Passed
 Setup No.: S_AH02
 Date of Test: 2014/05/07 16:38
 Body: FCC47CFRChIPART24PERSONAL COMMUNICATIONS SERVICES
 Test Specification: FCC part 2 and 24

Detailed Results:

detector	trace	resolution bandwidth /kHz	frequency /MHz	peak value /dBm	margin to limit /dB	limit /dBm	verdict
peak	maxhold	1	0.0099	-31.3	18.3	-13.0	passed
peak	maxhold	1000	1757.1	-31.7	18.7	-13.0	passed
peak	maxhold	1000	1960.0	-18.2	5.2	-13.0	passed
peak	maxhold	1000	4122.2	-29.7	16.7	-13.0	passed
peak	maxhold	1000	6984.0	-25.7	12.7	-13.0	passed
peak	maxhold	1000	14769.5	-27.6	14.6	-13.0	passed
peak	maxhold	1000	18927.9	-24.6	11.6	-13.0	passed

no further values have been found with a margin of less than 20 dB

Test: 24.3; Frequency Band = FDD2, Mode = HSDPA, Channel = 9538, Frequency = 1907.6MHz

Result: Passed
 Setup No.: S_AH02
 Date of Test: 2014/05/07 16:40
 Body: FCC47CFRChIPART24PERSONAL COMMUNICATIONS SERVICES
 Test Specification: FCC part 2 and 24

Detailed Results:

detector	trace	resolution bandwidth /kHz	frequency /MHz	peak value /dBm	margin to limit /dB	limit /dBm	verdict
peak	maxhold	1	0.0097	-32.8	19.8	-13.0	passed
peak	maxhold	1	0.0247	-32.9	19.9	-13.0	passed
peak	maxhold	1000	1668.7	-31.6	18.6	-13.0	passed
rms	maxhold	50	1910.10	-29.8	16.8	-13.0	passed
rms	maxhold	100	1911.34	-22.0	9.0	-13.0	passed
peak	maxhold	1000	1988.3	-18.4	5.4	-13.0	passed
peak	maxhold	1000	4464.9	-30.9	17.9	-13.0	passed
peak	maxhold	1000	6573.1	-26.0	13.0	-13.0	passed
peak	maxhold	1000	14198.4	-27.1	14.1	-13.0	passed
peak	maxhold	1000	18887.8	-23.6	10.6	-13.0	passed

no further values have been found with a margin of less than 20 dB

Test: 24.3; Frequency Band = FDD2, Mode = HSUPA, Channel = 9262, Frequency = 1852.4MHz

Result: Passed
 Setup No.: S_AH02
 Date of Test: 2014/05/07 16:46
 Body: FCC47CFRChIPART24PERSONAL COMMUNICATIONS SERVICES
 Test Specification: FCC part 2 and 24

Detailed Results:

detector	trace	resolution bandwidth /kHz	frequency /MHz	peak value /dBm	margin to limit /dB	limit /dBm	verdict
peak	maxhold	1	0.0098	-31.5	18.5	-13.0	passed
peak	maxhold	1000	1641.4	-32.1	19.1	-13.0	passed
rms	maxhold	100	1848.62	-22.3	9.3	-13.0	passed
rms	maxhold	50	1849.83	-32.0	19.0	-13.0	passed
peak	maxhold	1000	1929.7	-31.9	18.9	-13.0	passed
peak	maxhold	1000	2420.8	-30.8	17.8	-13.0	passed
peak	maxhold	1000	6994.0	-26.2	13.2	-13.0	passed
peak	maxhold	1000	14529.1	-27.1	14.1	-13.0	passed
peak	maxhold	1000	18917.8	-23.6	10.6	-13.0	passed

no further values have been found with a margin of less than 20 dB

Test: 24.3; Frequency Band = FDD2, Mode = HSUPA, Channel = 9400, Frequency = 1880MHz

Result: Passed
 Setup No.: S_AH02
 Date of Test: 2014/05/07 16:49
 Body: FCC47CFRChIPART24PERSONAL COMMUNICATIONS SERVICES
 Test Specification: FCC part 2 and 24

Detailed Results:

detector	trace	resolution bandwidth /kHz	frequency /MHz	peak value /dBm	margin to limit /dB	limit /dBm	verdict
peak	maxhold	1	0.0106	-32.3	19.3	-13.0	passed
peak	maxhold	3	0.0333	-32.6	19.6	-13.0	passed
peak	maxhold	1000	1626.1	-31.5	18.5	-13.0	passed
peak	maxhold	1000	1962.0	-32.6	19.6	-13.0	passed
peak	maxhold	1000	4969.9	-30.8	17.8	-13.0	passed
peak	maxhold	1000	6984.0	-26.6	13.6	-13.0	passed
peak	maxhold	1000	14499.0	-27.5	14.5	-13.0	passed
peak	maxhold	1000	19048.1	-24.3	11.3	-13.0	passed

no further values have been found with a margin of less than 20 dB

Test: 24.3; Frequency Band = FDD2, Mode = HSUPA, Channel = 9538, Frequency = 1907.6MHz

Result: Passed
 Setup No.: S_AH02
 Date of Test: 2014/05/07 16:55
 Body: FCC47CFRChIPART24PERSONAL COMMUNICATIONS SERVICES
 Test Specification: FCC part 2 and 24

Detailed Results:

detector	trace	resolution bandwidth /kHz	frequency /MHz	peak value /dBm	margin to limit /dB	limit /dBm	verdict
peak	maxhold	1	0.0095	-32.7	19.7	-13.0	passed
peak	maxhold	1	0.0106	-30.5	17.5	-13.0	passed
peak	maxhold	1000	1757.1	-31.7	18.7	-13.0	passed
rms	maxhold	50	1910.09	-30.6	17.6	-13.0	passed
rms	maxhold	100	1911.14	-21.6	8.6	-13.0	passed
peak	maxhold	1000	1972.7	-32.4	19.4	-13.0	passed
peak	maxhold	1000	3887.8	-30.8	17.8	-13.0	passed
peak	maxhold	1000	6984.0	-25.8	12.8	-13.0	passed
peak	maxhold	1000	14959.9	-27.2	14.2	-13.0	passed
peak	maxhold	1000	18917.8	-25.4	12.4	-13.0	passed

no further values have been found with a margin of less than 20 dB

Test: 24.3; Frequency Band = FDD2, Mode = W-CDMA, Channel = 9262, Frequency = 1852.4MHz

Result: Passed
 Setup No.: S_AH02
 Date of Test: 2014/05/07 17:02
 Body: FCC47CFRChIPART24PERSONAL COMMUNICATIONS SERVICES
 Test Specification: FCC part 2 and 24

Detailed Results:

detector	trace	resolution bandwidth /kHz	frequency /MHz	peak value /dBm	margin to limit /dB	limit /dBm	verdict
peak	maxhold	1000	1513.4	-31.4	18.4	-13.0	passed
rms	maxhold	100	1848.64	-22.7	9.7	-13.0	passed
rms	maxhold	50	1849.85	-31.6	18.6	-13.0	passed
peak	maxhold	1000	1988.1	-32.0	19.0	-13.0	passed
peak	maxhold	1000	4501.0	-30.6	17.6	-13.0	passed
peak	maxhold	1000	6984.0	-26.0	13.0	-13.0	passed
peak	maxhold	1000	14909.8	-27.5	14.5	-13.0	passed
peak	maxhold	1000	19008.0	-24.8	11.8	-13.0	passed

no further values have been found with a margin of less than 20 dB

Test: 24.3; Frequency Band = FDD2, Mode = W-CDMA, Channel = 9400, Frequency = 1880MHz

Result: Passed
 Setup No.: S_AH02
 Date of Test: 2014/05/07 17:04
 Body: FCC47CFRChIPART24PERSONAL COMMUNICATIONS SERVICES
 Test Specification: FCC part 2 and 24

Detailed Results:

detector	trace	resolution bandwidth /kHz	frequency /MHz	peak value /dBm	margin to limit /dB	limit /dBm	verdict
peak	maxhold	1	0.0103	-31.3	18.3	-13.0	passed
peak	maxhold	1000	1757.1	-32.2	19.2	-13.0	passed
peak	maxhold	1000	1937.9	-32.9	19.9	-13.0	passed
peak	maxhold	1000	4272.5	-31.2	18.2	-13.0	passed
peak	maxhold	1000	6963.9	-25.8	12.8	-13.0	passed
peak	maxhold	1000	11082.2	-26.8	13.8	-13.0	passed
peak	maxhold	1000	18927.9	-25.0	12.0	-13.0	passed

no further values have been found with a margin of less than 20 dB

Test: 24.3; Frequency Band = FDD2, Mode = W-CDMA, Channel = 9538, Frequency = 1907.6MHz

Result: Passed
 Setup No.: S_AH02
 Date of Test: 2014/05/07 17:06
 Body: FCC47CFRChIPART24PERSONAL COMMUNICATIONS SERVICES
 Test Specification: FCC part 2 and 24

Detailed Results:

detector	trace	resolution bandwidth /kHz	frequency /MHz	peak value /dBm	margin to limit /dB	limit /dBm	verdict
peak	maxhold	1	0.0119	-32.6	19.6	-13.0	passed
peak	maxhold	1000	1707.8	-31.7	18.7	-13.0	passed
rms	maxhold	50	1910.12	-29.8	16.8	-13.0	passed
rms	maxhold	100	1911.40	-21.3	8.3	-13.0	passed
peak	maxhold	1000	1938.4	-32.4	19.4	-13.0	passed
peak	maxhold	1000	4032.1	-30.0	17.0	-13.0	passed
peak	maxhold	1000	6984.0	-26.4	13.4	-13.0	passed
peak	maxhold	1000	14819.6	-27.8	14.8	-13.0	passed
peak	maxhold	1000	18907.8	-24.0	11.0	-13.0	passed

no further values have been found with a margin of less than 20 dB

3.5.10 24.4 Field strength of spurious radiation §2.1053, §24.238

Test: 24.4; Frequency Band = 1900, Mode = GSM, Channel = 661, Frequency = 1880.0MHz

Result: Passed
Setup No.: S_AH02_RSE
Date of Test: 2014/04/26 2:08
Body: FCC47CFRChIPART24PERSONAL COMMUNICATIONS SERVICES
Test Specification: FCC part 2 and 24

Detailed Results:

detector	trace	resolution bandwidth /kHz	frequency /MHz	peak value /dBm	limit /dBm	margin to limit /dB	azimuth /°	antenna polarization	EUT orientation	verdict
peak	maxhold	1000	7925.9	-30.73	-13.00	17.73	-90.0	horizontal	vertical	passed
peak	maxhold	1000	7937.9	-31.16	-13.00	18.16	-180.0	horizontal	horizontal	passed
peak	maxhold	1000	7949.9	-31.35	-13.00	18.35	120.0	vertical	horizontal	passed
peak	maxhold	1000	9344.7	-32.28	-13.00	19.28	0.0	horizontal	vertical	passed
peak	maxhold	1000	19228.5	-17.79	-13.00	4.79	120.0	horizontal	horizontal	passed
peak	maxhold	1000	19312.6	-17.78	-13.00	4.78	-135.0	vertical	vertical	passed
peak	maxhold	1000	19354.7	-18.53	-13.00	5.53	0.0	vertical	vertical	passed

no further values have been found with a margin of less than 20 dB

Test: 24.4; Frequency Band = FDD2, Mode = HSDPA, Channel = 9400, Frequency = 1880MHz

Result: Passed
Setup No.: S_AH02_RSE
Date of Test: 2014/05/02 17:13
Body: FCC47CFRChIPART24PERSONAL COMMUNICATIONS SERVICES
Test Specification: FCC part 2 and 24

Detailed Results:

detector	trace	resolution bandwidth /kHz	frequency /MHz	peak value /dBm	limit /dBm	margin to limit /dB	azimuth /°	antenna polarization	EUT orientation	verdict
peak	maxhold	1000	1958.4	-28.32	-13.00	15.32	0.0	vertical	vertical	passed
peak	maxhold	1000	1960.0	-31.95	-13.00	18.95	120.0	vertical	horizontal	passed
peak	maxhold	1000	7925.9	-31.83	-13.00	18.83	-135.0	horizontal	vertical	passed
peak	maxhold	1000	7937.9	-31.08	-13.00	18.08	120.0	vertical	horizontal	passed
peak	maxhold	1000	7949.9	-32.77	-13.00	19.77	-120.0	horizontal	horizontal	passed
peak	maxhold	1000	19214.4	-19.73	-13.00	6.73	-120.0	horizontal	horizontal	passed
peak	maxhold	1000	19228.5	-19.03	-13.00	6.03	-90.0	vertical	vertical	passed
peak	maxhold	1000	19242.5	-19.26	-13.00	6.26	45.0	horizontal	vertical	passed
peak	maxhold	1000	19312.6	-18.69	-13.00	5.69	-45.0	horizontal	vertical	passed

no further values have been found with a margin of less than 20 dB

Test: 24.4; Frequency Band = FDD2, Mode = HSUPA, Channel = 9400, Frequency = 1880MHz

Result: Passed
Setup No.: S_AH02_RSE
Date of Test: 2014/05/08 20:47
Body: FCC47CFRChIPART24PERSONAL COMMUNICATIONS SERVICES
Test Specification: FCC part 2 and 24

Detailed Results:

detector	trace	resolution bandwidth /kHz	frequency /MHz	peak value /dBm	limit /dBm	margin to limit /dB	azimuth /°	antenna polarization	EUT orientation	verdict
peak	maxhold	1000	7925.9	-31.66	-13.00	18.66	60.0	vertical	horizontal	passed
peak	maxhold	1000	7937.9	-31.00	-13.00	18.00	-180.0	vertical	horizontal	passed
peak	maxhold	1000	7949.9	-32.74	-13.00	19.74	60.0	horizontal	horizontal	passed
peak	maxhold	1000	7961.9	-31.64	-13.00	18.64	45.0	horizontal	vertical	passed
peak	maxhold	1000	19228.5	-18.35	-13.00	5.35	-60.0	vertical	horizontal	passed
peak	maxhold	1000	19256.5	-19.95	-13.00	6.95	-90.0	vertical	vertical	passed
peak	maxhold	1000	19312.6	-17.75	-13.00	4.75	-180.0	vertical	horizontal	passed

no further values have been found with a margin of less than 20 dB

Test: 24.4; Frequency Band = FDD2, Mode = W-CDMA, Channel = 9400, Frequency = 1880MHz

Result: Passed

Setup No.: S_AH02_RSE

Date of Test: 2014/04/25 22:39

Body: FCC47CFRChIPART24PERSONAL COMMUNICATIONS SERVICES

Test Specification: FCC part 2 and 24

Detailed Results:

detector	trace	resolution bandwidth /kHz	frequency /MHz	peak value /dBm	limit /dBm	margin to limit /dB	azimuth /°	antenna polarization	EUT orientation	verdict
peak	maxhold	1000	7901.8	-32.74	-13.00	19.74	90.0	horizontal	vertical	passed
peak	maxhold	1000	7913.8	-32.69	-13.00	19.69	135.0	horizontal	vertical	passed
peak	maxhold	1000	7925.9	-32.05	-13.00	19.05	-135.0	vertical	vertical	passed
peak	maxhold	1000	7937.9	-32.20	-13.00	19.20	0.0	horizontal	horizontal	passed
peak	maxhold	1000	7949.9	-32.69	-13.00	19.69	120.0	vertical	horizontal	passed
peak	maxhold	1000	9344.7	-17.03	-13.00	4.03	-60.0	vertical	horizontal	passed
peak	maxhold	1000	19228.5	-17.84	-13.00	4.84	0.0	horizontal	vertical	passed
peak	maxhold	1000	19312.6	-18.40	-13.00	5.40	-120.0	horizontal	horizontal	passed

no further values have been found with a margin of less than 20 dB

3.5.11 24.5 Emission and Occupied Bandwidth §2.1049, §24.238

Test: 24.5; Frequency Band = 1900 / FDD2

<i>Result:</i>	Passed
<i>Setup No.:</i>	S_AH02
<i>Date of Test:</i>	2014/05/06 10:04
<i>Body:</i>	FCC47CFRChIPART24PERSONAL COMMUNICATIONS SERVICES
<i>Test Specification:</i>	FCC part 2 and 24

Detailed Results:

Band	Mode	Modulation	Channel	Frequency (MHz)	26 dB Bandwidth (KHz)	99% Bandwidth (KHz)	Detector	RBW (KHz)	Verdict
1900	GSM/GPRS	GFSK	Low	1850.2	320.6	248.5	Peak	3	Pass
			Mid	1880	314.6	244.5			Pass
			High	1909.8	320.6	242.5			Pass
FDD 2	W-CDMA	QPSK	Low	1852.4	4649.3	4088.2	Peak	100	Pass
			Mid	1880	4649.3	4068.1			Pass
			High	1907.6	4649.3	4068.1			Pass
FDD 2	HSDPA	QPSK	Low	1852.4	4649.3	4088.2	Peak	100	Pass
			Mid	1880	4649.3	4068.1			Pass
			High	1907.6	4649.3	4068.1			Pass
FDD 2	HSUPA	QPSK	Low	1852.4	4669.3	4088.2	Peak	100	Pass
			Mid	1880	4689.4	4108.2			Pass
			High	1907.6	4649.3	4088.2			Pass

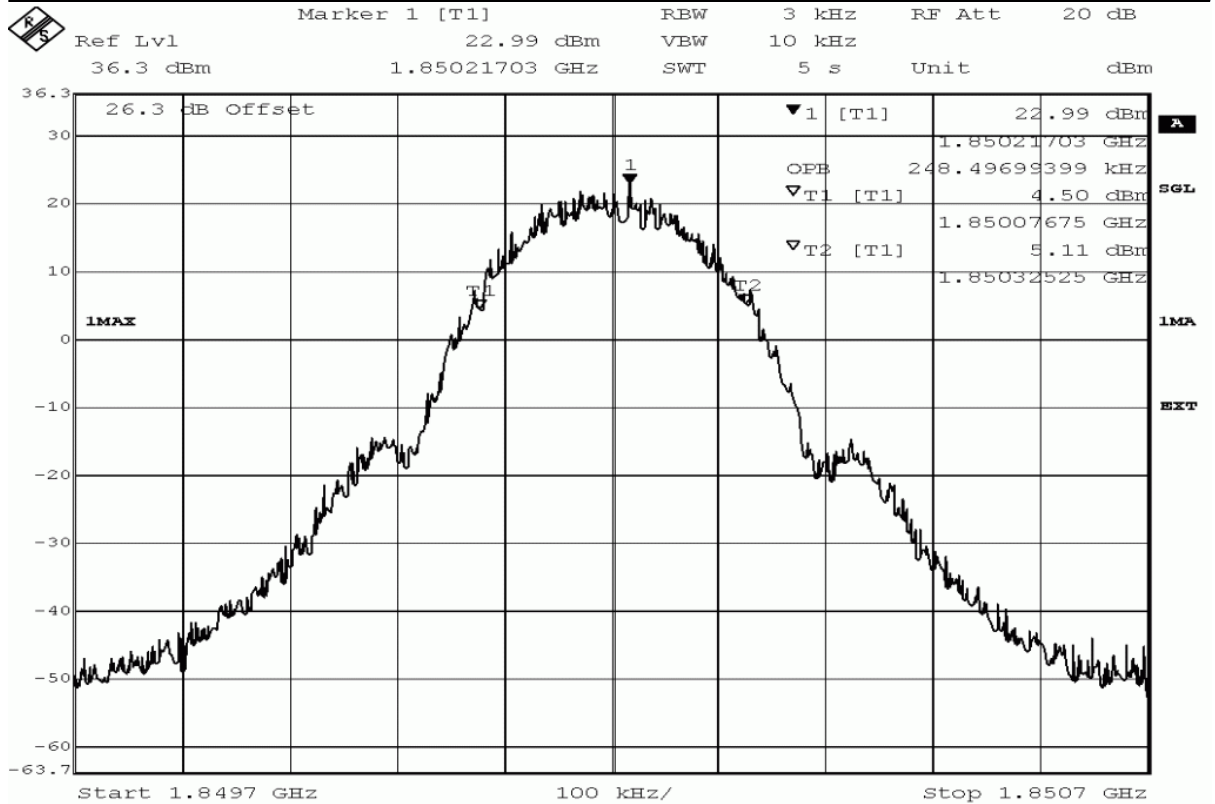

Title: bandwidth measurement
 Comment A: DE1015001, GSM1900, occupied bandwidth (99%), channel 512 (1850.2MHz)
 Date: 7.MAY.2014 12:20:48

GSM 99% Bandwidth Low Channel

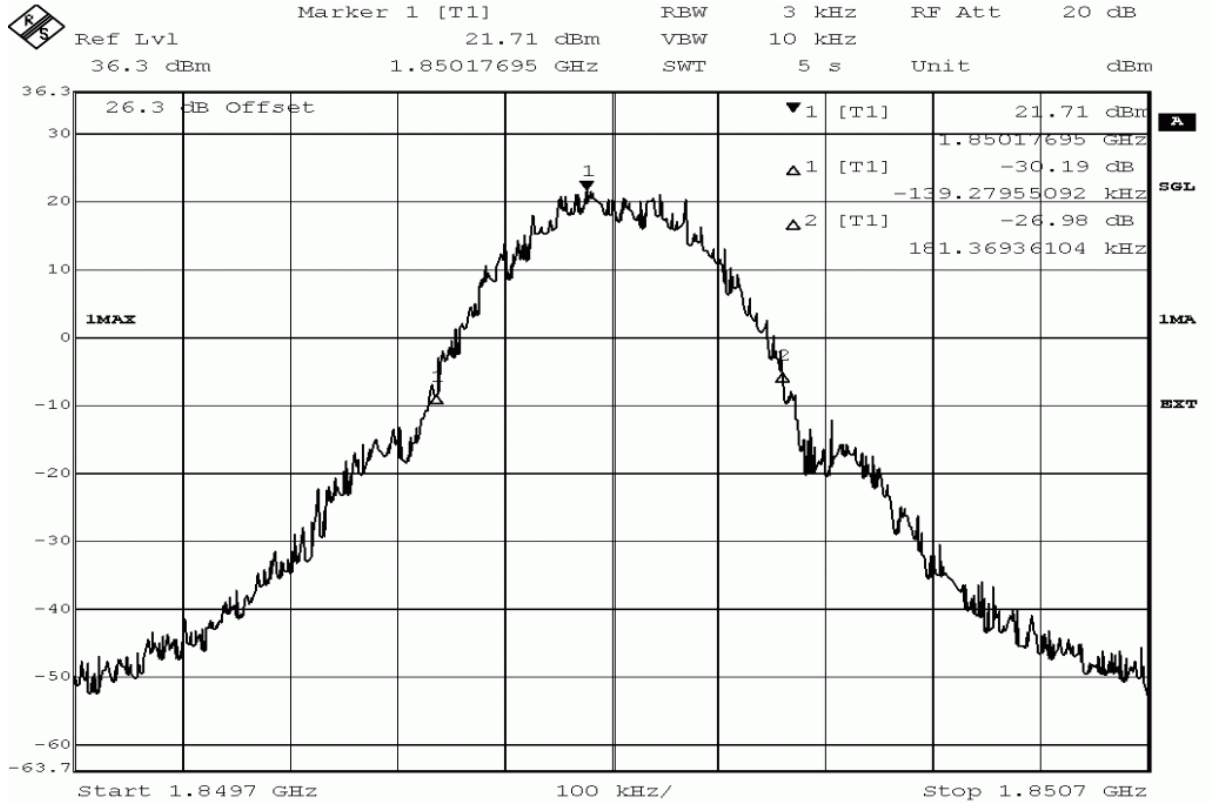

Title: bandwidth measurement
 Comment A: DE1015001, GSM1900, 26dB bandwidth,
 channel 512 (1850.2MHz)
 Date: 7.MAY.2014 12:20:25

GSM 26dB Bandwidth Low Channel

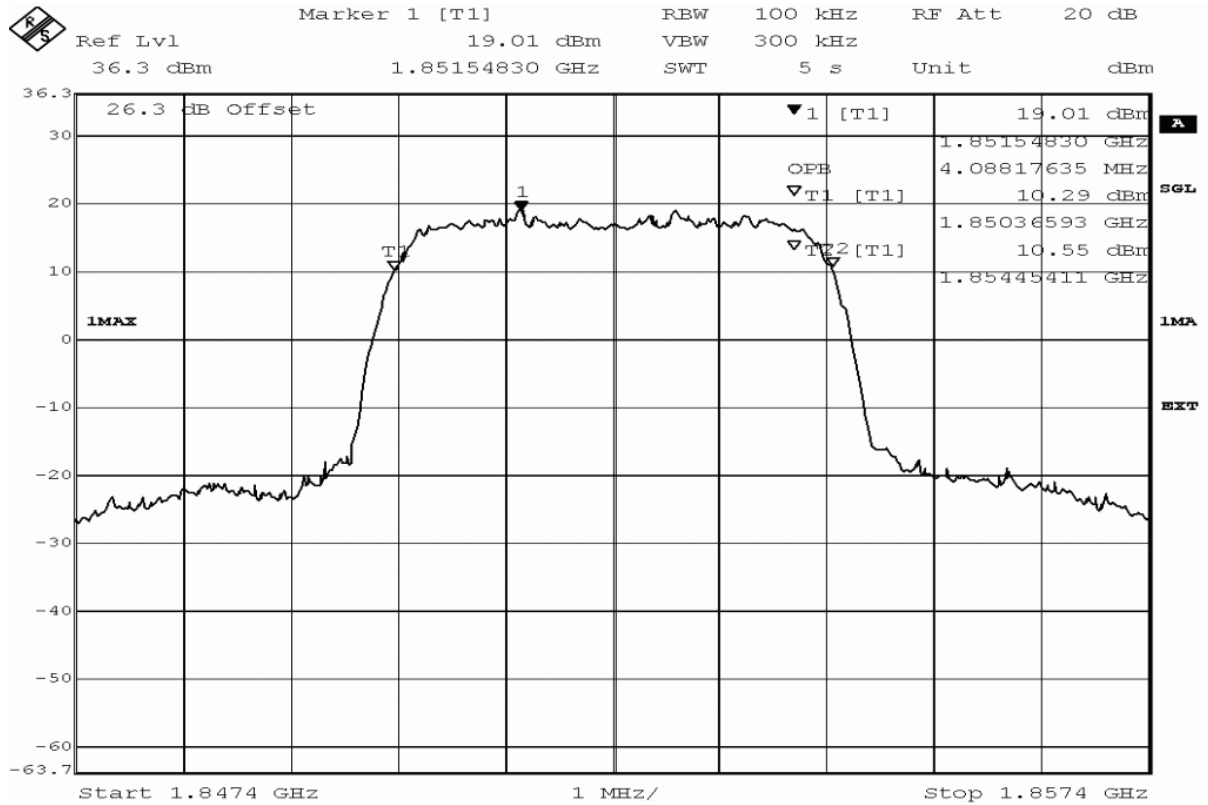

Title: bandwidth measurement
 Comment A: DE1015001, FDD II, occupied bandwidth (99%),
 channel 9262 (1852.4MHz)
 Date: 6.MAY.2014 23:57:42

WCDMA 99% Bandwidth Low Channel

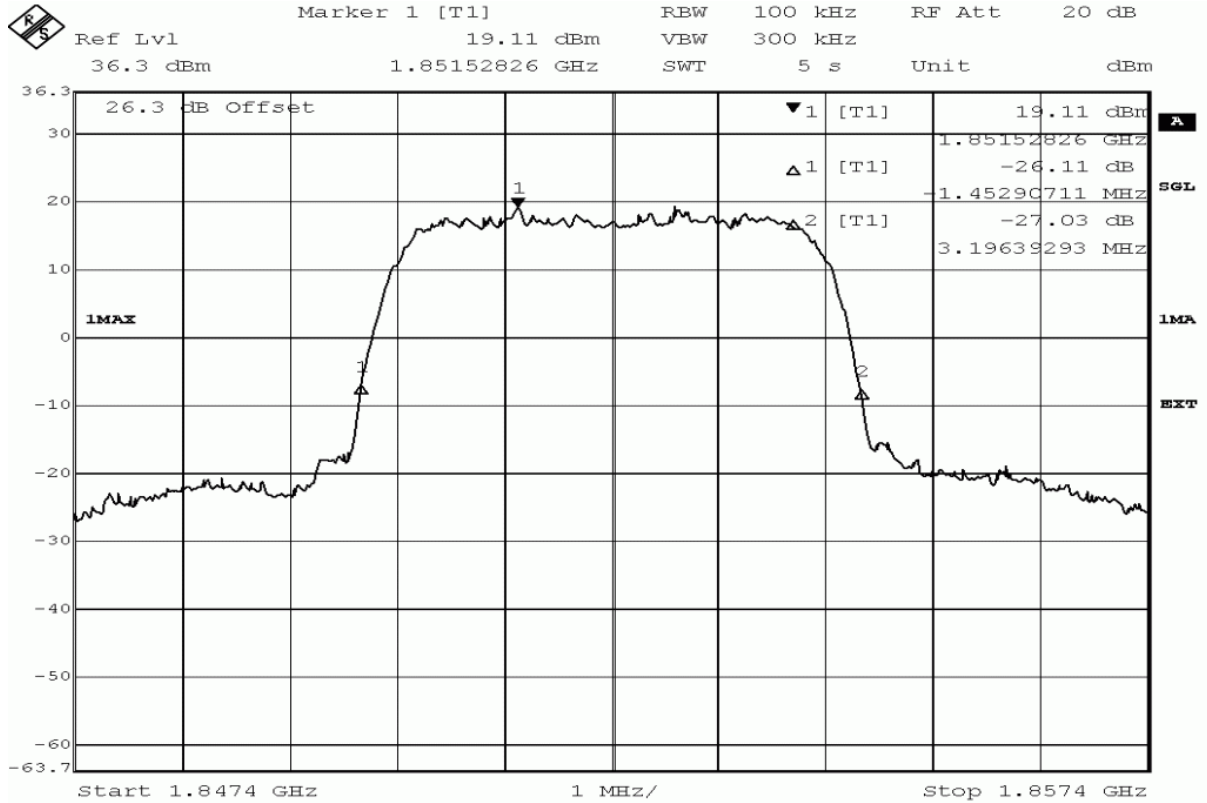

Title: bandwidth measurement
 Comment A: DE1015001, FDD II, 26dB bandwidth,
 channel 9262 (1852.4MHz)
 Date: 6.MAY.2014 23:57:19

WCDMA 26dB Bandwidth Low Channel

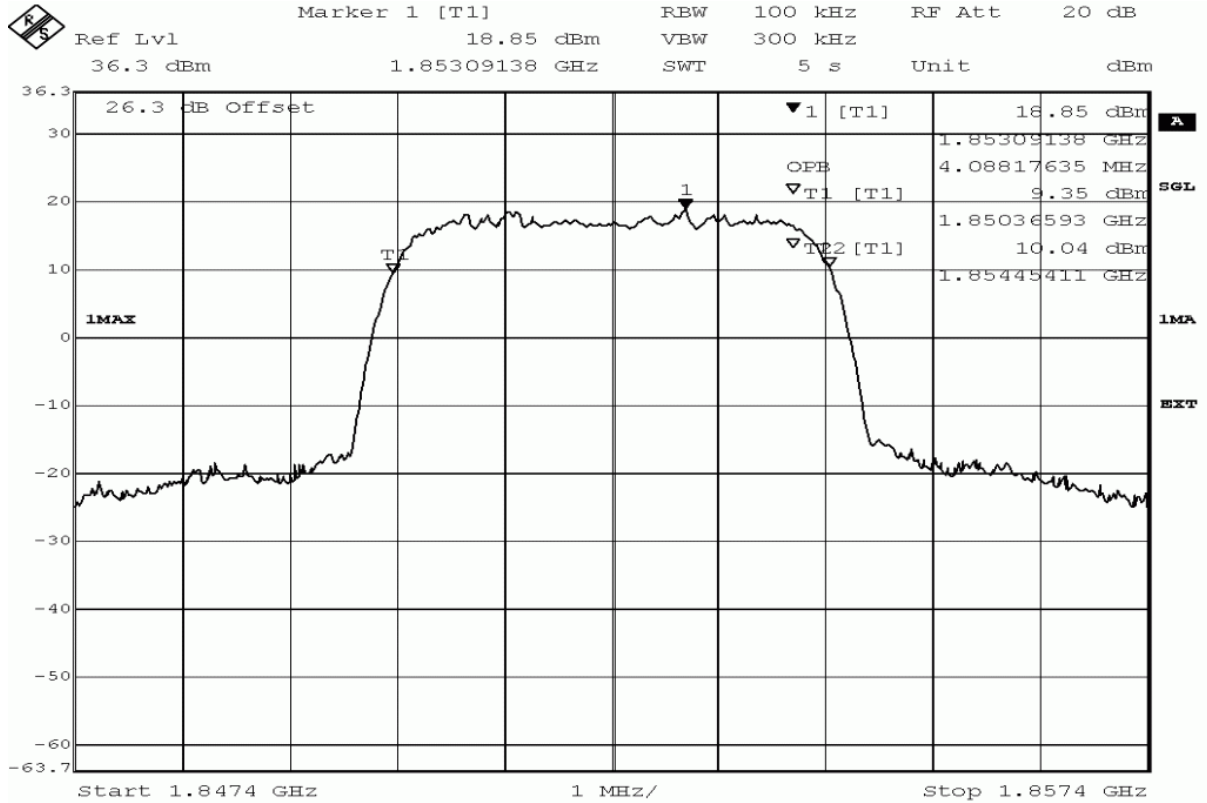

Title: bandwidth measurement
 Comment A: DE1015001, FDD II, occupied bandwidth (99%),
 channel 9262 (1852.4MHz)
 Date: 6.MAY.2014 21:27:54

HSDPA 99% Bandwidth Low Channel

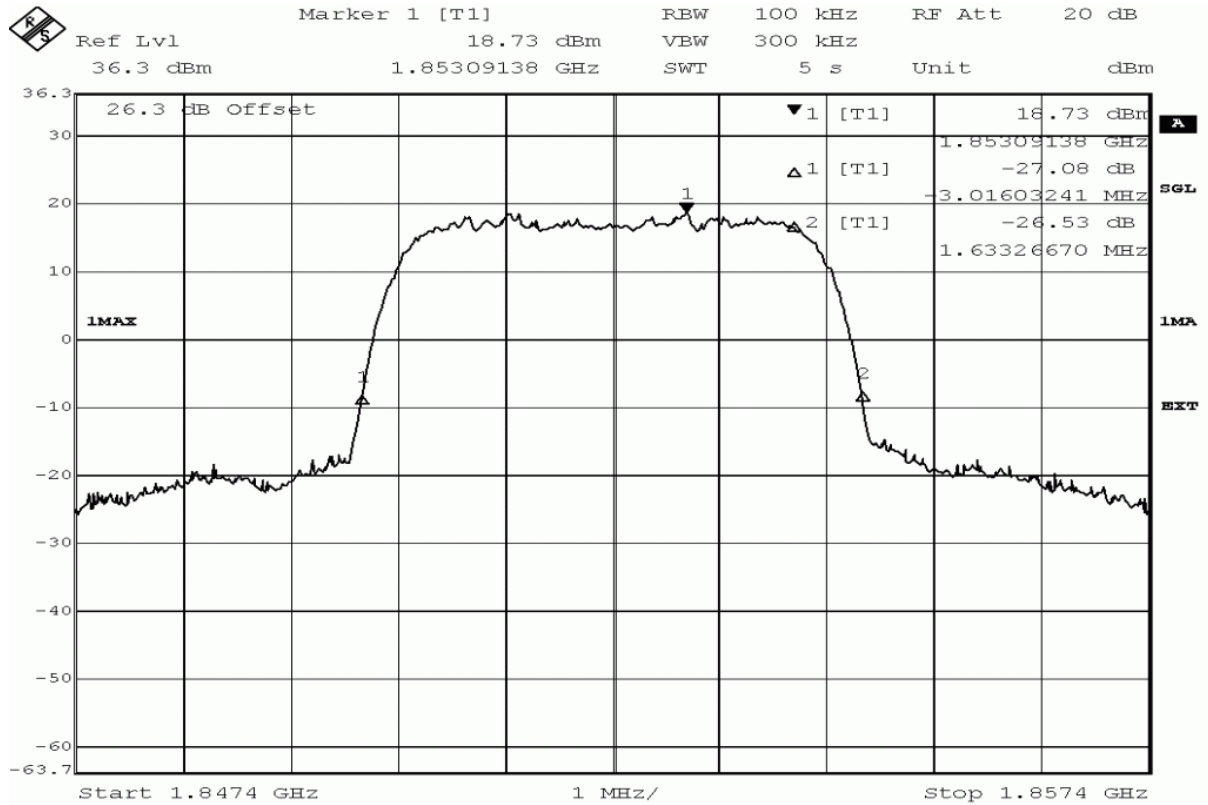

Title: bandwidth measurement
 Comment A: DE1015001, FDD II, 26dB bandwidth,
 channel 9262 (1852.4MHz)
 Date: 6.MAY.2014 21:27:32

HSDPA 26dB Bandwidth Low Channel

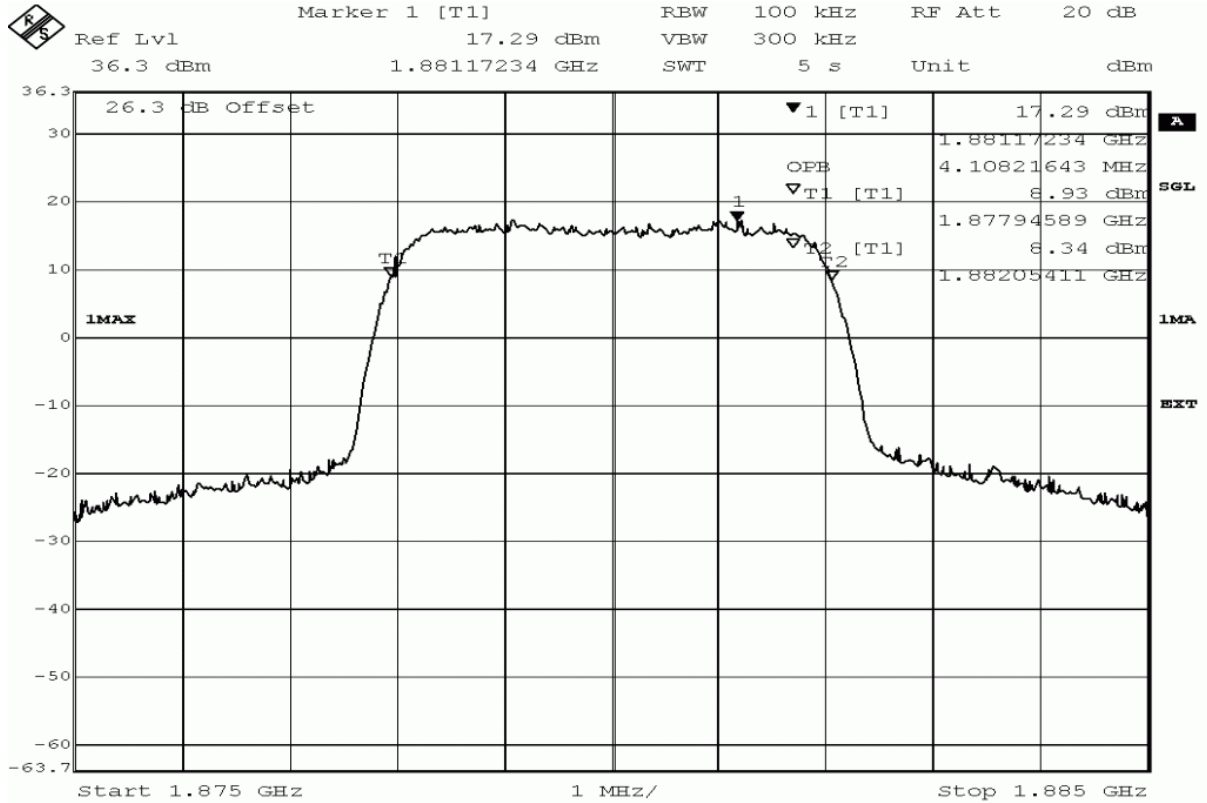

Title: bandwidth measurement
 Comment A: DE1015001, FDD II, occupied bandwidth (99%),
 channel 9400 (1880.0MHz)
 Date: 6.MAY.2014 21:14:38

HSUPA 99% Bandwidth Mid Channel

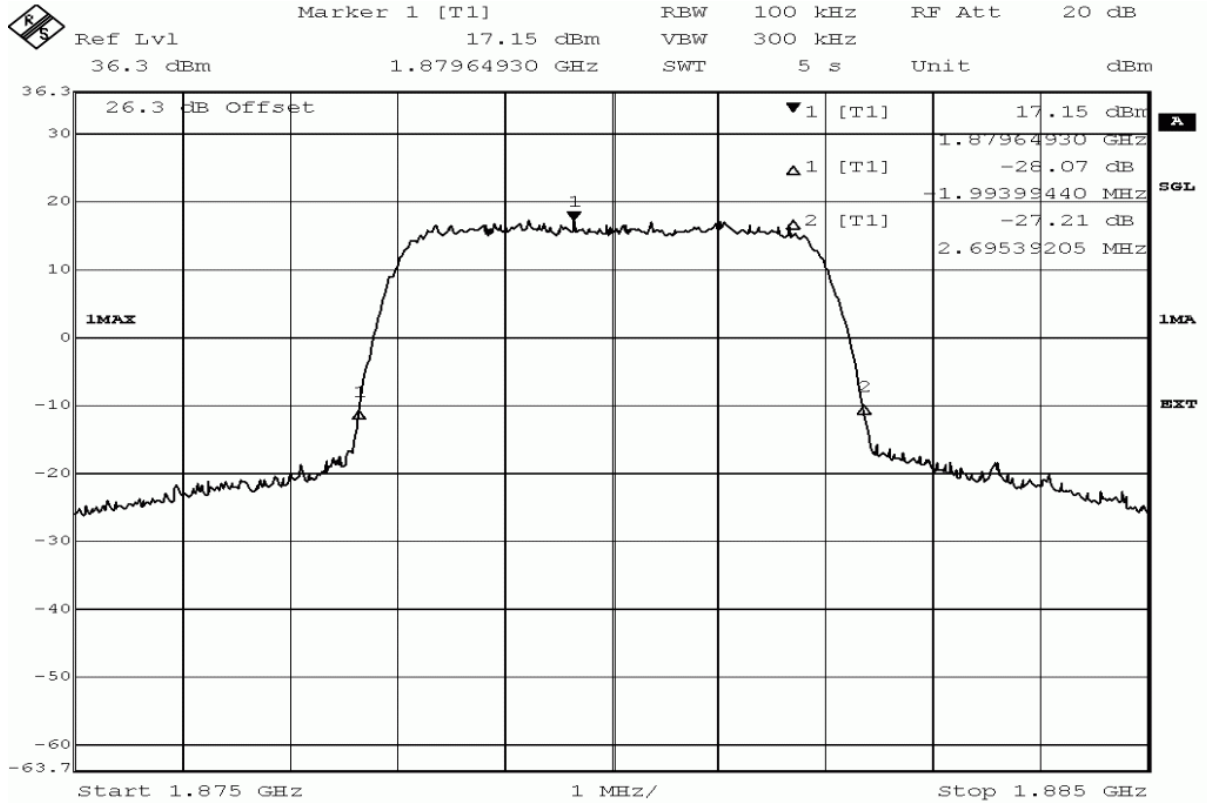

Title: bandwidth measurement
 Comment A: DE1015001, FDD II, 26dB bandwidth,
 channel 9400 (1880.0MHz)
 Date: 6.MAY.2014 21:14:15

HSUPA 26dB Bandwidth Mid Channel

3.5.12 24.6 Band edge compliance §2.1053, §24.238

Test: 24.6; Frequency Band = 1900 / FDD2

<i>Result:</i>	Passed
<i>Setup No.:</i>	S_AH02
<i>Date of Test:</i>	2014/05/06 9:36
<i>Body:</i>	FCC47CFRChIPART24PERSONAL COMMUNICATIONS SERVICES
<i>Test Specification:</i>	FCC part 2 and 24

Detailed Results:

Band	Mode	Modulation	Detector	Frequency (MHZ)	peak value /dBm	margin to limit /dB	limit /dBm	Verdict
1900	GSM / GPRS	GFSK	peak	1849.999	-13.06	0.06	-13.0	passed
			average	1849.996	-35.18	22.18	-13.0	passed
			rms	1849.999	-27.44	14.44	-13.0	passed
peak			1910.024	-17.71	4.71	-13.0	passed	
average			1910.021	-36.34	23.34	-13.0	passed	
rms			1910.021	-28.64	15.64	-13.0	passed	
Band	Mode	Modulation	Detector	Frequency (MHZ)	peak value /dBm	margin to limit /dB	limit /dBm	Verdict
FDD 2	W-CDMA	QPSK	peak	1849.930	-22.56	9.56	-13.0	Pass
			average	1850.000	-32.03	19.03	-13.0	Pass
			rms	1850.000	-31.31	18.31	-13.0	Pass
peak			1910.140	-21.29	8.28	-13.0	Pass	
average			1910.093	-30.64	17.64	-13.0	Pass	
rms			1910.117	-29.72	16.72	-13.0	Pass	
FDD 2	HSDPA		peak	1849.790	-21.05	8.05	-13.0	Pass
average			1849.895	-31.31	18.31	-13.0	Pass	
rms			1849.848	-30.64	17.64	-13.0	Pass	
peak			1910.152	-20.75	7.75	-13.0	Pass	
average			1910.105	-30.64	17.64	-13.0	Pass	
rms			1910.128	-29.44	16.44	-13.0	Pass	
FDD 2	HSUPA	peak	1849.941	-22.64	9.64	-13.0	Pass	
average		1850.000	-32.03	19.03	-13.0	Pass		
rms		1850.000	-31.31	18.31	-13.0	Pass		
peak		1910.000	-20.82	7.82	-13.0	Pass		
average		1910.000	-31.31	18.31	-13.0	Pass		
rms		1910.000	-30.32	17.32	-13.0	Pass		

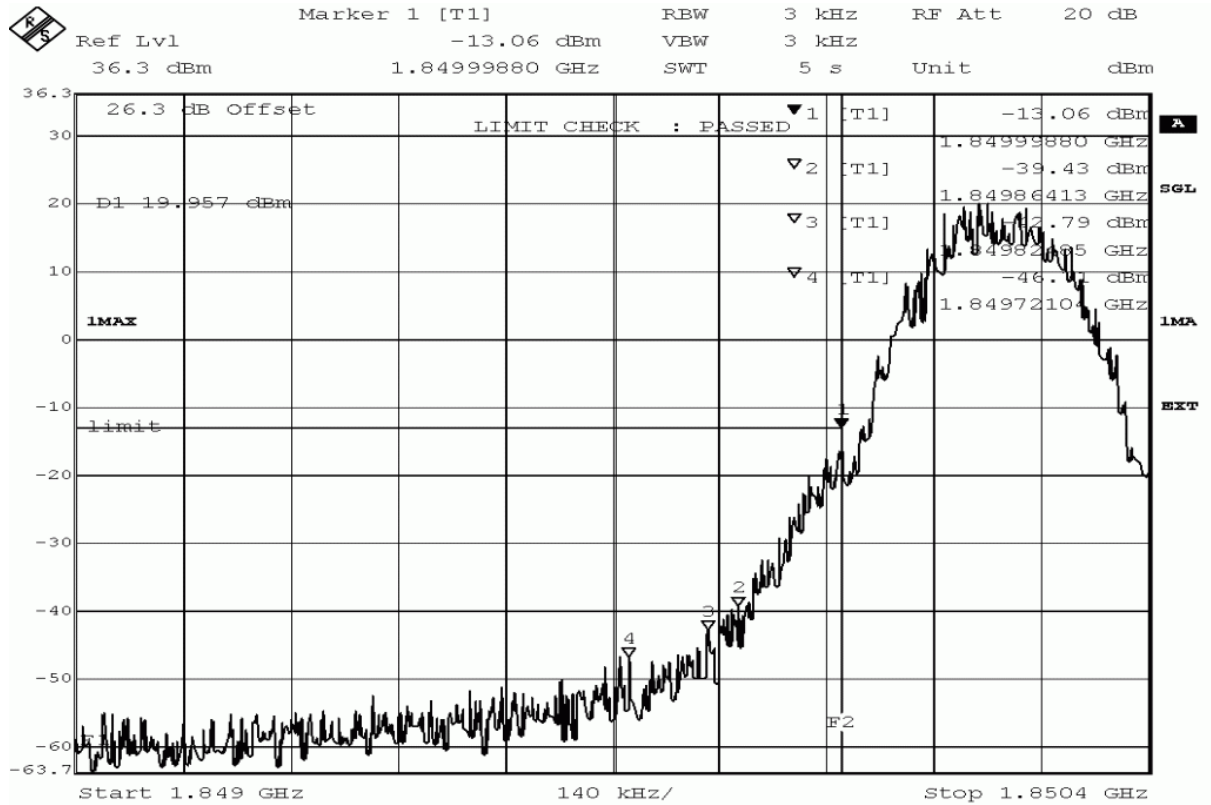

Title: band edge compliance measurement
 Comment A: DE1015001, GSM1900, band edge compliance, channel 512 (1850.2MHz)
 Date: 7.MAY.2014 12:21:14

GSM Low Channel

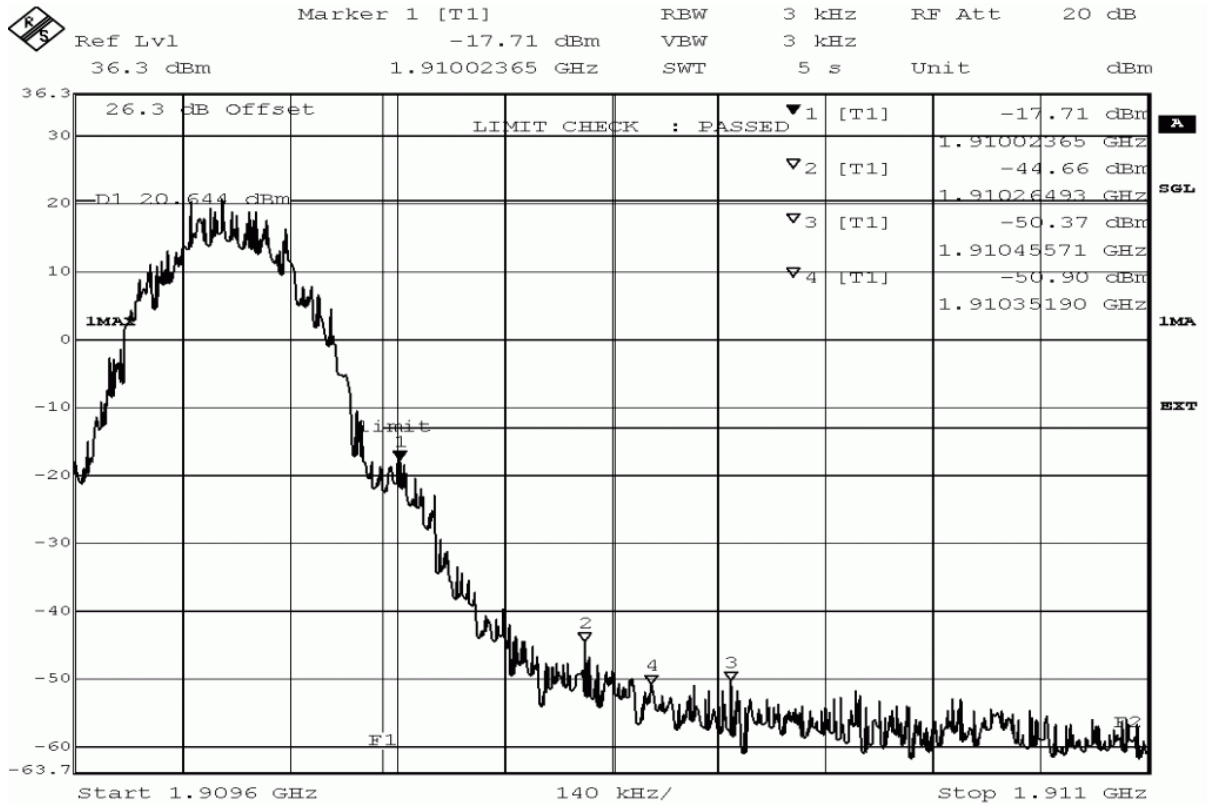

Title: band edge compliance measurement
 Comment A: DE1015001, GSM1900, band edge compliance,
 channel 810 (1909.8MHz)
 Date: 7.MAY.2014 12:42:37

GSM High Channel

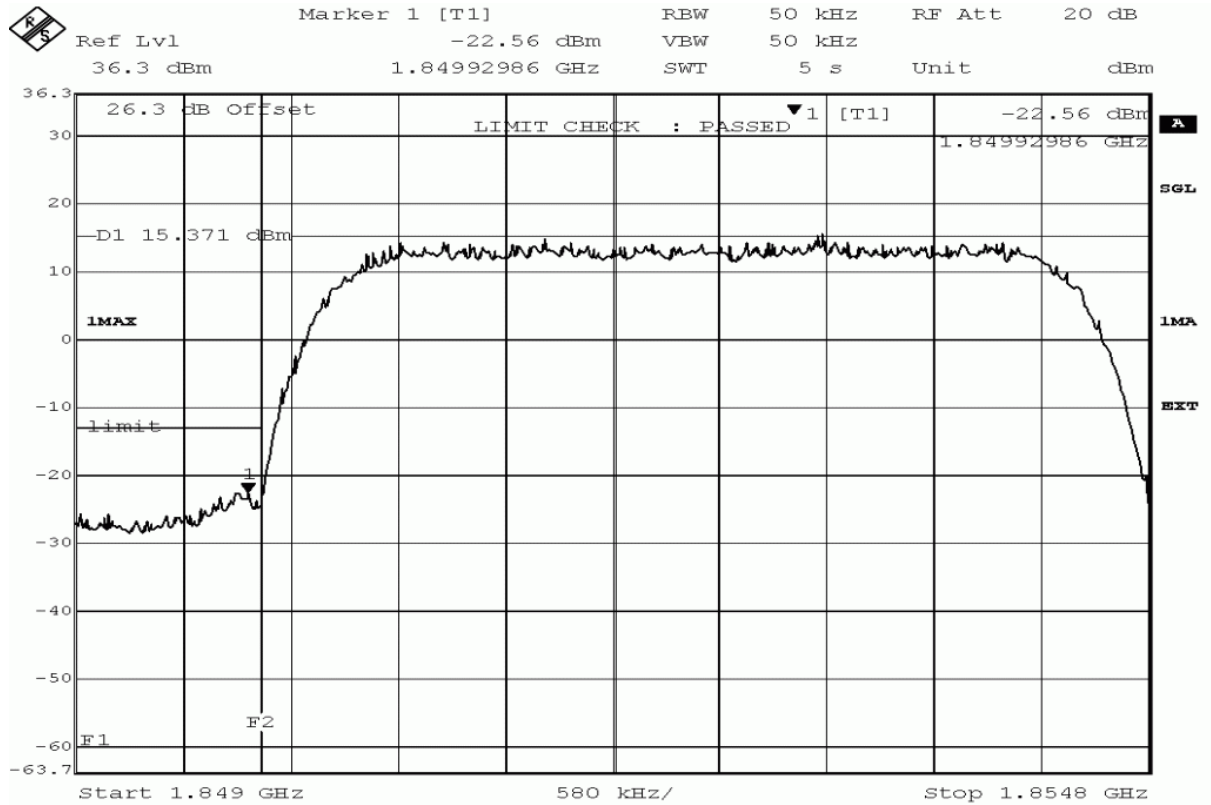

Title: band edge compliance measurement
 Comment A: DE1015001, FDD II, band edge compliance,
 channel 9262 (1852.4MHz)
 Date: 6.MAY.2014 23:58:05

WCDMA Low channel

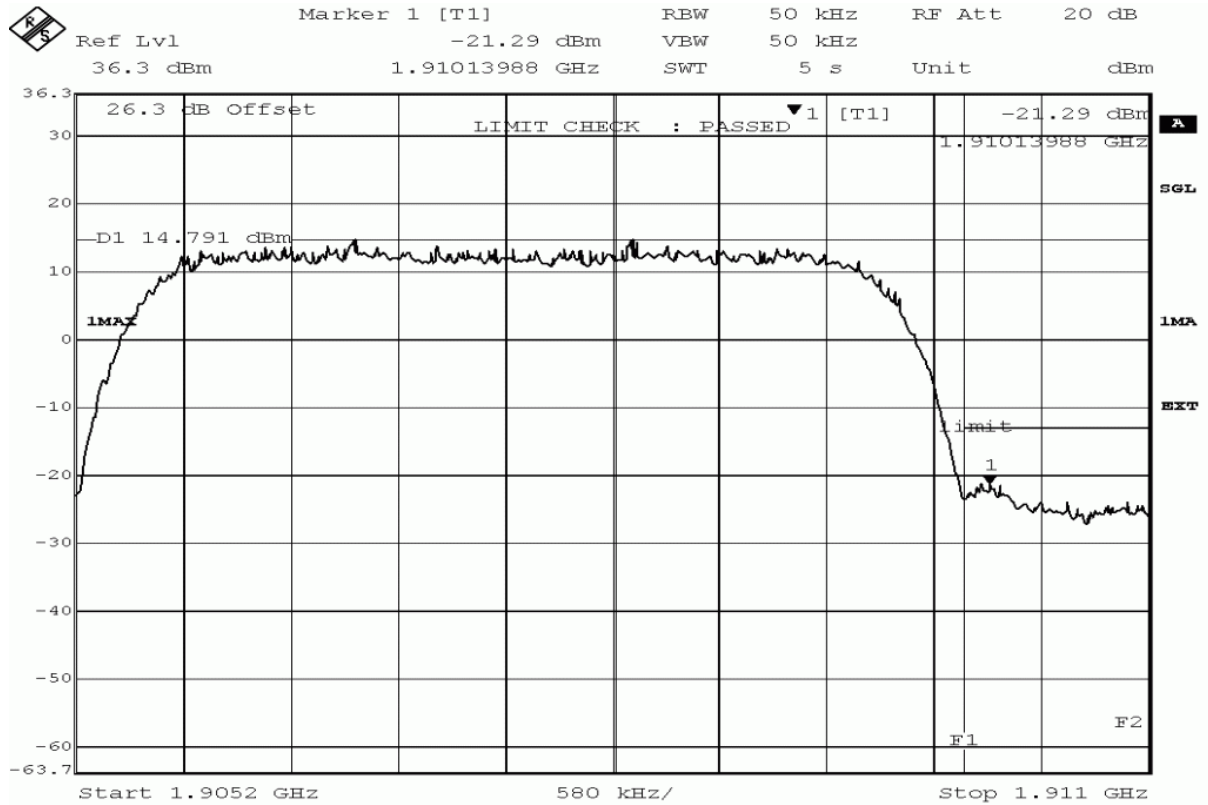

Title: band edge compliance measurement
 Comment A: DE1015001, FDD II, band edge compliance,
 channel 9538 (1907.6MHz)
 Date: 7.MAY.2014 00:08:53

WCDMA high channel

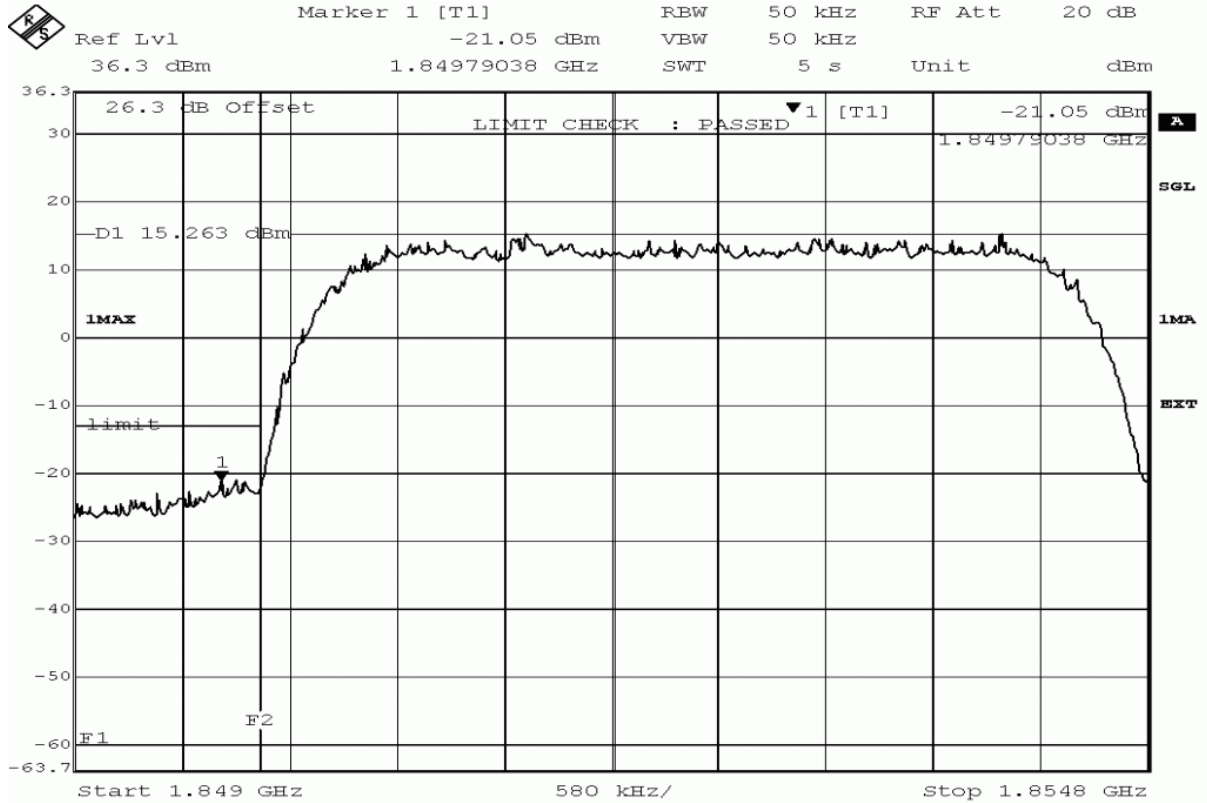

Title: band edge compliance measurement
 Comment A: DE1015001, FDD II HSUPA, band edge compliance, channel 9262 (1852.4MHz)
 Date: 6.MAY.2014 21:28:18

HSDPA low channel

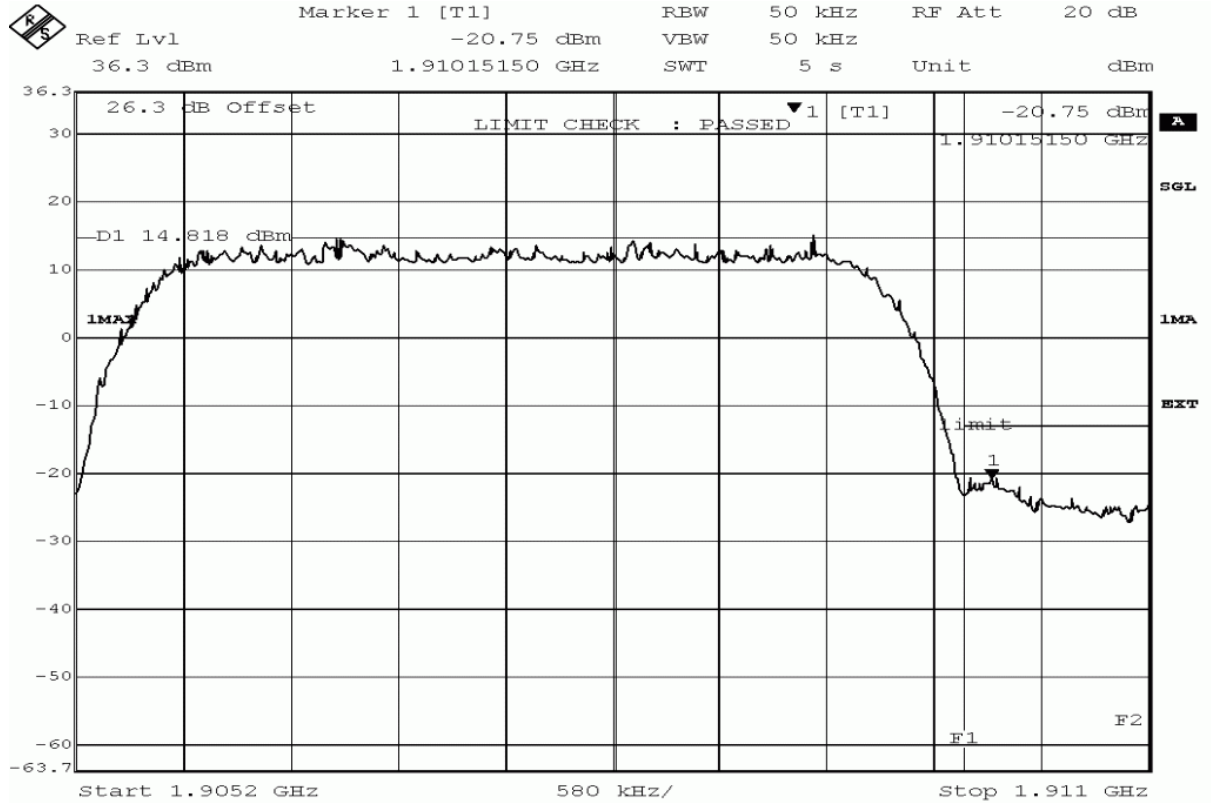

Title: band edge compliance measurement
 Comment A: DE1015001, FDD II HSUPA, band edge compliance,
 channel 9262 (1852.4MHz)
 Date: 6.MAY.2014 21:39:52

HSDPA high channel

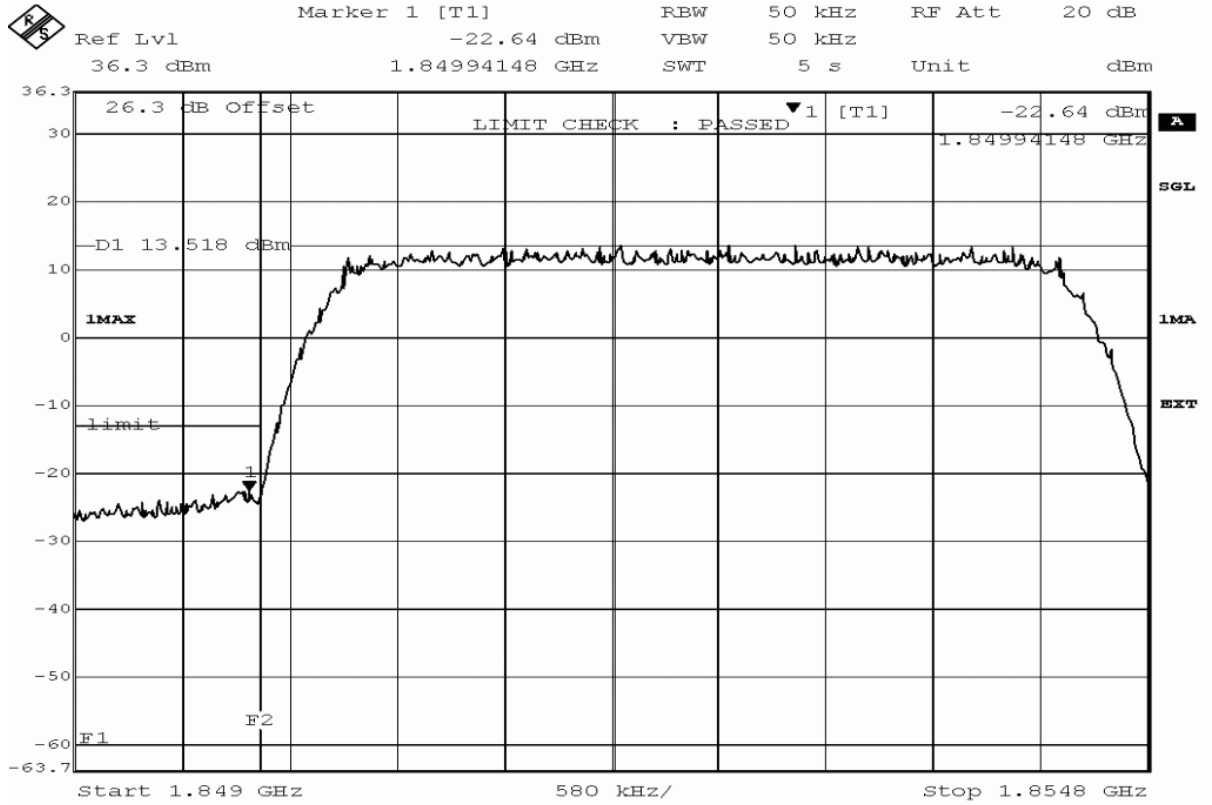

Title: band edge compliance measurement
 Comment A: DE1015001, FDD II HSUPA, band edge compliance, channel 9262 (1852.4MHz)
 Date: 6.MAY.2014 21:09:56

HSUPA Low channel

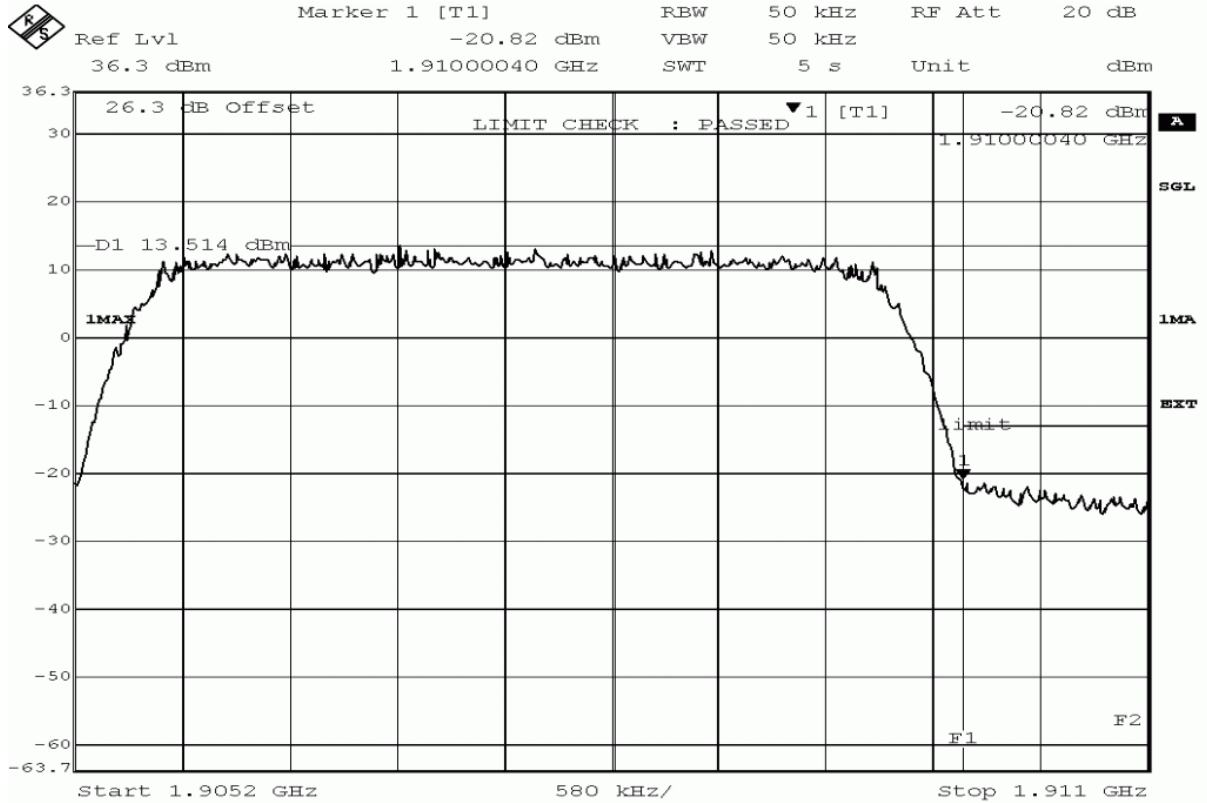

Title: band edge compliance measurement
 Comment A: DE1015001, FDD II HSUPA, band edge compliance, channel 9262 (1852.4MHz)
 Date: 6.MAY.2014 21:18:46

HSUPA high channel

4 Test Equipment Details

4.1 List of Used Test Equipment

The calibration, hardware and software states are shown for the testing period.

Test Equipment Anechoic Chamber

Lab ID:	Lab 1		
Manufacturer:	Frankonia		
Description:	Anechoic Chamber for radiated testing		
Type:	10.58x6.38x6.00 m ³		
	<i>Calibration Details</i>		<i>Last Execution Next Exec.</i>
	NSA (FCC)		2014/01/09 2017/01/09

Single Devices for Anechoic Chamber

<i>Single Device Name</i>	<i>Type</i>	<i>Serial Number</i>	<i>Manufacturer</i>
Air compressor	none	-	Atlas Copco
Anechoic Chamber	10.58 x 6.38 x 6.00 m ³	none	Frankonia
	<i>Calibration Details</i>		<i>Last Execution Next Exec.</i>
	FCC listing 96716 3m Part15/18		2014/01/09 2017/01/08
Controller Maturo	MCU	961208	Maturo GmbH
EMC camera	CE-CAM/1	-	CE-SYS
EMC camera Nr.2	CCD-400E	0005033	Mitsubishi
Filter ISDN	B84312-C110-E1		Siemens&Matsushita
Filter Universal 1A	BB4312-C30-H3	-	Siemens&Matsushita

Test Equipment Auxiliary Equipment for Radiated emissions

Lab ID:	Lab 1
Description:	Equipment for emission measurements
Serial Number:	see single devices

Single Devices for Auxiliary Equipment for Radiated emissions

<i>Single Device Name</i>	<i>Type</i>	<i>Serial Number</i>	<i>Manufacturer</i>
Antenna mast	AM 4.0	AM4.0/180/11920 513	Maturo GmbH
Biconical Broadband Antenna	SBA 9119	9119-005	Schwarzbeck
	<i>Calibration Details</i>		<i>Last Execution Next Exec.</i>
	Standard Calibration		2009/06/04 2014/06/03
Biconical dipole	VUBA 9117	9117-108	Schwarzbeck
	<i>Calibration Details</i>		<i>Last Execution Next Exec.</i>
	Standard Calibration		2012/01/18 2015/01/17
Broadband Amplifier 18MHz-26GHz	JS4-18002600-32-5P	849785	Miteq
Broadband Amplifier 1GHz-4GHz	AFS4-01000400-1Q-10P-4	-	Miteq
Broadband Amplifier 30MHz-18GHz	JS4-00101800-35-5P	896037	Miteq
Cable "ESI to EMI Antenna"	EcoFlex10	W18.01- 2+W38.01-2	Kabel Kusch
Cable "ESI to Horn Antenna"	UFB311A+UFB293C	W18.02- 2+W38.02-2	Rosenberger Micro-Coax

Single Devices for Auxiliary Equipment for Radiated emissions (continued)

<i>Single Device Name</i>	<i>Type</i>	<i>Serial Number</i>	<i>Manufacturer</i>
Double-ridged horn	HF 906	357357/001	Rohde & Schwarz GmbH & Co. KG
	<i>Calibration Details</i>		<i>Last Execution</i> <i>Next Exec.</i>
	Standard Calibration		2012/05/18 2015/05/17
Double-ridged horn	HF 906	357357/002	Rohde & Schwarz GmbH & Co. KG
	<i>Calibration Details</i>		<i>Last Execution</i> <i>Next Exec.</i>
	Standard Calibration		2012/06/26 2015/06/25
High Pass Filter	4HC1600/12750-1.5-KK	9942011	Trilithic
High Pass Filter	5HC2700/12750-1.5-KK	9942012	Trilithic
High Pass Filter	5HC3500/12750-1.2-KK	200035008	Trilithic
High Pass Filter	WHKX 7.0/18G-8SS	09	Wainwright
Horn Antenna Schwarzbeck 15-26 GHz BBHA 9170	BBHA 9170		
Log.-per. Antenna	HL 562 Ultralog	100609	Rohde & Schwarz GmbH & Co. KG
	<i>Calibration Details</i>		<i>Last Execution</i> <i>Next Exec.</i>
	Standard Calibration		2012/12/18 2015/12/17
Log.-per. Antenna	HL 562 Ultralog	830547/003	Rohde & Schwarz GmbH & Co. KG
Loop Antenna	HFH2-Z2	829324/006	Rohde & Schwarz GmbH & Co. KG
	<i>Calibration Details</i>		<i>Last Execution</i> <i>Next Exec.</i>
	Standard calibration		2011/10/27 2014/10/26
Pyramidal Horn Antenna 26,5 GHz	3160-09	00083069	EMCO Elektronik GmbH
Pyramidal Horn Antenna 40 GHz	3160-10	00086675	EMCO Elektronik GmbH
Tilt device Maturo (Rohacell)	Antrieb TD1.5-10kg	TD1.5- 10kg/024/379070 9	Maturo GmbH

Test Equipment Auxiliary Test Equipment

Lab ID:	Lab 1, Lab 2
Manufacturer:	see single devices
Description:	Single Devices for various Test Equipment
Type:	various
Serial Number:	none

Single Devices for Auxiliary Test Equipment

<i>Single Device Name</i>	<i>Type</i>	<i>Serial Number</i>	<i>Manufacturer</i>
Broadband Power Divider N (Aux)	1506A / 93459	LM390	Weinschel Associates
Broadband Power Divider SMA	WA1515	A855	Weinschel Associates
Digital Multimeter 03 (Multimeter)	Fluke 177	86670383	Fluke Europe B.V.
	<i>Calibration Details</i>		<i>Last Execution</i> <i>Next Exec.</i>
	Customized calibration		2013/12/04 2015/12/03
Fibre optic link Satellite (Aux)	FO RS232 Link	181-018	Pontis
Fibre optic link Transceiver (Aux)	FO RS232 Link	182-018	Pontis
Isolating Transformer	LTS 604	1888	Thalheimer Transformatorwerke GmbH
Notch Filter Ultra Stable (Aux)	WRCA800/960-6EEK	24	Wainwright
Signal Analyzer	FSV30	103005	Rohde & Schwarz GmbH & Co. KG
	<i>Calibration Details</i>		<i>Last Execution</i> <i>Next Exec.</i>
	Standard		2014/02/10 2016/02/09
Spectrum Analyser	FSP3	836722/011	Rohde & Schwarz GmbH & Co. KG
	<i>Calibration Details</i>		<i>Last Execution</i> <i>Next Exec.</i>
	Standard		2012/06/13 2015/06/12
Spectrum Analyser	FSU26	200418	Rohde & Schwarz GmbH & Co.KG
	<i>Calibration Details</i>		<i>Last Execution</i> <i>Next Exec.</i>
	Standard calibration		2013/07/29 2014/07/28
Vector Signal Generator	SMIQ 03B	832492/061	Rohde & Schwarz GmbH & Co.KG

Test Equipment Digital Signalling Devices

Lab ID: Lab 1, Lab 2
Description: Signalling equipment for various wireless technologies.

Single Devices for Digital Signalling Devices

Single Device Name	Type	Serial Number	Manufacturer
Bluetooth Signalling Unit CBT	CBT	100589	Rohde & Schwarz GmbH & Co. KG
	<i>Calibration Details</i>		<i>Last Execution</i> <i>Next Exec.</i>
	Standard calibration		2011/11/24 2014/11/23
CMW500	CMW500	107500	Rohde & Schwarz GmbH & Co. KG
Digital Radio Communication Tester	CMD 55	831050/020	Rohde & Schwarz GmbH & Co. KG
	<i>Calibration Details</i>		<i>Last Execution</i> <i>Next Exec.</i>
	Standard calibration		2011/11/28 2014/11/27
Universal Radio Communication Tester	CMU 200	102366	Rohde & Schwarz GmbH & Co. KG
	<i>HW/SW Status</i>		<i>Date of Start</i> <i>Date of End</i>
	Hardware: B11, B21V14, B21-2, B41, B52V14, B52-2, B53-2, B56V14, B68 3v04, PCMCIA, U65V04 Software: K21 4v21, K22 4v21, K23 4v21, K24 4v21, K42 4v21, K43 4v21, K53 4v21, K56 4v22, K57 4v22, K58 4v22, K59 4v22, K61 4v22, K62 4v22, K63 4v22, K64 4v22, K65 4v22, K66 4v22, K67 4v22, K68 4v22, K69 4v22 Firmware: µP1 8v50 02.05.06 ---		2007/07/16
Universal Radio Communication Tester	CMU 200	837983/052	Rohde & Schwarz GmbH & Co. KG
	<i>Calibration Details</i>		<i>Last Execution</i> <i>Next Exec.</i>
	Standard calibration		2011/12/07 2014/12/06
	<i>HW/SW Status</i>		<i>Date of Start</i> <i>Date of End</i>
	HW options: B11, B21V14, B21-2, B41, B52V14, B52-2, B53-2, B54V14, B56V14, B68 3v04, B95, PCMCIA, U65V02 SW options: K21 4v11, K22 4v11, K23 4v11, K24 4v11, K27 4v10, K28 4v10, K42 4v11, K43 4v11, K53 4v10, K65 4v10, K66 4v10, K68 4v10, Firmware: µP1 8v40 01.12.05 --- SW: K62, K69		2007/01/02 2008/11/03
Vector Signal Generator	SMU200A	100912	Rohde & Schwarz GmbH & Co. KG

Test Equipment Emission measurement devices

Lab ID: Lab 1
Description: Equipment for emission measurements
Serial Number: see single devices

Single Devices for Emission measurement devices

<i>Single Device Name</i>	<i>Type</i>	<i>Serial Number</i>	<i>Manufacturer</i>
Personal Computer	Dell	30304832059	Dell
Power Meter	NRVD	828110/016	Rohde & Schwarz GmbH & Co.KG
<i>Calibration Details</i>			
	Standard calibration		2013/05/03 2014/05/02
Sensor Head A	NRV-Z1	827753/005	Rohde & Schwarz GmbH & Co.KG
<i>Calibration Details</i>			
	Standard calibration		2013/04/30 2014/04/29
Signal Generator	SMR 20	846834/008	Rohde & Schwarz GmbH & Co. KG
<i>Calibration Details</i>			
	standard calibration		2011/05/12 2014/05/11
Spectrum Analyzer	ESIB 26	830482/004	Rohde & Schwarz GmbH & Co. KG
<i>Calibration Details</i>			
	Standard Calibration		2014/01/07 2016/01/31
	<i>HW/SW Status</i>		<i>Date of Start Date of End</i>
	Firmware-Update 4.34.4 from 3.45 during calibration		2009/12/03

Test Equipment Radio Lab Test Equipment

Lab ID: Lab 2
Description: Radio Lab Test Equipment

Single Devices for Radio Lab Test Equipment

Single Device Name	Type	Serial Number	Manufacturer
Broadband Power Divider SMA	WA1515	A856	Weinschel Associates
Coax Attenuator 10dB SMA 2W	4T-10	F9401	Weinschel Associates
Coax Attenuator 10dB SMA 2W	56-10	W3702	Weinschel Associates
Coax Attenuator 10dB SMA 2W	56-10	W3711	Weinschel Associates
Coax Cable Huber&Suhner	Sucotest 2,0m		Huber&Suhner
Coax Cable Rosenberger Micro Coax FA210A0010003030 SMA/SMA 1,0m	FA210A0010003030	54491-2	Rosenberger Micro-Coax
Power Meter	NRVD	828110/016	Rohde & Schwarz GmbH & Co.KG
	<i>Calibration Details</i>		<i>Last Execution Next Exec.</i>
	Standard calibration		2013/05/03 2014/05/02
RF Step Attenuator RSP	RSP	833695/001	Rohde & Schwarz GmbH & Co.KG
Rubidium Frequency Standard	Datum, Model: MFS	5489/001	Datum-Beverly
	<i>Calibration Details</i>		<i>Last Execution Next Exec.</i>
	Standard calibration		2013/06/24 2014/06/23
Sensor Head A	NRV-Z1	827753/005	Rohde & Schwarz GmbH & Co.KG
	<i>Calibration Details</i>		<i>Last Execution Next Exec.</i>
	Standard calibration		2013/04/30 2014/04/29
Signal Generator SME	SME03	827460/016	Rohde & Schwarz GmbH & Co.KG
	<i>Calibration Details</i>		<i>Last Execution Next Exec.</i>
	Standard calibration		2011/11/25 2014/11/24
Signal Generator SMP	SMP02	836402/008	Rohde & Schwarz GmbH & Co. KG
	<i>Calibration Details</i>		<i>Last Execution Next Exec.</i>
	Standard calibration		2013/05/06 2016/05/05
Spectrum Analyser	FSIQ26	840061/005	Rohde & Schwarz GmbH & Co. KG
	<i>Calibration Details</i>		<i>Last Execution Next Exec.</i>
	Standard Calibration		2013/02/12 2015/02/11
Temperature Chamber Vötsch 03	VT 4002	58566002150010	Vötsch
	<i>Calibration Details</i>		<i>Last Execution Next Exec.</i>
	Customized calibration		2014/03/11 2016/03/10

5 Annex

5.1 Additional Information for Report

Summary of Test Results

The EUT complied with all performed tests as listed in the summary section of this report.

Technical Report Summary

Type of Authorization :

Certification for a GSM/WCDMA/CDMA2000 cellular radiotelephone device

Applicable FCC Rules

Prepared in accordance with the requirements of FCC Rules and Regulations as listed in 47 CFR Ch.1 Parts 0 to 69. The following subparts are applicable to the results in this test report.

Part 2, Subpart J - Equipment Authorization Procedures, Certification

- § 2.1046 Measurement required: RF power output
- § 2.1049 Measurement required: Occupied bandwidth
- § 2.1051 Measurement required: Spurious emissions at antenna terminals
- § 2.1053 Measurement required: Field strength of spurious radiation
- § 2.1055 Measurement required: Frequency stability
- § 2.1057 Frequency spectrum to be investigated

Part 22, Subpart C – Operational and Technical Requirements

§ 22.355 Frequency tolerance

Part 22, Subpart H – Cellular Radiotelephone Service

- § 22.913 Effective radiated power limits
- § 22.917 Emission limitations for cellular equipment

Part 24, Subpart E - Broadband PCS

- § 24.232 Power and antenna height limits
- § 24.235 Frequency stability
- § 24.236 Field strength limits
- § 24.238 Emission limitations for Broadband PCS equipment

additional documents

ANSI TIA-603-C-2004

Description of Methods of Measurements

RF Power Output

Standard FCC Part 22, Subpart H
 FCC Part 24, Subpart E

The test was performed according to: FCC §2.1046

Test Description (conducted measurement procedure)

- 1) The EUT was coupled to a Spectrum Analyser and a Digital Communication Tester through a Power Divider. Refer to chapter "Setup Drawings".
- 2) The total insertion losses for signal path 1 and signal path 2 were measured. The values were used to correct the readings from the Spectrum Analyser and the Digital Communication Tester.
- 3) A call was established on a Traffic Channel between the EUT and the Digital Communication Tester.
Important Settings:
 - Channel (Frequency): please refer to the detailed results
- 4) The transmitted power of the EUT was recorded by using a spectrum analyser.

Test Description (radiated measurement procedure)

- 1) The EUT was placed inside an anechoic chamber. Refer to chapter "Setup Drawings". The EUT was coupled to a Digital Communication Tester which was located outside the chamber via a small signalling antenna.
- 2) A call was established on a Traffic Channel between the EUT and the Digital Communication Tester.
Important Settings:
 - Output Power: Maximum
 - Channel: please refer to the detailed results
- 3) A substitution procedure is used so that the readings from the spectrum analyser are corrected and represent directly the equivalent radiated power (related to a $\lambda/2$ dipole).
- 4) The output power was measured in both vertical and horizontal antenna polarisation during the call is established on the lowest channel, mid channel and on the highest channel. To find the worst case power all orientations (X, Y, Z) of the EUT have been measured.
- 5) The test procedure according to TIA-603-C-2004 has been considered.

Test Requirements / Limits

§2.1046 Measurements Required: RF Power Output

(a) For transmitters other than single sideband, independent sideband and controlled carrier radiotelephone, power output shall be measured at the RF output terminals when the transmitter is adjusted in accordance with the tune-up procedure to give the values of current and voltage on the circuit elements specified in § 2.1033(c)(8). The electrical characteristics of the output terminals when this test is made shall be stated.

§22.913 Effective radiated power limits

(a)(2) Maximum ERP. ... The ERP of mobile transmitters and auxiliary test transmitters must not exceed 7 Watts.

§24.232 Power and antenna height limits

(c) Mobile/portable stations are limited to 2 watts EIRP peak power and the equipment must employ means to limit the power to the minimum necessary for successful communications.

(e) Peak transmit power must be measured over any interval of continuous transmission using instrumentation calibrated in terms of an rms-equivalent voltage. The measurement results shall be properly adjusted for any instrument limitations, such as detector response times, limited resolution bandwidth capability when compared to the emission bandwidth, sensitivity, etc., so as to obtain a true peak measurement for the emission in question over the full bandwidth of the channel.

Emission and Occupied Bandwidth

Standard FCC Part 22, Subpart H
FCC Part 24, Subpart E

The test was performed according to: FCC §2.1049

Test Description

- 1) The EUT was coupled to a Spectrum Analyser and a Digital Communication Tester through a Power Divider. Refer to chapter "Setup Drawings".
- 2) The total insertion losses for signal path 1 and signal path 2 were measured. The values were used to correct the readings from the Spectrum Analyser and the Digital Communication Tester.
- 3) A call was established on a Traffic Channel between the EUT and the Digital Communication Tester.
Important Settings:
 - Output Power: Maximum
 - Channel: please refer to the detailed results

4) Important Analyser Settings:

- Resolution Bandwidth: >1% of the manufacturer's stated occupied bandwidth

5) The maximum spectral level of the modulated signal was recorded as the reference.

6) The emission bandwidth is measured as follows:

the two furthest frequencies above and below the frequency of the maximum reference level where the spectrum is -26 dB down have to be found.

7) The occupied bandwidth (99% Bandwidth) is measured as follows:

the occupied bandwidth, that is the frequency bandwidth such that, below its lower and above its upper frequency limits, the mean powers are each equal to 0.5 percent of the total mean power.

Test Requirements / Limits

§ 2.1049 Measurements required: Occupied bandwidth

The occupied bandwidth, that is the frequency bandwidth such that, below its lower and above its upper frequency limits, the mean powers radiated are each equal to 0.5 percent of the total mean power radiated by a given emission shall be measured under the following conditions (as applicable):

(h) Transmitters employing digital modulation techniques - when modulated by an input signal such that its amplitude and symbol rate represent the maximum rated conditions under which the equipment will be operated. The signal shall be applied through any filter networks, pseudo-random generators or other devices required in normal service. Additionally, the occupied bandwidth shall be shown for operation with any devices used for modifying the spectrum when such devices are optional at the discretion of the user.

Spurious emissions at antenna terminals

Standard FCC Part 22, Subpart H
FCC Part 24, Subpart E

The test was performed according to FCC §2.1051

Test Description

1) The EUT was coupled to a Spectrum Analyser and a Digital Communication Tester through a Power Divider. Refer to chapter "Setup Drawings".

2) The total insertion losses for signal path 1 and signal path 2 were measured. The values were used to correct the readings from the Spectrum Analyser and the Digital Communication Tester.

3) A call was established on a Traffic Channel between the EUT and the Digital Communication Tester.

Important Settings:

- Output Power: Maximum

- Channel: please refer to the detailed results

4) Important Analyser Settings

- [Resolution Bandwidth]:

a) [$\geq 1\%$ of wanted signal bandwidth] in the Span of 1 MHz directly below and above the PCS-Band,

b) otherwise [100 kHz] (or [1 MHz] for accelerated sweep times)

c) [reduced resolution bandwidth] in case the curve of the analyser IF-Filter or the wanted EUT signal leads to an exceeding of the limit, in this case a correction factor was used

- Sweep Time: depending on the transmitting signal, the span and the resolution bandwidth

5) The spurious emissions peaks were measured in the frequency range from 9 kHz to 10 GHz (up to the 10th harmonic) during the call was established

Test Requirements / Limits

§ 2.1051 Spurious emissions at antenna terminals

The radio frequency voltage or power generated within the equipment and appearing on a spurious frequency shall be checked at the equipment output terminals when properly loaded with a suitable artificial antenna. Curves or equivalent data shall show the magnitude of each harmonic and other spurious emission that can be detected when the equipment is operated under the conditions specified in Sec. 2.1049 as appropriate. The magnitude of spurious emissions which are attenuated more than 20 dB below the permissible value need not be specified.

§ 2.1057 Frequency spectrum to be investigated.

(a) In all of the measurements set forth in Secs. 2.1051 and 2.1053, the spectrum shall be investigated from the lowest radio frequency signal generated in the equipment, without going below 9 kHz, up to at least the frequency shown below:

(1) If the equipment operates below 10 GHz: to the tenth harmonic of the highest fundamental frequency or to 40 GHz, whichever is lower.

(b) Particular attention should be paid to harmonics and subharmonics of the carrier frequency as well as to those frequencies removed from the carrier by multiples of the oscillator frequency. Radiation at the frequencies of multiplier stages should also be checked.

(c) The amplitude of spurious emissions which are attenuated more than 20 dB below the permissible value need not be reported.

(d) Unless otherwise specified, measurements above 40 GHz shall be performed using a minimum resolution bandwidth of 1 MHz.

§ 22.917 Emission limitations for cellular equipment

(a) The power of any emission outside of the authorized operating frequency ranges must be attenuated below the transmitting power (P) by a factor of at least $43 + 10 \log(P)$ dB.

Remark of the test laboratory: This is calculated to be -13 dBm.

(b) Compliance with these rules is based on the use of measurement instrumentation employing a resolution bandwidth of 100 kHz or greater. In the 1 MHz bands immediately outside and adjacent to the frequency block a resolution bandwidth of at least one percent of the emission bandwidth of the fundamental emission of the transmitter may be employed. A narrower resolution bandwidth is permitted in all cases to improve measurement accuracy provided the measured power is integrated over the full required measurement bandwidth (i.e. 100 kHz or 1 percent of emission bandwidth, as specified). The emission bandwidth is defined as the width of the signal between two points, one below the carrier center frequency and one above the carrier center frequency, outside of which all emissions are attenuated at least 26 dB below the transmitter power.

(c) Licensees in this service may establish an alternative out of band emission limit to be used at specified band edge(s) in specified geographical areas [...].

(d) If any emission from a transmitter operating in this service results in interference to users of another radio service, the FCC may require a greater attenuation of that emission than specified in this section.

For reporting only spurious emission levels reaching to the 20dB margin to limit were noted.

§ 24.238 Emission limitations for Broadband PCS equipment

(a) The power of any emission outside of the authorized operating frequency ranges must be attenuated below the transmitting power (P) by a factor of at least $43 + 10 \log(P)$ dB.

Remark of the test laboratory: This is calculated to be -13 dBm.

(b) Compliance with these rules is based on the use of measurement instrumentation employing a resolution bandwidth of 1 MHz or greater. However, in the 1 MHz bands immediately outside and adjacent to the frequency block a resolution bandwidth of at least one percent of the emission bandwidth of the fundamental emission of the transmitter may be employed. A narrower resolution bandwidth is permitted in all cases to improve measurement accuracy provided the measured power is integrated over the full required measurement bandwidth (i.e. 1 MHz or 1 percent of emission bandwidth, as specified). The emission bandwidth is defined as the width of the signal between two points, one below the carrier center frequency and one above the carrier center frequency, outside of which all emissions are attenuated at least 26 dB below the transmitter power.

(c) Licensees in this service may establish an alternative out of band emission limit to be used at specified band edge(s) in specified geographical areas [...].

(d) If any emission from a transmitter operating in this service results in interference to users of another radio service, the FCC may require a greater attenuation of that emission than specified in this section.

For reporting only spurious emission levels reaching to the 20dB margin to limit were noted.

Field strength of spurious radiation

Standard FCC Part 22, Subpart H
 FCC Part 24, Subpart E

The test was performed according to: FCC §2.1053

Test Description

- 1) The EUT was placed inside an anechoic chamber. Refer to chapter "Setup Drawings". The EUT was coupled to a Digital Communication Tester which was located outside the chamber via a small signalling antenna.
- 2) A call was established on a Traffic Channel between the EUT and the Digital Communication Tester.

Important Settings:

- Output Power: Maximum

- Channel: please refer to the detailed results

- 3) A pre-calibration procedure is used so that the readings from the spectrum analyser are corrected and represent directly the equivalent radiated power (related to a $\lambda/2$ dipole).

- 4) All spurious radiation measurements were made with spectrum analyser and the appropriate calibrated antennas for the frequency range of 30 MHz to 10 GHz (up to the 10th harmonic of the transmit frequency). The frequency range from 9 kHz to 30 MHz has been examined during the conducted spurious emission measurements.

- 5) Important Analyser Settings

- [Resolution Bandwidth / Video Bandwidth]:

- a) [3 kHz / 10 kHz] in the Span of 1 MHz directly below and above the Band,

- b) [10 kHz / 30 kHz] in case the curve of the analyser IF-Filter leads to an exceeding of the limit, in this case a worst case correction factor of 20 dB (1 MHz -> 10 kHz) was used

- c) [1 MHz / 3 MHz] otherwise

- Sweep Time: depending on the transmitting signal, the span and the resolution bandwidth

- 6) The spurious emissions peaks were measured in both vertical and horizontal antenna polarization during the call is established on the lowest channel, mid channel and on the highest channel. To find the worst case peaks all orientations (X, Y, Z) of the EUT have been measured.

Test Requirements / Limits

§ 2.1053 Measurements required: Field strength of spurious radiation.

Measurements shall be made to detect spurious emissions that may be radiated directly from the cabinet, control circuits, power leads, or intermediate circuit elements under normal conditions of installation and operation. Curves or equivalent data shall be supplied showing the magnitude of each harmonic and other spurious emission. For this test, single sideband, independent sideband, and controlled carrier transmitters shall be modulated under the conditions specified in paragraph (c) of Sec. 2.1049, as appropriate. For equipment operating on frequencies below 890 MHz, an open field test is normally required, with the measuring instrument antenna located in the far-field at all test frequencies. In the event it is either impractical or impossible to make open field measurements (e.g. a broadcast transmitter installed in a building) measurements will be accepted of the equipment as installed. Such measurements must be accompanied by a description of the site where the measurements were made showing the location of any possible source of reflections which might distort the field strength measurements. Information submitted shall include the relative radiated power of each spurious emission with reference to the rated power output of the transmitter, assuming all emissions are radiated from halfwave dipole antennas.

(b) The measurements specified in paragraph (a) of this section shall be made for the following equipment:

(2) All equipment operating on frequencies higher than 25 MHz.

§ 2.1057 Frequency spectrum to be investigated.

(a) In all of the measurements set forth in Secs. 2.1051 and 2.1053, the spectrum shall be investigated from the lowest radio frequency signal generated in the equipment, without going below 9 kHz, up to at least the frequency shown below:

- (1) If the equipment operates below 10 GHz: to the tenth harmonic of the highest fundamental frequency or to 40 GHz, whichever is lower.

- (b) Particular attention should be paid to harmonics and subharmonics of the carrier frequency as well as to those frequencies removed from the carrier by multiples of the oscillator frequency. Radiation at the frequencies of multiplier stages should also be checked.

- (c) The amplitude of spurious emissions which are attenuated more than 20 dB below the permissible value need not be reported.

- (d) Unless otherwise specified, measurements above 40 GHz shall be performed using a minimum resolution bandwidth of 1 MHz.

§ 22.917 Emission limitations for cellular equipment

(a) The power of any emission outside of the authorized operating frequency ranges must be attenuated below the transmitting power (P) by a factor of at least $43 + 10 \log(P)$ dB.

This is calculated to be -13 dBm (effective radiated power) which corresponds to 84.6 dB μ V/m (field strength) in a distance of 3 m.

(b) Compliance with these rules is based on the use of measurement instrumentation employing a resolution bandwidth of 100 kHz or greater. In the 1 MHz bands immediately outside and adjacent to the frequency block a resolution bandwidth of at least one percent of the emission bandwidth of the fundamental emission of the transmitter may be employed. A narrower resolution bandwidth is permitted in all cases to improve

measurement accuracy provided the measured power is integrated over the full required measurement bandwidth (i.e. 100 kHz or 1 percent of emission bandwidth, as specified). The emission bandwidth is defined as the width of the signal between two points, one below the carrier center frequency and one above the carrier center frequency, outside of which all emissions are attenuated at least 26 dB below the transmitter power.

(c) Licensees in this service may establish an alternative out of band emission limit to be used at specified band edge(s) in specified geographical areas [...].

(d) If any emission from a transmitter operating in this service results in interference to users of another radio service, the FCC may require a greater attenuation of that emission than specified in this section.

For reporting only spurious emission levels reaching to the 20dB margin to limit were noted.

§ 24.238 Emission limitations for Broadband PCS equipment

(a) The power of any emission outside of the authorized operating frequency ranges must be attenuated below the transmitting power (P) by a factor of at least $43 + 10 \log(P)$ dB.

This is calculated to be -13 dBm (effective radiated power) which corresponds to 84.6 dB μ V/m (field strength) in a distance of 3 m.

(b) Compliance with these rules is based on the use of measurement instrumentation employing a resolution bandwidth of 1 MHz or greater. However, in the 1 MHz bands immediately outside and adjacent to the frequency block a resolution bandwidth of at least one percent of the emission bandwidth of the fundamental emission of the transmitter may be employed. A narrower resolution bandwidth is permitted in all cases to improve measurement accuracy provided the measured power is integrated over the full required measurement bandwidth (i.e. 1 MHz or 1 percent of emission bandwidth, as specified). The emission bandwidth is defined as the width of the signal between two points, one below the carrier center frequency and one above the carrier center frequency, outside of which all emissions are attenuated at least 26 dB below the transmitter power.

(c) Licensees in this service may establish an alternative out of band emission limit to be used at specified band edge(s) in specified geographical areas [...].

(d) If any emission from a transmitter operating in this service results in interference to users of another radio service, the FCC may require a greater attenuation of that emission than specified in this section.

For reporting only spurious emission levels reaching to the 20dB margin to limit were noted.

Frequency stability

Standard FCC Part 22, Subpart H
FCC Part 24, Subpart E

The test was performed according to FCC §2.1055

Test Description

- 1) The EUT was placed inside a temperature chamber.
- 2) The EUT was coupled to a Digital Communication Tester. Refer to chapter "Setup Drawings".
- 3) The climatic chamber was cycled down/up to a certain temperature, starting with the EUT minimum temperature.
- 4) After the temperature was stabilized the EUT was switched on and a call was established on a Traffic Channel between the EUT and the Digital Communication Tester.
Important Settings:
 - Output Power: Maximum
 - Mid Channel
- 5) The frequency error of the EUT was recorded by using an internal measurement function of the Digital Communication Tester immediately after the call was established, five minutes after the call was established and ten minutes after the call was established.
- 6) This measurement procedure was performed for temperature variation from -30°C to +50°C in increments of 10°C, if not otherwise stated in the detailed results.
When the EUT did not operate at certain temperature levels, these measurements were left out.

Test Requirements / Limits

§2.1055 Measurements required: Frequency stability

(a) The frequency stability shall be measured with variation of ambient temperature as follows:

- (1) From -30° to +50° centigrade for all equipment except that specified in paragraphs (a) (2) and (3) of this section.
- (b) Frequency measurements shall be made at the extremes of the specified temperature range and at intervals of not more than 10° centigrade through the range. A period of time sufficient to stabilize all of the components of the oscillator circuit at each temperature level shall be allowed prior to frequency measurement. The short term transient effects on the frequency of the transmitter due to keying (except for broadcast transmitters) and any heating element cycling normally occurring at each ambient temperature level also shall be shown. Only the portion or portions of the transmitter containing the frequency determining and stabilizing circuitry need be subjected to the temperature variation test.
- (d) The frequency stability shall be measured with variation of primary supply voltage as follows:
- (1) Vary primary supply voltage from 85 to 115 percent of the nominal value for other than hand carried battery equipment.
- (2) For hand carried, battery powered equipment, reduce primary supply voltage to the battery operating end point which shall be specified by the manufacturer.
- (3) The supply voltage shall be measured at the input to the cable normally provided with the equipment, or at the power supply terminals if cables are not normally provided. Effects on frequency of transmitter keying (except for broadcast transmitters) and any heating element cycling at the nominal supply voltage and at each extreme also shall be shown.

§22.355 Frequency tolerance

...the carrier frequency of each transmitter in the Public Mobile Service must be maintained within the tolerances given in table C-1 of this section.

Table C-1.- Frequency Tolerance for Transmitters in the Public Mobile Services

Frequency range (MHz)	Base, fixed (ppm)	Mobile up to 3 watts (ppm)	Mobile above 3 watts (ppm)
25 to 50	20.0	20.0	50.0
50 to 450	5.0	5.0	50.0
450 to 512	2.5	5.0	5.0
821 to 896	1.5	2.5	2.5
928 to 929	5.0	n/a	n/a
929 to 960	1.5	n/a	n/a
2110 to 2220	10.0	n/a	n/a For the mid

channel (836.6 MHz) the frequency tolerance is 2.5 ppm (2091.5 Hz).

§24.235 Frequency stability

The frequency stability shall be sufficient to ensure that the fundamental emission stays within the authorized frequency block.

7Layers interpretation of limit:

To ensure that the frequency stability shall be sufficient to ensure that the fundamental emission stays within the authorized frequency block following limit was used:

$$\pm 2.5 \text{ ppm} = 4700 \text{ Hz for a frequency of } 1880.0 \text{ MHz}$$

in accordance with FCC Part 22, Subpart H, §22.355, table C-1: Frequency tolerance for the carrier frequency of mobile transmitters in the Public Mobile Service in the frequency range 821 to 896 MHz.

Band edge compliance

Standard FCC Part 22, Subpart H

The test was performed according to: FCC §22.913

Test Description

- 1) The EUT was coupled to a Spectrum Analyser and a Digital Communication Tester through a Power Divider. Refer to chapter "Setup Drawings".
 - 2) The total insertion losses for signal path 1 and signal path 2 were measured. The values were used to correct the readings from the Spectrum Analyser and the Digital Communication Tester.
 - 3) A call was established on a Traffic Channel between the EUT and the Digital Communication Tester.
- Important Settings:

- Output Power: Maximum
- Channel: please refer to the detailed results
- 4) Important Analyser Settings:
 - Resolution Bandwidth = Video Bandwidth: >1% of the manufacturer's stated occupied bandwidth

Test Requirements / Limits

§ 22.917 Emission limitations for cellular equipment

Refer to chapter "Field strength of spurious radiation".

Band edge compliance

Standard: FCC Part 24, Subpart E

The test was performed according to: FCC §24.238

Test Description

1) The EUT was coupled to a Spectrum Analyser and a Digital Communication Tester through a Power Divider. Refer to chapter "Setup Drawings".

2) The total insertion losses for signal path 1 and signal path 2 were measured. The values were used to correct the readings from the Spectrum Analyser and the Digital Communication Tester.

3) A call was established on a Traffic Channel between the EUT and the Digital Communication Tester.

Important Settings:

- Output Power: Maximum
- Channel: please refer to the detailed results
- 4) Important Analyser Settings:
 - Resolution Bandwidth = Video Bandwidth: >1% of the manufacturer's stated occupied bandwidth

Test Requirements / Limits

§ 24.238 Effective radiated power limits

Refer to chapter "Field strength of spurious radiation".

Subtests HSDPA

Sub-test	β_c	β_d	β_d (SF)	β_c/β_d	β_{HS} (Note1, Note 2)	CM (dB) (Note 3)	MPR (dB) (Note 3)
1	2/15	15/15	64	2/15	4/15	0.0	0.0
2	12/15 (Note 4)	15/15 (Note 4)	64	12/15 (Note 4)	24/15	1.0	0.0
3	15/15	8/15	64	15/8	30/15	1.5	0.5
4	15/15	4/15	64	15/4	30/15	1.5	0.5

Note 1: $?_{ACK}$, $?_{NACK}$ and $?_{CQI} = 30/15$ with $\beta_{hs} = 30/15 * \beta_c$.

Note 2: For the HS-DPCCH power mask requirement test in clause 5.2C, 5.7A, and the Error Vector Magnitude (EVM) with HS-DPCCH test in clause 5.13.1A, and HSDPA EVM with phase discontinuity in clause 5.13.1AA, $?_{ACK}$ and $?_{NACK} = 30/15$ with $\beta_{hs} = 30/15 * \beta_c$, and $?_{CQI} = 24/15$ with $\beta_{hs} = 24/15 * \beta_c$.

Note 3: CM = 1 for $\beta_c/\beta_d = 12/15$, $\beta_{HS}/\beta_c = 24/15$. For all other combinations of DPDCH, DPCCH and HS-DPCCH the MPR is based on the relative CM difference. This is applicable for only UEs that support HSDPA in release 6 and later releases.

Note 4: For subtest 2 the β_c/β_d ratio of 12/15 for the TFC during the measurement period (TF1, TF0) is achieved by setting the signalled gain factors for the reference TFC (TF1, TF1) to $\beta_c = 11/15$ and $\beta_d = 15/15$.

Subtests HSUPA

Subtest	Mode	Loopback Mode	Rel99 RMC	HSDPA FRC	HSUPA Test	Number of E-DPDCH Channels
1	Rel6 HSUPA	Test Mode 1	12.2kbps RMC	H-Set1	HSUPA Loopback	1
2	Rel6 HSUPA	Test Mode 1	12.2kbps RMC	H-Set1	HSUPA Loopback	1
3	Rel6 HSUPA	Test Mode 1	12.2kbps RMC	H-Set1	HSUPA Loopback	2
4	Rel6 HSUPA	Test Mode 1	12.2kbps RMC	H-Set1	HSUPA Loopback	1
5	Rel6 HSUPA	Test Mode 1	12.2kbps RMC	H-Set1	HSUPA Loopback	1

Subtest	Max UL Data Rate (kb/s)	β_c/β_d	β_{hs}	β_d	CM
1	242.1	11/15	22/15	1309/225	1
2	161.3	6/15	12/15	94/75	3
3	524.7	15/9	30/15	47/15	2
4	197.6	2/15	4/15	56/75	3
5	299.6	15/15	30/15	134/15	1

Setup Drawings

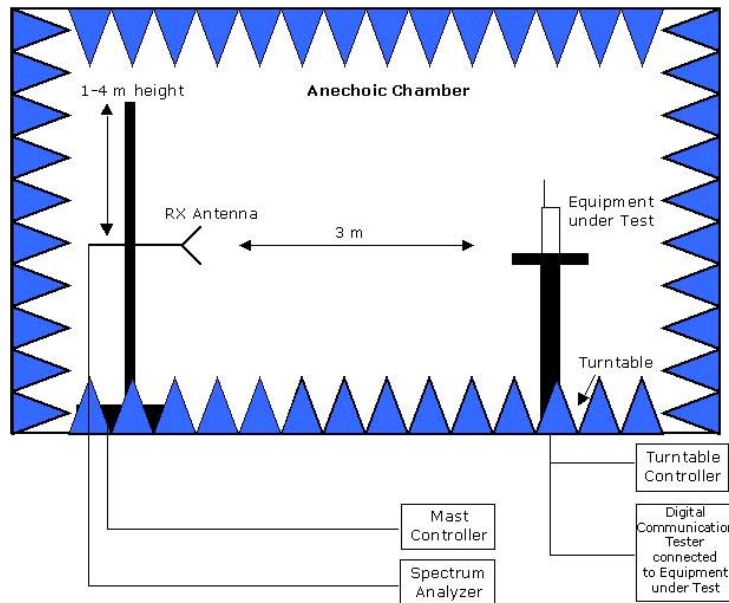

Remark: Depending on the frequency range suitable antenna types, attenuators or preamplifiers are used.

Principle set-up for radiated measurements

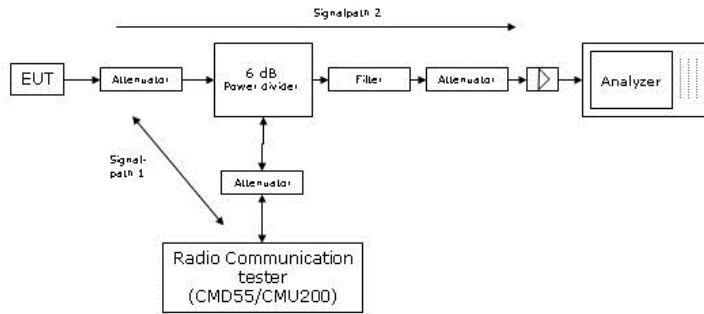

Remark: Depending on the frequency range suitable attenuators and/or filters and/or amplifiers are used.

Principle set-up for conducted measurements under nominal conditions

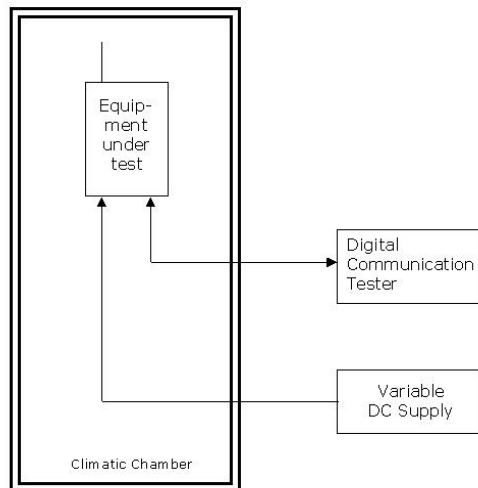

Principle set-up for tests under extreme test conditions

Correlation of measurement requirements for Cellular Equipment from FCC and IC

Test name – FCC	FCC reference CFR47				Test name – IC	IC reference			
	Part 2	Part 22	Part 24	Part 27		RSS-Gen	RSS-132 SRSP-503	RSS-133 SRSP-510	RSS-139 SRSP-513
					Issue:	3, 2010	3, 2013	6, 2013	2, 2009
RF power output	§ 2.1046	§ 22.913	§ 24.232	§ 27.50	Transmitter output power	4.8	5.4	6.4	6.4
Frequency stability	§ 2.1055	§ 22.355	§ 24.235	§ 27.54	Frequency stability	4.7	5.3	6.3	6.3
Spurious emissions at antenna terminals	§ 2.1051	§ 22.917	§ 24.238	§ 27.53	Transmitter unwanted emissions conducted	4.9	5.5	6.5	6.5
–	–	–	–	–	Receiver unwanted emissions conducted	4.10; 6.2	5.6 *)	6.6 *)	6.6 *)
Field strength of spurious radiation	§ 2.1053	§ 22.917	§ 24.238	§ 27.53	Transmitter unwanted emissions radiated	4.9	5.5	6.5	6.5
–	–	–	–	–	Receiver unwanted emissions radiated	4.10; 6.2	5.6 *)	6.6 *)	6.6 *)
Emission and Occupied Bandwidth	§ 2.1049	–	–	–	Emission and Occupied Bandwidth	4.6	5.5	2.3; 6.5	2.3; 6.5
Band edge compliance	§ 2.1053	§ 22.917	§ 24.238	§ 27.53	Band edge compliance	4.9	5.5	6.5	6.5

*) Receivers which are part of Transceivers are exempted with respect to Notice 2012-DRS0126.

6 Index

1	Administrative Data	2
1.1	Project Data	2
1.2	Applicant Data	2
1.3	Test Laboratory Data	2
1.4	Signature of the Testing Responsible	2
1.5	Signature of the Accreditation Responsible	3
2	Test Object Data	3
2.1	General OUT Description	3
2.2	Detailed Description of OUT Samples	4
2.3	OUT Features	4
2.4	Auxiliary Equipment	5
2.5	Setups used for Testing	5
3	Results	5
3.1	General	5
3.2	List of the Applicable Body	6
3.3	List of Test Specification	6
3.4	Summary	7
3.5	Detailed Results	9
3.5.1	22.1 RF Power Output §2.1046, §22.913	9
3.5.2	22.2 Frequency stability §2.1055	17
3.5.3	22.3 Spurious emissions at antenna terminals §2.1051, §22.917	20
3.5.4	22.4 Field strength of spurious radiation §2.1053, §22.917	25
3.5.5	22.5 Emission and Occupied Bandwidth §2.1049, §22.917	27
3.5.6	22.6 Band edge compliance §2.1053, §22.917	36
3.5.7	24.1 RF Power Output §2.1046, §24.232	46
3.5.8	24.2 Frequency stability §2.1055, §24.235	54
3.5.9	24.3 Spurious emissions at antenna terminals §2.1051, §24.238	57
3.5.10	24.4 Field strength of spurious radiation §2.1053, §24.238	63
3.5.11	24.5 Emission and Occupied Bandwidth §2.1049, §24.238	65

3.5.12 24.6 Band edge compliance §2.1053, §24.238	74
4 Test Equipment Details	84
4.1 List of Used Test Equipment	84
5 Annex	90
5.1 Additional Information for Report	90
6 Index	103
