



**FCC 47 CFR PART 15 SUBPART C AND ANSI C63.4: 2003**

**TEST REPORT**

**For**

**Wireless-N Router w 3G+Modem & Voice**

**Model Number: Series 1098 Model 4530XY  
(X=A,B,C,D or NOTHING)  
(Y=A,B,C,D or NOTHING)**

**Brand: Zoom**

**Issued for**

**Zoom Telephonics , Inc**

207 South Street Boston , Ma 02111 USA

**Issued by**

**Compliance Certification Services Inc.**

**Tainan Lab.**

**No.8,Jiucengling, Xinhua Dist., Tainan City 712, Taiwan (R.O.C.)**

**TEL: 886-6-580-2201**

**FAX: 886-6-580-2202**

**Issued Date: August 09, 2012**



**Note:** This report shall not be reproduced except in full, without the written approval of Compliance Certification Services Inc. Ltd. This document may be altered or revised by Compliance Certification Services Inc. personnel only, and shall be noted in the revision section of the document



**REVISION HISTORY**

<b>Rev.</b>	<b>Issue Date</b>	<b>Revisions</b>	<b>Effect Page</b>	<b>Revised By</b>
00	May 09, 2012	Initial Issue	ALL	Sunny Chang
01	August 09, 2012	Add co-locating mode	Page 32	Sunny Chang



**TABLE OF CONTENTS**

**1. TEST REPORT CERTIFICATION ..... 4**

**2. EUT DESCRIPTION ..... 5**

**3. DESCRIPTION OF TEST MODES ..... 7**

**4. TEST METHODOLOGY ..... 8**

**5. FACILITIES AND ACCREDITATIONS ..... 8**

    5.1 FACILITIES ..... 8

    5.2 EQUIPMENT ..... 8

    5.3 LABORATORY ACCREDITATIONS LISTINGS ..... 8

    5.4 TABLE OF ACCREDITATIONS AND LISTINGS ..... 9

**6. CALIBRATION AND UNCERTAINTY ..... 10**

    6.1 MEASURING INSTRUMENT CALIBRATION ..... 10

    6.2 MEASUREMENT UNCERTAINTY ..... 10

**7. SETUP OF EQUIPMENT UNDER TEST ..... 11**

    7.1 SETUP CONFIGURATION OF EUT ..... 11

    7.2 SUPPORT EQUIPMENT ..... 12

    7.3 EUT OPERATING CONDITION ..... 13

**8. APPLICABLE LIMITS AND TEST RESULTS ..... 14**

    8.1 6DB BANDWIDTH ..... 14

    8.2 MAXIMUM PEAK OUTPUT POWER ..... 25

    8.3 MAXIMUM PERMISSIBLE EXPOSURE ..... 30

    8.4 POWER SPECTRAL DENSITY ..... 33

    8.5 CONDUCTED SPURIOUS EMISSION ..... 43

    8.6 RADIATED EMISSIONS ..... 56

    8.7 POWERLINE CONDUCTED EMISSIONS ..... 89

**9. ANTENNA REQUIREMENT ..... 95**

    9.1 STANDARD APPLICABLE ..... 95

    9.2 ANTENNA CONNECTED CONSTRUCTION ..... 95

**APPENDIX I SETUP PHOTOS ..... 96**

**APPENDIX II PHOTOGRAPHS OF EUT ..... A1**



# 1. TEST REPORT CERTIFICATION

**Applicant** : Zoom Telephonics , Inc  
**Address** : 207 South Street Boston , Ma 02111 USA  
**Equipment Under Test** : Wireless-N Router w 3G+Modem & Voice  
**Model Number** : Series 1098 Model 4530XY  
 (X=A,B,C,D or NOTHING)  
 (Y=A,B,C,D or NOTHING)  
**Brand Name** : Zoom  
**Date of Test** : March 19, 2012 ~ May 03, 2012

APPLICABLE STANDARD	
STANDARD	TEST RESULT
FCC Part 15 Subpart C AND ANSI C63.4 : 2003	No non-compliance noted

Approved by:

Reviewed by:

**Jeter Wu**  
Assistant Manager

**Eric Huang**  
Assistant Section Manager



## 2. EUT DESCRIPTION

<b>Product Name</b>	Wireless-N Router w 3G+Modem & Voice
<b>Model Number</b>	Series 1098 Model 4530XY (X=A,B,C,D or NOTHING) (Y=A,B,C,D or NOTHING)
<b>Brand Name</b>	Zoom
<b>Received Date</b>	March 19, 2012
<b>Frequency Range</b>	IEEE 802.11b/g, 802.11n HT20 (DTS Band):2412MHz~2462MHz IEEE 802.11n HT40 (DTS Band):2422MHz~2452MHz
<b>Transmit Power</b>	IEEE 802.11b Mode :17.74dBm (DTS Band) (59.43 mW) IEEE 802.11g Mode : 24.60dBm (DTS Band) (288.4 mW) IEEE 802.11n HT20 Mode : 24.79dBm (DTS Band) (301.3 mW) IEEE 802.11n HT40 Mode :24.76dBm (DTS Band) (299.2 mW)
<b>Channel Spacing</b>	IEEE 802.11b/g, 802.11n HT20/HT40: 5MHz
<b>Channel Number</b>	IEEE 802.11b/g, 802.11n HT20:11 Channels IEEE 802.11n HT40 :7 Channels
<b>Transmit Data Rate</b>	IEEE 802.11b : 11, 5.5, 2, 1 Mbps IEEE 802.11g : 54, 48, 36, 24, 18, 12, 9, 6 Mbps IEEE 802.11n HT20 : 65, 58.5, 52, 39, 26, 19.5, 13, 6.5 Mbps IEEE 802.11n HT40 : 150, 135, 121.5, 108, 81, 54, 40.5, 27, 13.5 Mbps
<b>Type of Modulation</b>	IEEE 802.11b : DSSS (CCK, DQPSK, DBPSK)
	IEEE 802.11g : OFDM (64QAM, 16QAM, QPSK, BPSK)
	IEEE 802.11n HT20/40 : OFDM (64QAM, 16QAM, QPSK, BPSK)
<b>Frequency Selection</b>	By software / firmware
<b>Antenna Type</b>	<b>Antenna *3</b> <b>3G Antenna*2 (1TX2RX)</b> 1. Dipole Antenna 3.1dBi (1TX1RX) 2. PCB Antenna 0dBi (1RX) <b>2.4G Antenna*1 (1TX1RX)</b> 1. PCB Antenna 3.79dBi (1TX1RX)
<b>Power Source</b>	<b>Powered from Adapter</b> <b>Adapter 1</b> Brand: AMIGO Model: AMS9-1201000FU2 Input: 100-240Vac, 50/60Hz, 0.5A Output: 12Vdc, 1.0A <b>Adapter 2</b> Brand: CWT Model: CAP012121 Input: 100-240Vac, 47-63Hz, 0.35A Output: 12Vdc, 1.0A
<b>Temperature Range</b>	0 ~ +40°C



- REMARK:**
1. The sample selected for test was engineering sample that approximated to production product and was provided by manufacturer.
  2. This submittal(s) (test report) is intended for FCC ID: **BDNWL1098** filing to comply with Section 15.207, 15.209 and 15.247 of the FCC Part 15, Subpart C Rules.
  3. For more details, please refer to the user manual.



### 3. DESCRIPTION OF TEST MODES

The EUT is a Wireless-N Router w 3G+Modem & Voice.

The RF chipset is manufactured by Ralink technology, corp.

The antenna peak gain 3.79dBi (highest gain) were chosen for full testing.

#### IEEE 802.11 b ,802.11g ,802.11n HT20 mode (DTS Band)

The EUT had been tested under operating condition.

There are three channels have been tested as following:

Channel	Frequency (MHz)
Low	2412
Middle	2437
High	2462

IEEE 802.11b mode: 1Mbps long data rates (worst case) were chosen for full testing.

IEEE 802.11g mode: 6Mbps data rates (worst case) were chosen for full testing.

IEEE 802.11n HT20 mode: 6.5Mbps data rates (worst case) were chosen for full testing.

#### IEEE 802.11n HT40 mode (DTS Band)

The EUT had been tested under operating condition.

There are three channels have been tested as following:

Channel	Frequency (MHz)
Low	2422
Middle	2437
High	2452

IEEE 802.11n HT40 mode: 13.5Mbps data rates (worst case) were chosen for full testing.

The worst-case data rates are determined according to the description above, based on the investigations by measuring the PSD, peak power and average power across all the data rates, bandwidths, modulations and spatial stream modes.



## 4. TEST METHODOLOGY

The tests documented in this report were performed in accordance with ANSI C63.4 and FCC CFR 47 15.207, 15.209 and 15.247 and KDB 558074..

## 5. FACILITIES AND ACCREDITATIONS

### 5.1 FACILITIES

All measurement facilities used to collect the measurement data are located at No.8, Jiucengling, Xinhua Dist., Tainan City 712, Taiwan (R.O.C.)

The sites are constructed in conformance with the requirements of ANSI C63.7:1992, ANSI C63.4: 2003 and CISPR Publication 22.

### 5.2 EQUIPMENT

Radiated emissions are measured with one or more of the following types of linearly polarized antennas: tuned dipole, biconical, log periodic, bi-log, and/or ridged waveguide, horn. Spectrum analyzers with preselectors and quasi-peak detectors are used to perform radiated measurements.

Conducted emissions are measured with Line Impedance Stabilization Networks and EMI Test Receivers.

Calibrated wideband preamplifiers, coaxial cables, and coaxial attenuators are also used for making measurements.

All receiving equipment conforms to CISPR Publication 16-1, "Radio Interference Measuring Apparatus and Measurement Methods."

### 5.3 LABORATORY ACCREDITATIONS LISTINGS

The test facilities used to perform radiated and conducted emissions tests are accredited by Taiwan Accreditation Foundation for the specific scope of accreditation under Lab Code: 1109 to perform Electromagnetic Interference tests according to FCC PART 15 AND CISPR 22 requirements. No part of this report may be used to claim or imply product endorsement by TAF or any agency of the Government. In addition, the test facilities are listed with Federal Communications Commission (registration no: TW-1037 and 455173).





## 5.4 TABLE OF ACCREDITATIONS AND LISTINGS

Our laboratories are accredited and approved by the following accreditation body according to ISO/IEC 17025.

<b>Taiwan</b>	<b>TAF</b>
---------------	------------

The measuring facility of laboratories has been authorized or registered by the following approval agencies.

<b>Canada</b>	<b>Industry Canada</b>
<b>Germany</b>	<b>TUV NORD</b>
<b>Taiwan</b>	<b>BSMI</b>
<b>USA</b>	<b>FCC</b>

Copies of granted accreditation certificates are available for downloading from our web site, <http://www.ccsrf.com>



## 6. CALIBRATION AND UNCERTAINTY

### 6.1 MEASURING INSTRUMENT CALIBRATION

The measuring equipment utilized to perform the tests documented in this report has been calibrated in accordance with the manufacturer’s recommendations, and is traceable to recognized national standards.

### 6.2 MEASUREMENT UNCERTAINTY

Where relevant, the following measurement uncertainty levels have been estimated for tests performed on the apparatus:

PARAMETER	UNCERTAINTY
Radiated Emission, 30 to 200 MHz Test Site : OATS-6	±3.59dB
Radiated Emission, 200 to 1000 MHz Test Site : OATS-6	±3.27dB
Radiated Emission, 1 to 26.5 GHz	± 3.20dB
Power Line Conducted Emission	± 2.90dB

This measurement uncertainty is confidence of approximately 95%, k=2



## 7. SETUP OF EQUIPMENT UNDER TEST

### 7.1 SETUP CONFIGURATION OF EUT

#### RF Test Setup:

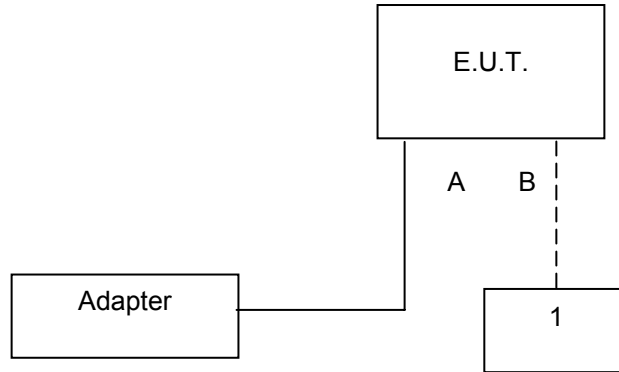

#### EMI Test Setup:

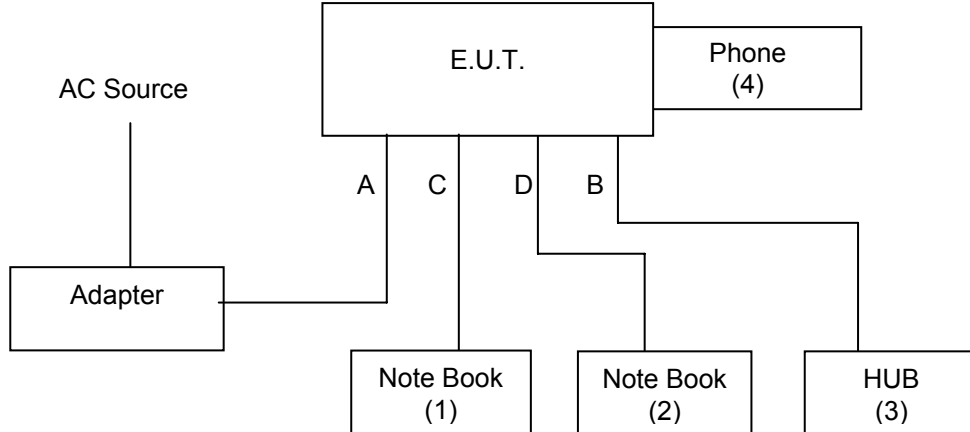



### 7.2 SUPPORT EQUIPMENT

#### RF test

No.	Product	Manufacturer	Model No.	Certify No.	Signal cable
1.	Note Book	IBM	T43	DoC	Power cable, unshd, 1.6m

No.	Signal cable description	
A	DC Power	Unshielded, 1.5m, 1pcs.
B	LAN	Unshielded, 10m, 1pcs.

#### EMI test

No.	Product	Manufacturer	Model No.	Certify No.	Signal cable
1.	Note Book	IBM	R51	R33026	Power cable, unshd, 1.6m
2.	Note Book	IBM	T43	DoC	Power cable, unshd, 1.6m
3.	HUB	BARRICAD	SMC7008B R	DoC	Power cable, unshd, 1.6m
4.	PHONE	B.A.S.S	B5-101	DoC	Power cable, unshd, 1.6m

No.	Signal cable description	
A	DC Power	Unshielded, 1.6m, 1pcs.
B	LAN	Unshielded, 3m, 3pcs.
C	LAN	Unshielded, 10m, 1pcs.
D	LAN	Unshielded, 10m, 1pcs.

#### REMARK:

- 1.All the above equipment/cables were placed in worse case positions to maximize emission signals during emission test.
2. Grounding was established in accordance with the manufacturer’s requirements and conditions for the intended use.



## 7.3 EUT OPERATING CONDITION

### RF Setup

1. Set up all computers like the setup diagram.
2. The "Ralink QA Test Program for RT5350QA" software was used for testing  
The EUT driver software installed in the host support equipment during testing was Ralink QA Test Program for RT5350QA Drive

### **TX Mode:**

- ⇒ **Tx Mode: CCK 、 OFDM 、 HT MixMode** (Bandwidth: 20 、 40)
- ⇒ **Tx Data Rate: 1Mbps long** (IEEE 802.11b mode , TX)  
**6Mbps** (IEEE 802.11g mode , TX)  
**6.5Mbps** (IEEE 802.11n HT20 mode , chain 0 TX)  
**13.5Mbps** (IEEE 802.11n HT40 mode, chain 0 TX)

### **Power control mode**

- Target Power:** IEEE 802.11b Channel Low (2412MHz) = 13  
IEEE 802.11b Channel Middle (2437MHz) = 14  
IEEE 802.11b Channel High (2462MHz) = 15
- Target Power:** IEEE 802.11g Channel Low (2412MHz) = 12  
IEEE 802.11g Channel Middle (2437MHz) = 14  
IEEE 802.11g Channel High (2462MHz) = 12
- Target Power:** IEEE 802.11n HT20 Channel Low (2412MHz) = 11 (**Chain 0**)  
IEEE 802.11 n HT20 Channel Middle (2437MHz) = 14 (**Chain 0**)  
IEEE 802.11 n HT20 Channel High (2462MHz) = 12 (**Chain 0**)
- Target Power:** IEEE 802.11n HT40 Channel Low (2422MHz) = 09 (**Chain 0**)  
IEEE 802.11 n HT40 Channel Middle (2437MHz) = 14 (**Chain 0**)  
IEEE 802.11 n HT40 Channel High (2452MHz) = 09 (**Chain 0**)

### (2) **RX Mode :**

- MAC Address: FFFFFFFF**
- Start RX**

3. All of the function are under run.
4. Start test.

### **Normal Link Setup**

1. Set up all computers like the setup diagram.
2. All of the function are under run.
3. Notebook PC (2) ping 192.168.0.10 -t to Notebook PC (1).
4. Notebook PC (1) ping 192.168.0.20 -t to Notebook PC (2).
5. Notebook PC (1) ping 192.168.0.50 -t to Wireless Access Point (3).

Start test.



## 8. APPLICABLE LIMITS AND TEST RESULTS

### 8.1 6DB BANDWIDTH

#### LIMIT

§ 15.207(a) (2) For direct sequence systems, the minimum 6dB bandwidth shall be at least 500kHz

#### TEST EQUIPMENTS

Name of Equipment	Manufacturer	Model	Serial Number	Calibration Due
Spectrum Analyzer	R&S	FSEK 30	835253/002	SEP. 29, 2012

#### TEST SETUP

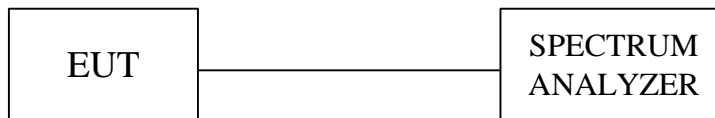

#### TEST PROCEDURE

The transmitter output was connected to a spectrum analyzer. The bandwidth of the fundamental frequency was measured by spectrum analyzer with 100 KHz RBW and 100 KHz VBW. The 6dB bandwidth is defined as the total spectrum the power of which is higher than peak power minus 6dB.



**TEST RESULTS**

No non-compliance noted.

**IEEE 802.11b mode**

Channel	Channel Frequency (MHz)	6dB Bandwidth (kHz)	Minimum Limit (kHz)	Pass / Fail
Low	2412	12224.45	500	PASS
Middle	2437	12224.45	500	PASS
High	2462	12224.45	500	PASS

**NOTE :**

1. At final test to get the worst-case emission at 1Mbps long.
2. The cable assembly insertion loss of 11.7dB (including 10 dB pad and 1.7 dB cable) was entered as an offset in the spectrum analyzer to allow for direct reading of power.

**IEEE 802.11g mode**

Channel	Channel Frequency (MHz)	6dB Bandwidth (kHz)	Minimum Limit (kHz)	Pass / Fail
Low	2412	16633.27	500	PASS
Middle	2437	16633.27	500	PASS
High	2462	16633.27	500	PASS

**NOTE :**

1. At final test to get the worst-case emission at 6Mbps.
2. The cable assembly insertion loss of 11.7dB (including 10 dB pad and 1.7 dB cable) was entered as an offset in the spectrum analyzer to allow for direct reading of power.



**IEEE 802.11n HT20 mode**

Channel	Channel Frequency (MHz)	6dB Bandwidth (kHz)	Minimum Limit (kHz)	Pass / Fail
Low	2412	17735.47	500	PASS
Middle	2437	17735.47	500	PASS
High	2462	17735.47	500	PASS

**NOTE :**

1. At final test to get the worst-case emission at 6.5Mbps.
2. The cable assembly insertion loss of 11.7dB (including 10 dB pad and 1.7 dB cable) was entered as an offset in the spectrum analyzer to allow for direct reading of power.

**IEEE 802.11n HT40 mode**

Channel	Channel Frequency (MHz)	6dB Bandwidth (kHz)	Minimum Limit (kHz)	Pass / Fail
Low	2422	36472.95	500	PASS
Middle	2437	36272.55	500	PASS
High	2452	36472.95	500	PASS

**NOTE :**

1. At final test to get the worst-case emission at 13.5Mbps.
2. The cable assembly insertion loss of 11.7dB (including 10 dB pad and 1.7 dB cable) was entered as an offset in the spectrum analyzer to allow for direct reading of power.





**6dB BANDWIDTH ( 802.11b MODE)**

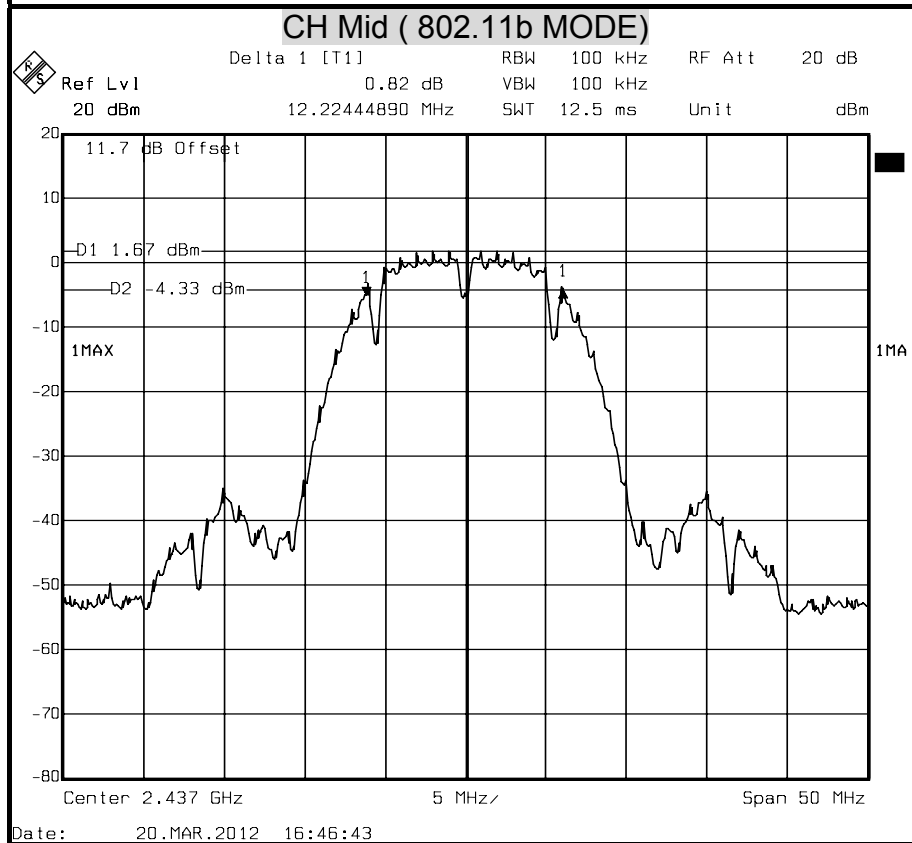
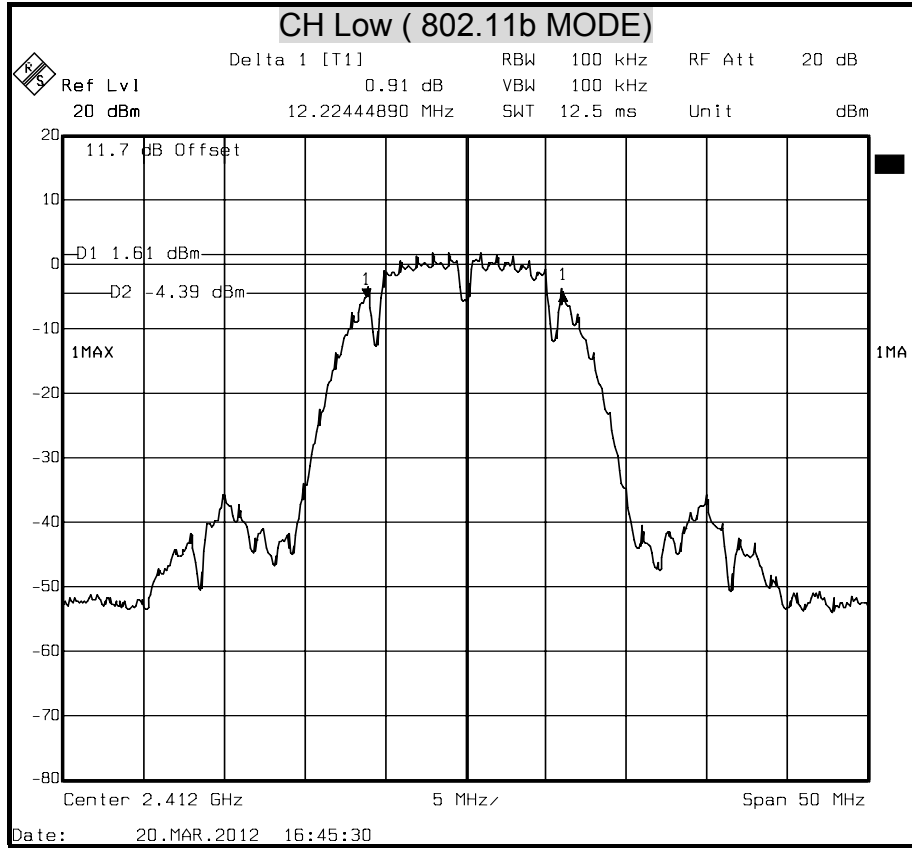

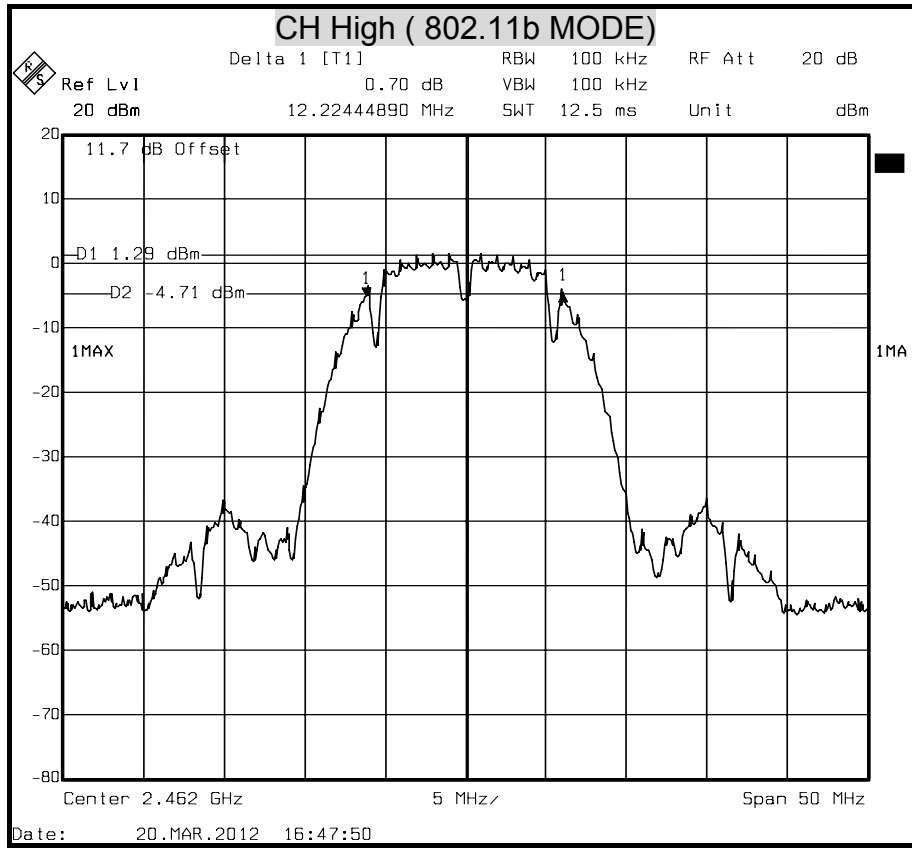



**6dB BANDWIDTH ( 802.11g MODE)**

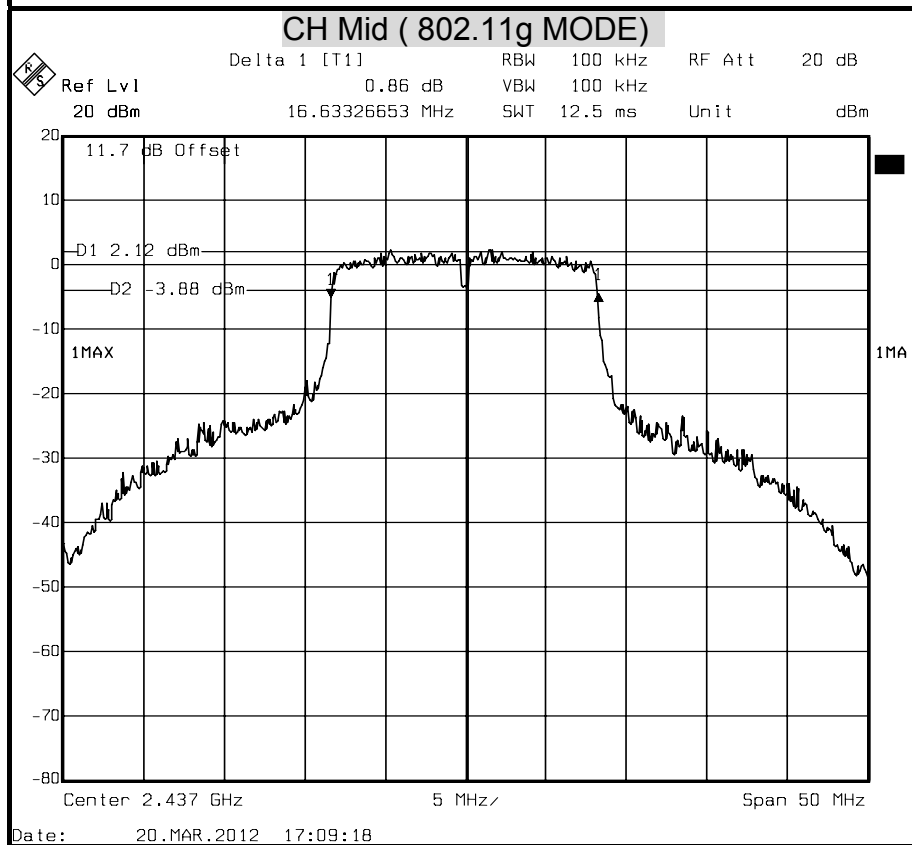
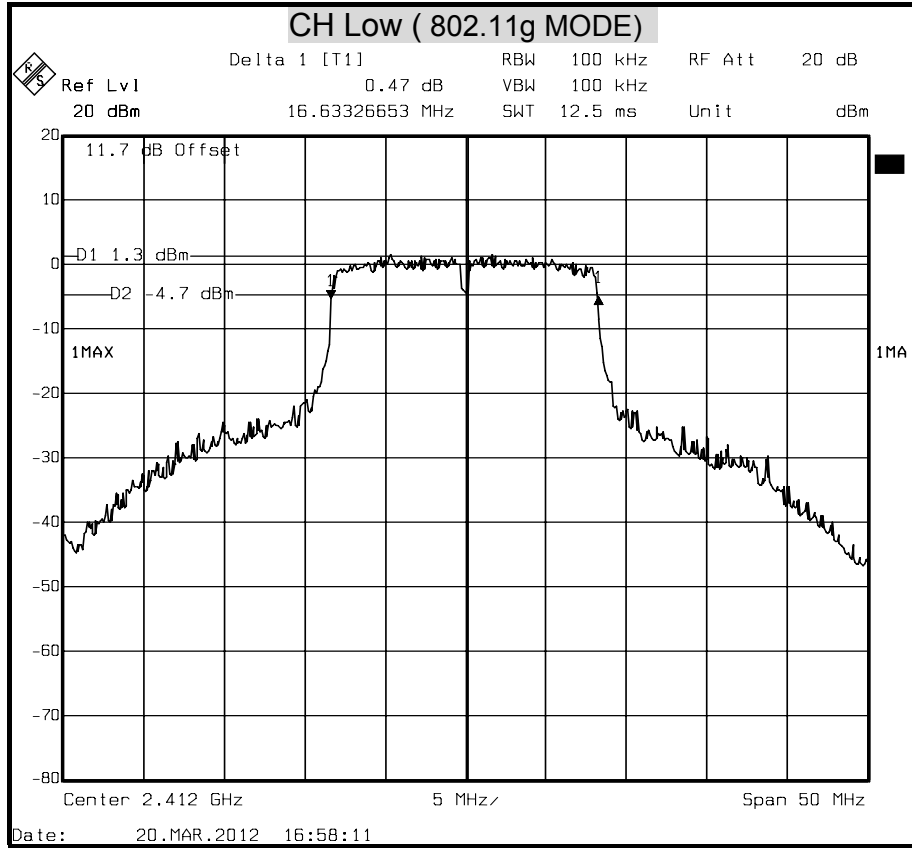

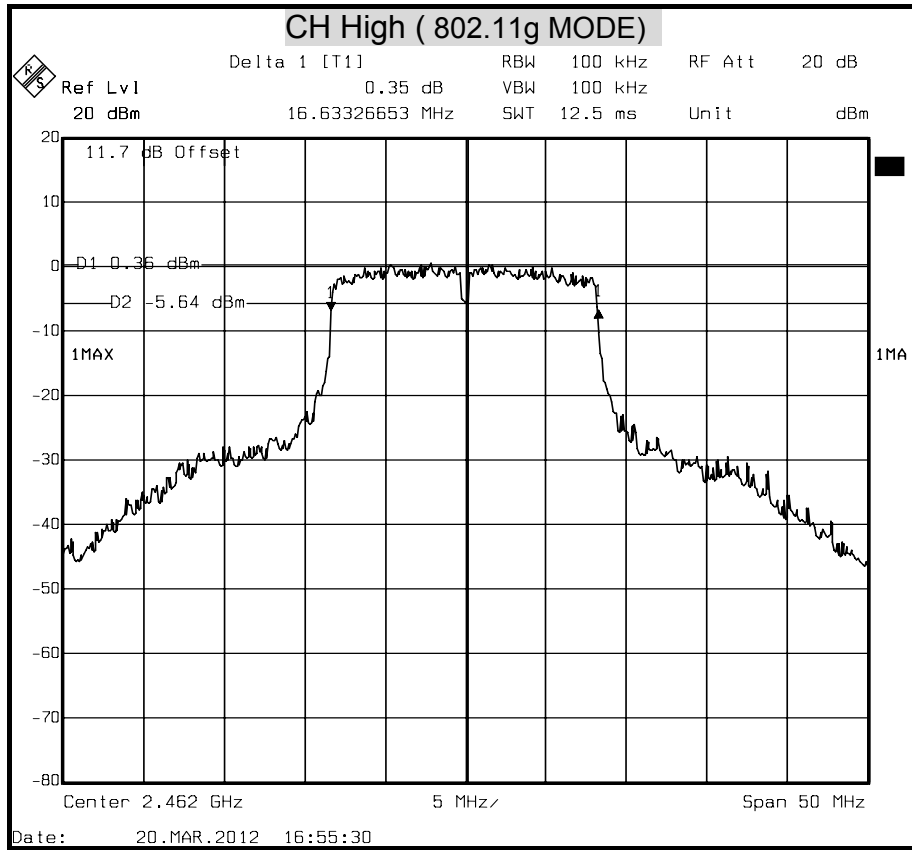



**6dB BANDWIDTH ( 802.11n HT20 MODE)**

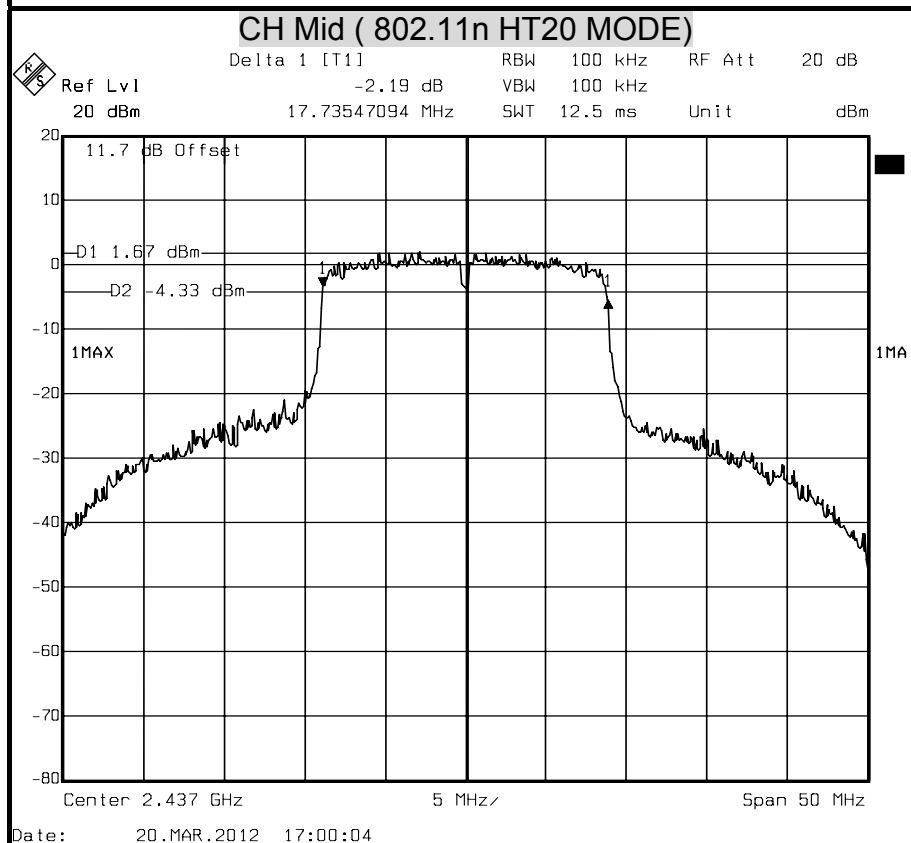
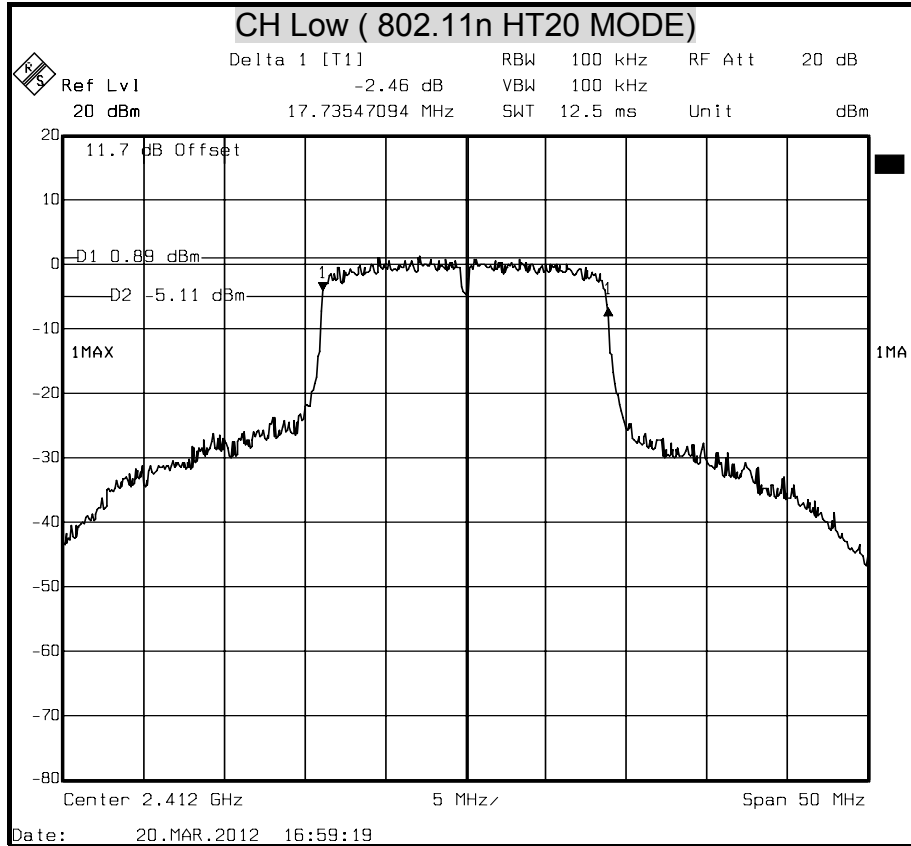

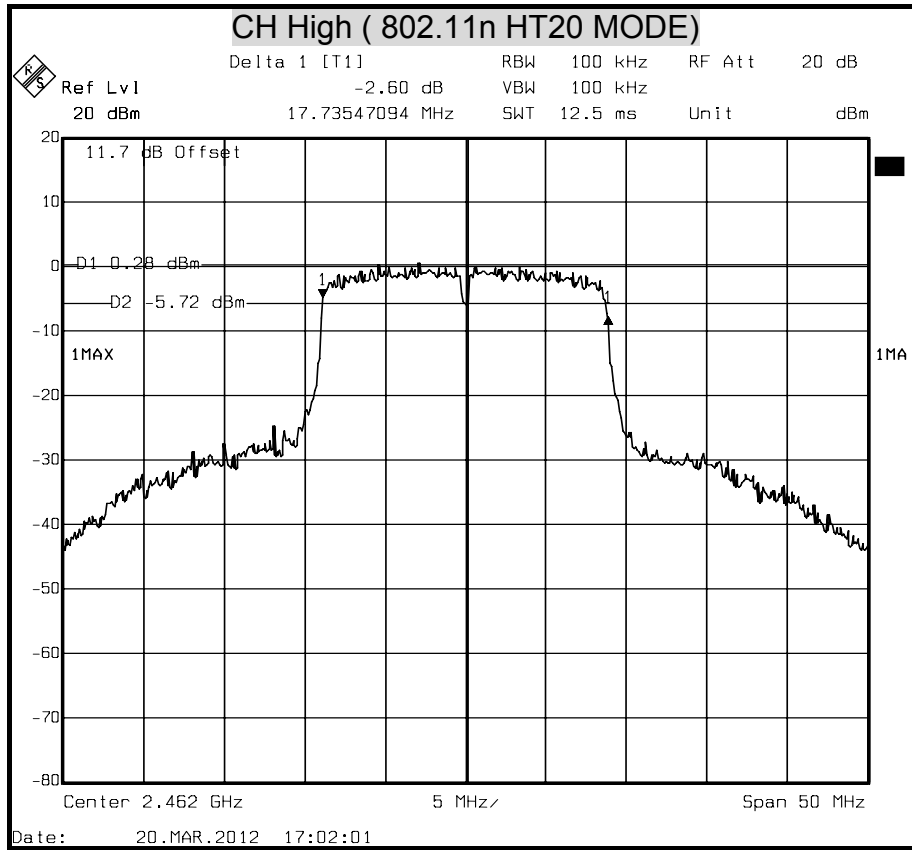



### 6dB BANDWIDTH ( 802.11n HT40 MODE)

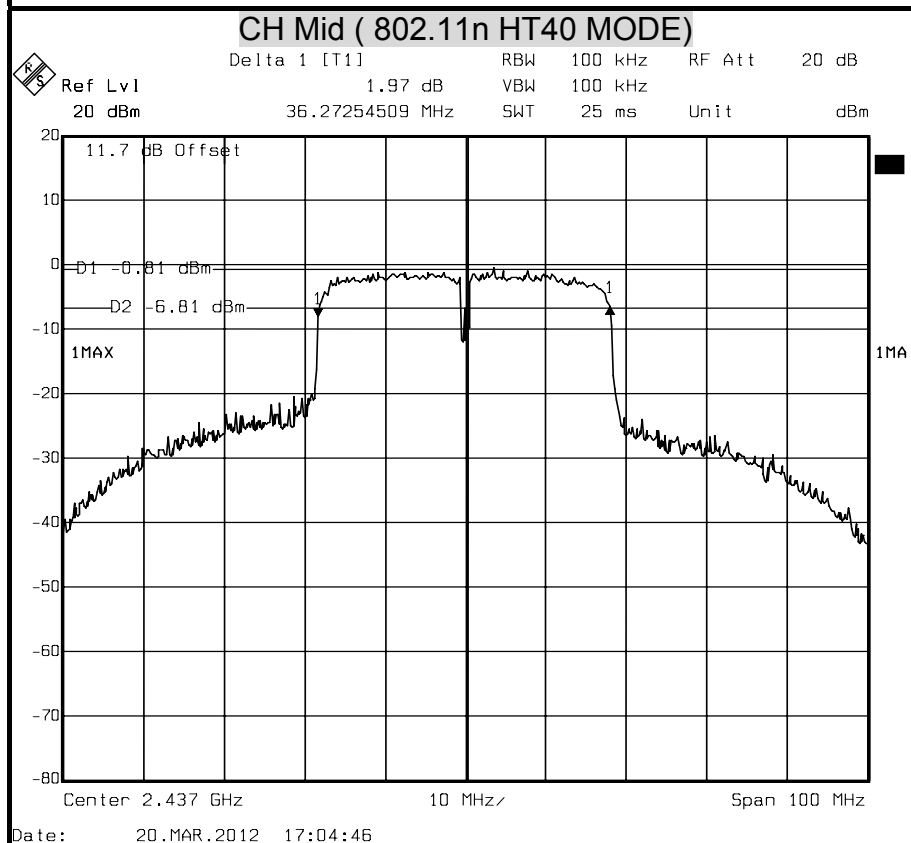
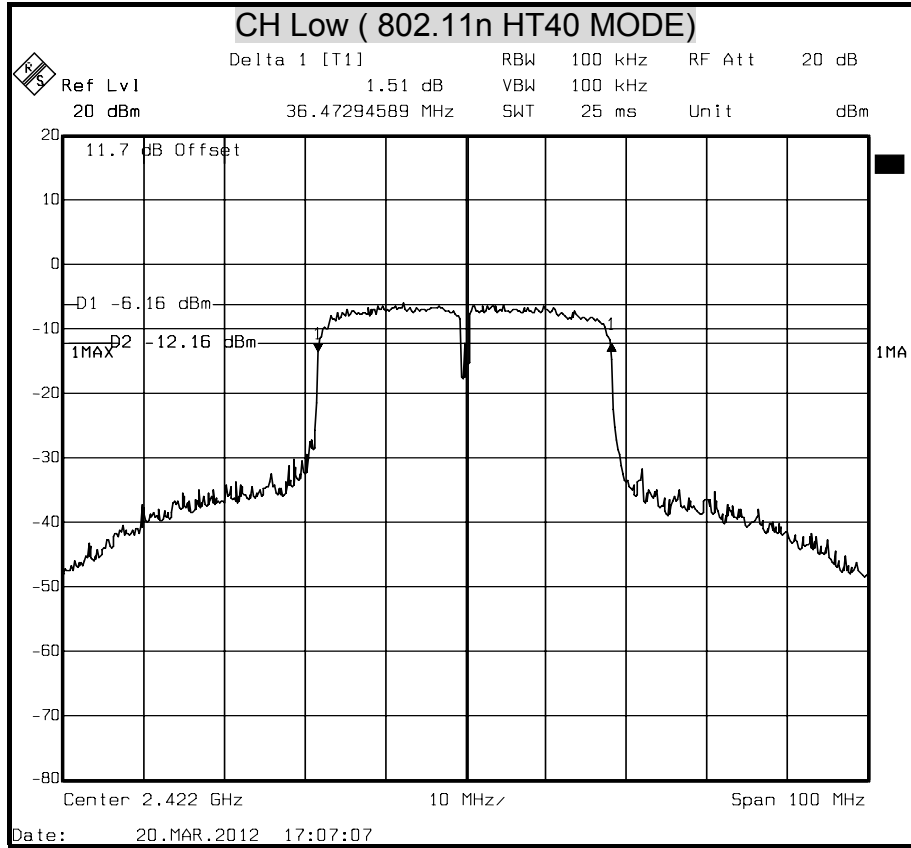

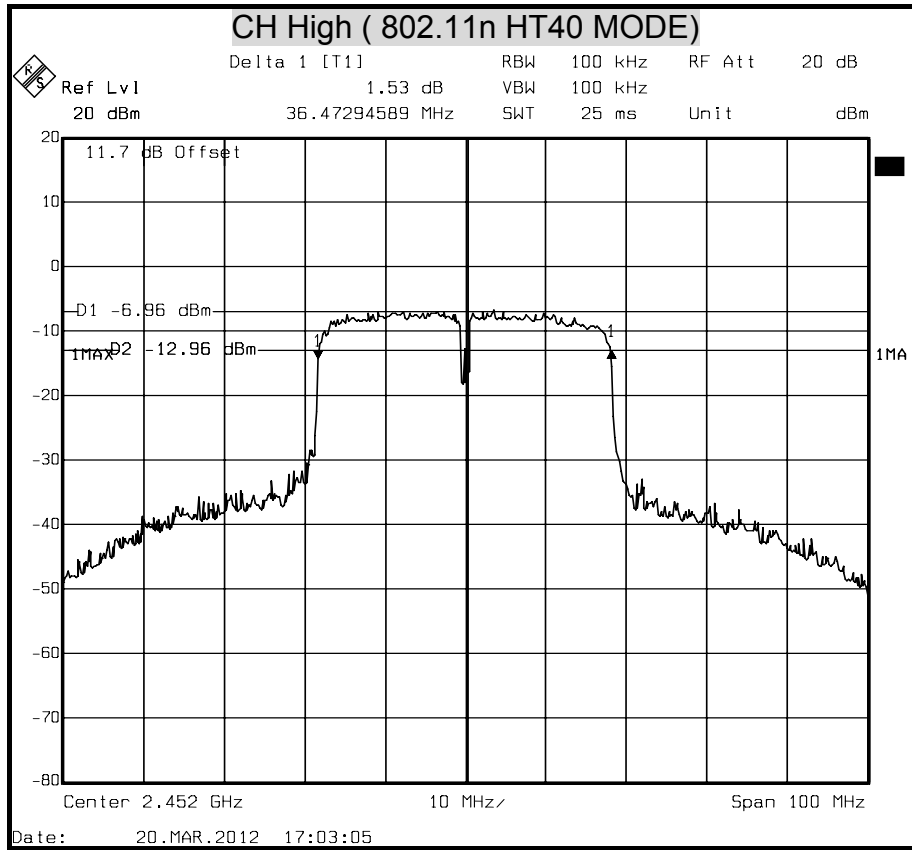





## 8.2 MAXIMUM PEAK OUTPUT POWER

### LIMIT

§ 15.247(b) The maximum peak output power of the intentional radiator shall not exceed the following :

§ 15.247(b) (3) For systems using digital modulation in the 902-928 MHz, 2400-2483.5 MHz, and 5725-5850 MHz bands : 1 watt.

§ 15.247(b) (4) Except as shown in paragraphs (c) of this section , if transmitting antennas of directional gain greater than 6 dBi are used the peak output power from the intentional radiator shall be reduced below the stated values in paragraphs (b)(1) or (b)(2), and (b)(3) of this section , as appropriate, by the amount in dB that the directional gain of the antenna exceeds 6 dBi.

### TEST EQUIPMENTS

Name of Equipment	Manufacturer	Model	Serial Number	Calibration Due
Spectrum Analyzer	R&S	FSEK 30	835253/002	SEP. 29, 2012

*Remark: Each piece of equipment is scheduled for calibration once a year.*

### TEST SETUP

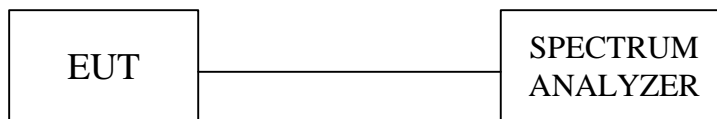



## **TEST PROCEDURE**

The tests were performed in accordance with KDB 558074 5.2.1.2 and 5.2.2.1.

### **5.2.1.2 Measurement Procedure PK2:**

- 1.This procedure provides an integrated measurement alternative when the maximum available RBW < EBW.
- 2.Set the RBW = 1 MHz.
- 3.Set the VBW = 3 MHz.
- 4.Set the span to a value that is 5-30 % greater than the EBW.
- 5.Detector = peak.
- 6.Sweep time = auto couple.
- 7.Trace mode = max hold.
- 8.Allow trace to fully stabilize.
- 9.Use the spectrum analyzer's integrated band power measurement function with band limits set equal to the EBW band edges(for some analyzers, this may require a manual override to ensure use of peak detector). If the spectrum analyzer does not have a band power function, sum the spectrum levels (in linear power units) at 1 MHz intervals extending across the EBW of the spectrum.

### **5.2.2.1 Measurement Procedure AVG1(power averaging over the EBW with slow sweep speed):**

- 1.Set the analyzer span to 5-30% greater than the EBW.
- 2.Set the RBW = 1 MHz.
- 3.Set the VBW  $\geq$  3 MHz.
- 4.Detector = power average (RMS).
- 5.Ensure that the number of measurement points in the sweep  $\geq$  2 x (span/RBW).
- 6.Manually set the sweep time to:  $\geq$ 10 x (number of measurement points in sweep) x (transmission symbol period).
- 7.Perform the measurement over a single sweep.
- 8.Use the spectrum analyzer's integrated band power measurement function with band limits set equal to the EBW band edges to determine the maximum conducted output power of the EUT over the EBW. Note: If the analyzer does not have a band power function, sum the spectral levels (in linear power units) at 1 MHz intervals extending across the entire EBW.

## **TEST RESULTS**

No non-compliance noted



**IEEE 802.11b mode**

Channel	Channel Frequency (MHz)	Peak Power (dBm)	Peak Power Limit (dBm)	Pass / Fail
Low	2412	17.27	30	PASS
Middle	2437	17.74	30	PASS
High	2462	17.43	30	PASS

**NOTE :** 1. At final test to get the worst-case emission at 1Mbps long.  
2. The cable assembly insertion loss of 11.7dB (including 10 dB pad and 1.7 dB cable) was entered as an offset in the power meter to allow for direct reading of power.

**IEEE 802.11g mode**

Channel	Channel Frequency (MHz)	Peak Power (dBm)	Peak Power Limit (dBm)	Pass / Fail
Low	2412	23.80	30	PASS
Middle	2437	24.60	30	PASS
High	2462	22.79	30	PASS

**NOTE :** 1. At final test to get the worst-case emission at 6Mbps.  
2. The cable assembly insertion loss of 11.7dB (including 10 dB pad and 1.7 dB cable) was entered as an offset in the power meter to allow for direct reading of power.



**IEEE 802.11n HT20 mode**

Channel	Channel Frequency (MHz)	Peak Power (dBm)	Peak Power Limit (dBm)	Pass / Fail
Low	2412	23.43	30	PASS
Middle	2437	24.79	30	PASS
High	2462	22.91	30	PASS

**NOTE :** 1. At final test to get the worst-case emission at 6.5Mbps.  
2. The cable assembly insertion loss of 11.7dB (including 10 dB pad and 1.7 dB cable) was entered as an offset in the power meter to allow for direct reading of power.

**IEEE 802.11n HT40 mode**

Channel	Channel Frequency (MHz)	Peak Power (dBm)	Peak Power Limit (dBm)	Pass / Fail
Low	2422	19.77	30	PASS
Middle	2437	24.76	30	PASS
High	2452	18.84	30	PASS

**NOTE :** 1. At final test to get the worst-case emission at 13.5Mbps.  
2. The cable assembly insertion loss of 11.7dB (including 10 dB pad and 1.7 dB cable) was entered as an offset in the power meter to allow for direct reading of power.



**Average Power Data  
IEEE 802.11b mode**

Channel	Channel Frequency (MHz)	Average Power (dBm)
Low	2412	14.25
Middle	2437	14.67
High	2462	14.33

**IEEE 802.11g mode**

Channel	Channel Frequency (MHz)	Average Power (dBm)
Low	2412	16.89
Middle	2437	17.68
High	2462	15.93

**IEEE 802.11n HT20 mode**

Channel	Channel Frequency (MHz)	Average Power (dBm)
Low	2412	16.38
Middle	2437	17.70
High	2462	16.09

**IEEE 802.11n HT40 mode**

Channel	Channel Frequency (MHz)	Average Power (dBm)
Low	2422	12.58
Middle	2437	17.92
High	2452	11.93



### 8.3 MAXIMUM PERMISSIBLE EXPOSURE

According to FCC 1.1310 : The criteria listed in the following table shall be used to evaluate the environment impact of human exposure to radio frequency (RF) radiation as specified in 1.1307(b) LIMITS FOR MAXIMUM PERMISSIBLE EXPOSURE (MPE)

Frequency Range (MHz)	Electric Field Strength (V/m)	Magnetic Field Strength (A/m)	Power Density (mW/cm <sup>2</sup> )	Average Time
(A) Limits for Occupational / Control Exposures				
300-1,500	--	--	F/300	6
1,500-100,000	--	--	5	6
(B) Limits for General Population / Uncontrol Exposures				
300-1,500	--	--	F/1500	6
1,500-100,000	--	--	1	30

### CALCULATIONS

Given  $E = \frac{\sqrt{30 \times P \times G}}{d}$  &  $S = \frac{E^2}{3770}$

Where  $E$  = Field strength in Volts / meter

$P$  = Power in Watts

$G$  = Numeric antenna gain

$d$  = Distance in meters

$S$  = Power density in milliwatts / square centimeter

Combining equations and re-arranging the terms to express the distance as a function of the remaining variables yields:

$$S = \frac{30 \times P \times G}{3770d^2}$$

Changing to units of mW and cm, using:

$$P \text{ (mW)} = P \text{ (W)} / 1000 \text{ and}$$

$$d \text{ (cm)} = d \text{ (m)} / 100$$

Yields

$$S = \frac{30 \times (P/1000) \times G}{3770 \times (d/100)^2} = 0.0796 \times \frac{P \times G}{d^2}$$

Where  $d$  = Distance in cm

$P$  = Power in mW

$G$  = Numeric antenna gain

$S$  = Power density in mW / cm<sup>2</sup>



**LIMIT**

Power Density Limit, S=1.0mW/cm<sup>2</sup>

**TEST RESULTS**

No non-compliance noted.

$$S = \frac{30 \times (P/1000) \times G}{3770 \times (d/100)^2} = 0.0796 \times \frac{P \times G}{d^2}$$

G=3.79dBi=2.393316 mW

- IEEE 802.11b = 0.0796 \* 59.4292 \* 2.39331576 ÷ 400 = 0.0283
- IEEE 802.11g = 0.0796 \* 288.4032 \* 2.39331576 ÷ 400 = 0.13736
- IEEE 802.11n HT20 = 0.0796 \* 301.3006 \* 2.39331576 ÷ 400 = 0.1435
- IEEE 802.11n HT40 = 0.0796 \* 299.2265 \* 2.39331576 ÷ 400 = 0.14251

Mode	Minimum separation distance (cm)	Output Power (dBm)	Output Power (mw)	Antenna Gain (dBi)	Power Density Limit (mW/cm <sup>2</sup> )	Power Density at 20cm (mW/cm <sup>2</sup> )
IEEE 802.11b	20	17.74	59.43	3.79	1.00	0.028304
IEEE 802.11g	20	24.60	288.40	3.79	1.00	0.137358
IEEE 802.11n HT20	20	24.79	301.30	3.79	1.00	0.143500
IEEE 802.11n HT40	20	24.76	299.23	3.79	1.00	0.142513

**REMARK:** For mobile or fixed location transmitters, the maximum power density is 1.0 mW/cm<sup>2</sup> even if the calculation indicates that the power density would be larger.



**Co-Location Mode**

WWAN MPE

Channel NO	Channel Frequency (MHz)	Output Power (mW)	Antenna Gain (dBi)	Antenna Gain (mW)	Power Density (S) (mW/cm2)	Limit of Power Density (S) (mW/cm2)
189	836.4	1729.82	1.21	1.32	0.4548	0.558
661	1880	993.12	2	1.59	0.3132	1

Collocated MPE Calculations

WLAN Band	(WLAN Pd)/(MPE Limit)	(WWAN 850MHz)/(MPE Limit)	(850 MHz WWAN fraction) + (WLAN fraction)	Limit	Pass/Fail
2412 - 2462	0.1435	0.8151	0.9586	1	Pass

WLAN Band	(WLAN Pd)/(MPE Limit)	(WWAN 1900MHz)/(MPE Limit)	(1900 MHz WWAN fraction) + (WLAN fraction)	Limit	Pass/Fail
2412 - 2462	0.1435	0.3132	0.4567	1	Pass





### 8.4 POWER SPECTRAL DENSITY

#### LIMIT

§ 15.247(e) For digitally modulated systems, the power spectral density conducted from the intentional radiator to the antenna shall not greater than 8 dBm in any 3 kHz band during any time interval of continuous transmission.

#### TEST EQUIPMENTS

Name of Equipment	Manufacturer	Model	Serial Number	Calibration Due
Spectrum Analyzer	R&S	FSEK 30	835253/002	SEP. 29, 2012

#### TEST SETUP

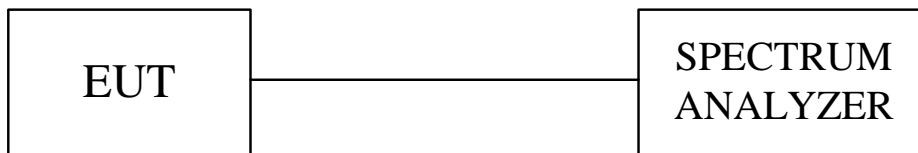

#### TEST PROCEDURE

The tests were performed in accordance with KDB 558074 5.3.1.

##### **5.3.1 Measurement Procedure PKPSD:**

1. Use this procedure when the maximum peak conducted output power in the fundamental emission is used to demonstrate compliance.
2. Set the RBW = 100 kHz.
3. Set the VBW ≥ 300 kHz.
4. Set the span to 5-30 % greater than the EBW.
5. Detector = peak.
6. Sweep time = auto couple.
7. Trace mode = max hold.
8. Allow trace to fully stabilize.
9. Use the peak marker function to determine the maximum power level in any 100 kHz band segment within the fundamental EBW.
10. Scale the observed power level to an equivalent value in 3 kHz by adjusting (reducing) the measured power by a bandwidth correction factor (BWCF) where  $BWCF = 10\log(3\text{ kHz}/100\text{ kHz} = -15.2\text{ dB})$ .
11. The resulting peak PSD level must be ≤ 8 dBm.

#### TEST RESULTS

No non-compliance noted.



**IEEE 802.11b mode**

Channel	Frequency (MHz)	Reading (dBm)	BWCF (dB)	PPSD (dBm)	Limit (dBm)	Margin (dB)	Result
Low	2412	3.28	-15.2	-11.92	8.00	-19.92	PASS
Middle	2437	3.44	-15.2	-11.76	8.00	-19.76	PASS
High	2462	3.16	-15.2	-12.04	8.00	-20.04	PASS

**NOTE :** 1. At final test to get the worst-case emission at 1Mbps long.  
 2. The cable assembly insertion loss of 11.7dB (including 10 dB pad and 1.7 dB cable) was Entered as an offset in the spectrum analyzer to allow for direct reading of power.

**IEEE 802.11g mode**

Channel	Frequency (MHz)	Reading (dBm)	BWCF (dB)	PPSD (dBm)	Limit (dBm)	Margin (dB)	Result
Low	2412	2.95	-15.2	-12.25	8.00	-20.25	PASS
Middle	2437	3.45	-15.2	-11.75	8.00	-19.75	PASS
High	2462	1.85	-15.2	-13.35	8.00	-21.35	PASS

**NOTE :** 1. At final test to get the worst-case emission at 1Mbps long.  
 2. The cable assembly insertion loss of 11.7dB (including 10 dB pad and 1.7 dB cable) was Entered as an offset in the spectrum analyzer to allow for direct reading of power.

**IEEE 802.11n HT20 mode**

Channel	Frequency (MHz)	Reading (dBm)	BWCF (dB)	PPSD (dBm)	Limit (dBm)	Margin (dB)	Result
Low	2412	2.05	-15.2	-13.15	8.00	-21.15	PASS
Middle	2437	3.26	-15.2	-11.94	8.00	-19.94	PASS
High	2462	1.23	-15.2	-13.97	8.00	-21.97	PASS

**NOTE :** 1. At final test to get the worst-case emission at 1Mbps long.  
 2. The cable assembly insertion loss of 11.7dB (including 10 dB pad and 1.7 dB cable) was Entered as an offset in the spectrum analyzer to allow for direct reading of power.

**IEEE 802.11n HT40 mode**

Channel	Frequency (MHz)	Reading (dBm)	BWCF (dB)	PPSD (dBm)	Limit (dBm)	Margin (dB)	Result
Low	2422	-4.81	-15.2	-20.01	8.00	-28.01	PASS
Middle	2437	0.39	-15.2	-14.81	8.00	-22.81	PASS
High	2452	-5.09	-15.2	-20.29	8.00	-28.29	PASS

**NOTE :** 1. At final test to get the worst-case emission at 1Mbps long.  
 2. The cable assembly insertion loss of 11.7dB (including 10 dB pad and 1.7 dB cable) was Entered as an offset in the spectrum analyzer to allow for direct reading of power.



**POWER SPECTRAL DENSITY ( IEEE 802.11b MODE)**

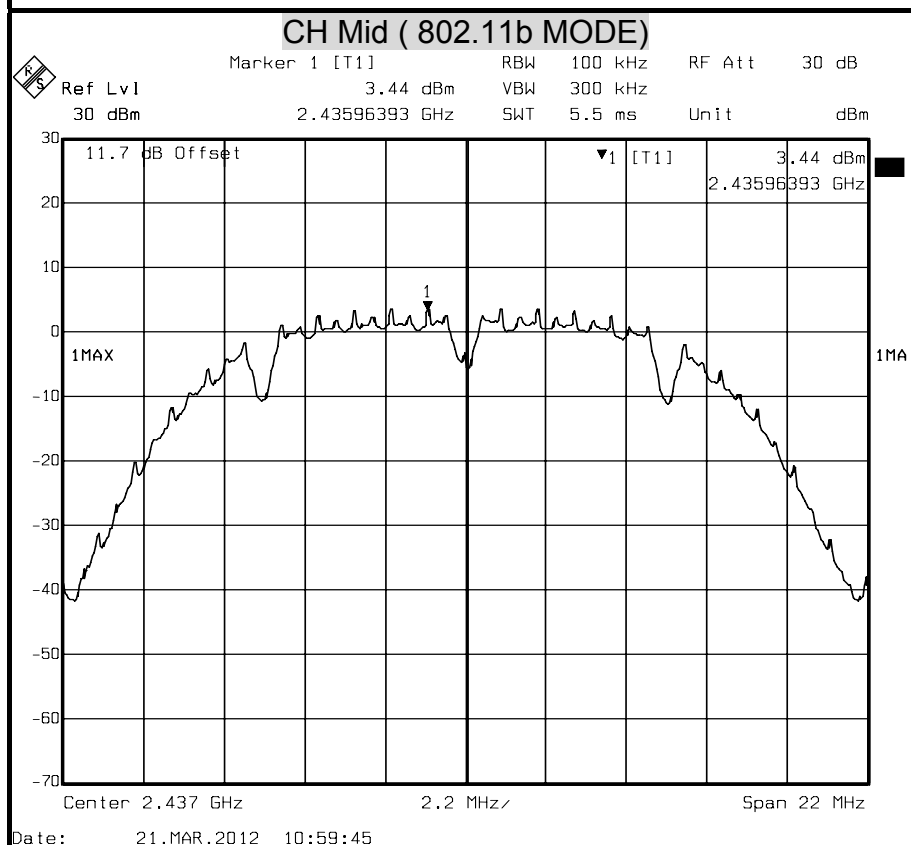
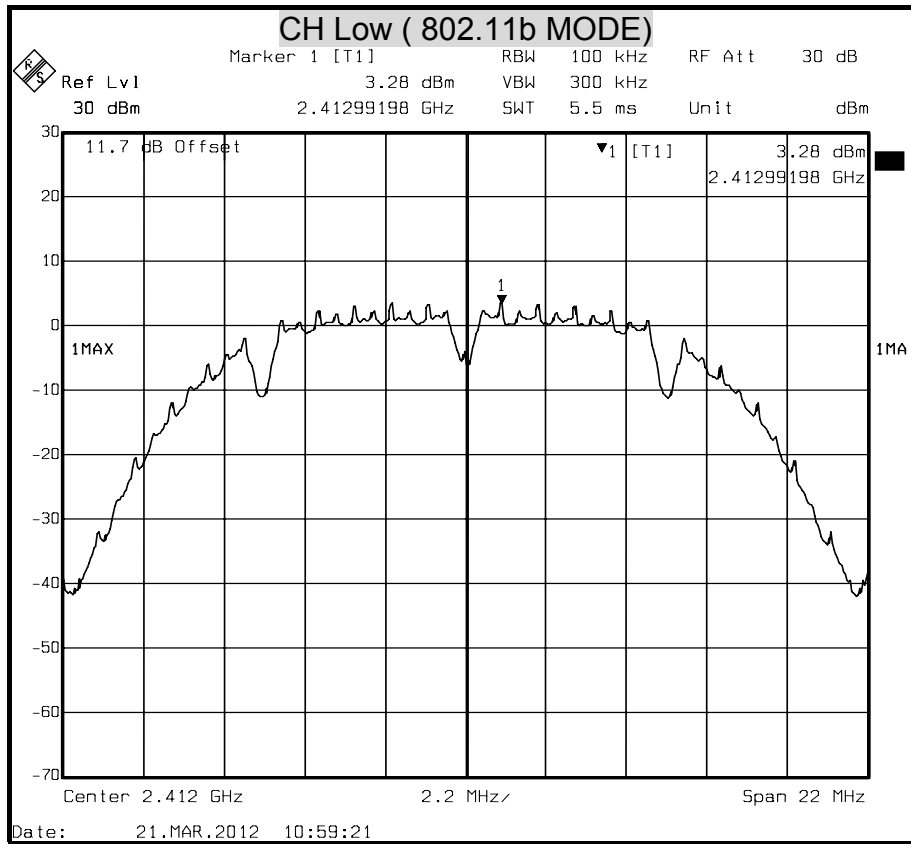

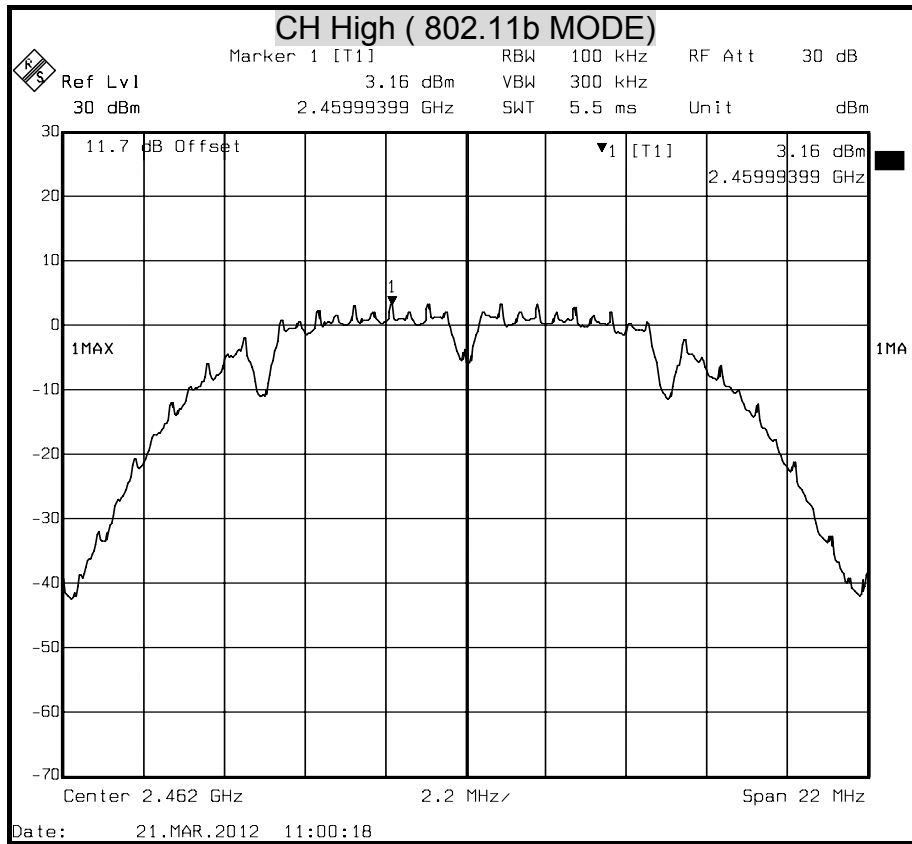



**POWER SPECTRAL DENSITY ( IEEE 802.11g MODE )**

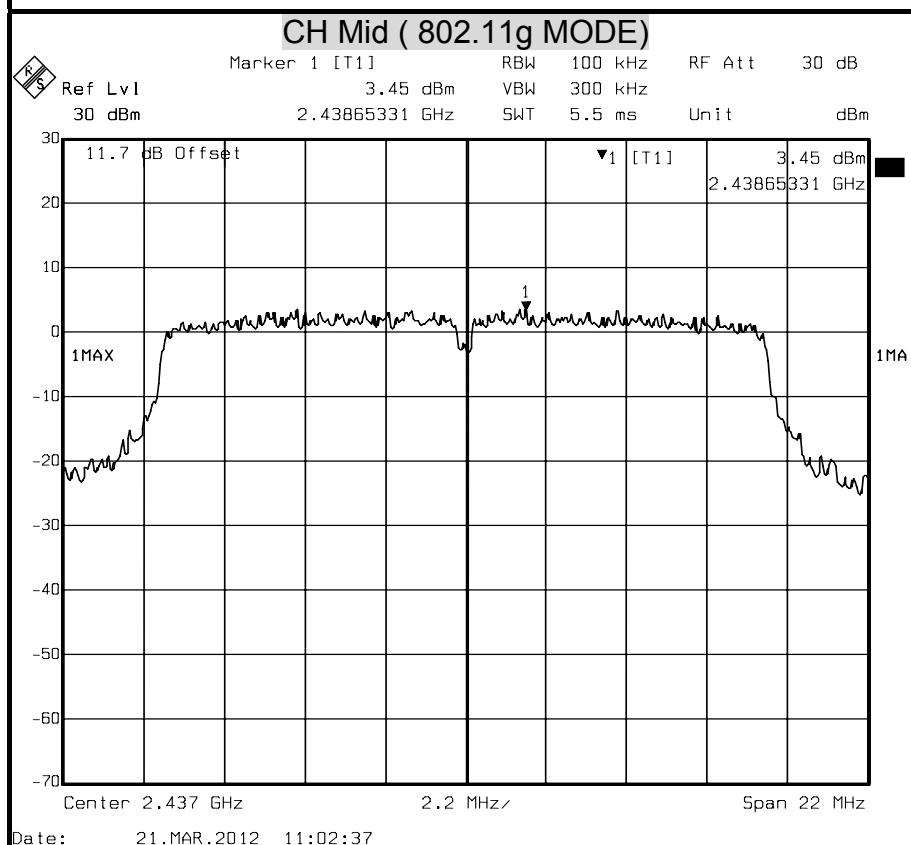
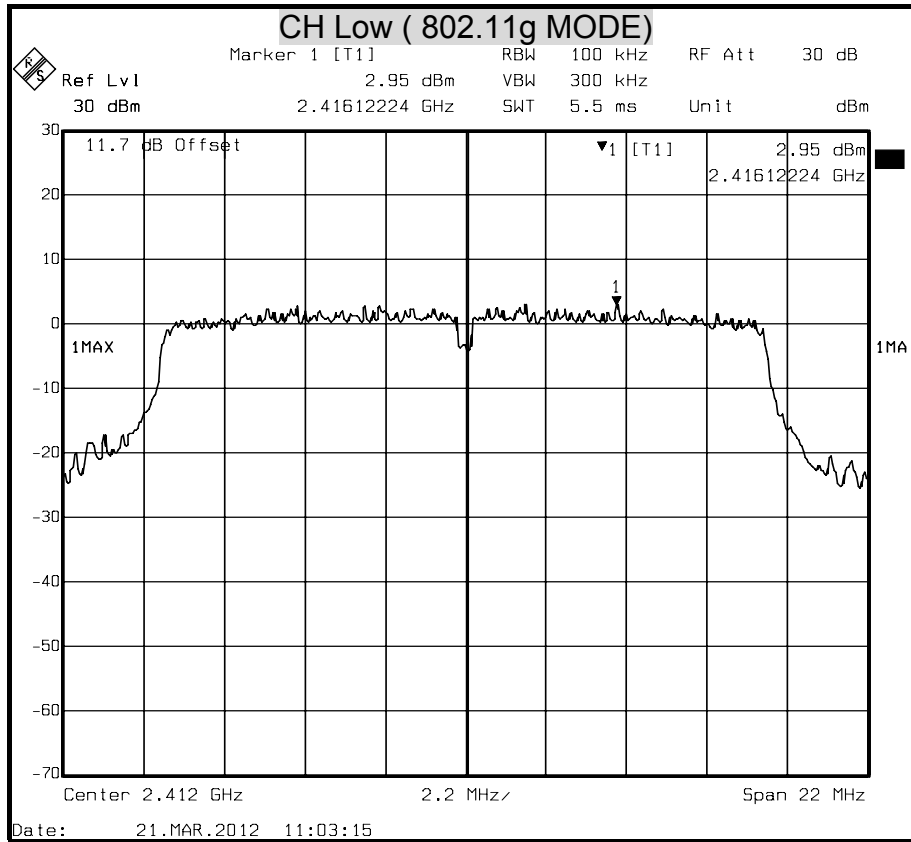

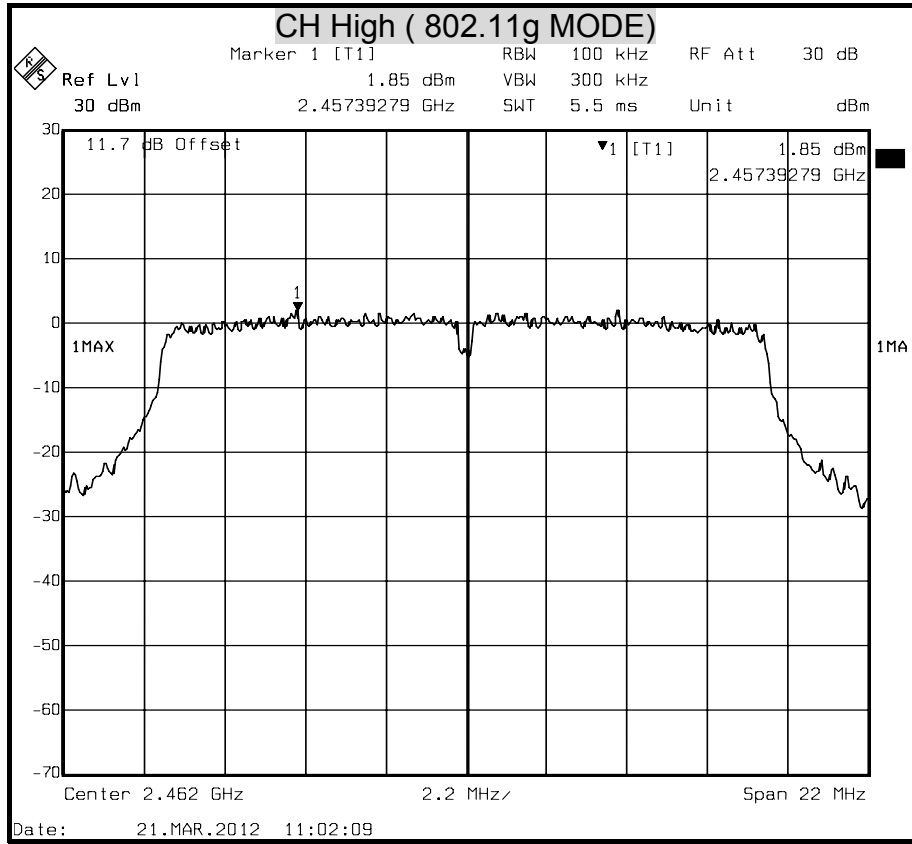



**POWER SPECTRAL DENSITY ( 802.11n HT20 MODE )**

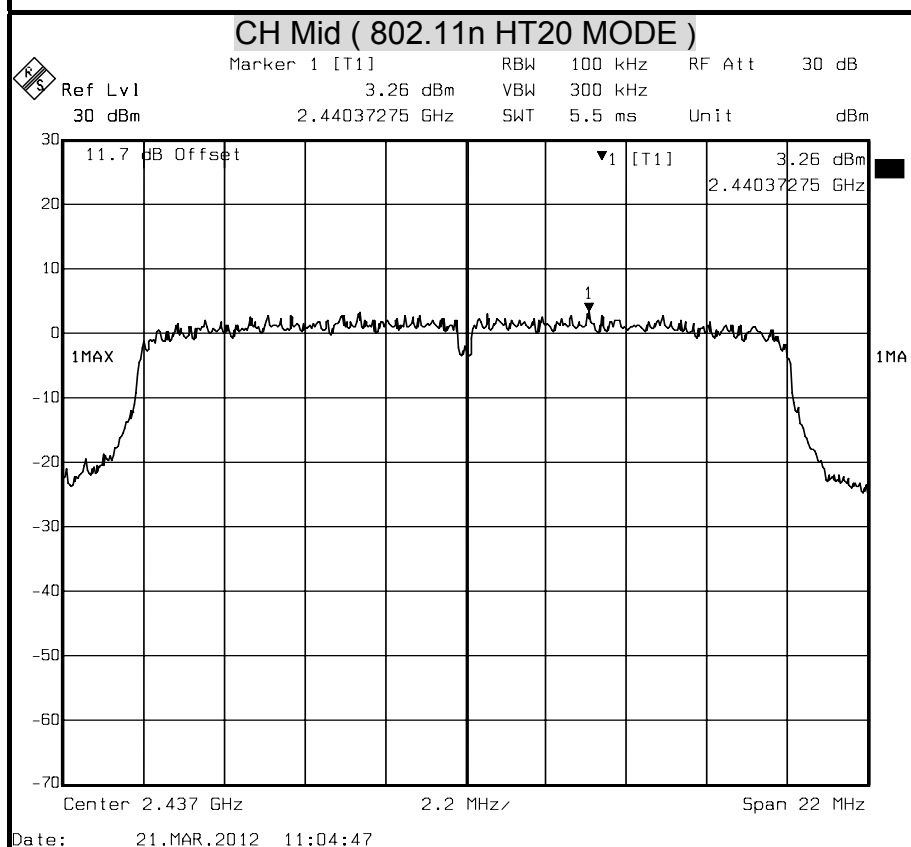
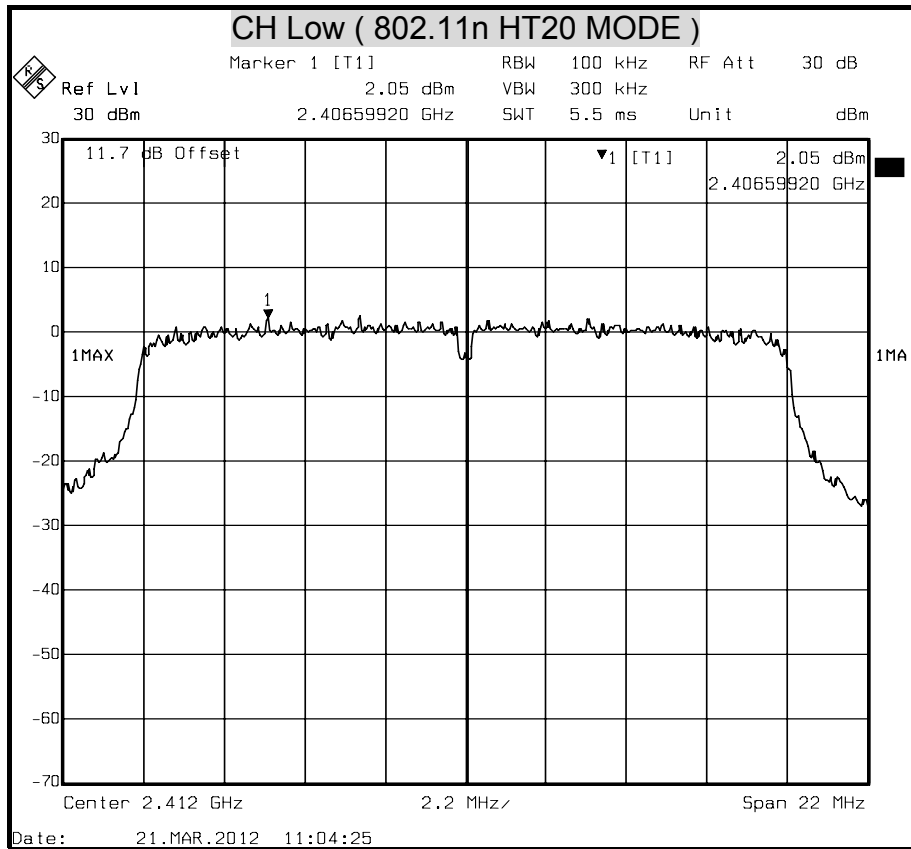

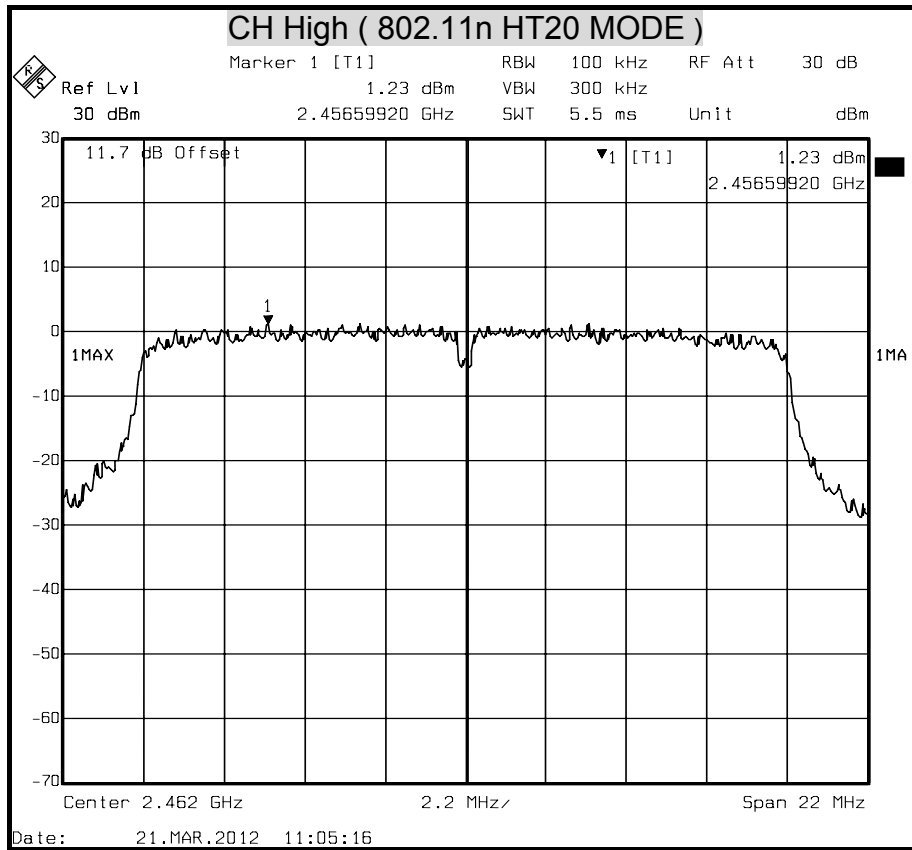





**POWER SPECTRAL DENSITY ( 802.11n HT40 MODE )**

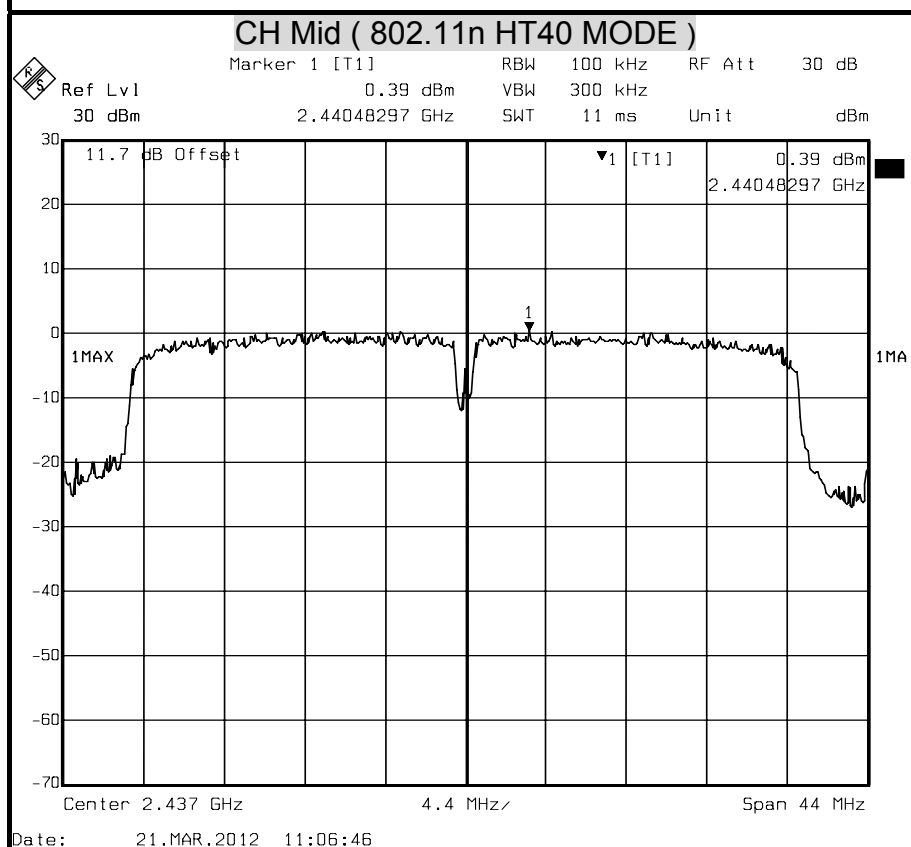
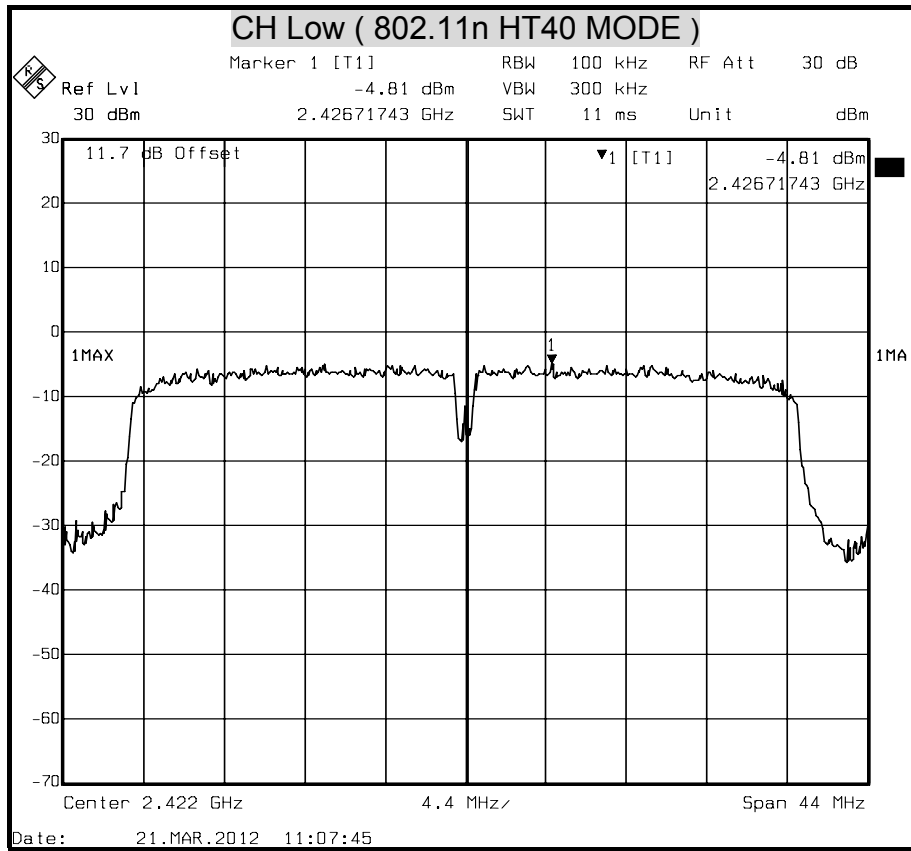

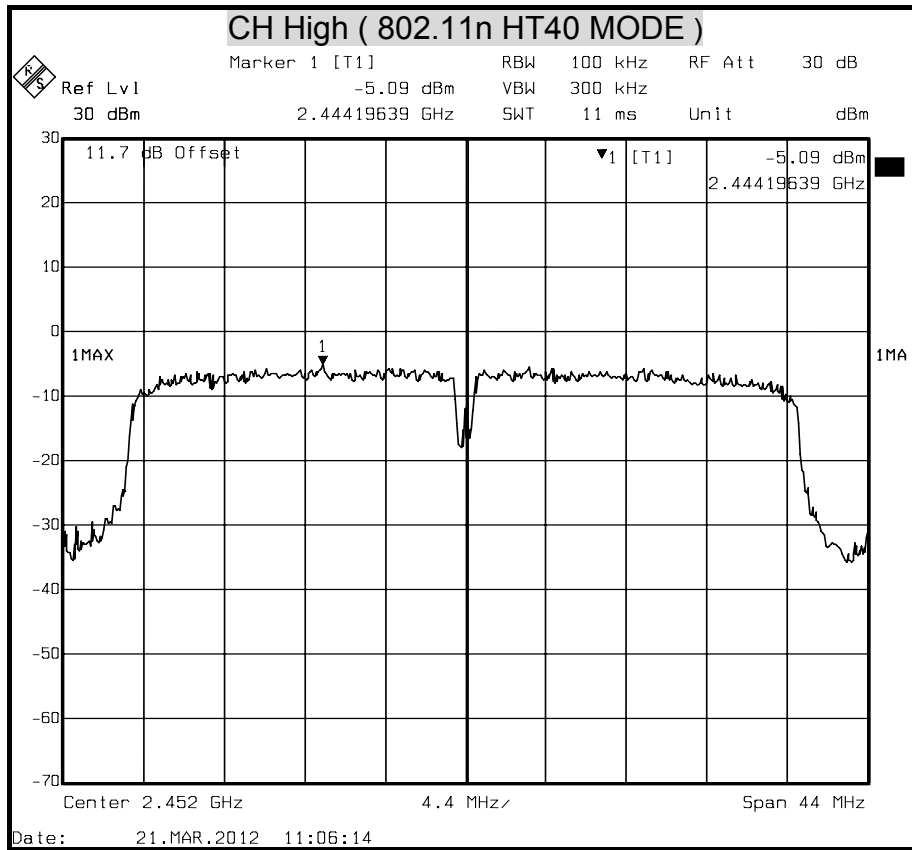



## 8.5 CONDUCTED SPURIOUS EMISSION

### LIMITS

§ 15.247(d) In any 100 kHz bandwidth outside the frequency band in which the spread spectrum intentional radiator is operating, the radio frequency power that is produced by the intentional radiator shall be at least 20 dB below that in the 100 kHz bandwidth within the band that contains the highest level of the desired power, based on either an RF conducted or a radiated measurement. Attenuation below the general limits specified in § 15.209(a) is not required. In addition, radiated emissions which fall in the restricted bands, as defined in § 15.205(a), must also comply with the radiated emission limits specified in § 15.209(a) (see § 15.205(c)).

### TEST PROCEDURE

The transmitter output is connected to a spectrum analyzer. The resolution bandwidth is set to 100 kHz. The video bandwidth is set to 100 kHz.

The spectrum from 30 MHz to 26.5 GHz is investigated with the transmitter set to the lowest, middle, and highest channels in the 2.4 GHz band.

### TEST SETUP

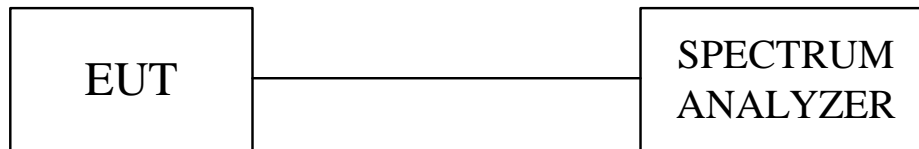

### TEST RESULTS

No non-compliance noted.



### OUT-OF-BAND SPURIOUS EMISSIONS-CONDUCTED MEASUREMENT

( IEEE 802.11b MODE )

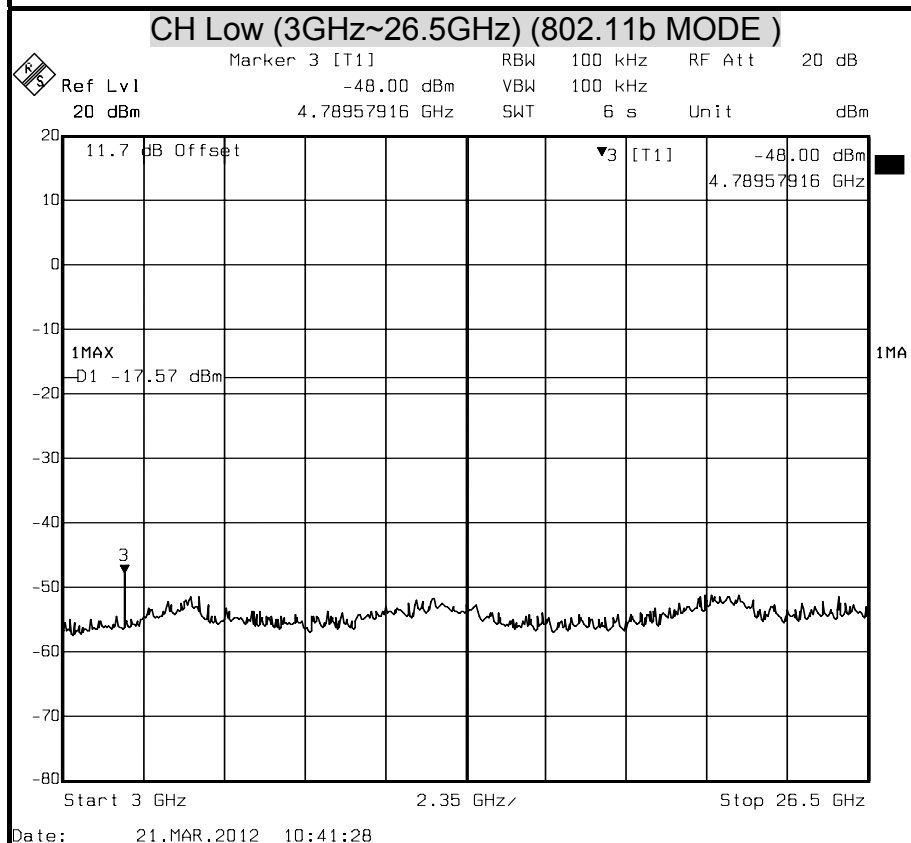
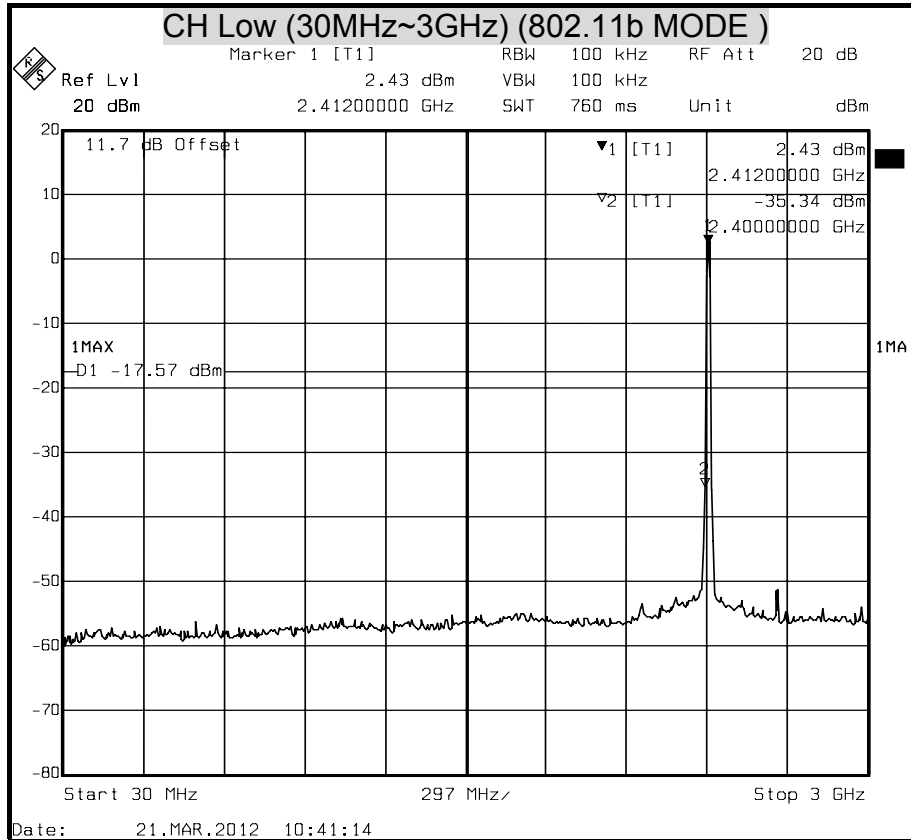

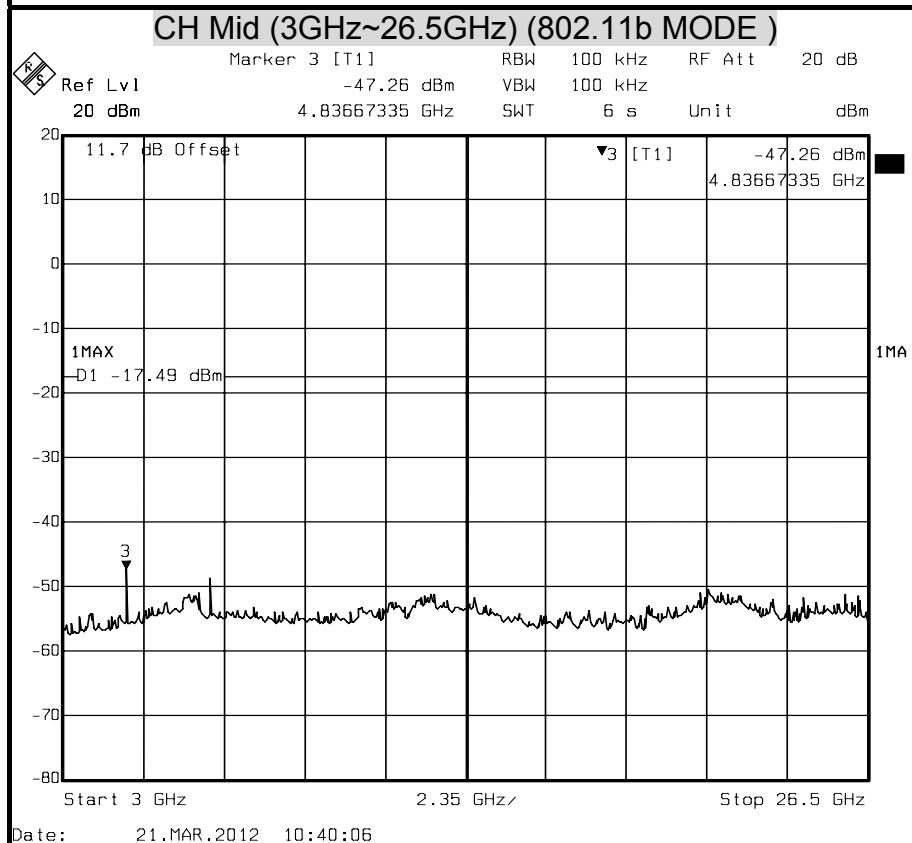
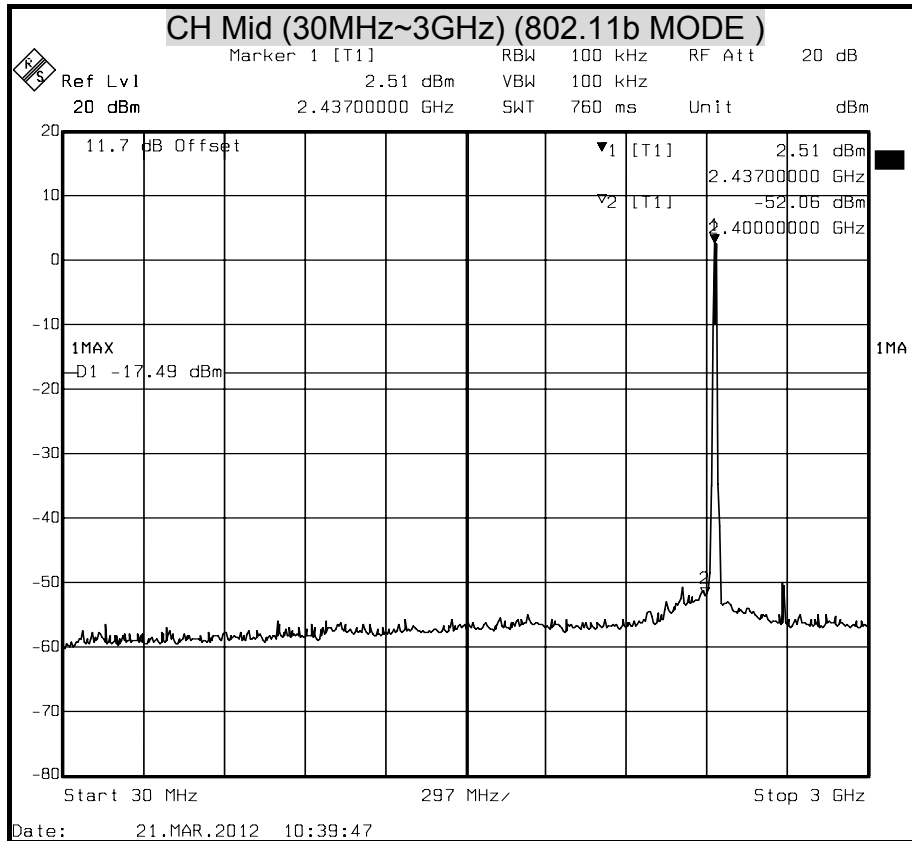

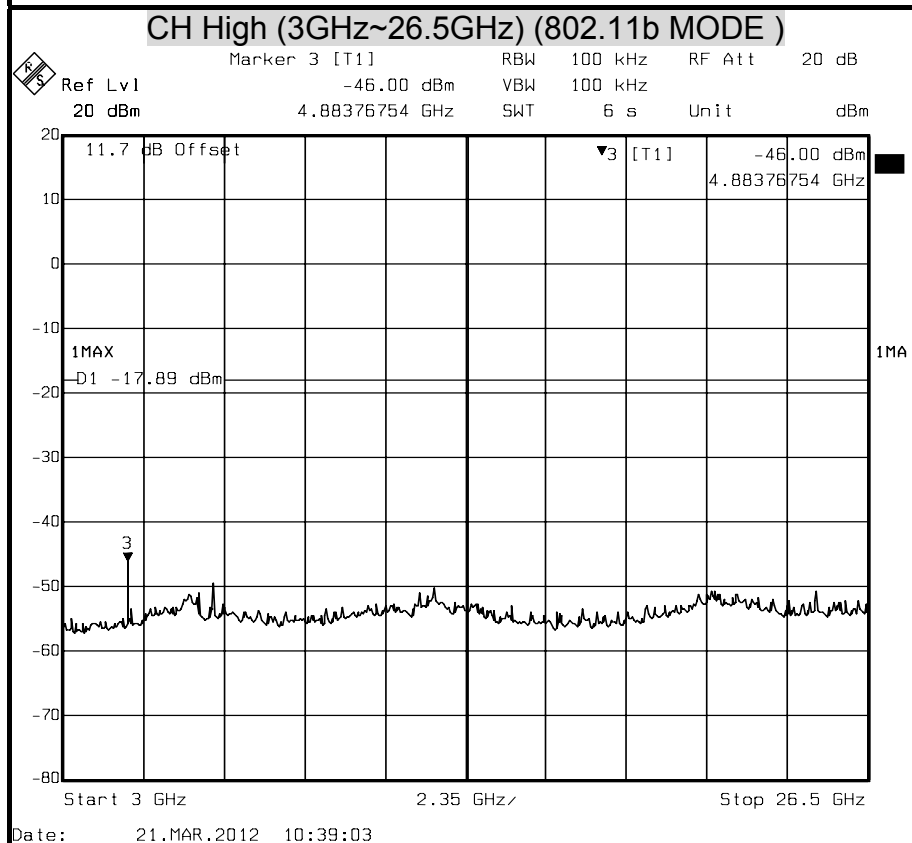
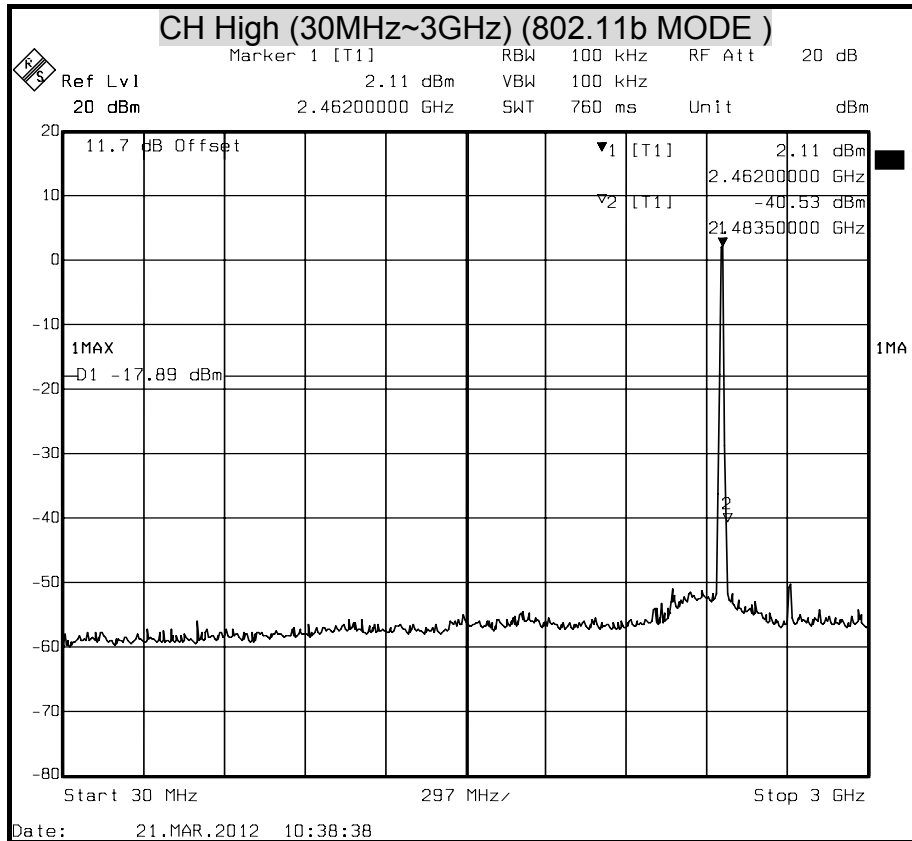



### OUT-OF-BAND SPURIOUS EMISSIONS-CONDUCTED MEASUREMENT

( 802.11g MODE)

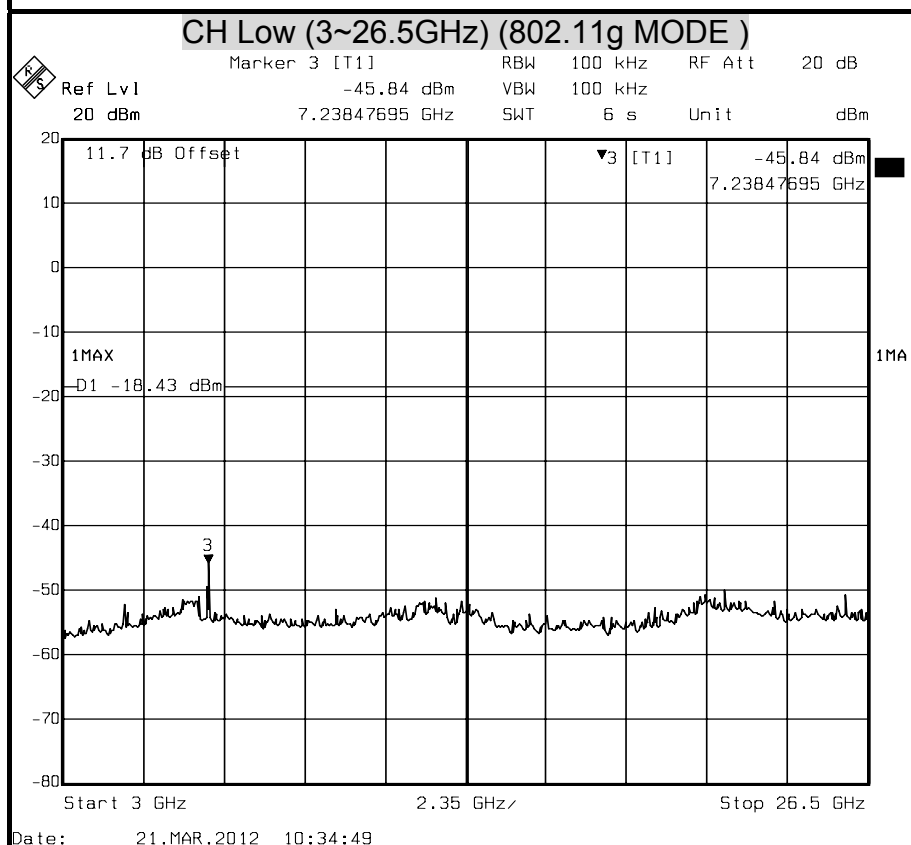
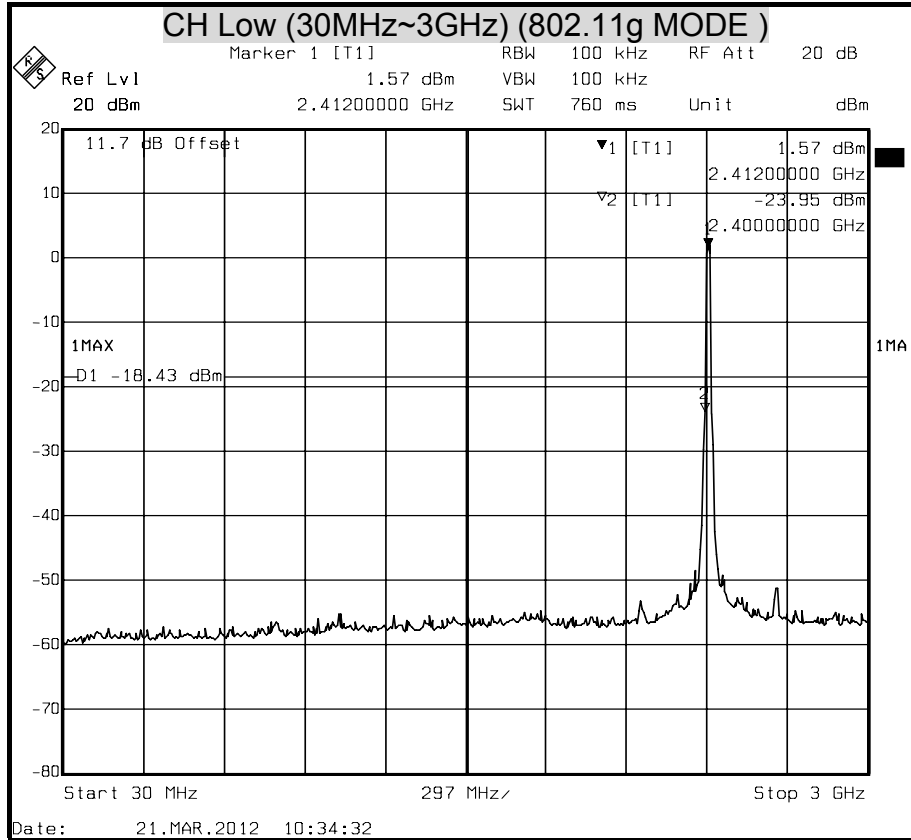

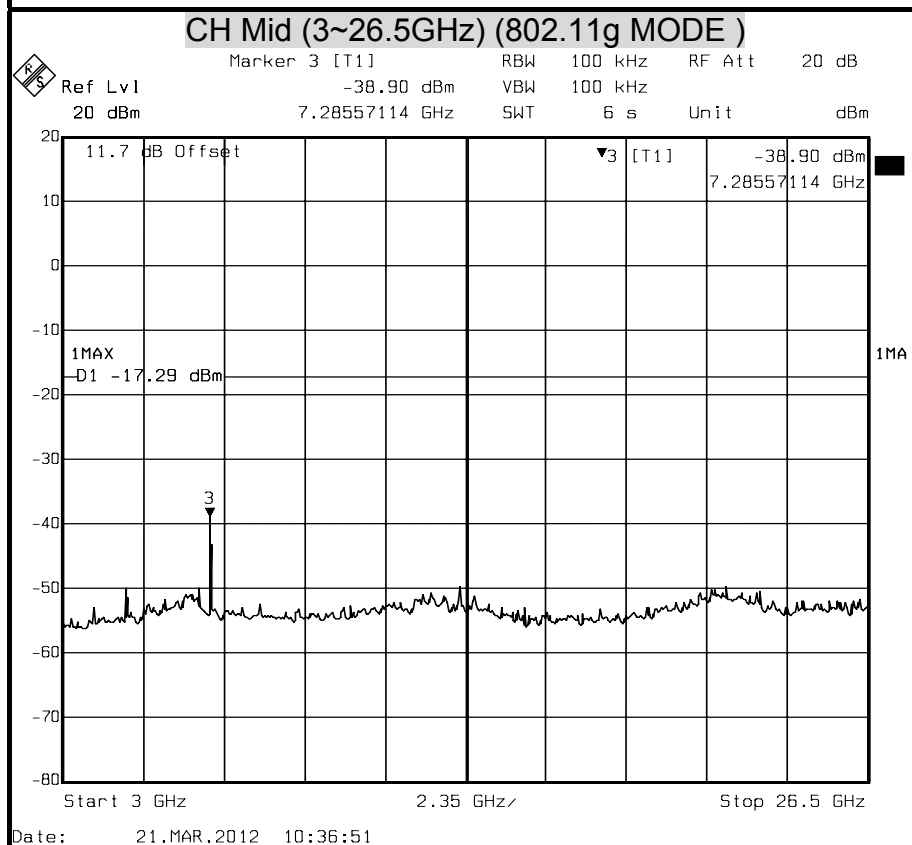
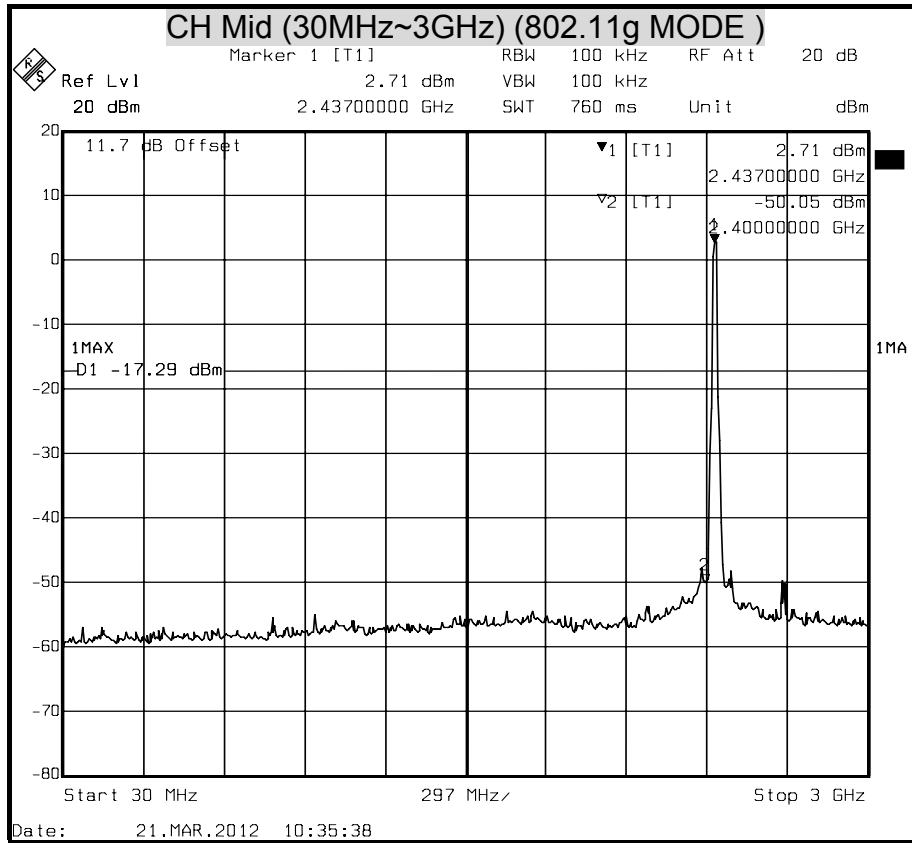



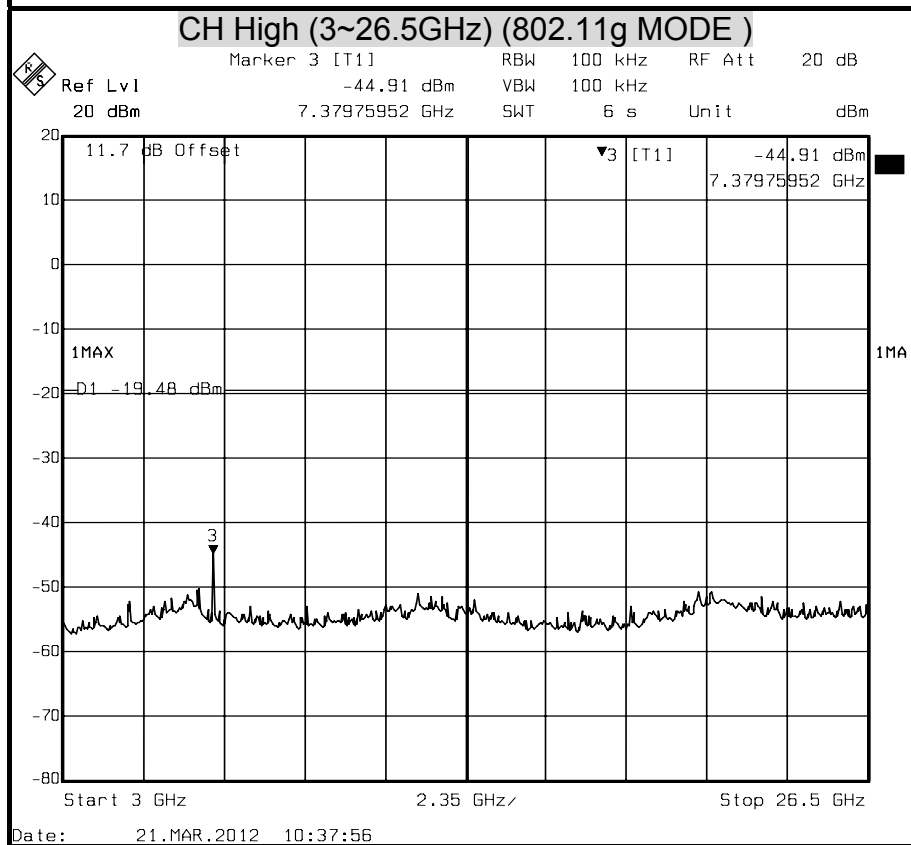
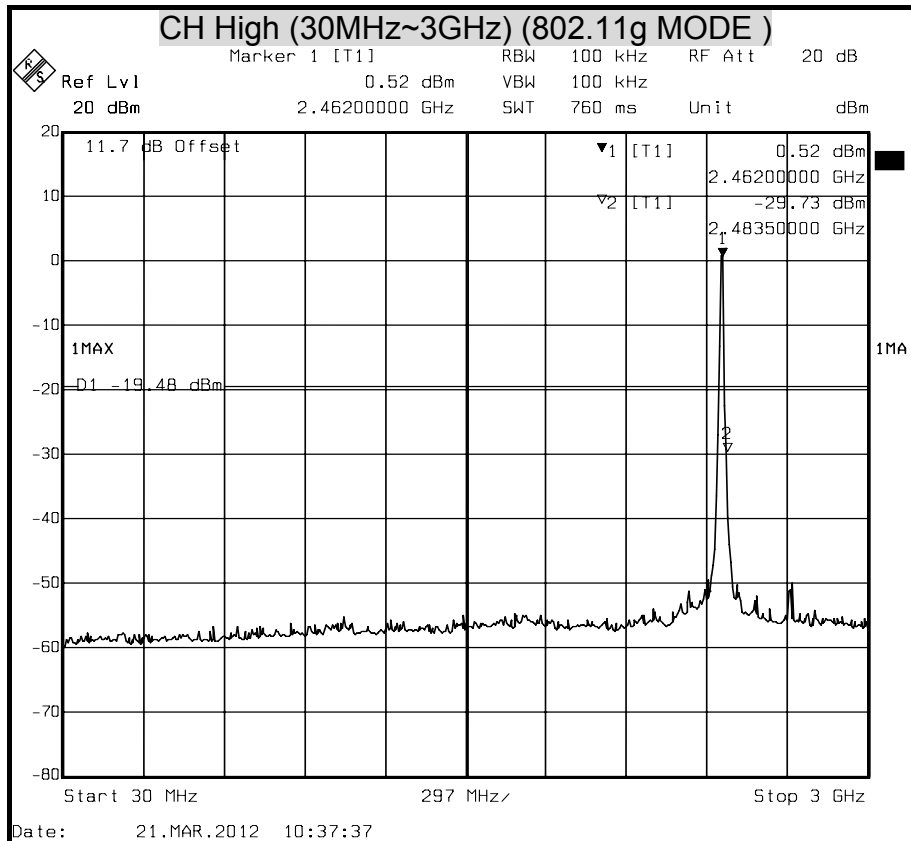



### OUT-OF-BAND SPURIOUS EMISSIONS-CONDUCTED MEASUREMENT

( 802.11n HT20 MODE )

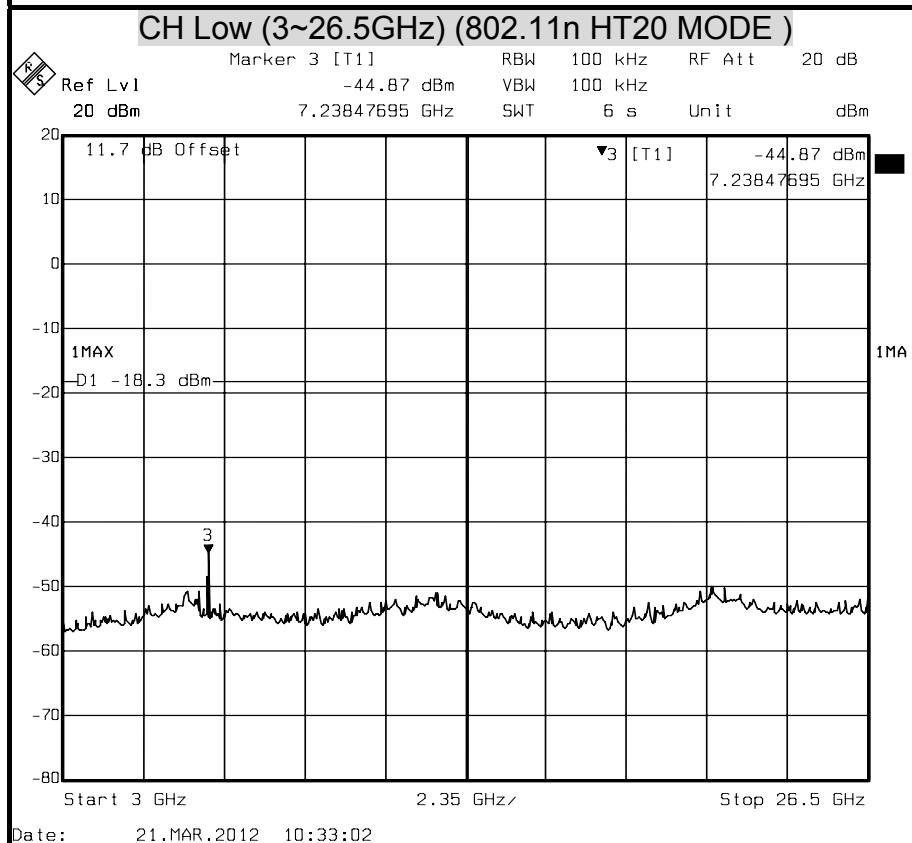
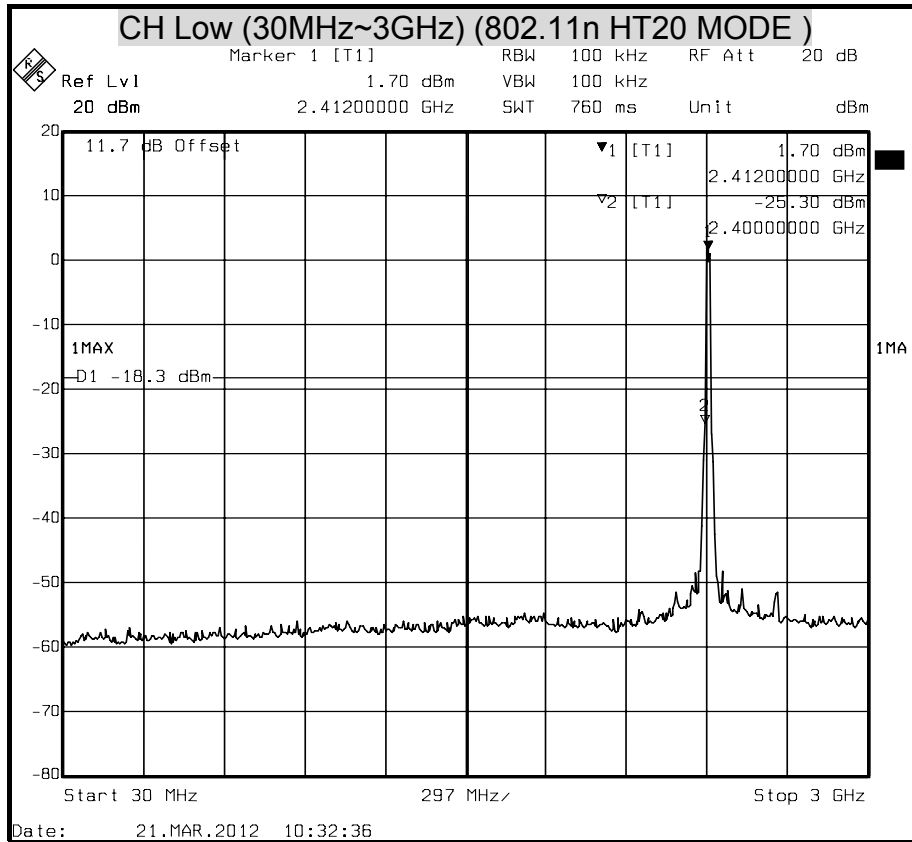

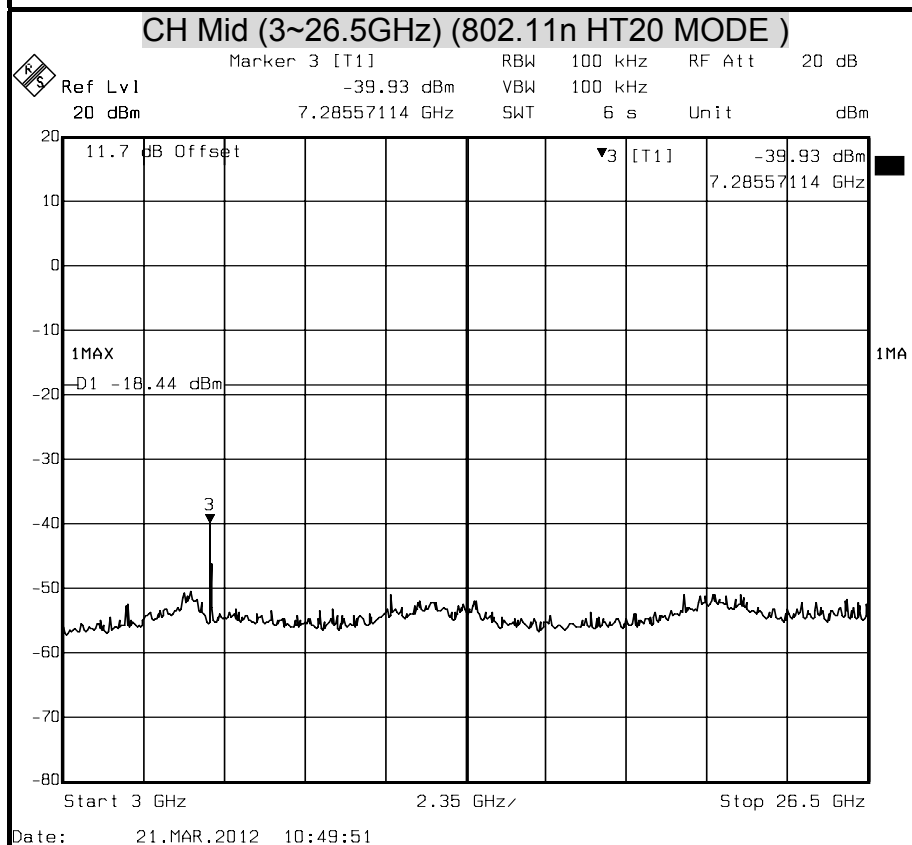
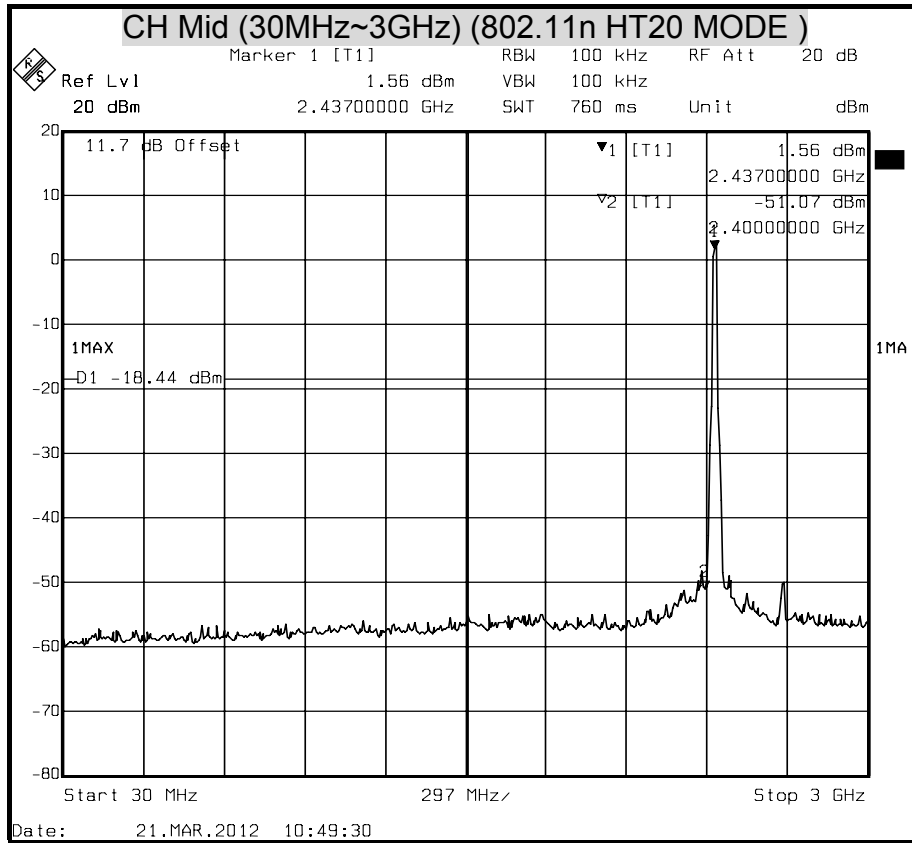

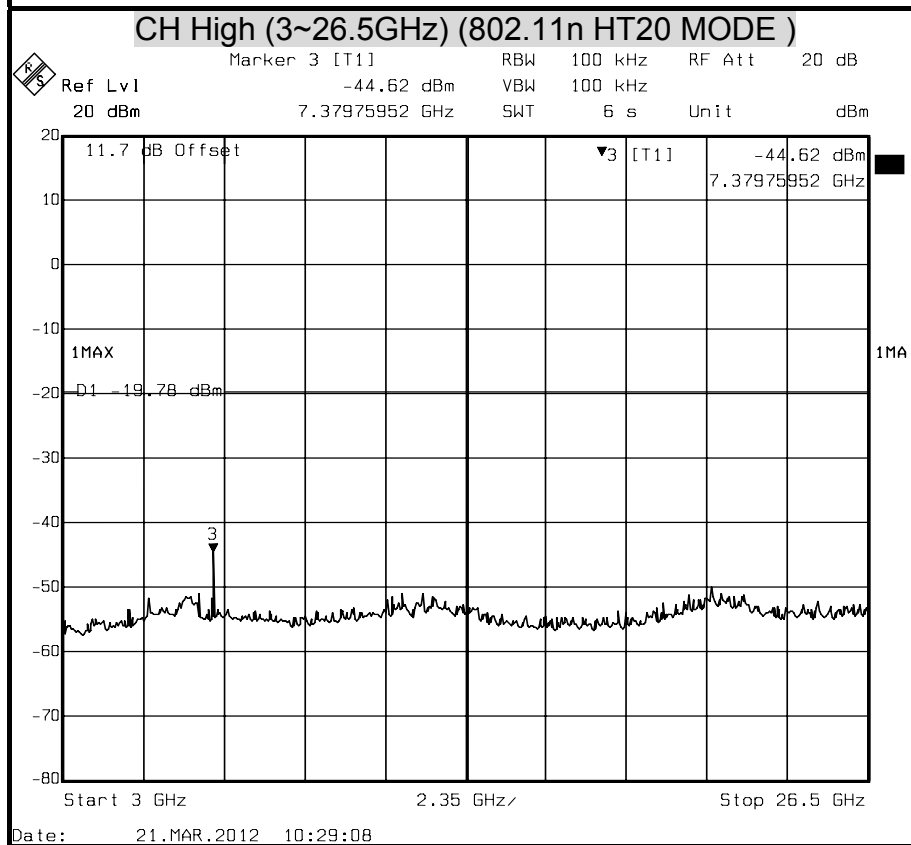
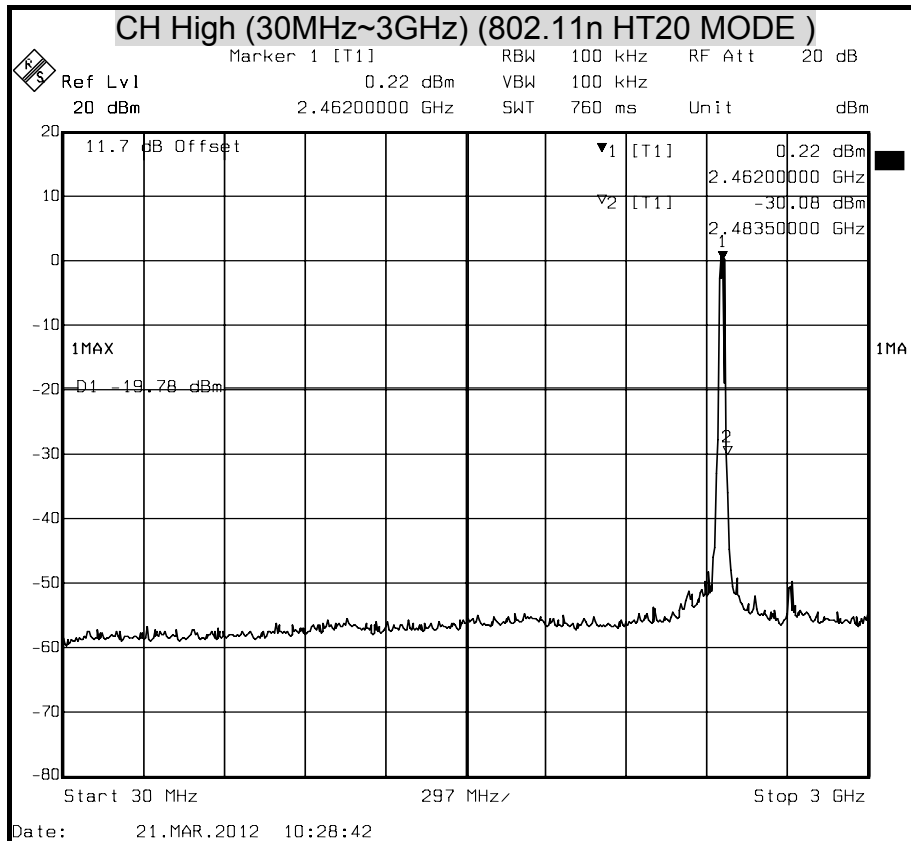



### OUT-OF-BAND SPURIOUS EMISSIONS-CONDUCTED MEASUREMENT

( 802.11n HT40 MODE )

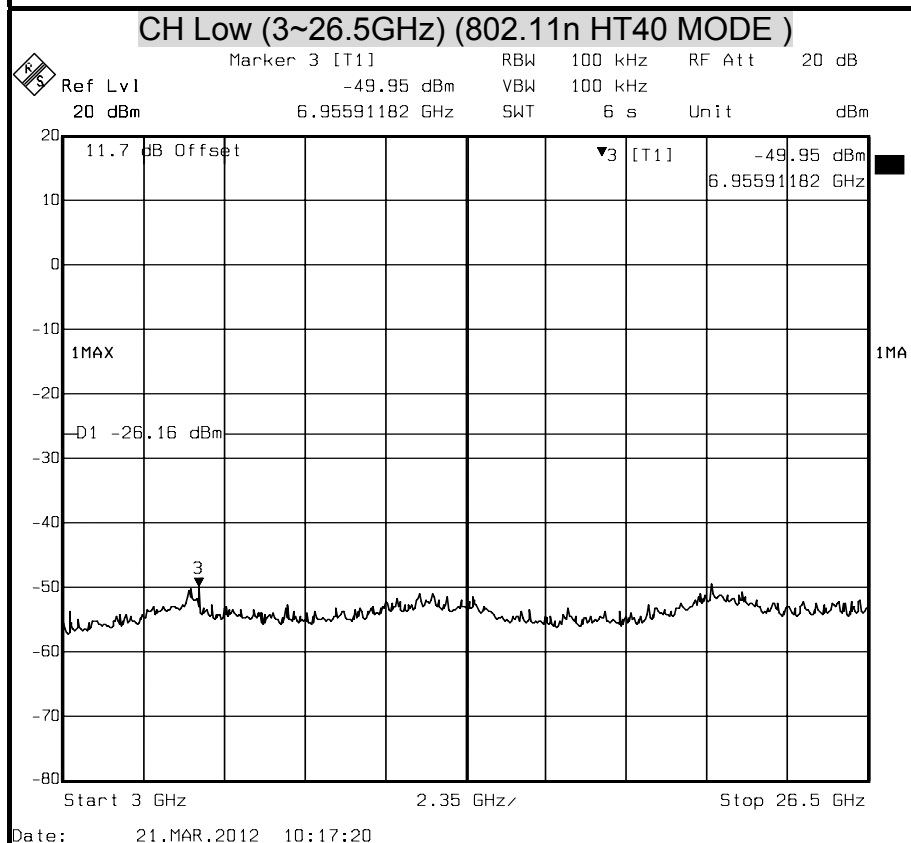
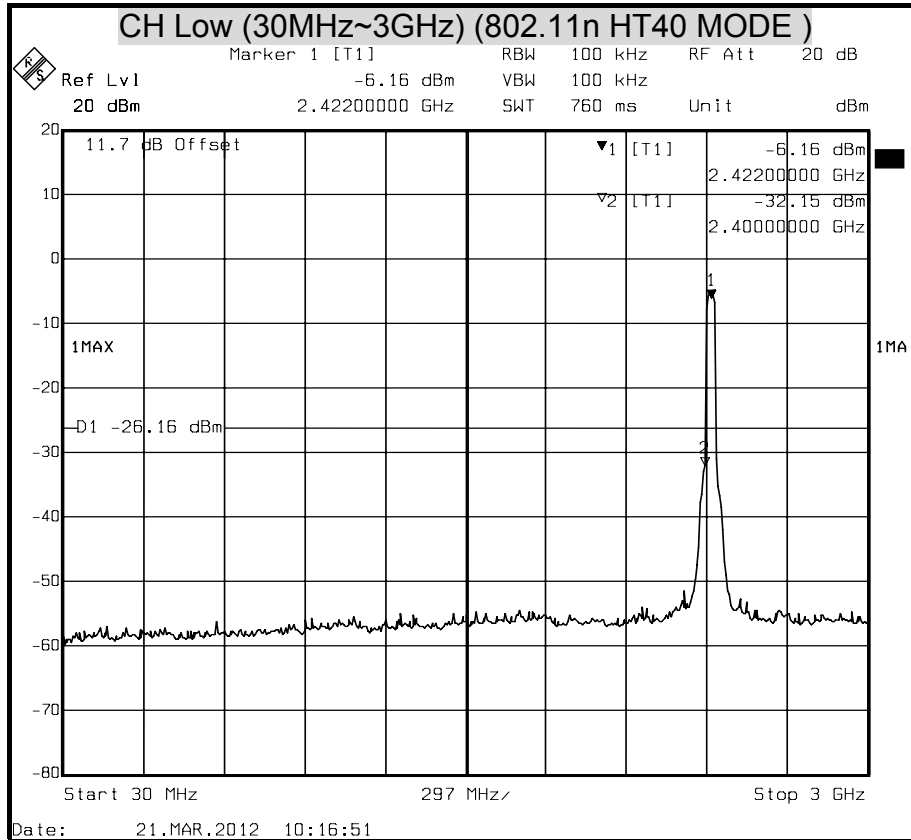

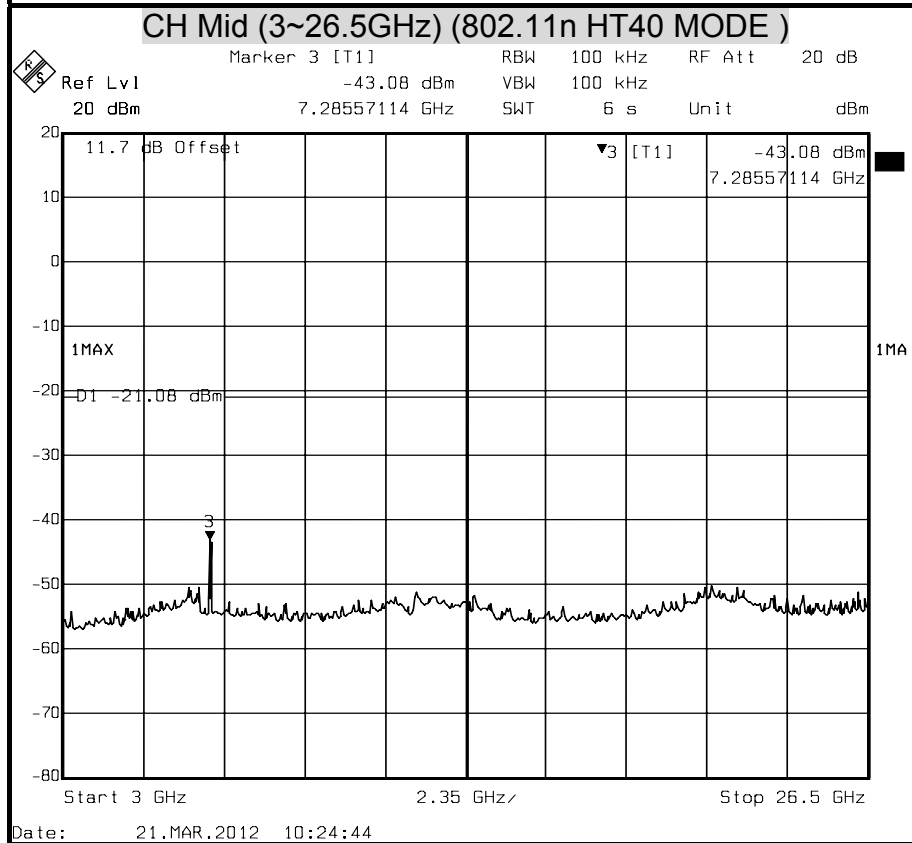
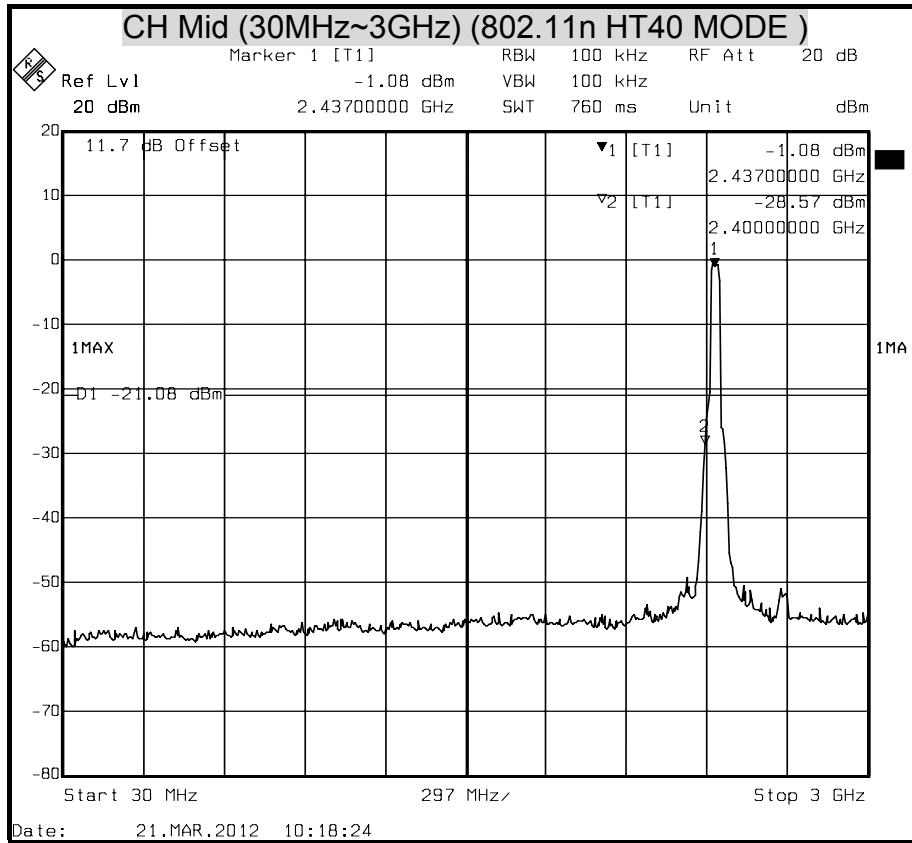

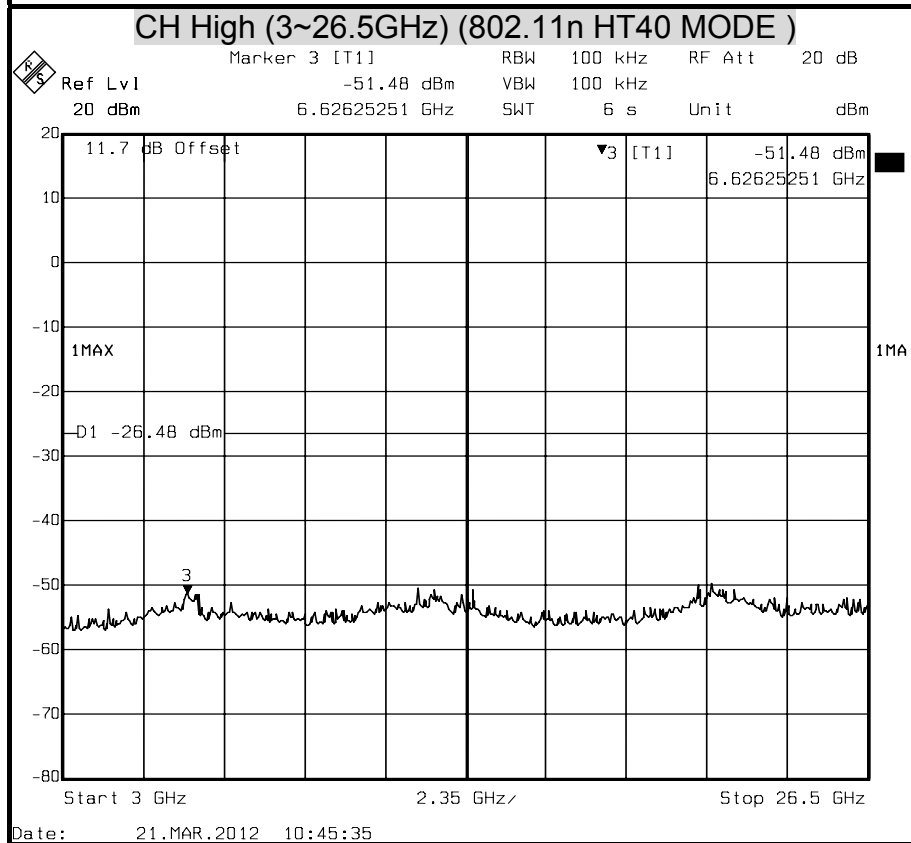
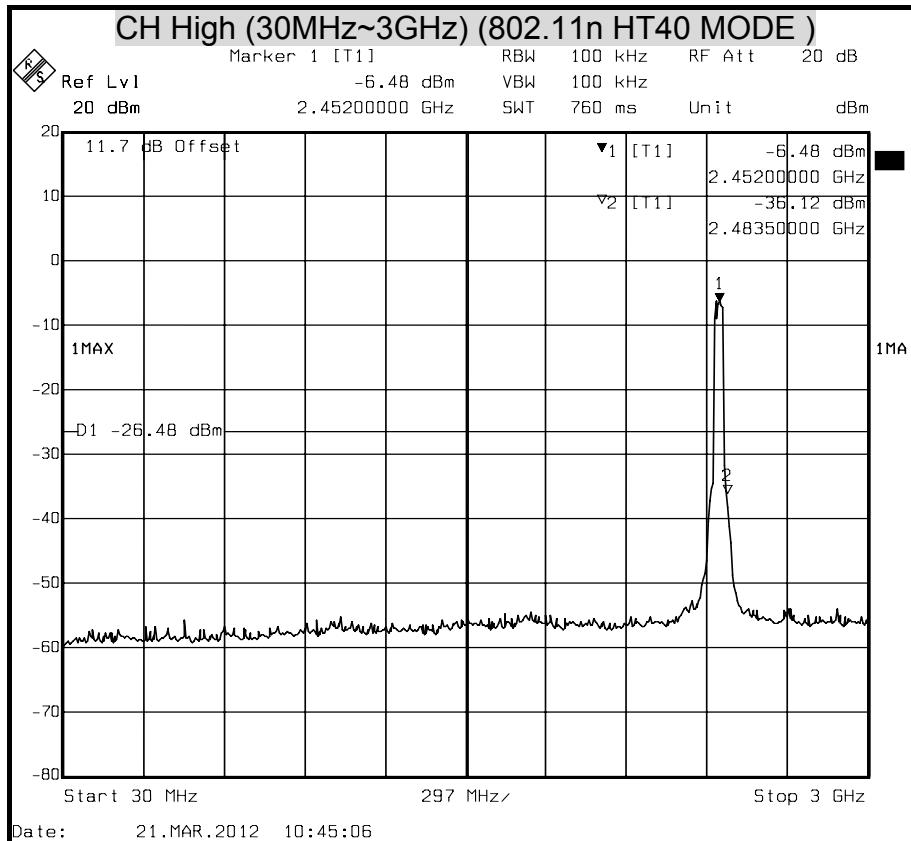



### 8.6 RADIATED EMISSIONS

#### 8.6.1 TRANSMITTER RADIATED SUPURIOUS EMSSIONS

##### LIMITS

§ 15.205 (a) Except as shown in paragraph (d) of this section, only spurious emissions are permitted in any of the frequency bands listed below:

MHz	MHz	MHz	GHz
0.090 - 0.110	16.42 - 16.423	399.9 - 410	4.5 - 5.15
<sup>1</sup> 0.495 - 0.505	16.69475 - 16.69525	608 - 614	5.35 - 5.46
2.1735 - 2.1905	16.80425 - 16.80475	960 - 1240	7.25 - 7.75
4.125 - 4.128	25.5 - 25.67	1300 - 1427	8.025 - 8.5
4.17725 - 4.17775	37.5 - 38.25	1435 - 1626.5	9.0 - 9.2
4.20725 - 4.20775	73 - 74.6	1645.5 - 1646.5	9.3 - 9.5
6.215 - 6.218	74.8 - 75.2	1660 -1710	10.6 -12.7
6.26775 - 6.26825	108 -121.94	1718.8 - 1722.2	13.25 -13.4
6.31175 - 6.31225	123 - 138	2200 - 2300	14.47 – 14.5
8.291 - 8.294	149.9 - 150.05	2310 - 2390	15.35 -16.2
8.362 - 8.366	156.52475 - 156.52525	2483.5 - 2500	17.7 - 21.4
8.37625 - 8.38675	156.7 - 156.9	2655 - 2900	22.01 - 23.12
8.41425 - 8.41475	162.0125 - 167.17	3260 - 3267	23.6 - 24.0
12.29 - 12.293	167.72 - 173.2	3332 - 3339	31.2 - 31.8
12.51975 - 12.52025	240 - 285	3345.8 - 3338	36.43 - 36.5
12.57675 - 12.57725	322 -335.4	3600 - 4400	( <sup>2</sup> )
13.36 - 13.41			

<sup>1</sup> Until February 1, 1999, this restricted band shall be 0.490-0.510 MHz.

<sup>2</sup> Above 38.6

§ 15.205 (b) Except as provided in paragraphs (d) and (e), the field strength of emissions appearing within these frequency bands shall not exceed the limits shown in Section 15.209. At frequencies equal to or less than 1000 MHz, compliance with the limits in Section 15.209 shall be demonstrated using measurement instrumentation employing a CISPR quasi-peak detector. Above 1000 MHz, compliance with the emission limits in Section 15.209 shall be demonstrated based on the average value of the measured emissions. The provisions in Section 15.35 apply to these measurements.





§ 15.209 (a) Except as provided elsewhere in this Subpart, the emissions from an intentional radiator shall not exceed the field strength levels specified in the following table :

Frequency (MHz)	Field Strength (microvolts/meter)	Measurement Distance (meters)
30 - 88	100 **	3
88 - 216	150 **	3
216 - 960	200 **	3
Above 960	500	3

\*\* Except as provided in paragraph (g), fundamental emissions from intentional radiators operating under this Section shall not be located in the frequency bands 54-72 MHz, 76-88 MHz, 174-216 MHz or 470-806 MHz, However, operation within these frequency bands is permitted under other sections of this Part, e-g, Sections 15.231 and 15.241.

§ 15.209 (b) In the emission table above, the tighter limit applies at the band edges.

**TEST EQUIPMENTS**

The following test equipments are utilized in making the measurements contained in this report.

Open Area Test Site # 6				
Name of Equipment	Manufacturer	Model	Serial Number	Calibration Due
TYPE N COAXIAL CABLE	SUHNER	CHA9513	6	NOV. 15, 2012
BI-LOG Antenna	Sunol	JB1	A070506-2	OCT. 03, 2012
LOOP ANTENNA	EMCO	6502	8905-2356	JUN. 10, 2012
Pre-Amplifier	HP	8447F	2944A03817	NOV. 23, 2012
EMI Receiver	R&S	ESVS10	833206/012	MAY 31, 2012
RF Cable	SUHNER	SUCOFLEX104PEA	20520/4PEA	NOV. 10, 2012
Horn Antenna	Com-Power	AH-118	071032	DEC. 04, 2012
Spectrum Analyzer	R&S	FSEK 30	835253/002	SEP, 29, 2012
Pre-Amplifier	MITEQ	AFS44-00108650-42-10P-44	1205908	NOV. 23, 2012
3116 Double Ridge Antenna (40G)	ETS-LINDGREN	EMCO-003	00078	NOV. 14, 2012
Turn Table	Yo Chen	001	-----	N.C.R.
Antenna Tower	AR	TP1000A	309874	N.C.R.
Controller	CT	SC101	-----	N.C.R.
RF Switch	E-INSTRUMENT TELH LTD	ERS-180A	EC1204141	N.C.R
Power Meter	Anritsu	ML2487A	6K00003888	MAY 30, 2012
Power Sensor	Anritsu	MA2491A	33265	MAY 30.2012
Temp./Humidity Chamber	K.SON	THS-M1	242	AUG. 09, 2012
Signal Generator	HP	8673C	2938A00663	SEP. 12, 2012
DC Power Source	LOKO	DSP-5050	L1507009282	N.C.R



**TEST SETUP**

The diagram below shows the test setup that is utilized to make the measurements for emission from 30 to 1GHz.

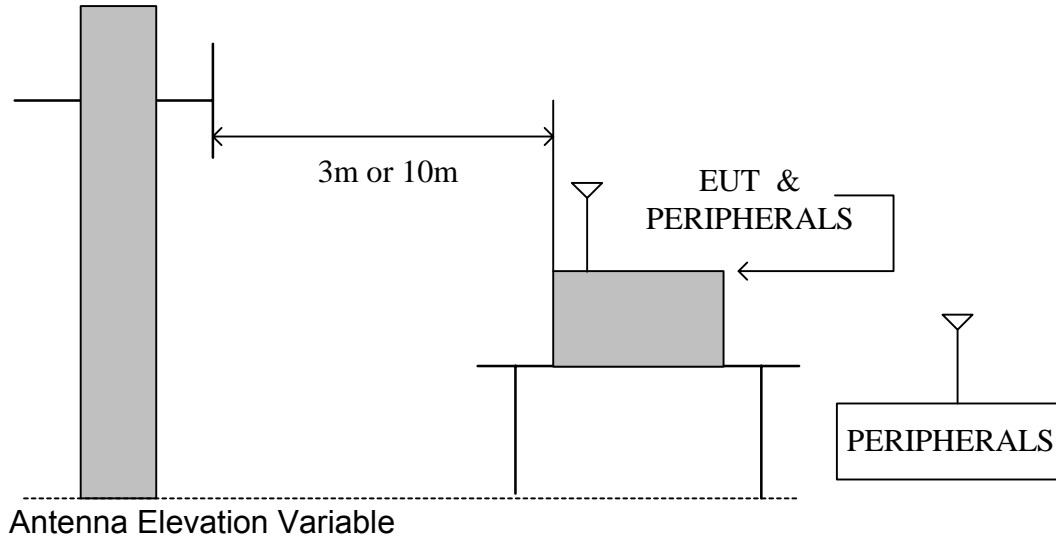

The diagram below shows the test setup that is utilized to make the measurements for emission above 1GHz.

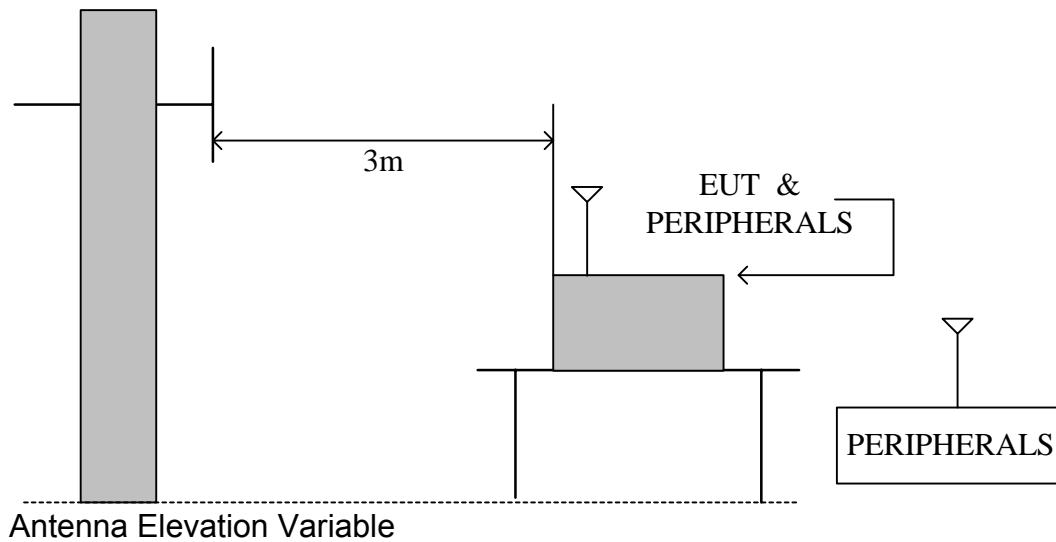



## **TEST PROCEDURE**

- a. The EUT was placed on the top of a rotating table 0.8 meters above the ground at a 10 meter open area test site. The table was rotated 360 degrees to determine the position of the highest radiation.
- b. While measuring the radiated emission below 1GHz, the EUT was set 3 or 10 meters away from the interference-receiving antenna, which was mounted on the top of a variable-height antenna tower. While measuring the radiated emission above 1GHz, the EUT was set 3 meters away from the interference-receiving antenna
- c. The antenna is a broadband antenna, and its height is varied from one meter to four meters above the ground to determine the maximum value of the field strength. Both horizontal and vertical polarization of the antenna are set to make the measurement.
- d. For each suspected emission, the EUT was arranged to its worst case and then the antenna was tuned to heights from 1 meter to 4 meters and the table was turned from 0 degrees to 360 degrees to find the maximum reading.
- e. The test-receiver system was set to Peak Detect Function and Specified Bandwidth with Maximum Hold Mode.
- f. If the emission level of the EUT in peak mode was 10 dB lower than the limit specified, then testing could be stopped and the peak values of the EUT would be reported. Otherwise the emissions that did not have 10 dB margin would be re-tested one by one using peak, quasi-peak or average method as specified and then reported in a data sheet.
- g. The tests were performed in accordance with KDB 558074 5.4.

### **NOTE:**

1. The resolution bandwidth and video bandwidth of test receiver/spectrum analyzer is 120 KHz for Peak detection (PK) and Quasi-peak detection (QP) at frequency below 1GHz.
2. The resolution bandwidth and video bandwidth of test receiver/spectrum analyzer is 1 MHz for Peak detection and frequency above 1GHz.
3. The resolution bandwidth of test receiver/spectrum analyzer is 1 MHz and the video bandwidth is 10 Hz for Average detection (AV) at frequency above 1GHz.
4. **No emission is found between lowest internal used/generated frequency to 30MHz (9kHz~30MHz)**

## **TEST RESULTS**

No non-compliance noted.

**8.6.2 WORST-CASE RADIATED EMISSION BELOW 1 GHz**

<b>Product Name</b>	Wireless-N Router w 3G+Modem & Voice	<b>Test Date</b>	2012/03/20
<b>Model</b>	Series 1098 Model 4530	<b>Test By</b>	John Chen
<b>Test Mode</b>	WAN Mode	<b>TEMP&amp; Humidity</b>	26.4°C, 56%

## Horizontal

<b>Freq.</b>	<b>Reading</b>	<b>Antenna</b>	<b>Cable</b>	<b>Measure</b>	<b>Limit</b>	<b>Over</b>	<b>Detector</b>
<b>MHz</b>	<b>Level</b>	<b>Factor</b>	<b>Loss</b>	<b>Level</b>	<b>dBuV/m</b>	<b>Limit</b>	
	<b>dBuV</b>	<b>dB/m</b>	<b>dB</b>	<b>dBuV/m</b>	<b>dBuV/m</b>	<b>dBuV/m</b>	
125.00	1.26	13.61	2.48	17.34	30.00	-12.66	QP
177.13	11.00	11.38	3.07	25.45	30.00	-4.55	QP
250.00	2.60	11.86	3.70	18.16	37.00	-18.84	QP
300.00	5.20	13.49	4.10	22.79	37.00	-14.21	QP
360.00	8.50	14.57	4.52	27.59	37.00	-9.41	QP
420.00	5.50	16.11	4.92	26.53	37.00	-10.47	QP
480.00	9.07	17.51	5.28	31.86	37.00	-5.14	QP
500.00	5.20	17.93	5.40	28.53	37.00	-8.47	QP
539.80	3.61	17.99	5.60	27.20	37.00	-9.80	QP
600.00	10.07	18.45	5.90	34.42	37.00	-2.58	QP
720.00	5.90	20.30	6.70	32.90	37.00	-4.10	QP
840.00	4.30	21.81	7.34	33.45	37.00	-3.55	QP

## Vertical

<b>Freq.</b>	<b>Reading</b>	<b>Antenna</b>	<b>Cable</b>	<b>Measure</b>	<b>Limit</b>	<b>Over</b>	<b>Detector</b>
<b>MHz</b>	<b>Level</b>	<b>Factor</b>	<b>Loss</b>	<b>Level</b>	<b>dBuV/m</b>	<b>Limit</b>	
	<b>dBuV</b>	<b>dB/m</b>	<b>dB</b>	<b>dBuV/m</b>	<b>dBuV/m</b>	<b>dBuV/m</b>	
58.43	16.70	7.46	1.66	25.82	30.00	-4.18	QP
70.85	17.99	8.20	1.82	28.01	30.00	-1.99	QP
125.00	6.00	13.61	2.48	22.08	30.00	-7.92	QP
143.25	13.09	12.98	2.50	28.56	30.00	-1.44	QP
173.48	11.15	11.60	3.03	25.78	30.00	-4.22	QP
180.00	8.00	11.21	3.10	22.31	30.00	-7.69	QP
219.43	10.76	10.91	3.39	25.06	30.00	-4.94	QP
250.00	11.32	11.86	3.70	26.88	37.00	-10.12	QP
300.00	6.60	13.49	4.10	24.19	37.00	-12.81	QP
360.00	8.00	14.57	4.52	27.09	37.00	-9.91	QP
500.00	3.40	17.93	5.40	26.73	37.00	-10.27	QP
600.00	8.22	18.45	5.90	32.57	37.00	-4.43	QP

**REMARK:** Emission level (dBuV/m) =Antenna Factor (dB/m) + Cable loss (dB) + Meter Reading (dBuV).

**8.6.3 TRANSMITTER RADIATED EMISSION ABOVE 1 GHz**

<b>Product Name</b>	Wireless-N Router w 3G+Modem & Voice	<b>Test Date</b>	2012/03/21
<b>Model</b>	Series 1098 Model 4530	<b>Test By</b>	John Chen
<b>Test Mode</b>	IEEE 802.11b TX (CH Low)	<b>TEMP&amp; Humidity</b>	25.9°C,56%

## Horizontal

TX / IEEE 802.11b mode / CH Low				Measurement Distance at 3m				Horizontal polarity	
Freq.	Reading	AF	Cable Loss	Pre-amp	Filter	Level	Limit	Margin	Mark
(MHz)	(dBμV)	(dB/m)	(dB)	(dB)	(dB)	(dBμV/m)	(dBμV/m)	(dB)	(P/Q/A)
* 1440.15	56.90	26.35	2.15	41.72	0.78	44.46	74.00	-29.54	P
* 1440.15	47.56	26.35	2.15	41.72	0.78	35.12	54.00	-18.88	A
* 4823.88	52.65	33.17	3.73	42.38	0.69	47.86	74.00	-26.14	P
* 4823.88	48.88	33.17	3.73	42.38	0.69	44.09	54.00	-9.91	A
N/A	-----	-----	-----	-----	-----	-----	-----	-----	P
N/A	-----	-----	-----	-----	-----	-----	-----	-----	A

<b>Product Name</b>	Wireless-N Router w 3G+Modem & Voice	<b>Test Date</b>	2012/03/21
<b>Model</b>	Series 1098 Model 4530	<b>Test By</b>	John Chen
<b>Test Mode</b>	IEEE 802.11b TX (CH Low)	<b>TEMP&amp; Humidity</b>	25.9°C,56%

## Vertical

TX / IEEE 802.11b mode / CH Low				Measurement Distance at 3m				Vertical polarity	
Freq.	Reading	AF	Cable Loss	Pre-amp	Filter	Level	Limit	Margin	Mark
(MHz)	(dBμV)	(dB/m)	(dB)	(dB)	(dB)	(dBμV/m)	(dBμV/m)	(dB)	(P/Q/A)
* 1440.05	57.62	26.35	2.15	41.72	0.78	45.18	74.00	-28.82	P
* 1440.05	50.34	26.35	2.15	41.72	0.78	37.90	54.00	-16.10	A
* 4874.12	54.82	33.32	3.74	42.43	0.71	50.17	74.00	-23.83	P
* 4874.12	48.13	33.32	3.74	42.43	0.71	43.48	54.00	-10.52	A
N/A	-----	-----	-----	-----	-----	-----	-----	-----	P
N/A	-----	-----	-----	-----	-----	-----	-----	-----	A

## REMARK:

1. AF: Antenna Factor, Cable: Cable Loss, Pre-Amp: Preamplifier gain, Filter: 2.4GHz~2.5GHz Filter Insertion Loss
2. Spectrum analyzer setting P(Peak): RBW=1MHz, VBW=1MHz, A(Average): RBW=1MHz, VBW=10Hz
3. The result basic equation calculation is as follow:  
Level = Reading + AF + Cable - Preamp + Filter, Margin = Level-Limit
4. The other emission levels were 20dB below the limit
5. The test limit distance is 3M limit.



<b>Product Name</b>	Wireless-N Router w 3G+Modem & Voice	<b>Test Date</b>	2012/03/21
<b>Model</b>	Series 1098 Model 4530	<b>Test By</b>	John Chen
<b>Test Mode</b>	IEEE 802.11b TX (CH Middle)	<b>TEMP&amp; Humidity</b>	25.9°C,56%

Horizontal

TX / IEEE 802.11b mode / CH Middle				Measurement Distance at 3m				Horizontal polarity	
Freq.	Reading	AF	Cable Loss	Pre-amp	Filter	Level	Limit	Margin	Mark
(MHz)	(dBμV)	(dB/m)	(dB)	(dB)	(dB)	(dBμV/m)	(dBμV/m)	(dB)	(P/Q/A)
* 1440.05	57.62	26.35	2.15	41.72	0.78	45.18	74.00	-28.82	P
* 1440.05	50.34	26.35	2.15	41.72	0.78	37.90	54.00	-16.10	A
* 4874.12	54.82	33.32	3.74	42.43	0.71	50.17	74.00	-23.83	P
* 4874.12	48.13	33.32	3.74	42.43	0.71	43.48	54.00	-10.52	A
N/A	-----	-----	-----	-----	-----	-----	-----	-----	P
N/A	-----	-----	-----	-----	-----	-----	-----	-----	A

<b>Product Name</b>	Wireless-N Router w 3G+Modem & Voice	<b>Test Date</b>	2012/03/21
<b>Model</b>	Series 1098 Model 4530	<b>Test By</b>	John Chen
<b>Test Mode</b>	IEEE 802.11b TX (CH Middle)	<b>TEMP&amp; Humidity</b>	25.9°C,56%

Vertical

TX / IEEE 802.11b mode / CH Middle				Measurement Distance at 3m				Vertical polarity	
Freq.	Reading	AF	Cable Loss	Pre-amp	Filter	Level	Limit	Margin	Mark
(MHz)	(dBμV)	(dB/m)	(dB)	(dB)	(dB)	(dBμV/m)	(dBμV/m)	(dB)	(P/Q/A)
* 1439.98	57.35	26.35	2.15	41.72	0.78	44.91	74.00	-29.09	P
* 1439.98	48.33	26.35	2.15	41.72	0.78	35.89	54.00	-18.11	A
* 4873.95	53.92	33.32	3.74	42.43	0.71	49.26	74.00	-24.74	P
* 4873.95	48.70	33.32	3.74	42.43	0.71	44.04	54.00	-9.96	A
N/A	-----	-----	-----	-----	-----	-----	-----	-----	P
N/A	-----	-----	-----	-----	-----	-----	-----	-----	A

REMARK:

1. AF: Antenna Factor, Cable: Cable Loss, Pre-Amp: Preamplifier gain, Filter: 2.4GHz~2.5GHz Filter Insertion Loss
2. Spectrum analyzer setting P(Peak): RBW=1MHz, VBW=1MHz, A(Average): RBW=1MHz, VBW=10Hz
3. The result basic equation calculation is as follow:  
Level = Reading + AF + Cable - Preamp + Filter , Margin = Level-Limit
4. The other emission levels were 20dB below the limit
5. The test limit distance is 3M limit.



<b>Product Name</b>	Wireless-N Router w 3G+Modem & Voice	<b>Test Date</b>	2012/03/21
<b>Model</b>	Series 1098 Model 4530	<b>Test By</b>	John Chen
<b>Test Mode</b>	IEEE 802.11b TX (CH High)	<b>TEMP&amp; Humidity</b>	25.9°C,56%

Horizontal

TX / IEEE 802.11b mode / CH High				Measurement Distance at 3m				Horizontal polarity	
Freq.	Reading	AF	Cable Loss	Pre-amp	Filter	Level	Limit	Margin	Mark
(MHz)	(dBμV)	(dB/m)	(dB)	(dB)	(dB)	(dBμV/m)	(dBμV/m)	(dB)	(P/Q/A)
* 1439.72	59.33	26.35	2.15	41.72	0.78	46.89	74.00	-27.11	P
* 1439.72	48.14	26.35	2.15	41.72	0.78	35.70	54.00	-18.30	A
* 4923.97	54.26	33.47	3.76	42.48	0.73	49.74	74.00	-24.26	P
* 4923.97	48.13	33.47	3.76	42.48	0.73	43.61	54.00	-10.39	A
N/A	-----	-----	-----	-----	-----	-----	-----	-----	P
N/A	-----	-----	-----	-----	-----	-----	-----	-----	A

<b>Product Name</b>	Wireless-N Router w 3G+Modem & Voice	<b>Test Date</b>	2012/03/21
<b>Model</b>	Series 1098 Model 4530	<b>Test By</b>	John Chen
<b>Test Mode</b>	IEEE 802.11b TX (CH High)	<b>TEMP&amp; Humidity</b>	25.9°C,56%

Vertical

TX / IEEE 802.11b mode / CH High				Measurement Distance at 3m				Vertical polarity	
Freq.	Reading	AF	Cable Loss	Pre-amp	Filter	Level	Limit	Margin	Mark
(MHz)	(dBμV)	(dB/m)	(dB)	(dB)	(dB)	(dBμV/m)	(dBμV/m)	(dB)	(P/Q/A)
* 1440.24	57.13	26.35	2.15	41.72	0.78	44.69	74.00	-29.31	P
* 1440.24	47.05	26.35	2.15	41.72	0.78	34.61	54.00	-19.39	A
* 4923.98	53.99	33.47	3.76	42.48	0.73	49.47	74.00	-24.53	P
* 4923.98	49.18	33.47	3.76	42.48	0.73	44.66	54.00	-9.34	A
N/A	-----	-----	-----	-----	-----	-----	-----	-----	P
N/A	-----	-----	-----	-----	-----	-----	-----	-----	A

REMARK:

1. AF: Antenna Factor, Cable: Cable Loss, Pre-Amp: Preamplifier gain, Filter: 2.4GHz~2.5GHz Filter Insertion Loss
2. Spectrum analyzer setting P(Peak): RBW=1MHz, VBW=1MHz, A(Average): RBW=1MHz, VBW=10Hz
3. The result basic equation calculation is as follow:  
Level = Reading + AF + Cable - Preamp + Filter, Margin = Level-Limit
4. The other emission levels were 20dB below the limit
5. The test limit distance is 3M limit.



<b>Product Name</b>	Wireless-N Router w 3G+Modem & Voice	<b>Test Date</b>	2012/03/21
<b>Model</b>	Series 1098 Model 4530	<b>Test By</b>	John Chen
<b>Test Mode</b>	IEEE 802.11g TX (CH Low)	<b>TEMP&amp; Humidity</b>	25.9°C,56%

Horizontal

TX / IEEE 802.11g mode / CH Low				Measurement Distance at 3m				Horizontal polarity	
Freq.	Reading	AF	Cable Loss	Pre-amp	Filter	Level	Limit	Margin	Mark
(MHz)	(dBµV)	(dB/m)	(dB)	(dB)	(dB)	(dBµV/m)	(dBµV/m)	(dB)	(P/Q/A)
* 4823.95	51.62	33.17	3.73	42.38	0.69	46.83	74.00	-27.17	P
* 4823.95	46.39	33.17	3.73	42.38	0.69	41.60	54.00	-12.40	A
7235.99	53.94	38.61	4.67	41.84	1.44	56.81	74.00	-17.19	P
7235.99	47.22	38.61	4.67	41.84	1.44	50.09	54.00	-3.91	A
N/A	-----	-----	-----	-----	-----	-----	-----	-----	P
N/A	-----	-----	-----	-----	-----	-----	-----	-----	A

<b>Product Name</b>	Wireless-N Router w 3G+Modem & Voice	<b>Test Date</b>	2012/03/21
<b>Model</b>	Series 1098 Model 4530	<b>Test By</b>	John Chen
<b>Test Mode</b>	IEEE 802.11g TX (CH Low)	<b>TEMP&amp; Humidity</b>	25.9°C,56%

Vertical

TX / IEEE 802.11g mode / CH Low				Measurement Distance at 3m				Vertical polarity	
Freq.	Reading	AF	Cable Loss	Pre-amp	Filter	Level	Limit	Margin	Mark
(MHz)	(dBµV)	(dB/m)	(dB)	(dB)	(dB)	(dBµV/m)	(dBµV/m)	(dB)	(P/Q/A)
* 4823.98	51.05	33.17	3.73	42.38	0.69	46.26	74.00	-27.74	P
* 4823.98	45.26	33.17	3.73	42.38	0.69	40.47	54.00	-13.53	A
7236.00	51.23	38.61	4.67	41.84	1.44	54.10	74.00	-19.90	P
7236.00	45.31	38.61	4.67	41.84	1.44	48.18	54.00	-5.82	A
N/A	-----	-----	-----	-----	-----	-----	-----	-----	P
N/A	-----	-----	-----	-----	-----	-----	-----	-----	A

REMARK:

1. AF: Antenna Factor, Cable: Cable Loss, Pre-Amp: Preamplifier gain, Filter: 2.4GHz~2.5GHz Filter Insertion Loss
2. Spectrum analyzer setting P(Peak): RBW=1MHz, VBW=1MHz, A(Average): RBW=1MHz, VBW=10Hz
3. The result basic equation calculation is as follow:  
Level = Reading + AF + Cable – Preamp + Filter , Margin = Level-Limit
4. The other emission levels were 20dB below the limit
5. The test limit distance is 3M limit.





<b>Product Name</b>	Wireless-N Router w 3G+Modem & Voice	<b>Test Date</b>	2012/03/21
<b>Model</b>	Series 1098 Model 4530	<b>Test By</b>	John Chen
<b>Test Mode</b>	IEEE 802.11g TX (CH Middle)	<b>TEMP&amp; Humidity</b>	25.9°C,56%

## Horizontal

TX / IEEE 802.11g mode / CH Middle		Measurement Distance at 3m				Horizontal polarity			
Freq.	Reading	AF	Cable Loss	Pre-amp	Filter	Level	Limit	Margin	Mark
(MHz)	(dBμV)	(dB/m)	(dB)	(dB)	(dB)	(dBμV/m)	(dBμV/m)	(dB)	(P/Q/A)
* 4873.99	53.95	33.32	3.74	42.43	0.71	49.29	74.00	-24.71	P
* 4873.99	47.88	33.32	3.74	42.43	0.71	43.22	54.00	-10.78	A
* 7311.12	54.36	38.83	4.71	41.72	1.60	57.77	74.00	-16.23	P
* 7311.12	48.39	38.83	4.71	41.72	1.60	51.80	54.00	-2.20	A
N/A	-----	-----	-----	-----	-----	-----	-----	-----	P
N/A	-----	-----	-----	-----	-----	-----	-----	-----	A

<b>Product Name</b>	Wireless-N Router w 3G+Modem & Voice	<b>Test Date</b>	2012/03/21
<b>Model</b>	Series 1098 Model 4530	<b>Test By</b>	John Chen
<b>Test Mode</b>	IEEE 802.11g TX (CH Middle)	<b>TEMP&amp; Humidity</b>	25.9°C,56%

## Vertical

TX / IEEE 802.11g mode / CH Middle		Measurement Distance at 3m				Vertical polarity			
Freq.	Reading	AF	Cable Loss	Pre-amp	Filter	Level	Limit	Margin	Mark
(MHz)	(dBμV)	(dB/m)	(dB)	(dB)	(dB)	(dBμV/m)	(dBμV/m)	(dB)	(P/Q/A)
* 4874.05	53.34	33.32	3.74	42.43	0.71	48.68	74.00	-25.32	P
* 4874.05	47.33	33.32	3.74	42.43	0.71	42.67	54.00	-11.33	A
* 7310.89	51.62	38.83	4.71	41.73	1.60	55.03	74.00	-18.97	P
* 7310.89	46.66	38.83	4.71	41.73	1.60	50.07	54.00	-3.93	A
N/A	-----	-----	-----	-----	-----	-----	-----	-----	P
N/A	-----	-----	-----	-----	-----	-----	-----	-----	A

## REMARK:

1. AF: Antenna Factor, Cable: Cable Loss, Pre-Amp: Preamplifier gain, Filter: 2.4GHz~2.5GHz Filter Insertion Loss
2. Spectrum analyzer setting P(Peak): RBW=1MHz, VBW=1MHz, A(Average): RBW=1MHz, VBW=10Hz
3. The result basic equation calculation is as follow:  
Level = Reading + AF + Cable - Preamp + Filter, Margin = Level-Limit
4. The other emission levels were 20dB below the limit
5. The test limit distance is 3M limit.



<b>Product Name</b>	Wireless-N Router w 3G+Modem & Voice	<b>Test Date</b>	2012/03/21
<b>Model</b>	Series 1098 Model 4530	<b>Test By</b>	John Chen
<b>Test Mode</b>	IEEE 802.11g TX (CH High)	<b>TEMP&amp; Humidity</b>	25.9°C,56%

Horizontal

TX / IEEE 802.11g mode / CH High				Measurement Distance at 3m				Horizontal polarity	
Freq.	Reading	AF	Cable Loss	Pre-amp	Filter	Level	Limit	Margin	Mark
(MHz)	(dBµV)	(dB/m)	(dB)	(dB)	(dB)	(dBµV/m)	(dBµV/m)	(dB)	(P/Q/A)
* 4923.86	50.14	33.47	3.76	42.48	0.73	45.62	74.00	-28.38	P
* 4923.86	45.92	33.47	3.76	42.48	0.73	41.40	54.00	-12.60	A
* 7385.81	52.84	39.06	4.75	41.61	1.76	56.79	74.00	-17.21	P
* 7385.81	46.46	39.06	4.75	41.61	1.76	50.41	54.00	-3.59	A
N/A	-----	-----	-----	-----	-----	-----	-----	-----	P
N/A	-----	-----	-----	-----	-----	-----	-----	-----	A

<b>Product Name</b>	Wireless-N Router w 3G+Modem & Voice	<b>Test Date</b>	2012/03/21
<b>Model</b>	Series 1098 Model 4530	<b>Test By</b>	John Chen
<b>Test Mode</b>	IEEE 802.11g TX (CH High)	<b>TEMP&amp; Humidity</b>	25.9°C,56%

Vertical

TX / IEEE 802.11g mode / CH High				Measurement Distance at 3m				Vertical polarity	
Freq.	Reading	AF	Cable Loss	Pre-amp	Filter	Level	Limit	Margin	Mark
(MHz)	(dBµV)	(dB/m)	(dB)	(dB)	(dB)	(dBµV/m)	(dBµV/m)	(dB)	(P/Q/A)
* 4923.94	49.85	33.47	3.76	42.48	0.73	45.33	74.00	-28.67	P
4923.94	44.32	33.47	3.76	42.48	0.73	39.80	54.00	-14.20	A
* 7385.93	51.56	39.06	4.75	41.61	1.76	55.51	74.00	-18.49	P
* 7385.93	45.40	39.06	4.75	41.61	1.76	49.35	54.00	-4.65	A
N/A	-----	-----	-----	-----	-----	-----	-----	-----	P
N/A	-----	-----	-----	-----	-----	-----	-----	-----	A

REMARK:

1. AF: Antenna Factor, Cable: Cable Loss, Pre-Amp: Preamplifier gain, Filter: 2.4GHz~2.5GHz Filter Insertion Loss
2. Spectrum analyzer setting P(Peak): RBW=1MHz, VBW=1MHz, A(Average): RBW=1MHz, VBW=10Hz
3. The result basic equation calculation is as follow:  
Level = Reading + AF + Cable - Preamp + Filter, Margin = Level-Limit
4. The other emission levels were 20dB below the limit
5. The test limit distance is 3M limit.



<b>Product Name</b>	Wireless-N Router w 3G+Modem & Voice	<b>Test Date</b>	2012/03/21
<b>Model</b>	Series 1098 Model 4530	<b>Test By</b>	John Chen
<b>Test Mode</b>	IEEE 802.11n HT20 TX (CH Low)	<b>TEMP&amp; Humidity</b>	25.9°C,56%

## Horizontal

TX / IEEE 802.11n HT20 mode / CH Low				Measurement Distance at 3m				Horizontal polarity		
Freq.	Reading	AF	Cable Loss	Pre-amp	Filter	Level	Limit	Margin	Mark	
(MHz)	(dBμV)	(dB/m)	(dB)	(dB)	(dB)	(dBμV/m)	(dBμV/m)	(dB)	(P/Q/A)	
* 4823.97	52.34	33.17	3.73	42.38	0.69	47.55	74.00	-26.45	P	
* 4823.97	46.10	33.17	3.73	42.38	0.69	41.31	54.00	-12.69	A	
7236.02	53.25	38.61	4.67	41.84	1.44	56.12	74.00	-17.88	P	
7236.02	46.25	38.61	4.67	41.84	1.44	49.12	54.00	-4.88	A	
N/A	-----	-----	-----	-----	-----	-----	-----	-----	P	
N/A	-----	-----	-----	-----	-----	-----	-----	-----	A	

<b>Product Name</b>	Wireless-N Router w 3G+Modem & Voice	<b>Test Date</b>	2012/03/21
<b>Model</b>	Series 1098 Model 4530	<b>Test By</b>	John Chen
<b>Test Mode</b>	IEEE 802.11n HT20 TX (CH Low)	<b>TEMP&amp; Humidity</b>	25.9°C,56%

## Vertical

TX / IEEE 802.11n HT20 mode / CH Low				Measurement Distance at 3m				Vertical polarity		
Freq.	Reading	AF	Cable Loss	Pre-amp	Filter	Level	Limit	Margin	Mark	
(MHz)	(dBμV)	(dB/m)	(dB)	(dB)	(dB)	(dBμV/m)	(dBμV/m)	(dB)	(P/Q/A)	
* 4823.91	51.02	33.17	3.73	42.38	0.69	46.23	74.00	-27.77	P	
* 4823.91	44.95	33.17	3.73	42.38	0.69	40.16	54.00	-13.84	A	
7239.84	51.69	38.62	4.68	41.84	1.44	54.59	74.00	-19.41	P	
7239.84	45.27	38.62	4.68	41.84	1.44	48.17	54.00	-5.83	A	
N/A	-----	-----	-----	-----	-----	-----	-----	-----	P	
N/A	-----	-----	-----	-----	-----	-----	-----	-----	A	

## REMARK:

1. AF: Antenna Factor, Cable: Cable Loss, Pre-Amp: Preamplifier gain, Filter: 2.4GHz~2.5GHz Filter Insertion Loss
2. Spectrum analyzer setting P(Peak): RBW=1MHz, VBW=1MHz, A(Average): RBW=1MHz, VBW=10Hz
3. The result basic equation calculation is as follow:  
Level = Reading + AF + Cable - Preamp + Filter, Margin = Level-Limit
4. The other emission levels were 20dB below the limit
5. The test limit distance is 3M limit.



<b>Product Name</b>	Wireless-N Router w 3G+Modem & Voice	<b>Test Date</b>	2012/03/21
<b>Model</b>	Series 1098 Model 4530	<b>Test By</b>	John Chen
<b>Test Mode</b>	IEEE 802.11n HT20 TX (CH Middle)	<b>TEMP&amp; Humidity</b>	25.9°C,56%

Horizontal

TX / IEEE 802.11n HT20 mode / CH Middle				Measurement Distance at 3m				Horizontal polarity		
Freq.	Reading	AF	Cable Loss	Pre-amp	Filter	Level	Limit	Margin	Mark	
(MHz)	(dBµV)	(dB/m)	(dB)	(dB)	(dB)	(dBµV/m)	(dBµV/m)	(dB)	(P/Q/A)	
* 4873.92	53.65	33.32	3.74	42.43	0.71	48.99	74.00	-25.01	P	
* 4873.92	47.20	33.32	3.74	42.43	0.71	42.54	54.00	-11.46	A	
* 7311.07	55.64	38.83	4.71	41.72	1.60	59.05	74.00	-14.95	P	
* 7311.07	48.33	38.83	4.71	41.72	1.60	51.74	54.00	-2.26	A	
N/A	-----	-----	-----	-----	-----	-----	-----	-----	P	
N/A	-----	-----	-----	-----	-----	-----	-----	-----	A	

<b>Product Name</b>	Wireless-N Router w 3G+Modem & Voice	<b>Test Date</b>	2012/03/21
<b>Model</b>	Series 1098 Model 4530	<b>Test By</b>	John Chen
<b>Test Mode</b>	IEEE 802.11n HT20 TX (CH Middle)	<b>TEMP&amp; Humidity</b>	25.9°C,56%

Vertical

TX / IEEE 802.11n HT20 mode / CH Middle				Measurement Distance at 3m				Vertical polarity		
Freq.	Reading	AF	Cable Loss	Pre-amp	Filter	Level	Limit	Margin	Mark	
(MHz)	(dBµV)	(dB/m)	(dB)	(dB)	(dB)	(dBµV/m)	(dBµV/m)	(dB)	(P/Q/A)	
* 4873.97	52.94	33.32	3.74	42.43	0.71	48.28	74.00	-25.72	P	
* 4873.97	46.14	33.32	3.74	42.43	0.71	41.48	54.00	-12.52	A	
* 7311.03	51.02	38.83	4.71	41.72	1.60	54.43	74.00	-19.57	P	
* 7311.03	45.87	38.83	4.71	41.72	1.60	49.28	54.00	-4.72	A	
N/A	-----	-----	-----	-----	-----	-----	-----	-----	P	
N/A	-----	-----	-----	-----	-----	-----	-----	-----	A	

REMARK:

1. AF: Antenna Factor, Cable: Cable Loss, Pre-Amp: Preamplifier gain, Filter: 2.4GHz~2.5GHz Filter Insertion Loss
2. Spectrum analyzer setting P(Peak): RBW=1MHz, VBW=1MHz, A(Average): RBW=1MHz, VBW=10Hz
3. The result basic equation calculation is as follow:  
Level = Reading + AF + Cable - Preamp + Filter, Margin = Level-Limit
4. The other emission levels were 20dB below the limit
5. The test limit distance is 3M limit.



<b>Product Name</b>	Wireless-N Router w 3G+Modem & Voice	<b>Test Date</b>	2012/03/21
<b>Model</b>	Series 1098 Model 4530	<b>Test By</b>	John Chen
<b>Test Mode</b>	IEEE 802.11n HT20 TX (CH High)	<b>TEMP&amp; Humidity</b>	25.9°C,56%

## Horizontal

TX / IEEE 802.11n HT20 mode / CH High				Measurement Distance at 3m				Horizontal polarity	
Freq.	Reading	AF	Cable Loss	Pre-amp	Filter	Level	Limit	Margin	Mark
(MHz)	(dBμV)	(dB/m)	(dB)	(dB)	(dB)	(dBμV/m)	(dBμV/m)	(dB)	(P/Q/A)
* 4923.99	50.99	33.47	3.76	42.48	0.73	46.47	74.00	-27.53	P
* 4923.99	45.31	33.47	3.76	42.48	0.73	40.79	54.00	-13.21	A
* 7386.04	53.46	39.06	4.75	41.61	1.76	57.41	74.00	-16.59	P
* 7386.04	46.70	39.06	4.75	41.61	1.76	50.65	54.00	-3.35	A
N/A	-----	-----	-----	-----	-----	-----	-----	-----	P
N/A	-----	-----	-----	-----	-----	-----	-----	-----	A

<b>Product Name</b>	Wireless-N Router w 3G+Modem & Voice	<b>Test Date</b>	2012/03/21
<b>Model</b>	Series 1098 Model 4530	<b>Test By</b>	John Chen
<b>Test Mode</b>	IEEE 802.11n HT20 TX (CH High)	<b>TEMP&amp; Humidity</b>	25.9°C,56%

## Vertical

TX / IEEE 802.11n HT20 mode / CH High				Measurement Distance at 3m				Vertical polarity	
Freq.	Reading	AF	Cable Loss	Pre-amp	Filter	Level	Limit	Margin	Mark
(MHz)	(dBμV)	(dB/m)	(dB)	(dB)	(dB)	(dBμV/m)	(dBμV/m)	(dB)	(P/Q/A)
* 4923.95	50.04	33.47	3.76	42.48	0.73	45.52	74.00	-28.48	P
* 4923.95	45.19	33.47	3.76	42.48	0.73	40.67	54.00	-13.33	A
* 7385.94	51.45	39.06	4.75	41.61	1.76	55.40	74.00	-18.60	P
* 7385.94	45.36	39.06	4.75	41.61	1.76	49.31	54.00	-4.69	A
N/A	-----	-----	-----	-----	-----	-----	-----	-----	P
N/A	-----	-----	-----	-----	-----	-----	-----	-----	A

## REMARK:

1. AF: Antenna Factor, Cable: Cable Loss, Pre-Amp: Preamplifier gain, Filter: 2.4GHz~2.5GHz Filter Insertion Loss
2. Spectrum analyzer setting P(Peak): RBW=1MHz, VBW=1MHz, A(Average): RBW=1MHz, VBW=10Hz
3. The result basic equation calculation is as follow:  
Level = Reading + AF + Cable - Preamp + Filter, Margin = Level-Limit
4. The other emission levels were 20dB below the limit
5. The test limit distance is 3M limit.



<b>Product Name</b>	Wireless-N Router w 3G+Modem & Voice	<b>Test Date</b>	2012/03/21
<b>Model</b>	Series 1098 Model 4530	<b>Test By</b>	John Chen
<b>Test Mode</b>	IEEE 802.11n HT40 TX (CH Low)	<b>TEMP&amp; Humidity</b>	25.9°C,56%

## Horizontal

TX / IEEE 802.11n HT40 mode / CH Low				Measurement Distance at 3m				Horizontal polarity		
Freq.	Reading	AF	Cable Loss	Pre-amp	Filter	Level	Limit	Margin	Mark	
(MHz)	(dBμV)	(dB/m)	(dB)	(dB)	(dB)	(dBμV/m)	(dBμV/m)	(dB)	(P/Q/A)	
* 4843.98	50.14	33.23	3.74	42.40	0.70	45.40	74.00	-28.60	P	
* 4843.98	44.83	33.23	3.74	42.40	0.70	40.09	54.00	-13.91	A	
* 7265.93	52.73	38.70	4.69	41.80	1.50	55.82	74.00	-18.18	P	
* 7265.93	46.68	38.70	4.69	41.80	1.50	49.77	54.00	-4.23	A	
N/A	-----	-----	-----	-----	-----	-----	-----	-----	P	
N/A	-----	-----	-----	-----	-----	-----	-----	-----	A	

<b>Product Name</b>	Wireless-N Router w 3G+Modem & Voice	<b>Test Date</b>	2012/03/21
<b>Model</b>	Series 1098 Model 4530	<b>Test By</b>	John Chen
<b>Test Mode</b>	IEEE 802.11n HT40 TX (CH Low)	<b>TEMP&amp; Humidity</b>	25.9°C,56%

## Vertical

TX / IEEE 802.11n HT40 mode / CH Low				Measurement Distance at 3m				Vertical polarity		
Freq.	Reading	AF	Cable Loss	Pre-amp	Filter	Level	Limit	Margin	Mark	
(MHz)	(dBμV)	(dB/m)	(dB)	(dB)	(dB)	(dBμV/m)	(dBμV/m)	(dB)	(P/Q/A)	
* 4843.92	51.22	33.23	3.74	42.40	0.70	46.48	74.00	-27.52	P	
* 4843.92	45.03	33.23	3.74	42.40	0.70	40.29	54.00	-13.71	A	
* 7265.88	51.92	38.70	4.69	41.80	1.50	55.01	74.00	-18.99	P	
* 7265.88	46.37	38.70	4.69	41.80	1.50	49.46	54.00	-4.54	A	
N/A	-----	-----	-----	-----	-----	-----	-----	-----	P	
N/A	-----	-----	-----	-----	-----	-----	-----	-----	A	

## REMARK:

1. AF: Antenna Factor, Cable: Cable Loss, Pre-Amp: Preamplifier gain, Filter: 2.4GHz~2.5GHz Filter Insertion Loss
2. Spectrum analyzer setting P(Peak): RBW=1MHz, VBW=1MHz, A(Average): RBW=1MHz, VBW=10Hz
3. The result basic equation calculation is as follow:  
Level = Reading + AF + Cable - Preamp + Filter, Margin = Level-Limit
4. The other emission levels were 20dB below the limit
5. The test limit distance is 3M limit.



<b>Product Name</b>	Wireless-N Router w 3G+Modem & Voice	<b>Test Date</b>	2012/03/21
<b>Model</b>	Series 1098 Model 4530	<b>Test By</b>	John Chen
<b>Test Mode</b>	IEEE 802.11n HT40 TX (CH Middle)	<b>TEMP&amp; Humidity</b>	25.9°C,56%

Horizontal

TX / IEEE 802.11n HT40 mode / CH Middle				Measurement Distance at 3m				Horizontal polarity		
Freq.	Reading	AF	Cable Loss	Pre-amp	Filter	Level	Limit	Margin	Mark	
(MHz)	(dBμV)	(dB/m)	(dB)	(dB)	(dB)	(dBμV/m)	(dBμV/m)	(dB)	(P/Q/A)	
* 4873.96	52.41	33.32	3.74	42.43	0.71	47.75	74.00	-26.25	P	
* 4873.96	46.82	33.32	3.74	42.43	0.71	42.16	54.00	-11.84	A	
* 7310.92	53.11	38.83	4.71	41.72	1.60	56.52	74.00	-17.48	P	
* 7310.92	47.85	38.83	4.71	41.72	1.60	51.26	54.00	-2.74	A	
N/A	-----	-----	-----	-----	-----	-----	-----	-----	P	
N/A	-----	-----	-----	-----	-----	-----	-----	-----	A	

<b>Product Name</b>	Wireless-N Router w 3G+Modem & Voice	<b>Test Date</b>	2012/03/21
<b>Model</b>	Series 1098 Model 4530	<b>Test By</b>	John Chen
<b>Test Mode</b>	IEEE 802.11n HT40 TX (CH Middle)	<b>TEMP&amp; Humidity</b>	25.9°C,56%

Vertical

TX / IEEE 802.11n HT40 mode / CH Middle				Measurement Distance at 3m				Vertical polarity		
Freq.	Reading	AF	Cable Loss	Pre-amp	Filter	Level	Limit	Margin	Mark	
(MHz)	(dBμV)	(dB/m)	(dB)	(dB)	(dB)	(dBμV/m)	(dBμV/m)	(dB)	(P/Q/A)	
* 4873.98	51.39	33.32	3.74	42.43	0.71	46.73	74.00	-27.27	P	
* 4873.98	45.70	33.32	3.74	42.43	0.71	41.04	54.00	-12.96	A	
* 7310.94	51.32	38.83	4.71	41.72	1.60	54.73	74.00	-19.27	P	
* 7310.94	47.18	38.83	4.71	41.72	1.60	50.59	54.00	-3.41	A	
N/A	-----	-----	-----	-----	-----	-----	-----	-----	P	
N/A	-----	-----	-----	-----	-----	-----	-----	-----	A	

REMARK:

1. AF: Antenna Factor, Cable: Cable Loss, Pre-Amp: Preamplifier gain, Filter: 2.4GHz~2.5GHz Filter Insertion Loss
2. Spectrum analyzer setting P(Peak): RBW=1MHz, VBW=1MHz, A(Average): RBW=1MHz, VBW=10Hz
3. The result basic equation calculation is as follow:  
Level = Reading + AF + Cable - Preamp + Filter, Margin = Level-Limit
4. The other emission levels were 20dB below the limit
5. The test limit distance is 3M limit.



<b>Product Name</b>	Wireless-N Router w 3G+Modem & Voice	<b>Test Date</b>	2012/03/21
<b>Model</b>	Series 1098 Model 4530	<b>Test By</b>	John Chen
<b>Test Mode</b>	IEEE 802.11n HT40 TX (CH High)	<b>TEMP&amp; Humidity</b>	25.9°C,56%

Horizontal

TX / IEEE 802.11n HT40 mode / CH High				Measurement Distance at 3m				Horizontal polarity	
Freq.	Reading	AF	Cable Loss	Pre-amp	Filter	Level	Limit	Margin	Mark
(MHz)	(dBµV)	(dB/m)	(dB)	(dB)	(dB)	(dBµV/m)	(dBµV/m)	(dB)	(P/Q/A)
* 4903.95	50.08	33.41	3.75	42.46	0.72	45.50	74.00	-28.50	P
* 4903.95	45.66	33.41	3.75	42.46	0.72	41.08	54.00	-12.92	A
* 7355.94	51.94	38.97	4.73	41.65	1.69	55.68	74.00	-18.32	P
* 7355.94	45.83	38.97	4.73	41.65	1.69	49.57	54.00	-4.43	A
N/A	-----	-----	-----	-----	-----	-----	-----	-----	P
N/A	-----	-----	-----	-----	-----	-----	-----	-----	A

<b>Product Name</b>	Wireless-N Router w 3G+Modem & Voice	<b>Test Date</b>	2012/03/21
<b>Model</b>	Series 1098 Model 4530	<b>Test By</b>	John Chen
<b>Test Mode</b>	IEEE 802.11n HT40 TX (CH High)	<b>TEMP&amp; Humidity</b>	25.9°C,56%

Vertical

TX / IEEE 802.11n HT40 mode / CH High				Measurement Distance at 3m				Vertical polarity	
Freq.	Reading	AF	Cable Loss	Pre-amp	Filter	Level	Limit	Margin	Mark
(MHz)	(dBµV)	(dB/m)	(dB)	(dB)	(dB)	(dBµV/m)	(dBµV/m)	(dB)	(P/Q/A)
* 4903.94	49.91	33.41	3.75	42.46	0.72	45.33	74.00	-28.67	P
* 4903.94	43.94	33.41	3.75	42.46	0.72	39.36	54.00	-14.64	A
* 7355.91	51.23	38.97	4.73	41.65	1.69	54.97	74.00	-19.03	P
* 7355.91	45.43	38.97	4.73	41.65	1.69	49.17	54.00	-4.83	A
N/A	-----	-----	-----	-----	-----	-----	-----	-----	P
N/A	-----	-----	-----	-----	-----	-----	-----	-----	A

REMARK:

1. AF: Antenna Factor, Cable: Cable Loss, Pre-Amp: Preamplifier gain, Filter: 2.4GHz~2.5GHz Filter Insertion Loss
2. Spectrum analyzer setting P(Peak): RBW=1MHz, VBW=1MHz, A(Average): RBW=1MHz, VBW=10Hz
3. The result basic equation calculation is as follow:  
Level = Reading + AF + Cable - Preamp + Filter , Margin = Level-Limit
4. The other emission levels were 20dB below the limit
5. The test limit distance is 3M limit.





### 8.6.4 RESTRICTED BAND EDGES

Detector mode : Peak

Polarity : Horizontal

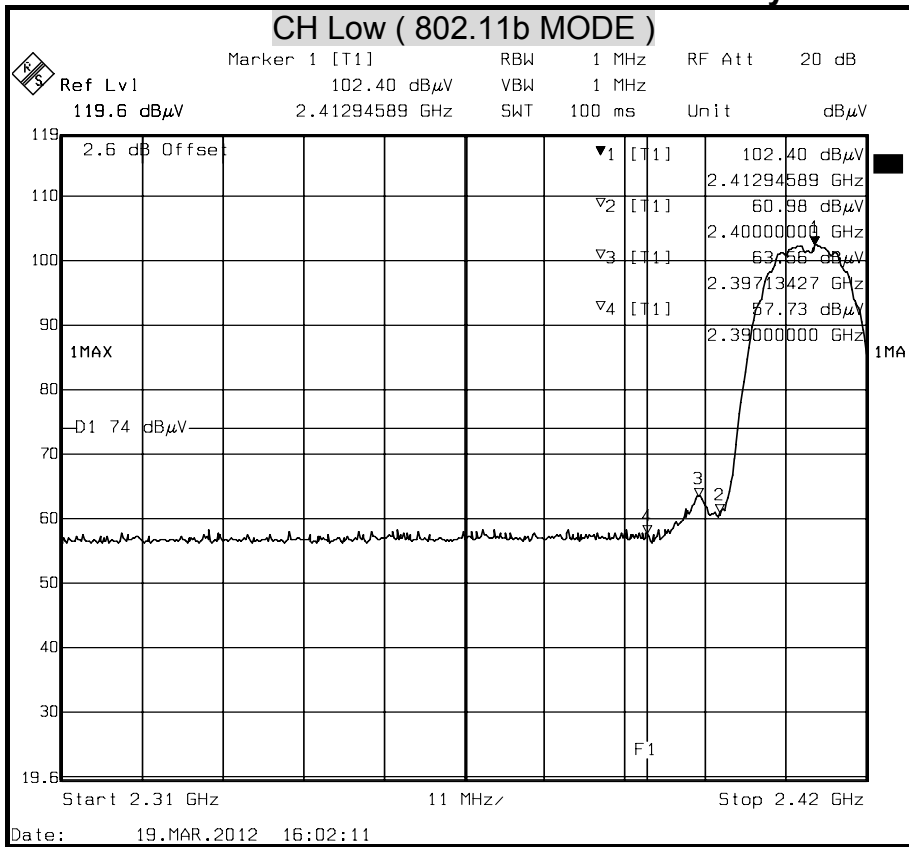

Detector mode : Average

Polarity : Horizontal

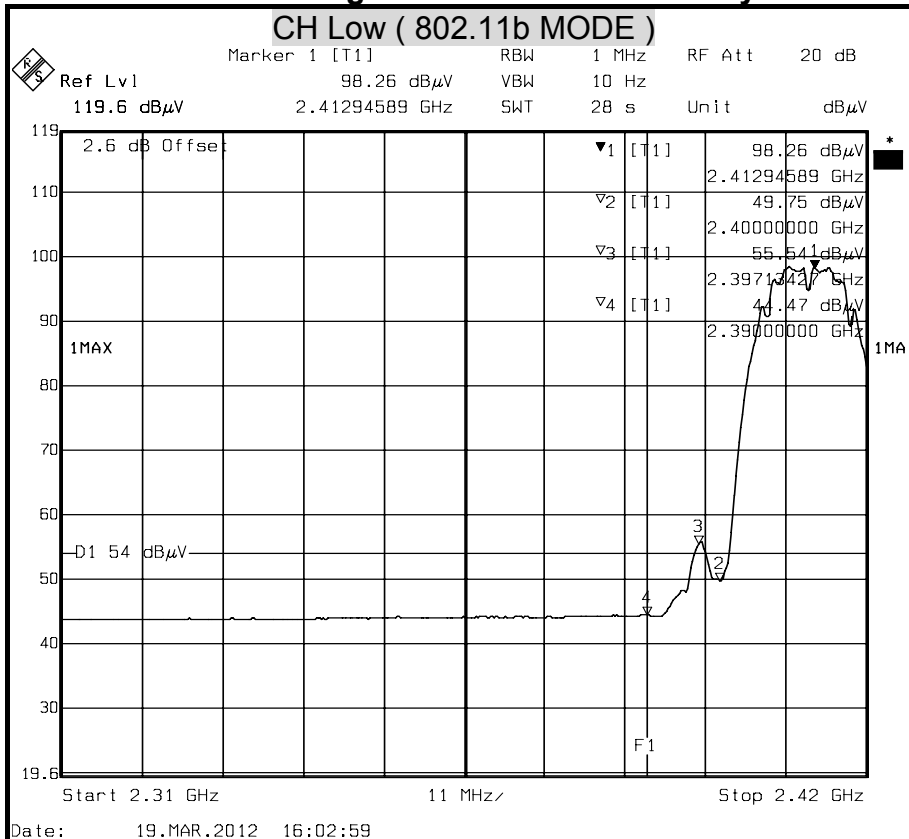



Detector mode : Peak

Polarity : Vertical

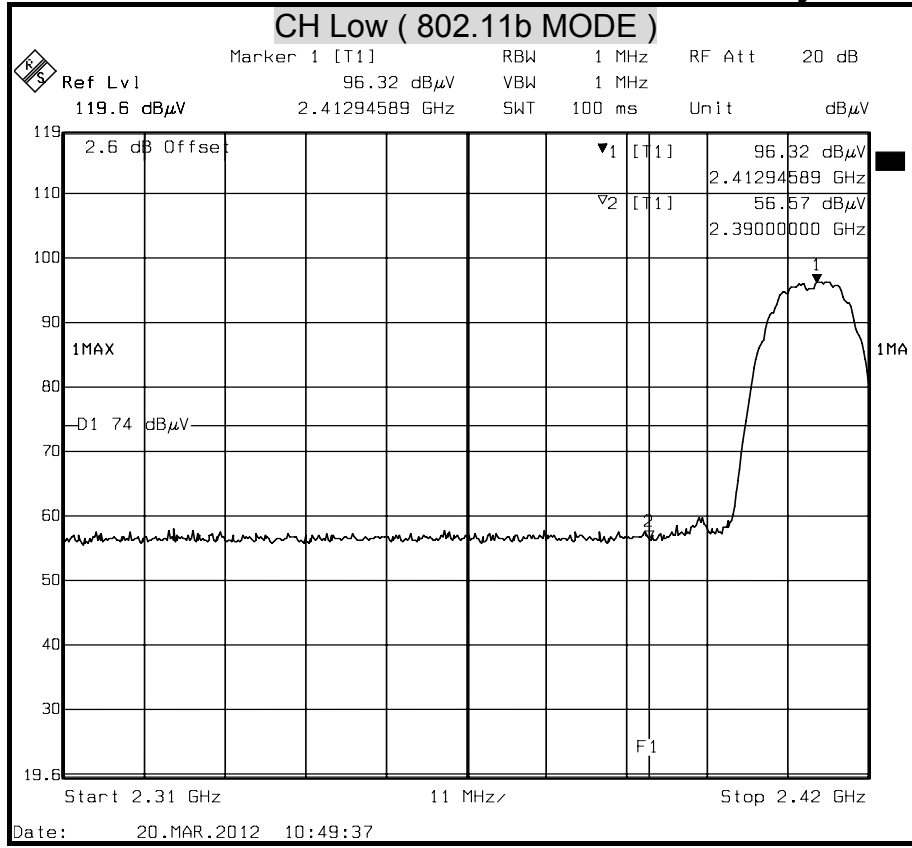

Detector mode : Average

Polarity : Vertical

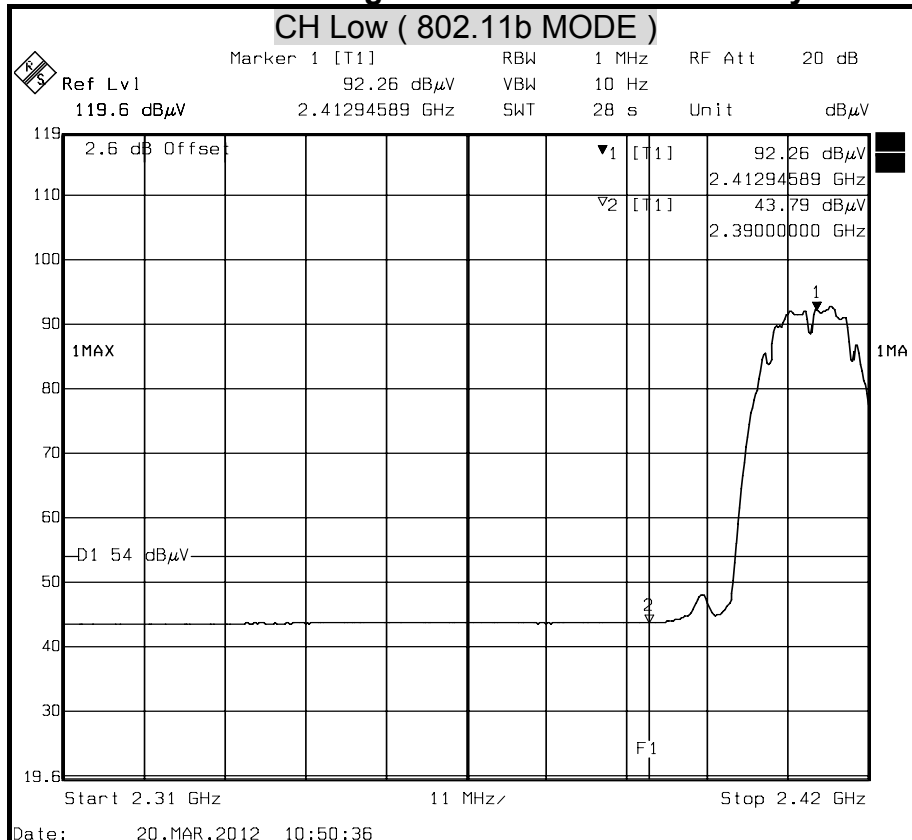



Detector mode : Peak

Polarity : Horizontal

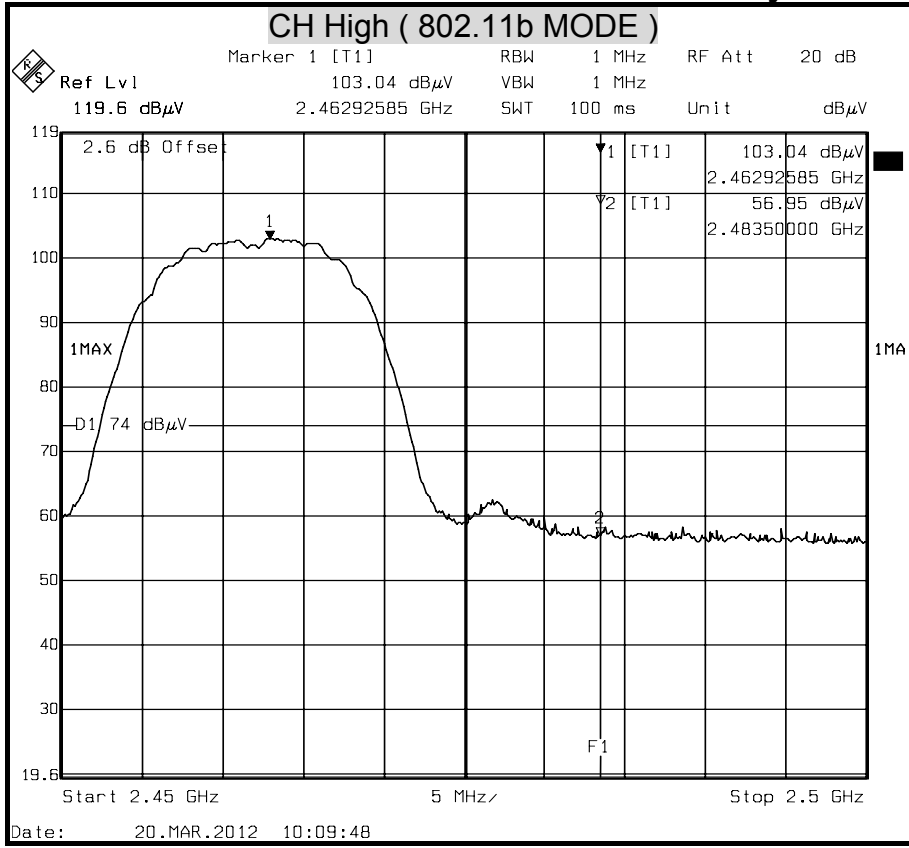

Detector mode : Average

Polarity : Horizontal

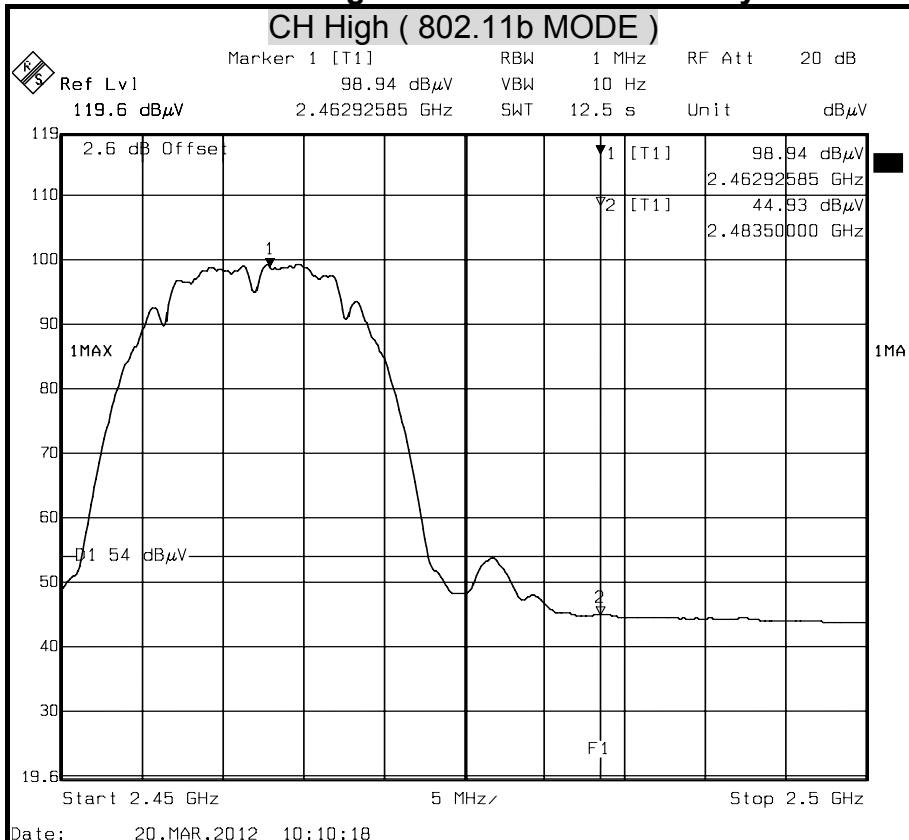



Detector mode : Peak

Polarity : Vertical

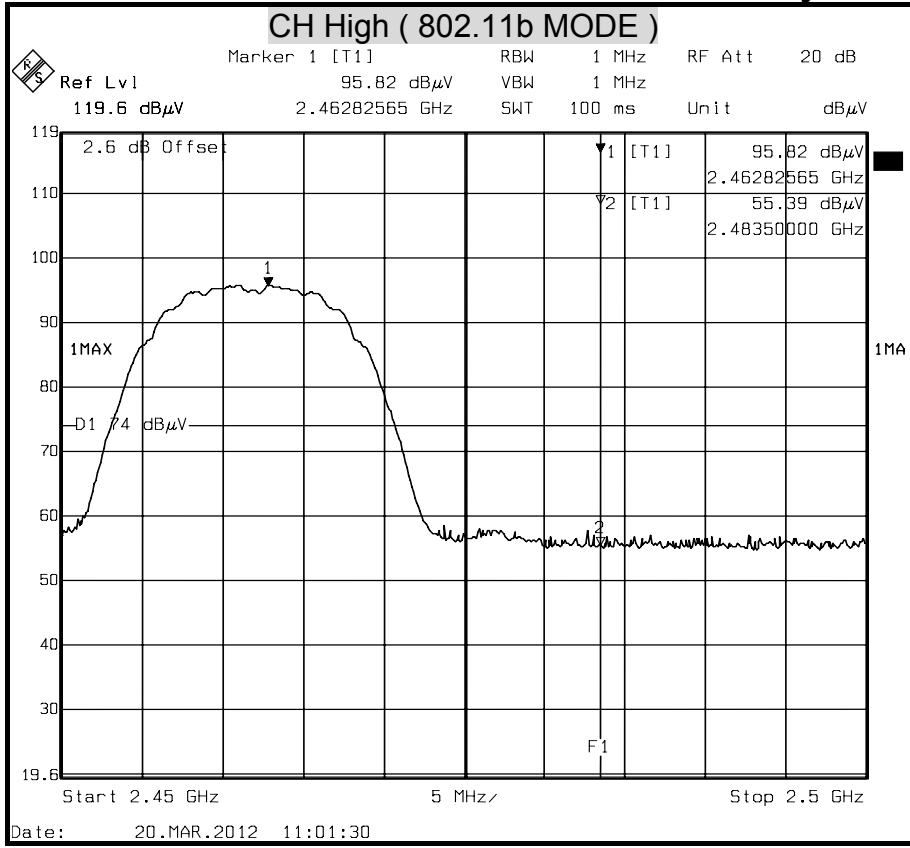

Detector mode : Average

Polarity : Vertical

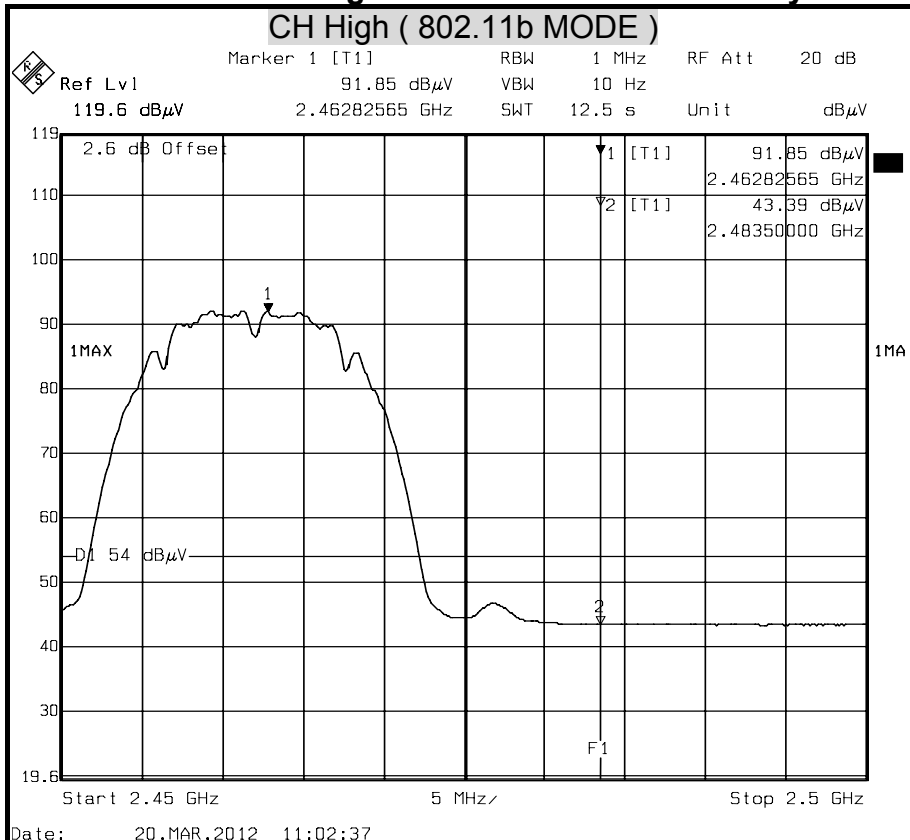



Detector mode : Peak

Polarity : Horizontal

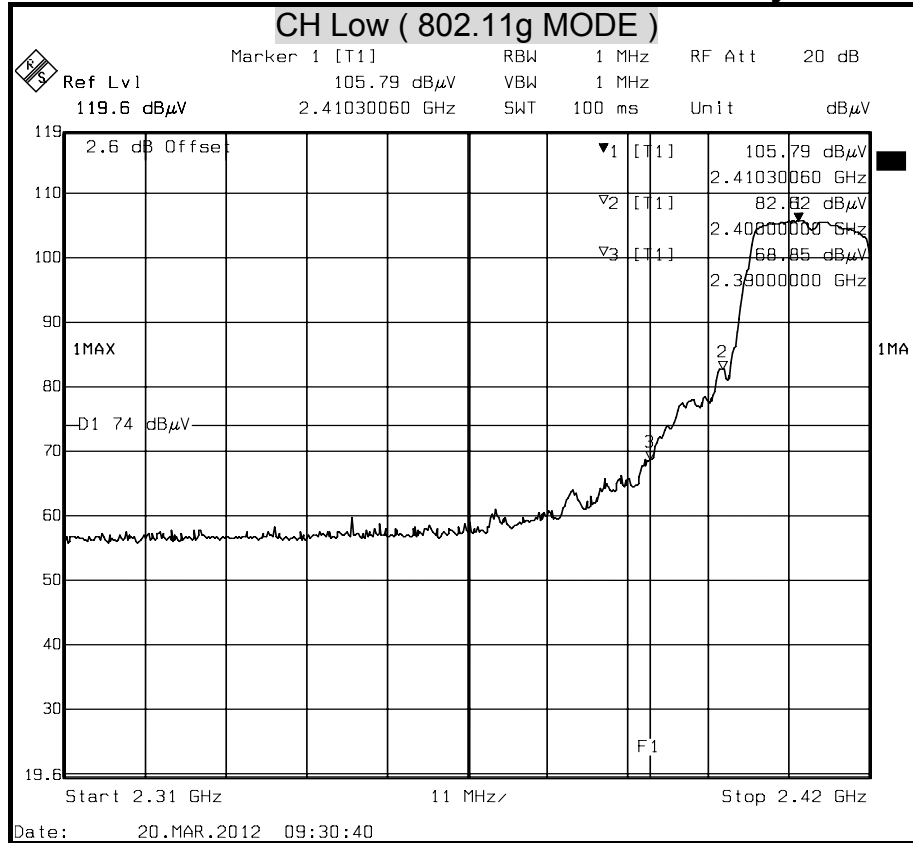

Detector mode : Average

Polarity : Horizontal

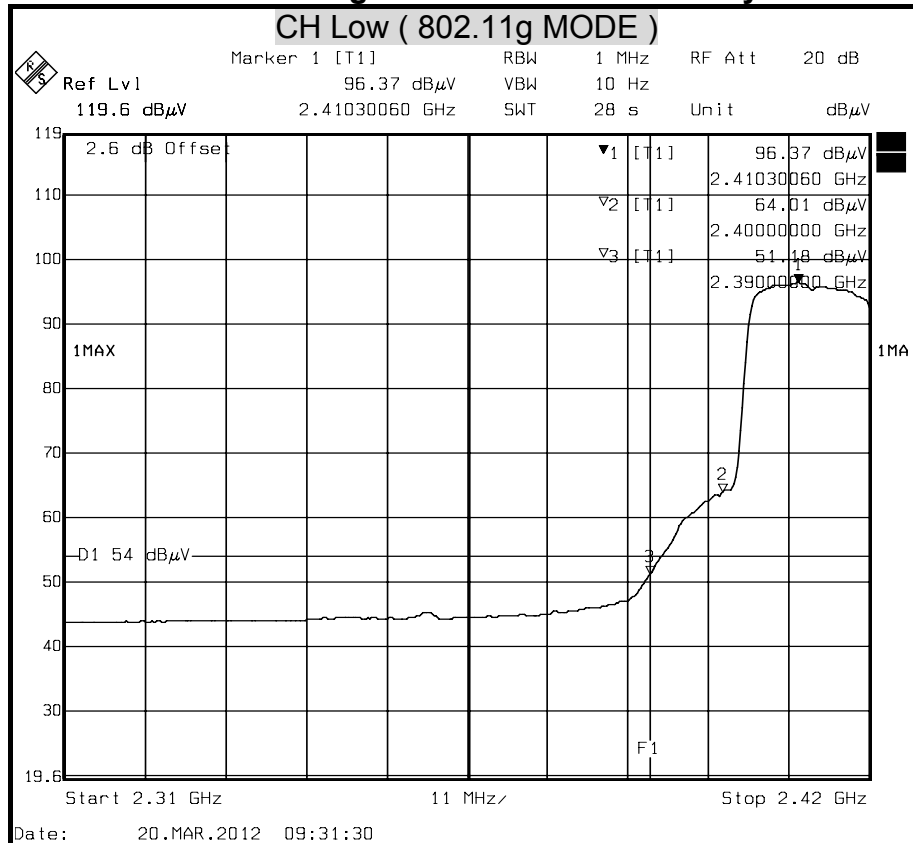



Detector mode : Peak

Polarity : Vertical

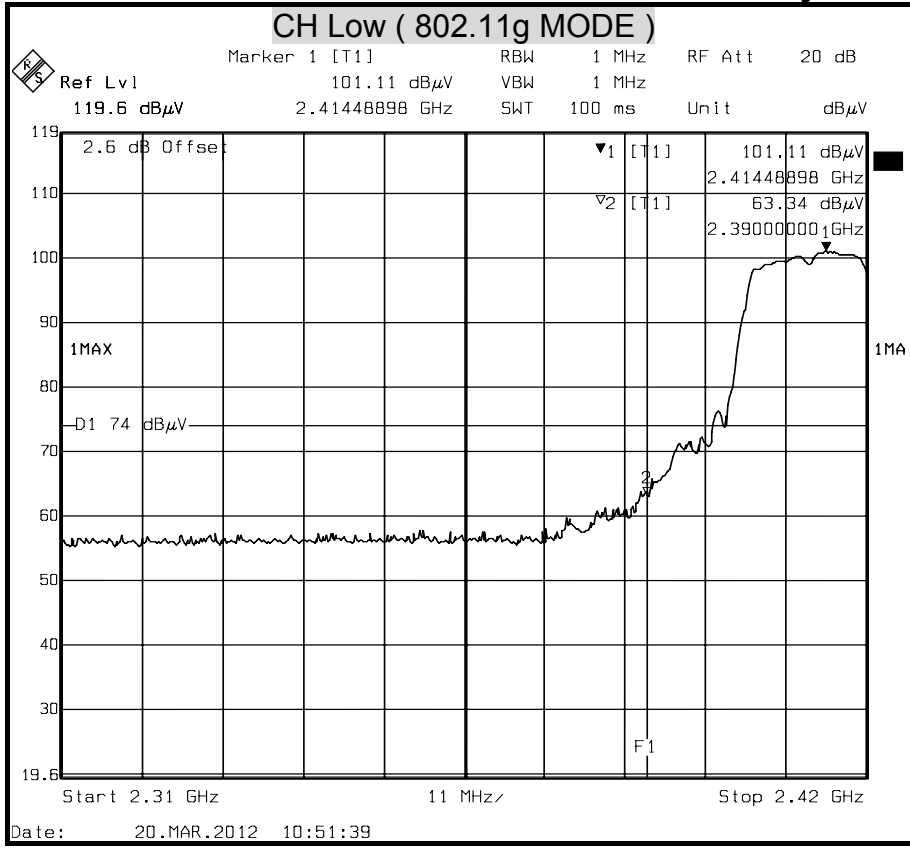

Detector mode : Average

Polarity : Vertical

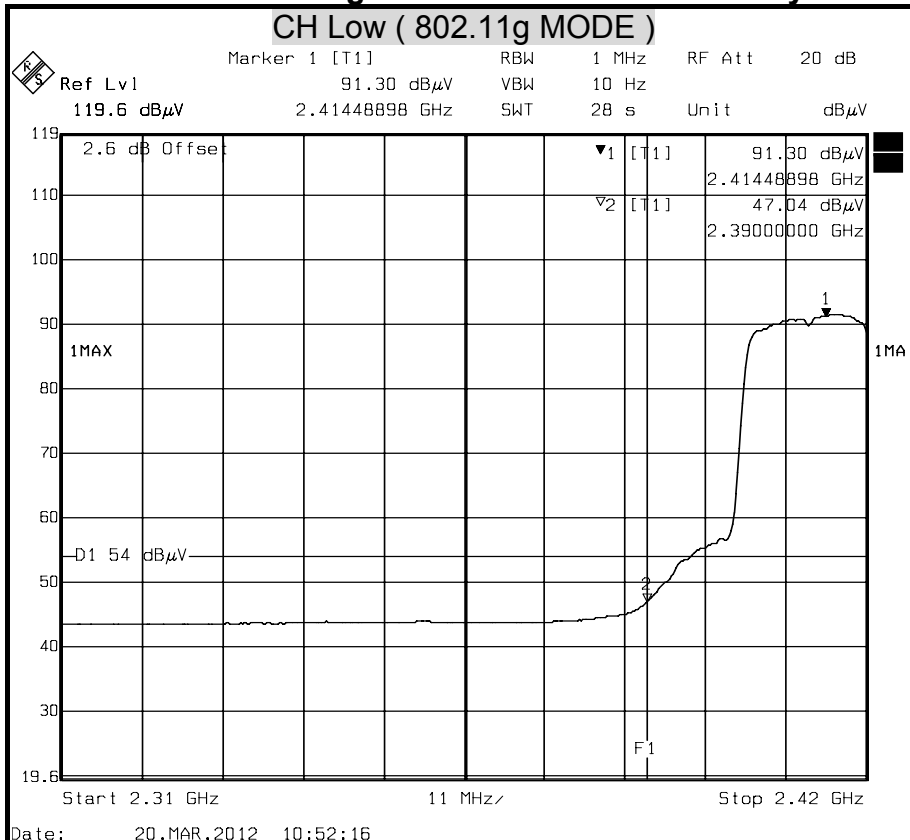



Detector mode : Peak

Polarity : Horizontal

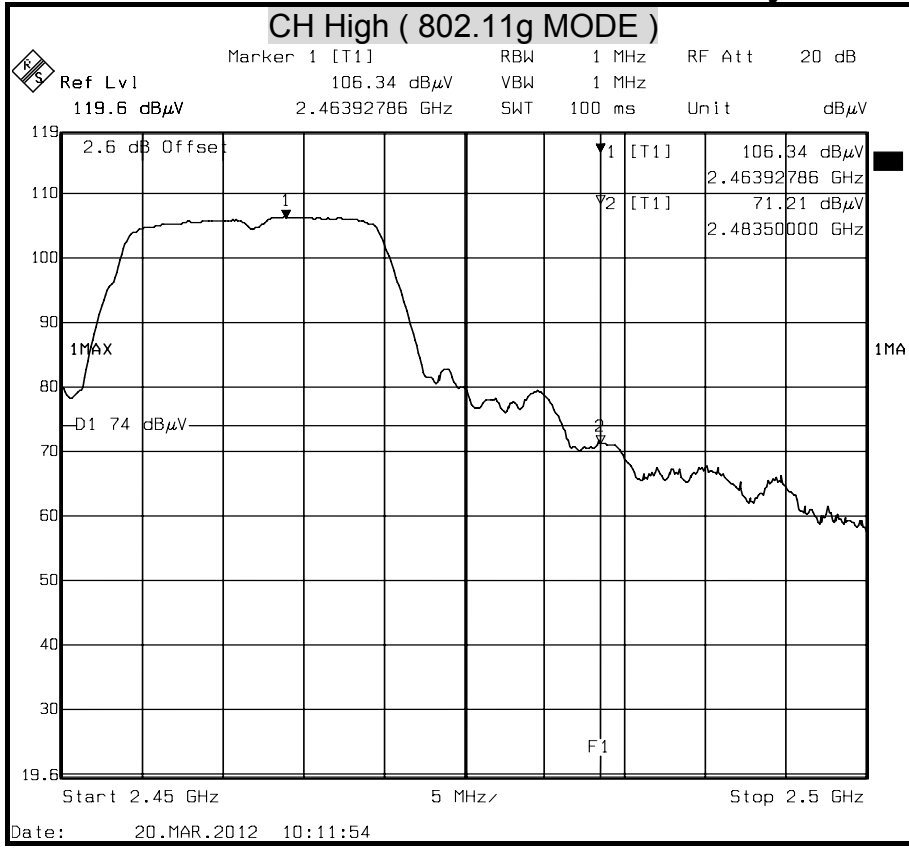

Detector mode : Average

Polarity : Horizontal

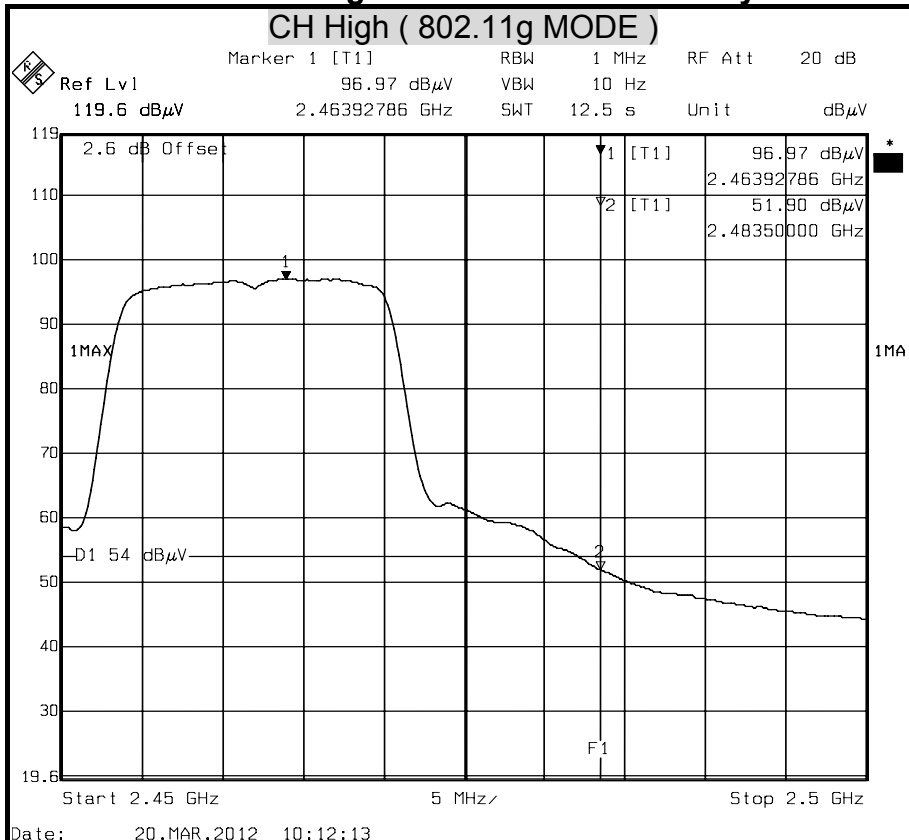



Detector mode : Peak

Polarity : Vertical

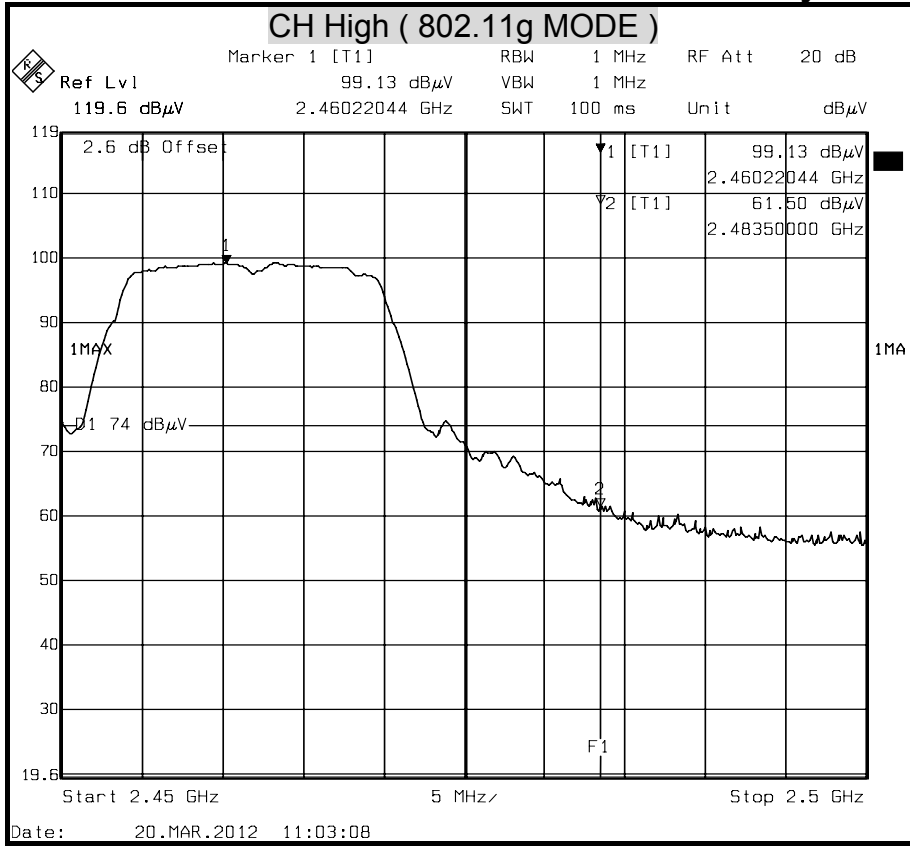

Detector mode : Average

Polarity : Vertical

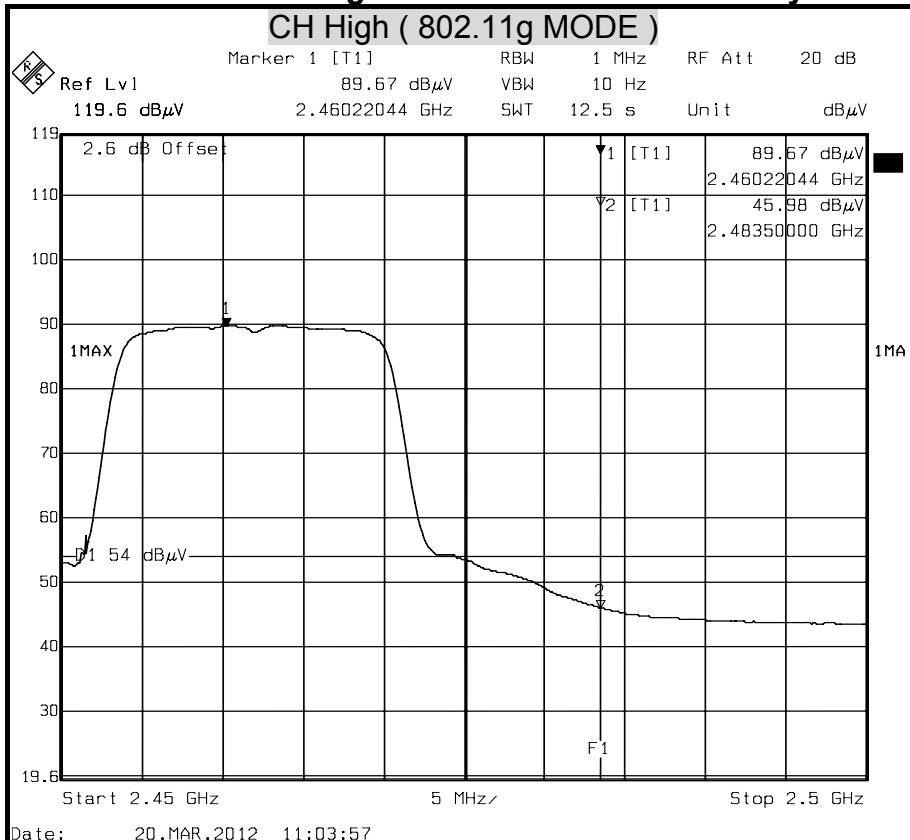





Detector mode : Peak

Polarity : Horizontal

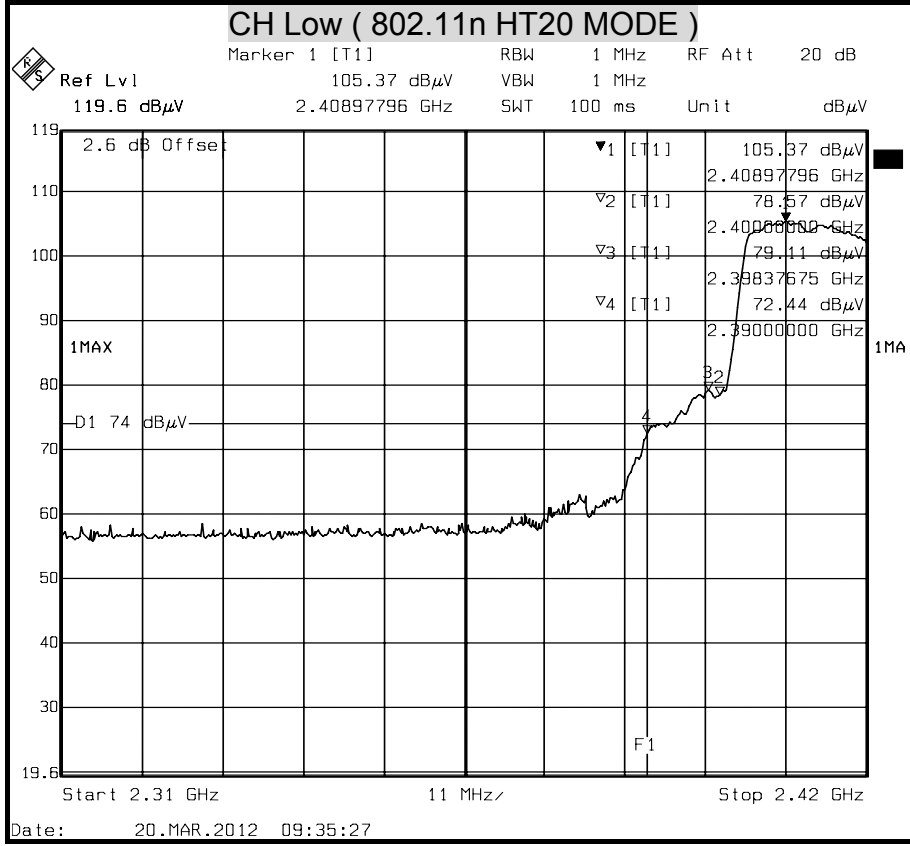

Detector mode : Average

Polarity : Horizontal

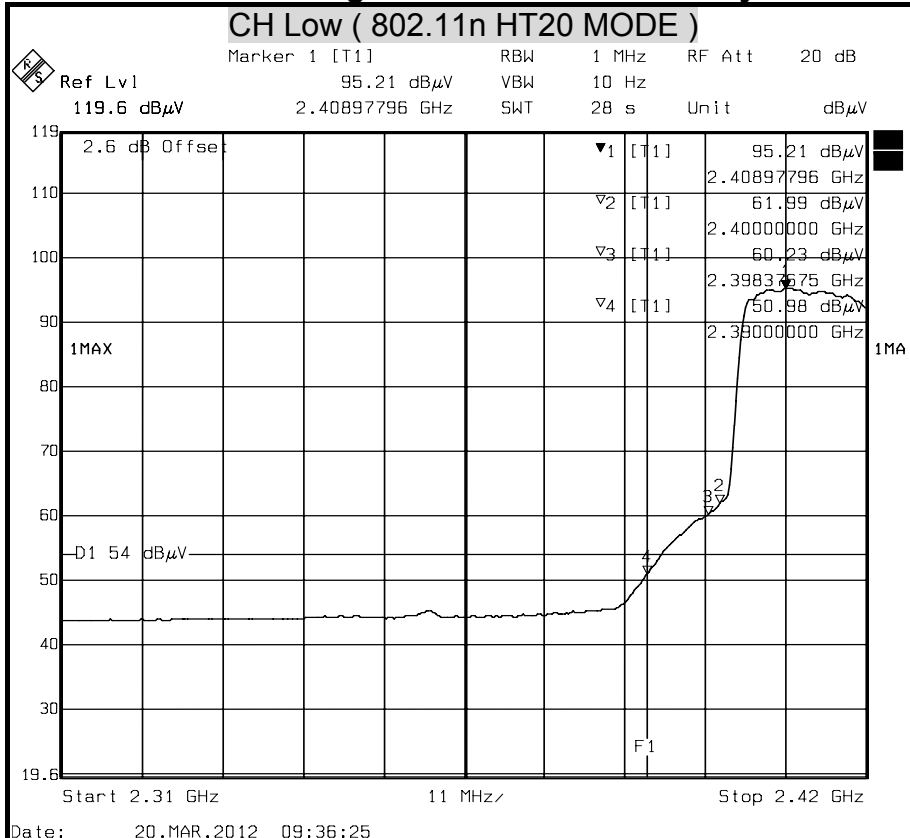



Detector mode : Peak

Polarity : Vertical

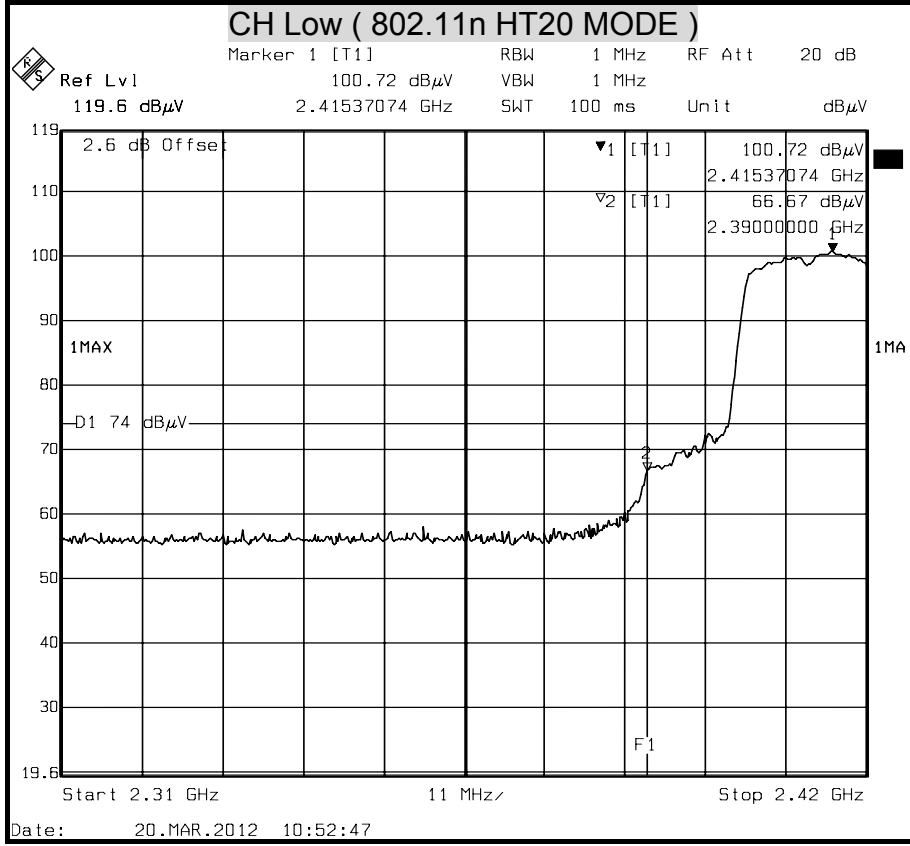

Detector mode : Average

Polarity : Vertical

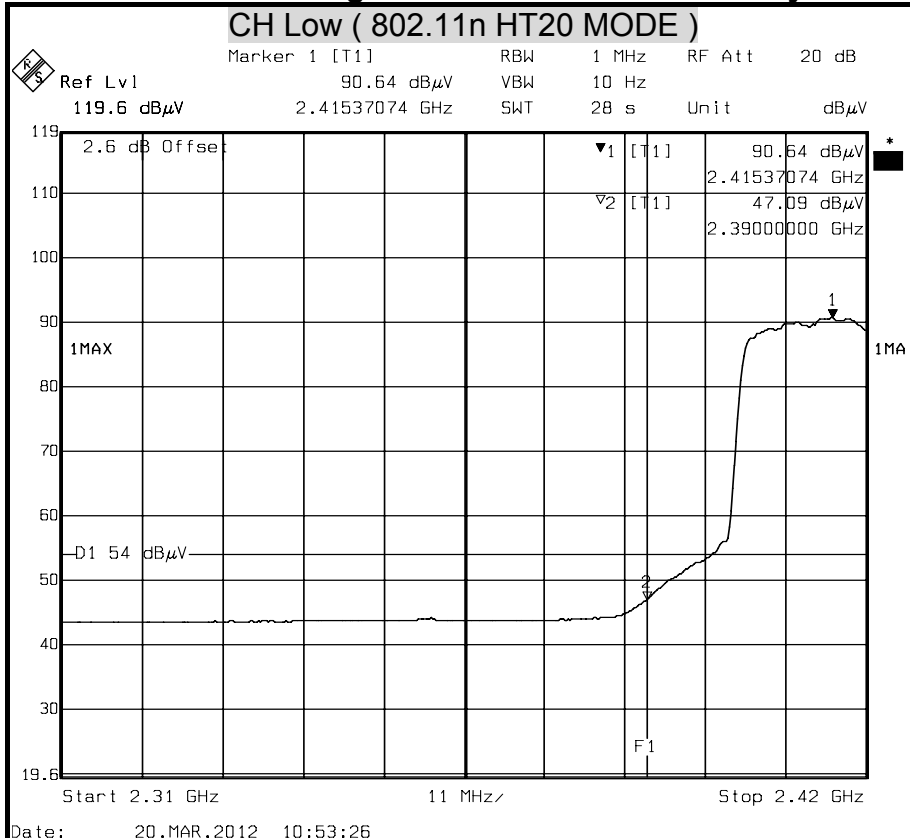



Detector mode : Peak

Polarity : Horizontal

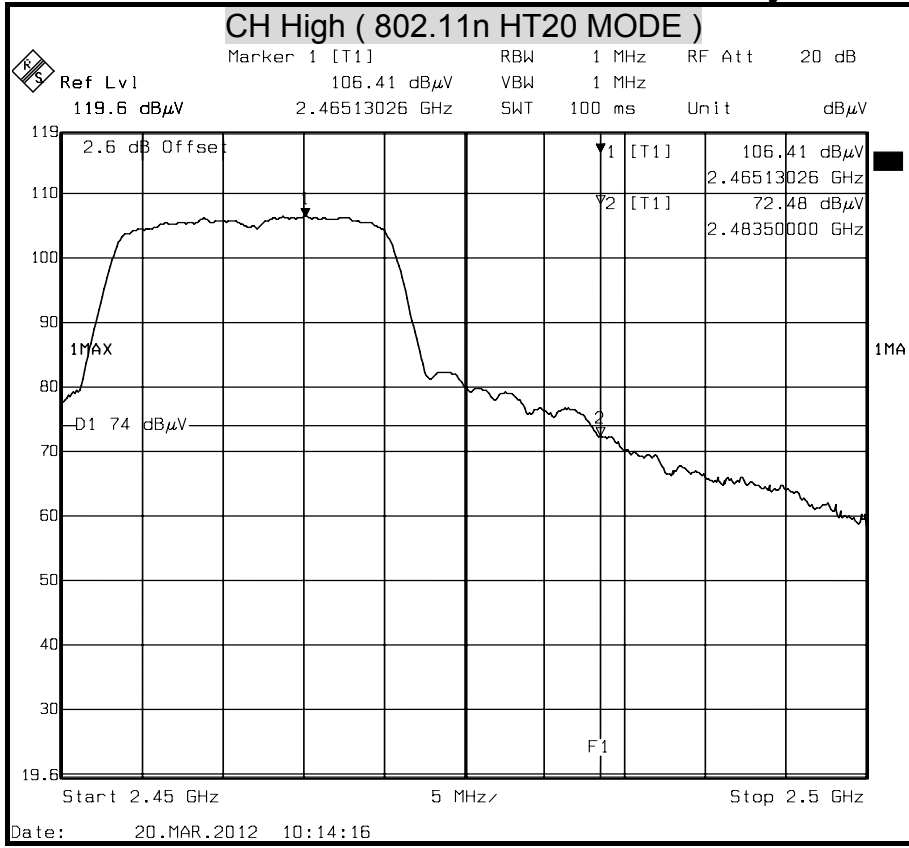

Detector mode : Average

Polarity : Horizontal

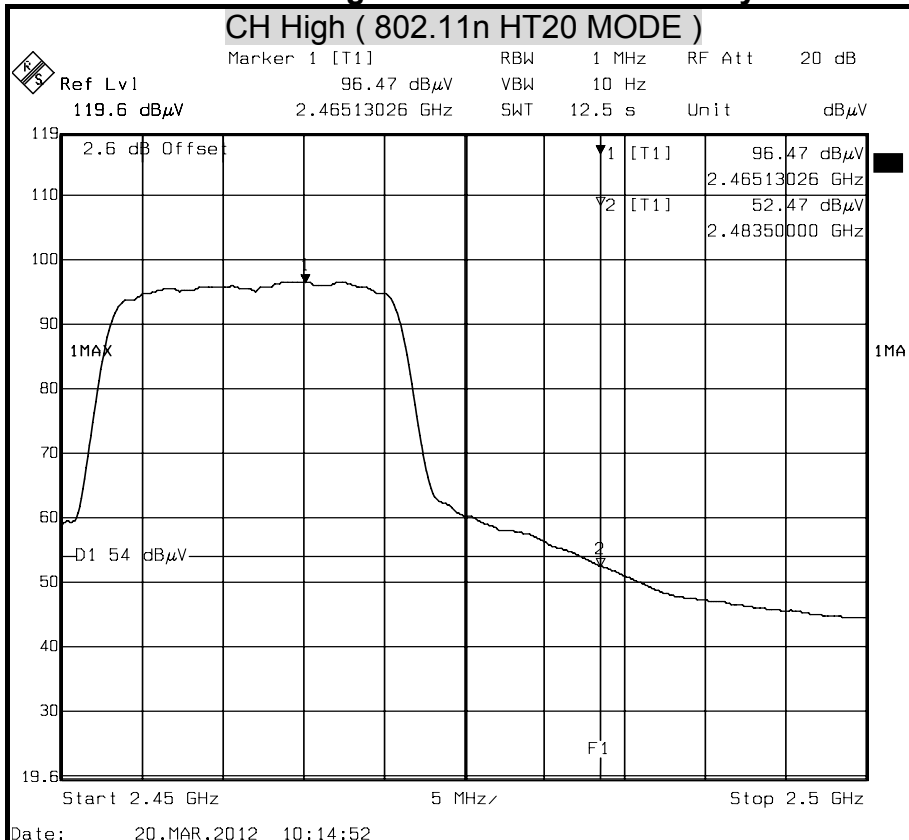



Detector mode : Peak

Polarity : Vertical

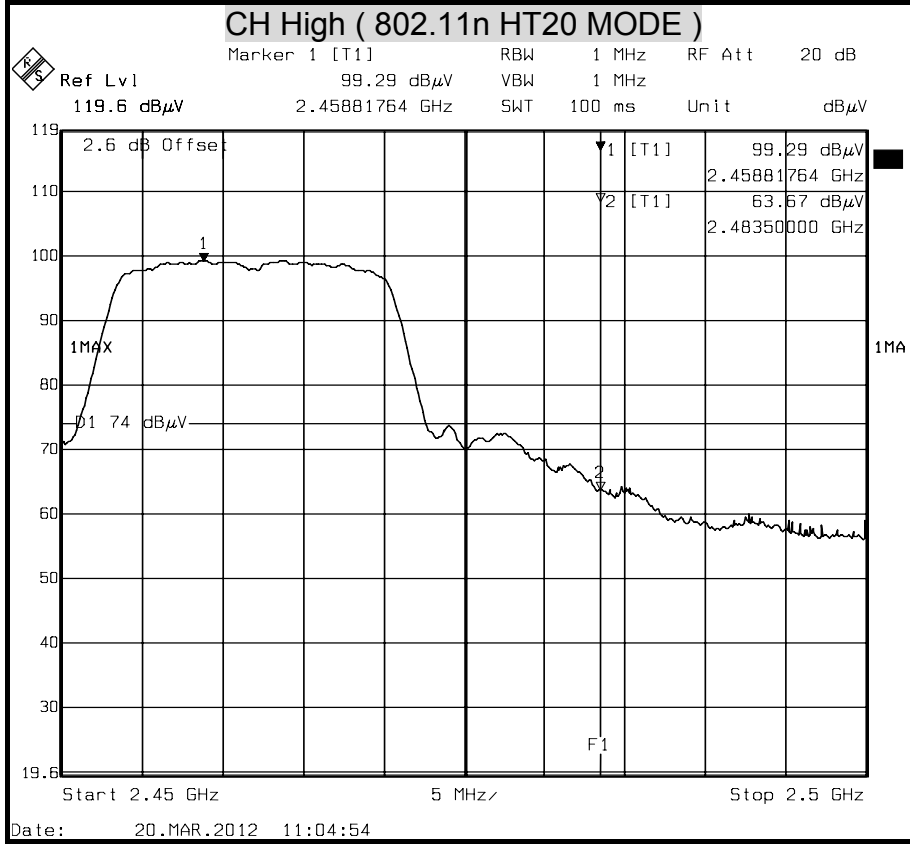

Detector mode : Average

Polarity : Vertical

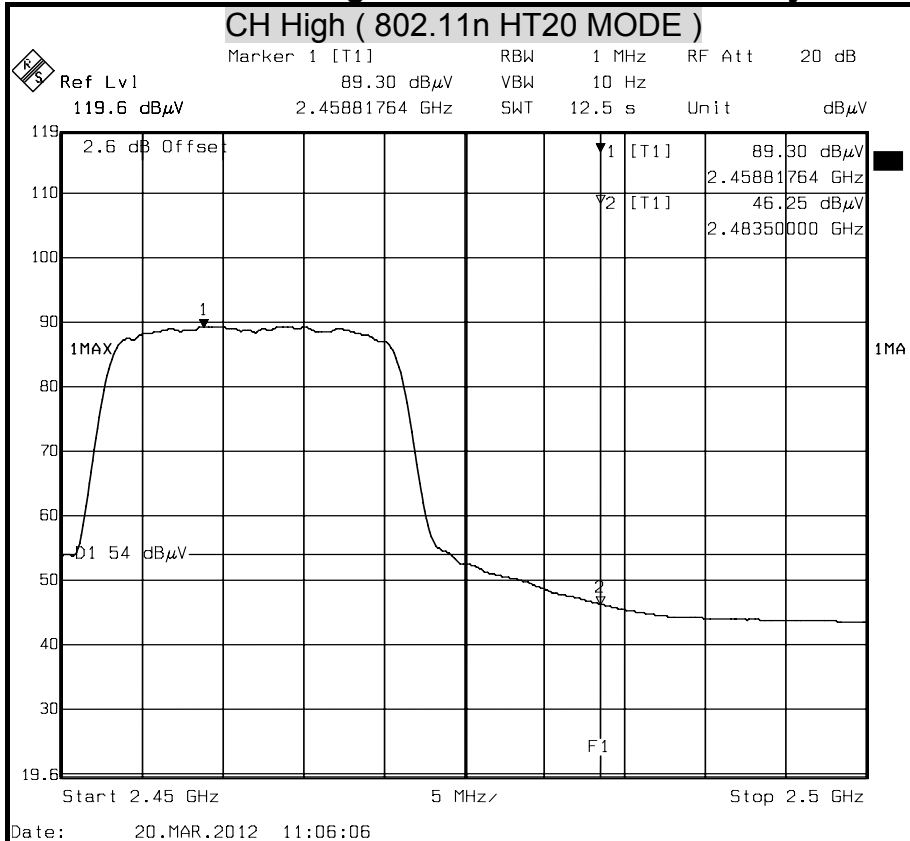



Detector mode : Peak

Polarity : Horizontal

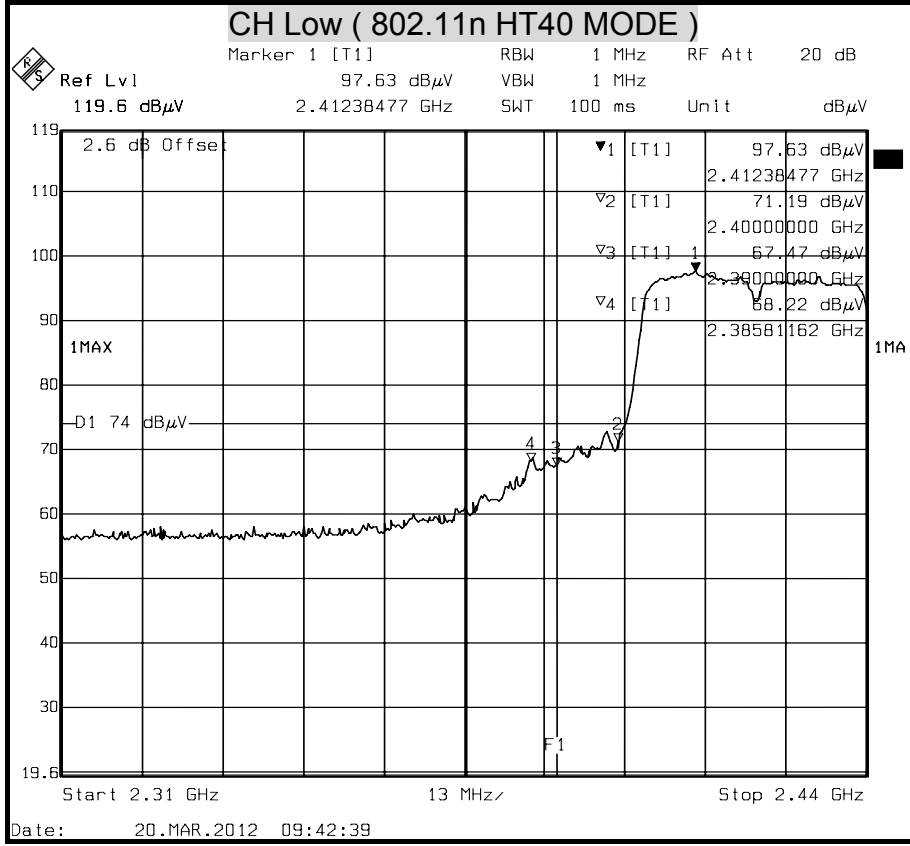

Detector mode : Average

Polarity : Horizontal

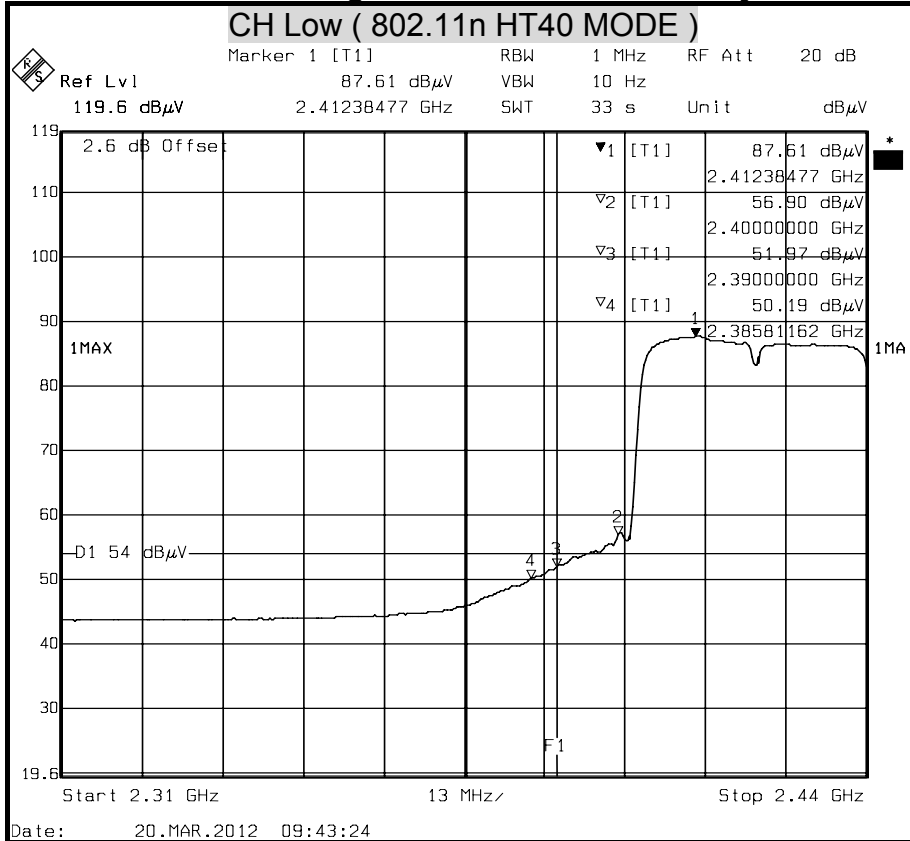



Detector mode : Peak

Polarity : Vertical

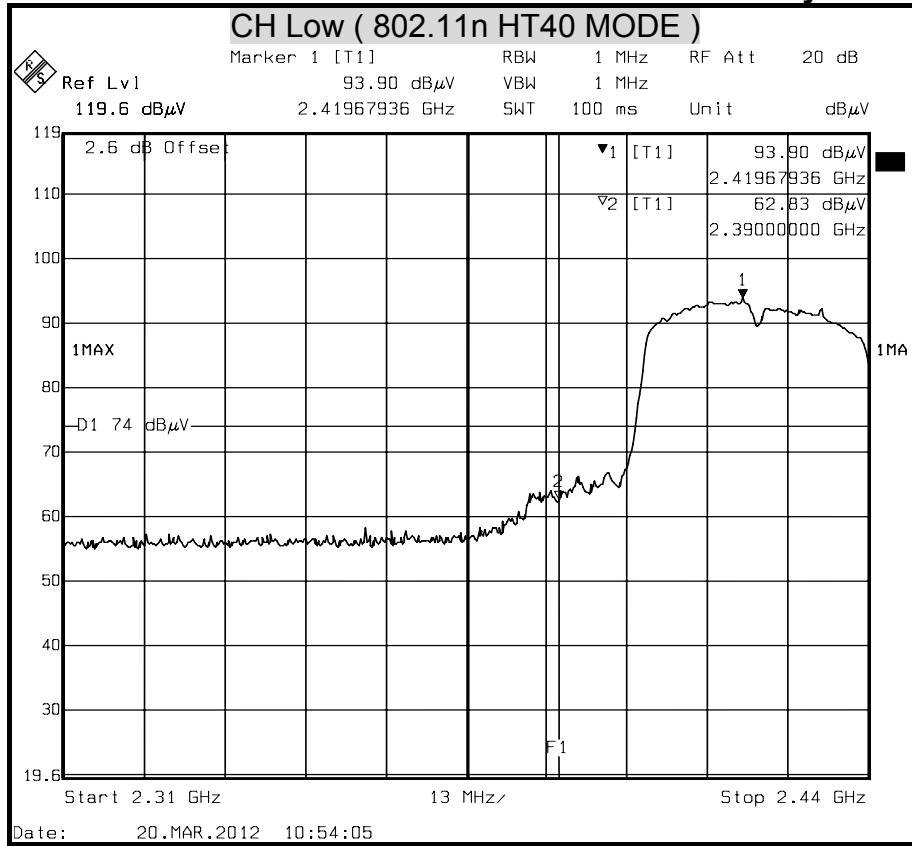

Detector mode : Average

Polarity : Vertical

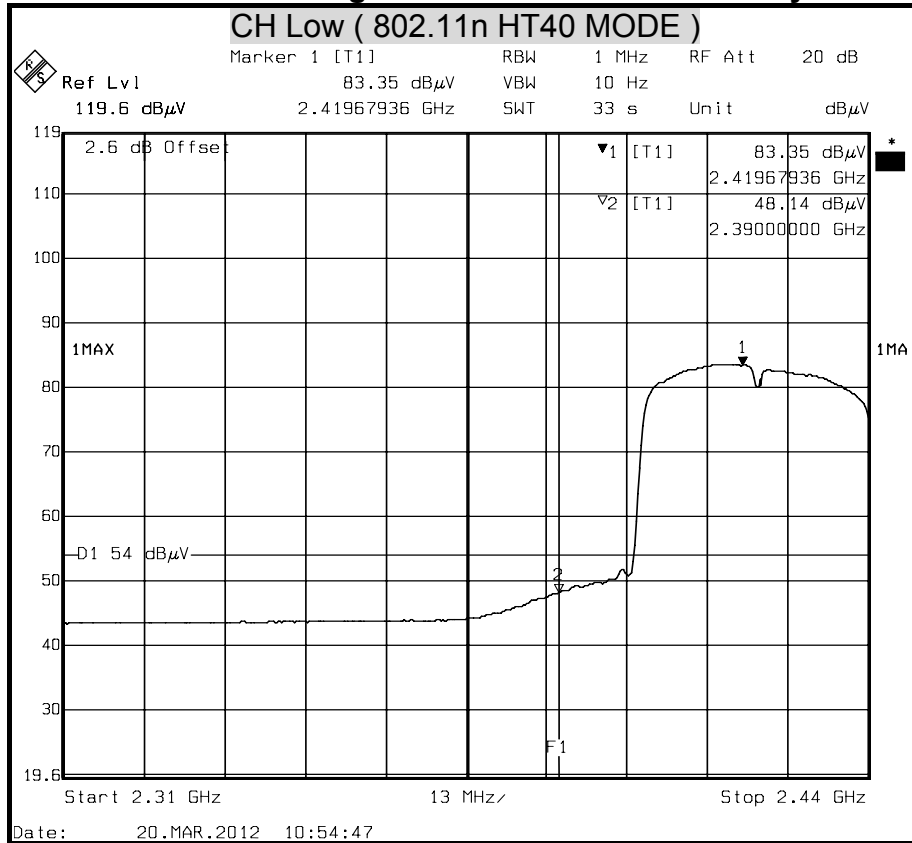



Detector mode : Peak

Polarity : Horizontal

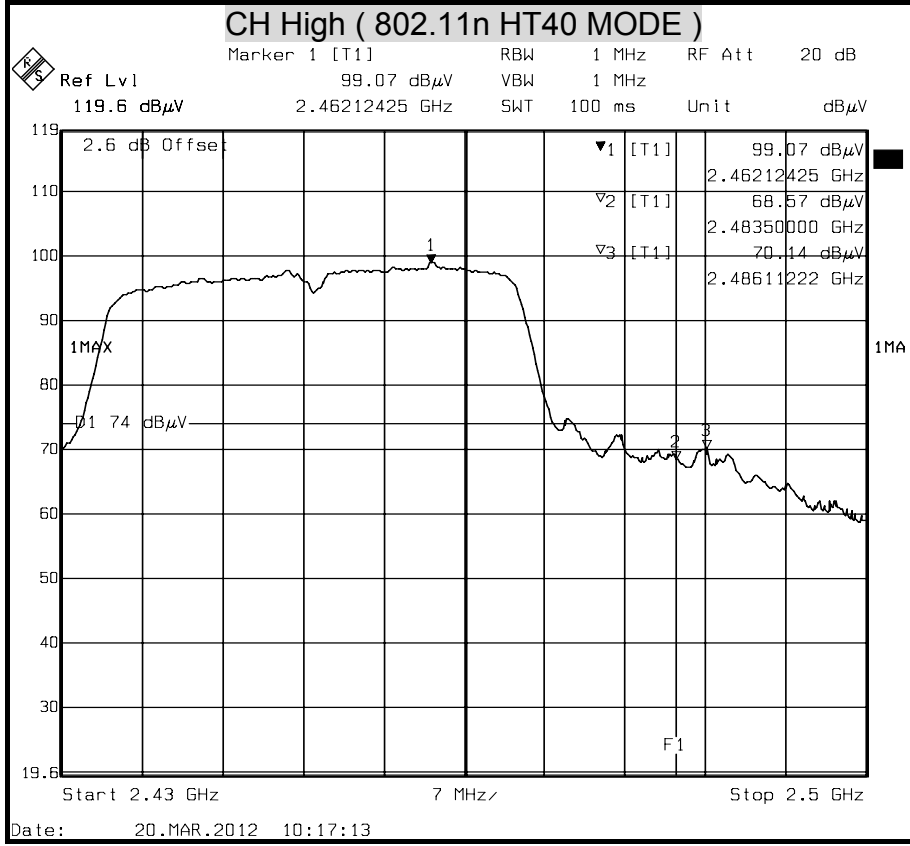

Detector mode : Average

Polarity : Horizontal

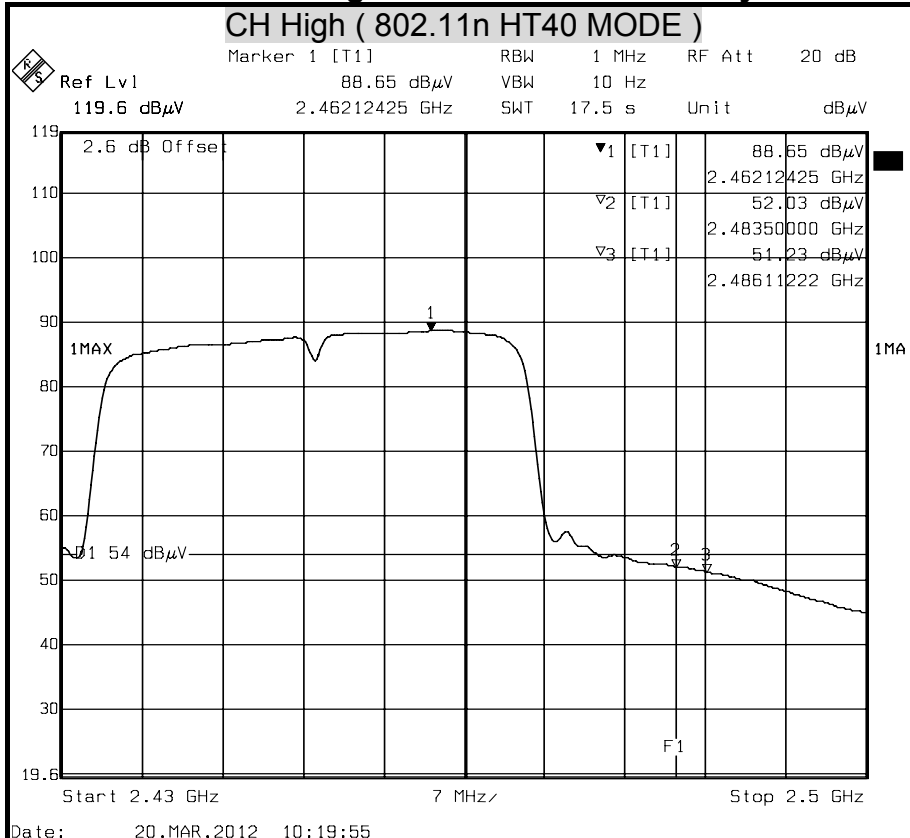



Detector mode : Peak

Polarity : Vertical

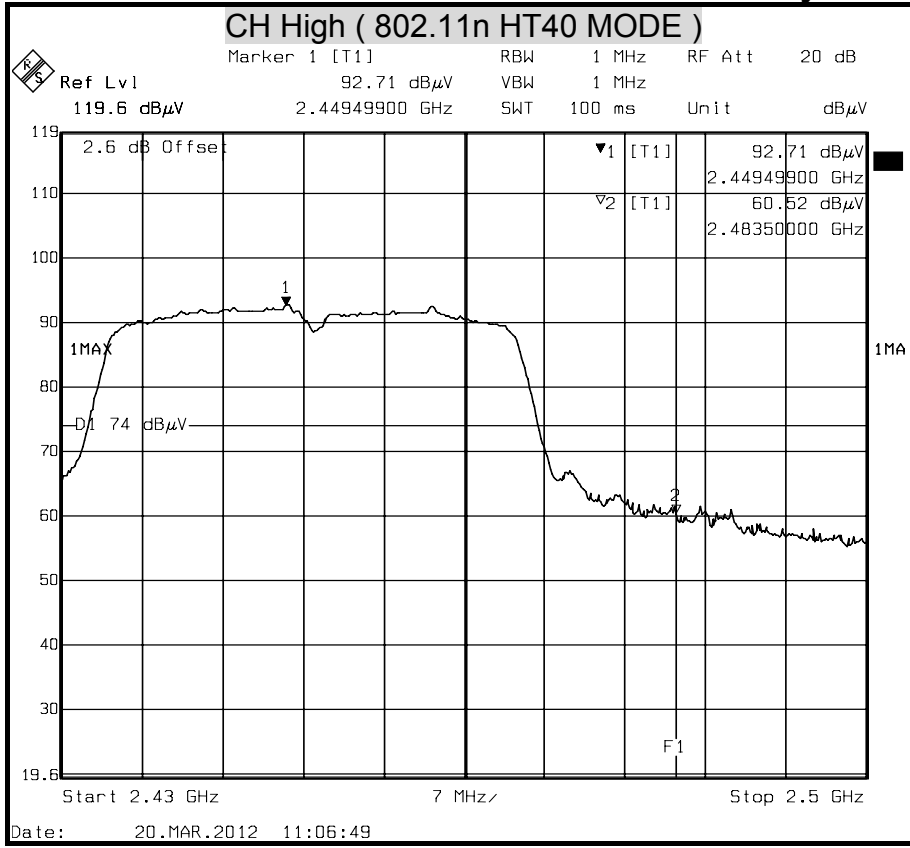

Detector mode : Average

Polarity : Vertical

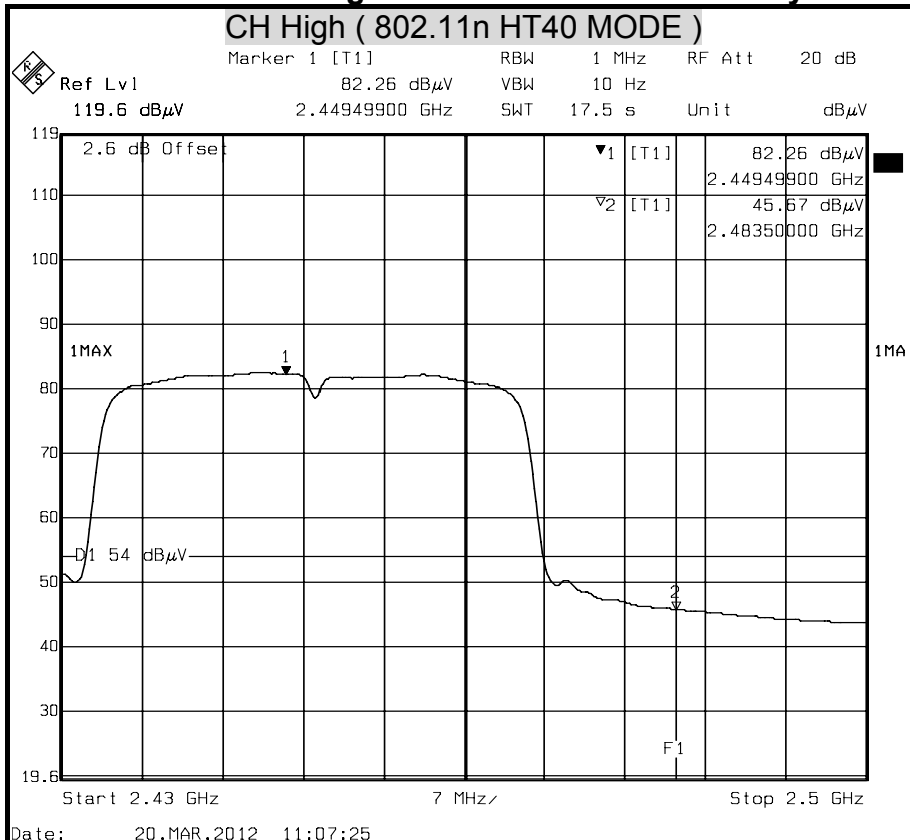





### 8.7 POWERLINE CONDUCTED EMISSIONS

#### LIMITS

§ 15.207 (a) Except as shown in paragraph (b) and (c) this section, for an intentional radiator that is designed to be connected to the public utility (AC) power line, the radio frequency voltage that is conducted back onto the AC power line on any frequency or frequencies within the band 150 kHz to 30 MHz shall not exceed the limits in the following table, as measured using a 50 μH/50 ohms line impedance stabilization network (LISN). Compliance with the provisions of this paragraph shall be based on the measurement of the radio frequency voltage between each power line and ground at the power terminal.

The lower limit applies at the boundary between the frequency ranges.

Frequency of Emission (MHz)	Conducted limit (dBμv)	
	Quasi-peak	Average
0.15 - 0.5	66 to 56	56 to 46
0.5 - 5	56	46
5 - 30	60	50

#### TEST EQUIPMENTS

The following test equipments are used during the conducted power line tests:

Conducted Emission room #1				
Name of Equipment	Manufacturer	Model	Serial Number	Calibration Due
L.I.S.N.	SCHWARZBECK	NNLK 8130	8130124	SEP. 25, 2012
	Rohde & Schwarz	ESH 3-Z5	840062/021	AUG. 02, 2012
TEST RECEIVER	Rohde & Schwarz	ESCS 30	100348	JUL. 03, 2012
TYPE N COAXIAL CABLE	CCS	BNC50	11	OCT. 30, 2012
Test S/W	e-3 (5.04211c) R&S (2.27)			



## TEST SETUP

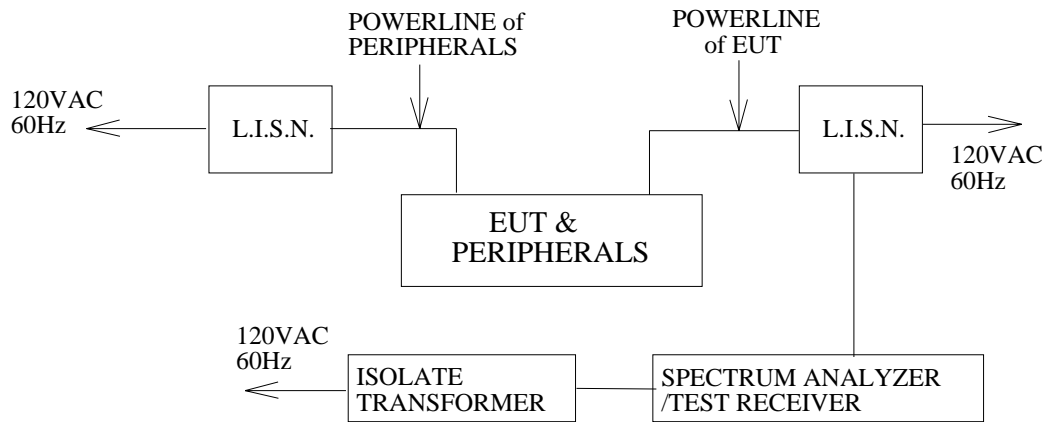

## TEST PROCEDURE

The EUT is placed on a non-conducting table 40 cm from the vertical ground plane and 80cm above the horizontal ground plane. The EUT IS CONFIGURED IN ACCORDANCE WITH ANSI C63.4.

The resolution bandwidth is set to 9 kHz for both quasi-peak detection and average detection measurements.

Line conducted data is recorded for both NEUTRAL and LINE.

## TEST RESULTS

No non-compliance noted.



### CONDUCTED RF VOLTAGE MEASUREMENT

<b>Product Name</b>	Wireless-N Router w 3G+Modem & Voice	<b>Test Date</b>	2012/05/03
<b>Model</b>	Series 1098 Model 4530	<b>Test By</b>	Hong Tsai
<b>Test Mode</b>	WAN Mode (Adapter 1)	<b>TEMP &amp; Humidity</b>	26.5°C, 54%

#### LINE

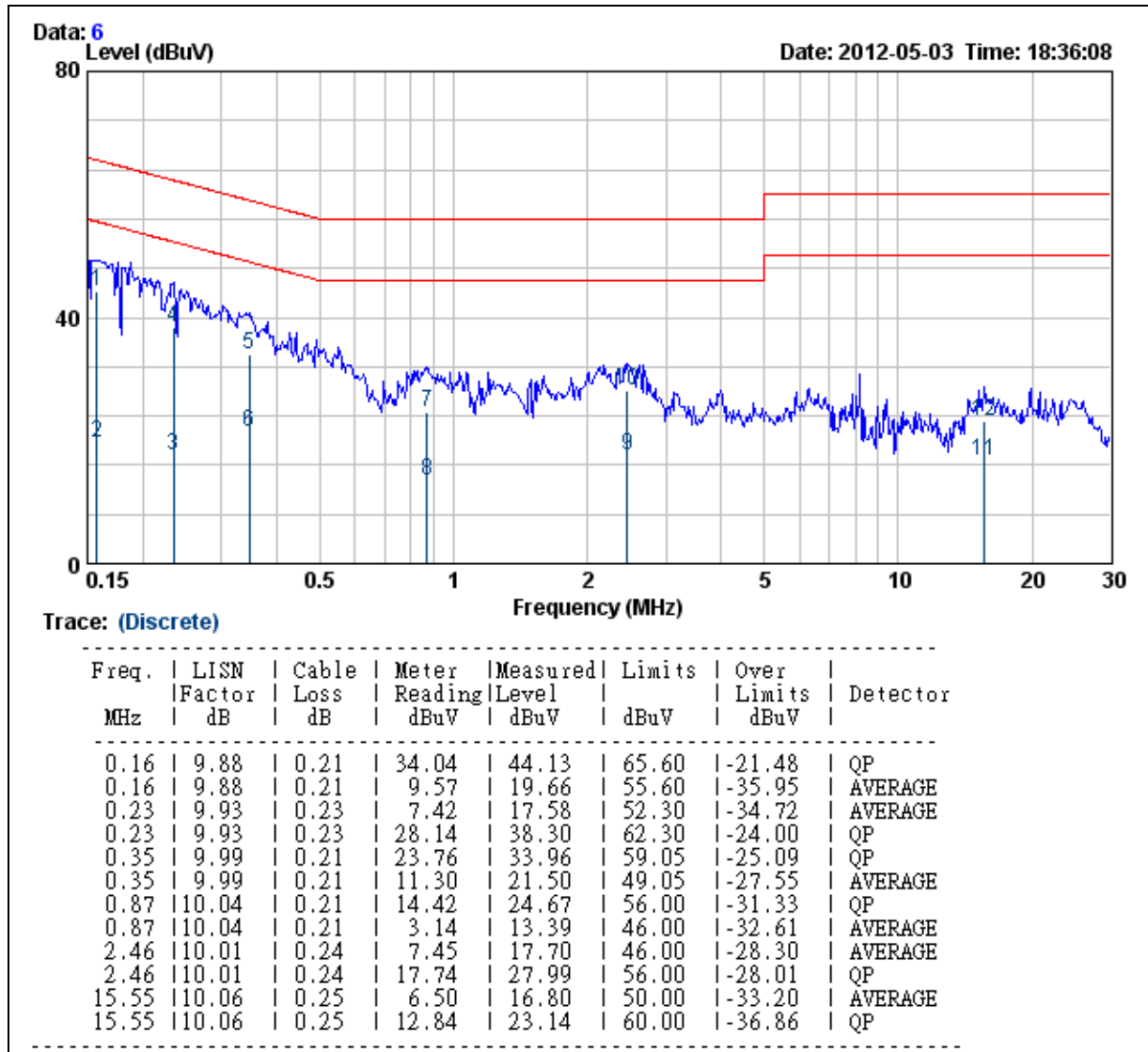

#### REMARK:

1. Correction Factor = Insertion loss + cable loss
2. Margin value = Emission level – Limit value



<b>Product Name</b>	Wireless-N Router w 3G+Modem & Voice	<b>Test Date</b>	2012/05/03
<b>Model</b>	Series 1098 Model 4530	<b>Test By</b>	Hong Tsai
<b>Test Mode</b>	WAN Mode (Adapter 1)	<b>TEMP &amp; Humidity</b>	26.5°C, 54%

NEUTRAL

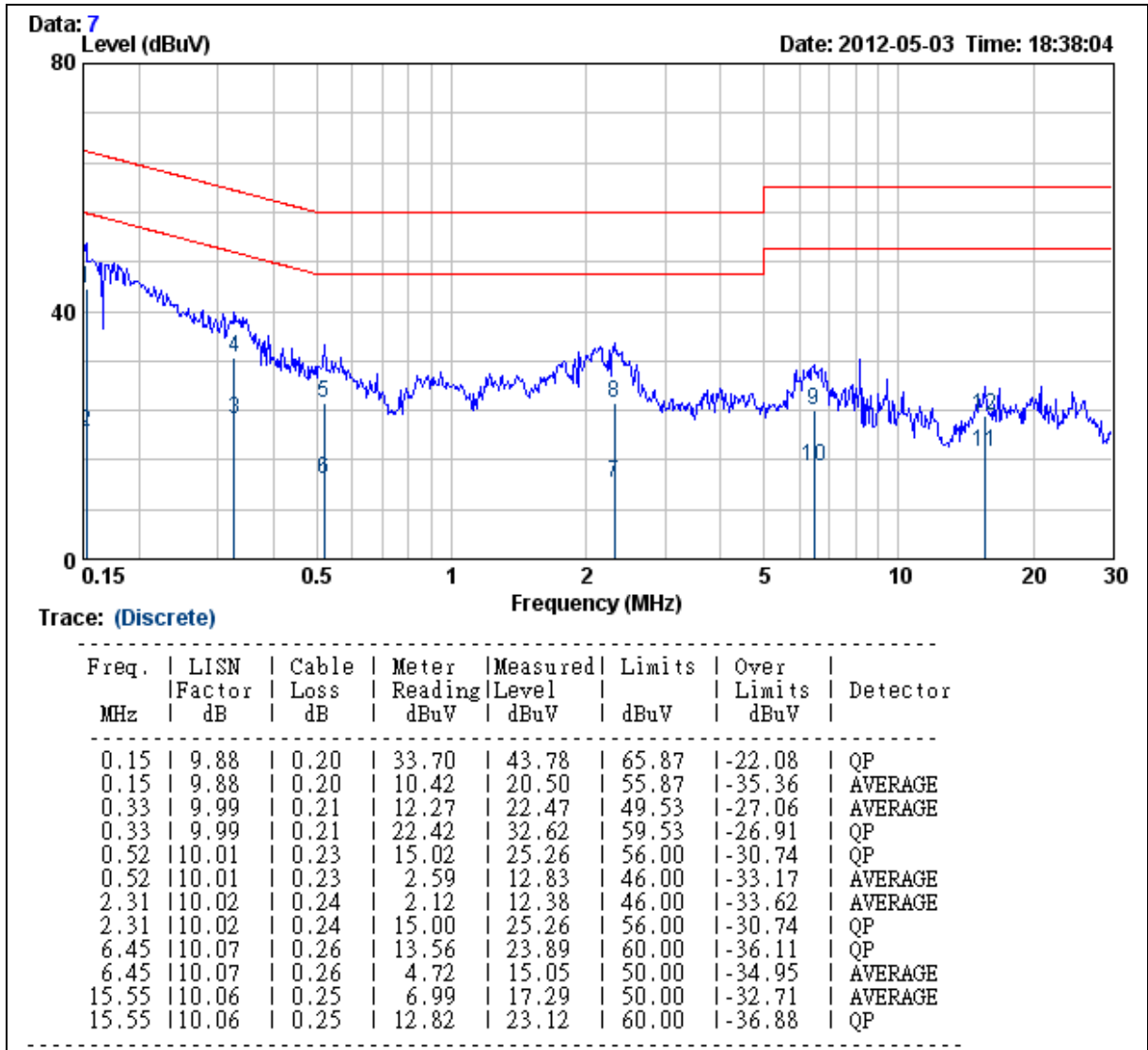

REMARK:

1. Correction Factor = Insertion loss + cable loss
2. Margin value = Emission level – Limit value



<b>Product Name</b>	Wireless-N Router w 3G+Modem & Voice	<b>Test Date</b>	2012/05/03
<b>Model</b>	Series 1098 Model 4530	<b>Test By</b>	Hong Tsai
<b>Test Mode</b>	WAN Mode (Adapter 2)	<b>TEMP &amp; Humidity</b>	26.5°C, 54%

LINE

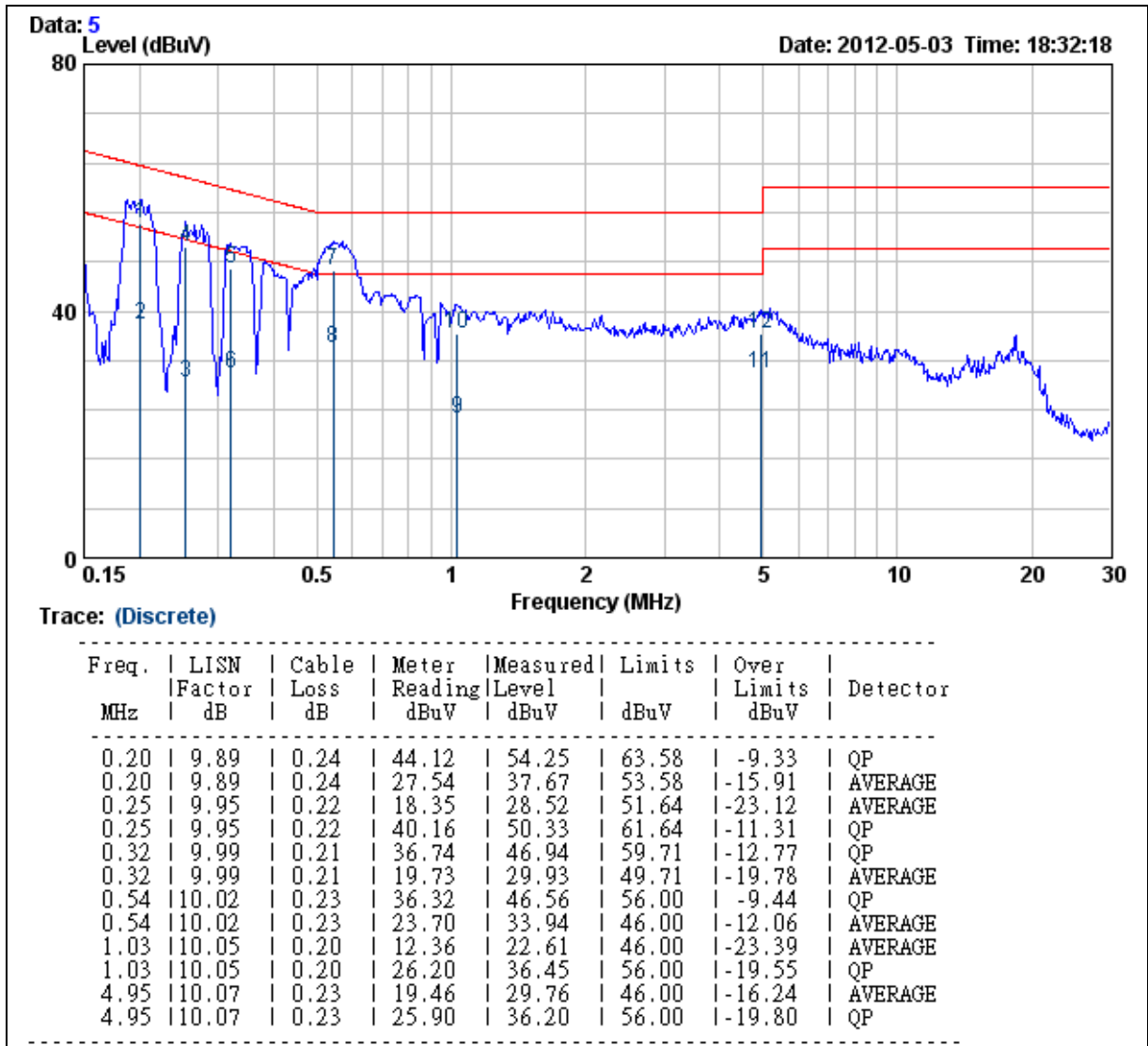

REMARK:

1. Correction Factor = Insertion loss + cable loss
2. Margin value = Emission level – Limit value



<b>Product Name</b>	Wireless-N Router w 3G+Modem & Voice	<b>Test Date</b>	2012/05/03
<b>Model</b>	Series 1098 Model 4530	<b>Test By</b>	Hong Tsai
<b>Test Mode</b>	WAN Mode (Adapter 1)	<b>TEMP &amp; Humidity</b>	26.5°C, 54%

NEUTRAL

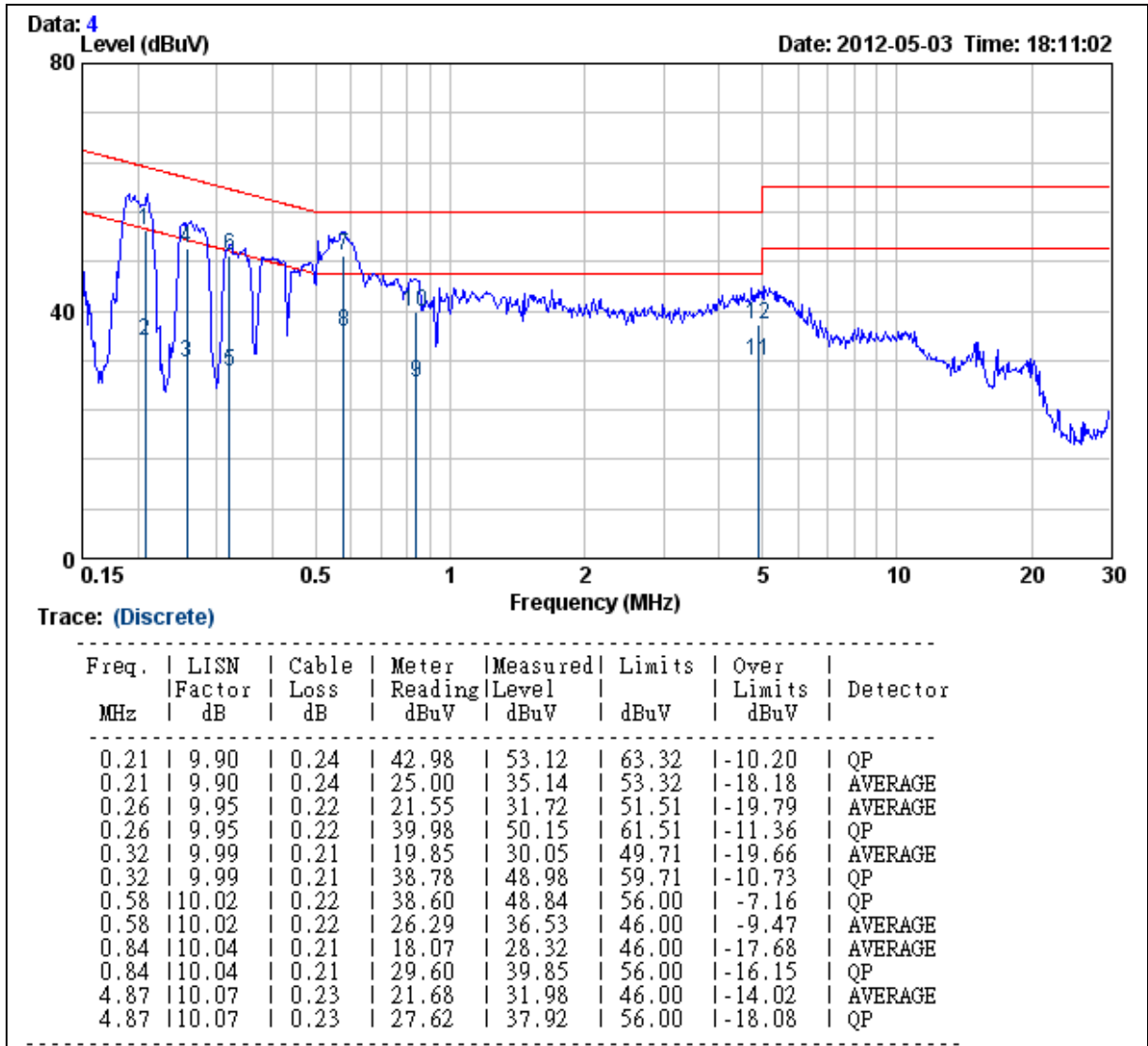

REMARK:

1. Correction Factor = Insertion loss + cable loss
2. Margin value = Emission level – Limit value



## **9. ANTENNA REQUIREMENT**

### **9.1 STANDARD APPLICABLE**

For intentional device, according to FCC 47 CFR Section 15.203, an intentional radiator shall be designed to ensure that no antenna other than that furnished by the responsible party shall be used with the device.

And according to FCC 47 CFR Section 15.247 (b), if transmitting antennas of directional gain greater than 6dBi are used, the power shall be reduced by the amount in dB that the directional gain of the antenna exceeds 6dBi.

### **9.2 ANTENNA CONNECTED CONSTRUCTION**

#### **Antenna \*3**

##### **3G Antenna\*2 (1TX2RX)**

1. Dipole Antenna 3.1dBi (1TX1RX)
2. PCB Antenna 0dBi (1RX)

##### **2.4G Antenna\*1 (1TX1RX)**

1. PCB Antenna 3.79dBi (1TX1RX)