



Ecom Sertech Corp.

Rm. 258, Bldg. 17, NO.195, Sec. 4 Chung Hsing Rd., ChuTung Chen, Hsinchu, Taiwan 310, R.O.C
TEL:886-3-5918012 FAX: 886-3-5825720

FCC ID : BDNBT4163
Report No. : ER03-08-063FRF
Page 1 of 48



TEST REPORT

Product Name : Bluetooth PC Card

Model Number : Series 4163, Model 4312

Applicant : Zoom Telephonics, Inc.

Address : 207 South Street Boston MA 02111 USA

Received Date : Aug. 29, 2003

Tested Date : Aug. 29, 2003

Notes :

1. This report will be invalid if duplicated or photocopied in part.
2. This report refers only to the specimen(s) submitted to testing, and be invalid as seperately used.
3. This report is invalid without examination stamp and signature of this institute.
4. The tested specimen(s) will be preserved for thirty days from the data issued.
5. The report must not be used to claim product certification, approval, or endorsement by NVLAP, NIST, or any agency of the federal government.





Ecom Sertech Corp.

Rm. 258, Bldg. 17, NO.195, Sec. 4 Chung Hsing Rd., ChuTung Chen, Hsinchu, Taiwan 310, R.O.C
TEL:886-3-5918012 FAX: 886-3-5825720

FCC ID : BDNBT4163
Report No. : ER03-08-063FRF
Page 2 of 48

Test Report Certification

Product Name : Bluetooth PC Card
Model Number : Series 4163, Model 4312
Applicant : Zoom Telephonics, Inc.

Measurement Standard :

47 CFR Part 15, Subpart B and Subpart C (Section 15.247),
ANSI C63.4-2001

Tested By : K. P. Pang, **Date** : (Aug. 29, 2003)
(K. P. Pang)

Reviewed By : Roger Sheng, **Date** : (Aug. 29, 2003)
(Roger Sheng)

Approved By : Chieh-De Tsai, **Date** : (Aug. 29, 2003)
(Chieh-De Tsai, Manager)



WE HEREBY CERTIFY THAT: The measurements shown in the attachment were made in accordance with the procedures indicated, and the energy emitted by the equipment was found to be within the limits applicable. We assume full responsibility for the accuracy and completeness of these measurements and vouch for the qualifications of all persons taking them.



TABLE OF CONTENTS

TITLE	PAGE NO.
1. GENERAL INFORMATION	5
1.1 DESCRIPTION OF EUT & POWER.....	5
1.2 DESCRIPTION OF PERIPHERALS.....	6
1.3 EUT & PERIPHERALS SETUP DIAGRAM.....	6
1.4 DESCRIPTION OF TEST SITE	8
1.5 SUMMARY OF TEST RESULTS.....	8
2. CONDUCTED POWERLINE TEST.....	9
2.1 TEST EQUIPMENTS.....	9
2.2 TEST SETUP.....	9
2.3 CONDUCTED POWER LINE EMISSION LIMIT.....	10
2.4 TEST PROCEDURE.....	10
2.5 UNCERTAINTY OF CONDUCTED EMISSION.....	10
2.6 LINE CONDUCTED RF VOLTAGE MEASUREMENT.....	11
2.7 PHOTOS OF CONDUCTION TEST.....	12
3. 20dB Bandwidth for hopping.....	13
3.1 TEST EQUIPMENTS.....	13
3.2 TEST SETUP.....	13
3.3 LIMITS OF 20dB BANDWIDTH MEASUREMENT.....	13
3.4 TEST PROCEDURE.....	13
3.5 UNCERTAINTY OF CONDUCTED EMISSION.....	14
3.6 TEST RESULTS.....	14
3.7 PHOTO OF 20DB BANDWIDTH MEASUREMENT.....	15
4. MAXIMUM PEAK OUTPUT POWER.....	16
4.1 TEST EQUIPMENTS.....	16
4.2 TEST SETUP.....	16
4.3 LIMITS OF MAXIMUM PEAK OUTPUT POWER.....	16
4.4 TEST PROCEDURE.....	17
4.5 UNCERTAINTY OF CONDUCTED EMISSION.....	17
4.6 TEST RESULTS.....	17
5. HOPPING CHANNEL SEPARATION.....	18
5.1 TEST EQUIPMENTS.....	18
5.2 TEST SETUP.....	18
5.3 LIMITS OF HOPPING CHANNEL SEPARATION.....	18
5.4 TEST PROCEDURE.....	19
5.5 UNCERTAINTY OF CONDUCTED EMISSION.....	19
5.6 TEST RESULTS.....	19
5.7 PHOTO OF HOPPING CHANNEL SEPARATION.....	19
6. NUMBER OF HOPPING FREQUENCY USED.....	20
6.1 TEST EQUIPMENTS.....	20
6.2 TEST SETUP.....	20
6.3 LIMITS OF NUMBER OF HOPPING FREQUENCY USED.....	20
6.4 TEST PROCEDURE.....	21
6.5 UNCERTAINTY OF CONDUCTED EMISSION.....	21
6.6 TEST RESULTS.....	21
6.7 PHOTO OF NUMBER OF HOPPING FREQUENCY USED.....	21



TABLE OF CONTENTS

TITLE	PAGE NO.
7. DWELL TIME ON EACH CHANNEL.....	22
7.1 TEST EQUIPMENTS.....	22
7.2 TEST SETUP.....	22
7.3 LIMITS OF DWELL TIME ON EACH CHANNEL.....	22
7.4 TEST PROCEDURE.....	23
7.5 UNCERTAINTY OF CONDUCTED EMISSION.....	23
7.6 TEST RESULTS.....	23
7.7 PHOTO OF DWELL TIME ON EACH CHANNEL.....	24-25
8. Out of Band Spurious Emissions -Conducted Measurements.....	26
8.1 TEST EQUIPMENTS.....	26
8.2 TEST SETUP.....	26
8.3 LIMITS OF Out of Band Measurements.....	26
8.4 TEST PROCEDURE.....	27
8.5 UNCERTAINTY OF CONDUCTED EMISSION.....	27
8.6 TEST RESULTS.....	28-29
9. Out of Band Spurious Emissions -Radiated Measurements.....	30
9.1 TEST EQUIPMENTS.....	30
9.2 TEST SETUP.....	30
9.3 RADIATION LIMIT.....	31
9.4 TEST PROCEDURES.....	32
9.5 UNCERTAINTY OF RADIATED EMISSION.....	32
9.6 RADIATED RF NOISE MEASUREMENT.....	33-45
9.7 PHOTOS OF OPEN SITE.....	46-47
10. ANTENNA REQUIREMENT.....	48
10.1 STANDARD APPLICABLE.....	48
10.2 ANTENNA CONNECTED CONSTRUCTION.....	48



1. GENERAL INFORMATION

1.1 DESCRIPTION OF EUT & POWER

MANUFACTURER : Zoom Telephonics, Inc.
SAMPLE NAME : Bluetooth PC Card
MODEL NO : Series 4163, Model 4312
EUT DESCRIPTION : 2.4GHz FREQUENCY HOPPING SPREAD SPECTRUM
DATA TRANSCEIVER FOR Bluetooth PC Card
FREQUENCY RANGE : 2402 MHz TO 2480MHz
CHANNEL Spacing : 1MHz
AIR DATA RATE : 723Kbps
TYPE OF MODULATION : Frequency Hopping Spread Spectrum
FREQUENCY SELECTION : BY SOFTWARE
ANTENNA TYPE : Monopole antenna soldered on PCB
POWER SOURCE : 5VDC, 128mA



1.2 DESCRIPTION OF PERIPHERALS

(1) Notebook PC

MANUFACTURER : DELL CORP.
MODEL NUMBER : PP01L
SERIAL NUMBER : CN-09C748-48155-1AP-6081
F.C.C. : DOC
POWER CORD : Unshielded, Detachable, 1.8m

(2) PRINTER

MANUFACTURER : Hp Corp.
MODEL NUMBER : C6431D
SERIAL NUMBER : CN19T6S011
F.C.C. ID : DOC
POWER SOURCE : 100-240VAC,50/60Hz,0.7A
SIGNAL CABLE : Shielded , Undetachable , 1.8m

(3) MODEM

MANUFACTURER : ZYXEL communication Corp.
MODEL NUMBER : Omni 56K
SERIAL NUMBER : S1Z4107729
F.C.C. ID : 1880MN156K
POWER SOURCE : 9VAC(From Power Adapter)
SIGNAL CABLE : Shielded , Undetachable , 1.8m

(4) Notebook PC

MANUFACTURER : DELL CORP.
MODEL NUMBER : PP01L
SERIAL NUMBER : CN-09C748-48155-1AP-6630
F.C.C. : DOC

1.3 EUT & PERIPHERALS SETUP DIAGRAM

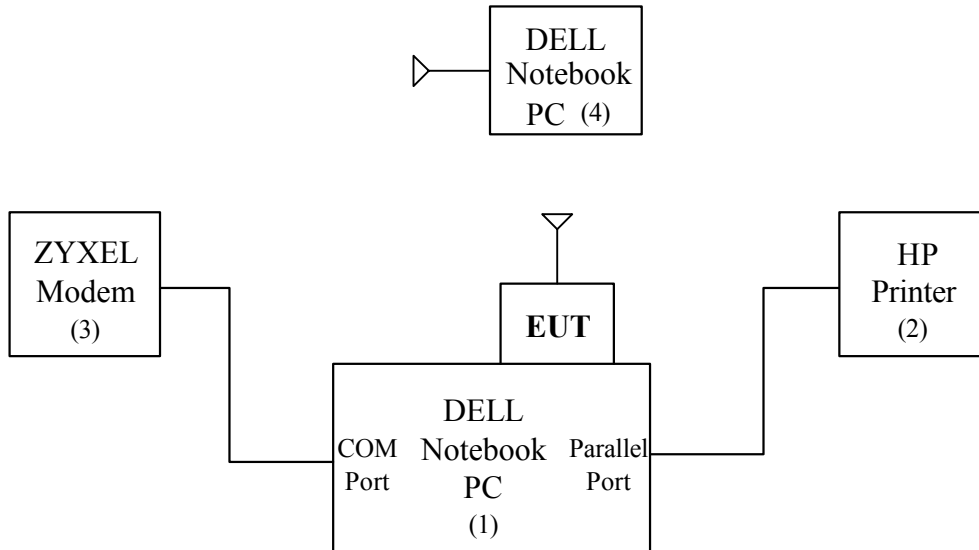



Ecom Sertech Corp.

Rm. 258, Bldg. 17, NO.195, Sec. 4 Chung Hsing Rd., ChuTung Chen, Hsinchu, Taiwan 310, R.O.C
TEL:886-3-5918012 FAX : 886-3-5825720

FCC ID : BDNBT4163
Report No. : ER03-08-063FRF
Page 8 of 48

1.4 DESCRIPTION OF TEST SITE

SITE DESCRIPTION : FCC Certificate NO. : 90585
 BSMI Certificate NO. : SL2-IN-E-0002
 NVLAP Lab code : 200118-0
 CNLA Certificate NO. : CNLA-ZL97018
 VCCI Certificate NO. : R-1229, C-1250

NAME OF SITE : Ecom Sertech Corp. Hsinchu
 (Spin-off from ITRI / ERSO on Apr. 01, 2003)

SITE LOCATION : Rm.258, Bldg.17, NO.195 , Sec. 4, Chung Hsing Rd.,
 Chu-Tung Chen. Hsin-Chu, Taiwan 310 R.O.C.

1.5 SUMMARY OF TEST RESULTS

The EUT has been tested according to the following specifications :

APPLIED STANDARD : 47 CFR Part 15, Subpart B and Subpart C			
Standard Section	Test Type and Limit	Result	REMARK
15.107 15.207	AC Power Conducted Emission Limit : Sec1.5.107	PASS	Meet the requirement of limit
15.109 15.205 15.209	Transmitter Radiated Emissions Limit : Table 15.209	PASS	Meet the requirement of limit
15.247(a) (1)(i)-(ii)	Transmitter 20dB Bandwidth Limit < 1MHz	PASS	Meet the requirement of limit
15.247(b)(1)	Maximum Peak Output Power Limit : max. 30dBm	PASS	Meet the requirement of limit
15.247(a)(1)	Carrier Frequency Separation	PASS	Meet the requirement of limit
15.247(a) (1)(ii)	Number of Hopping Frequency	PASS	Meet the requirement of limit
15.247(a) (1)(ii)	Time of Occupancy (dwell time)	PASS	Meet the requirement of limit
15.247(c)	Band Edge Compliens	PASS	Meet the requirement of limit
15.247(c)	Out of Band Measurements	PASS	Meet the requirement of limit



2. CONDUCTED POWERLINE TEST

For intentional device, according to § 15.207(a) Line Conducted Emission Limit is required to verify the EUT.

2.1 TEST EQUIPMENTS

The following test equipments are used during the conducted powerline tests :

Manufacturer or Type	Model No	Serial No.	Date of Calibration	Calibration Period	Remark
SPECTRUM ANALYZER & DISPLAY	HP 8568A	2235A02320	APR. 01, 2003	1 Year	PRETEST
QUASI-PEAK ADAPTER	HP 85650 A	2341A00672	APR. 01, 2003	1 Year	PRETEST
ISOLATION TRANSFORMER	SOLAR 7032-1	N/A	N/A	N/A	FINAL
L.I.S.N.	EMCO 3850/2	9311-1025 9401-1028	JAN. 08, 2003 For Characteristic impedance	1 Year	FINAL
			MAY 18, 2003 For Insertion loss		
TEST RECEIVER	R/S ESHS30	838550/003	JUN. 07, 2003	1 Year	FINAL
SHIELDED ROOM	KEENE 5983	NO.1	N/A	N/A	FINAL
PULSE LIMIT	R/S EHS3Z2	357.8810.52	JUL. 10, 2003	1 Year	FINAL
N TYPE COAXIAL CABLE	-----	-----	JUL. 10, 2003	1 Year	FINAL
50Ω TERMINATOR	-----	-----	JUL. 10, 2003	1 Year	FINAL

2.2 TEST SETUP

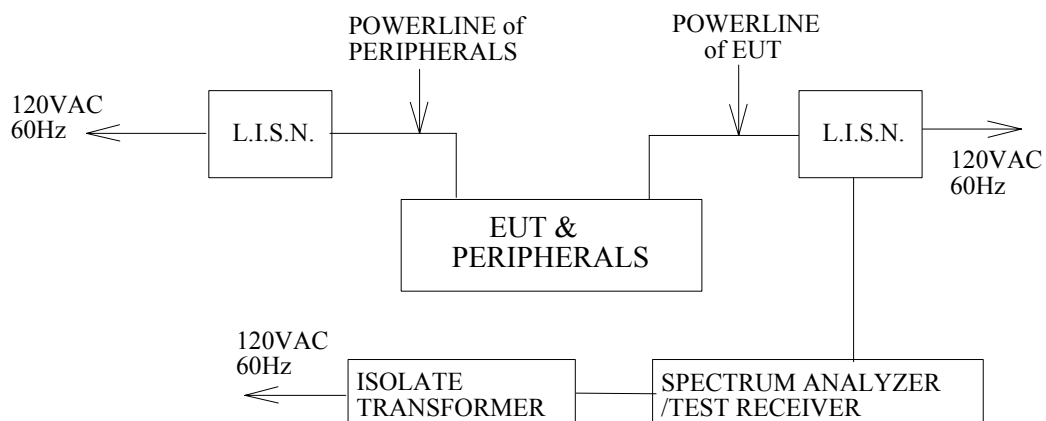



2.3 CONDUCTED POWER LINE EMISSION LIMIT

For unintentional device, according to § 15.107(a) Line Conducted Emission Limits is as following :

Frequency (MHz)	Maximum Rf Line Voltage (Db μ v)			
	CLASS A		CLASS B	
	Q.P.	Ave.	Q.P.	Ave.
0.15 - 0.50	79	66	66-56	56-46
0.50 - 5.00	73	60	56	46
5.00 - 30.0	73	60	60	50

For intentional device, according to § 15.207(a) Line Conducted Emission Limit is same as above table.

2.4 TEST PROCEDURE

The test procedure is performed in a 12ft×12ft×8ft(L×W×H) shielded room. the EUT along with its peripherals were placed on a 1.0m(W)× 1.5m(L) and 0.8m in height wooden table and the EUT was adjusted to maintain a 0.4 meter space from a vertical reference plane. The EUT was connected to power mains through a line impedance stabilization network (LISN) which provides 50 ohm coupling impedance for measuring instrument and the chasis ground was bounded to the horizontal ground plane of shielded room. All peripherals were connected to the second LISN and the chasis ground also bounded to the horizontal ground plane of shielded room. The excess power cable between the EUT and the LISN was bundled. The power cables of peripherals were unbundled. All connecting cables of EUT and peripherals were moved to find the maximum emission.

2.5 UNCERTAINTY OF CONDUCTED EMISSION

The uncertainty of conducted emission is ± 1.36 dB.



2.6 LINE CONDUCTED RF VOLTAGE MEASUREMENT

The frequency spectrum from 0.15 MHz to 30 MHz was investigated. All emissions not reported below are more than 20 dB below the prescribed limits.

Temperature : 26 °C

Humidity : 65 % RH

Frequency (MHz)	Loss(dB)		MEASUREMENT				L1 Emission (dBμV)		L2 Emission (dBμV)		LIMITS (dBμV)	
			L1(dBμV)		L2(dBμV)		Q.P.	A.V.	Q.P.	A.V.	Q.P.	A.V.
	L1	L2	Q.P.	A.V.	Q.P.	A.V.						
0.150	0.1	0.2	*	*	*	*	*	*	*	*	66.00	56.00
0.153	0.1	0.2	34.70	*	*	*	34.80	*	*	*	65.84	55.84
0.261	0.1	0.2	*	*	38.80	*	*	*	39.00	*	61.40	51.40
0.396	0.1	0.2	37.50	*	40.30	*	37.60	*	40.50	*	57.94	47.94
0.726	0.1	0.2	*	*	29.00	*	*	*	29.20	*	56.00	46.00
0.750	0.1	0.2	32.10	*	*	*	32.20	*	*	*	56.00	46.00
1.983	0.1	0.2	25.80	*	*	*	25.90	*	*	*	56.00	46.00
1.986	0.1	0.2	*	*	26.90	*	*	*	27.10	*	56.00	46.00
2.841	0.18	0.2	26.10	*	*	*	26.28	*	*	*	56.00	46.00
3.834	0.2	0.2	*	*	29.10	*	*	*	29.30	*	56.00	46.00
6.741	0.3	0.3	29.00	*	29.00	*	29.30	*	29.30	*	60.00	50.00
8.997	0.4	0.4	*	*	30.20	*	*	*	30.60	*	60.00	50.00
14.07	0.5	0.6	31.60	*	*	*	32.11	*	*	*	60.00	50.00
16.389	0.7	0.7	26.30	*	*	*	27.00	*	*	*	60.00	50.00
27.72	1.4	1.5	*	*	20.90	*	*	*	22.40	*	60.00	50.00
30.000	1.4	1.8	*	*	*	*	*	*	*	*	60.00	50.00

REMARKS : 1. * Undetectable or the Q.P. value is lower than the limits of Ave.
 2. The EUT is in TX mode.

2.7 PHOTOS OF CONDUCTION TEST



3. 20dB Bandwidth for hopping

Test Requirement: 15.247(a)(1)(ii)

3.1 TEST EQUIPMENTS

Description & Manufacturer	Model No.	Serial No.	Date Of Calibration
ROHDE & SCHWARZ SPECTRUM ANALYZER	FSEK30	835253/002	JUN. 17, 2003
HP ATTENUATOR	8496B	3247A18505	Cal. on use
HP PLOTTER	7750A	725A 852141	N/A

NOTE :

1. The measurement uncertainty is less than +/- 2.6dB, which is calculated as per the NAMAS document NIS81.
2. The calibration interval of the above test instruments is 12 months and the calibrations are traceable to NML/ROC and NIST/USA.

3.2 TEST SETUP

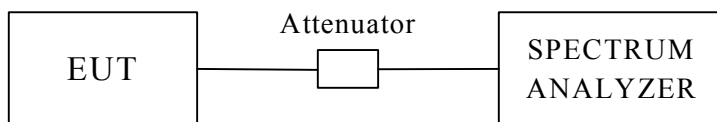

3.3 LIMITS OF 20dB BANDWIDTH MEASUREMENT

Limit: 20dB band width < 1MHz

3.4 TEST PROCEDURE

The 20dB band width was measured with a spectrum analyzer connected to RF antenna connector(conducted measurement) while EUT was operating in transmit mode at the appropriate center frequency.

The analyzer center frequency was set to the EUT carrier frequency, using the analyzer. Display Line and Marker Delta functions, the 20dB band width of the emission was determined.



Ecom Sertech Corp.

Rm. 258, Bldg. 17, NO.195, Sec. 4 Chung Hsing Rd., ChuTung Chen, Hsinchu, Taiwan 310, R.O.C
TEL:886-3-5918012 FAX : 886-3-5825720

FCC ID : BDNBT4163
Report No. : ER03-08-063FRF
Page 14 of 48

3.5 UNCERTAINTY OF CONDUCTED EMISSION

The uncertainty of conducted emission is ± 10 KHz.

3.6 TEST RESULTS

Refer to attached spectrum analyzer data chart.

- (1) 2402 MHz (Low) 871 kHz
- (2) 2441MHz (Mid) 876 kHz
- (3) 2480MHz (High) 871 kHz

Input Power (System)	5VDC	Environmental Conditions	26°C, 55%RH,
Tested By	K. P. Pang		

Channel	Channel Frequency (MHz)	20dB Bandwidth (MHz)	Maximum Limit (MHz)	Pass / Fail
1	2402	0.871	1	PASS
6	2441	0.876	1	PASS
11	2480	0.871	1	PASS



3.7 PHOTO OF 20DB BANDWIDTH MEASUREMENT

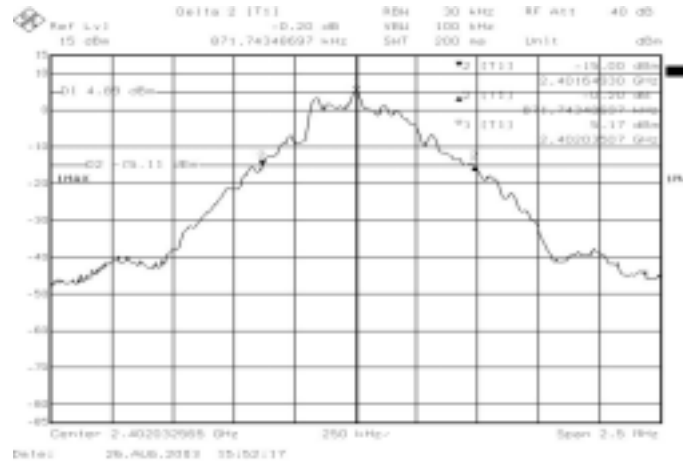

Channel Low

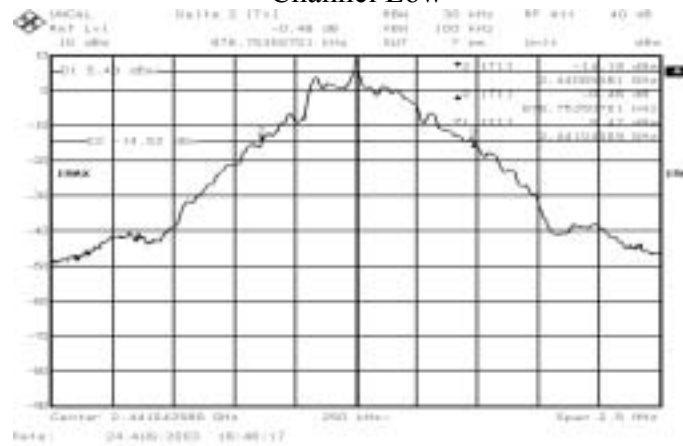

Channel Middle

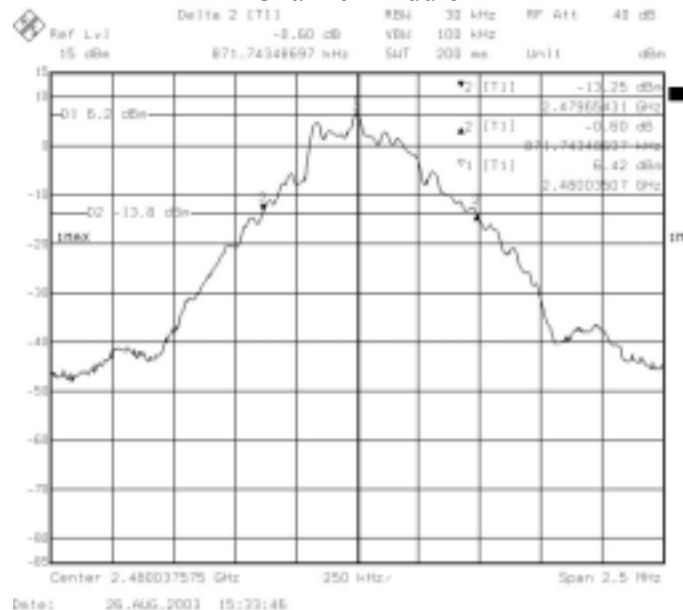

Channel high

4. MAXIMUM PEAK OUTPUT POWER

Test Requirement: 15.247(b)(1)

4.1 TEST EQUIPMENTS

Description & Manufacturer	Model No.	Serial No.	Date Of Calibration
ROHDE & SCHWARZ SPECTRUM ANALYZER	FSEK30	835253/002	JUN. 17, 2003
HP ATTENUATOR	8496B	3247A18505	Cal. on use
HP PLOTTER	7750A	725A 852141	N/A

NOTE :

1. The measurement uncertainty is less than +/- 2.6dB, which is calculated as per the NAMAS document NIS81.
2. The calibration interval of the above test instruments is 12 months and the calibrations are traceable to NML/ROC and NIST/USA.

4.2 TEST SETUP

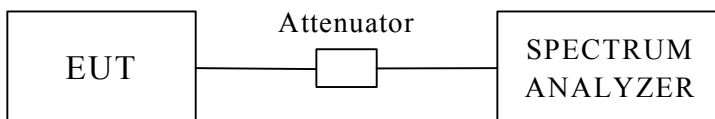

4.3 LIMITS OF MAXIMUM PEAK OUTPUT POWER

The Maximum Peak Output Power Measurement is 1W(30dBm) for frequency hopping systems operating in 2400~2483.5 MHz employing at least 75 hopping channels.



4.4 TEST PROCEDURE

The RF power output was measured with a Power meter connected to the RF Antenna connector (conducted measurement) while EUT was operating in transmit mode at the appropriate center frequency, A spectrum analyzer was used to record the shape of the transmit signal see 4.7 for the measurement set up.

4.5 UNCERTAINTY OF CONDUCTED EMISSION

The uncertainty of conducted emission is ± 1.82 dB.

4.6 TEST RESULTS

Input Power (System)	5VDC	Environmental Conditions	26°C , 55%RH,
Tested By	K. P. Pang		

Channel	Channel Frequency (MHz)	Peak Power Output (dBm)	Peak Power Limit (dBm)	Pass / Fail
Low	2402	6.32	30	PASS
Mid	2441	7.53	30	PASS
High	2480	8.87	30	PASS

Note :

1. At final test to get the worst-case emission at 1Mbps.
2. The result basic equation calculation as follow :
Peak Power Output = Peak Power Reading + Cable loss + Attenuator



5. HOPPING CHANNEL SEPARATION

Test Requirement: 15.247(a)(1)

5.1 TEST EQUIPMENTS

Description & Manufacturer	Model No.	Serial No.	Date Of Calibration
ROHDE & SCHWARZ SPECTRUM ANALYZER	FSEK30	835253/002	JUN. 17, 2003
HP ATTENUATOR	8496B	3247A18505	Cal. on use
HP PLOTTER	7750A	725A 852141	N/A

NOTE :

1. The measurement uncertainty is less than +/- 2.6dB, which is calculated as per the NAMAS document NIS81.
2. The calibration interval of the above test instruments is 12 months and the calibrations are traceable to NML/ROC and NIST/USA.

5.2 TEST SETUP

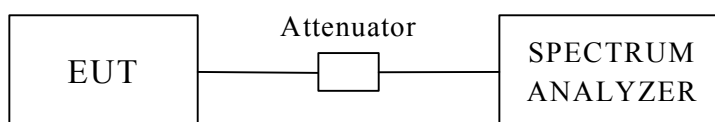

5.3 LIMITS OF HOPPING CHANNEL SEPARATION

According to 15.247(a)(1), frequency hopping system shall have, hopping channel carrier frequencies separated by a minimum of 25kHz or the 20dB bandwidth of the hopping channel, whichever is greater.

5.4 TEST PROCEDURE

1. Check the calibration of the measuring instrument using either an internal calibrator or a known signal from an external generator.
2. Position the EUT as shown in test setup without connection to measurement instrument. Turn on the EUT and connect it to measurement instrument. Then set it to any one convenient frequency within its operating range.
3. By using the MaxHold function record the separation of adjacent channels.
4. Measure the frequency difference of these two adjacent channels by spectrum analyzer MARK function. And then plot the result on spectrum analyzer screen.

Repeat above procedures until all frequencies measured were complete.

5.5 UNCERTAINTY OF CONDUCTED EMISSION

The uncertainty of conducted emission is ± 10 KHz.

5.6 TEST RESULTS

Refer to section 3, 20dB bandwidth measurement:

	Adjacent Hopping Channel Separation (kHz)	20dB bandwidth (kHz)	Minimum Bandwidth	Result
2441MHz (Mid)	997.99kHz	876.75	25kHz	Pass

5.7 PHOTO OF HOPPING CHANNEL SEPARATION

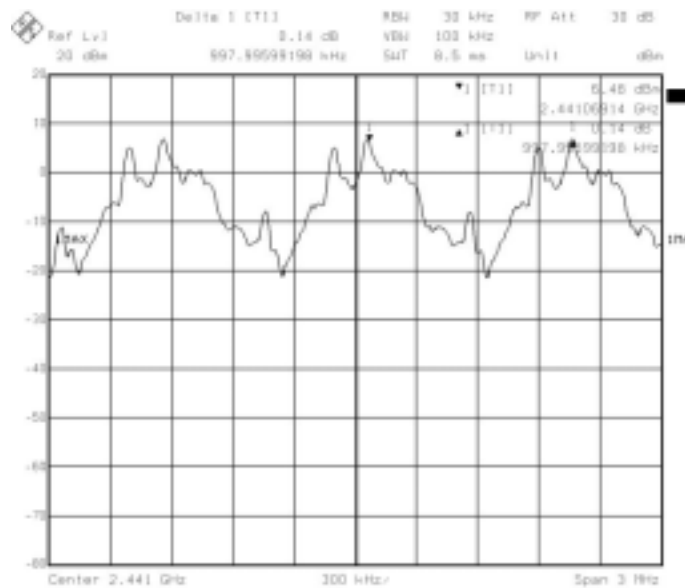

Channel (Mid)

6. NUMBER OF HOPPING FREQUENCY USED

Test Requirement: 15.247(a)(1)(ii)

6.1 TEST EQUIPMENTS

Description & Manufacturer	Model No.	Serial No.	Date Of Calibration
ROHDE & SCHWARZ SPECTRUM ANALYZER	FSEK30	835253/002	JUN. 17, 2003
HP ATTENUATOR	8496B	3247A18505	Cal. on use
HP PLOTTER	7750A	725A 852141	N/A

NOTE :

1. The measurement uncertainty is less than +/- 2.6dB, which is calculated as per the NAMAS document NIS81.
2. The calibration interval of the above test instruments is 12 months and the calibrations are traceable to NML/ROC and NIST/USA.

6.2 TEST SETUP

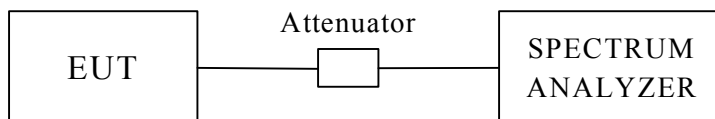

6.3 LIMITS OF NUMBER OF HOPPING FREQUENCY USED

According to 15.247(a)(1)(ii), for frequency hopping system operating in the 2400-2483.5MHz and 5725-5850 MHz bands shall use at least 75 hopping frequencies

6.4 TEST PROCEDURE

1. Check the calibration of the measuring instrument (spectrum analyzer) using either an internal calibrator or a known signal from an external generator.
2. Position the EUT as shown in test setup without connection to measurement instrument. Turn on the EUT and connect its antenna terminal to measurement instrument via a low loss cable. Then set it to any one measured frequency within its operating range and make sure the instrument is operated in its linear range.
3. Set the spectrum analyzer on MaxHold Mode, and then keep the EUT in hopping mode. Record all the signals from each channel until each one has been recorded.
4. Set the spectrum analyzer on View mode and then plot the result on spectrum analyzer screen.
5. Repeat above procedures until all frequencies measured were complete.

6.5 UNCERTAINTY OF CONDUCTED EMISSION

The uncertainty is not applicable.

6.6 TEST RESULTS

Refer to attached graph.

There are 79 hopping frequencies in a hopping sequence.

6.7 PHOTO OF NUMBER OF HOPPING FREQUENCY USED

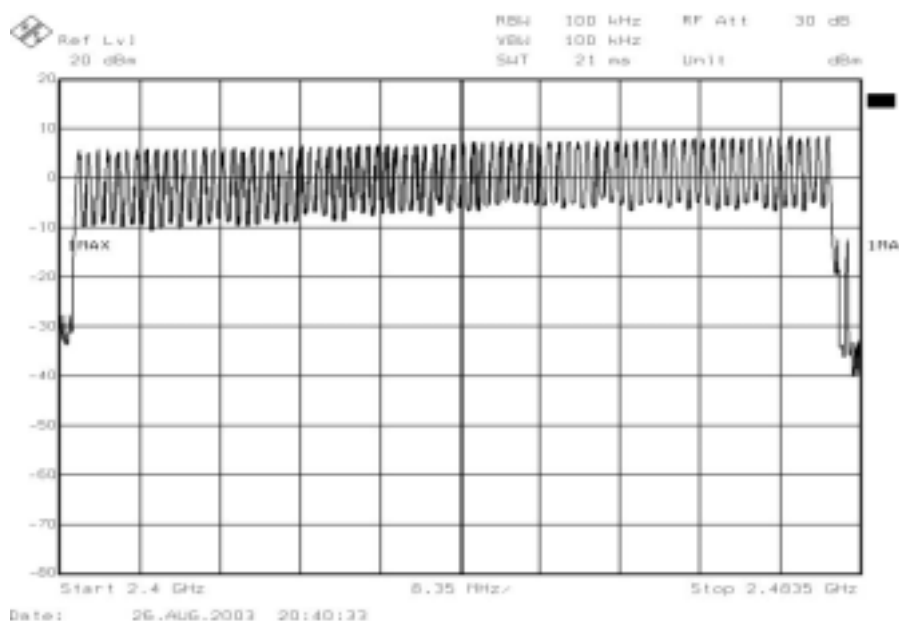

7. DWELL TIME ON EACH CHANNEL

Test Requirement: 15.247(a)(1)(ii)

7.1 TEST EQUIPMENTS

Description & Manufacturer	Model No.	Serial No.	Date Of Calibration
ROHDE & SCHWARZ SPECTRUM ANALYZER	FSEK30	835253/002	JUN. 17, 2003
HP ATTENUATOR	8496B	3247A18505	Cal. on use
HP PLOTTER	7750A	725A 852141	N/A

NOTE :

1. The measurement uncertainty is less than +/- 2.6dB, which is calculated as per the NAMAS document NIS81.
2. The calibration interval of the above test instruments is 12 months and the calibrations are traceable to NML/ROC and NIST/USA.

7.2 TEST SETUP

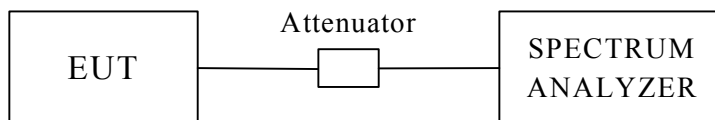

7.3 LIMITS OF DWELL TIME ON EACH CHANNEL

According to 15.247(a)(1)(ii), for frequency hopping system operating in the 2400-2483.5MHz and 5725-5850 MHz band, the average time of occupancy on any frequency shall not be greater than **0.4** second within a 30-second period



7.4 TEST PROCEDURE

1. Check the calibration of the measuring instrument using either an internal calibrator or a known signal from an external generator.
2. Position the EUT as shown in test setup without connection to measurement instrument. Turn on the EUT and connect its antenna terminal to measurement instrument via a low loss cable. Then set it to any one measured frequency within its operating range and make sure the instrument is operated in its linear range.
3. Adjust the center frequency of spectrum analyzer on any frequency be measured and set spectrum analyzer to zero span mode. And then, set RBW and VBW of spectrum analyzer to proper value.
4. Measure the time duration of one transmission on the measured frequency. And then plot the result with time difference of this time duration.
5. Repeat above procedures until all frequencies measured were complete.
6. The Bluetooth PC Card has 3 type of payload, DH1, DH3 and DH5. The hopping rates differ with different payloads. The longer the payload is, the slower the hopping rate is.

7.5 UNCERTAINTY OF CONDUCTED EMISSION

The uncertainty of time is $\pm 5.25\text{ms}$.

7.6 TEST RESULTS

Refer to attached graph.

Transmitting Frequency	Packet type	Hops/30sec	Dwell time (ms)	Time of occupancy on the TX channel in 30sec (ms)	Limit for Time of occupancy on the TX channel in 30sec (ms)	Results
2402MHz	DH1	306	0.410	125.46	400	Pass
2402MHz	DH3	150	1.643	246.45	400	Pass
2402MHz	DH5	102	2.2545	229.95	400	Pass



7.7 PHOTO OF DWELL TIME ON EACH CHANNEL

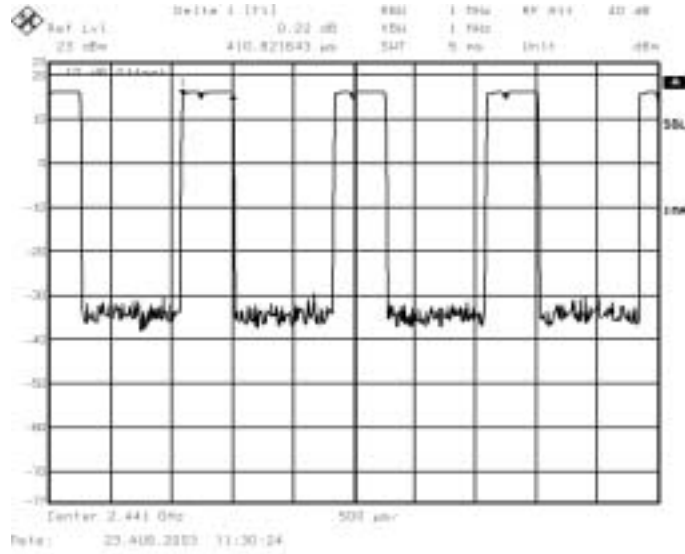

DH1

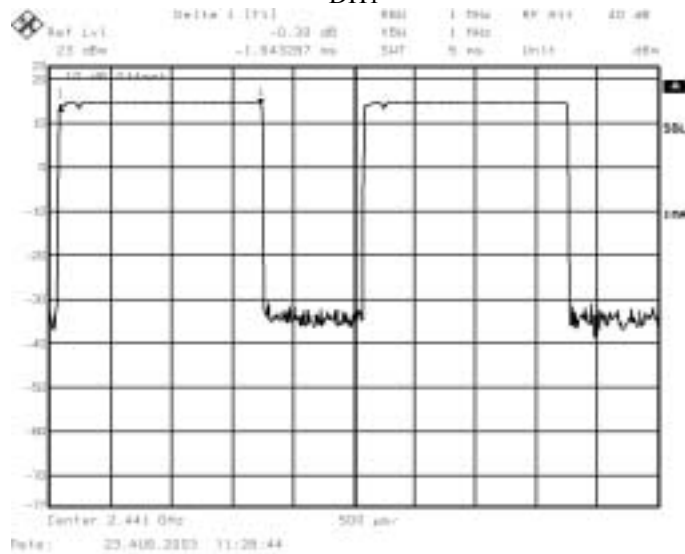

DH3

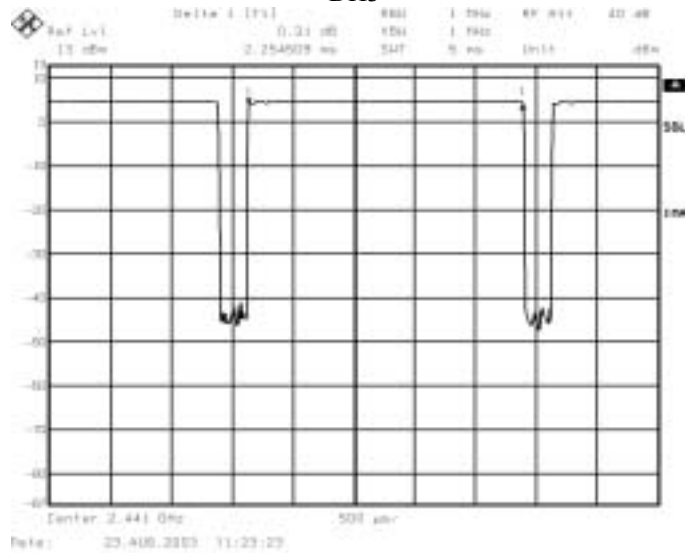

DH5



Ecom Sertech Corp.

Rm. 258, Bldg. 17, NO.195, Sec. 4 Chung Hsing Rd., ChuTung Chen, Hsinchu, Taiwan 310, R.O.C
TEL:886-3-5918012 FAX: 886-3-5825720

FCC ID : BDNBT4163
Report No. : ER03-08-063FRF
Page 25 of 48

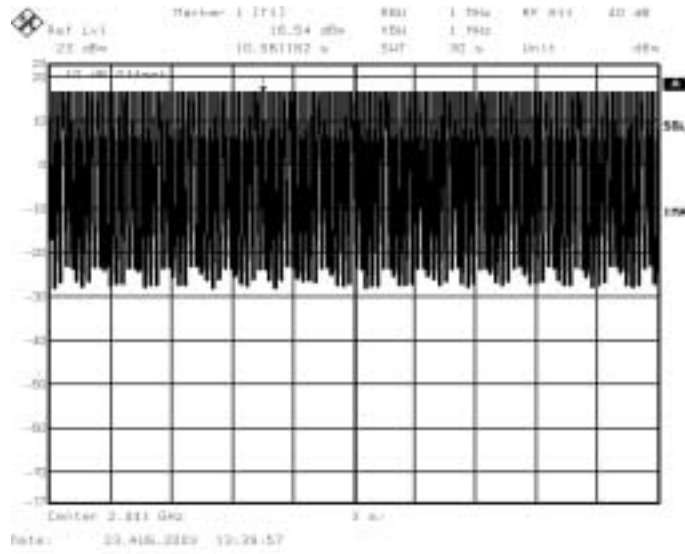

DH1

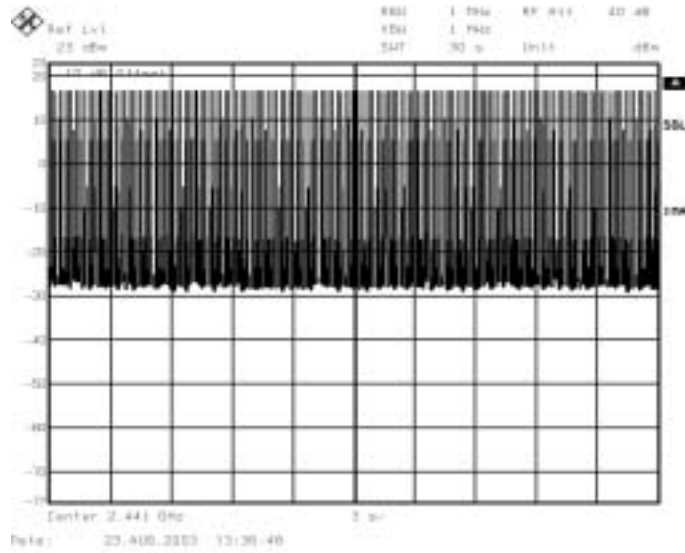

DH3

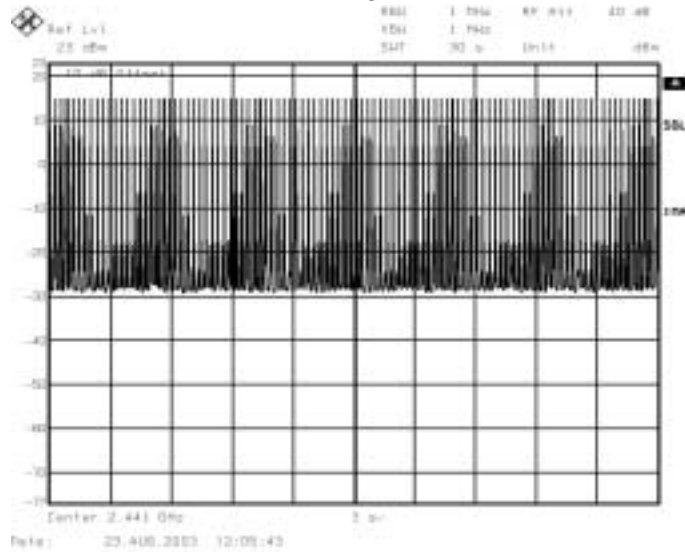

DH5



8. Out of Band Spurious Emissions -Conducted Measurements

Test Requirement: 15.247(c)

8.1 TEST EQUIPMENTS

Description & Manufacturer	Model No.	Serial No.	Date Of Calibration
ROHDE & SCHWARZ SPECTRUM ANALYZER	FSEK30	835253/002	JUN. 17, 2003
HP ATTENUATOR	8496B	3247A18505	Cal. on use
HP PLOTTER	7750A	725A 852141	N/A

NOTE :

3. The measurement uncertainty is less than +/- 2.6dB, which is calculated as per the NAMAS document NIS81.
4. The calibration interval of the above test instruments is 12 months and the calibrations are traceable to NML/ROC and NIST/USA.

8.2 TEST SETUP

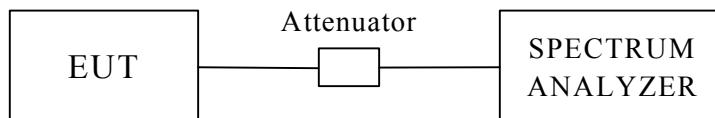

8.3 LIMITS OF Out of Band Measurements

According to Section 15.247(c), all harmonic/spurious must be 20dB down from the highest emission level within the authorized band.



Ecom Sertech Corp.

Rm. 258, Bldg. 17, NO.195, Sec. 4 Chung Hsing Rd., ChuTung Chen, Hsinchu, Taiwan 310, R.O.C
TEL:886-3-5918012 FAX: 886-3-5825720

FCC ID : BDNBT4163

Report No. : ER03-08-063FRF

Page 27 of 48

8.4 TEST PROCEDURE

Section 15.247(c): Spurious emissions. The following tests are required:

RF antenna conducted test: Set RBW= 100kHz, Video bandwidth (VBW) > RBW, scan up through 10th harmonic. All harmonics/spurs must be at least 20 dB down from the highest emission level within the authorized band as measured with a 100kHz RBW.

8.5 UNCERTAINTY OF CONDUCTED EMISSION

The uncertainty of Frequency : $\pm 100\text{kHz}$.

The uncertainty of Amplitude : $\pm 2\text{dB}$.



8.6 TEST RESULTS

Band-edge Compliance of RF Conducted Emissions

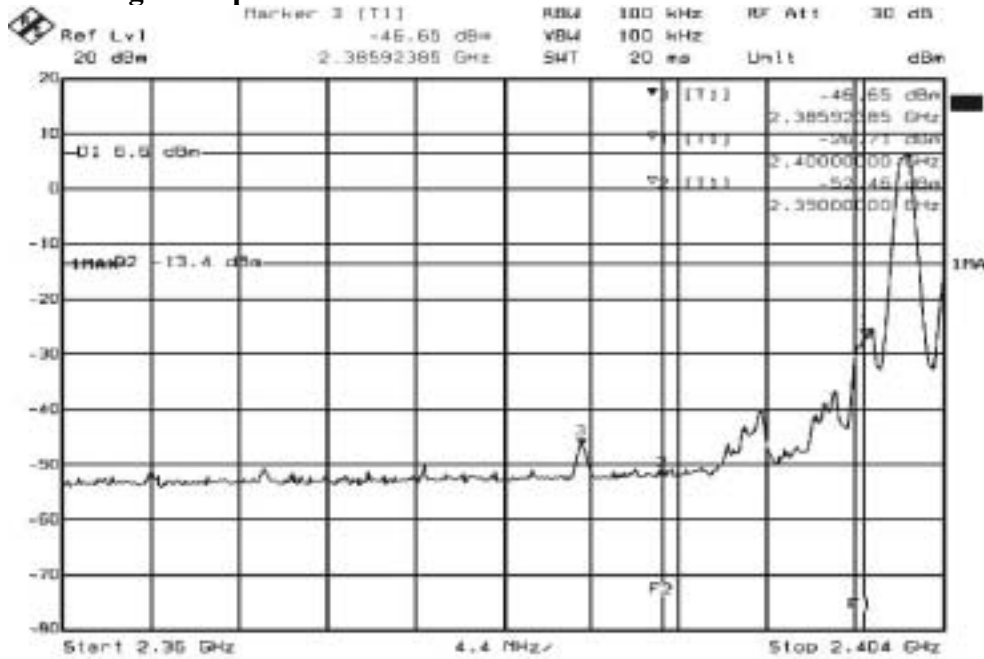

Date: 27.AUG.2003 8:04:31

Front

The highest emission in restricted band outside of the ISM band is -46.65dBm. The marker-delta value 53.25dB now displayed complies with the spurious limit in 15.247(c).

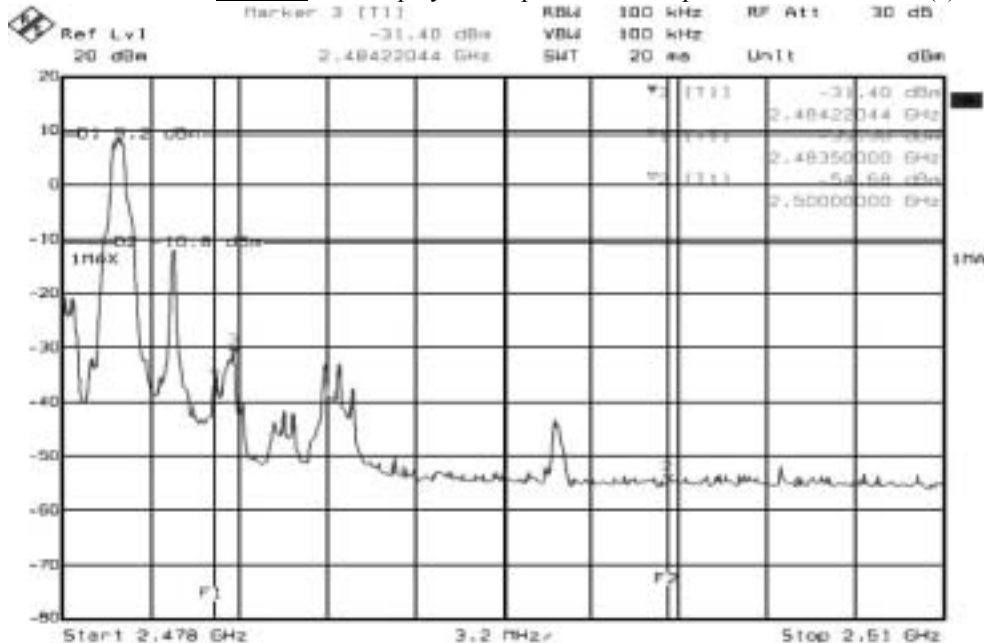

Date: 27.AUG.2003 8:54:39

End

The highest emission in restricted band outside of the ISM band is -31.40dBm. The marker-delta value 40.60dB now displayed complies with the spurious limit in 15.247(c).



Ecom Sertech Corp.

Rm. 258, Bldg. 17, NO.195, Sec. 4 Chung Hsing Rd., ChuTung Chen, Hsinchu, Taiwan 310, R.O.C
TEL:886-3-5918012 FAX : 886-3-5825720

FCC ID : BDNBT4163

Report No. : ER03-08-063FRF

Page 29 of 48

Spurious RF Conducted Emissions

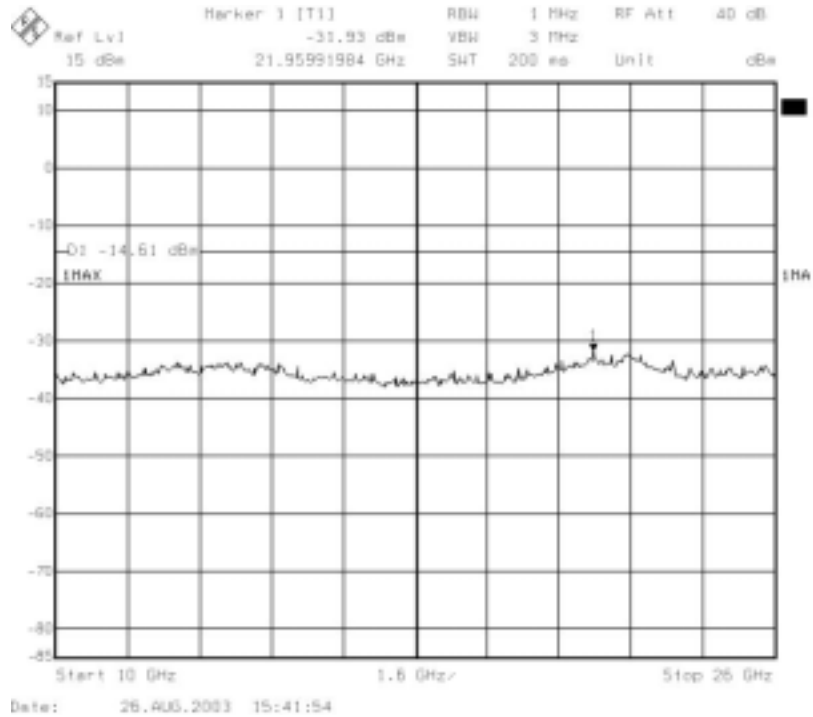
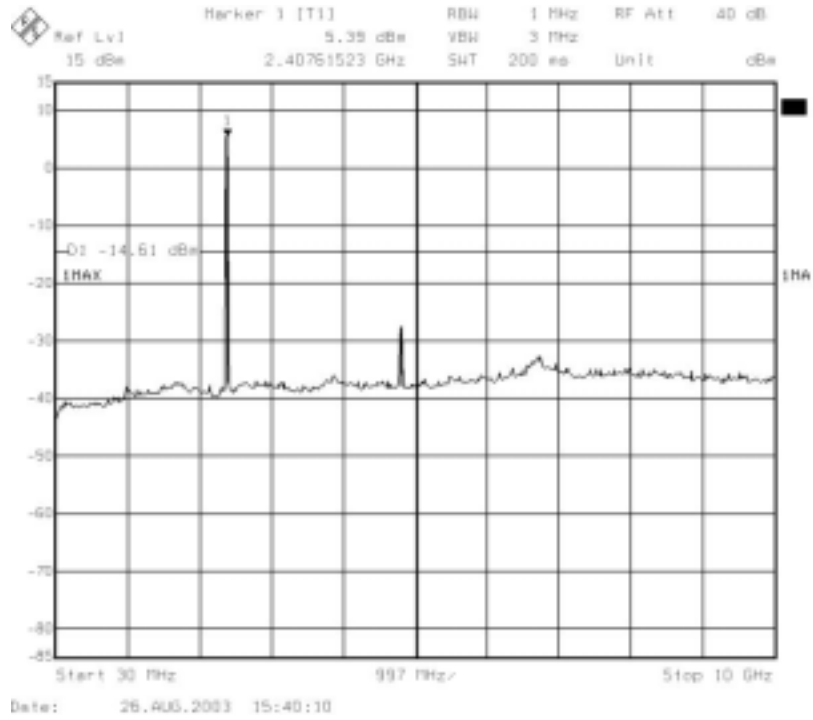

9. Out of Band Spurious Emissions -Radiated Measurements

Test Requirement: 15.247(c)

9.1 TEST EQUIPMENTS

The following test equipments are utilized in making the measurements contained in this report.

Manufacturer or Type	Model No	Serial No	Date of Calibration	Calibration Period	Remark
CHASE BI-LOG ANTENNA	CBL6112B	2421	MAY 07, 2003	1 Year	FINAL
R/S SPECTRUM ANALYZER	FSEK30	835253/002	JUN. 17, 2003	1 Year	FINAL
OPEN SITE	-----	No.2	JAN. 10, 2003	1 Year	FINAL
N TYPE COAXIAL CABLE	CHA9525	4	JUL. 13, 2003	1 Year	FINAL
Horn Antenna	AH-118	10089	FEB. 25, 2003	1 Year	FINAL
HP Pre-amplifier	8449B	3008A01471	OCT. 11, 2002	1 Year	FINAL
HP High pass filter	84300/80038	011	cal. on use	1 Year	FINAL
Horn Antenna	AH-840	03077	FEB. 25, 2003	1 Year	FINAL

9.2 TEST SETUP

The diagram below shows the test setup that is utilized to make the measurements for emission from 30 to 1GHz.

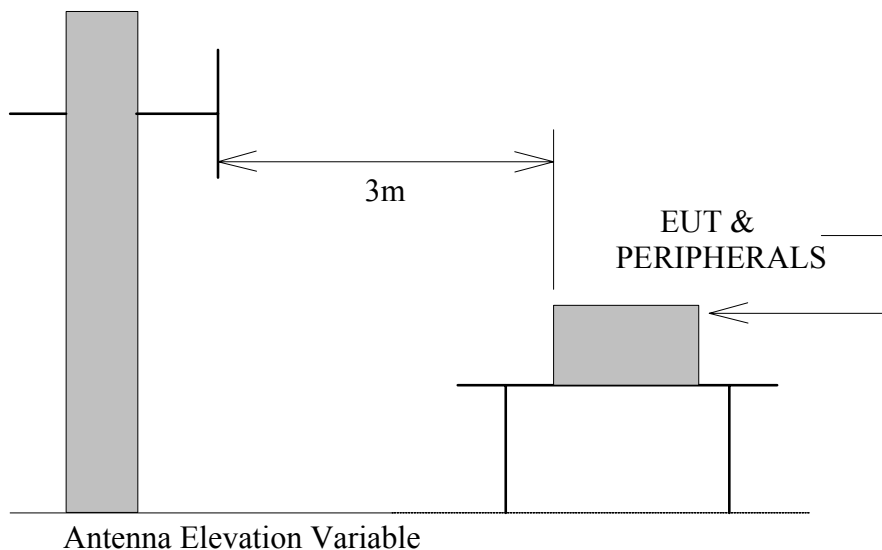

The diagram below shows the test setup that is utilized to make the measurements for emission above 1GHz.

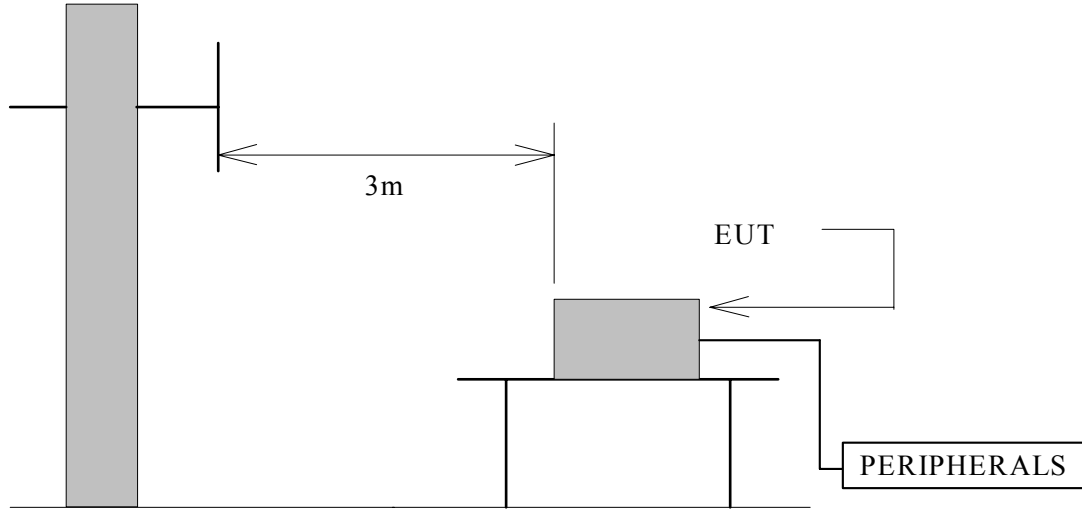

Antenna Elevation Variable

9.3 RADIATION LIMIT

For unintentional device, according to § 15.109(a), except for Class B digital devices, the field strength of radiated emissions from unintentional radiators at a distance of 3 meters shall not exceed the following values :

Frequency (MHz)	Distance (METERS)	Radiated (dB μ V/M)	Radiated (μ V/M)
30-88	3	40.0	100
88-216	3	43.5	150
216-960	3	46.0	200
Above 960	3	54.0	500

For intentional device, according to § 15.209(a), the general requirement of field strength of radiated emissions from intentional radiators at a distance of 3 meters shall not exceed the above table.



9.4 TEST PROCEDURES

- a. The EUT was placed on the top of a rotating table 0.8 meters above the ground at a 10 meter open area test site. The table was rotated 360 degrees to determine the position of the highest radiation.
- b. The EUT was set 3 meters away from the interference-receiving antenna, which was mounted on the top of a variable-height antenna tower.
- c. The antenna is a broadband antenna, and its height is varied from one meter to four meters above the ground to determine the maximum value of the field strength. Both horizontal and vertical polarizations of the antenna are set to make the measurement.
- d. For each suspected emission, the EUT was arranged to its worst case and then the antenna was tuned to heights from 1 meter to 4 meters and the rotatable table was turned from 0 degrees to 360 degrees to find the maximum reading.
- e. The test-receiver system was set to Peak Detect Function and Specified Bandwidth with Maximum Hold Mode.
- f. If the emission level of the EUT in peak mode was 10 dB lower than the limit specified, then testing could be stopped and the peak values of the EUT would be reported. Otherwise the emissions that did not have 10 dB margin would be re-tested one by one using peak, quasi-peak or average method as specified and then reported in a data sheet.

NOTE :

1. The resolution bandwidth and video bandwidth of test receiver/spectrum analyzer is 120 KHz for Peak detection (PK) and Quasi-peak detection (QP) at frequency below 1GHz.
2. The resolution bandwidth and video bandwidth of test receiver/spectrum analyzer is 1 MHz for Peak detection and frequency above 1GHz.
3. The resolution bandwidth of test receiver/spectrum analyzer is 1 MHz and the video bandwidth is 10 Hz for Average detection (AV) at frequency above 1GHz.

9.5 UNCERTAINTY OF RADIATED EMISSION

The uncertainty of radiated emission is ± 2.72 dB.



9.6 RADIATED RF NOISE MEASUREMENT

Test Requirement: 15.109, 15.209

The frequency spectrum from 30 MHz to 1000 MHz was investigated. All emissions not reported below are more than 20 dB below the prescribed limits.

All readings are quasi-peak values.

Temperature : 35 °C

Humidity : 41 % RH

Frequency (MHz)	Antenna Factor (dB)	Cable Loss (dB)	Meter Reading at 3m(dBμV/M)		Limits at 3m (dBμV/M)	Emission Level at 3m(dBμV/M)	
			Horizontal	Vertical		Horizontal	Vertical
30.00	21.39	0.90	*	*	40.00	*	*
31.08	20.61	0.92	10.30	15.90	40.00	31.83	37.43
82.97	9.80	1.66	9.60	25.40	40.00	21.06	36.86
531.23	18.70	5.06	13.20	14.30	46.00	36.96	38.06
566.27	19.13	5.23	10.60	14.00	46.00	34.96	38.36
632.13	19.50	5.56	10.80	12.90	46.00	35.87	37.97
665.77	19.47	5.73	11.30	14.80	46.00	36.50	40.00
702.20	19.45	5.91	17.20	19.10	46.00	42.57	44.47
731.63	19.78	6.06	15.20	16.50	46.00	41.04	42.34
765.27	20.15	6.23	13.20	9.00	46.00	39.57	35.37
800.01	20.53	6.40	12.40	11.90	46.00	39.33	38.83
1000.00	21.58	7.00	*	*	54.00	*	*

REMARKS : 1. * Undetectable

2. Emission level (dB μ V/M) =Antenna Factor (dB/m) + Cable loss (dB) + Meter Reading (dB μ V).

3. The EUT is in TX mode.



Ecom Sertech Corp.

Rm. 258, Bldg. 17, NO.195, Sec. 4 Chung Hsing Rd., ChuTung Chen, Hsinchu, Taiwan 310, R.O.C
 TEL:886-3-5918012 FAX : 886-3-5825720

FCC ID : BDNBT4163

Report No. : ER03-08-063FRF

Page 34 of 48

Test Requirement: 15.205

The frequency spectrum **above 1 GHz** was investigated. All emissions not reported below are more than 40 dB below the prescribed limits. Readings are both peak and average values.

Company	ZOOM	Test Date :	2003/8/6
Product Name	Bluetooth PC Card	Test By:	K. P. Pang
Model Name	Series 4163, Model 4312	TEMP&Humidity :	26°C , 55%

CH(Low) (2402MHz) RX				Measurement Distance at 1m					Horizontal polarity		
Freq.	Reading	AF	Cable	Pre-amp	Dist	Filter	Level	Limit	Margin	Mark	Height
(MHz)	(dBuV)	(dBuV)	(dB)	(dB)	dB	dB	(dBuV/m)	(dBuV/m)	(dB)	(P/Q/A)	(Meter)
4823.61	40.42	34.44	2.77	35.38	9.5	0	32.75	74	-41.25	P	1.0
4823.61	28.46	34.44	2.77	35.38	9.5	0	20.79	54	-33.21	A	1.0
7236.05	40.14	39.81	3.94	35.56	9.5	0	38.83	74	-35.17	P	1.0
7236.05	28.61	39.81	3.94	35.56	9.5	0	27.30	54	-26.70	A	1.0
9647.88	41.57	38.54	4.10	35.67	9.5	0	39.03	74	-34.97	P	1.0
9647.88	28.92	38.54	4.10	35.67	9.5	0	26.38	54	-27.62	A	1.0

1. Measurement was up to 18GHz harmonic,“---” means that the emissions level is too low to be measured.
2. AF: Antenna Factor, Closs: Cable Loss, Pre-Amp: Preamplifier gain, Filter: High Pass Filter Insertion Loss (3.5GHz)
3. Analyzer setting P(Peak): RBW=1MHz, VBW=1MHz, A(Average): RBW=1MHz,VBW=10Hz
4. Dist : correction to extrea plate reading to 3m specification distance 1m measurement distance = -9.5dB
5. The result basic equation calculation as follow :

$$\text{Level} = \text{Reading} + \text{AF} + \text{Closs} - \text{Preamp} + \text{Filter} - \text{Dist}, \text{Margin} = \text{Level} - \text{Limit}$$
6. The test limit distance is 3M limit.
7. The other emission levels were very low against the limit.



Ecom Sertech Corp.

Rm. 258, Bldg. 17, NO.195, Sec. 4 Chung Hsing Rd., ChuTung Chen, Hsinchu, Taiwan 310, R.O.C
TEL:886-3-5918012 FAX : 886-3-5825720

FCC ID : BDNBT4163

Report No. : ER03-08-063FRF

Page 35 of 48

Test Requirement: 15.205

The frequency spectrum above 1 GHz was investigated. All emissions not reported below are more than 40 dB below the prescribed limits. Readings are both peak and average values.

Company	ZOOM	Test Date :	2003/8/6
Product Name	Bluetooth PC Card	Test By:	K. P. Pang
Model Name	Series 4163, Model 4312	TEMP&Humidity :	26°C , 55%

CH(Low) (2402MHz) RX				Measurement Distance at 1m					Vertical polarity		
Freq.	Reading	AF	Cable	Pre-amp	Dist	Filter	Level	Limit	Margin	Mark	Height
(MHz)	(dBuV)	(dBuV)	(dB)	(dB)	dB	dB	(dBuV/m)	(dBuV/m)	(dB)	(P/Q/A)	(Meter)
4824.16	40.81	34.44	2.78	35.38	9.5	0	33.14	74	-40.86	P	1.0
4824.16	28.61	34.44	2.78	35.38	9.5	0	20.94	54	-33.06	A	1.0
7237.55	40.32	39.80	3.95	35.56	9.5	0	39.01	74	-34.99	P	1.0
7237.55	28.46	39.80	3.95	35.56	9.5	0	27.15	54	-26.85	A	1.0
9648.83	42.34	38.54	4.10	35.67	9.5	0	39.80	74	-34.20	P	1.0
9648.83	28.89	38.54	4.10	35.67	9.5	0	26.35	54	-27.65	A	1.0

1. Measurement was up to 18GHz harmonic,“---” means that the emissions level is too low to be measured.
2. AF: Antenna Factor, Closs: Cable Loss, Pre-Amp: Preamplifier gain, Filter: High Pass Filter Insertion Loss (3.5GHz)
3. Analyzer setting P(Peak): RBW=1MHz, VBW=1MHz, A(Average): RBW=1MHz,VBW=10Hz
4. Dist : correction to extrea plate reading to 3m specification distance 1m measurement distance = -9.5dB
5. The result basic equation calculation as follow :
Level = Reading + AF + Closs - Preamp + Filter - Dist, Margin = Level - Limit
6. The test limit distance is 3M limit.
7. The other emission levels were very low against the limit.



Ecom Sertech Corp.

Rm. 258, Bldg. 17, NO.195, Sec. 4 Chung Hsing Rd.,ChuTung Chen, Hsinchu, Taiwan 310, R.O.C
 TEL:886-3-5918012 FAX : 886-3-5825720

FCC ID : BDNBT4163

Report No. : ER03-08-063FRF

Page 36 of 48

Test Requirement: 15.205

The frequency spectrum above 1 GHz was investigated. All emissions not reported below are more than 40 dB below the prescribed limits. Readings are both peak and average values.

Company	ZOOM	Test Date :	2003/8/6
Product Name	Bluetooth PC Card	Test By:	K. P. Pang
Model Name	Series 4163, Model 4312	TEMP&Humidity :	26°C , 55%

CH(Mid) (2441MHz) RX				Measurement Distance at 1m					Horizontal polarity		
Freq.	Reading	AF	Cable	Pre-amp	Dist	Filter	Level	Limit	Margin	Mark	Height
(MHz)	(dBuV)	(dBuV)	(dB)	(dB)	dB	dB	(dBuV/m)	(dBuV/m)	(dB)	(P/Q/A)	(Meter)
4873.83	41.54	34.77	2.80	35.40	9.5	0	34.21	74	-39.79	P	1.0
4873.83	29.68	34.77	2.80	35.40	9.5	0	22.35	54	-31.65	A	1.0
7312.22	41.44	39.78	4.00	35.57	9.5	0	40.15	74	-33.85	P	1.0
7312.22	29.22	39.78	4.00	35.57	9.5	0	27.93	54	-26.07	A	1.0
9747.94	41.57	38.53	4.02	35.72	9.5	0	38.89	74	-35.11	P	1.0
9747.94	29.12	38.53	4.02	35.72	9.5	0	26.44	54	-27.56	A	1.0

1. Measurement was up to 18GHz harmonic,“---” means that the emissions level is too low to be measured.
2. AF: Antenna Factor, Closs: Cable Loss, Pre-Amp: Preamplifier gain, Filter: High Pass Filter Insertion Loss (3.5GHz)
3. Analyzer setting P(Peak): RBW=1MHz, VBW=1MHz, A(Average): RBW=1MHz,VBW=10Hz
4. Dist : correction to extrea plate reading to 3m specification distance 1m measurement distance = -9.5dB
5. The result basic equation calculation as follow :

$$\text{Level} = \text{Reading} + \text{AF} + \text{Closs} - \text{Preamp} + \text{Filter} - \text{Dist}, \text{Margin} = \text{Level} - \text{Limit}$$
6. The test limit distance is 3M limit.
7. The other emission levels were very low against the limit.



Ecom Sertech Corp.

Rm. 258, Bldg. 17, NO.195, Sec. 4 Chung Hsing Rd., ChuTung Chen, Hsinchu, Taiwan 310, R.O.C
 TEL:886-3-5918012 FAX : 886-3-5825720

FCC ID : BDNBT4163

Report No. : ER03-08-063FRF

Page 37 of 48

Test Requirement: 15.205

The frequency spectrum above 1 GHz was investigated. All emissions not reported below are more than 40 dB below the prescribed limits. Readings are both peak and average values.

Company	ZOOM	Test Date :	2003/8/6
Product Name	Bluetooth PC Card	Test By:	K. P. Pang
Model Name	Series 4163, Model 4312	TEMP&Humidity :	26°C , 55%

CH(Mid) (2441MHz) RX				Measurement Distance at 1m					Vertical polarity		
Freq.	Reading	AF	Cable	Pre-amp	Dist	Filter	Level	Limit	Margin	Mark	Height
(MHz)	(dBuV)	(dBuV)	(dB)	(dB)	dB	dB	(dBuV/m)	(dBuV/m)	(dB)	(P/Q/A)	(Meter)
4873.16	41.73	34.76	2.80	35.40	9.5	0	34.40	74	-39.60	P	1.0
4873.16	29.75	34.76	2.80	35.40	9.5	0	22.42	54	-31.58	A	1.0
7311.55	40.83	39.78	4.00	35.57	9.5	0	39.54	74	-34.46	P	1.0
7311.55	28.46	39.78	4.00	35.57	9.5	0	27.17	54	-26.83	A	1.0
9747.61	40.47	38.53	4.02	35.72	9.5	0	37.79	74	-36.21	P	1.0
9747.61	29.14	38.53	4.02	35.72	9.5	0	26.46	54	-27.54	A	1.0

1. Measurement was up to 18GHz harmonic,“---” means that the emissions level is too low to be measured.
2. AF: Antenna Factor, Closs: Cable Loss, Pre-Amp: Preamplifier gain, Filter: High Pass Filter Insertion Loss (3.5GHz)
3. Analyzer setting P(Peak): RBW=1MHz, VBW=1MHz, A(Average): RBW=1MHz,VBW=10Hz
4. Dist : correction to extrea plate reading to 3m specification distance 1m measurement distance = -9.5dB
5. The result basic equation calculation as follow :

$$\text{Level} = \text{Reading} + \text{AF} + \text{Closs} - \text{Preamp} + \text{Filter} - \text{Dist}, \text{Margin} = \text{Level} - \text{Limit}$$
6. The test limit distance is 3M limit.
7. The other emission levels were very low against the limit.



Ecom Sertech Corp.

Rm. 258, Bldg. 17, NO.195, Sec. 4 Chung Hsing Rd., ChuTung Chen, Hsinchu, Taiwan 310, R.O.C
 TEL:886-3-5918012 FAX : 886-3-5825720

FCC ID : BDNBT4163

Report No. : ER03-08-063FRF

Page 38 of 48

Test Requirement: 15.205

The frequency spectrum above 1 GHz was investigated. All emissions not reported below are more than 40 dB below the prescribed limits. Readings are both peak and average values.

Company	ZOOM	Test Date :	2003/8/6
Product Name	Bluetooth PC Card	Test By:	K. P. Pang
Model Name	Series 4163, Model 4312	TEMP&Humidity :	26°C , 55%

CH(High) (2480MHz) RX				Measurement Distance at 1m					Horizontal polarity		
Freq.	Reading	AF	Cable	Pre-amp	Dist	Filter	Level	Limit	Margin	Mark	Height
(MHz)	(dBuV)	(dBuV)	(dB)	(dB)	dB	dB	(dBuV/m)	(dBuV/m)	(dB)	(P/Q/A)	(Meter)
4923.27	42.54	35.09	2.83	35.41	9.5	0	35.55	74	-38.45	P	1.0
4923.27	29.88	35.09	2.83	35.41	9.5	0	22.89	54	-31.11	A	1.0
7387.99	41.75	39.74	4.06	35.57	9.5	0	40.48	74	-33.52	P	1.0
7387.99	29.09	39.74	4.06	35.57	9.5	0	27.82	54	-26.18	A	1.0
9848.16	41.74	38.52	3.93	35.77	9.5	0	38.92	74	-35.08	P	1.0
9848.16	29.47	38.52	3.93	35.77	9.5	0	26.65	54	-27.35	A	1.0

1. Measurement was up to 18GHz harmonic,“---” means that the emissions level is too low to be measured.
2. AF: Antenna Factor, Closs: Cable Loss, Pre-Amp: Preamplifier gain, Filter: High Pass Filter Insertion Loss (3.5GHz)
3. Analyzer setting P(Peak): RBW=1MHz, VBW=1MHz, A(Average): RBW=1MHz,VBW=10Hz
4. Dist : correction to extrea plate reading to 3m specification distance 1m measurement distance = -9.5dB
5. The result basic equation calculation as follow :

$$\text{Level} = \text{Reading} + \text{AF} + \text{Closs} - \text{Preamp} + \text{Filter} - \text{Dist}, \text{Margin} = \text{Level} - \text{Limit}$$
6. The test limit distance is 3M limit.
7. The other emission levels were very low against the limit.



Ecom Sertech Corp.

Rm. 258, Bldg. 17, NO.195, Sec. 4 Chung Hsing Rd.,ChuTung Chen, Hsinchu, Taiwan 310, R.O.C
TEL:886-3-5918012 FAX : 886-3-5825720

FCC ID : BDNBT4163

Report No. : ER03-08-063FRF

Page 39 of 48

Test Requirement: 15.205

The frequency spectrum above 1 GHz was investigated. All emissions not reported below are more than 40 dB below the prescribed limits. Readings are both peak and average values.

Company	ZOOM	Test Date :	2003/8/6
Product Name	Bluetooth PC Card	Test By:	K. P. Pang
Model Name	Series 4163, Model 4312	TEMP&Humidity :	26°C , 55%

CH(High) (2480MHz) RX				Measurement Distance at 1m					Vertical polarity		
Freq.	Reading	AF	Cable	Pre-amp	Dist	Filter	Level	Limit	Margin	Mark	Height
(MHz)	(dBuV)	(dBuV)	(dB)	(dB)	dB	dB	(dBuV/m)	(dBuV/m)	(dB)	(P/Q/A)	(Meter)
4923.11	40.16	35.09	2.83	35.41	9.5	0	33.17	74	-40.83	P	1.0
4923.11	29.86	35.09	2.83	35.41	9.5	0	22.87	54	-31.13	A	1.0
7387.05	40.06	39.75	4.06	35.57	9.5	0	38.79	74	-35.21	P	1.0
7387.05	28.15	39.75	4.06	35.57	9.5	0	26.88	54	-27.12	A	1.0
9847.83	41.23	38.52	3.93	35.77	9.5	0	38.41	74	-35.59	P	1.0
9847.83	29.47	38.52	3.93	35.77	9.5	0	26.65	54	-27.35	A	1.0

1. Measurement was up to 18GHz harmonic,“---” means that the emissions level is too low to be measured.
2. AF: Antenna Factor, Closs: Cable Loss, Pre-Amp: Preamplifier gain, Filter: High Pass Filter Insertion Loss (3.5GHz)
3. Analyzer setting P(Peak): RBW=1MHz, VBW=1MHz, A(Average): RBW=1MHz,VBW=10Hz
4. Dist : correction to extrea plate reading to 3m specification distance 1m measurement distance = -9.5dB
5. The result basic equation calculation as follow :

$$\text{Level} = \text{Reading} + \text{AF} + \text{Closs} - \text{Preamp} + \text{Filter} - \text{Dist}, \text{Margin} = \text{Level} - \text{Limit}$$
6. The test limit distance is 3M limit.
7. The other emission levels were very low against the limit.



Ecom Sertech Corp.

Rm. 258, Bldg. 17, NO.195, Sec. 4 Chung Hsing Rd., ChuTung Chen, Hsinchu, Taiwan 310, R.O.C
 TEL:886-3-5918012 FAX: 886-3-5825720

FCC ID : BDNBT4163

Report No. : ER03-08-063FRF

Page 40 of 48

Test Requirement: 15.205

The frequency spectrum above 1 GHz was investigated. All emissions not reported below are more than 40 dB below the prescribed limits. Readings are both peak and average values.

Company	ZOOM	Test Date :	2003/8/6
Product Name	Bluetooth PC Card	Test By:	K. P. Pang
Model Name	Series 4163, Model 4312	TEMP&Humidity :	26°C , 55%

CH(Low) (2402MHz) TX				Measurement Distance at 1m				Horizontal polarity			
Freq.	Reading	AF	Cable	Pre-amp	Dist	Filter	Level	Limit	Margin	Mark	Height
(MHz)	(dBuV)	(dBuV)	(dB)	(dB)	dB	dB	(dBuV/m)	(dBuV/m)	(dB)	(P/Q/A)	(Meter)
*2385.92	53.25	(delta between carrier and local max emission)					30.07	74	-43.93	P	1.00
*2385.92	53.25	(delta between carrier and local max emission)					29.24	54	-24.76	A	1.00
2402.01	58.69	31.80	2.33	0.00	9.50	0.00	83.32	Fundamental Frequency		P	1.00
2402.01	57.86	31.80	2.33	0.00	9.50	0.00	82.49			A	1.00
*4804.15	54.10	34.31	2.76	35.38	9.50	1.00	47.29	74	-26.71	P	1.00
*4804.15	49.07	34.31	2.76	35.38	9.50	1.00	42.26	54	-11.74	A	1.00
7206.61	54.66	39.82	3.92	35.56	9.50	1.00	54.34	74	-19.66	P	1.00
7206.61	47.87	39.82	3.92	35.56	9.50	1.00	47.55	54	-6.45	A	1.00
9608.28	52.05	38.54	4.13	35.65	9.50	1.00	50.57	74	-23.43	P	1.00
9608.28	43.58	38.54	4.13	35.65	9.50	1.00	42.10	54	-11.90	A	1.00
*12010.05	-----	-----	-----	-----	11.50	3.00	-----	-----	-----	-----	1.00
14412.06	-----	-----	-----	-----	9.50	1.00	-----	-----	-----	-----	1.00
16814.07	-----	-----	-----	-----	9.50	1.00	-----	-----	-----	-----	1.00
*19216.08	-----	-----	-----	-----	9.50	1.00	-----	-----	-----	-----	1.00
21618.09	-----	-----	-----	-----	9.50	1.00	-----	-----	-----	-----	1.00
24020.10	-----	-----	-----	-----	9.50	1.00	-----	-----	-----	-----	1.00

Note :

- The measurement was searched to 10th harmonic, Remark “---” means that the emissions level is too low to be measured.
- AF: Antenna Factor, Closs: Cable Loss, Pre-Amp: Preamplifier gain, Filter: High Pass Filter Insertion Loss (3.5GHz)
- Analyzer setting P(Peak): RBW=1MHz, VBW=1MHz, A(Average): RBW=1MHz, VBW=10Hz
- Remark “*” means that Restricted band.
- Dist : correction to extra plate reading to 3m specification distance 1m measurement distance = -9.5dB
- The result basic equation calculation is as follow:
 $Level = Reading + AF + Closs - Preamp + Filter - Dist$, $Margin = Level - Limit$
- The other emission levels were very low against the limit
- The test limit distance is 3M limit.



Ecom Sertech Corp.

Rm. 258, Bldg. 17, NO.195, Sec. 4 Chung Hsing Rd., ChuTung Chen, Hsinchu, Taiwan 310, R.O.C
 TEL:886-3-5918012 FAX : 886-3-5825720

FCC ID : BDNBT4163

Report No. : ER03-08-063FRF

Page 41 of 48

Test Requirement: 15.205

The frequency spectrum above 1 GHz was investigated. All emissions not reported below are more than 40 dB below the prescribed limits. Readings are both peak and average values.

Company	ZOOM	Test Date :	2003/8/6
Product Name	Bluetooth PC Card	Test By:	K. P. Pang
Model Name	Series 4163, Model 4312	TEMP&Humidity :	26°C , 55%

CH(Low) (2402MHz) TX				Measurement Distance at 3m				Vertical polarity			
Freq.	Reading	AF	Cable	Pre-amp	Dist	Filter	Level	Limit	Margin	Mark	Height
(MHz)	(dBuV)	(dBuV)	(dB)	(dB)	dB	dB	(dBuV/m)	(dBuV/m)	(dB)	(P/Q/A)	(Meter)
*2385.92	53.25	(delta between carrier and local max emission)					34.93	74	-39.07	P	1.00
*2385.92	53.25	(delta between carrier and local max emission)					34.21	54	-19.79	A	1.00
2402.01	63.55	31.80	2.33	0.00	9.50	0.00	88.18	Fundamental Frequency		P	1.00
2402.01	62.83	31.80	2.33	0.00	9.50	0.00	87.46			A	1.00
*4804.15	63.30	34.31	2.76	35.38	9.50	1.00	56.49	74	-17.51	P	1.00
*4804.15	59.08	34.31	2.76	35.38	9.50	1.00	52.27	54	-1.73	A	1.00
7206.61	55.72	39.82	3.92	35.56	9.50	1.00	55.40	74	-18.60	P	1.00
7206.61	48.93	39.82	3.92	35.56	9.50	1.00	48.61	54	-5.39	A	1.00
9608.28	57.45	38.54	4.13	35.65	9.50	1.00	55.97	74	-18.03	P	1.00
9608.28	49.67	38.54	4.13	35.65	9.50	1.00	48.19	54	-5.81	A	1.00
*12010.05	-----	-----	-----	-----	10.50	2.00	-----	-----	-----	-----	1.00
14412.06	-----	-----	-----	-----	9.50	1.00	-----	-----	-----	-----	1.00
16814.07	-----	-----	-----	-----	9.50	1.00	-----	-----	-----	-----	1.00
*19216.08	-----	-----	-----	-----	9.50	1.00	-----	-----	-----	-----	1.00
21618.09	-----	-----	-----	-----	9.50	1.00	-----	-----	-----	-----	1.00
24020.10	-----	-----	-----	-----	9.50	1.00	-----	-----	-----	-----	1.00

Note :

- The measurement was searched to 10th harmonic, Remark “---” means that the emissions level is too low to be measured.
- AF: Antenna Factor, Closs: Cable Loss, Pre-Amp: Preamplifier gain, Filter: High Pass Filter Insertion Loss (3.5GHz)
- Analyzer setting P(Peak): RBW=1MHz, VBW=1MHz, A(Average): RBW=1MHz, VBW=10Hz
- Remark “*” means that Restricted band.
- Dist : correction to extra plate reading to 3m specification distance 1m measurement distance = -9.5dB
- The result basic equation calculation is as follow:
 $Level=Reading+AF+Closs-Preamp+Filter-Dist, Margin=Level-Limit$
- The other emission levels were very low against the limit
- The test limit distance is 3M limit.



Ecom Sertech Corp.

Rm. 258, Bldg. 17, NO.195, Sec. 4 Chung Hsing Rd., ChuTung Chen, Hsinchu, Taiwan 310, R.O.C
 TEL:886-3-5918012 FAX : 886-3-5825720

FCC ID : BDNBT4163

Report No. : ER03-08-063FRF

Page 42 of 48

Test Requirement: 15.205

The frequency spectrum above 1 GHz was investigated. All emissions not reported below are more than 40 dB below the prescribed limits. Readings are both peak and average values.

Company	ZOOM	Test Date :	2003/8/6
Product Name	Bluetooth PC Card	Test By:	K. P. Pang
Model Name	Series 4163, Model 4312	TEMP&Humidity :	26°C , 55%

CH(Mid) (2441MHz) TX				Measurement Distance at 1m				Horizontal polarity			
Freq.	Reading	AF	Cable	Pre-amp	Dist	Filter	Level	Limit	Margin	Mark	Height
(MHz)	(dBuV)	(dBuV)	(dB)	(dB)	dB	dB	(dBuV/m)	(dBuV/m)	(dB)	(P/Q/A)	(Meter)
2441.62	59.09	31.76	2.44	0.00	9.50	0.00	83.78	Fundamental Frequency		P	1.00
2441.62	58.39	31.76	2.44	0.00	9.50	0.00	83.08			A	1.00
*4882.62	47.21	34.83	2.81	35.40	9.50	1.00	40.94	74	-33.06	P	1.00
*4882.62	38.20	34.83	2.81	35.40	9.50	1.00	31.93	54	-22.07	A	1.00
*7323.69	51.95	39.77	4.01	35.57	9.50	1.00	51.66	74	-22.34	P	1.00
*7323.69	45.04	39.77	4.01	35.57	9.50	1.00	44.75	54	-9.25	A	1.00
9765.02	54.45	38.52	4.00	35.73	9.50	1.00	52.74	74	-21.26	P	1.00
9765.02	46.40	38.52	4.00	35.73	10.50	2.00	44.69	75	-30.31	P	1.00
*12208.10	-----	-----	-----	-----	10.50	2.00	-----	-----	-----	-----	1.00
14649.72	-----	-----	-----	-----	9.50	1.00	-----	-----	-----	-----	1.00
17091.34	-----	-----	-----	-----	9.50	1.00	-----	-----	-----	-----	1.00
*19532.96	-----	-----	-----	-----	9.50	1.00	-----	-----	-----	-----	1.00
21974.58	-----	-----	-----	-----	9.50	1.00	-----	-----	-----	-----	1.00
24416.20	-----	-----	-----	-----	9.50	1.00	-----	-----	-----	-----	1.00

Note :

- The measurement was searched to 10th harmonic, Remark “---” means that the emissions level is too low to be measured.
- AF: Antenna Factor, Closs: Cable Loss, Pre-Amp: Preamplifier gain, Filter: High Pass Filter Insertion Loss (3.5GHz)
- Analyzer setting P(Peak): RBW=1MHz, VBW=1MHz, A(Average): RBW=1MHz, VBW=10Hz
- Remark “*” means that Restricted band.
- Dist : correction to extra plate reading to 3m specification distance 1m measurement distance = -9.5dB
- The result basic equation calculation is as follow:
 $Level = Reading + AF + Closs - Preamp + Filter - Dist$, $Margin = Level - Limit$
- The other emission levels were very low against the limit
- The test limit distance is 3M limit.



Ecom Sertech Corp.

Rm. 258, Bldg. 17, NO.195, Sec. 4 Chung Hsing Rd., ChuTung Chen, Hsinchu, Taiwan 310, R.O.C
 TEL:886-3-5918012 FAX : 886-3-5825720

FCC ID : BDNBT4163

Report No. : ER03-08-063FRF

Page 43 of 48

Test Requirement: 15.205

The frequency spectrum above 1 GHz was investigated. All emissions not reported below are more than 40 dB below the prescribed limits. Readings are both peak and average values.

Company	ZOOM	Test Date :	2003/8/6
Product Name	Bluetooth PC Card	Test By:	K. P. Pang
Model Name	Series 4163, Model 4312	TEMP&Humidity :	26°C , 55%

CH(Mid) (2441MHz) TX				Measurement Distance at 1m					Vertical polarity		
Freq.	Reading	AF	Cable	Pre-amp	Dist	Filter	Level	Limit	Margin	Mark	Height
(MHz)	(dBuV)	(dBuV)	(dB)	(dB)	dB	dB	(dBuV/m)	(dBuV/m)	(dB)	(P/Q/A)	(Meter)
2441.62	64.07	31.76	2.44	0.00	9.50	0.00	88.76	Fundamental Frequency		P	1.00
2441.62	63.34	31.76	2.44	0.00	9.50	0.00	88.03			A	1.00
*4882.62	51.99	34.83	2.81	35.40	9.50	1.00	45.72	74	-28.28	P	1.00
*4882.62	47.13	34.83	2.81	35.40	9.50	1.00	40.86	54	-13.14	A	1.00
*7323.69	55.68	39.77	4.01	35.57	9.50	1.00	55.39	74	-18.61	P	1.00
*7323.69	48.41	39.77	4.01	35.57	9.50	1.00	48.12	54	-5.88	A	1.00
9765.02	61.61	38.52	4.00	35.73	9.50	1.00	59.90	74	-14.10	P	1.00
9766.02	53.58	38.52	4.00	35.73	10.50	2.00	51.87	75	-23.13	P	1.00
*12208.10	-----	-----	-----	-----	10.50	2.00	-----	-----	-----	-----	1.00
14649.72	-----	-----	-----	-----	9.50	1.00	-----	-----	-----	-----	1.00
17091.34	-----	-----	-----	-----	9.50	1.00	-----	-----	-----	-----	1.00
*19532.96	-----	-----	-----	-----	9.50	1.00	-----	-----	-----	-----	1.00
21974.58	-----	-----	-----	-----	9.50	1.00	-----	-----	-----	-----	1.00
24416.20	-----	-----	-----	-----	9.50	1.00	-----	-----	-----	-----	1.00

Note :

- The measurement was searched to 10th harmonic, Remark “---” means that the emissions level is too low to be measured.
- AF: Antenna Factor, Closs: Cable Loss, Pre-Amp: Preamplifier gain, Filter: High Pass Filter Insertion Loss (3.5GHz)
- Analyzer setting P(Peak): RBW=1MHz, VBW=1MHz, A(Average): RBW=1MHz, VBW=10Hz
- Remark “*” means that Restricted band.
- Dist : correction to extra plate reading to 3m specification distance 1m measurement distance = -9.5dB
- The result basic equation calculation is as follow:
 $Level=Reading+AF+Closs-Preamp+Filter-Dist, Margin=Level-Limit$
- The other emission levels were very low against the limit
- The test limit distance is 3M limit.



Ecom Sertech Corp.

Rm. 258, Bldg. 17, NO.195, Sec. 4 Chung Hsing Rd., ChuTung Chen, Hsinchu, Taiwan 310, R.O.C
 TEL:886-3-5918012 FAX : 886-3-5825720

FCC ID : BDNBT4163

Report No. : ER03-08-063FRF

Page 44 of 48

Test Requirement: 15.205

The frequency spectrum above 1 GHz was investigated. All emissions not reported below are more than 40 dB below the prescribed limits. Readings are both peak and average values.

Company	ZOOM	Test Date :	2003/8/6
Product Name	Bluetooth PC Card	Test By:	K. P. Pang
Model Name	Series 4163, Model 4312	TEMP&Humidity :	26°C , 55%

CH(High) (2480MHz) TX				Measurement Distance at 1m				Horizontal polarity			
Freq.	Reading	AF	Cable	Pre-amp	Dist	Filter	Level	Limit	Margin	Mark	Height
(MHz)	(dBuV)	(dBuV)	(dB)	(dB)	dB	dB	(dBuV/m)	(dBuV/m)	(dB)	(P/Q/A)	(Meter)
2480.94	60.31	31.72	2.54	0.00	9.50	0.00	85.07	Fundamental Frequency		P	1.00
2480.94	59.38	31.72	2.54	0.00	9.50	0.00	84.14			A	1.00
*2484.22	40.60	(delta between carrier and local max emission)					44.47	74	-29.53	P	1.00
*2484.22	40.60	(delta between carrier and local max emission)					43.54	54	-10.46	A	1.00
*4961.62	44.61	35.35	2.85	35.42	9.50	1.00	38.89	74	-35.11	P	1.00
*4961.62	35.17	35.35	2.85	35.42	9.50	1.00	29.45	54	-24.55	A	1.00
*7441.92	47.75	39.72	4.10	35.58	9.50	1.00	47.50	74	-26.50	P	1.00
*7441.92	39.80	39.72	4.10	35.58	9.50	1.00	39.55	54	-14.45	A	1.00
9919.62	48.63	38.51	3.88	35.81	9.50	1.00	46.70	74	-27.30	P	1.00
9919.62	38.70	38.51	3.88	35.81	9.50	1.00	36.77	54	-17.23	A	1.00
*12404.70	-----	-----	-----	-----	10.50	2.00	-----	-----	-----	-----	1.00
14885.64	-----	-----	-----	-----	9.50	1.00	-----	-----	-----	-----	1.00
17366.58	-----	-----	-----	-----	9.50	1.00	-----	-----	-----	-----	1.00
*19847.52	-----	-----	-----	-----	9.50	1.00	-----	-----	-----	-----	1.00
*22328.46	-----	-----	-----	-----	9.50	1.00	-----	-----	-----	-----	1.00
24809.40	-----	-----	-----	-----	9.50	1.00	-----	-----	-----	-----	1.00

Note :

- The measurement was searched to 10th harmonic, Remark “---” means that the emissions level is too low to be measured.
- AF: Antenna Factor, Closs: Cable Loss, Pre-Amp: Preamplifier gain, Filter: High Pass Filter Insertion Loss (3.5GHz)
- Analyzer setting P(Peak): RBW=1MHz, VBW=1MHz, A(Average): RBW=1MHz, VBW=10Hz
- Remark “*” means that Restricted band.
- Dist : correction to extra plate reading to 3m specification distance 1m measurement distance = -9.5dB
- The result basic equation calculation is as follow:
 $Level = Reading + AF + Closs - Preamp + Filter - Dist$, $Margin = Level - Limit$
- The other emission levels were very low against the limit
- The test limit distance is 3M limit.



Ecom Sertech Corp.

Rm. 258, Bldg. 17, NO.195, Sec. 4 Chung Hsing Rd., ChuTung Chen, Hsinchu, Taiwan 310, R.O.C
 TEL:886-3-5918012 FAX : 886-3-5825720

FCC ID : BDNBT4163

Report No. : ER03-08-063FRF

Page 45 of 48

Test Requirement: 15.205

The frequency spectrum above 1 GHz was investigated. All emissions not reported below are more than 40 dB below the prescribed limits. Readings are both peak and average values.

Company	ZOOM	Test Date :	2003/8/6
Product Name	Bluetooth PC Card	Test By:	K. P. Pang
Model Name	Series 4163, Model 4312	TEMP&Humidity :	26°C , 55%

CH(High) (2480MHz) TX				Measurement Distance at 1m					Vertical polarity		
Freq.	Reading	AF	Cable	Pre-amp	Dist	Filter	Level	Limit	Margin	Mark	Height
(MHz)	(dBuV)	(dBuV)	(dB)	(dB)	dB	dB	(dBuV/m)	(dBuV/m)	(dB)	(P/Q/A)	(Meter)
2480.94	65.59	31.72	2.54	0.00	9.50	0.00	90.35	Fundamental Frequency		P	1.00
2480.94	64.73	31.72	2.54	0.00	9.50	0.00	89.49			A	1.00
*2484.22	40.60	(delta between carrier and local max emission)					49.75	74	-24.25	P	1.00
*2484.22	40.60	(delta between carrier and local max emission)					48.89	54	-5.11	A	1.00
*4961.62	49.41	35.35	2.85	35.42	9.50	1.00	43.69	74	-30.31	P	1.00
*4961.62	43.37	35.35	2.85	35.42	9.50	1.00	37.65	54	-16.35	A	1.00
*7441.92	50.04	39.72	4.10	35.58	9.50	1.00	49.79	74	-24.21	P	1.00
*7441.92	41.88	39.72	4.10	35.58	9.50	1.00	41.63	54	-12.37	A	1.00
9919.62	53.16	38.51	3.88	35.81	9.50	1.00	51.23	74	-22.77	P	1.00
9919.62	44.69	38.51	3.88	35.81	9.50	1.00	42.76	54	-11.24	A	1.00
*12404.70	-----	-----	-----	-----	10.50	2.00	-----	-----	-----	-----	1.00
14885.64	-----	-----	-----	-----	9.50	1.00	-----	-----	-----	-----	1.00
17366.58	-----	-----	-----	-----	9.50	1.00	-----	-----	-----	-----	1.00
*19847.52	-----	-----	-----	-----	9.50	1.00	-----	-----	-----	-----	1.00
*22328.46	-----	-----	-----	-----	9.50	1.00	-----	-----	-----	-----	1.00
24809.40	-----	-----	-----	-----	9.50	1.00	-----	-----	-----	-----	1.00

Note :

- The measurement was searched to 10th harmonic, Remark “---” means that the emissions level is too low to be measured.
- AF: Antenna Factor, Closs: Cable Loss, Pre-Amp: Preamplifier gain, Filter: High Pass Filter Insertion Loss (3.5GHz)
- Analyzer setting P(Peak): RBW=1MHz, VBW=1MHz, A(Average): RBW=1MHz, VBW=10Hz
- Remark “*” means that Restricted band.
- Dist : correction to extra plate reading to 3m specification distance 1m measurement distance = -9.5dB
- The result basic equation calculation is as follow:
 $Level = Reading + AF + Closs - Preamp + Filter - Dist$, $Margin = Level - Limit$
- The other emission levels were very low against the limit
- The test limit distance is 3M limit.

9.7 PHOTOS OF OPEN SITE





Ecom Sertech Corp.

Rm. 258, Bldg. 17, NO.195, Sec. 4 Chung Hsing Rd., ChuTung Chen, Hsinchu, Taiwan 310, R.O.C
TEL:886-3-5918012 FAX : 886-3-5825720

FCC ID : BDNBT4163

Report No. : ER03-08-063FRF

Page 47 of 48





10. ANTENNA REQUIREMENT

10.1 STANDARD APPLICABLE

For intentional device, according to FCC 47 CFR Section 15.203, an intentional radiator shall be designed to ensure that no antenna other than that furnished by the responsible party shall be used with the device.

And according to FCC 47 CFR Section 15.247 (b), if transmitting antennas of directional gain greater than 6dBi are used, the power shall be reduced by the amount in dB that the directional gain of the antenna exceeds 6dBi.

10.2 ANTENNA CONNECTED CONSTRUCTION

The antenna used in this product is Monopole antenna. The antenna connector is directly soldered on PCB. And the maximum Gain of this antenna is only -1dBi MAX.