

FCC ID TEST REPORT

for

Zoom Mobile Broadband Modem/Router with Wireless-N.

Model: Series 1109

FCC ID: BDN1109WL

Prepared for: Zoom Telephonics, Inc
207 South Street Boston, MA 02111, USA

Prepared by: Shenzhen TCT Testing Technology Co.,Ltd
1F, Building 1, Yibaolai Industrial Park, Qiaotou Village, Fuyong Town,
Baoan District, Shenzhen, Guangdong, China

TEL: +86-0755-27673339

FAX: +86-0755-27673332

Report Number: TCT140708055F2-1

Date of Test: Jul. 10-Jul. 24, 2014

Date of Report: Aug. 06, 2014

The results detailed in this test report relate only to the specific sample(s) tested. It is the Application's responsibility to ensure that all production units are manufactured with equivalent EMC characteristics. This report is not to be reproduced except in full, without written approval from TCT Testing Technology

Table of Contents

1.0 General Details	3
1.1 Test Lab Details	3
1.2 Applicant Details	3
1.4 Statement	4
1.5 Test Engineer	4
2.0 Test equipments and Associated Equipment used during the test.	5
2.1 Test Equipments.....	5
2.2 AE used during the test	5
3.0 Technical Details	6
3.1 Summary of test results	6
3.2 Test Standards	6
4.0 EUT Modification	6
5.0 Measurement Uncertainty (95% confidence levels, k=2)	6
6.0 Power Line Conducted Emission Test	7
7.0 Maximum Peak Output Power	11
8.0 6dB Bandwidth Measurement	13
9.0 Power Spectral Density Measurement	21
10.0 Band-edge Measurement	35
11.0 Spurious Emission Test	44
12.0 Antenna Requirement	78

1.0 General Details

1.1 Test Lab Details

Name :	Shenzhen Tongce Testing Lab
Address:	1F, Leinuo Watch Building, Fuyong Town, Baoan Dist, Shenzhen, China
Telephone:	13410377511
Fax:	--

The test facility is recognized, certified, or accredited by the following organizations:

FCC Registration Number: 572331

Shenzhen TCT Testing Technology Co., Ltd., Shenzhen EMC Laboratory: Shenzhen Tongce Testing Lab
The 3m Semi-anechoic chamber has been registered and fully described in a report with the (FCC) Federal Communications Commission. The acceptance letter from the FCC is maintained in our files.
Registration Number: 572331

Industry Canada (IC)

The 3m Semi-anechoic chamber of Shenzhen TCT Testing Technology Co., Ltd. has been registered by Certification and Engineering Bureau of Industry Canada for radio equipment testing
Registration Number IC: 10668A-1

1.2 Applicant Details

Applicant:	Zoom Telephonics, Inc
Address:	207 South Street Boston, MA 02111, USA
Telephone:	617 423-1072
Fax:	617 423-3923

Manufacturer:	MAXCOMM Co., LTD
Address:	6F1, No.120-12, Sec. 3, Zhongshan Road, Zhonghe District., 235, New Taipei City, Taiwan
Telephone:	--
Fax:	--

1.3 Description of EUT

Product:	Zoom Mobile Broadband Modem/Router with Wireless-N.
Model No.:	Series 1109
Additional Model No.:	4520, 8010
Brand Name:	ZOOM
Operation Frequency:	WCDMA2100: 1920-1980(TX) ; 2110-2170 MHz(RX) Rel-7 WCDMA 1900/GSM1900: 1850-1910(TX): 1930-1990 MHz(RX) WCDMA 850/GSM850: 824-849(TX): 869-894 MHz(RX) GSM900: 880-915(TX): 925-960 MHz(RX), GSM1800: 1710-1785(TX): 1805-1880 MHz(RX) WIFI:IEEE 802.11b: 2412-2462 MHz IEEE 802.11g: 2412-2462 MHz IEEE 802.11n: 2412-2462 MHz(HT 20), 2422-2452 MHz(HT 40)
Antenna Designation:	WIFI external antenna: 5dbi WIFI internal antenna: 2.7dbi WWAN Antenna: 5dbi
Power supply:	Adapter information: Model: SWPP-12001000-3C Input: AC 100-240V, 50/60Hz, 1.0A Output: DC 12V, 1000mA

1.4 Statement

All models above are identical in the circuit, PCB layout, internal structure, all of the housing are made of plastic material, and just the appearance are different ,different model names are different for the marketing requirement.

1.5 Test Engineer

The sample tested by



Printed name: Jack Kang

2.0 Test equipments and Associated Equipment used during the test.

2.1 Test Equipments

Instrument Type	Manufacturer	Model	Serial No.	Date of Cal.	Due Date
ESPI Test Receiver	ROHDE&SCHWARZ	ESPI 3	100379	July 2, 2014	July 1, 2015
Ultra Broadband ANT	ROHDE&SCHWARZ	HL562	100157	July 3, 2014	July 2, 2015
Power Meter	Agilent	E4416A	MY45101555	July 3, 2014	July 2, 2015
Power Sensor	Agilent	E9327A	MY44421198	July 3, 2014	July 2, 2015
System Controller	CT	SC100	-	July 3, 2014	July 2, 2015
Spectrum Analyzer	ROHDE&SCHWARZ	FSEM	848597/001	July 3, 2014	July 2, 2015
Pre-amplifier	Teseq	LAN6900	--	July 3, 2014	July 2, 2015
Pre-amplifier	Agilent	8447D	83153007374	July 3, 2014	July 2, 2015
Pre-amplifier	Agilent	8449B	3008A01738	July 3, 2014	July 2, 2015
Loop antenna	A.R.A.	PLA-1030/B	1029	July 3, 2014	July 2, 2015
Horn Antenna	ETS LINDGREN	3117	--	July 3, 2014	July 2, 2015
Horn Antenna	ETS LINDGREN	3160	--	July 3, 2014	July 2, 2015
EMI Test Receiver	R&S	ESCS30	100139	July 2, 2014	July 1, 2015
LISN	AFJ	LS16C	16010222119	July 2, 2014	July 1, 2015
Coaxial Cable	TCT	N/A	N/A	July 2, 2014	July 1, 2015
Coaxial Cable	TCT	N/A	N/A	July 2, 2014	July 1, 2015
Coaxial cable	TCT	N/A	N/A	July 2, 2014	July 1, 2015
Coaxial Cable	TCT	N/A	N/A	July 2, 2014	July 1, 2015

2.2 AE used during the test

Equipment type	Manufacturer	Model

3.0 Technical Details

3.1 Summary of test results

The EUT has been tested according to the following specifications:		
Test Item	CFR 47 Section	Result
AC Power Line Conducted Emission	15.207(a)	Complies
Maximum Peak Output Power	15.247(b)(3)	Complies
6 dB bandwidth	15.247 (a)(2)	Complies
Maximum Power Density	15.247(e)	Complies
Band age Measurement	15.247 (d), 15.205 (a), 15.209 (a)	Complies
Radiated Emission	15.209	Complies
Antenna Requirement	15.203,15.247(c)	Complies
RF Exposure	15.247(b), 1.1307(b)	Complies

3.2 Test Standards

FCC Part 15:2013 Subpart C, Paragraph 15.247

KDB 558074 D01 DTS Meas Guidance v03r02

According to ANSI C63.4 standards, the test results are both the “worst case” and “worst setup” 1Mbps for 802.11b, 6Mbps for 802.11g, 6.5Mbps for 802.11n(H20) and 13.5 Mbps for 802.11n(H40). Duty cycle setting during the transmission is 98.5% with maximum power setting for all modulations.

4.0 EUT Modification

No modification by Shenzhen TCT Testing Technology Co., Ltd.

5.0 Measurement Uncertainty (95% confidence levels, k=2)

No.	Item	MU
1.	Radio Frequency	$\pm 1 \times 10^{-9}$
2.	Temperature	$\pm 0.1^{\circ}\text{C}$
3.	Humidity	$\pm 1.0\%$
4.	RF power, conducted	$\pm 0.34\text{dB}$
5.	RF power density, conducted	$\pm 1.45\text{dB}$
6.	Spurious emissions, conducted	$\pm 3.70\text{dB}$
7.	All emissions, radiated	$\pm 4.50\text{dB}$

Note: 1) For IEEE 802.11b/g/n (HT 20): Low channel: 2412MHz, Middle channel: 2437MHz,
High channel: 2462MHz
For IEEE 802.11n (HT 40): Low channel: 2422MHz, Middle channel: 2437MHz,
High channel: 2452MHz

6.0 Power Line Conducted Emission Test

6.1 Schematics of the test

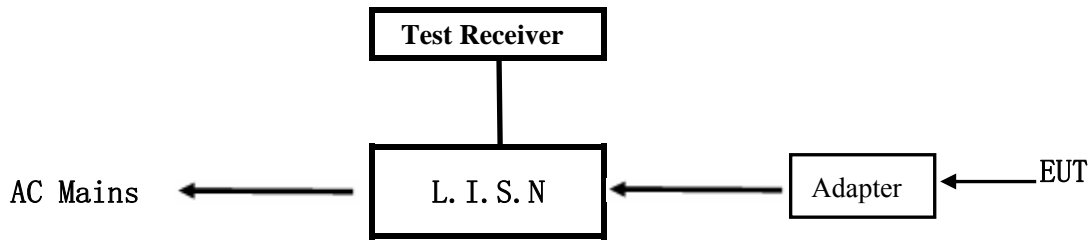

EUT: Equipment Under Test

6.2 Test Method and test Procedure

The EUT was tested according to ANSI C63.10-2009. The Frequency spectrum From 0.15MHz to 30MHz was investigated.

Test Voltage: 120V~, 60Hz EUT

Block diagram of Test setup

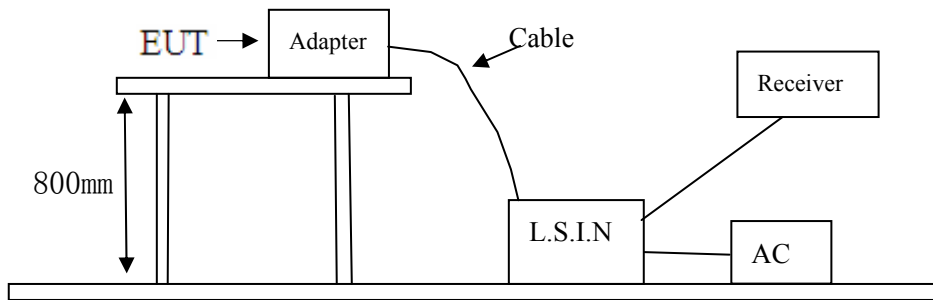

6.3 EUT Operating Condition

Operating condition is according to ANSI C63.10 -2009

- A Setup the EUT and simulators as shown on the following
- B Enable AF signal and confirm EUT active to normal condition

6.4 Test Equipment

Instrument Type	Manufacturer	Model	Serial No.	Date of Cal.	Due Date
EMI Test Receiver	R&S	ESCS30	100139	July 2, 2014	July 1, 2015
LISN	AFJ	LS16C	16010222119	July 2, 2014	July 1, 2015

6.5 Conducted Emission Limit

Frequency(MHz)	Class A Limits (dB μ V)		Class B Limits (dB μ V)	
	Quasi-peak Level	Average Level	Quasi-peak Level	Average Level
0.15 ~ 0.50	79.0	66.0	66.0~56.0*	56.0~46.0*
0.50 ~ 5.00	73.0	60.0	56.0	46.0
5.00 ~ 30.00	73.0	60.0	60.0	50.0

- Notes: 1. *Decreasing linearly with logarithm of frequency.
2. The tighter limit shall apply at the transition frequencies

6.6 Test specification:

Environmental conditions: Temperature: 23° C Humidity: 51% Atmospheric pressure: 103kPa

Frequency range: 0.15 MHz – 30 MHz

The test was carried out in the following operation mode(s):

- Tx mode

6.7 Test result

Min. limit margin >10 dB from 0.15MHz to 30MHz

The requirements are FULFILLED

Remarks: According to FCC part 15.207.

A Conducted Emission on Line Terminal of the power line (150kHz to 30MHz)

EUT Description:	Zoom Mobile Broadband Modem/Router with Wireless-N.
Operation Mode:	Tx mode
Tested By:	SKY
Test date:	July 18, 2014

Start Frequency	Stop Frequency	Step	IF BW	Detector	Final M-Time
0.15MHz	30MHz	4.5KHz	10KHz	QP+AVG	1s

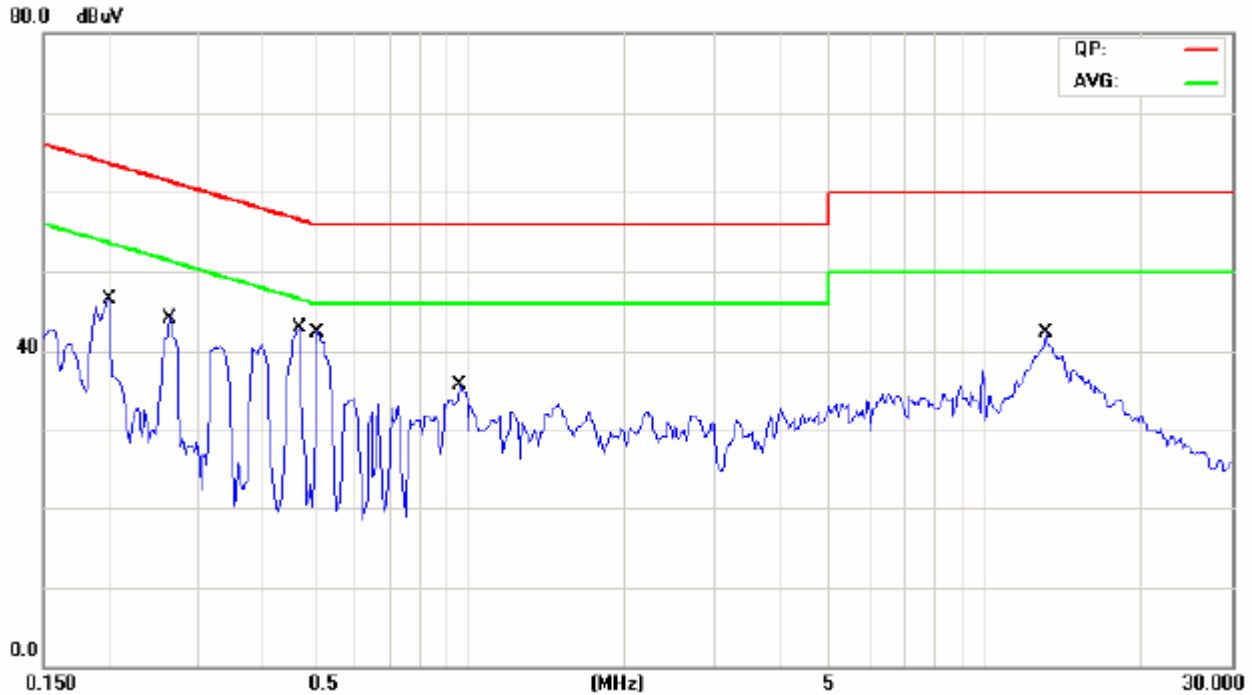

No.	Mk.	Freq. MHz	Reading Level dBuV	Correct Factor dB	Measure- ment dBuV	Limit dBuV	Over dB	Detector	Comment
1		0.2008	33.47	10.32	43.79	63.57	-19.78	QP	
2		0.2008	22.68	10.32	33.00	53.57	-20.57	AVG	
3		0.2633	27.11	10.41	37.52	61.32	-23.80	QP	
4		0.2633	17.05	10.41	27.46	51.32	-23.86	AVG	
5		0.4703	30.17	10.34	40.51	56.51	-16.00	QP	
6		0.4703	17.28	10.34	27.62	46.51	-18.89	AVG	
7	*	0.5094	30.78	10.45	41.23	56.00	-14.77	QP	
8		0.5094	18.15	10.45	28.60	46.00	-17.40	AVG	
9		0.9586	22.66	10.56	33.22	56.00	-22.78	QP	
10		0.9586	8.83	10.56	19.39	46.00	-26.61	AVG	
11		13.0859	24.82	10.97	35.79	60.00	-24.21	QP	
12		13.0859	13.46	10.97	24.43	50.00	-25.57	AVG	

B Conducted Emission on Neutral Terminal of the power line (150kHz to 30MHz)

EUT Description:	Zoom Mobile Broadband Modem/Router with Wireless-N.
Operation Mode:	Tx mode
Tested By:	SKY
Test Date:	July 18, 2014

Start Frequency	Stop Frequency	Step	IF BW	Detector	Final M-Time
0.15MHz	30MHz	4.5KHz	10KHz	QP+AVG	1s

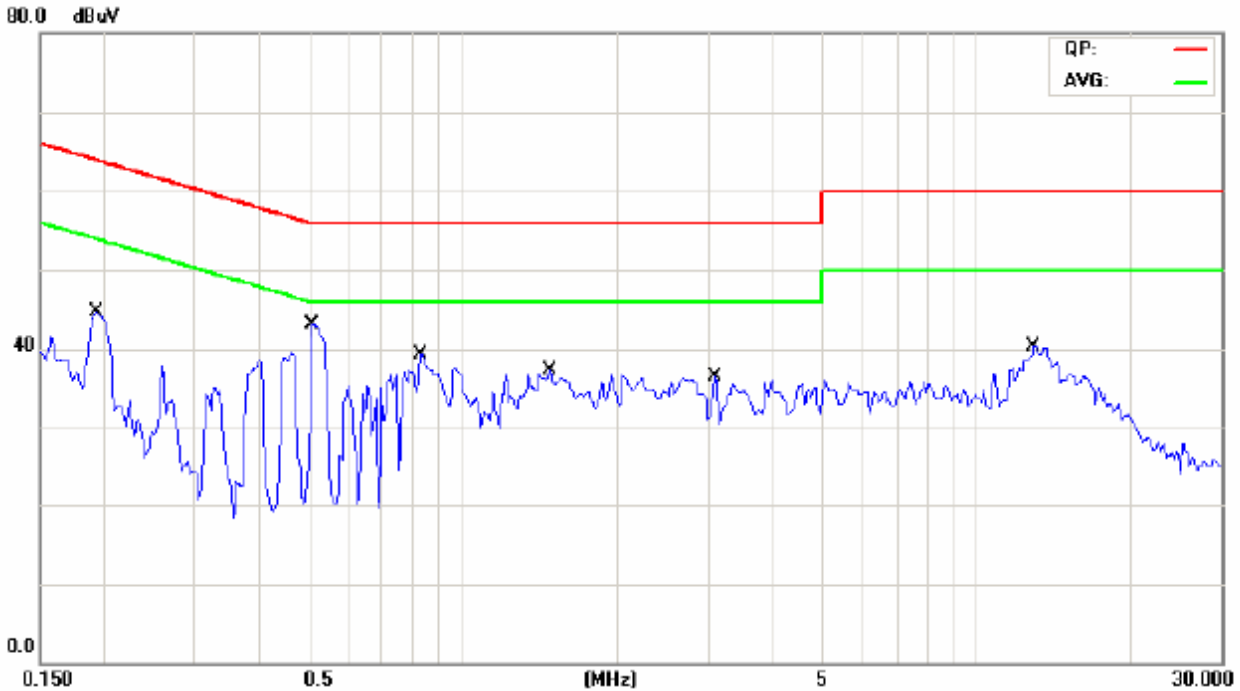

No.	Mk.	Freq.	Reading Level	Correct Factor	Measurement	Limit	Over	Detector	Comment
		MHz	dBuV	dB	dBuV	dBuV	dB		
1		0.1930	31.59	10.38	41.97	63.90	-21.93	QP	
2		0.1930	16.36	10.38	26.74	53.90	-27.16	AVG	
3	*	0.5094	31.42	10.45	41.87	56.00	-14.13	QP	
4		0.5094	19.32	10.45	29.77	46.00	-16.23	AVG	
5		0.8297	26.99	10.46	37.45	56.00	-18.55	QP	
6		0.8297	13.23	10.46	23.69	46.00	-22.31	AVG	
7		1.4742	23.73	10.65	34.38	56.00	-21.62	QP	
8		1.4742	11.01	10.65	21.66	46.00	-24.34	AVG	
9		3.0977	18.50	10.45	28.95	56.00	-27.05	QP	
10		3.0977	3.74	10.45	14.19	46.00	-31.81	AVG	
11		12.9219	26.20	11.00	37.20	60.00	-22.80	QP	
12		12.9219	14.99	11.00	25.99	50.00	-24.01	AVG	

7.0 Maximum Peak Output Power

7.1 Test Setup

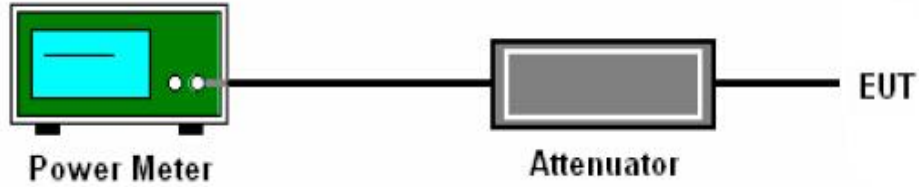

7.2 Limits of Maximum Peak Output Power

The Maximum Peak Output Power Measurement is 30dBm.

7.3 Test Procedure

1. The testing follows FCC KDB Publication NO558074 (Measurement Guidance of DTS)
2. The RF output of EUT was connected to the power meter by a low loss cable
3. Measure the power by power meter

7.4 Test Equipment:

Instrument Type	Manufacturer	Model	Serial No.	Date of Cal.	Due Date
Power Meter	Agilent	E4416A	MY45101555	July 3, 2014	July 2, 2015
Power Sensor	Agilent	E9327A	MY44421198	July 3, 2014	July 2, 2015

7.5 Test Result

Configuration IEEE 802.11b/ Antenna 1+Antenna 2

Test channel	Conducted Power (dBm)			Limit (dBm)	Result
	Antenna 1	Antenna 2	Total		
Lowest	18.79	17.57	21.23	30	Pass
Middle	19.14	17.31	21.33	30	Pass
Highest	19.18	17.44	21.41	30	Pass

Configuration IEEE 802.11g/ Antenna 1+Antenna 2

Test channel	Conducted Power (dBm)			Limit (dBm)	Result
	Antenna 1	Antenna 2	Total		
Lowest	16.42	13.24	18.13	30	Pass
Middle	16.92	13.43	18.53	30	Pass
Highest	16.77	13.03	18.30	30	Pass

Configuration IEEE 802.11n/ Antenna 1+Antenna 2

Test channel	Conducted Power (dBm)			Limit (dBm)	Result
	Antenna 1	Antenna 2	Total		
Lowest	16.71	13.73	18.48	30	Pass
Middle	16.92	13.38	18.51	30	Pass
Highest	16.84	13.26	18.42	30	Pass

Configuration IEEE 802.11n(40MHz)/ Antenna 1+Antenna 2

Test channel	Conducted Power (dBm)			Limit (dBm)	Result
	Antenna 1	Antenna 2	Total		
Lowest	16.97	13.32	18.53	30	Pass
Middle	17.01	13.66	18.66	30	Pass
Highest	16.96	13.30	18.51	30	Pass

8.0 6dB Bandwidth Measurement

8.1 Test Setup

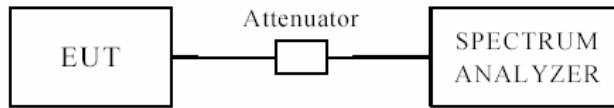

8.2 Limits of 6dB Bandwidth Measurement

The minimum of 6 dB Bandwidth is >500 kHz

8.3 Test Procedure

According to KDB 558074 D01 DTS Meas Guidance v03r02, the transmitter output was connected to the spectrum analyzer through an attenuator. The spectrum analyzer is setting as follows: RBW=100 kHz, VBW=300 kHz, Detector=Peak, Trace mode=max hold, Sweep=auto couple. The 6dB bandwidth is defined as the two outermost amplitude points (upper and lower) that are attenuated by 6 dB relative to the maximum level measured in the fundamental emission.

8.4 Test Equipment:

Instrument Type	Manufacturer	Model	Serial No.	Date of Cal.	Due Date
Spectrum Analyzer	ROHDE&SCHWARZ	FSEM	848597/001	July 3, 2014	July 2, 2015

8.5 Test Result

Antenna 1:

IEEE 802.11b mode			
Test channel	6 dB occupied bandwidth (MHz)	Limit (kHz)	Result
Lowest	12.0673	500	Pass
Middle	12.1154	500	Pass
Highest	12.1154	500	Pass
IEEE 802.11g mode			
Test channel	6 dB occupied bandwidth (MHz)	Limit (kHz)	Result
Lowest	16.3462	500	Pass
Middle	16.2981	500	Pass
Highest	16.2981	500	Pass
IEEE 802.11n(HT 20) mode			
Test channel	6 dB occupied bandwidth (MHz)	Limit (kHz)	Result
Lowest	16.8269	500	Pass
Middle	16.2981	500	Pass
Highest	16.2019	500	Pass
IEEE 802.11n(HT 40) mode			
Test channel	6 dB occupied bandwidth (MHz)	Limit (kHz)	Result
Lowest	35.0962	500	Pass
Middle	35.0962	500	Pass
Highest	35.1763	500	Pass

Note: Measurements were conducted in antenna 1 and antenna 2 and the worst case (antenna1)was submitted only.

Test plot :

Antenna 1

Test Mode: IEEE 802.11b mode

Low channel

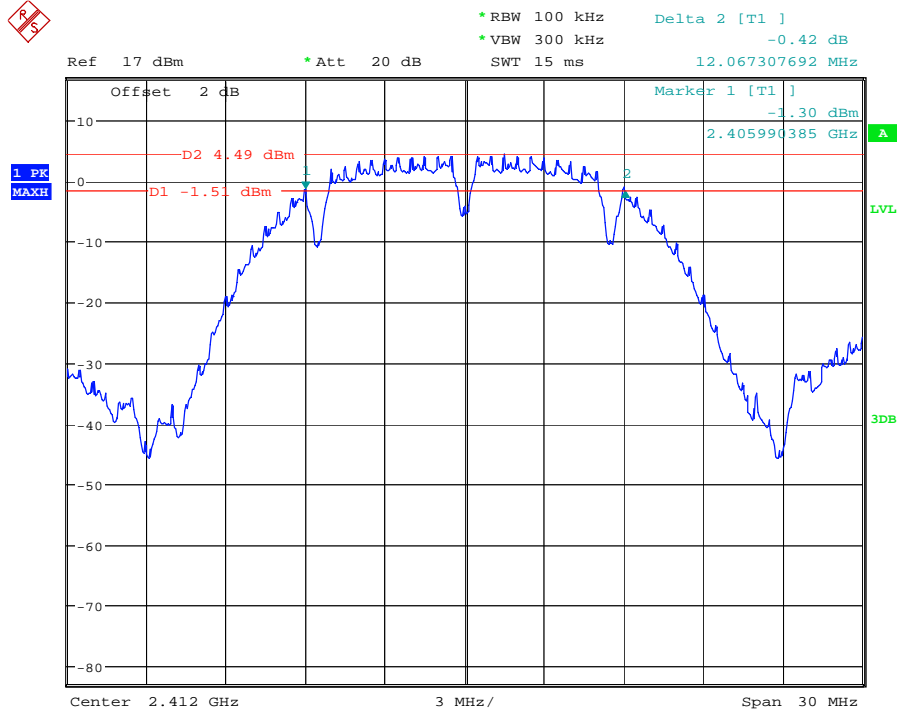

Middle channel

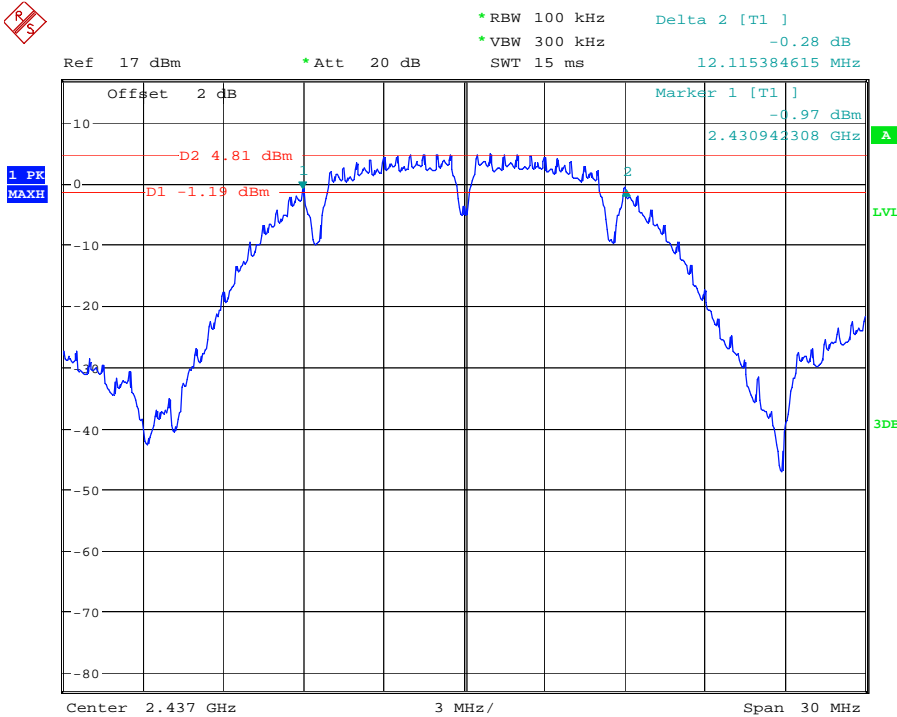

High channel

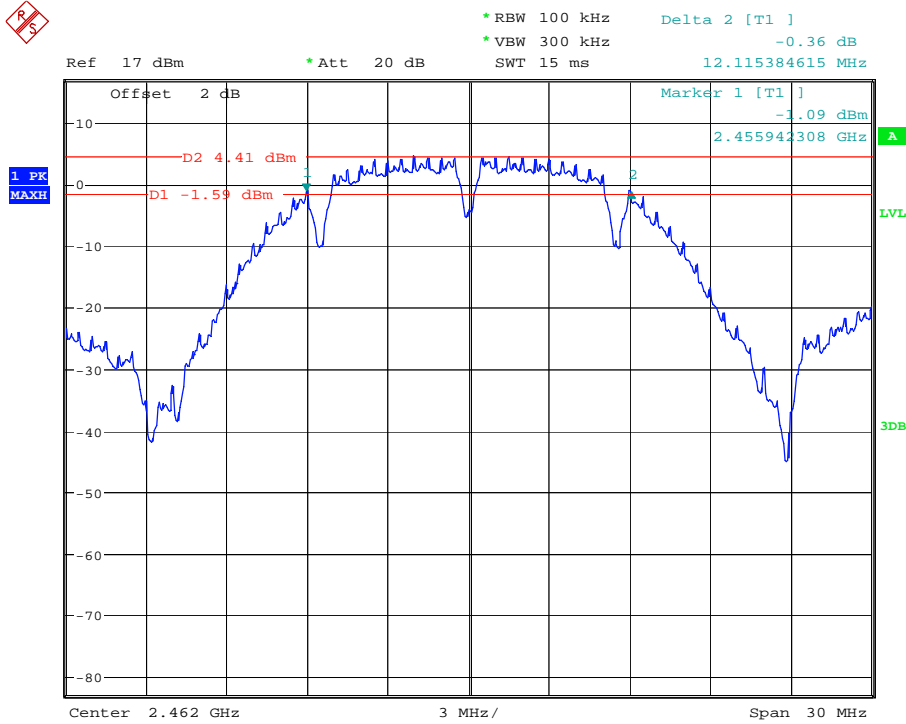

Test Mode: IEEE 802.11g mode

Low channel

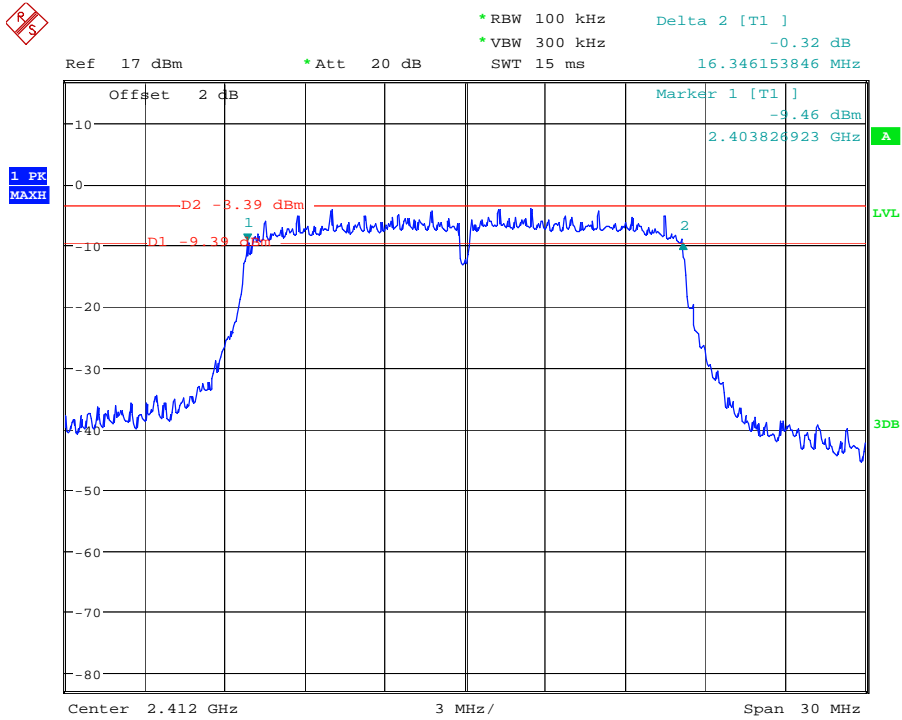

Middle channel

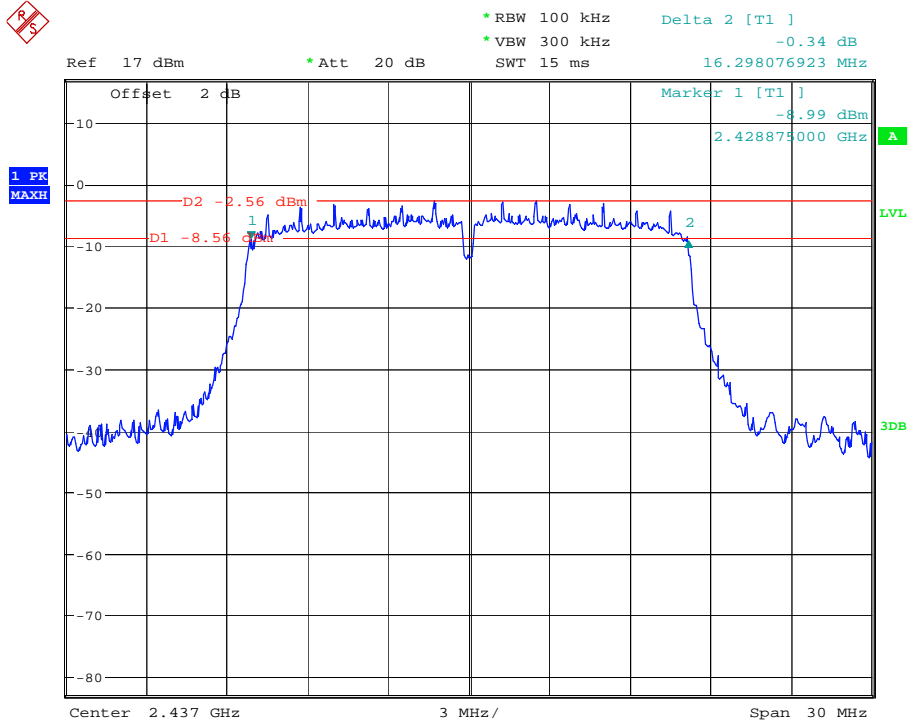

High channel

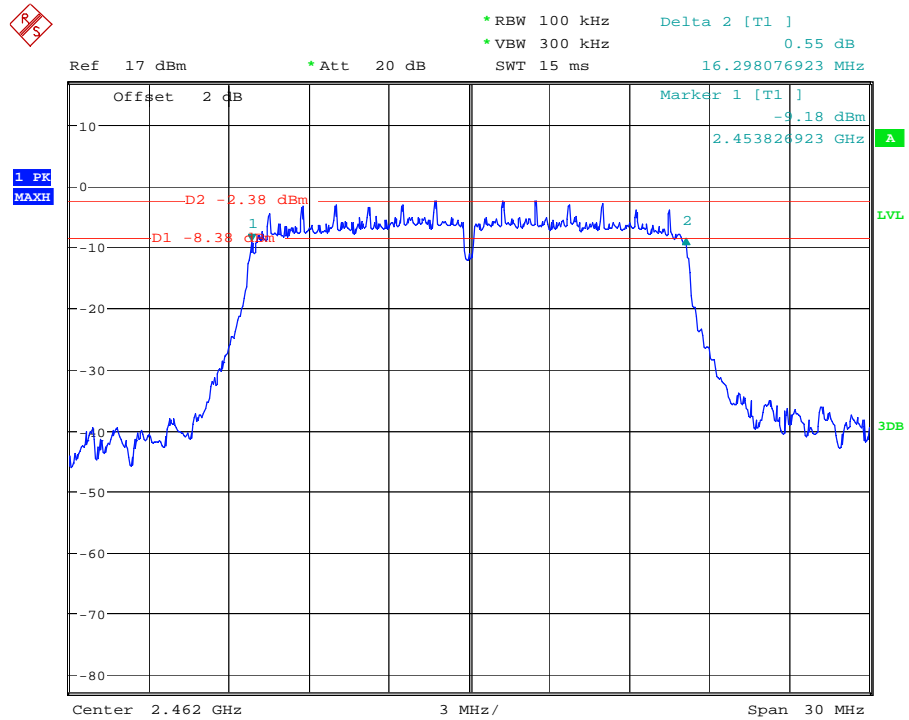

Test Mode: IEEE 802.11n (HT 20) mode

Low channel

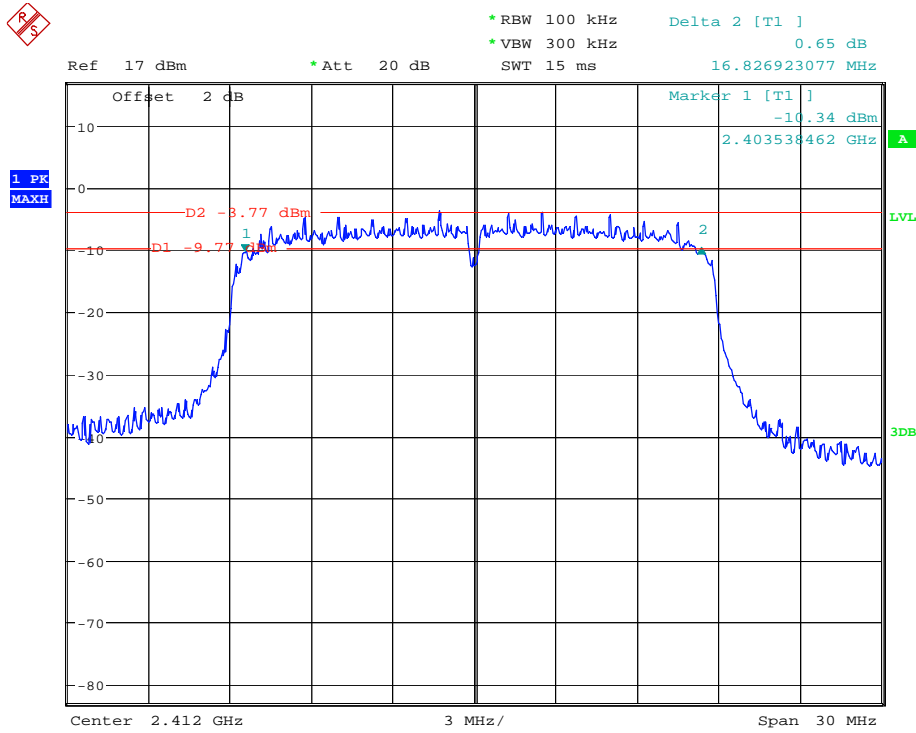

Middle channel

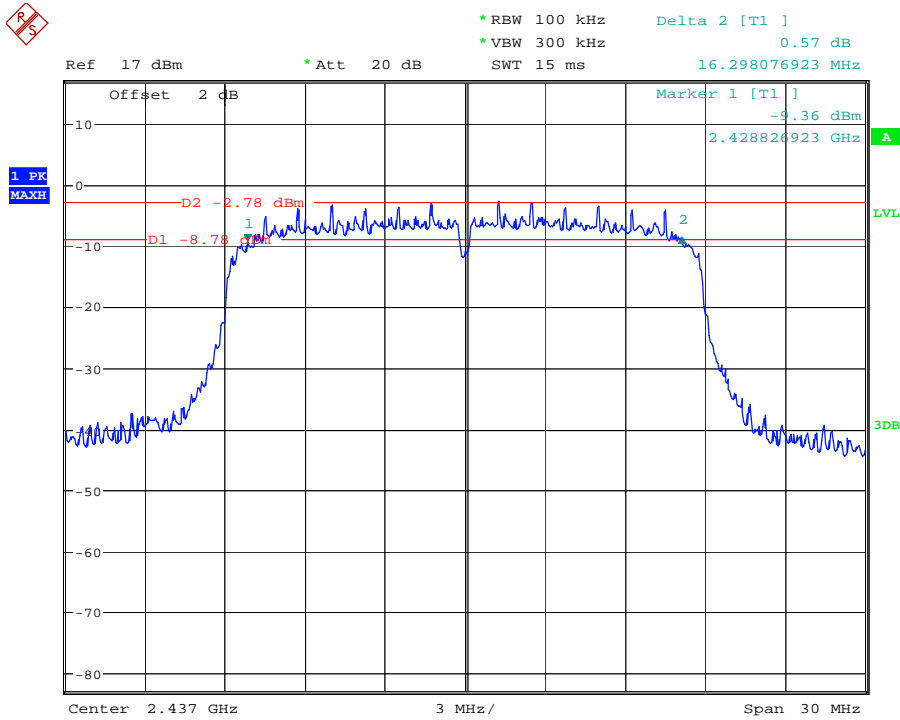

High channel

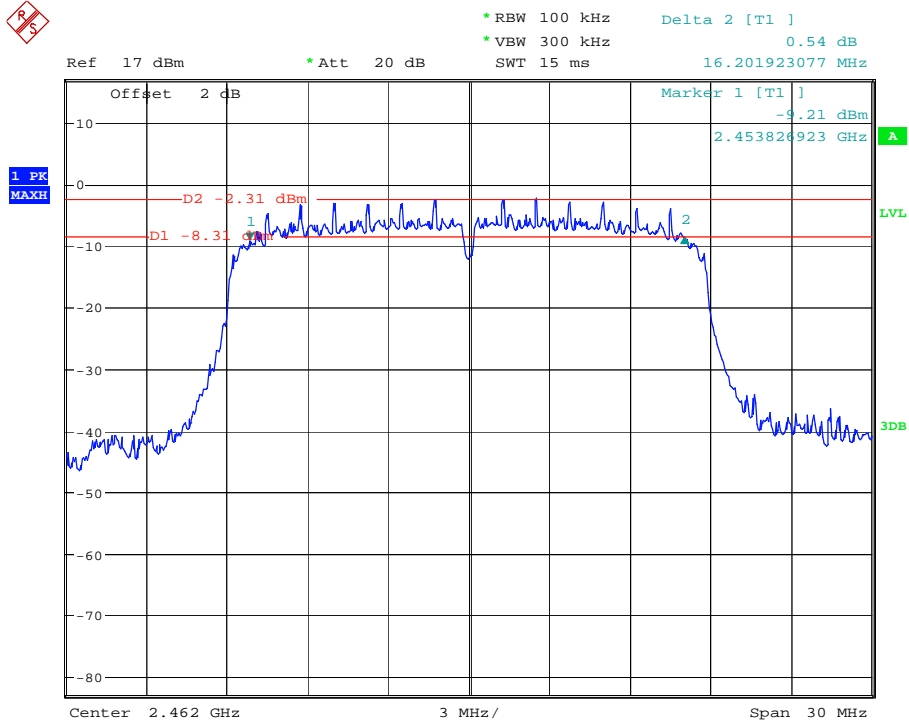

Test Mode: IEEE 802.11n(HT 40) mode

Low channel

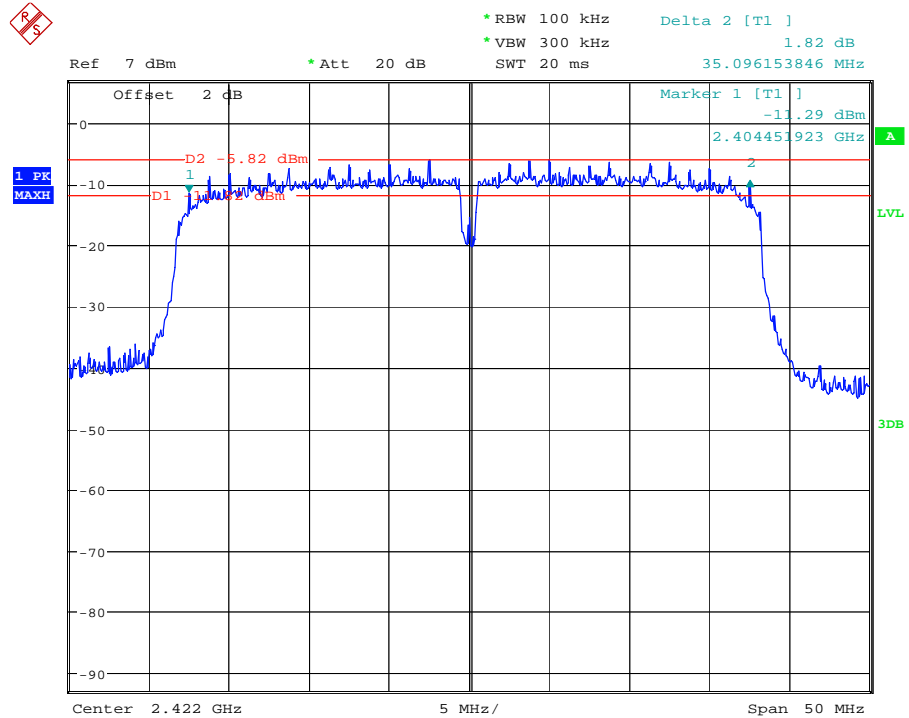

Middle channel

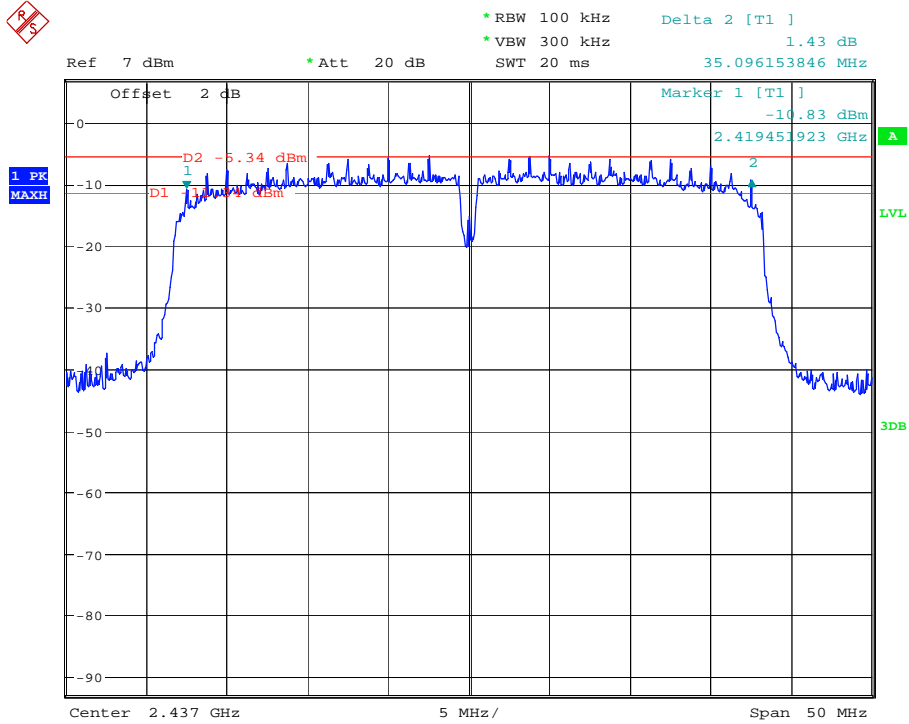

High channel

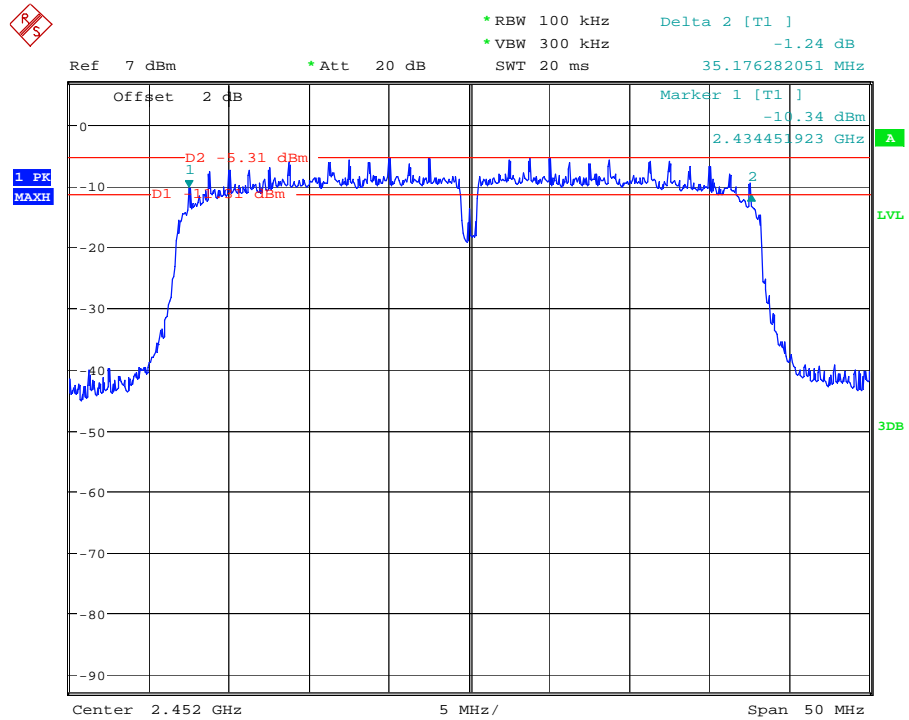

9.0 Power Spectral Density Measurement

9.1 Test Setup

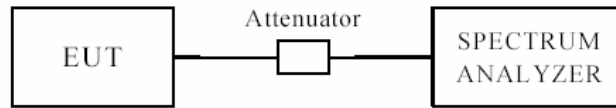

9.2 Limits of Power Spectral Density Measurement

The Maximum Power Spectral Density is 8 dBm in any 3 kHz.

9.3 Test Procedure

According to KDB 558074 D01 DTS Meas Guidance v03r02, the transmitter output was connected to the spectrum analyzer through an attenuator.

The spectrum analyzer is setting as follows:

- a) Set analyzer center frequency to DTS channel center frequency.
- b) Set the span to 1.5 times the *DTS bandwidth*.
- c) Set the RBW to: $3 \text{ kHz} \leq \text{RBW} \leq 100 \text{ kHz}$.
- d) Set the VBW $\geq 3 \times \text{RBW}$.
- e) Detector = peak.
- f) Sweep time = auto couple.
- g) Trace mode = max hold.
- h) Allow trace to fully stabilize.
- i) Use the peak marker function to determine the maximum amplitude level within the RBW.
- j) If measured value exceeds limit, reduce RBW (no less than 3 kHz) and repeat.

9.4 Test Equipment:

Instrument Type	Manufacturer	Model	Serial No.	Date of Cal.	Due Date
Spectrum Analyzer	ROHDE&SCHWARZ	FSEM	848597/001	July 3, 2014	July 2, 2015

9.5 Test Result

Configuration IEEE 802.11b/ Antenna 1+Antenna 2

Test channel	Peak Power Spectral Density (dBm)			Limit (dBm)	Result
	Antenna 1	Antenna 2	Total		
Lowest	-11.84	-13.68	-9.65	8	Pass
Middle	-11.66	-16.26	-10.37	8	Pass
Highest	-11.66	-15.80	-10.24	8	Pass

Configuration IEEE 802.11g/ Antenna 1+Antenna 2

Test channel	Peak Power Spectral Density (dBm)			Limit (dBm)	Result
	Antenna 1	Antenna 2	Total		
Lowest	-19.60	-20.52	-17.03	8	Pass
Middle	-18.49	-20.43	-16.34	8	Pass
Highest	-18.18	-21.04	-16.37	8	Pass

Configuration IEEE 802.11n/ Antenna 1+Antenna 2

Test channel	Peak Power Spectral Density (dBm)			Limit (dBm)	Result
	Antenna 1	Antenna 2	Total		
Lowest	-19.79	-20.03	-16.90	8	Pass
Middle	-18.47	-19.31	-15.86	8	Pass
Highest	-18.04	-20.43	-16.06	8	Pass

Configuration IEEE 802.11n(40MHz)/ Antenna 1+Antenna 2

Test channel	Peak Power Spectral Density (dBm)			Limit (dBm)	Result
	Antenna 1	Antenna 2	Total		
Lowest	-21.37	-23.70	-19.37	8	Pass
Middle	-20.27	-23.34	-18.53	8	Pass
Highest	-20.22	-23.51	-18.55	8	Pass

Test plots:

Antenna 1

Test Mode: IEEE 802.11b mode

Low channel

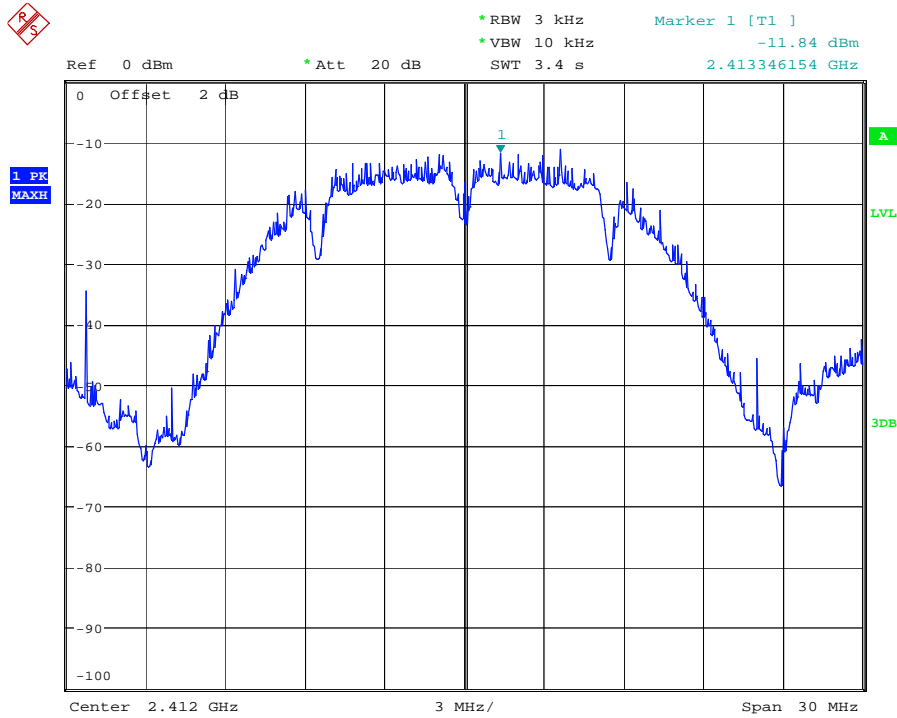

Middle channel

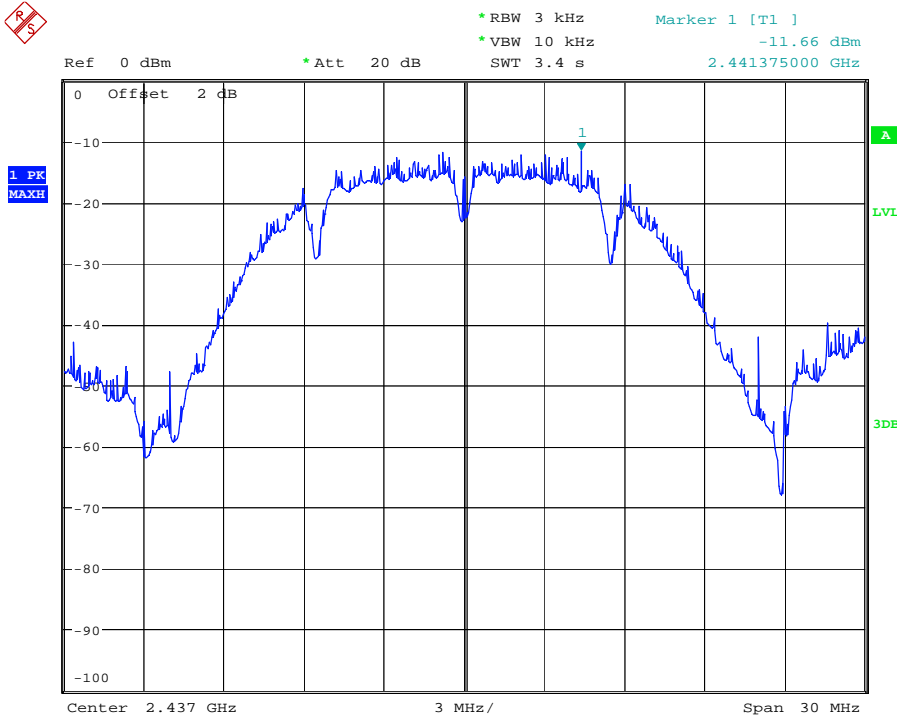

High channel

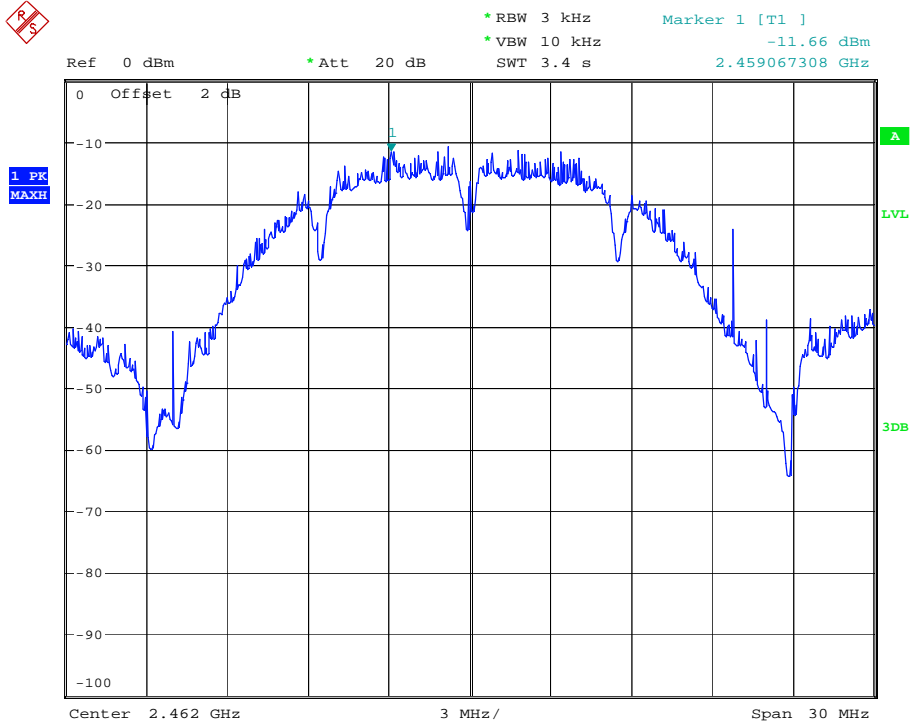

Test Mode: IEEE 802.11g mode

Low channel

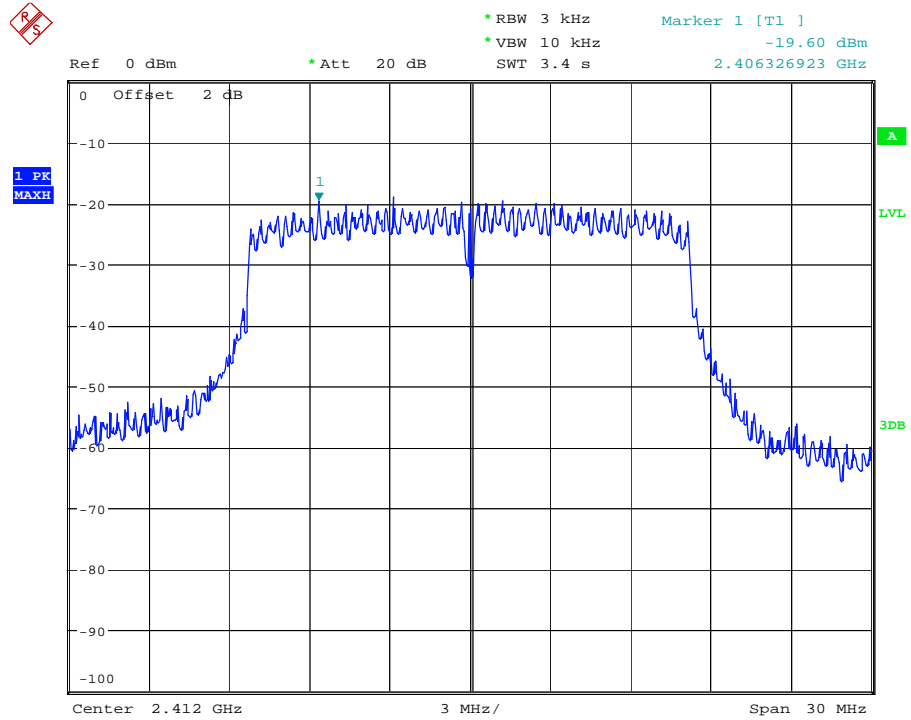

Test Mode: IEEE 802.11n (HT 20) mode

Low channel

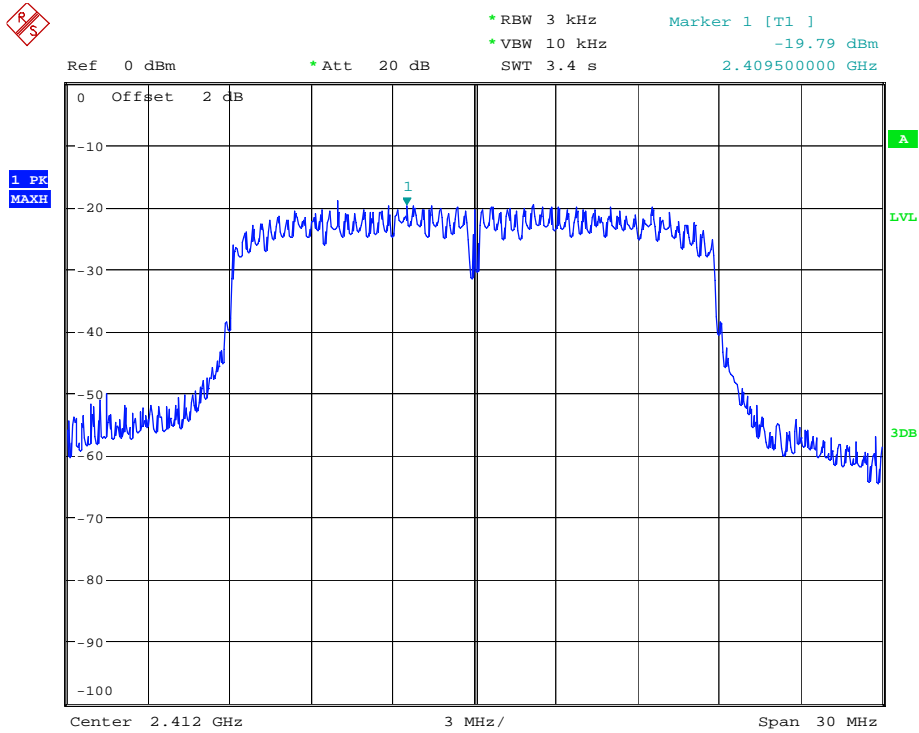

Middle channel

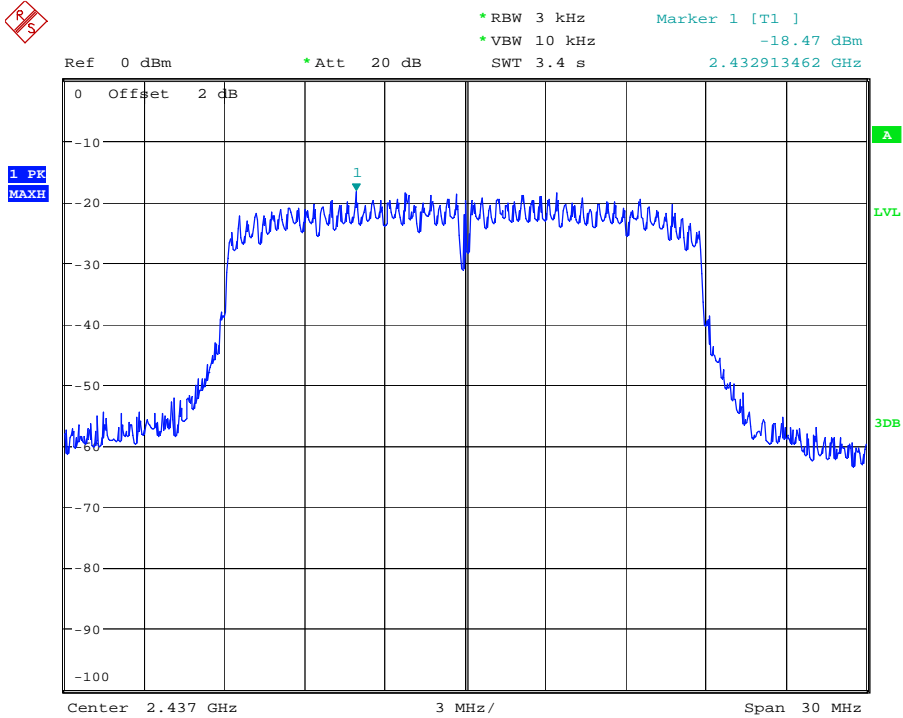

High channel

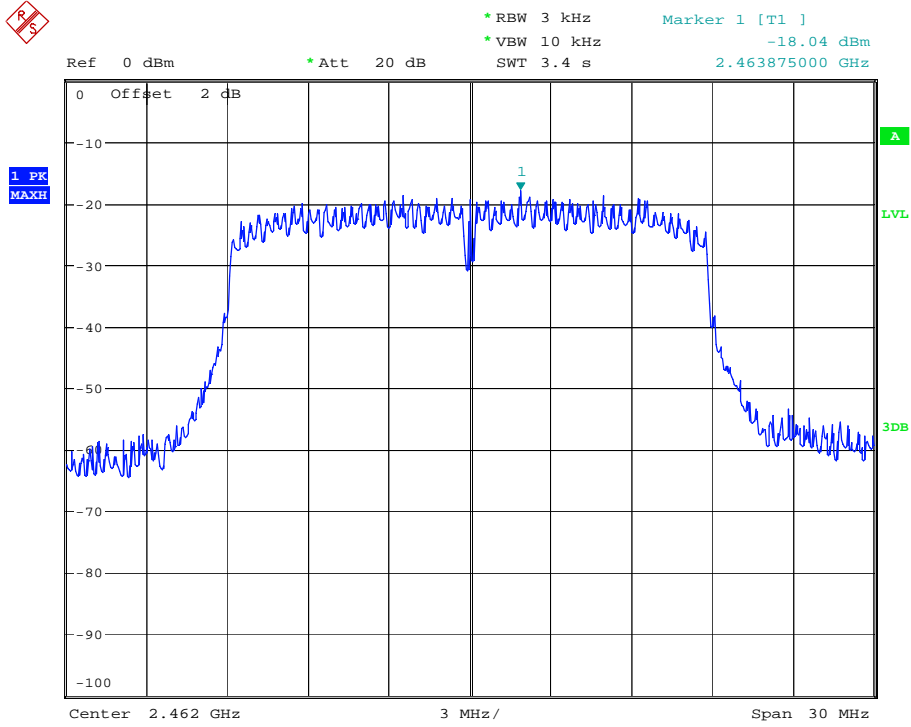

Test Mode: IEEE 802.11n(HT 40) mode

Low channel

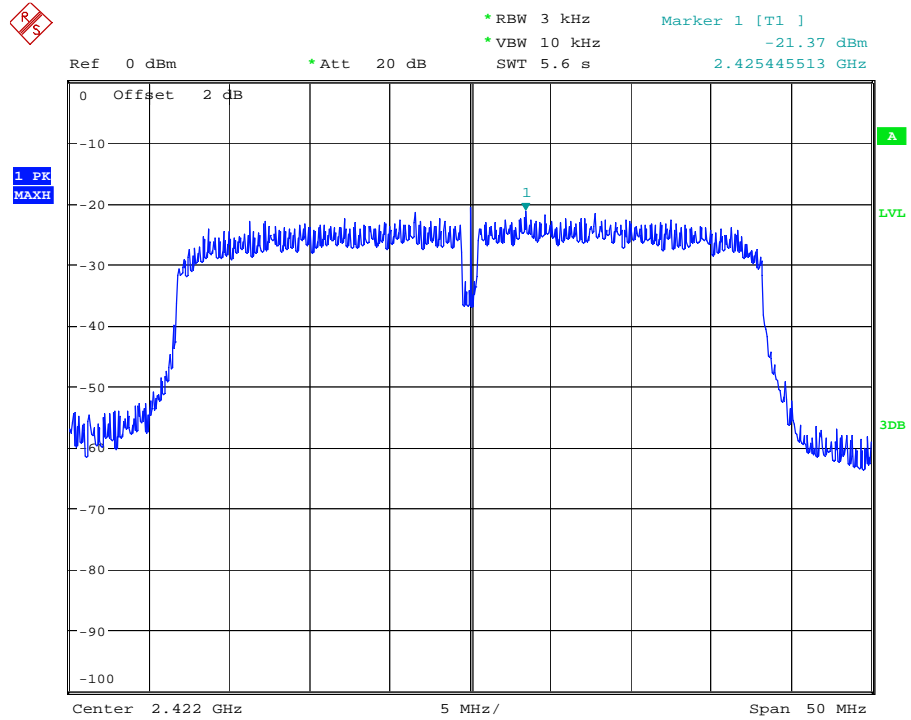

Test plots:

Antenna 2

Test Mode: IEEE 802.11b mode

Low channel

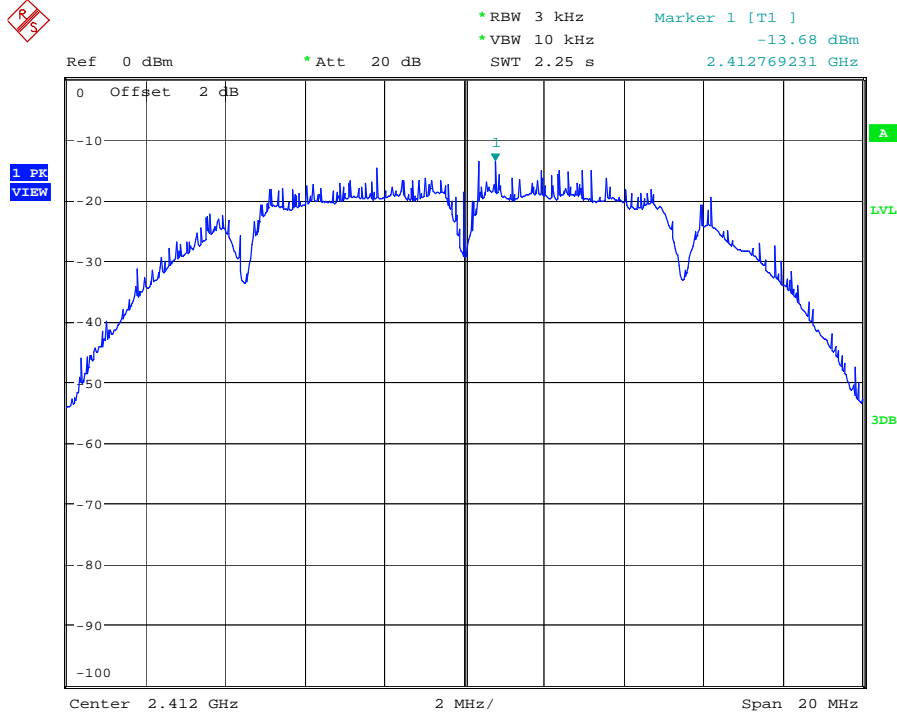

Middle channel

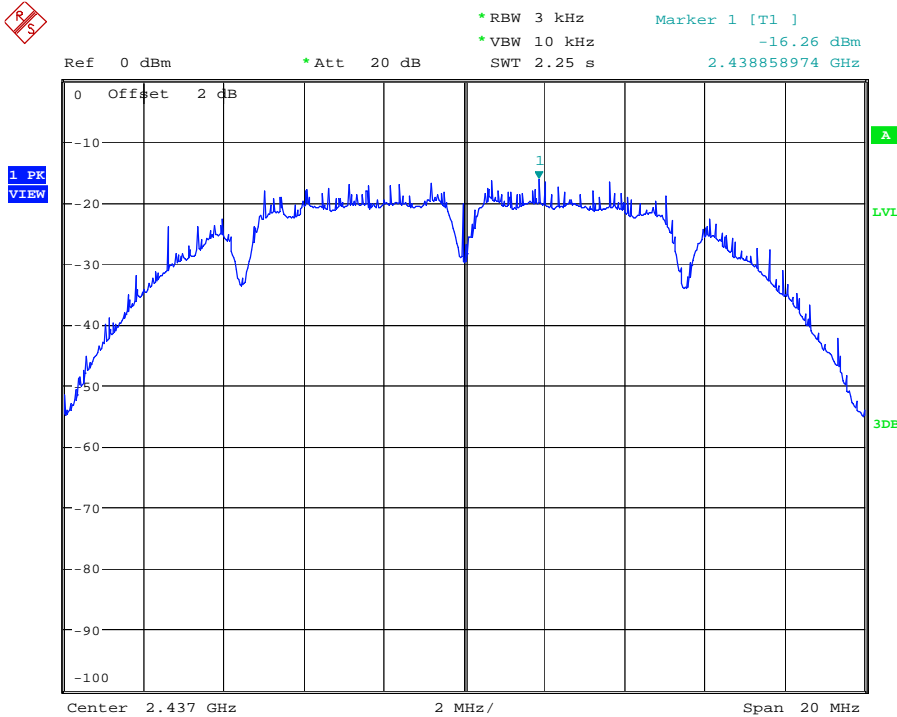

High channel

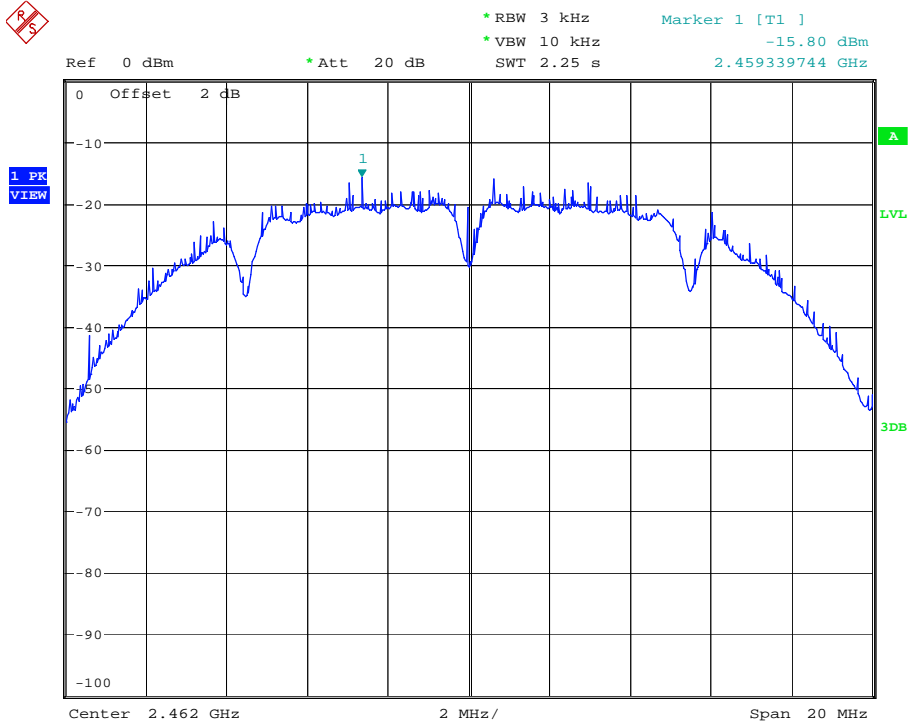

Test Mode: IEEE 802.11g mode

Low channel

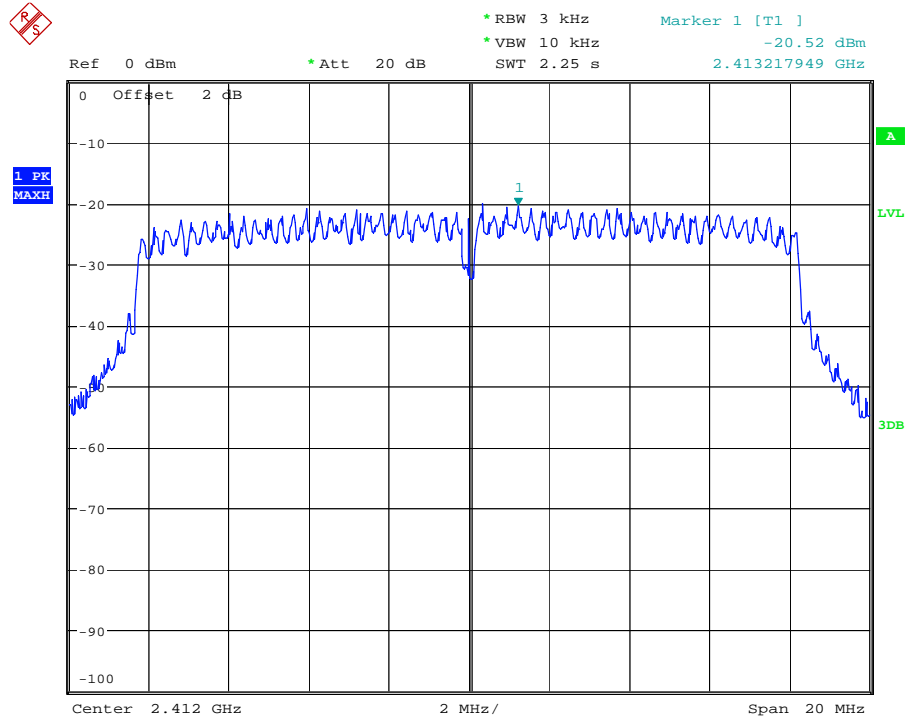

Middle channel

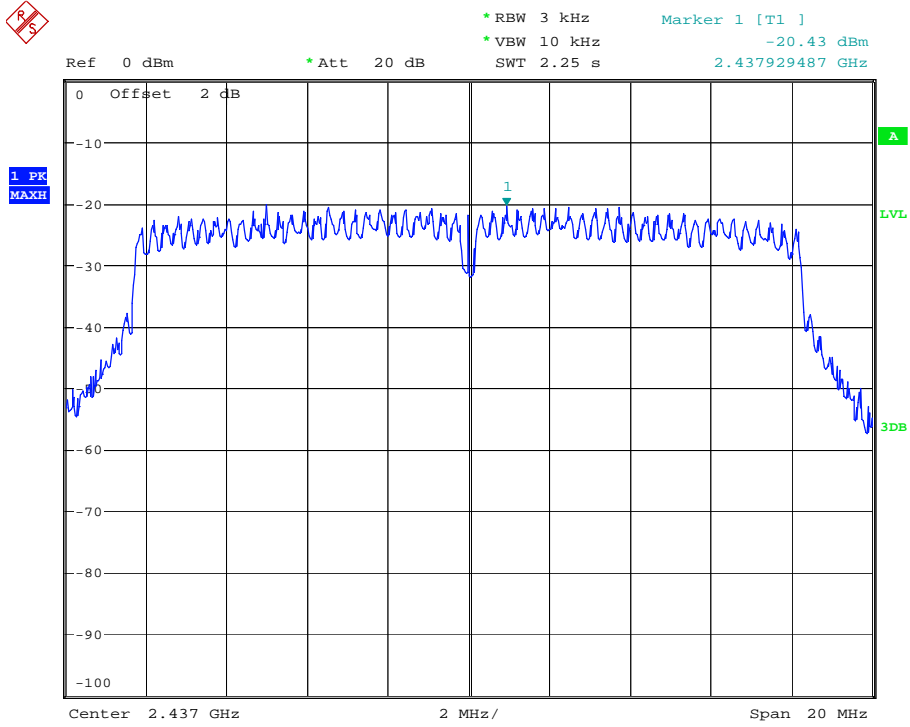

High channel

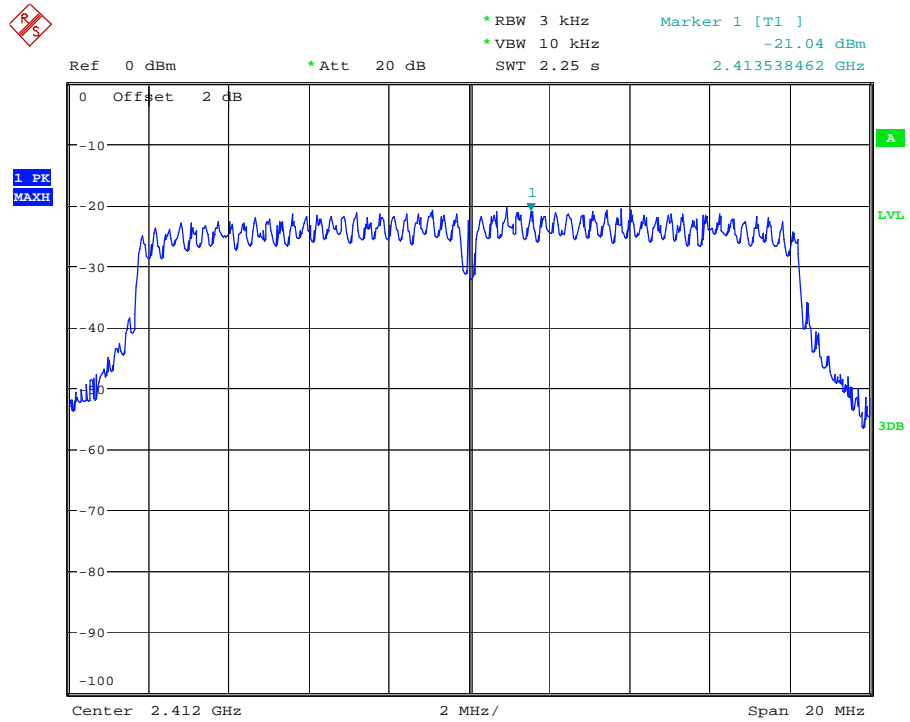

Test Mode: IEEE 802.11n (HT 20) mode

Low channel

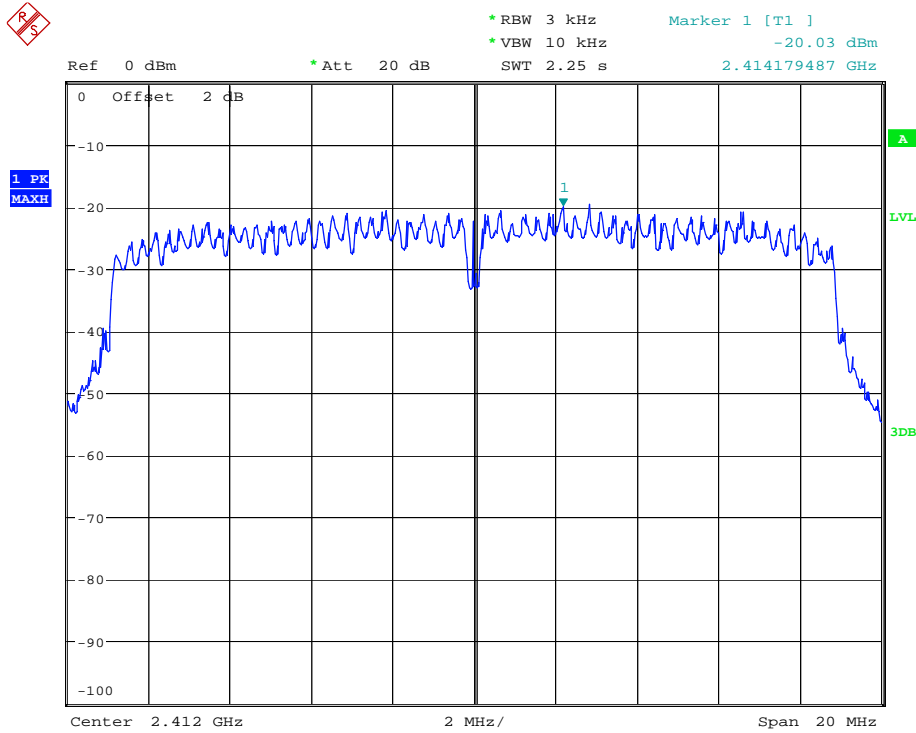

Middle channel

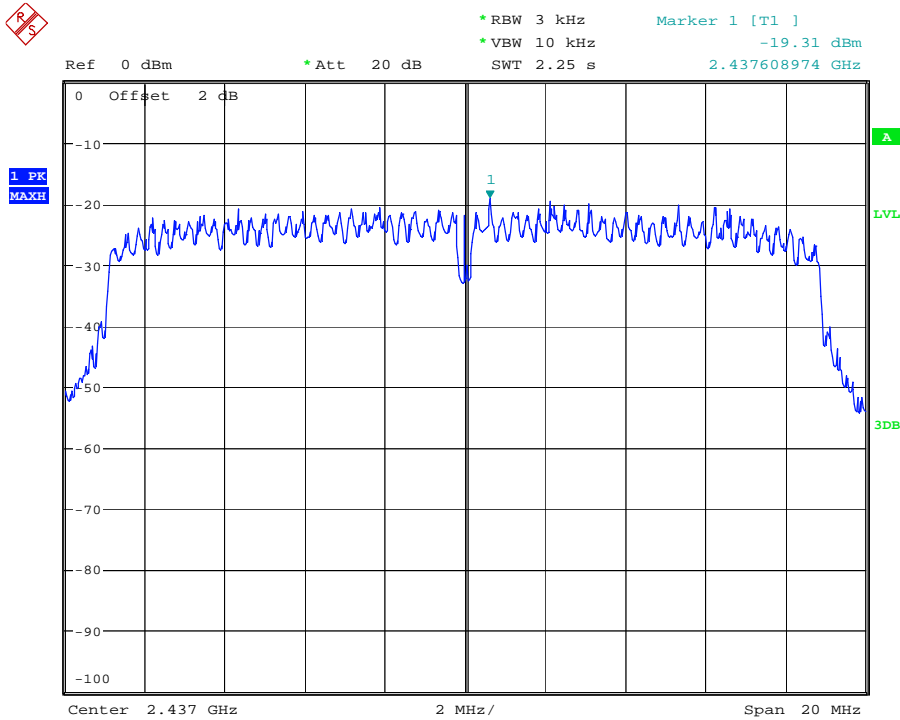

High channel

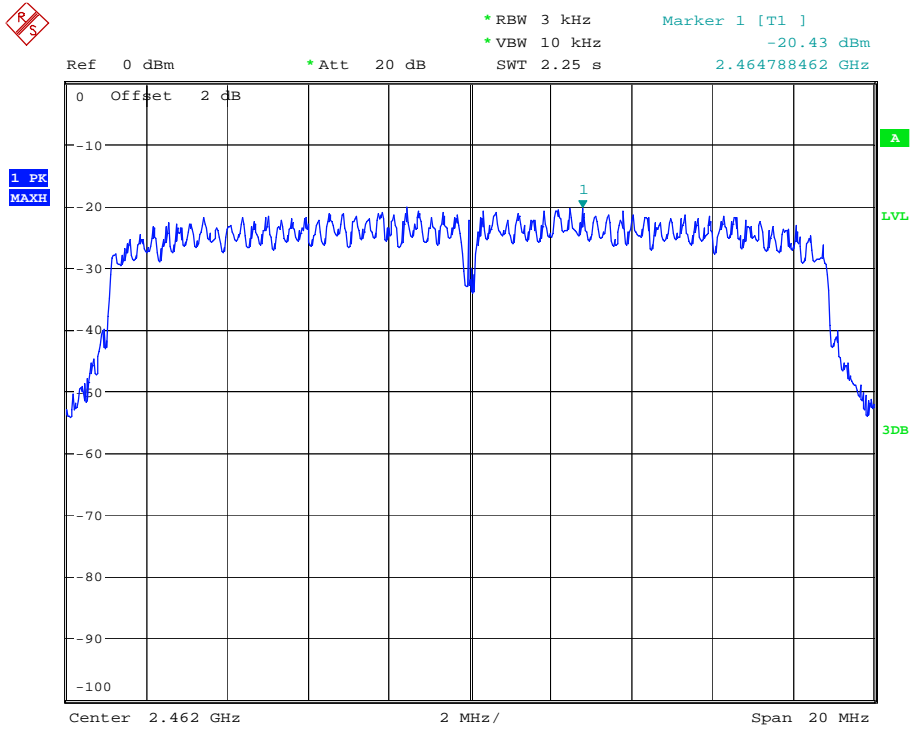

Test Mode: IEEE 802.11n(HT 40) mode

Low channel

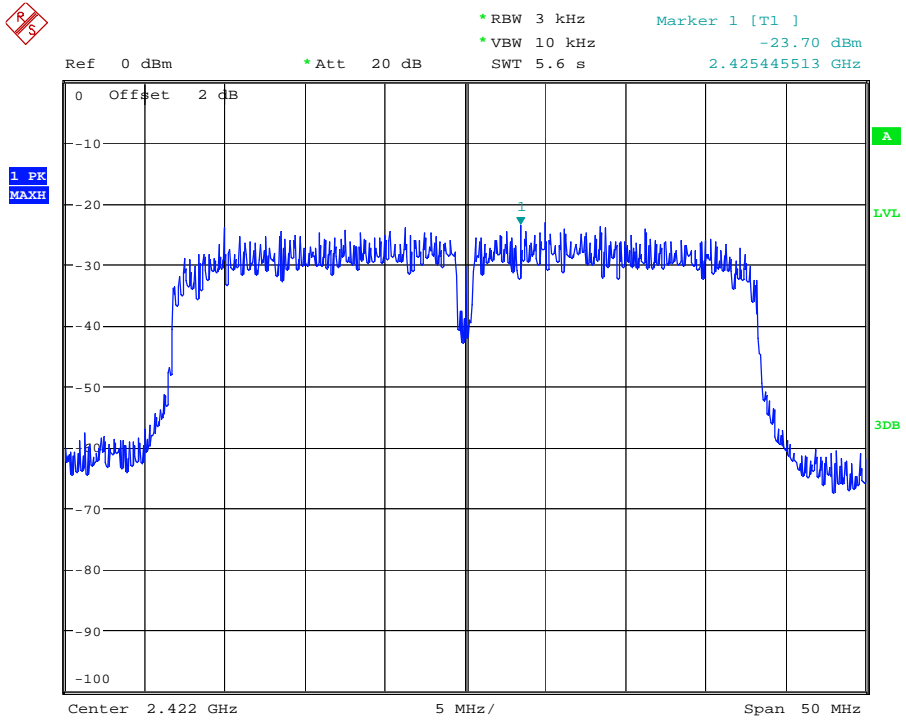

10.0 Band-edge Measurement

10.1 Test Equipment

Instrument Type	Manufacturer	Model	Serial No.	Date of Cal.	Due Date
Spectrum Analyzer	ROHDE&SCHWARZ	FSEM	848597/001	July 3, 2014	July 2, 2015
Pre-amplifier	Agilent	8449B	3008A01738	July 2, 2014	July 1, 2015
Horn Antenna	ETS LINDGREN	3117	--	July 1, 2014	July 1, 2015

10.2 Test specification:

Environmental conditions: Temperature 22° C Humidity: 50% Atmospheric pressure: 103kPa

10.3 Limit:

Radiated emissions which fall in the restricted bands, as defined in section 15.205(a), must also comply with The radiated emission limits specified in 15.209(a)

The DTS rules specify that in any 100 kHz bandwidth outside of the authorized frequency band, the power shall be attenuated according to the following conditions:

- a) If the maximum peak conducted output power procedure was used to demonstrate compliance as described in 9.1, then the peak output power measured in any 100 kHz bandwidth outside of the authorized frequency band shall be attenuated by at least 20 dB relative to the maximum in-band peak PSD level in 100 kHz (*i.e.*, 20 dBc).
- b) If maximum conducted (average) output power was used to demonstrate compliance as described in 9.2, then the peak power in any 100 kHz bandwidth outside of the authorized frequency band shall be attenuated by at least 30 dB relative to the maximum in-band peak PSD level in 100 kHz (*i.e.*, 30 dBc).
- c) In either case, attenuation to levels below the 15.209 general radiated emissions limits is not required.

10.4 Test Procedure

- a) Set the center frequency and span to encompass frequency range to be measured.
- b) Set the RBW = 100 kHz.
- c) Set the VBW $\geq 3 \times$ RBW.
- d) Detector = peak.
- e) Sweep time = auto couple.
- f) Trace mode = max hold.
- g) Allow trace to fully stabilize.
- h) Use the peak marker function to determine the maximum amplitude level.

10.5 Test Result:

Conducted Emission Method

Test plots:

Test Mode: IEEE 802.11b mode

Low channel

Antenna 1

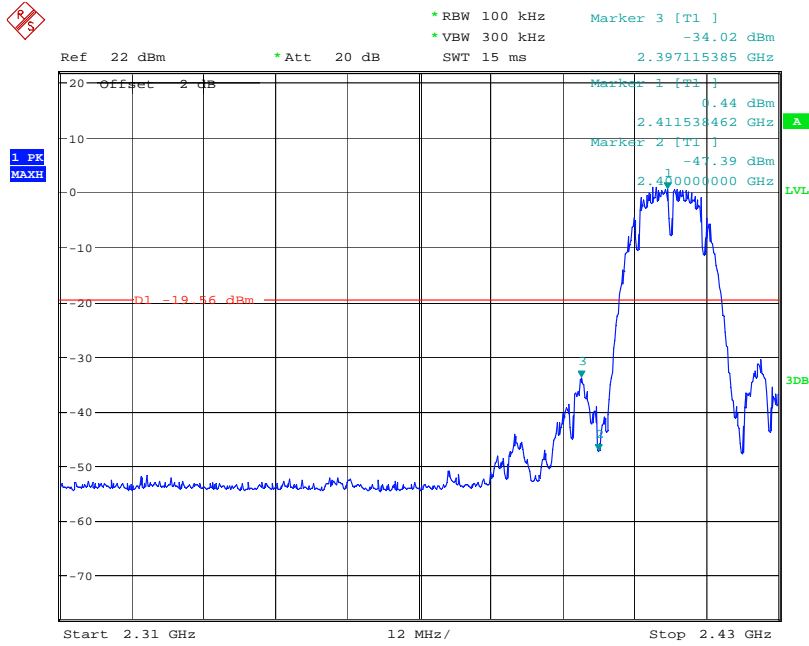

Antenna 2

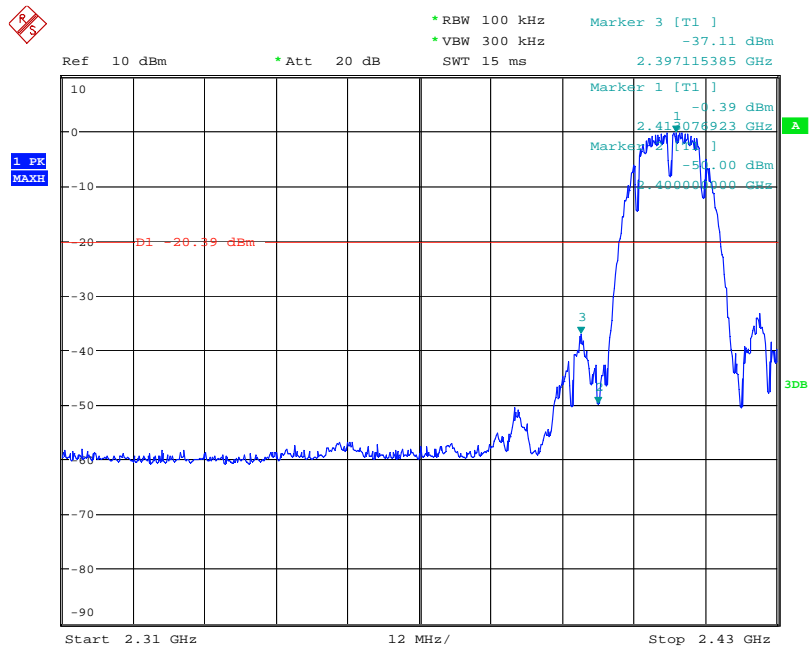

High channel Antenna 1

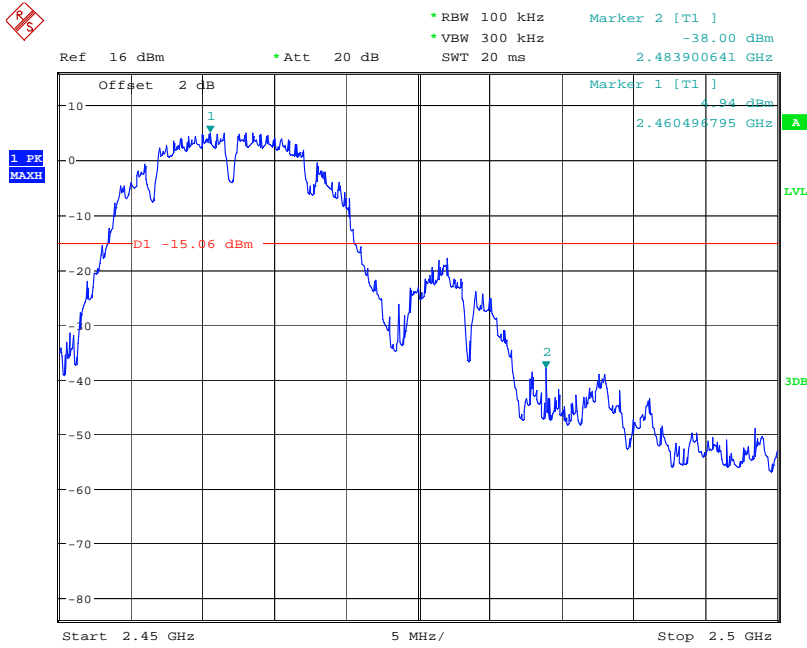

Antenna 2

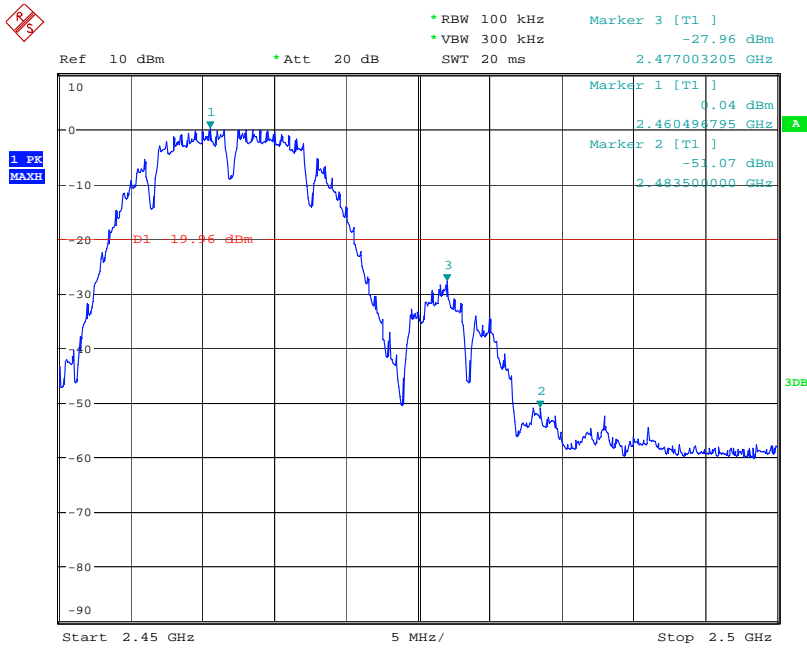

Test Mode: IEEE 802.11g mode

Low channel

Antenna 1

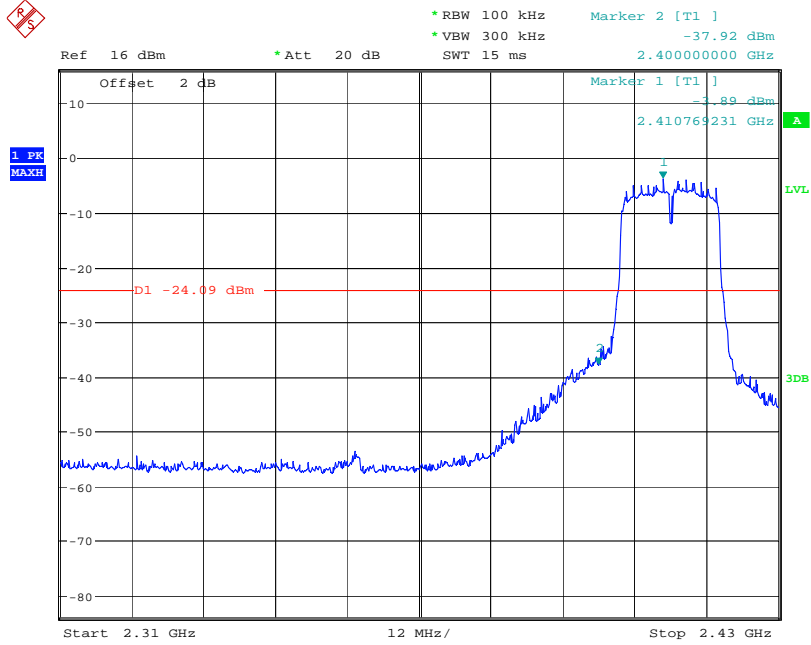

Antenna 2

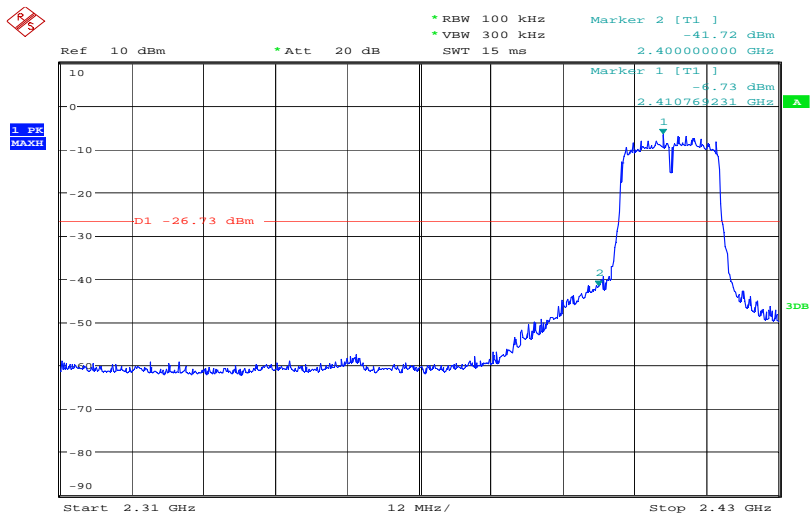

High channel Antenna 1

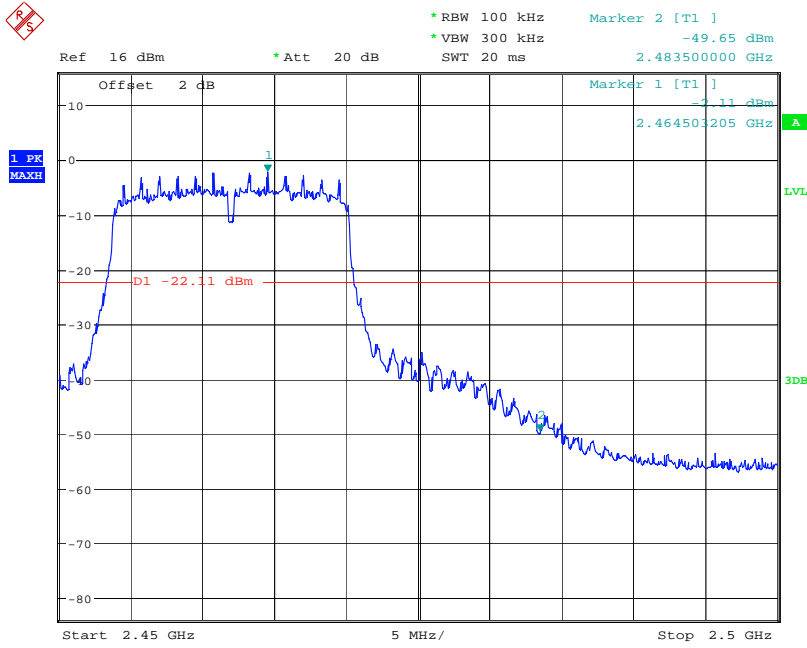

Antenna 2

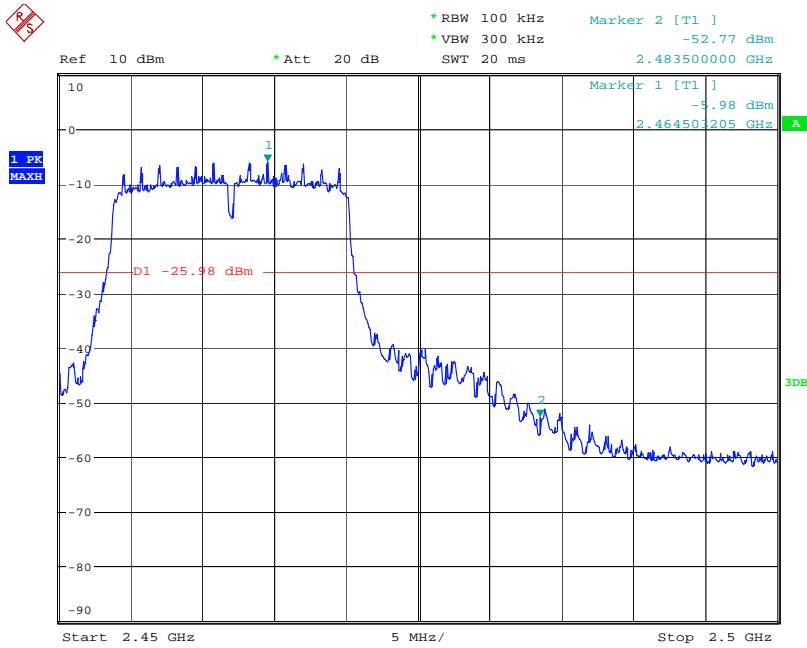

High channel Antenna 1

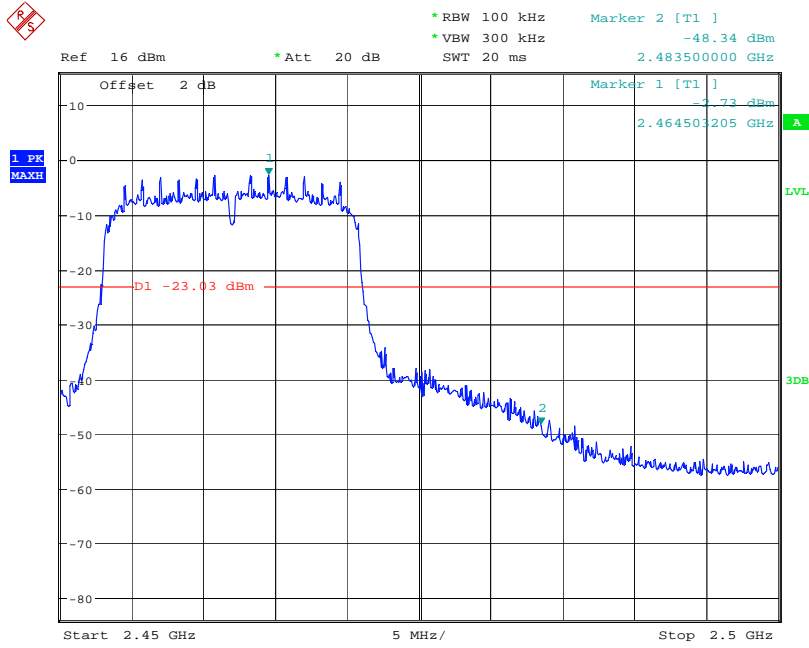

Antenna 2

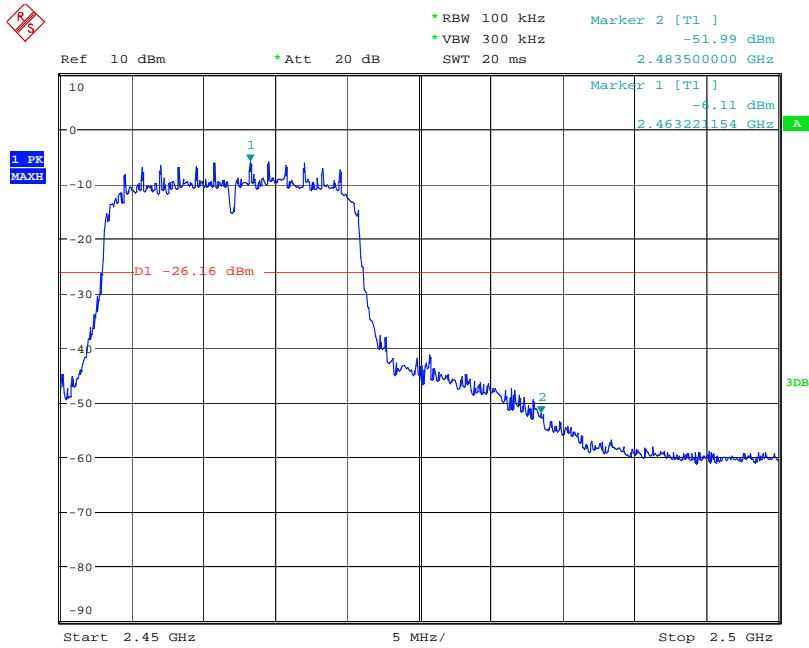

Test Mode: IEEE 802.11n (HT 40) mode

Low channel

Antenna 1

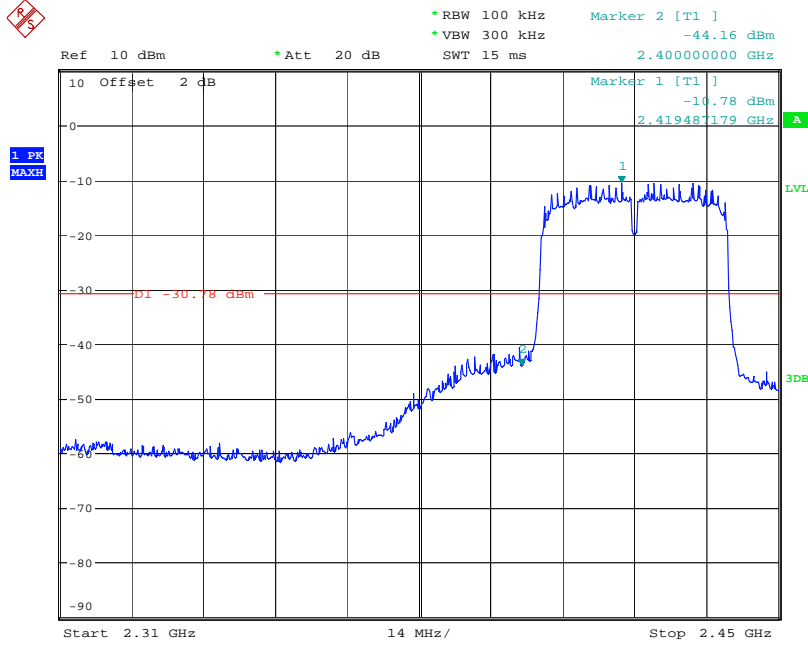

Antenna 2

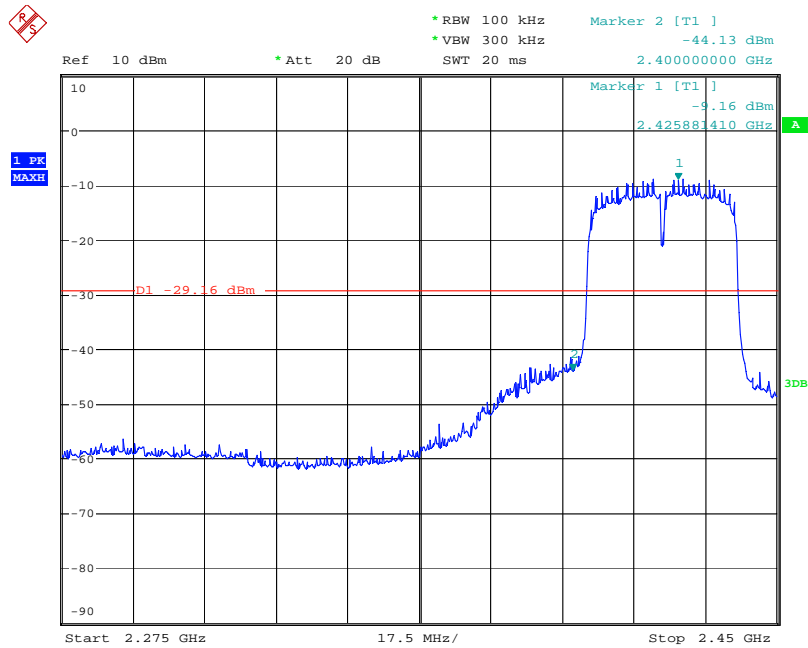

High channel Antenna 1

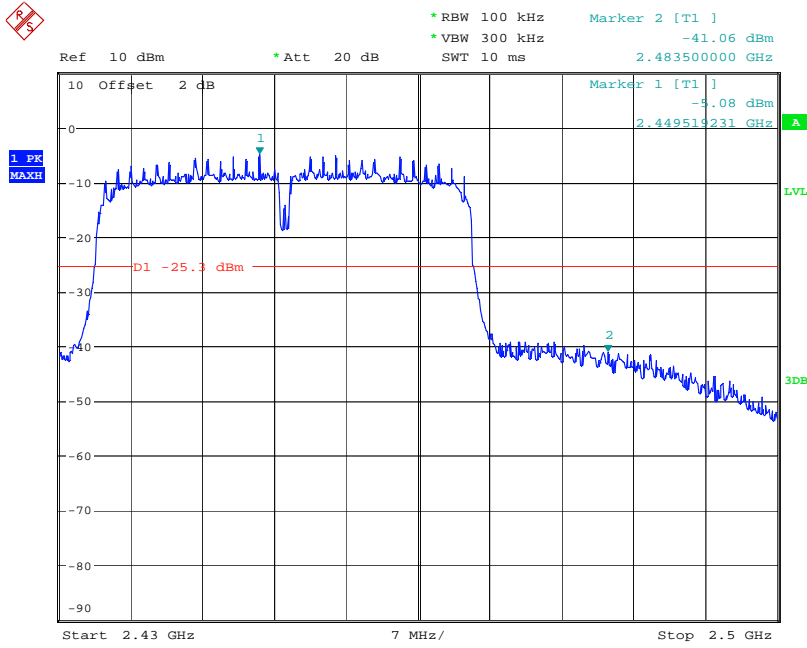

Antenna 2

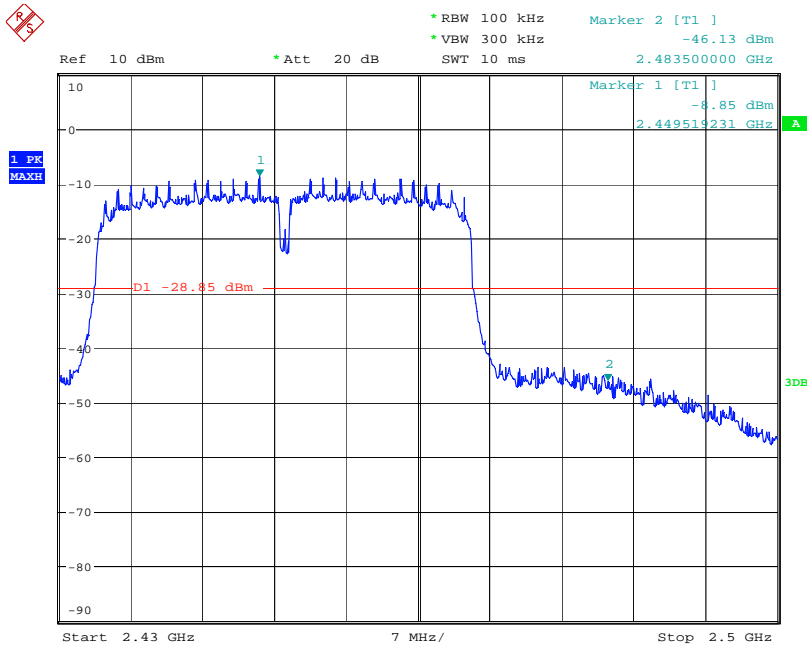

11.0 Spurious Emission Test

11.1 Conducted emissions Measurement

11.1.1 Test configuration

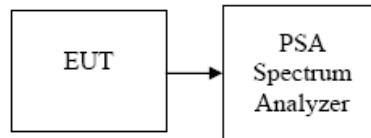

11.1.2 Limit:

In any 100 kHz bandwidth outside the frequency band in which the spread spectrum or digitally modulated intentional radiator is operating, the radio frequency power that is produced by the intentional radiator shall be at least 20 dB below that in the 100 kHz bandwidth within the band that contains the highest level of the desired power, based on either an RF conducted or a radiated measurement. Attenuation below the general limits specified in Section 15.209(a) is not required. In addition, radiated emissions which fall in the restricted bands, as defined in Section 15.205(a), must also comply with the radiated emission limits specified in Section 15.209(a) (see Section 15.205(c)).

11.1.3 Test procedure:

Conducted RF measurements of the transmitter output were made to confirm that the EUT antenna port conducted emissions meet the specified limit and to identify any spurious signals that require further investigation or measurements on the radiated emissions site. The transmitter output is connected to the spectrum analyzer. The resolution bandwidth is set to 100 kHz. The video bandwidth is set to 100 kHz. Measurements are made over the 30MHz to 25 GHz range with the transmitter set to the lowest, middle, and highest channels.

11.1.4 Test Equipment

Instrument Type	Manufacturer	Model	Serial No.	Date of Cal.	Due Date
Spectrum Analyzer	ROHDE&SCHWARZ	FSEM	848597/001	July 3, 2014	July 2, 2015

11.1.5 Test Result:

Test plots please refer to next pages.

- Note: 1. Conducted emissions measurements below 30 MHz were made, and the maximum peak was detected, which is much less the limit. So it is not submitted in the report.
 2. Above 13G the signal is too low, which is much less than the limit, no necessary take down the records.

Test plots:

Antenna 1

Test Mode: IEEE 802.11b mode

Low channel

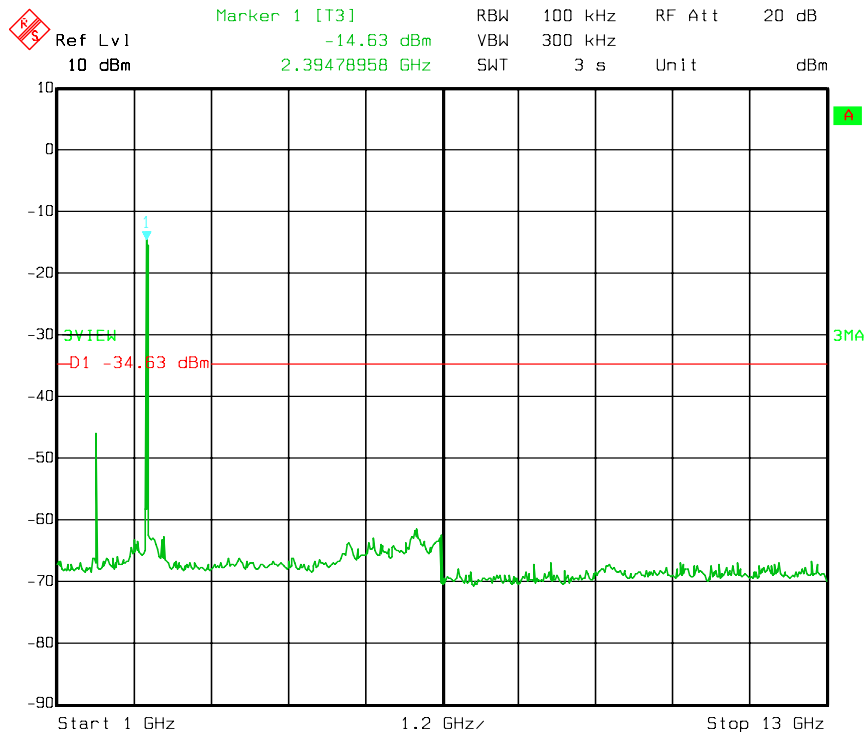
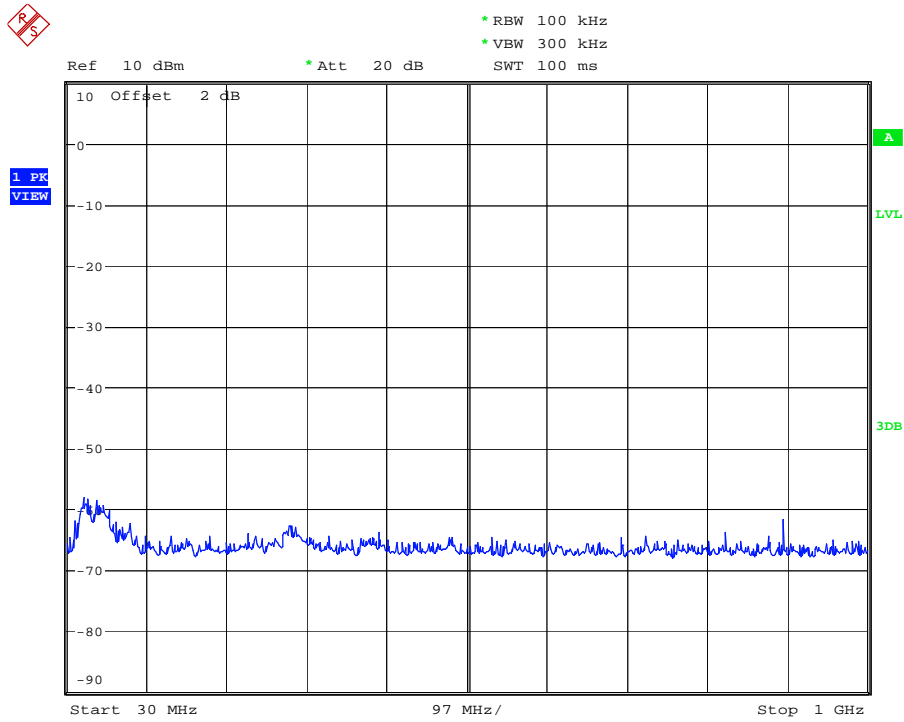

Note: Sweep points=1001pts

Middle channel

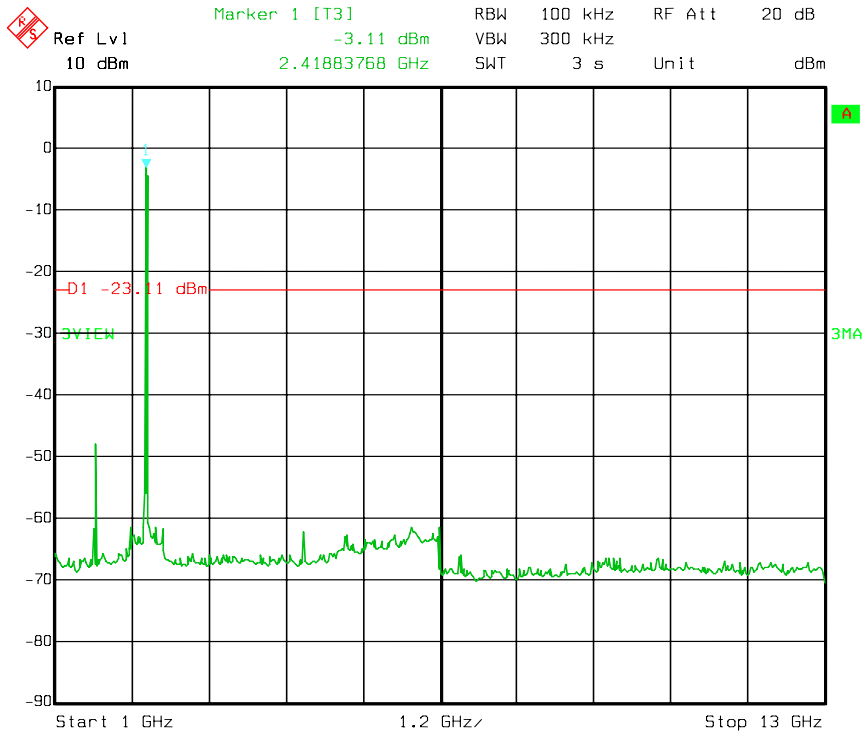
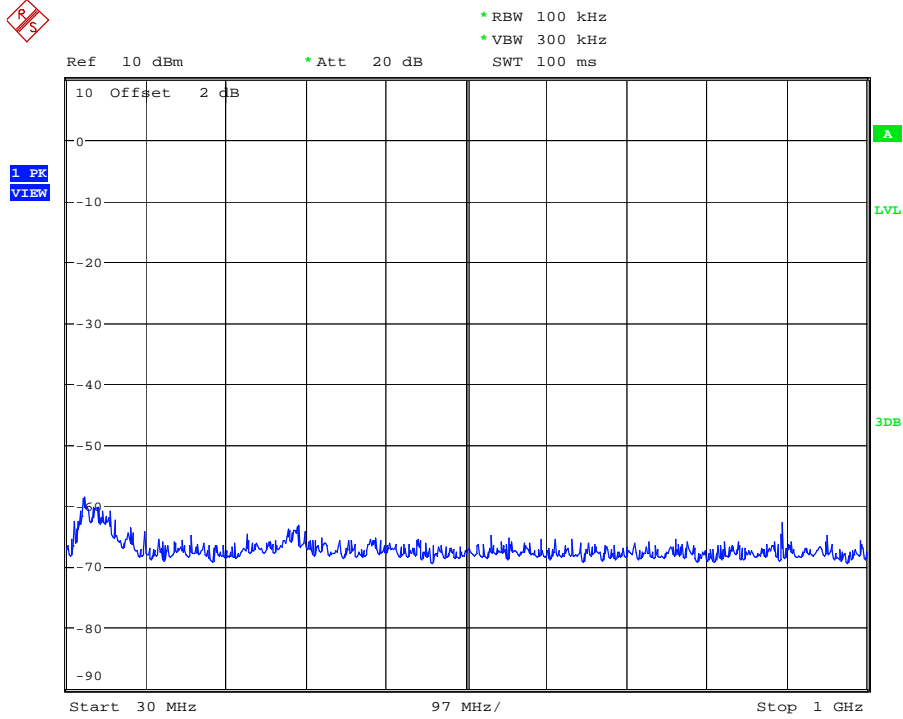

Note: Sweep points=1001pts

High channel

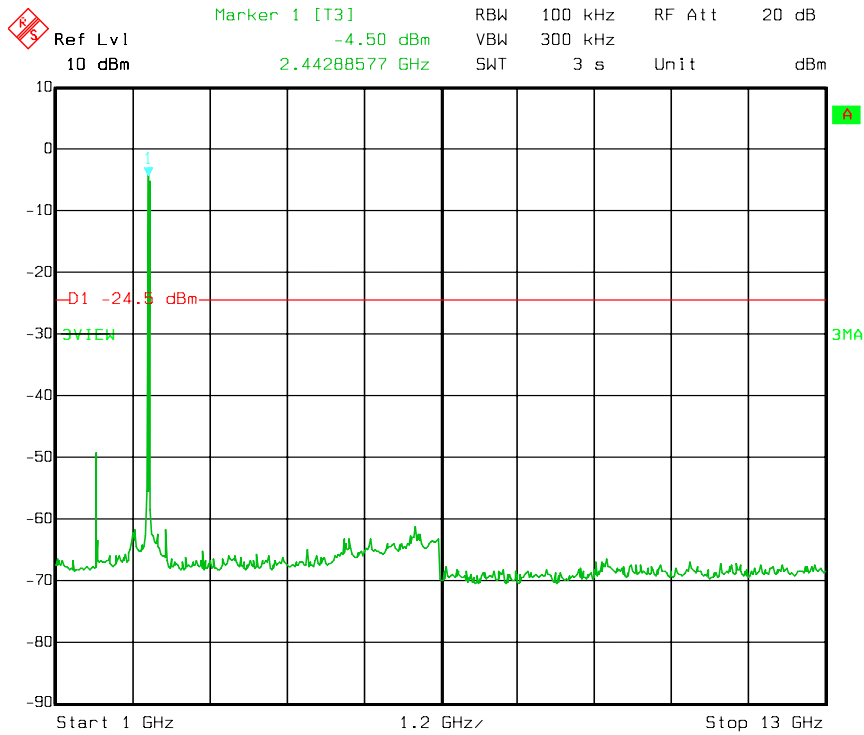
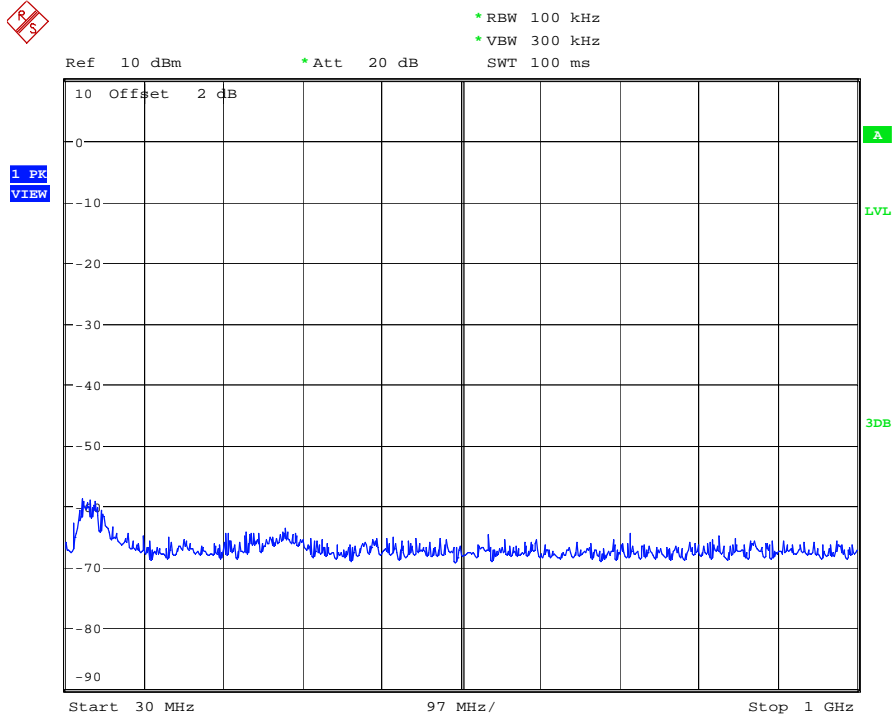

Note: Sweep points=1001pts

Test Mode: IEEE 802.11g mode

Low channel

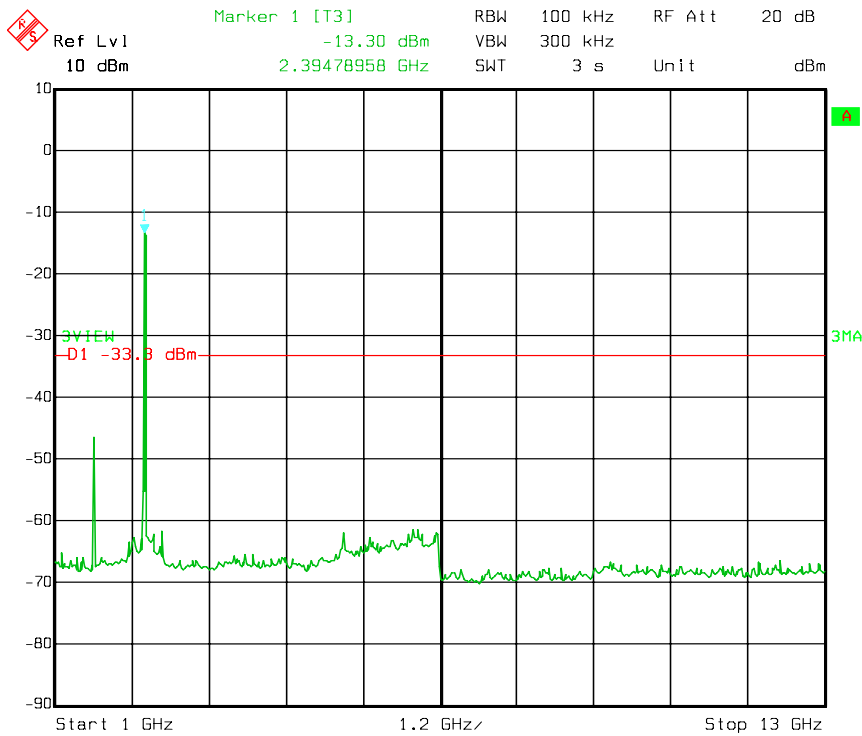
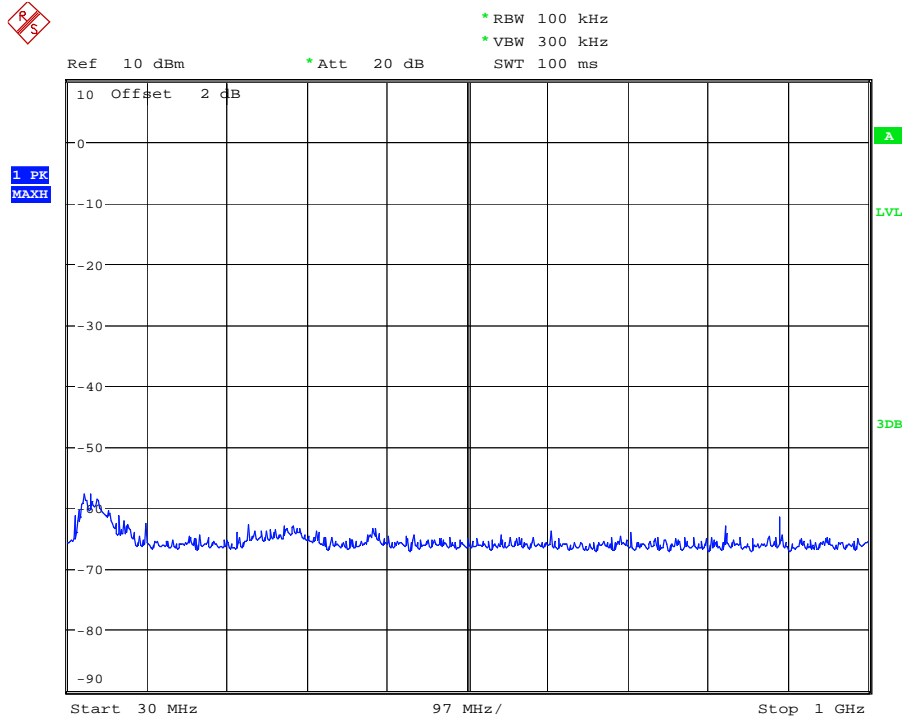

Note: Sweep points=1001pts

Middle channel

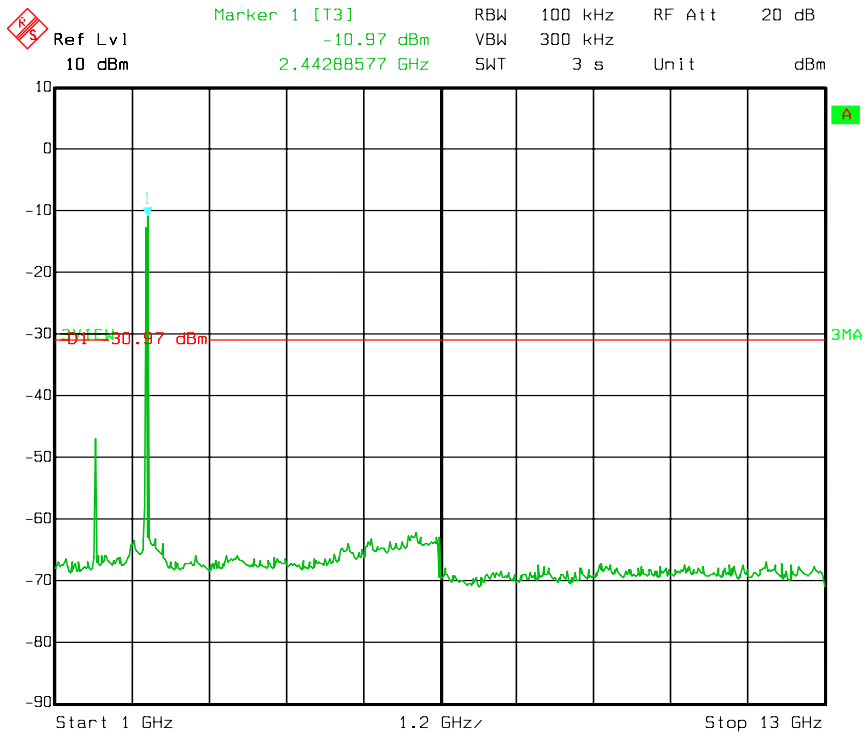
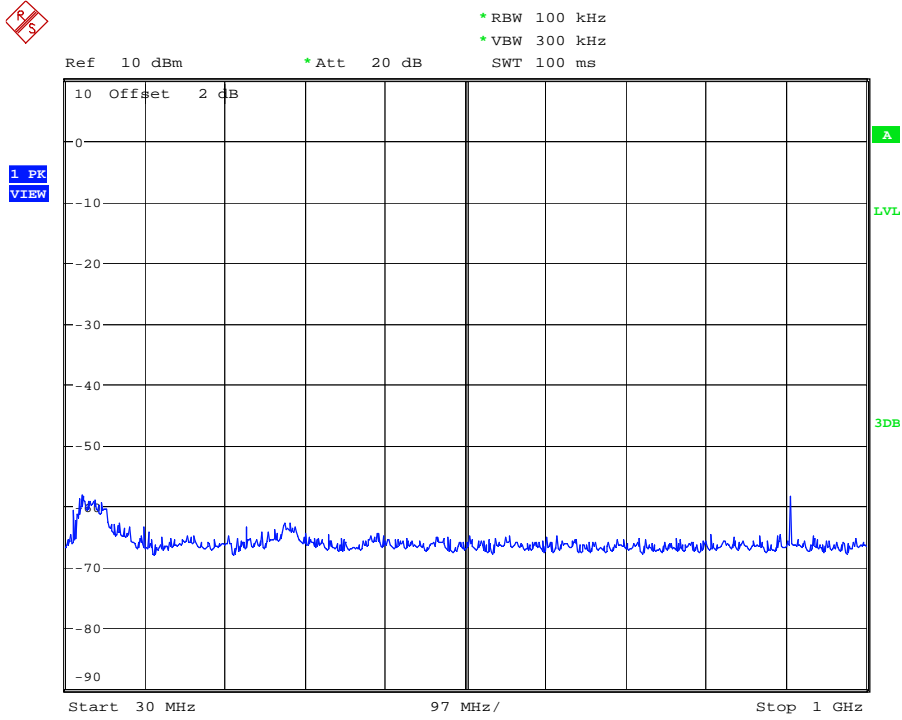

Note: Sweep points=1001pts

High channel

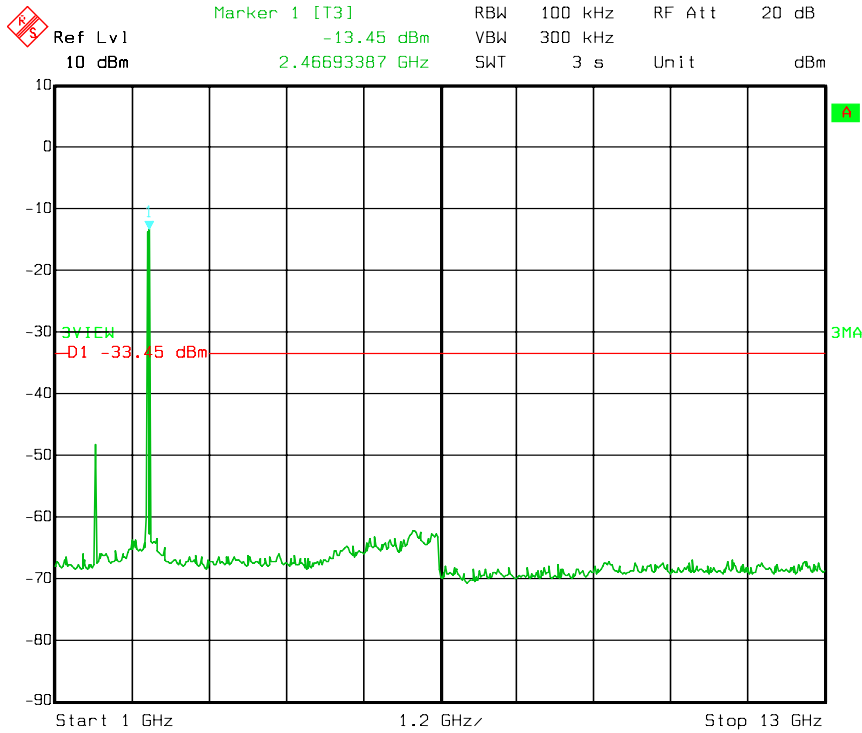
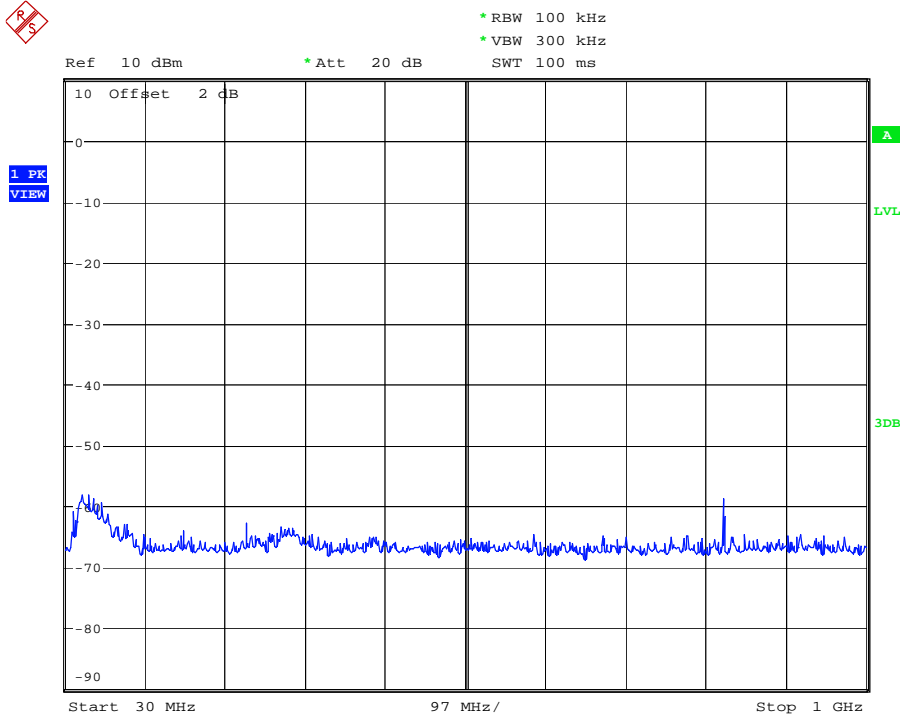

Note: Sweep points=1001pts

Test Mode: IEEE 802.11n(HT 20) mode

Low channel

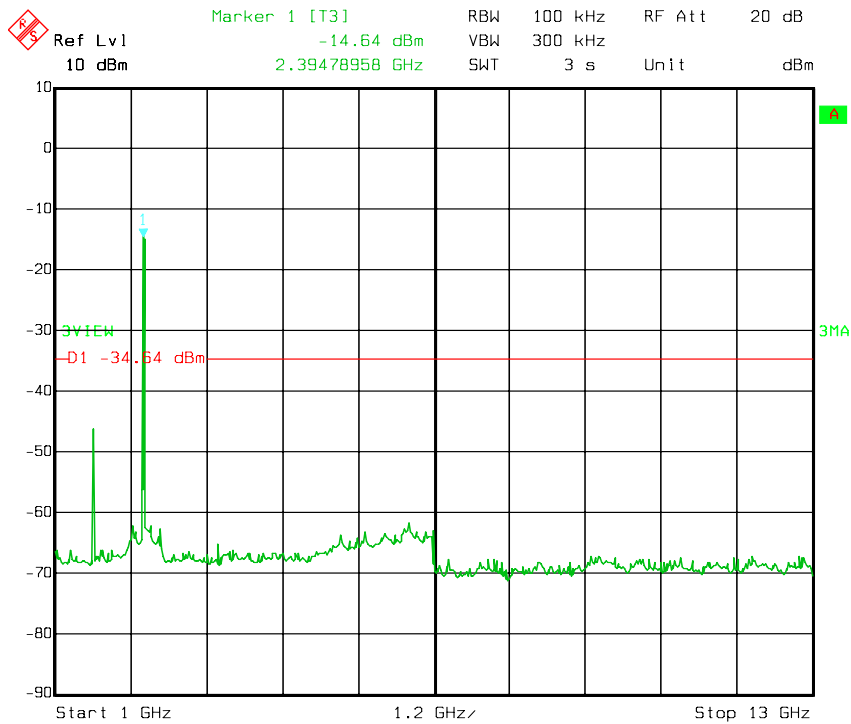
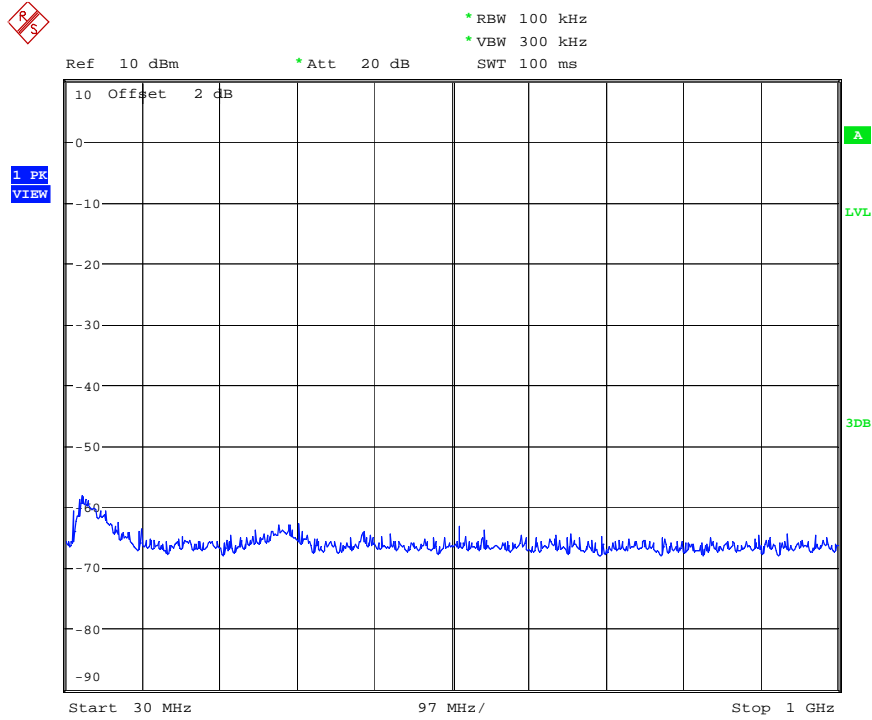

Note: Sweep points=1001pts

Middle channel

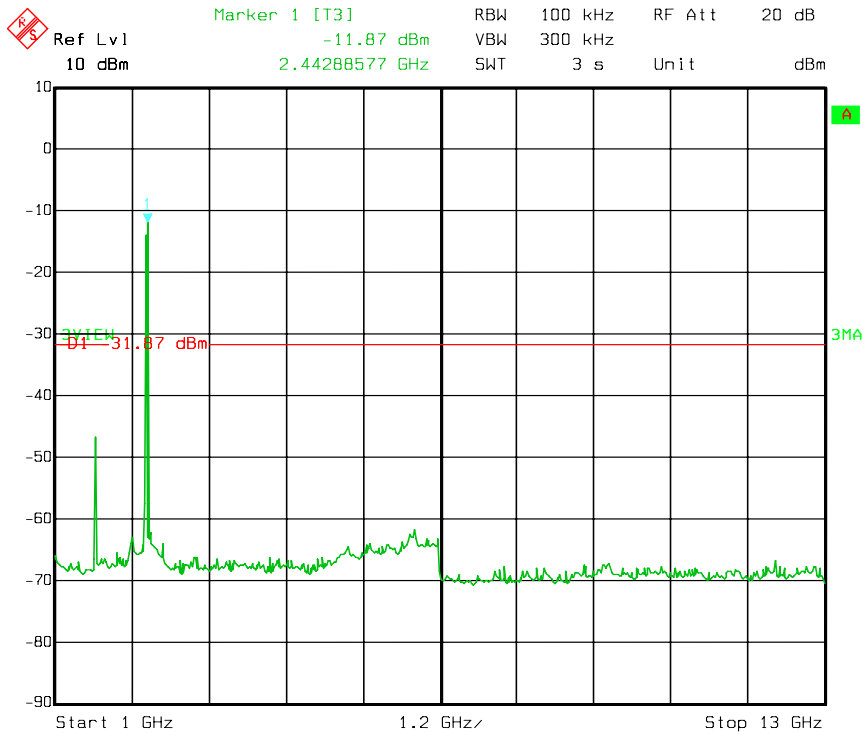
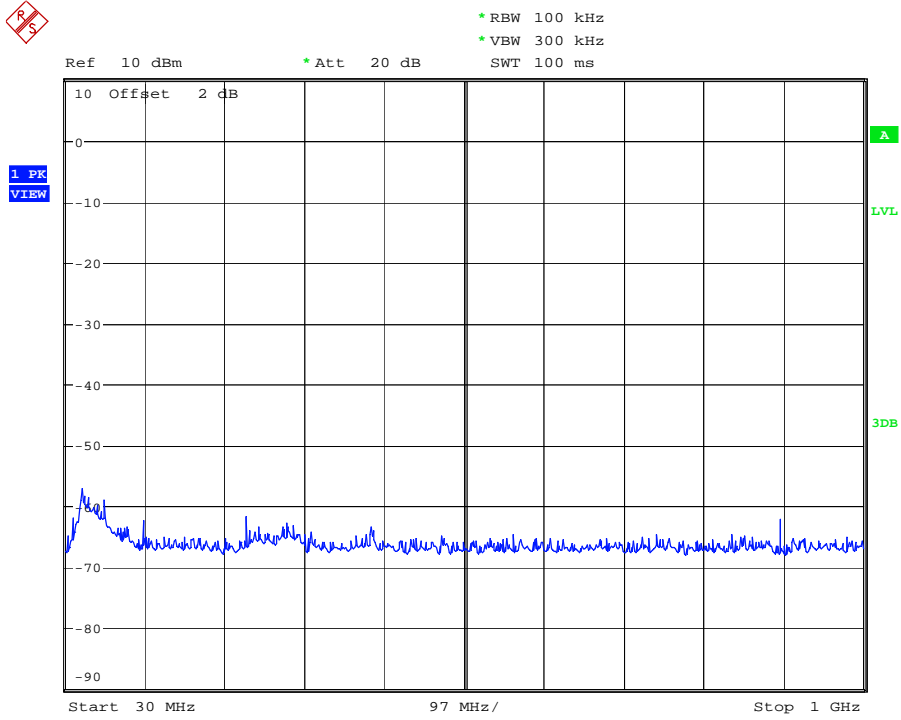

Note: Sweep points=1001pts

High channel

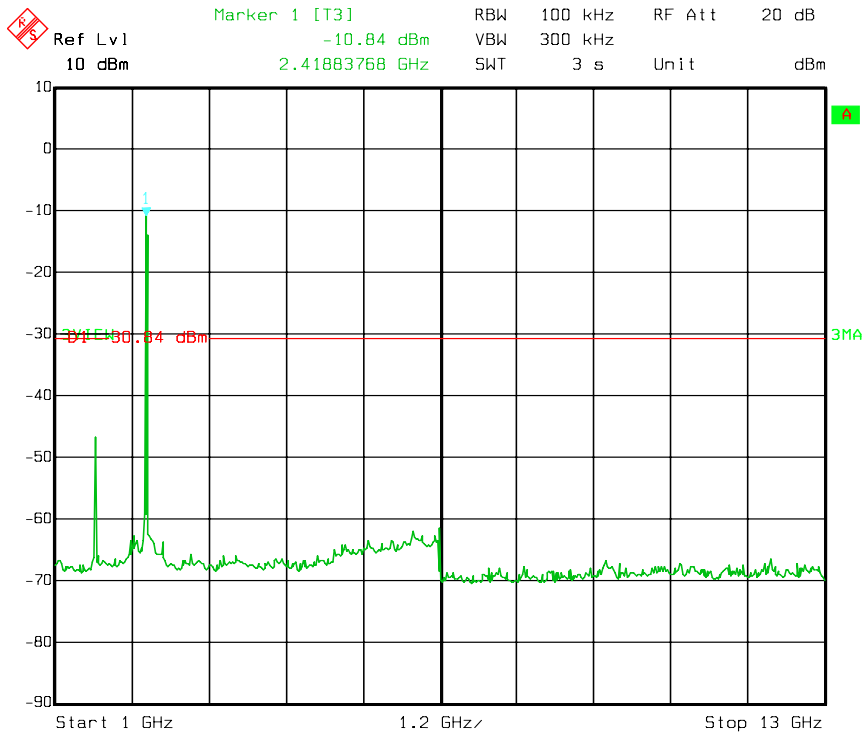
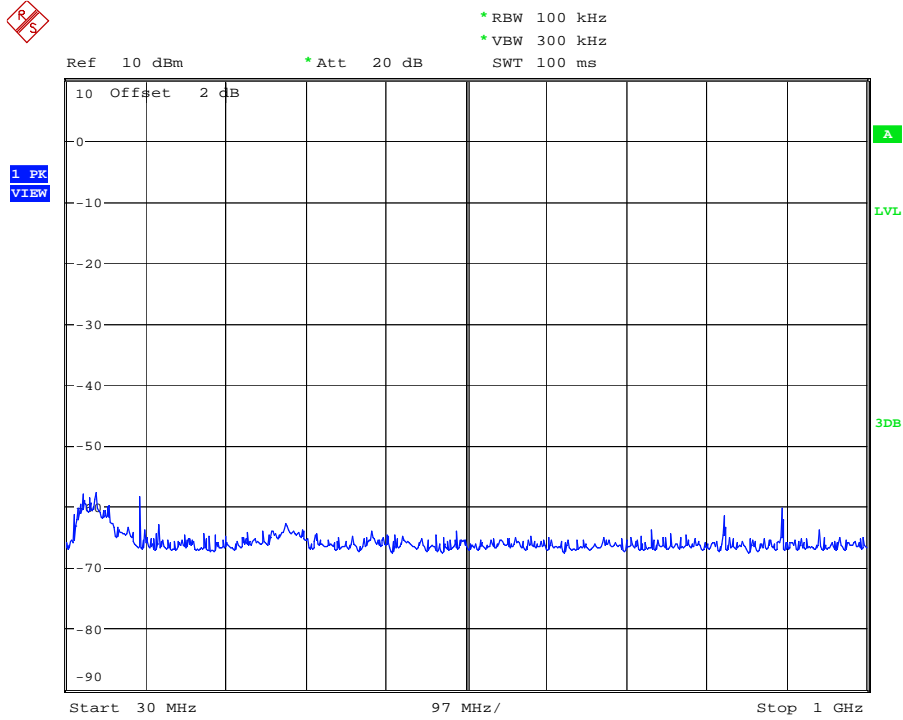

Note: Sweep points=1001pts

Test Mode: IEEE 802.11n(HT 40) mode

Low channel

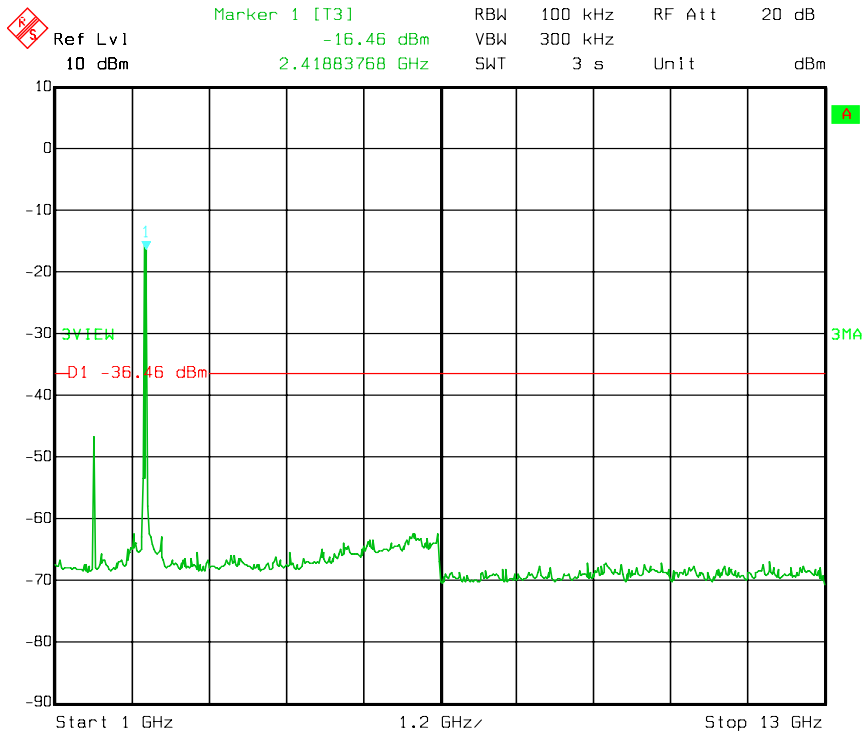
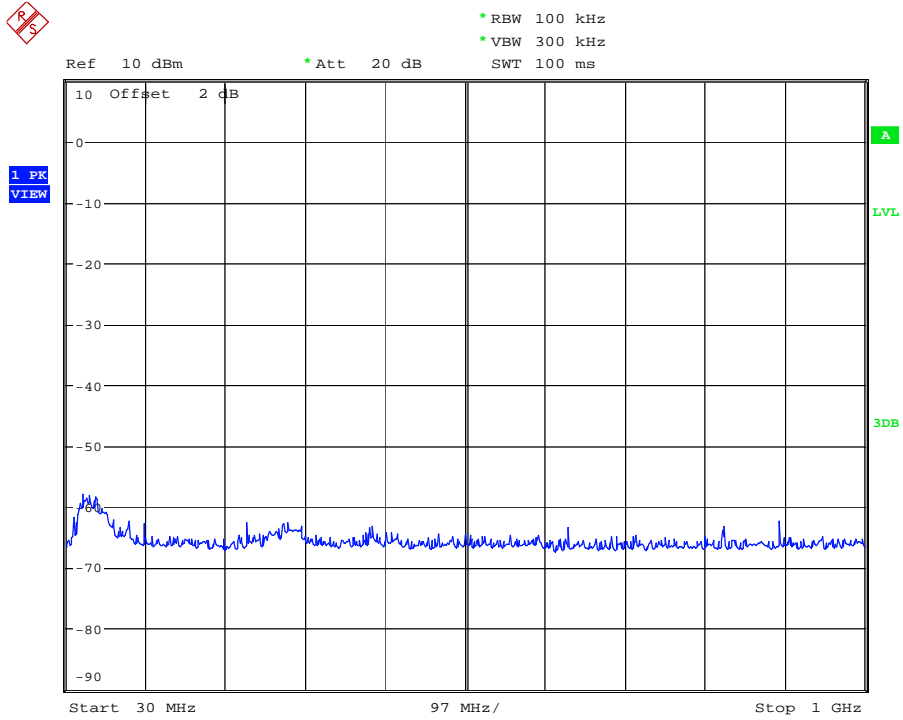

Note: Sweep points=1001pts

High channel

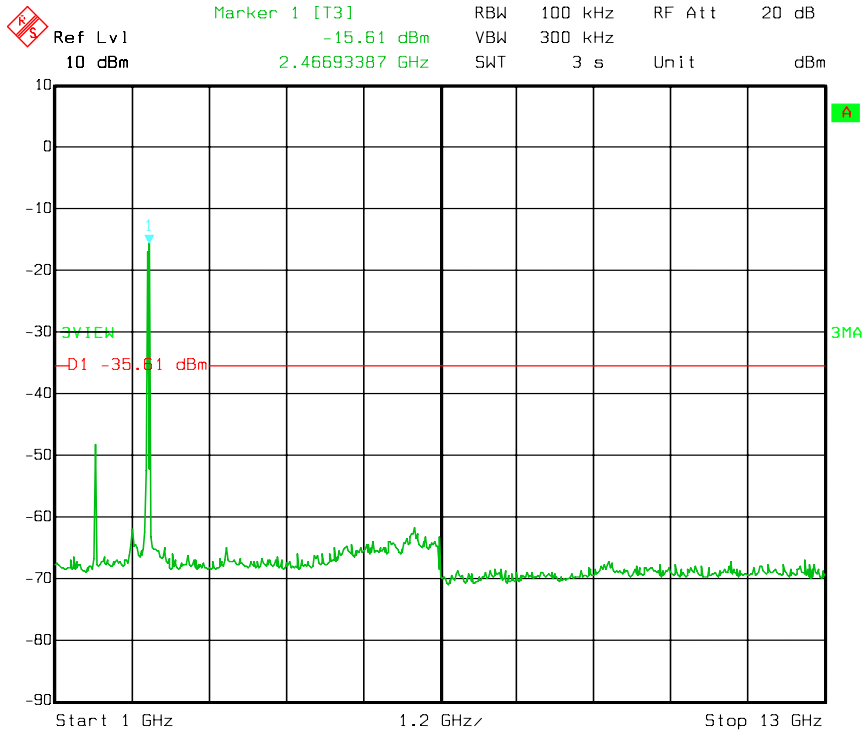
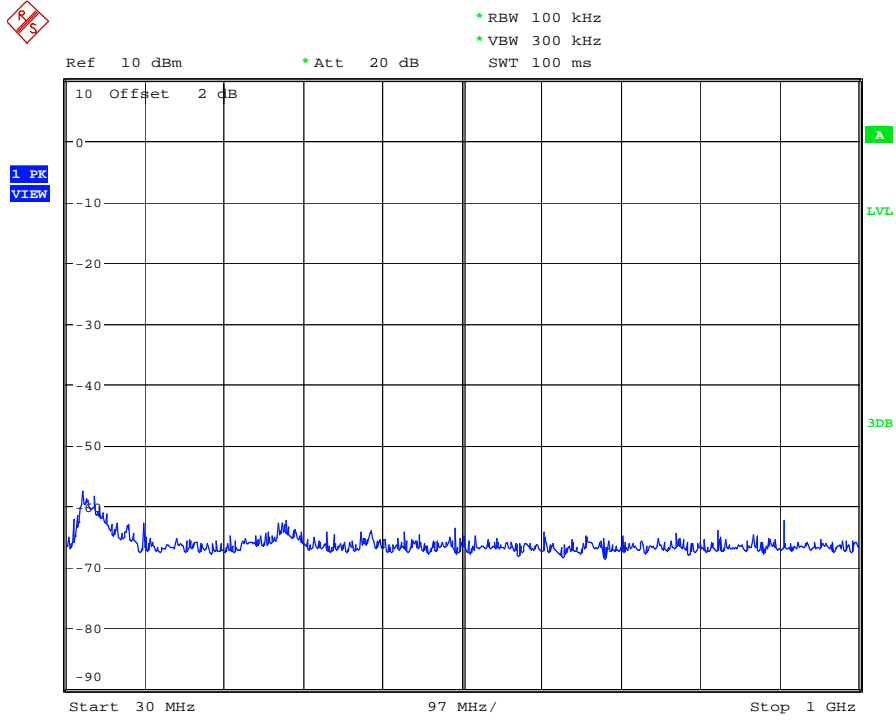

Note: Sweep points=1001pts

Test plots:

Antenna 2

Test Mode: IEEE 802.11b mode

Low channel

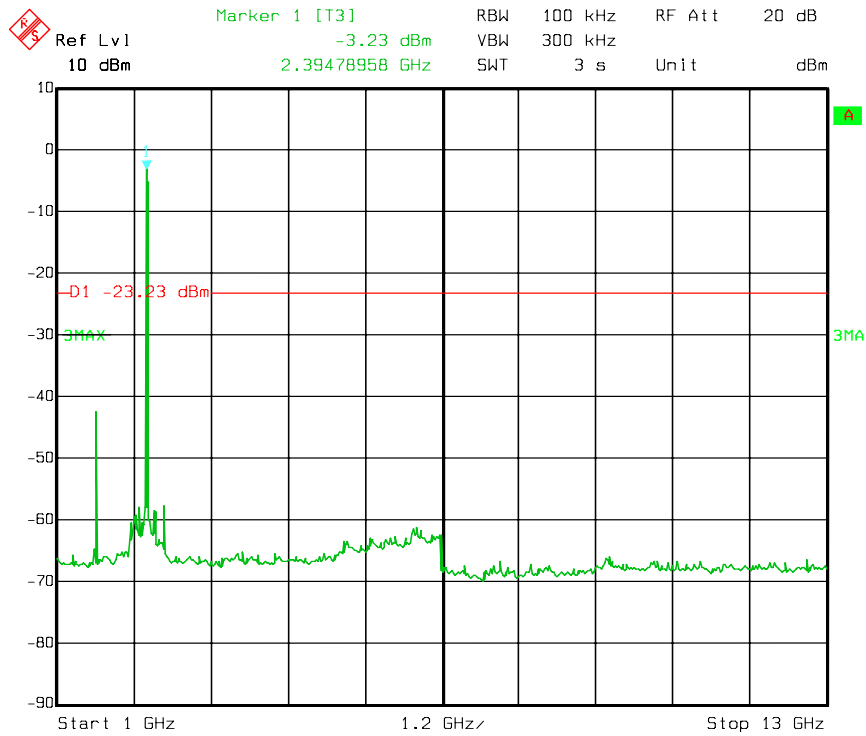
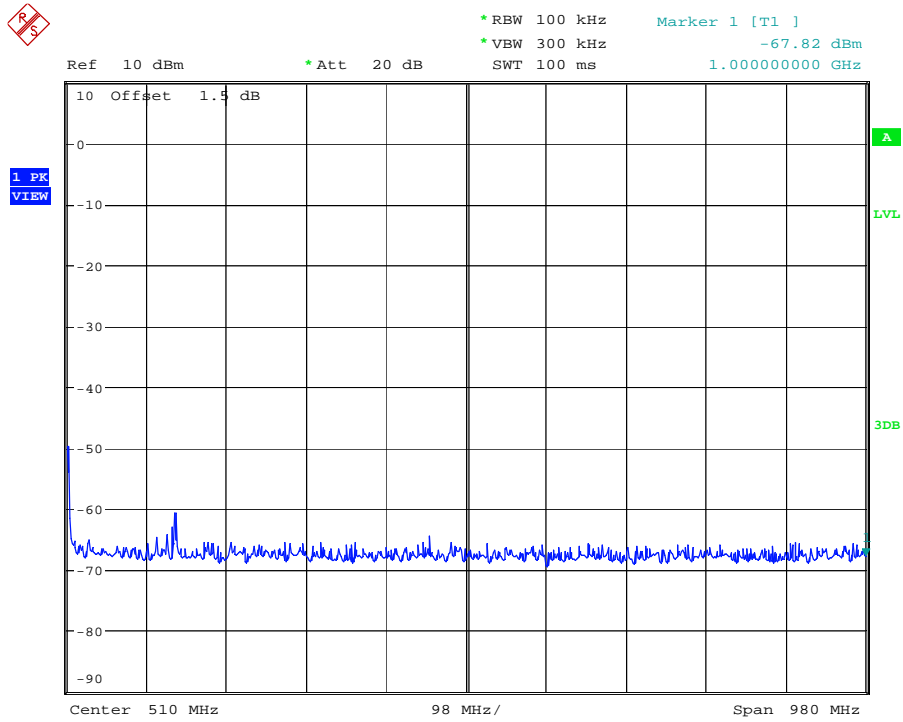

Note: Sweep points=1001pts

Middle channel

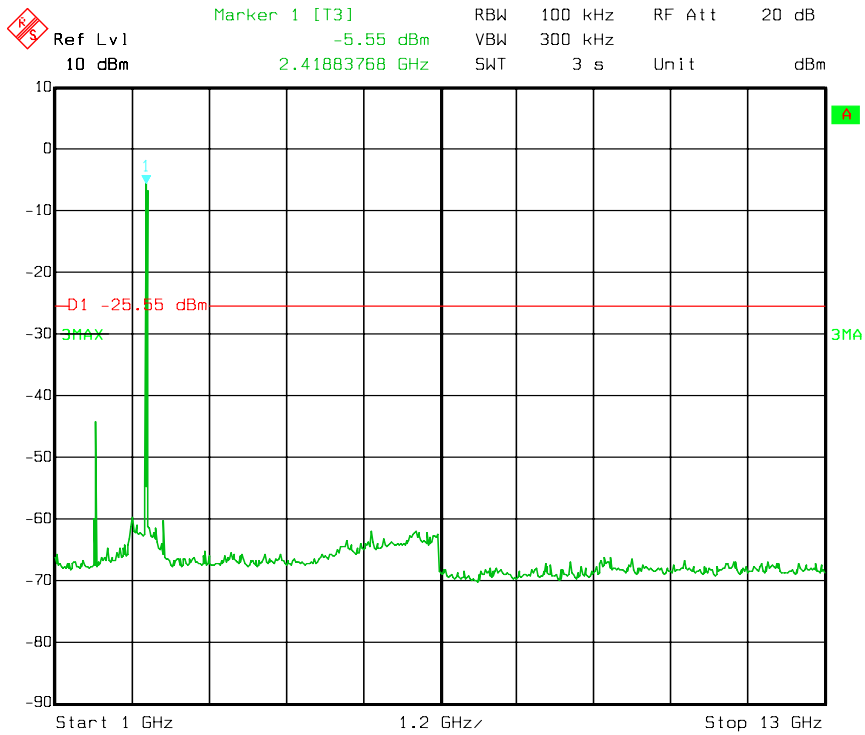
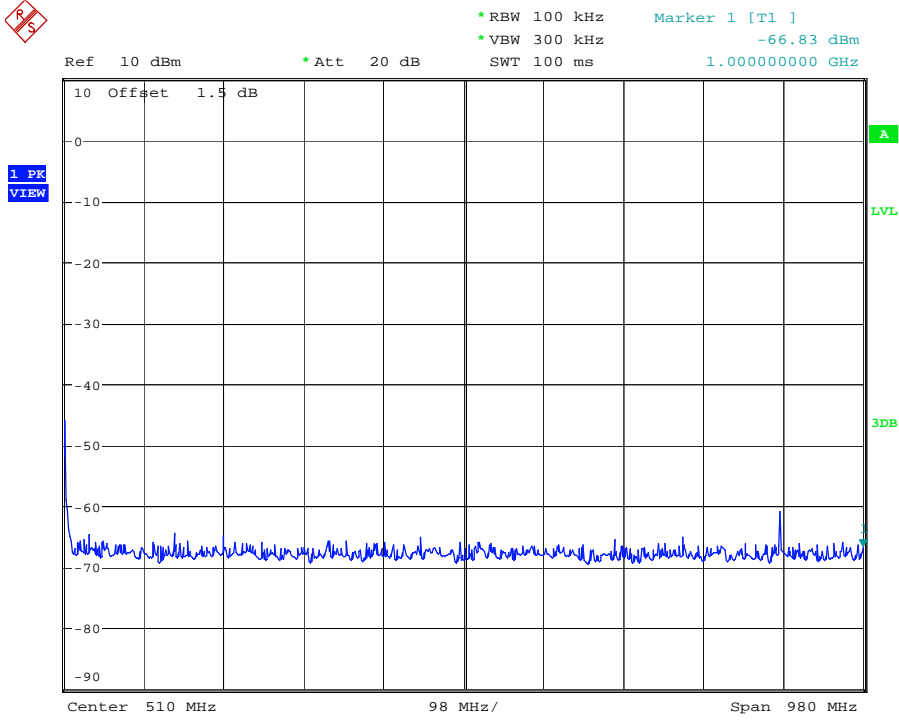

Note: Sweep points=1001pts

High channel

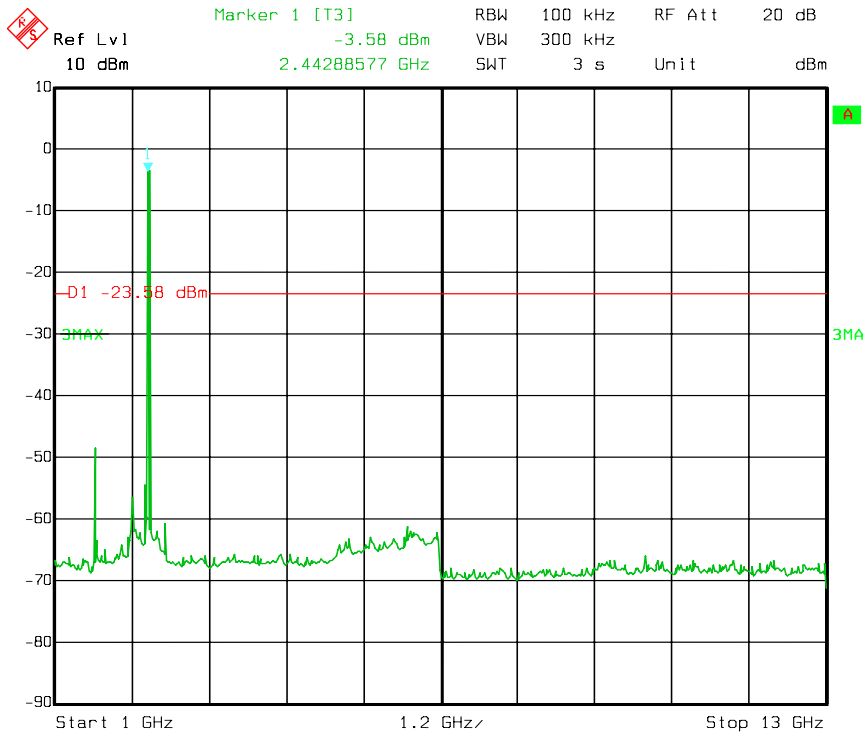
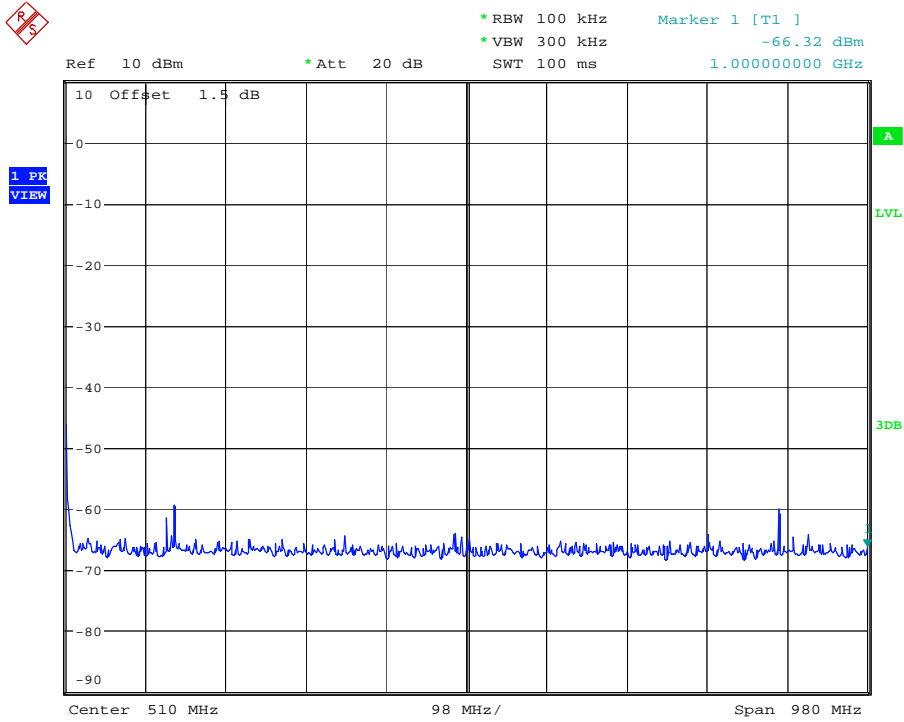

Note: Sweep points=1001pts

Test Mode: IEEE 802.11g mode

Low channel

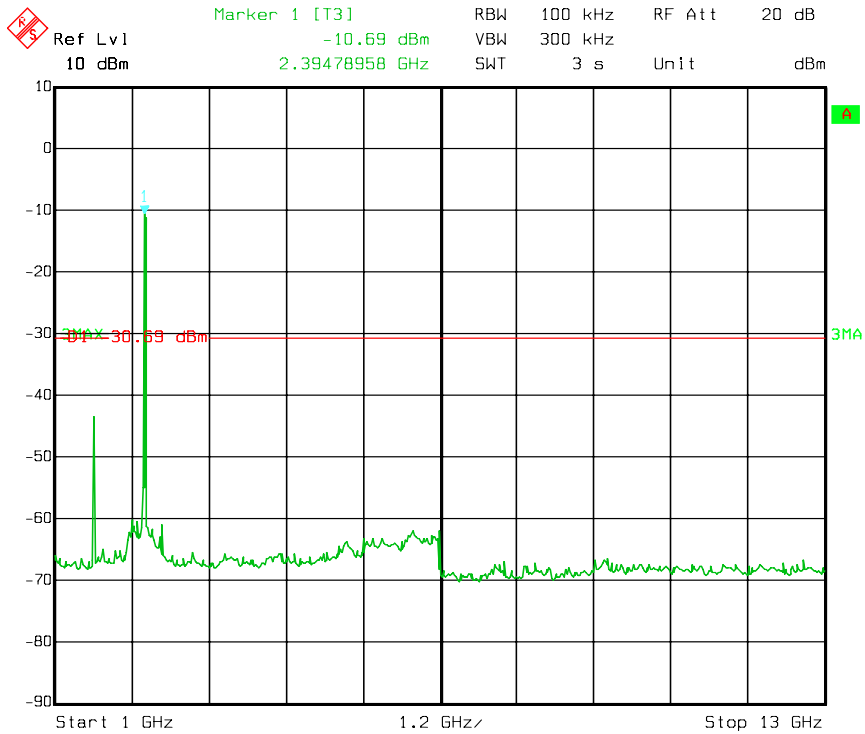
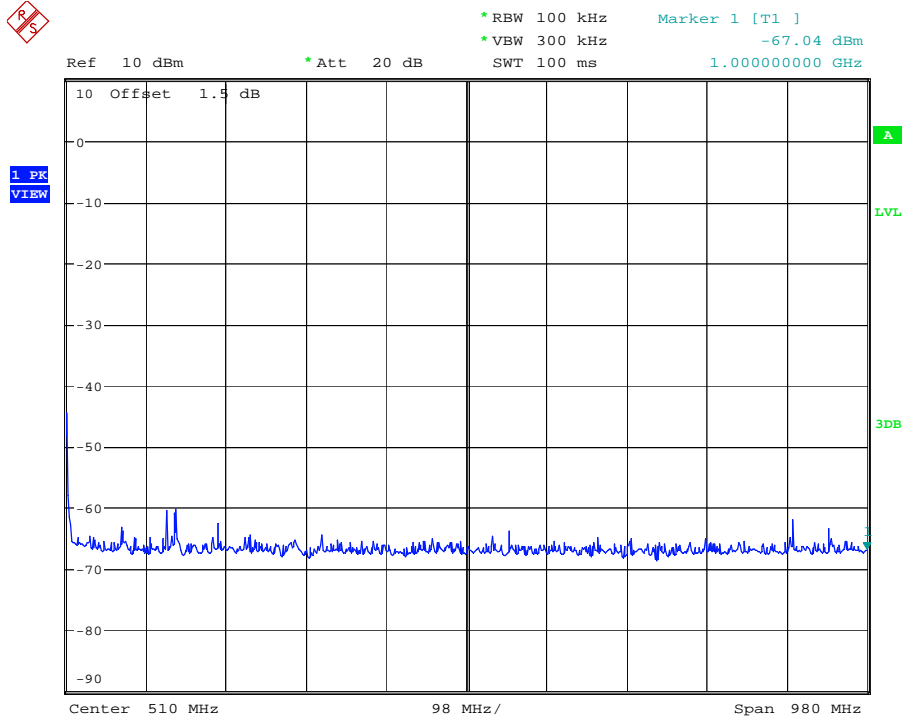

Note: Sweep points=1001pts

Middle channel

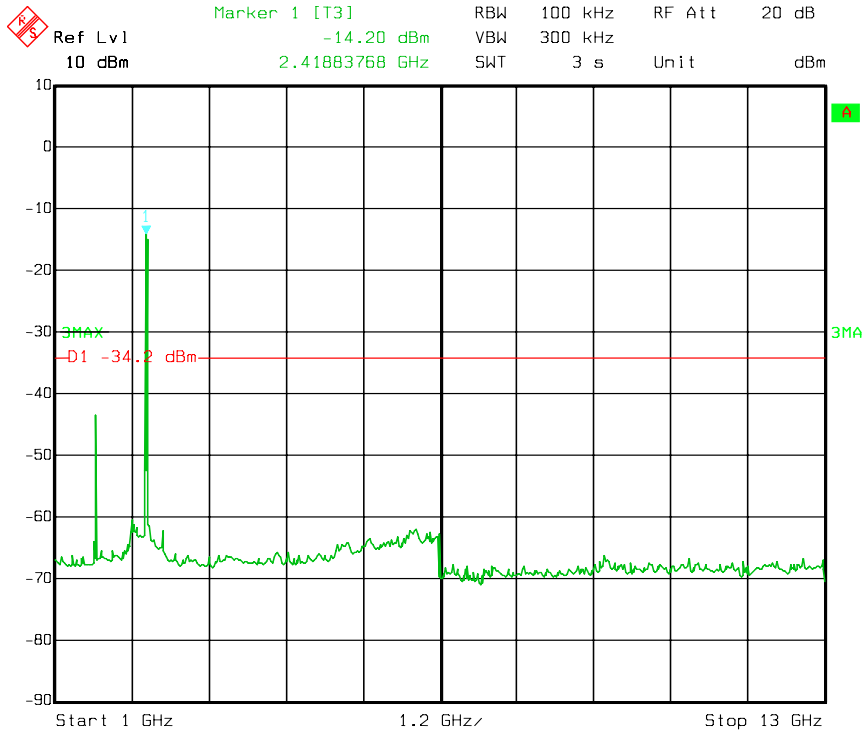
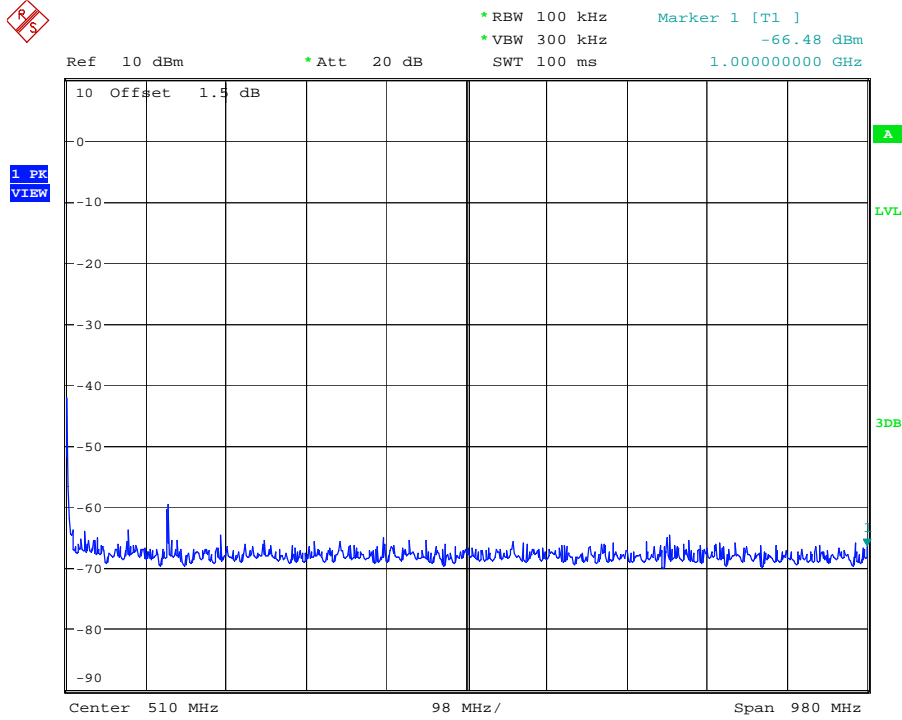

Note: Sweep points=1001pts

High channel

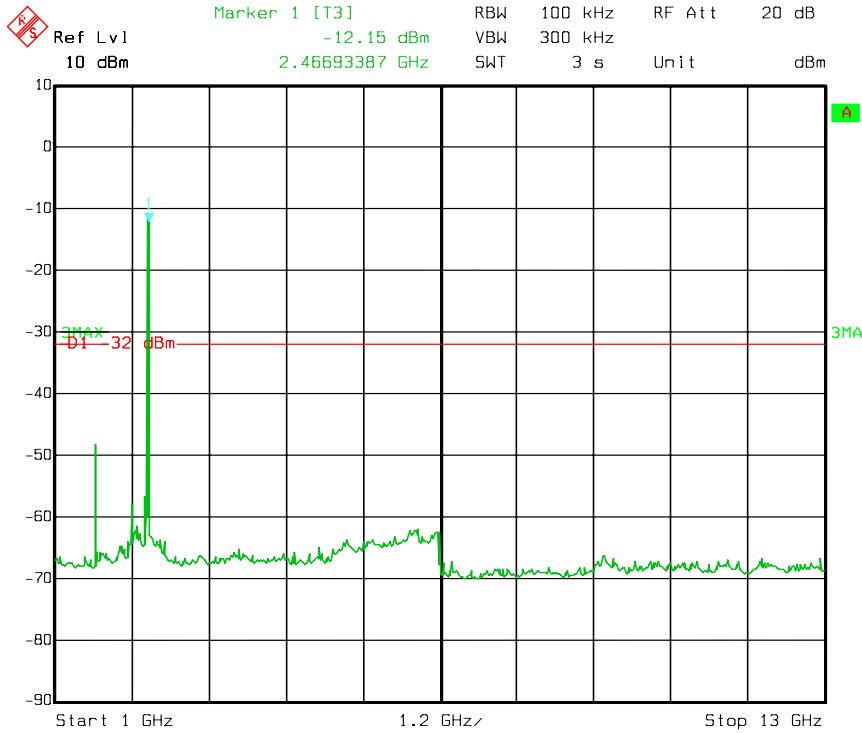
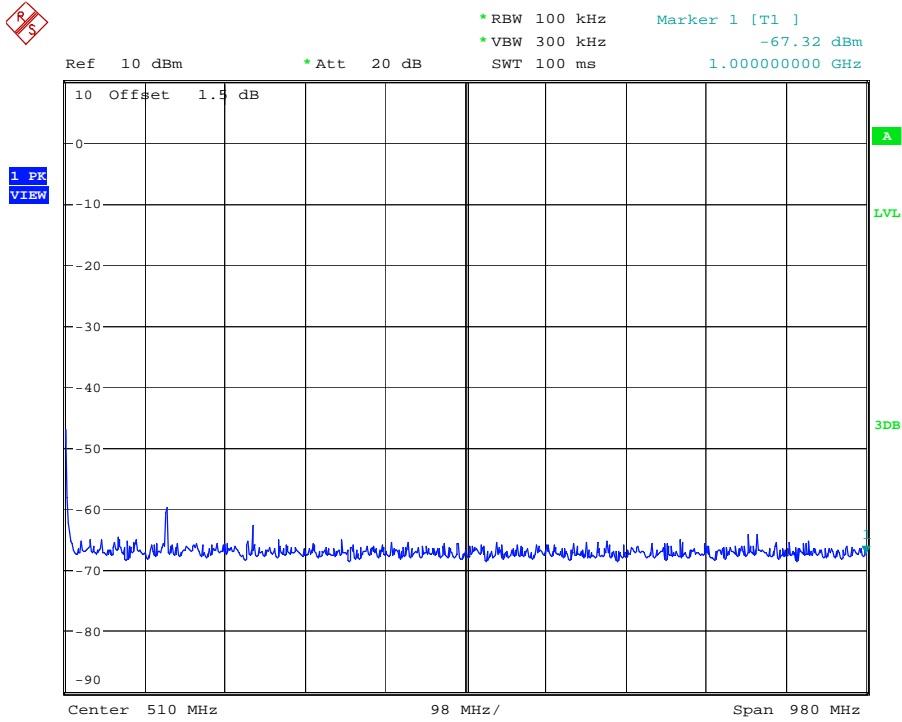

Note: Sweep points=1001pts

Test Mode: IEEE 802.11n(HT 20) mode

Low channel

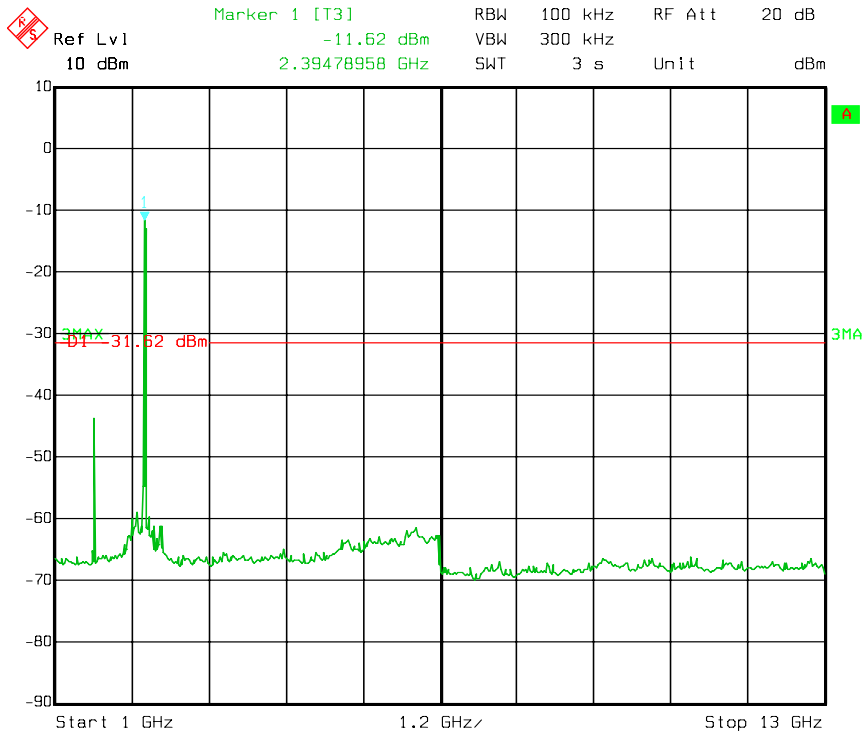
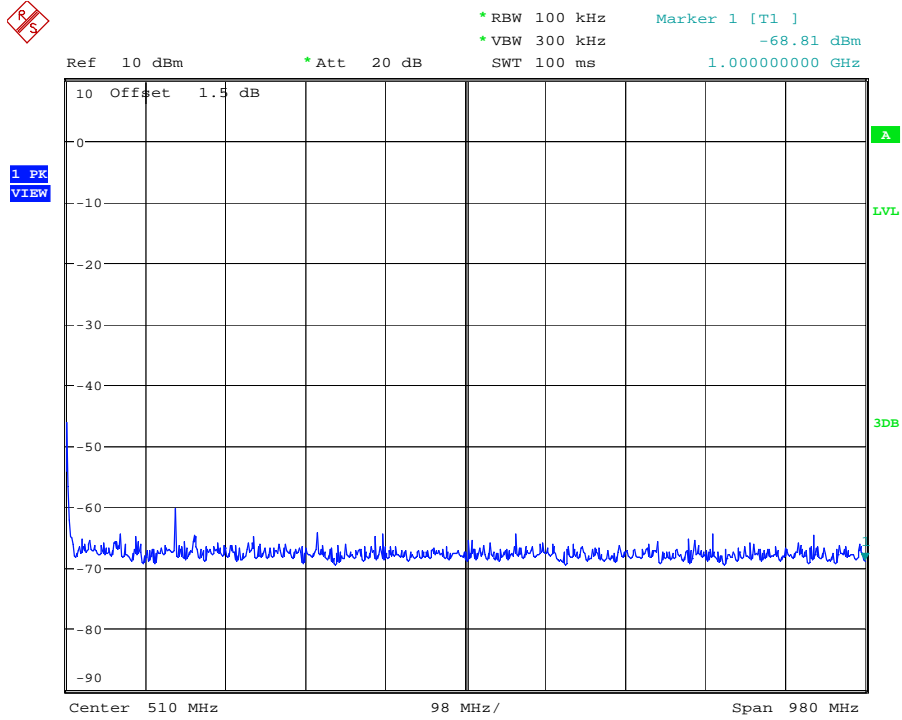

Note: Sweep points=1001pts

Middle channel

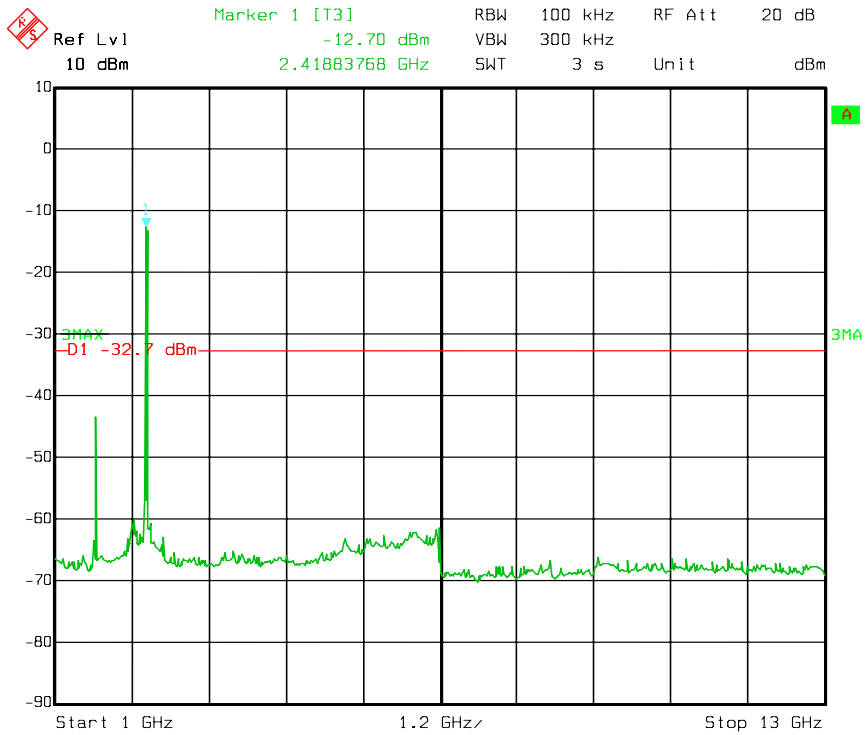
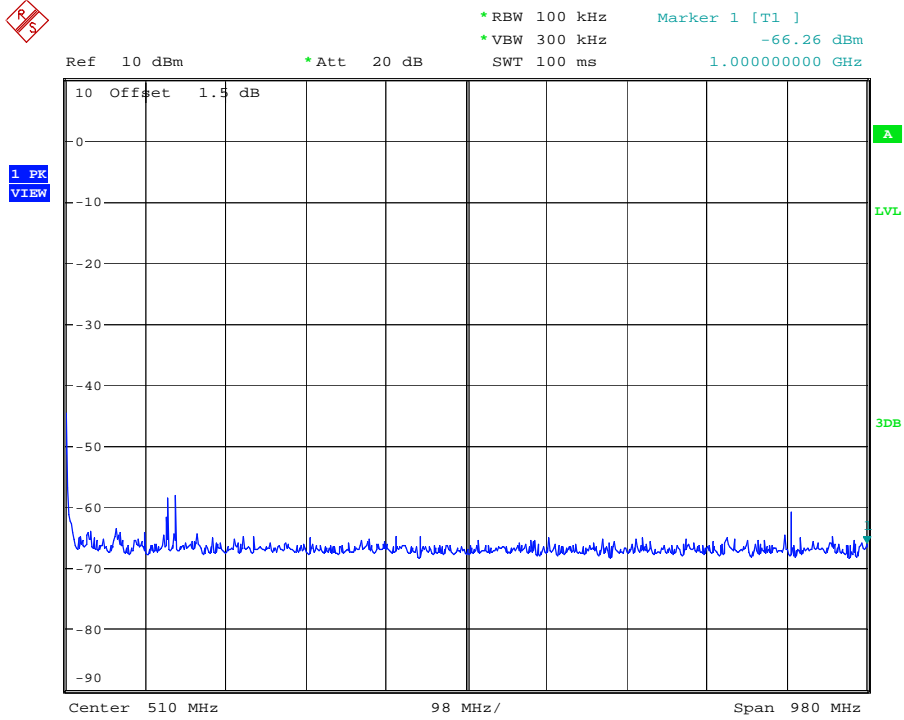

Note: Sweep points=1001pts

High channel

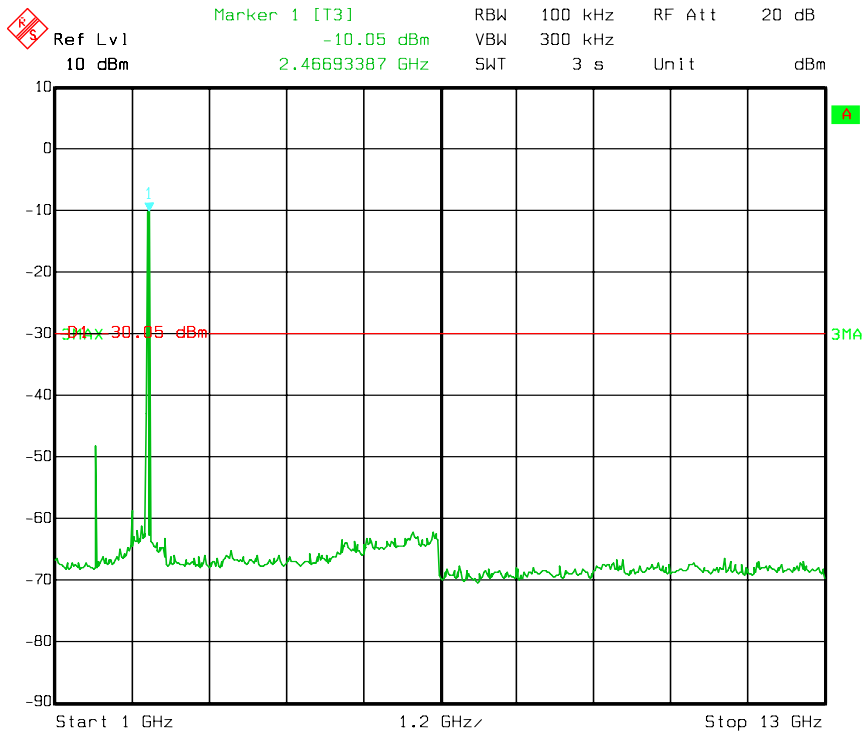
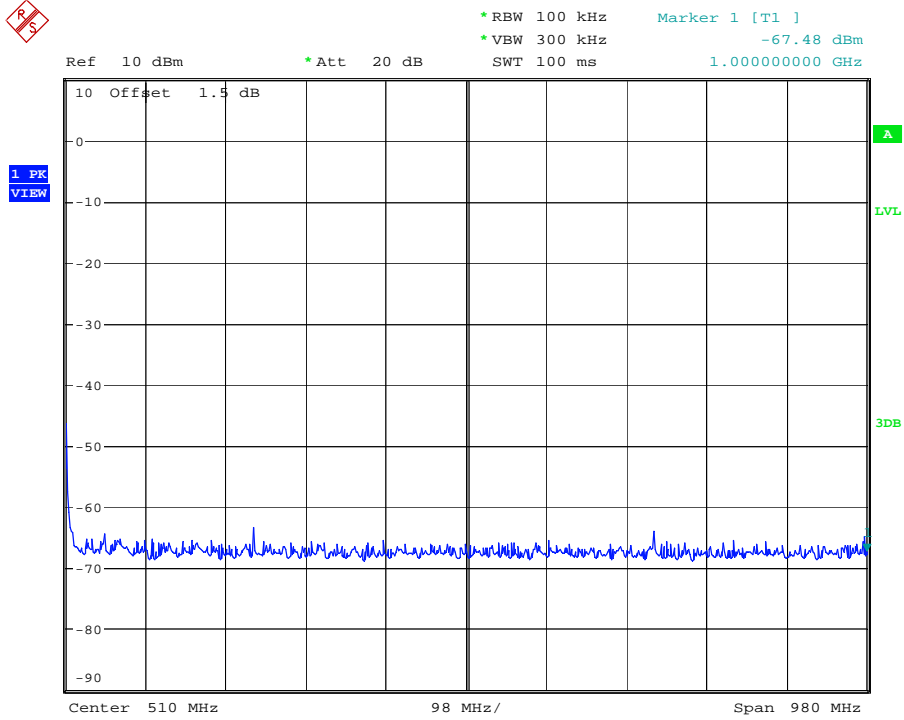

Note: Sweep points=1001pts

Test Mode: IEEE 802.11n(HT 40) mode

Low channel

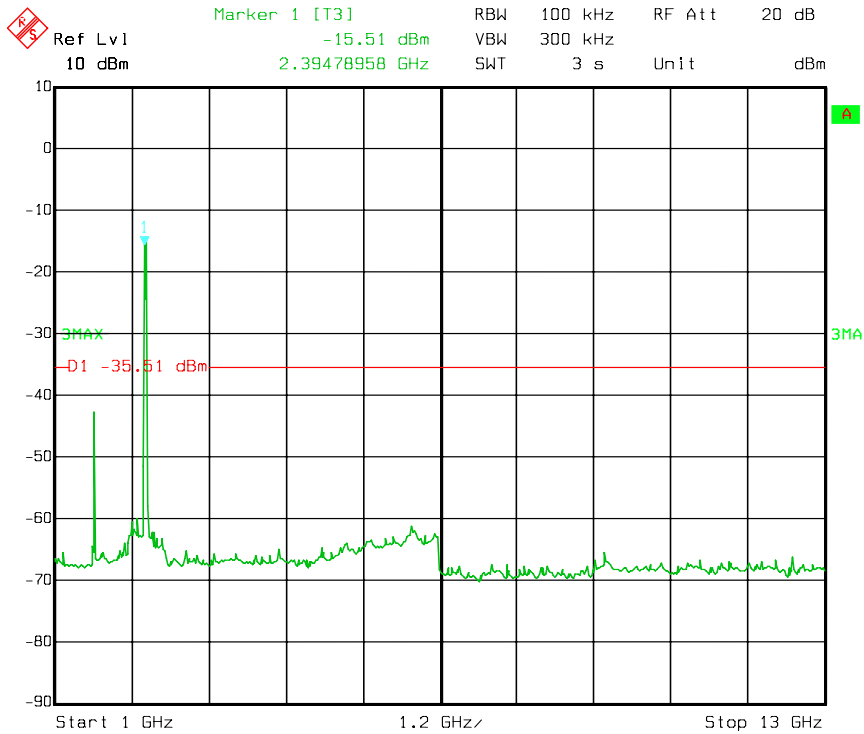
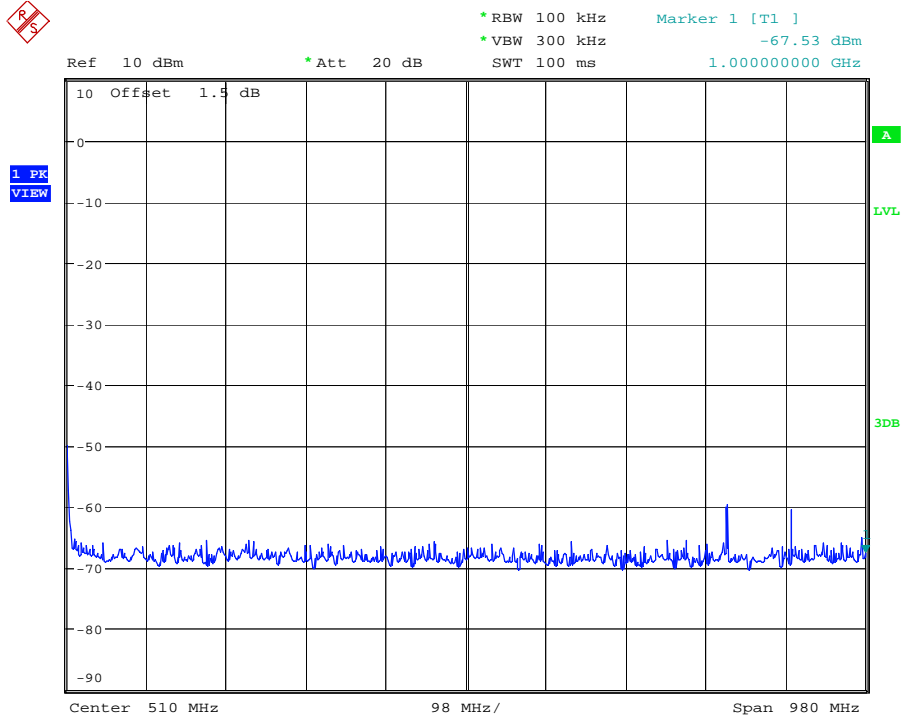

Note: Sweep points=1001pts

Middle channel

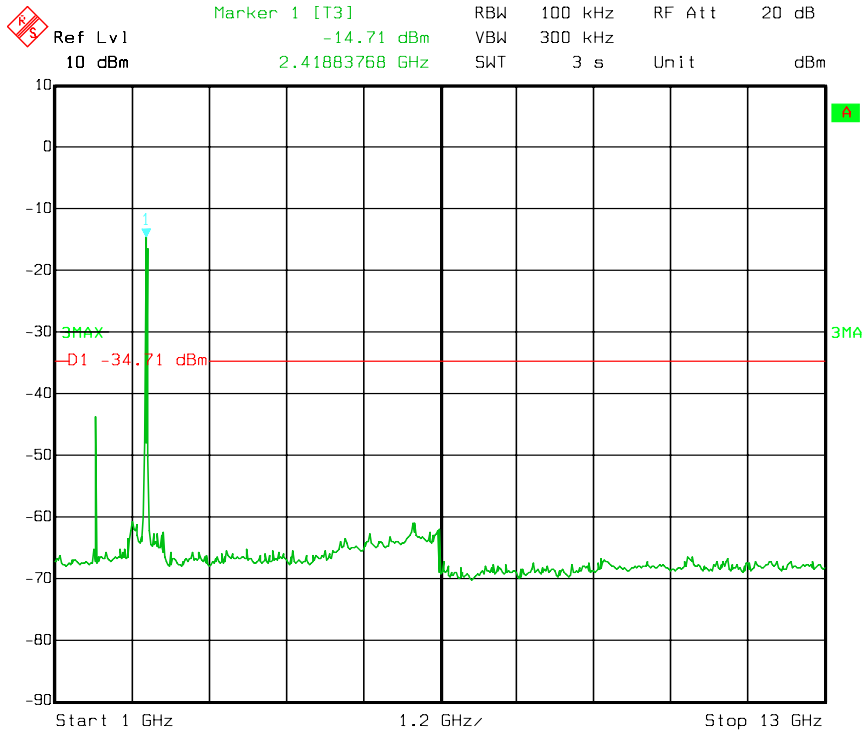
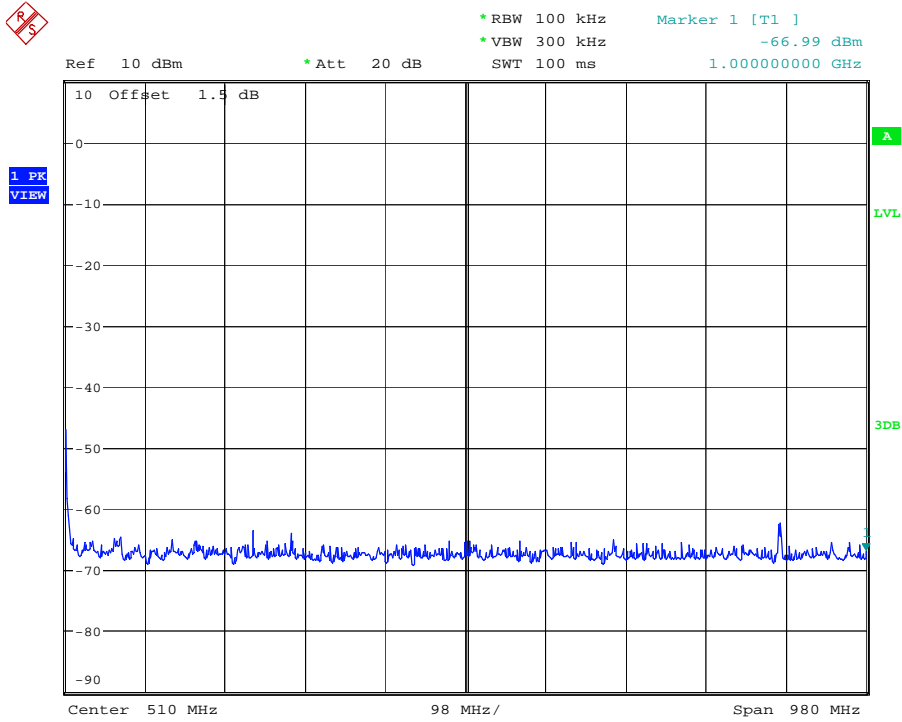

Note: Sweep points=1001pts

High channel

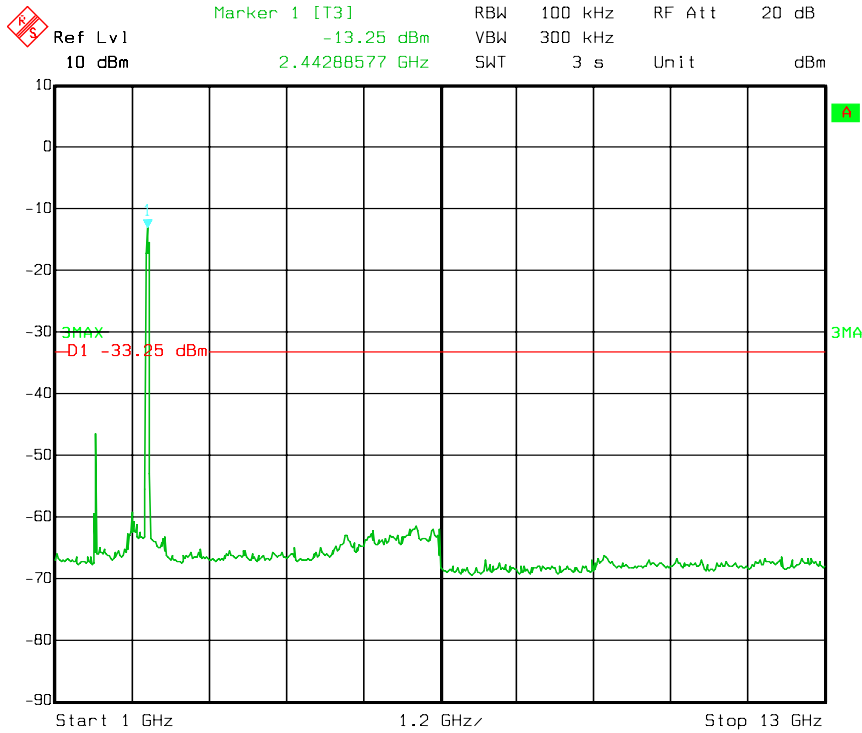
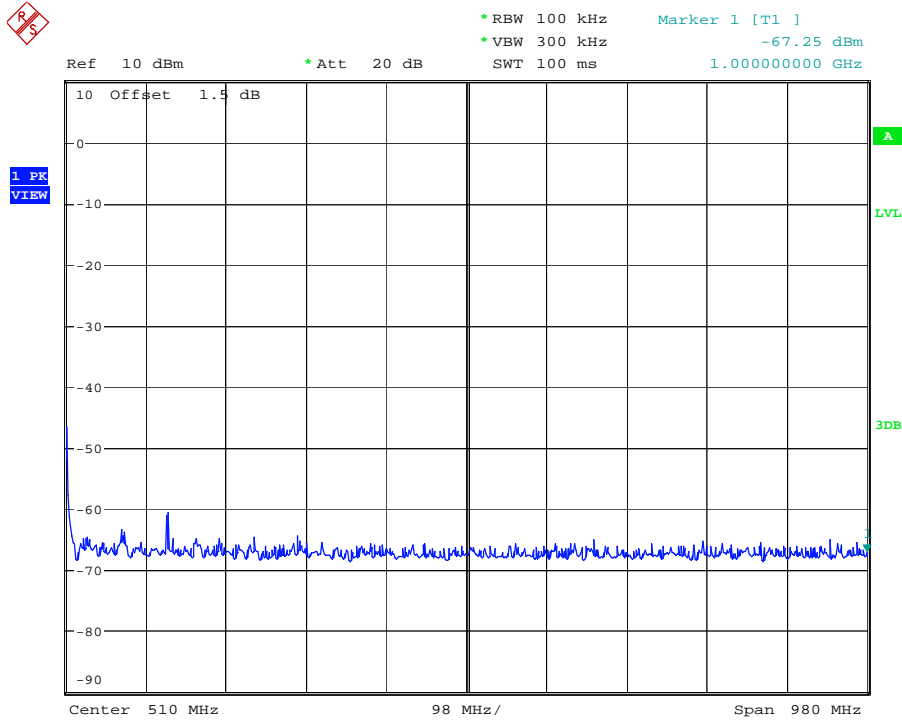

Note: Sweep points=1001pts

11.2 Radiated emissions Measurement

11.2.1 Test Method and test Procedure:

- 1) The EUT was tested according to ANSI C63.10 –2009.
- 2) The EUT, peripherals were put on the turntable which table size is 1m x 1.5 m, table high 0.8 m. All set up is according to ANSI C63.10-2009.
- 3) The frequency spectrum from 30 MHz to 25 GHz was investigated. All readings from 30 MHz to 1 GHz quasi-peak values with a resolution bandwidth of 120 kHz.
All readings are above 1 GHz, peak values with a resolution bandwidth of 1 MHz . Measurements were made at 3 meters.
Set the spectrum as follows:
 - 1): Peak: RBW=1MHz, VBW=1MHz, Sweep=Auto
 - 2): Average: RBW=1MHz, VBW=10Hz, Sweep=Auto
- 4) The antenna high is varied from 1 m to 4 m high to find the maximum emission for each frequency.
- 5) The antenna polarization: Vertical polarization and Horizontal polarization.

Block diagram of Test setup

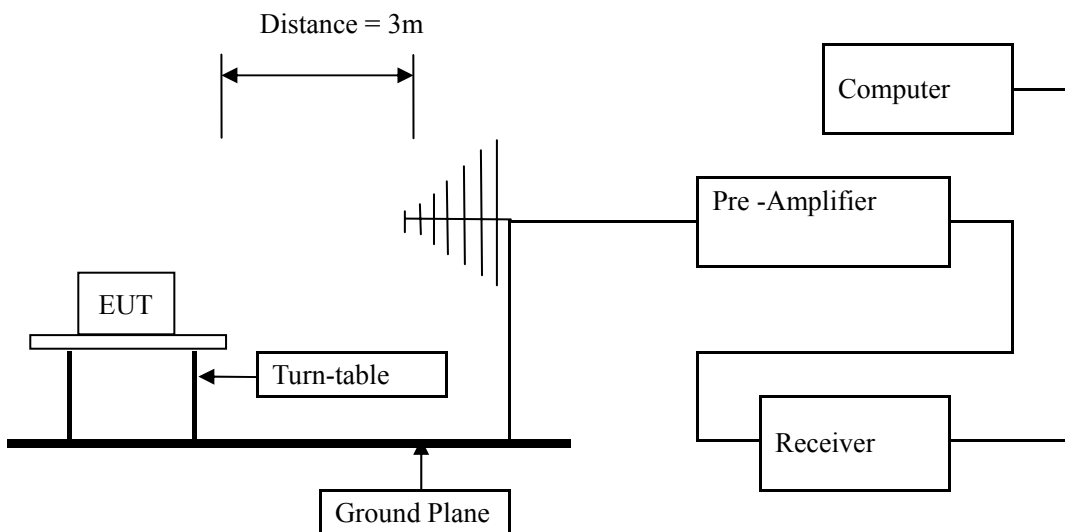

Block diagram of Test setup for frequency below 30MHz

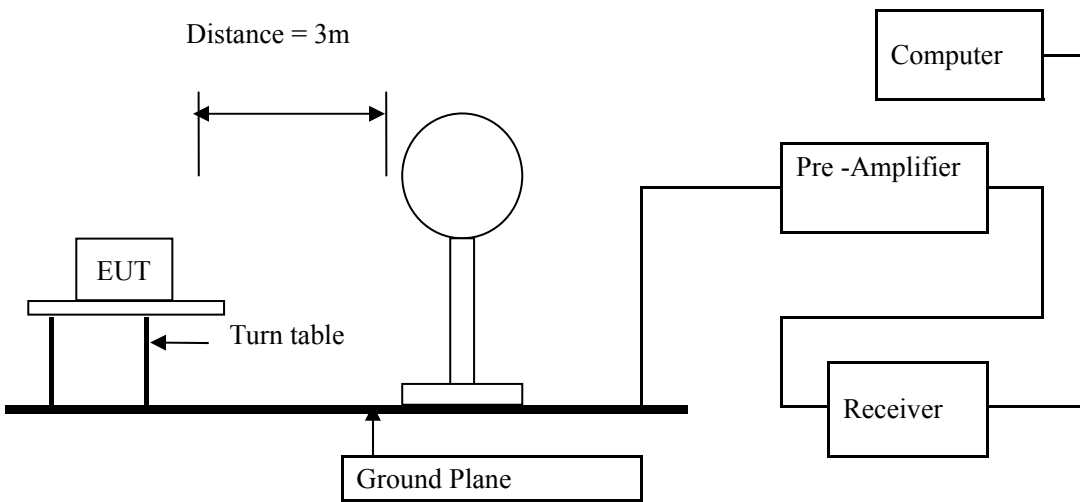

Block diagram of Test setup for frequency above 1GHz

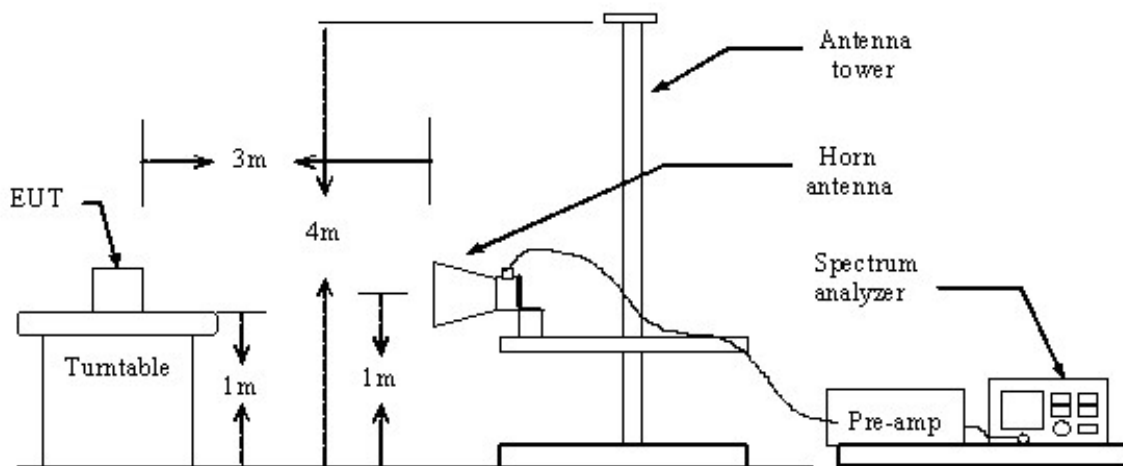

11.2.2 EUT Operating Condition

Operating condition is according to ANSI C63.10 -2009

11.2.3 Radiated Emission Limit

All emission from a digital device, including any network of conductors and apparatus connected thereto, shall not exceed the level of field strength specified below:

Frequencies in restricted band are complied to limit on Paragraph 15.209.

Frequency Range (MHz)	Distance (m)	Field strength (dB μ V/m)
0.009-0.490	3	20log 2400/F (kHz) + 80
0.490-1.705	3	20log 24000/F (kHz) + 40
1.705-30	3	20log 30 + 40
30-88	3	40.0
88-216	3	43.5
216-960	3	46.0
Above 960	3	54.0

- Note:
- 1) RF Voltage (dBuV) = 20 log RF Voltage (uV)
 - 2) In the Above Table, the tighter limit applies at the band edges.
 - 3) Distance refers to the distance in meters between the measuring instrument antenna and the EUT
 - 4) This is a handheld device. The radiated emissions should be tested under 3-axes position (Lying, Side, and Stand), After pre-test. It was found that the worse radiated emission was get at the lying position.
 - 5) All scanning using PK detector. And the final emission level was get using QP detector for frequency range from 30-1000MHz. As to 1G-25G, the final emission level got using PK and AV detector.
 - 6) If measurement is made at 3m distance, then F.S Limitation at 3m distance is adjusted by using the formula $Ld1 = Ld2 * (d2/d1)$
 - 7) The DTS rules specify that emissions which fall into restricted frequency bands shall comply with the general radiated emission limits.9

11.2.4 Test Equipment:

Instrument Type	Manufacturer	Model	Serial No.	Date of Cal.	Due Date
ESPI Test Receiver	ROHDE&SCHWARZ	ESPI 3	100379	July 2, 2014	July 1, 2015
Spectrum Analyzer	ROHDE&SCHWARZ	FSEM	848597/001	July 3, 2014	July 2, 2015
Pre-amplifier	Teseq	LNA6900	--	July 3, 2014	July 2, 2015
Pre-amplifier	Agilent	8447D	83153007374	July 3, 2014	July 2, 2015
Pre-amplifier	Agilent	8449B	3008A01738	July 3, 2014	July 2, 2015
Loop antenna	A.R.A.	PLA-1030/B	1029	July 3, 2014	July 2, 2015
Ultra Broadband ANT	ROHDE&SCHWARZ	HL562	100157	July 3, 2014	July 2, 2015
Horn Antenna	ETS LINDGREN	3117	--	July 3, 2014	July 2, 2015
Horn Antenna	ETS LINDGREN	3160	--	July 3, 2014	July 2, 2015

11.2.5 Test specification:

Environmental conditions: Temperature 22° C Humidity: 51% Atmospheric pressure: 103kPa

11.2.6 Test result

A Radiated Emission (9 kHz---30 MHz)

Note: 1) Emission Level=Reading+ Cable loss+ Antenna factor-Amp factor
2) The emission levels are 20 dB below the limit value, which are not reported. It is deemed to comply with the requirement

Result: Pass

Frequency (MHz)	Level@3m (dB μ V/m)	Limit@3m (dB μ V/m)
--	--	--
--	--	--
--	--	--
--	--	--

B General Radiated Emissions Data

Please refer to following diagram for individual

Radiated Emission In Horizontal (30MHz----1000MHz)

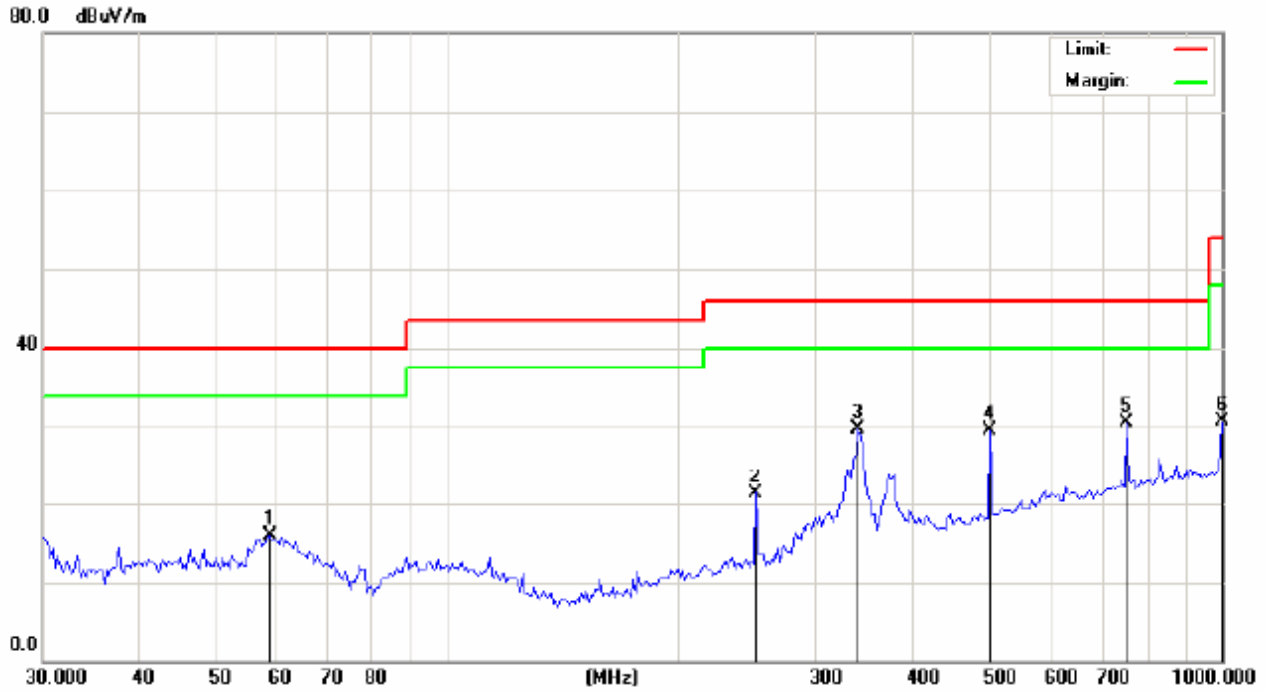

No.	Mk.	Freq. MHz	Reading Level dBuV	Correct Factor dB	Measure- ment dBuV/m	Limit dBuV/m	Over dB	Antenna Height cm	Table Degree degree	Comment
1		58.8980	29.48	-13.49	15.99	40.00	-24.01	peak	0	
2		250.4860	34.17	-12.77	21.40	46.00	-24.60	peak	0	
3		338.8546	40.29	-10.51	29.78	46.00	-16.22	peak	0	
4		502.2473	37.18	-7.66	29.52	46.00	-16.48	peak	0	
5	*	754.9628	34.57	-4.10	30.47	46.00	-15.53	peak	0	
6		1000.000	26.92	3.85	30.77	54.00	-23.23	peak	0	

Radiated Emission In Vertical (30MHz----1000MHz)



No. Mk.	Freq. MHz	Reading Level dBuV	Correct Factor dB	Measurement dBuV/m	Limit dBuV/m	Over dB	Detector	Antenna Height cm	Table Degree	Comment
1	37.5648	37.99	-13.29	24.70	40.00	-15.30	peak		0	
2	50.8172	38.22	-13.04	25.18	40.00	-14.82	peak		0	
3 *	83.1076	44.36	-16.62	27.74	40.00	-12.26	peak		0	
4	124.9250	40.00	-16.44	23.56	43.50	-19.94	peak		0	
5	371.2680	34.91	-9.98	24.93	46.00	-21.07	peak		0	
6	827.1795	30.58	-3.68	26.90	46.00	-19.10	peak		0	

Note: Measurements were conducted in all three channels (high, middle, low) with IEEE 802.11b mode, IEEE 802.11g mode, IEEE 802.11n(HT20), IEEE 802.11n(HT40), and the worst case (high channel in IEEE 802.11b mode) was submitted only.

C Fundamental & Harmonics Radiated Emission Data (1000MHz-25000MHz)

Operation mode tested for spurious emissions was the mode which delivered maximum spectral density 802.11b. all three modulations of EUT have been tested, but only show the worst case in this report, and we found the worst case is 802.11b.

IEEE 802.11b mode: Low channel: 2412 MHz									
Freq. (MHz)	Ant. Pol. H/V	Peak reading (dBuV)	AV reading (dBuV)	Correction Factor (dB)	Emission Level		Peak limit (dBuV/m)	AV limit (dBuV/m)	Margin (dB)
					Peak (dBuV/m)	AV (dBuV/m)			
2387.01	H	72.21	---	-4.20	68.01	---	74.00	54.00	-5.99
2387.01	H	---	53.51	-4.20	---	49.31	74.00	54.00	-4.69
4824.00	H	48.65	---	-3.94	44.71	---	74.00	54.00	-9.29
7236.00	H	48.01	---	0.52	48.53	---	74.00	54.00	-5.47
---	---	---	---	---	---	---	---	---	---
2387.01	V	71.24	---	-4.20	67.04	---	74.00	54.00	-6.96
2387.01	V	---	51.36	-4.20	---	47.16	74.00	54.00	-6.84
4824.00	V	49.65	---	-3.94	45.71	---	74.00	54.00	-8.29
7236.00	V	45.21	---	0.52	45.73	---	74.00	54.00	-8.27
---	---	---	---	---	---	---	---	---	---

Notes: 1) Measurements were conducted from 1 GHz to the 10th harmonic of highest fundamental frequency.

2) Radiated emissions measured in frequencies above 1GHz were made with peak detector and Average (AV) detector.

3) Average test would be performed if the peak readings were greater than the average limit.

4) Data of measurement shown “---“in the above table mean that the reading of emissions is attenuated more than 20 dB below the limits or the field strength is too small to be measured.

5) Emission Level=Peak (AV) Reading + Correction Factor;

Correction Factor= Antenna Factor + Cable loss – Pre-amplifier

6) Margin (dB) = Emission Level (Peak) (dBuV/m)-Average limit (dBuV/m)

IEEE 802.11b mode: Middle channel: 2437 MHz									
Freq. (MHz)	Ant. Pol. H/V	Peak reading (dBuV)	AV reading (dBuV)	Correction Factor (dB)	Emission Level		Peak limit (dBuV/m)	AV limit (dBuV/m)	Margin (dB)
					Peak (dBuV/m)	AV (dBuV/m)			
4874.00	H	47.65	---	-3.98	43.67	---	74.00	54.00	-10.33
7311.00	H	46.01	---	0.57	46.58	---	74.00	54.00	-7.42
---	---	---	---	---	---	---	---	---	---
4874.00	V	51.84	---	-3.98	47.86	---	74.00	54.00	-6.14
7311.00	V	48.29	---	0.57	48.86	---	74.00	54.00	-5.14
---	---	---	---	---	---	---	---	---	---

Notes: 1) Measurements were conducted from 1 GHz to the 10th harmonic of highest fundamental frequency.

2) Radiated emissions measured in frequencies above 1GHz were made with peak detector and Average (AV) detector.

3) Average test would be performed if the peak readings were greater than the average limit.

4) Data of measurement shown “---“in the above table mean that the reading of emissions is attenuated more than 20 dB below the limits or the field strength is too small to be measured.

5) Emission Level=Peak (AV) Reading + Correction Factor;

Correction Factor= Antenna Factor + Cable loss – Pre-amplifier

6) Margin (dB) = Emission Level (Peak) (dBuV/m)-Average limit (dBuV/m)

IEEE 802.11b mode: High channel: 2462 MHz									
Freq. (MHz)	Ant. Pol. H/V	Peak reading (dBuV)	AV reading (dBuV)	Correction Factor (dB)	Emission Level		Peak limit (dBuV/m)	AV limit (dBuV/m)	Margin (dB)
					Peak (dBuV/m)	AV (dBuV/m)			
2493.51	H	72.34	---	-2.38	69.96	---	74.00	54.00	-4.04
2493.51	H	---	52.54	-2.38	---	50.14	74.00	54.00	-3.86
4924.00	H	72.34	---	-3.98	68.36	---	74.00	54.00	-5.64
4924.00	H	---	52.54	-3.98	---	48.56	74.00	54.00	-5.44
7386.00	H	48.33	---	0.57	48.90	---	74.00	54.00	-5.10
---	---	---	---	---	---	---	---	---	---
2493.51	H	72.21	---	-2.38	69.83	---	74.00	54.00	-4.17
2493.51	H	---	51.31	-2.38	---	48.93	74.00	54.00	-5.07
4924.00	V	53.05	---	-3.98	49.07	---	74.00	54.00	-4.93
7386.00	V	48.15	---	0.57	48.72	---	74.00	54.00	-5.28
---	---	---	---	---	---	---	---	---	---

Notes: 1) Measurements were conducted from 1 GHz to the 10th harmonic of highest fundamental frequency.

2) Radiated emissions measured in frequencies above 1GHz were made with peak detector and Average (AV) detector.

3) Average test would be performed if the peak readings were greater than the average limit.

4) Data of measurement shown “---“in the above table mean that the reading of emissions is attenuated more than 20 dB below the limits or the field strength is too small to be measured.

5) Emission Level=Peak (AV) Reading + Correction Factor;

Correction Factor= Antenna Factor + Cable loss – Pre-amplifier

6) Margin (dB) = Emission Level (Peak) (dBuV/m)-Average limit (dBuV/m)

12.0 Antenna Requirement

12.1 Standard Applicable

For intentional device, according to FCC 47 CFR Section 15.203, an intentional radiator shall be designed to ensure that no antenna other than that furnished by the responsible party shall be used with the device.

And according to FCC 47 CFR Section 15.247 (b), if transmitter antennas of directional gain greater than 6 dBi are used, the power shall be reduced by the amount in dB that the directional gain of the antenna exceeds 6 dBi.

12.2 Antenna Specification

According to the manufacturer declared, the EUT has two reverse-polarity SMA; the directional gain of antenna is 5 dBi, and a WIFI internal antenna which antenna gain is 2.7dBi. A reverse SMA connector is considered unique.

Therefore the EUT is considered sufficient to comply with the provision.

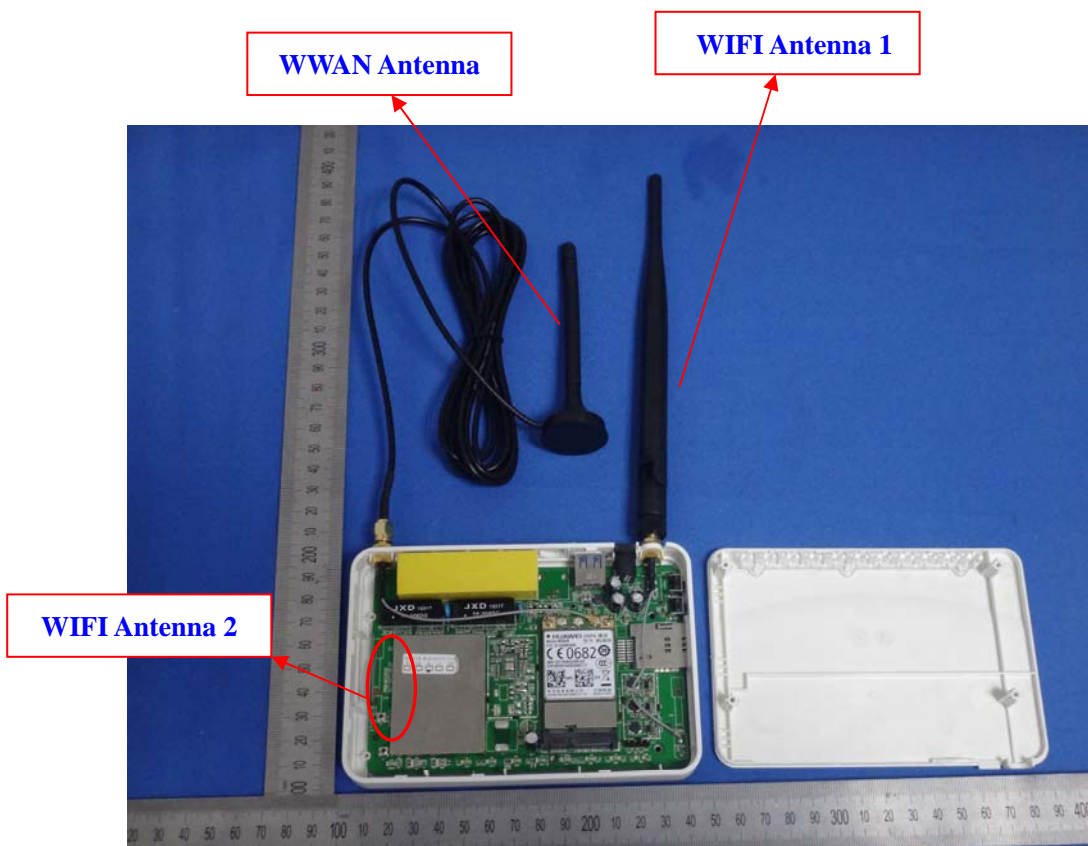

****END OF REPORT****