



# **CERTIFICATION TEST REPORT**

**Report Number. :** 11792114-E1V2

**Applicant :** APPLE, INC.  
1 INFINITE LOOP  
CUPERTINO, CA 95014, U.S.A.

**Model :** A1865, A1903

**FCC ID :** BCG-E3161A

**IC :** 579C-E3161A

**EUT Description :** SMARTPHONE

**Test Standard(s) :** FCC 47 CFR PART 15 SUBPART C  
INDUSTRY CANADA RSS - 247 ISSUE 2

**Date Of Issue:**  
August 28, 2017

**Prepared by:**  
UL Verification Services Inc.  
47173 Benicia Street  
Fremont, CA 94538, U.S.A.  
TEL: (510) 771-1000  
FAX: (510) 661-0888



NVLAP LAB CODE 200065-0

---

Revision History

<u>Rev.</u>	<u>Issue Date</u>	<u>Revisions</u>	<u>Revised By</u>
V1	8/23/2017	Initial Review	Tri Pham
V2	8/28/2017	Address TCB's Questions	Chin Pang

## TABLE OF CONTENTS

<b>1. ATTESTATION OF TEST RESULTS .....</b>	<b>7</b>
<b>2. TEST METHODOLOGY .....</b>	<b>8</b>
<b>3. FACILITIES AND ACCREDITATION .....</b>	<b>8</b>
<b>4. CALIBRATION AND UNCERTAINTY .....</b>	<b>9</b>
4.1. MEASURING INSTRUMENT CALIBRATION .....	9
4.2. SAMPLE CALCULATION .....	9
4.3. MEASUREMENT UNCERTAINTY.....	9
<b>5. EQUIPMENT UNDER TEST.....</b>	<b>10</b>
5.1. DESCRIPTION OF EUT .....	10
5.2. DIFFERENCE IN MODEL NUMBER.....	10
5.3. MAXIMUM OUTPUT POWER.....	10
5.4. DESCRIPTION OF AVAILABLE ANTENNAS .....	10
5.5. SOFTWARE AND FIRMWARE.....	10
5.6. WORST-CASE CONFIGURATION AND MODE.....	11
5.7. DESCRIPTION OF TEST SETUP.....	12
<b>6. TEST AND MEASUREMENT EQUIPMENT .....</b>	<b>17</b>
<b>7. MEASUREMENT METHODS .....</b>	<b>18</b>
<b>8. ANTENNA PORT TEST RESULTS.....</b>	<b>19</b>
8.1. UAT 1, Pmax BASIC DATA RATE GFSK MODULATION.....	21
8.1.1. 20 dB AND 99% BANDWIDTH .....	21
8.1.2. HOPPING FREQUENCY SEPARATION .....	24
8.1.3. NUMBER OF HOPPING CHANNELS.....	25
8.1.4. AVERAGE TIME OF OCCUPANCY .....	28
8.1.5. OUTPUT POWER .....	32
8.1.6. AVERAGE POWER .....	33
8.1.7. CONDUCTED SPURIOUS EMISSIONS.....	34
8.2. UAT 1, Pmax ENHANCED DATA RATE DQPSK MODULATION.....	39
8.2.1. OUTPUT POWER .....	39
8.2.2. AVERAGE POWER.....	40
8.3. UAT 1, Pmax ENHANCED DATA RATE 8PSK MODULATION.....	41
8.3.1. 20 dB AND 99% BANDWIDTH .....	41
8.3.2. HOPPING FREQUENCY SEPARATION .....	44
8.3.3. NUMBER OF HOPPING CHANNELS.....	45
8.3.4. AVERAGE TIME OF OCCUPANCY .....	48
8.3.5. OUTPUT POWER .....	52
8.3.6. AVERAGE POWER.....	53

8.3.7.	CONDUCTED SPURIOUS EMISSIONS.....	54
8.4.	<i>UAT 1, P<sub>low</sub> BASIC DATA RATE GFSK MODULATION</i> .....	59
8.4.1.	20 dB AND 99% BANDWIDTH .....	59
8.4.2.	HOPPING FREQUENCY SEPARATION .....	62
8.4.3.	NUMBER OF HOPPING CHANNELS.....	63
8.4.4.	AVERAGE TIME OF OCCUPANCY .....	66
8.4.5.	OUTPUT POWER .....	70
8.4.6.	AVERAGE POWER.....	71
8.4.7.	CONDUCTED SPURIOUS EMISSIONS.....	72
8.5.	<i>UAT 1, P<sub>low</sub> ENHANCED DATA RATE DQPSK MODULATION</i> .....	77
8.5.1.	OUTPUT POWER .....	77
8.5.2.	AVERAGE POWER.....	78
8.6.	<i>UAT 1, P<sub>low</sub> ENHANCED DATA RATE 8PSK MODULATION</i> .....	79
8.6.1.	20 dB AND 99% BANDWIDTH .....	79
8.6.2.	HOPPING FREQUENCY SEPARATION .....	82
8.6.3.	NUMBER OF HOPPING CHANNELS.....	83
8.6.4.	AVERAGE TIME OF OCCUPANCY .....	86
8.6.5.	OUTPUT POWER .....	90
8.6.6.	AVERAGE POWER.....	91
8.6.7.	CONDUCTED SPURIOUS EMISSIONS.....	92
8.7.	<i>LAT 3, P<sub>max</sub> BASIC DATA RATE GFSK MODULATION</i> .....	97
8.7.1.	20 dB AND 99% BANDWIDTH .....	97
8.7.2.	HOPPING FREQUENCY SEPARATION .....	100
8.7.3.	NUMBER OF HOPPING CHANNELS.....	101
8.7.4.	AVERAGE TIME OF OCCUPANCY .....	104
8.7.5.	OUTPUT POWER .....	108
8.7.6.	AVERAGE POWER.....	109
8.7.7.	CONDUCTED SPURIOUS EMISSIONS.....	110
8.8.	<i>LAT 3, P<sub>max</sub> ENHANCED DATA RATE DQPSK MODULATION</i> .....	115
8.8.1.	OUTPUT POWER .....	115
8.8.2.	AVERAGE POWER.....	116
8.9.	<i>LAT 3, P<sub>max</sub> ENHANCED DATA RATE 8PSK MODULATION</i> .....	117
8.9.1.	20 dB AND 99% BANDWIDTH .....	117
8.9.2.	HOPPING FREQUENCY SEPARATION .....	120
8.9.3.	NUMBER OF HOPPING CHANNELS.....	121
8.9.4.	AVERAGE TIME OF OCCUPANCY .....	124
8.9.5.	OUTPUT POWER .....	128
8.9.6.	AVERAGE POWER.....	129
8.9.7.	CONDUCTED SPURIOUS EMISSIONS.....	130
8.10.	<i>LAT 3, P<sub>low</sub> BASIC DATA RATE GFSK MODULATION</i> .....	135
8.10.1.	20 dB AND 99% BANDWIDTH.....	135
8.10.2.	HOPPING FREQUENCY SEPARATION.....	138
8.10.3.	NUMBER OF HOPPING CHANNELS .....	139
8.10.4.	AVERAGE TIME OF OCCUPANCY .....	142
8.10.5.	OUTPUT POWER.....	146
8.10.6.	AVERAGE POWER .....	147
8.10.7.	CONDUCTED SPURIOUS EMISSIONS .....	148
8.11.	<i>LAT 3, P<sub>low</sub> ENHANCED DATA RATE DQPSK MODULATION</i> .....	153
8.11.1.	OUTPUT POWER.....	153

8.11.2.	AVERAGE POWER .....	154
8.12.	<i>LAT 3, P<sub>low</sub> ENHANCED DATA RATE 8PSK MODULATION</i> .....	155
8.12.1.	20 dB AND 99% BANDWIDTH.....	155
8.12.2.	HOPPING FREQUENCY SEPARATION.....	158
8.12.3.	NUMBER OF HOPPING CHANNELS .....	159
8.12.4.	AVERAGE TIME OF OCCUPANCY .....	162
8.12.5.	OUTPUT POWER.....	166
8.12.6.	AVERAGE POWER .....	167
8.12.7.	CONDUCTED SPURIOUS EMISSIONS .....	168
<b>9.</b>	<b>RADIATED TEST RESULTS.....</b>	<b>173</b>
9.1.	<i>LIMITS AND PROCEDURE</i> .....	173
9.2.	<i>UAT 1, P<sub>max</sub> BASIC DATA RATE GFSK MODULATION</i> .....	174
9.2.1.	RESTRICTED BANDEDGE (LOW CHANNEL).....	174
9.2.2.	AUTHORIZED BANDEDGE (HIGH CHANNEL).....	176
9.2.3.	HARMONICS AND SPURIOUS EMISSIONS .....	178
9.3.	<i>UAT 1, P<sub>max</sub> ENHANCED DATA RATE 8PSK MODULATION</i> .....	184
9.3.1.	RESTRICTED BANDEDGE (LOW CHANNEL).....	184
9.3.2.	AUTHORIZED BANDEDGE (HIGH CHANNEL).....	186
9.3.3.	HARMONICS AND SPURIOUS EMISSIONS .....	188
9.4.	<i>UAT 1, P<sub>low</sub> BASIC DATA RATE GFSK MODULATION</i> .....	194
9.4.1.	RESTRICTED BANDEDGE (LOW CHANNEL).....	194
9.4.2.	AUTHORIZED BANDEDGE (HIGH CHANNEL).....	196
9.4.3.	HARMONICS AND SPURIOUS EMISSIONS .....	198
9.5.	<i>UAT 1, P<sub>low</sub> ENHANCED DATA RATE 8PSK MODULATION</i> .....	204
9.5.1.	RESTRICTED BANDEDGE (LOW CHANNEL).....	204
9.5.2.	AUTHORIZED BANDEDGE (HIGH CHANNEL).....	206
9.5.3.	HARMONICS AND SPURIOUS EMISSIONS .....	208
9.6.	<i>LAT 3, P<sub>max</sub> BASIC DATA RATE GFSK MODULATION</i> .....	214
9.6.1.	RESTRICTED BANDEDGE (LOW CHANNEL).....	214
9.6.2.	AUTHORIZED BANDEDGE (HIGH CHANNEL).....	216
9.6.3.	HARMONICS AND SPURIOUS EMISSIONS .....	218
9.7.	<i>LAT 3, P<sub>max</sub> ENHANCED DATA RATE 8PSK MODULATION</i> .....	224
9.7.1.	RESTRICTED BANDEDGE (LOW CHANNEL).....	224
9.7.2.	AUTHORIZED BANDEDGE (HIGH CHANNEL).....	226
9.7.3.	HARMONICS AND SPURIOUS EMISSIONS .....	228
9.8.	<i>LAT 3, P<sub>low</sub> BASIC DATA RATE GFSK MODULATION</i> .....	234
9.8.1.	RESTRICTED BANDEDGE (LOW CHANNEL).....	234
9.8.2.	AUTHORIZED BANDEDGE (HIGH CHANNEL).....	236
9.8.3.	HARMONICS AND SPURIOUS EMISSIONS .....	238
9.9.	<i>LAT 3, P<sub>low</sub> ENHANCED DATA RATE 8PSK MODULATION</i> .....	244
9.9.1.	RESTRICTED BANDEDGE (LOW CHANNEL).....	244
9.9.2.	AUTHORIZED BANDEDGE (HIGH CHANNEL).....	246
9.9.3.	HARMONICS AND SPURIOUS EMISSIONS .....	248
9.10.	<i>WORST-CASE BELOW 1 GHz</i> .....	254
9.11.	<i>WORST-CASE ABOVE 18 GHz</i> .....	256
<b>10.</b>	<b>AC POWER LINE CONDUCTED EMISSIONS .....</b>	<b>258</b>

---

10.1.	<i>EUT POWERED BY AC/DC ADAPTER VIA USB CABLE.....</i>	<i>259</i>
10.2.	<i>EUT POWERED BY HOST PC VIA USB CABLE.....</i>	<i>261</i>
10.3.	<i>SETUP PHOTOS.....</i>	<i>263</i>

# 1. ATTESTATION OF TEST RESULTS

**COMPANY NAME:** APPLE, INC.  
1 INFINITE LOOP  
CUPERTINO, CA 95014, U.S.A

**EUT DESCRIPTION:** SMARTPHONE

**MODEL:** A1865, A1903

**SERIAL NUMBER:** C39TX02KJ8PT

**DATE TESTED:** MAY 23, 2017 – JULY 29, 2017

APPLICABLE STANDARDS	
STANDARD	TEST RESULTS
CFR 47 Part 15 Subpart C	Pass
INDUSTRY CANADA RSS-247 Issue 2	Pass
INDUSTRY CANADA RSS-GEN Issue 4	Pass

UL Verification Services Inc. tested the above equipment in accordance with the requirements set forth in the above standards. All indications of Pass/Fail in this report are opinions expressed by UL Verification Services Inc. based on interpretations and/or observations of test results. Measurement Uncertainties were not taken into account and are published for informational purposes only. The test results show that the equipment tested is capable of demonstrating compliance with the requirements as documented in this report.

**Note:** The results documented in this report apply only to the tested sample, under the conditions and modes of operation as described herein. This document may not be altered or revised in any way unless done so by UL Verification Services Inc. and all revisions are duly noted in the revisions section. Any alteration of this document not carried out by UL Verification Services Inc. will constitute fraud and shall nullify the document. This report must not be used by the client to claim product certification, approval, or endorsement by NVLAP, NIST, any agency of the Federal Government, or any agency of any government.

Approved & Released For  
UL Verification Services Inc. By:



Chin Pang  
Senior Engineer  
UL VERIFICATION SERVICES INC.

Prepared By:



Tri Pham  
Test Engineer  
UL VERIFICATION SERVICES INC.

## 2. TEST METHODOLOGY

The tests documented in this report were performed in accordance with FCC CFR 47 Part 2, FCC CFR 47 Part 15, ANSI C63.10-2013, RSS-GEN Issue 4, and RSS-247 Issue 2.

## 3. FACILITIES AND ACCREDITATION

The test sites and measurement facilities used to collect data are located at 47173 and 47266 Benicia Street, Fremont, California, USA. Line conducted emissions are measured only at the 47173 address. The following table identifies which facilities were utilized for radiated emission measurements documented in this report. Specific facilities are also identified in the test results sections.

47173 Benicia Street	47266 Benicia Street
<input type="checkbox"/> Chamber A (IC:2324B-1)	<input checked="" type="checkbox"/> Chamber D (IC: 22541-1)
<input type="checkbox"/> Chamber B (IC:2324B-2)	<input checked="" type="checkbox"/> Chamber E (IC: 22541-2)
<input type="checkbox"/> Chamber C (IC:2324B-3)	<input checked="" type="checkbox"/> Chamber F (IC: 22541-3)
	<input type="checkbox"/> Chamber G (IC: 22541-4)
	<input checked="" type="checkbox"/> Chamber H (IC: 22541-5)

The above test sites and facilities are covered under FCC Test Firm Registration # 208313.

UL Verification Services Inc. is accredited by NVLAP, Laboratory Code 200065-0. The full scope of accreditation can be viewed at <http://ts.nist.gov/standards/scopes/2000650.htm>.



## 4. CALIBRATION AND UNCERTAINTY

### 4.1. MEASURING INSTRUMENT CALIBRATION

The measuring equipment utilized to perform the tests documented in this report has been calibrated in accordance with the manufacturer's recommendations, and is traceable to recognized national standards.

### 4.2. SAMPLE CALCULATION

Where relevant, the following sample calculation is provided:

$$\begin{aligned} \text{Field Strength (dBuV/m)} &= \text{Measured Voltage (dBuV)} + \text{Antenna Factor (dB/m)} + \\ &\text{Cable Loss (dB)} - \text{Preamp Gain (dB)} \\ 36.5 \text{ dBuV} + 18.7 \text{ dB/m} + 0.6 \text{ dB} - 26.9 \text{ dB} &= 28.9 \text{ dBuV/m} \end{aligned}$$

### 4.3. MEASUREMENT UNCERTAINTY

Where relevant, the following measurement uncertainty levels have been estimated for tests performed on the apparatus:

Parameter	Uncertainty
Worst Case Conducted Disturbance, 9KHz to 0.15 MHz	3.84 dB
Worst Case Conducted Disturbance, 0.15 to 30 MHz	3.65 dB
Worst Case Radiated Disturbance, 9KHz to 30 MHz	3.15 dB
Worst Case Radiated Disturbance, 30 to 1000 MHz	5.36 dB
Worst Case Radiated Disturbance, 1000 to 18000 MHz	4.32 dB
Worst Case Radiated Disturbance, 18000 to 26000 MHz	4.45 dB
Worst Case Radiated Disturbance, 26000 to 40000 MHz	5.24 dB
Occupied Channel Bandwidth	±0.39 %
Time	±0.02 %

Uncertainty figures are valid to a confidence level of 95%.

## 5. EQUIPMENT UNDER TEST

### 5.1. DESCRIPTION OF EUT

The Equipment under Test is a mobile phone with GSM, GPRS, EGPRS, UMTS, LTE, TD-SCDMA and CDMA technologies. It also supports IEEE 802.11a/b/g/n/ac, Bluetooth®, GPS and NFC. The device has a built-in inductive charging receiver which is not user accessible. The rechargeable battery is not user accessible.

### 5.2. DIFFERENCE IN MODEL NUMBER

A1865 and A1903 are exactly the same. Two models numbers are allocated for marketing and logistic purpose only.

### 5.3. MAXIMUM OUTPUT POWER

The transmitter has a maximum peak conducted output power as follows:

Antenna	Config	Frequency Range (MHz)	Mode	Output Power (dBm)	Output Power (mW)
UAT 1	Pmax	2402 - 2480	Basic GFSK	20.25	105.93
		2402 - 2480	DQPSK	19.71	93.54
		2402 - 2480	Enhanced 8PSK	19.80	95.50
	Plow	2402 - 2480	Basic GFSK	10.20	10.47
		2402 - 2480	DQPSK	10.19	10.45
		2402 - 2480	Enhanced 8PSK	10.25	10.59
LAT 3	Pmax	2402 - 2480	Basic GFSK	20.21	104.95
		2402 - 2480	DQPSK	20.22	105.20
		2402 - 2480	Enhanced 8PSK	20.23	105.44
	Plow	2402 - 2480	Basic GFSK	10.23	10.54
		2402 - 2480	DQPSK	10.67	11.67
		2402 - 2480	Enhanced 8PSK	10.75	11.89

### 5.4. DESCRIPTION OF AVAILABLE ANTENNAS

Frequency Band (GHz)	UAT 1(dBi)	LAT 3 (dBi)
2.4	-1.67	-4.42

### 5.5. SOFTWARE AND FIRMWARE

The firmware installed in the EUT during testing was version 15.1.40.176.

## 5.6. WORST-CASE CONFIGURATION AND MODE

Radiated band edge, harmonic, and spurious emissions from 1GHz to 18GHz were performed with the EUT set to transmit at highest power on Low/Middle/High channels.

Radiated emissions below 30MHz, below 1GHz, above 18GHz and power line conducted emissions were performed with the EUT transmits at the channel with the highest output power as worst-case scenario.

The fundamental of the EUT was investigated in three orthogonal orientations, X (Flatbed), Y (Landscape), and Z (Portrait), on both UAT 1 and LAT 3 antennas. In addition, the EUT was also investigated with and without AC/DC charger, headphones & laptop. It was determined that X (Flatbed) orientation was the worst-case orientation on both antennas without AC/DC charger, headphones, or laptop; therefore, all final radiated testing was performed with EUT only in X-orientation for 1 - 18GHz and 18 – 26GHz and for 30-1000MHz EUT was tested with AC/DC charger.

Worst-case data rates were:

GFSK mode: DH5  
8PSK mode: 3-DH5

DQPSK mode has been verified to have the lowest power.

For simultaneous transmission of multiple channels from the same antenna LAT 3 in the 2.4GHz BT and 5GHz bands, tests were conducted for various configurations having the highest power. No noticeable new emission was found.

There are two vendors of the WiFi/Bluetooth radio modules: variant 1 and variant 2. The WiFi/Bluetooth radio modules have the same mechanical outline (e.g., the same package dimension and pin-out layout), use the same on-board antenna matching circuit, have an identical antenna structure, and are built and tested to conform to the same specifications and to operate within the same tolerances.

Baseline testing was performed on the two variants to determine the worst case on all conducted power and radiated emissions.

## 5.7. DESCRIPTION OF TEST SETUP

### SUPPORT EQUIPMENT

Support Equipment List				
Description	Manufacturer	Model	Serial Number	FCC ID
Laptop AC/DC adapter	Apple	A1344	T1580	NA
Laptop	Apple	A1278	C02HJ0A7DTY4	NA
DC power supply	Lambda	GEN 60-25	SCPV56329	NA

### I/O CABLES (CONDUCTED TEST)

I/O Cable List						
Cable No	Port	# of identical ports	Connector Type	Cable Type	Cable Length (m)	Remarks
1	Antenna	1	SMA	Shielded	1	N/A
2	USB	1	USB	Shielded	1	Laptop to EUT
3	AC	1	AC	Un-shielded	3	N/A
4	Aligator clip	1	minigrabber	Un-Shielded	1	DC power supply to EUT

### I/O CABLES (RADIATED ABOVE 1 GHZ)

I/O Cable List						
Cable No	Port	# of identical ports	Connector Type	Cable Type	Cable Length (m)	Remarks
NA						

### I/O CABLES (AC POWER CONDUCTED TEST AND BELOW 1 GHZ)

I/O Cable List						
Cable No	Port	# of identical ports	Connector Type	Cable Type	Cable Length (m)	Remarks
1	AC	1	AC	Un-shielded	3	N/A

### I/O CABLES (AC LINE CONDUCTED: LAPTOP CONFIGUARTION)

I/O Cable List						
Cable No	Port	# of identical	Connector Type	Cable Type	Cable Length (m)	Remarks
1	AC	1	AC	Un-shielded	3	N/A
2	USB	1	USB	Shielded	1	N/A

**TEST SETUP**

The EUT was tested connected to a host Laptop via USB cable adapter and SMA cable connected to antenna port. Test software exercised the EUT.

**SETUP DIAGRAM**

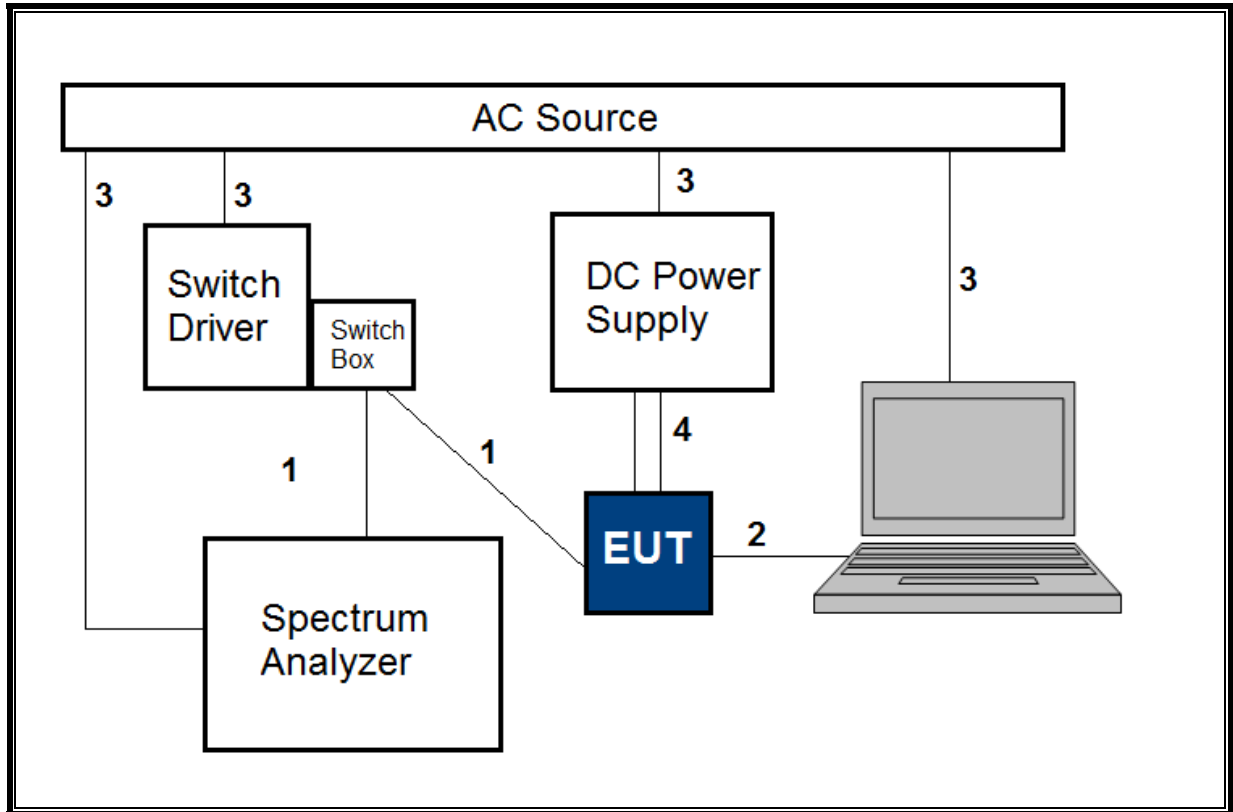

**TEST SETUP- RADIATED-ABOVE 1 GHZ**

The EUT was powered by battery. Test software exercised the EUT.

**SETUP DIAGRAM**

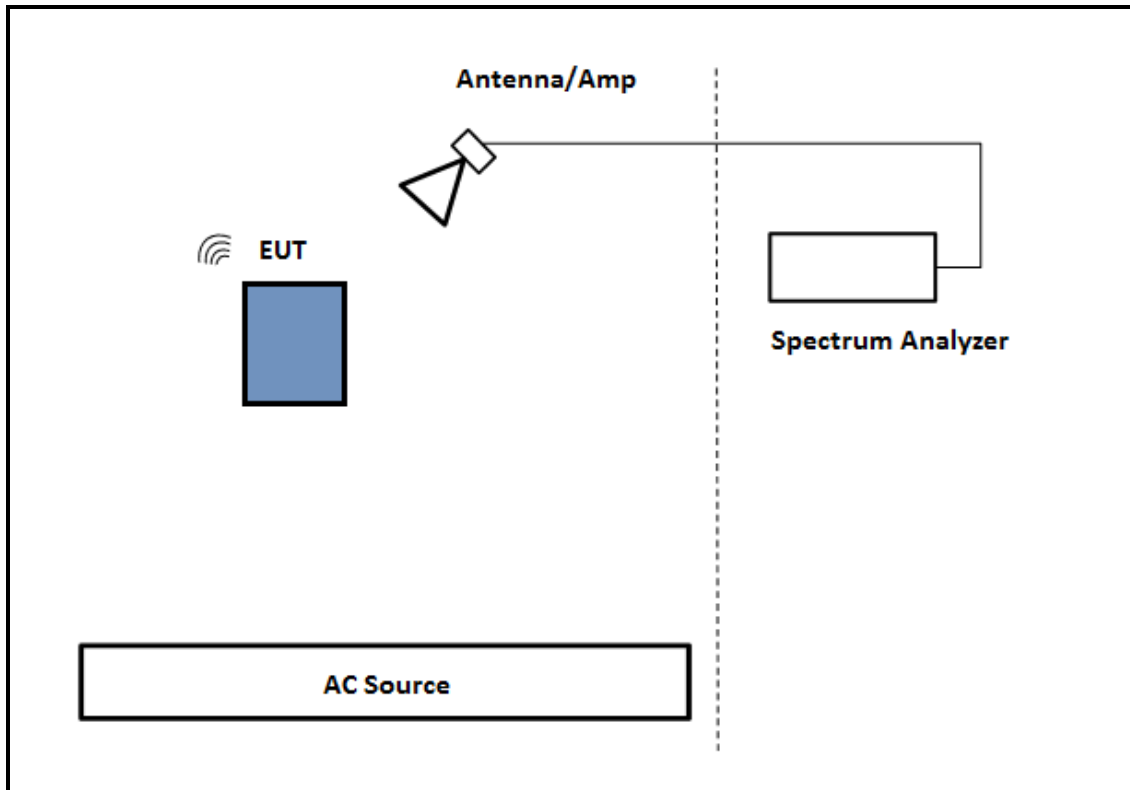

**TEST SETUP- BELOW 1GHZ & AC LINE CONDUCTED TESTS**

The EUT was powered by AC/DC adapter. Test software exercised the EUT.

**SETUP DIAGRAM**

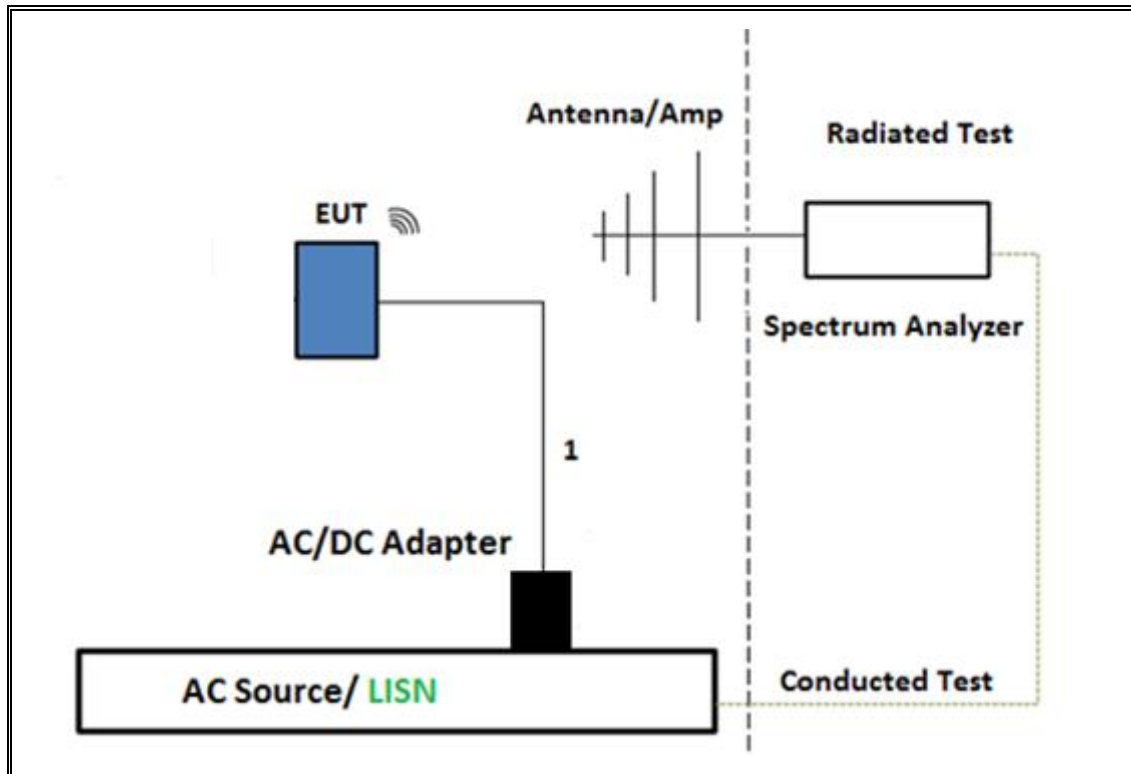

**TEST SETUP- AC LINE CONDUCTED TEST (LAPTOP CONFIGURATION)**

The EUT was tested connected to a host Laptop via USB cable. Test software exercised the EUT.

**SETUP DIAGRAM**

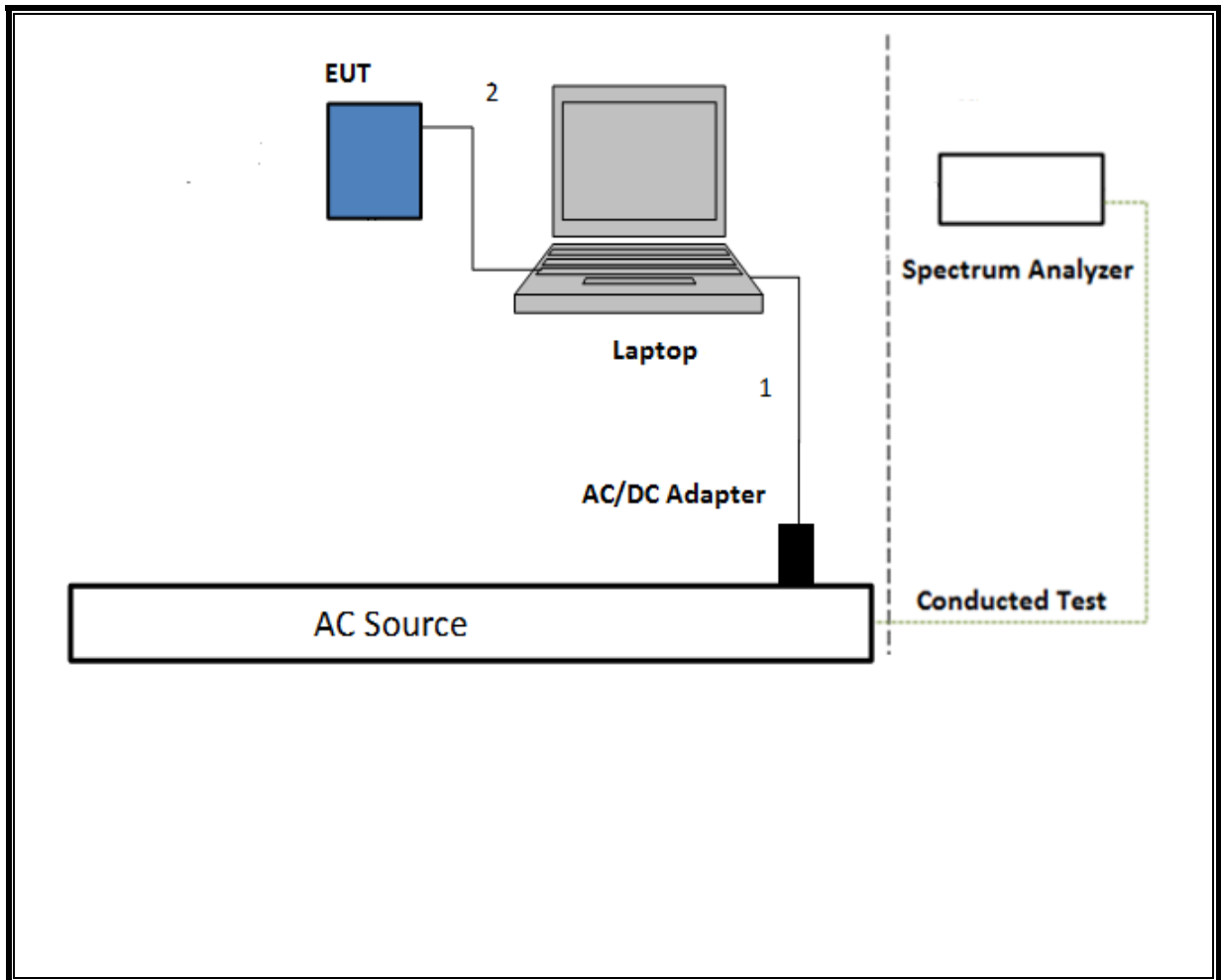



## 6. TEST AND MEASUREMENT EQUIPMENT

The following test and measurement equipment was utilized for the tests documented in this report:

TEST EQUIPMENT LIST				
Description	Manufacturer	Model	Asset	Cal Due
Antenna, Horn 1-18GHz	ETS Lindgren	3117	T862	4/20/2018
Amplifier, 1 to 18GHz	Miteq	AFS42-00101800-25-S-42	T740	11/29/17
Spectrum Analyzer, PXA 3Hz to 44GHz	Keysight	N9030A	T340	12/14/2017
Antenna, Horn 1-18GHz	ETS Lindgren	3117	T863	6/9/2018
Amplifier, 1 to 18GHz	Miteq	AFS42-00101800-25-S-42	T741	11/29/2017
Spectrum Analyzer, PXA 3Hz to 44GHz	Keysight	N9030A	T1113	12/20/2017
Antenna, Horn 1-18GHz	ETS Lindgren	3117	T119	3/28/2018
Amplifier, 1 to 18GHz	Miteq	AFS42-00101800-25-S-42	T742	11/29/2017
Spectrum Analyzer, PSA, 3Hz to 44GHz	Agilent (Keysight) Technologies	E4446A	T177	03/20/2018
Antenna, Horn 1-18GHz	ETS Lindgren	3117	T119	3/28/2018
Amplifier, 1 to 18GHz	Miteq	AFS42-00101800-25-S-42	T742	11/29/2017
*Pre-Amp 18-26GHz	Agilent Technology	8449B	T404	7/5/2017
*Antenna Horn, 18 to 26GHz	ARA	MWH-1826	T447	6/16/2017
Spectrum Analyzer, 40GHz	Agilent	8564E	T106	9/7/2017
Power Meter, P-series single channel	Keysight	N1912A	T1245	1/05/2018
Power Sensor	Keysight	N1921A	T750	10/1/2017
*Amplifier, 10KHz to 1GHz, 32dB	Sonoma	310N	T835	6/18/2017
Antenna, Broadband Hybrid, 30MHz to 2000MHz	Sunol Sciences	JB1	T185	3/30/2018
Spectrum Analyzer, PXA 3Hz to 44GHz	Keysight	N9030A-544	T341	10/25/2017
AC Line Conducted				
EMI Test Receiver 9KHz-7GHz	Rohde & Schwarz	ESCI7	T1436	1/6/2018
*LISN for Conducted Emissions CISPR-16	Fischer	50/250-25-2-01	T1310	06/08/2017
Power Cable, Line Conducted Emissions	UL	PG1	T861	9/1/2017
UL AUTOMATION SOFTWARE				
Radiated Software	UL	UL EMC	Ver 9.5, April 26, 2016	
Conducted Software	UL	UL EMC	Ver 5.4, October 13, 2016	
AC Line Conducted Software	UL	UL EMC	Ver 9.5, May 26, 2015	

NOTE: Equipment that calibrated during the testing period was set for test after the calibration.

\*Testing is completed before equipment expiration date.

## 7. MEASUREMENT METHODS

On Time and Duty Cycle: ANSI C63.10-2013 Section 11.6

Occupied BW (99%): ANSI C63.10-2013 Section 6.9.3

Carrier Frequency Separation: ANSI C63.10-2013 Section 7.8.2

Number of Hopping Frequencies: ANSI C63.10-2013 Section 7.8.3

Time of Occupancy (Dwell Time): ANSI C63.10-2013 Section 7.8.4

Peak Output Power: ANSI C63.10-2013 Section 7.8.5

Conducted Spurious Emissions: ANSI C63.10-2013 Section 7.8.8

Conducted Band-Edge: ANSI C63.10-2013 Section 6.10.4

Radiated Spurious Emissions 30-1000MHz: ANSI C63.10-2013 Section 6.3 and 6.5

Radiated Spurious Emissions above 1GHz: ANSI C63.10-2013 Section 6.3 and 6.6

Radiated Band-edge: ANSI C63.10-2013 Section 6.10.5

AC Power-line conducted emissions: ANSI C63.10-2013, Section 6.2.

## 8. ANTENNA PORT TEST RESULTS

### ON TIME AND DUTY CYCLE

#### LIMITS

None; for reporting purposes only.

#### PROCEDURE

ANSI C63.10, Section 11.6 : Zero-Span Spectrum Analyzer Method.

### ON TIME AND DUTY CYCLE RESULTS

Mode	ON Time B (msec)	Period (msec)	Duty Cycle x (linear)	Duty Cycle (%)	Duty Cycle Correction Factor (dB)	1/B Minimum VBW (khz)
GFSK	133.1	133.1	1.00	100%	0.00	0.010
8FSK	133.1	133.1	1.00	100%	0.00	0.010

**DUTY CYCLE PLOTS**

**HOPPING OFF**

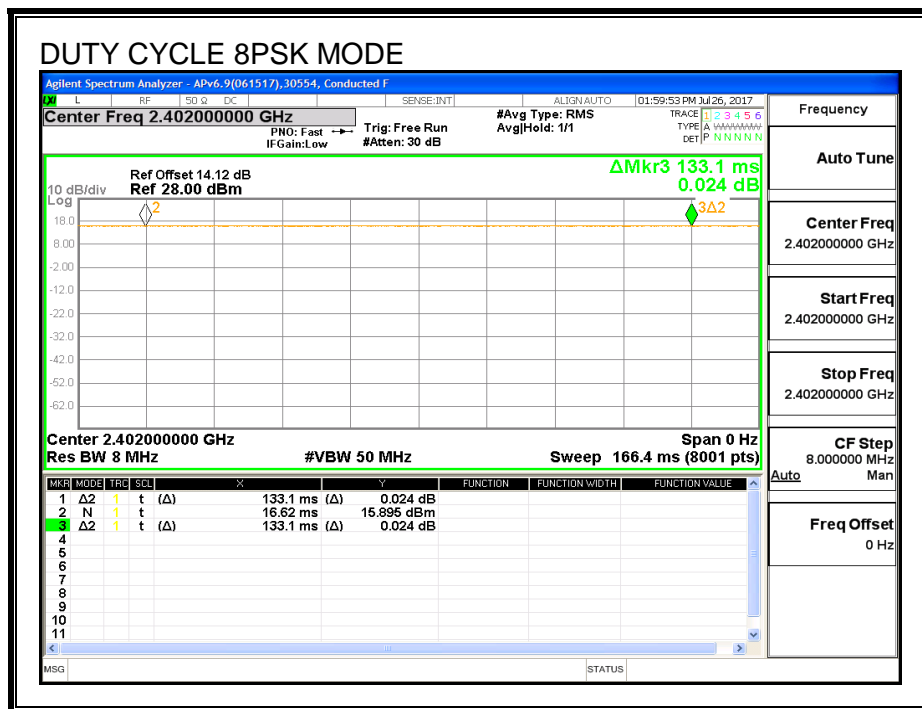
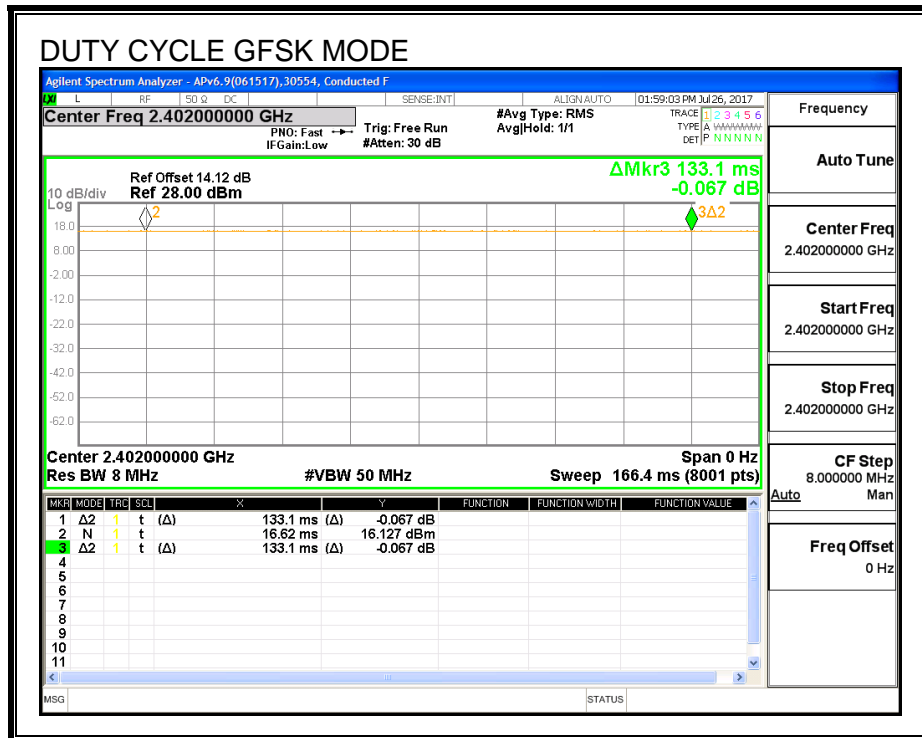

---

## 8.1. UAT 1, Pmax BASIC DATA RATE GFSK MODULATION

### 8.1.1. 20 dB AND 99% BANDWIDTH

#### LIMITS

None; for reporting purposes only.

#### TEST PROCEDURE

The transmitter output is connected to a spectrum analyzer. The RBW is set to  $\geq 1\%$  of the 20 dB bandwidth. The VBW is set to  $\geq$  RBW. The sweep time is coupled.

#### RESULTS

Channel	Frequency (MHz)	20 dB Bandwidth (KHz)	99% Bandwidth (KHz)
Low	2402	838.9	864.99
Middle	2441	853.0	862.57
High	2480	938.8	920.44

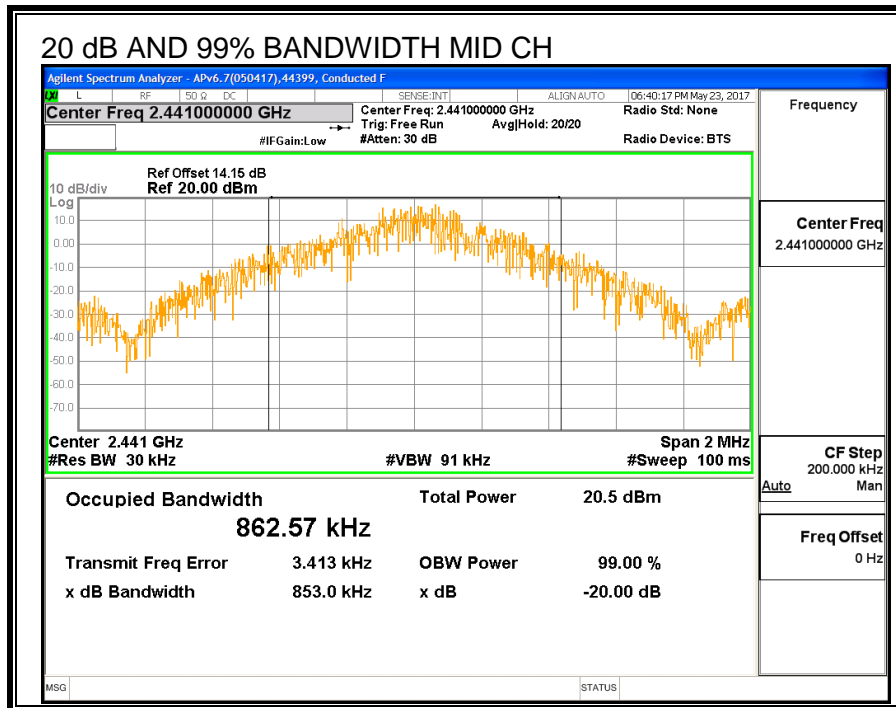
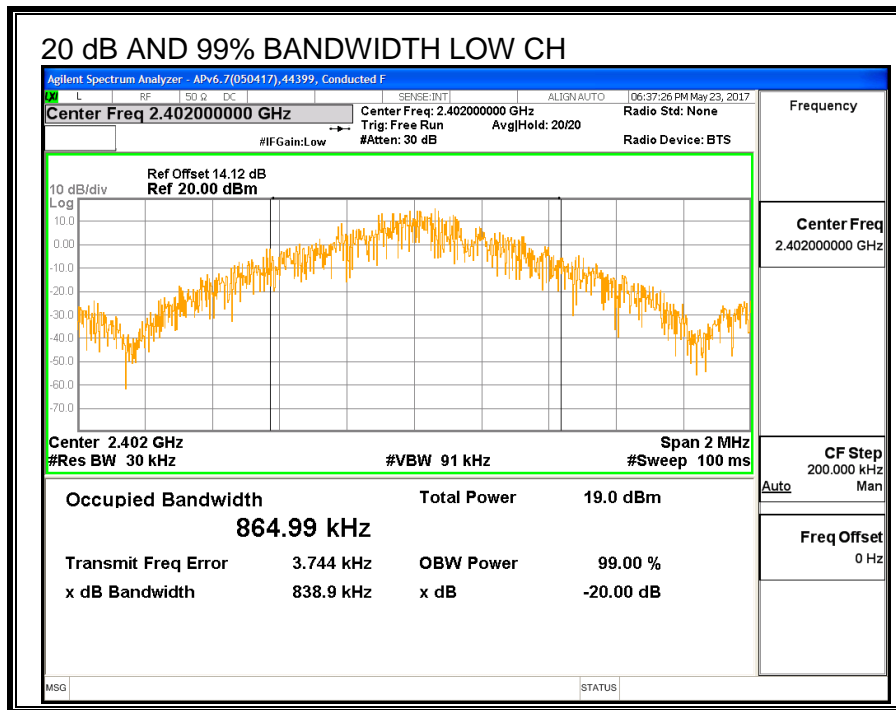

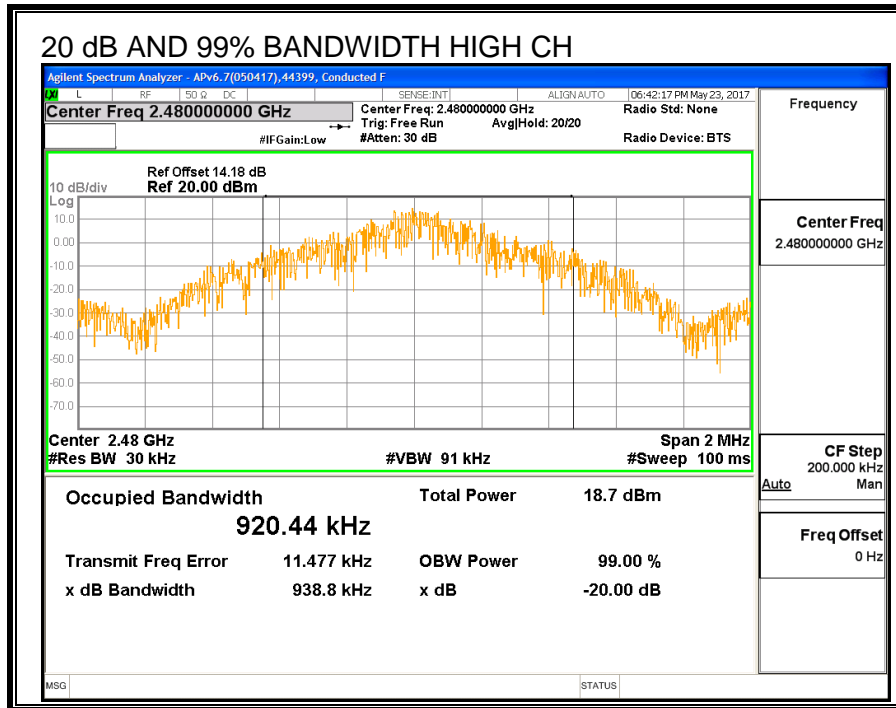

## 8.1.2. HOPPING FREQUENCY SEPARATION

### LIMITS

FCC §15.247 (a) (1)

IC RSS-247 (5.1) (b)

Frequency hopping systems shall have hopping channel carrier frequencies separated by a minimum of 25 kHz or the 20 dB bandwidth of the hopping channel, whichever is greater.

Alternatively, frequency hopping systems operating in the 2400-2483.5 MHz band may have hopping channel carrier frequencies that are separated by 25 kHz or two-thirds of the 20 dB bandwidth of the hopping channel, whichever is greater, provided the systems operate with an output power no greater than 125 mW.

### TEST PROCEDURE

The transmitter output is connected to a spectrum analyzer. The RBW is set to 300 kHz and the VBW is set to 910 kHz. The sweep time is coupled.

### RESULTS

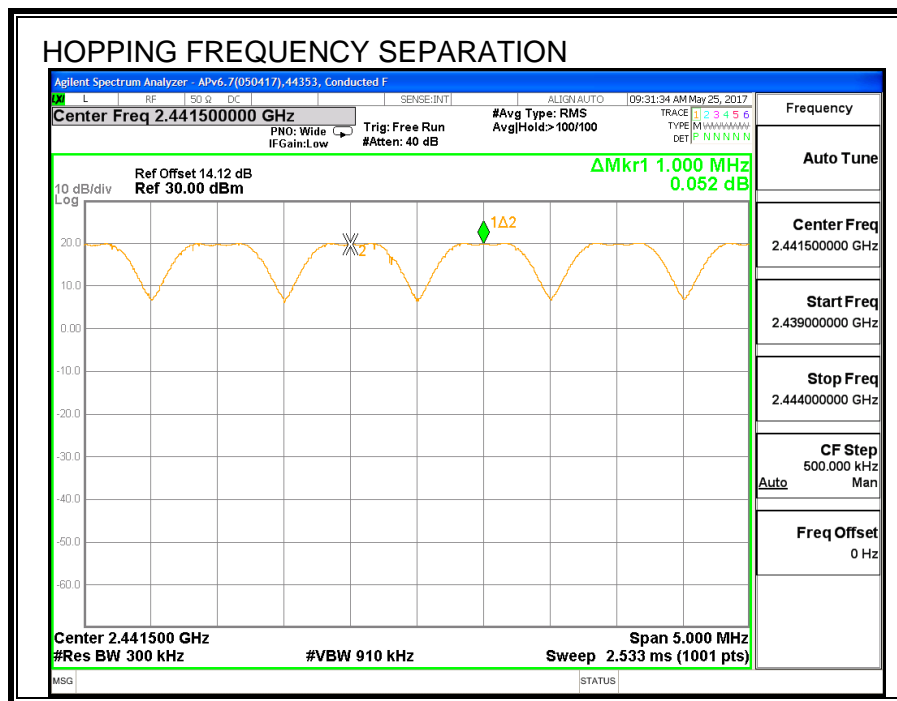



### 8.1.3. NUMBER OF HOPPING CHANNELS

#### LIMITS

FCC §15.247 (a) (1) (iii)

IC RSS-247 (5.1) (d)

Frequency hopping systems in the 2400 – 2483.5 MHz band shall use at least 15 non-overlapping channels.

#### TEST PROCEDURE

The transmitter output is connected to a spectrum analyzer. The span is set to cover the entire authorized band, in either a single sweep or in multiple contiguous sweeps. The RBW is set to a maximum of 1 % of the span. The analyzer is set to Max Hold.

#### RESULTS

Normal Mode: 79 Channels observed.

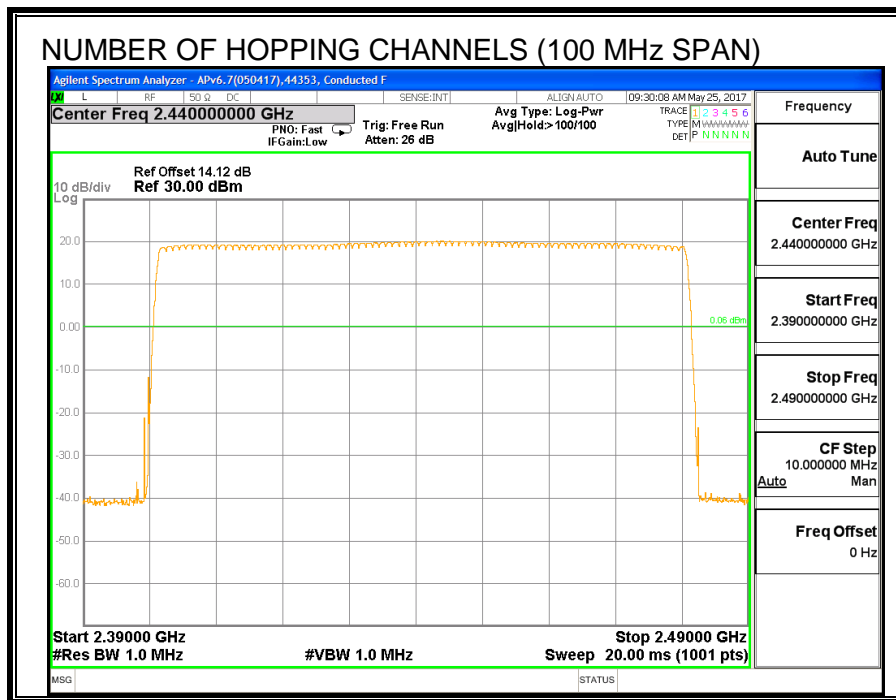

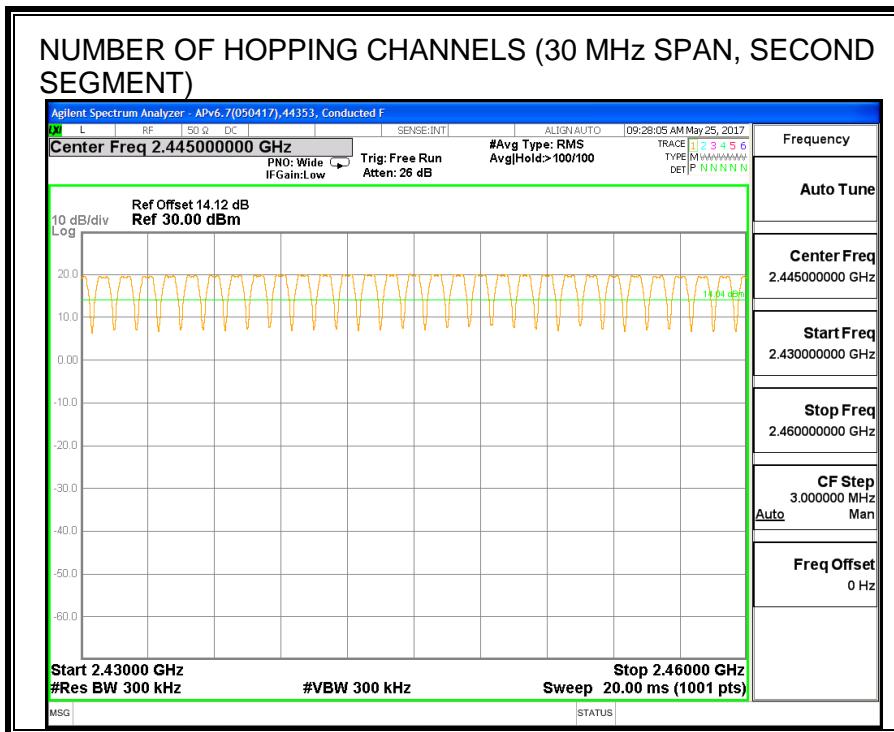
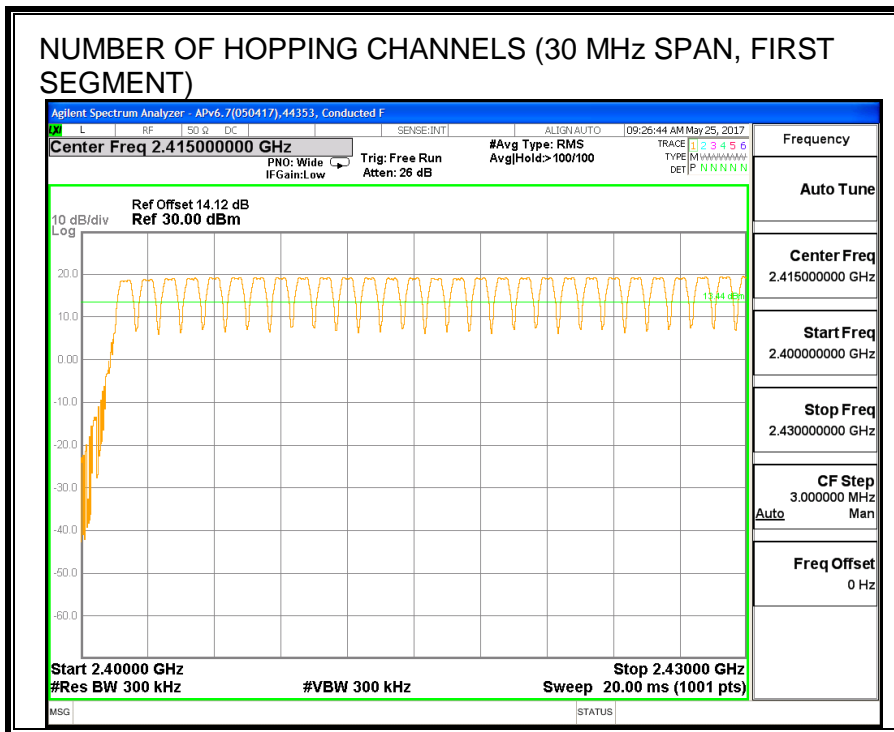

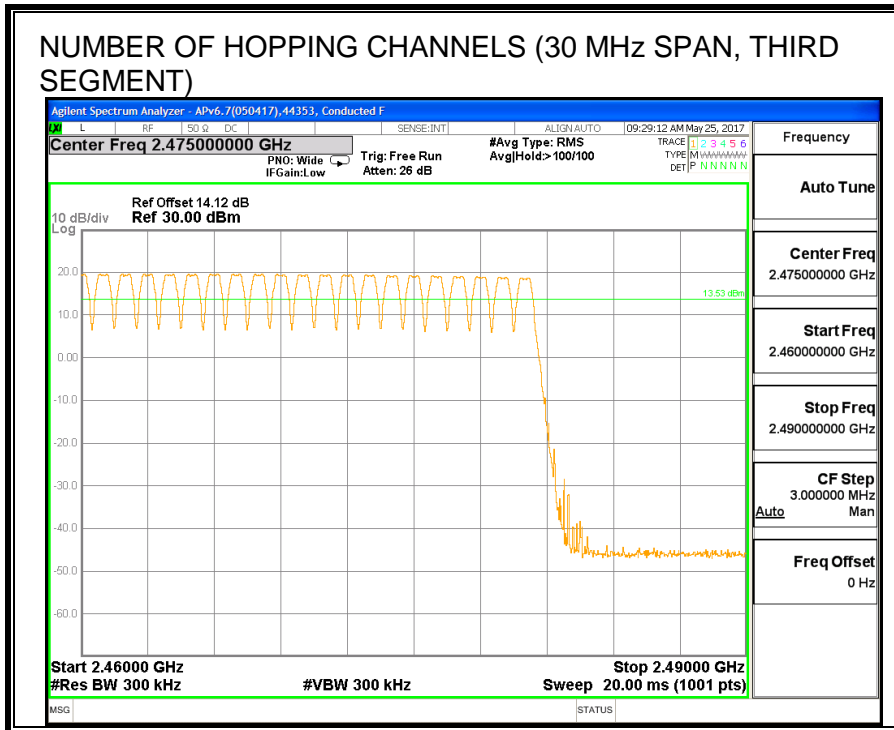

**8.1.4. AVERAGE TIME OF OCCUPANCY**

**LIMITS**

FCC §15.247 (a) (1) (iii)

IC RSS-247 (5.1) (d)

The average time of occupancy on any channel shall not be greater than 0.4 seconds within a period of 0.4 seconds multiplied by the number of hopping channels employed.

**TEST PROCEDURE**

The transmitter output is connected to a spectrum analyzer. The span is set to 0 Hz, centered on a single, selected hopping channel. The width of a single pulse is measured in a fast scan. The number of pulses is measured in a 3.16 second scan, to enable resolution of each occurrence.

The average time of occupancy in the specified 31.6 second period (79 channels \* 0.4 s) is equal to  $10 * (\# \text{ of pulses in } 3.16 \text{ s}) * \text{ pulse width}$ .

For AFH mode, the average time of occupancy in the specified 8 second period (20 channels \* 0.4 seconds) is equal to  $10 * (\# \text{ of pulses in } 0.8 \text{ s}) * \text{ pulse width}$ .

**RESULTS**

DH Packet	Pulse Width (msec)	Number of Pulses in 3.16 seconds	Average Time of Occupancy (sec)	Limit (sec)	Margin (sec)
GFSK Normal Mode					
DH1	0.383	32	0.123	0.4	-0.277
DH3	1.639	15	0.246	0.4	-0.154
DH5	2.888	12	0.347	0.4	-0.053



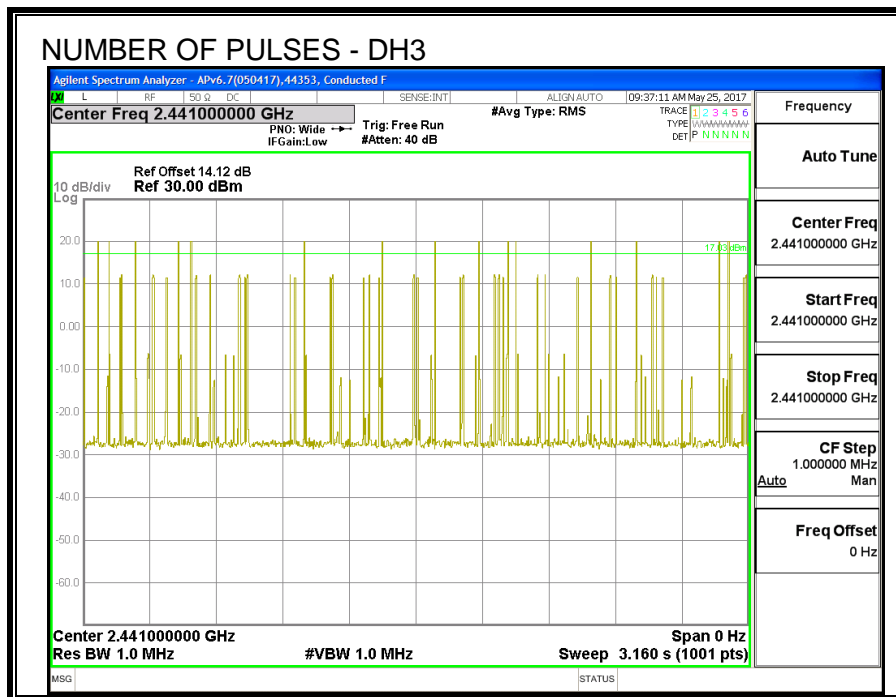
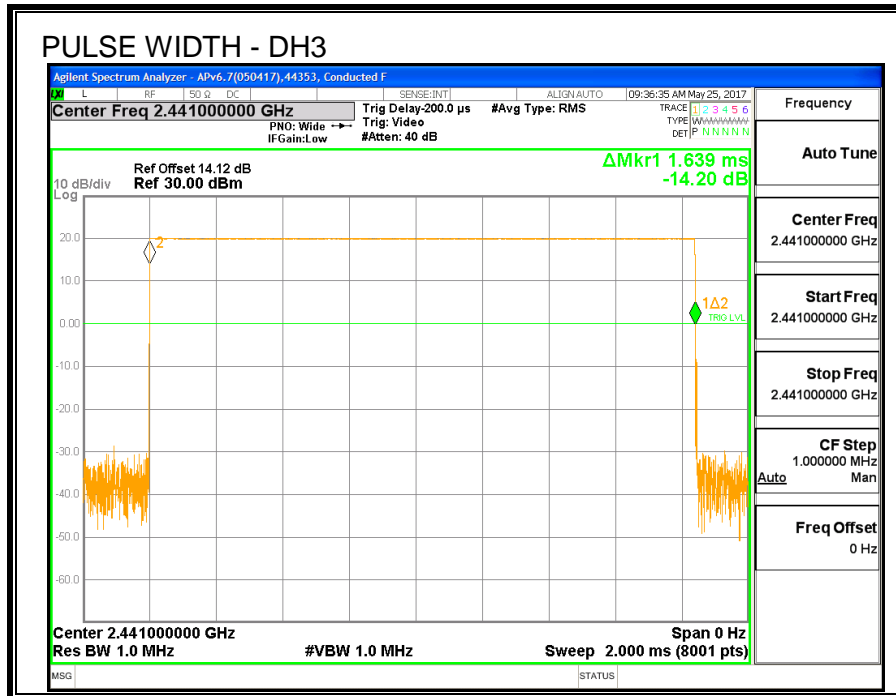

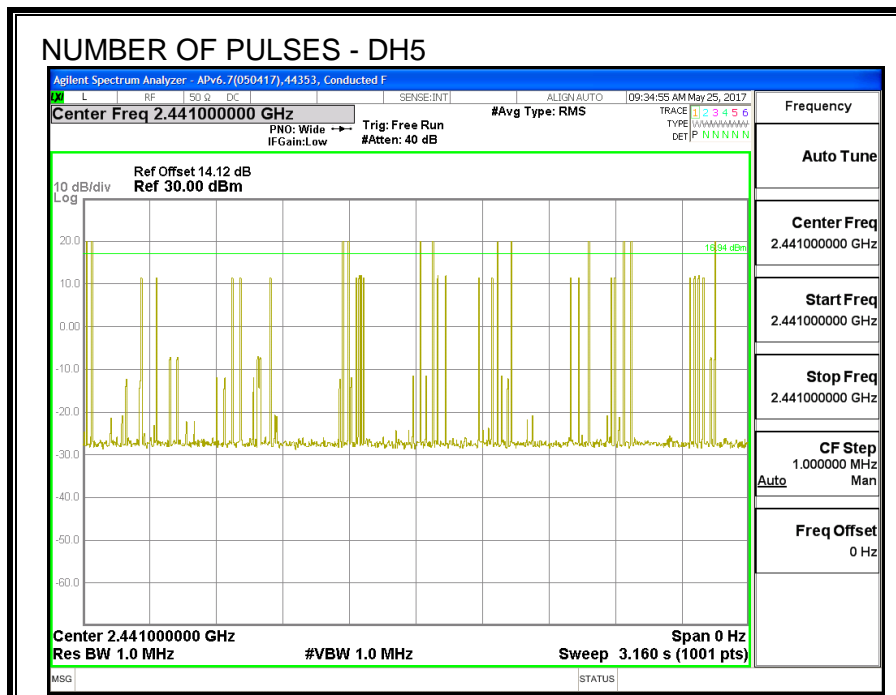
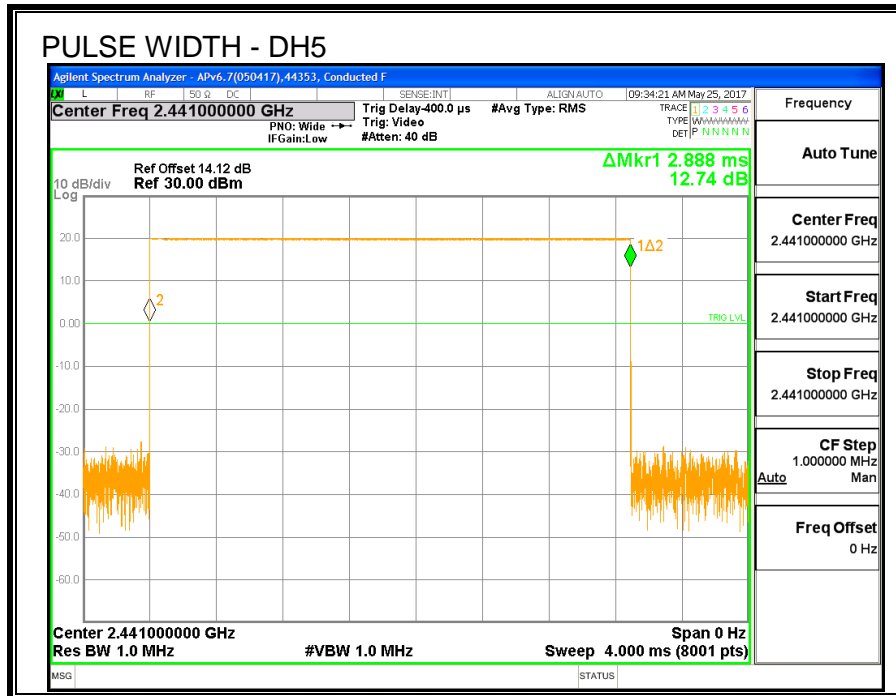

**8.1.5. OUTPUT POWER**

<b>ID:</b>	38806	<b>Date:</b>	7/29/17
------------	-------	--------------	---------

**LIMITS**

§15.247 (b) (1)

RSS-247 (5.4) (b)

The maximum antenna gain is less than 6 dBi, therefore the limit is 30 dBm.

**TEST PROCEDURE**

The transmitter output is connected to a wideband peak and average power meter.

**RESULTS**

<b>Channel</b>	<b>Frequency (MHz)</b>	<b>Output Power (dBm)</b>	<b>Limit (dBm)</b>	<b>Margin (dB)</b>
Low	2402	20.18	30	-9.82
Middle	2441	20.25	30	-9.75
High	2480	20.02	30	-9.98



---

**8.1.6. AVERAGE POWER**

<b>ID:</b>	44353	<b>Date:</b>	7/29/17
------------	-------	--------------	---------

**LIMITS**

None; for reporting purposes only.

**TEST PROCEDURE**

The transmitter output is connected to a power meter.

**RESULTS**

The cable assembly insertion loss of 11 dB (including 10 dB pad and 1 dB cable) was entered as an offset in the power meter to allow for direct reading of power.

<b>Channel</b>	<b>Frequency (MHz)</b>	<b>Average Power (dBm)</b>
Low	2402	19.93
Middle	2441	19.97
High	2480	19.89

### **8.1.7. CONDUCTED SPURIOUS EMISSIONS**

#### **LIMITS**

FCC §15.247 (d)

IC RSS-247 (5.5)

Limit = -20 dBc

#### **TEST PROCEDURE**

The transmitter output is connected to a spectrum analyzer. The resolution bandwidth is set to 100 kHz. The video bandwidth is set to 300 kHz.

The spectrum from 30 MHz to 26 GHz is investigated with the transmitter set to the lowest, middle, and highest channels.

The bandedges at 2.4 and 2.4835 GHz are investigated with the transmitter set to the normal hopping mode.

#### **RESULTS**

**CONDUCTED BANDEDGE AND SPURIOUS EMISSIONS**

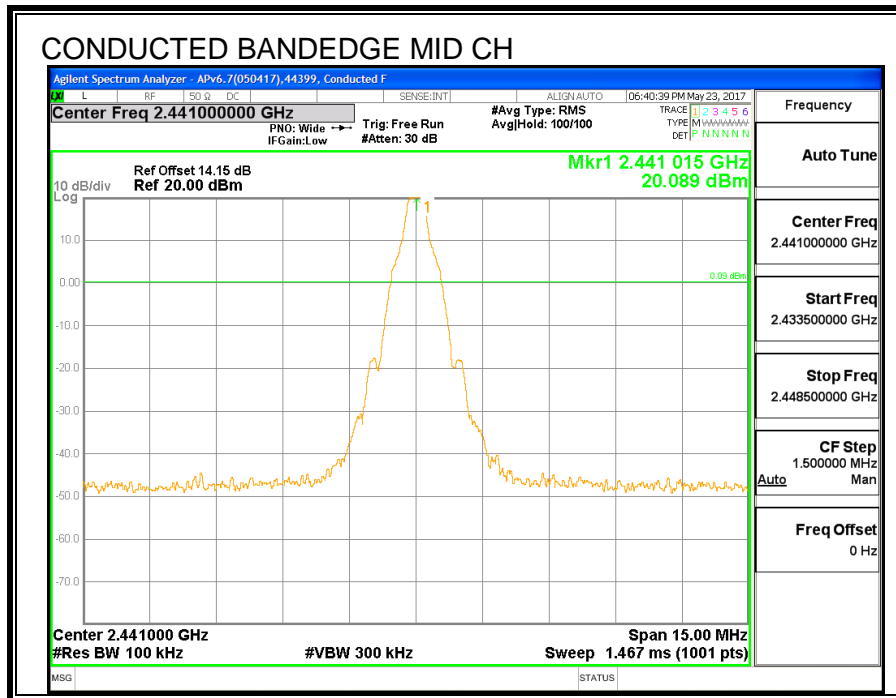
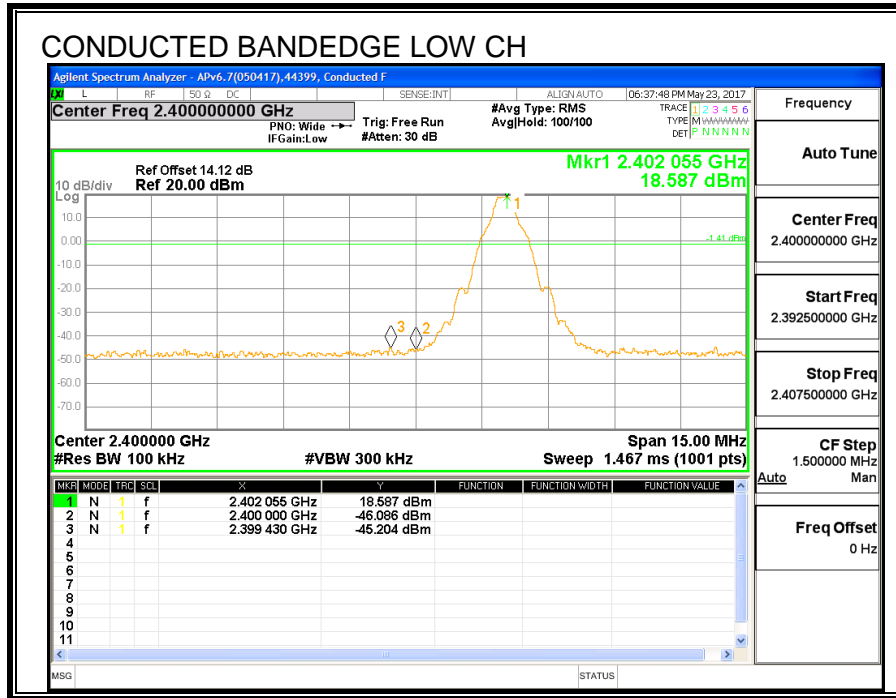

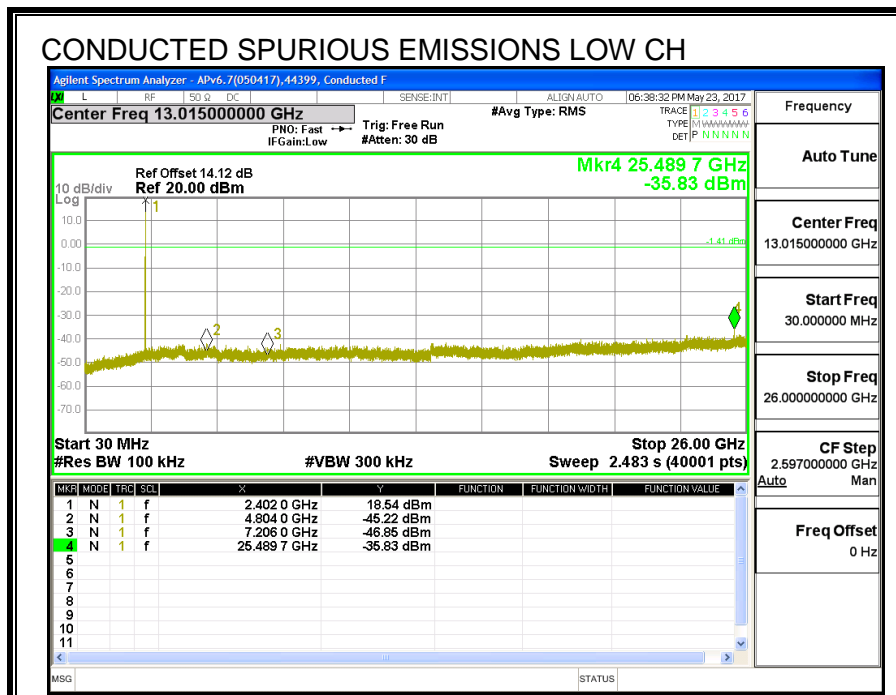
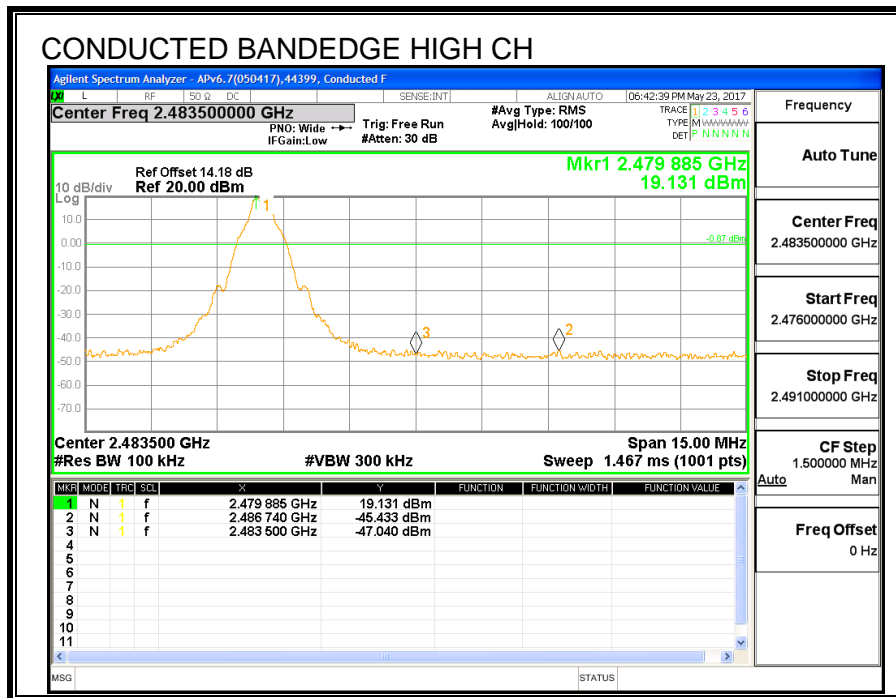

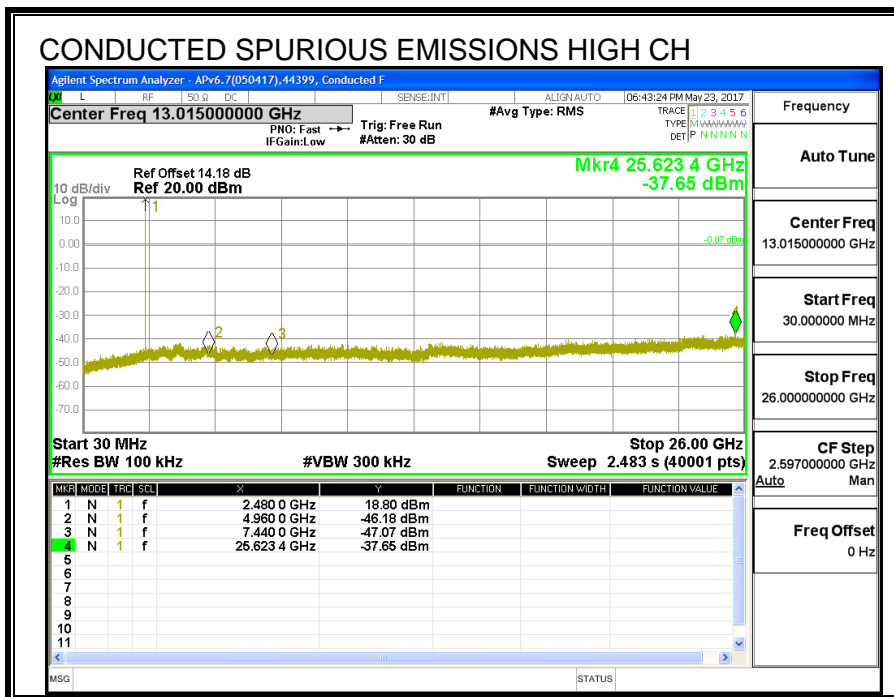
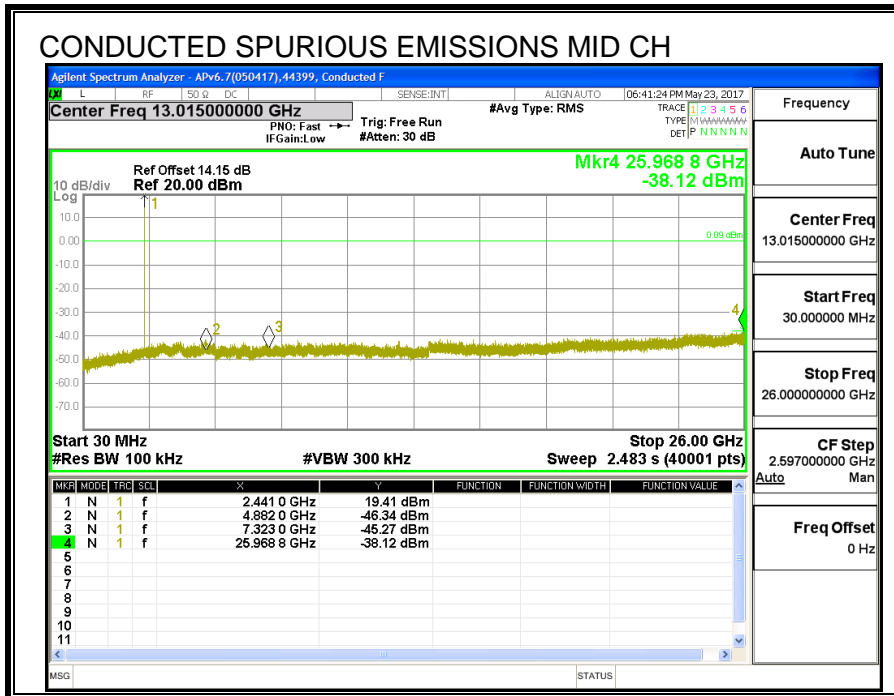

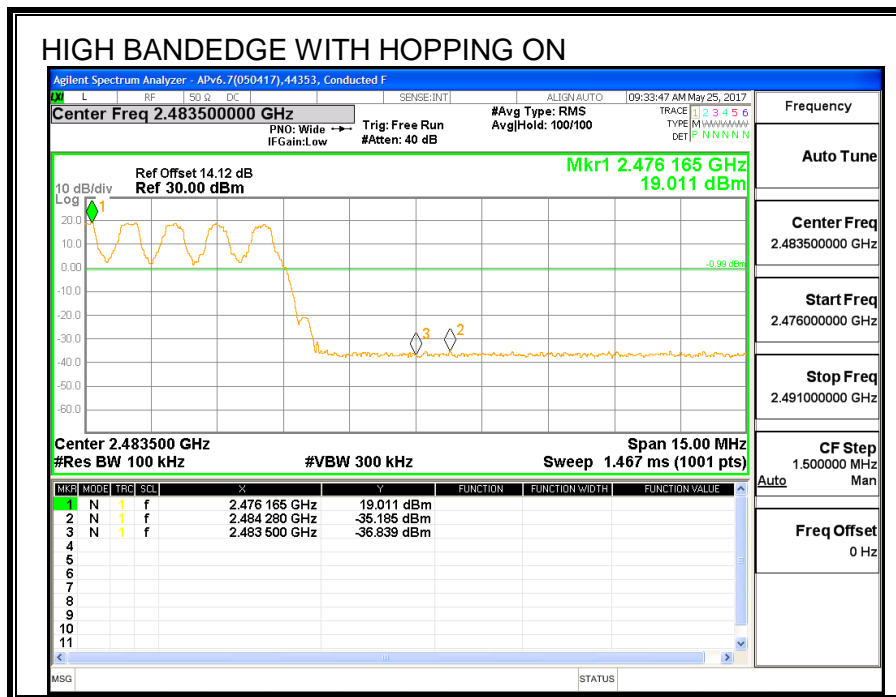
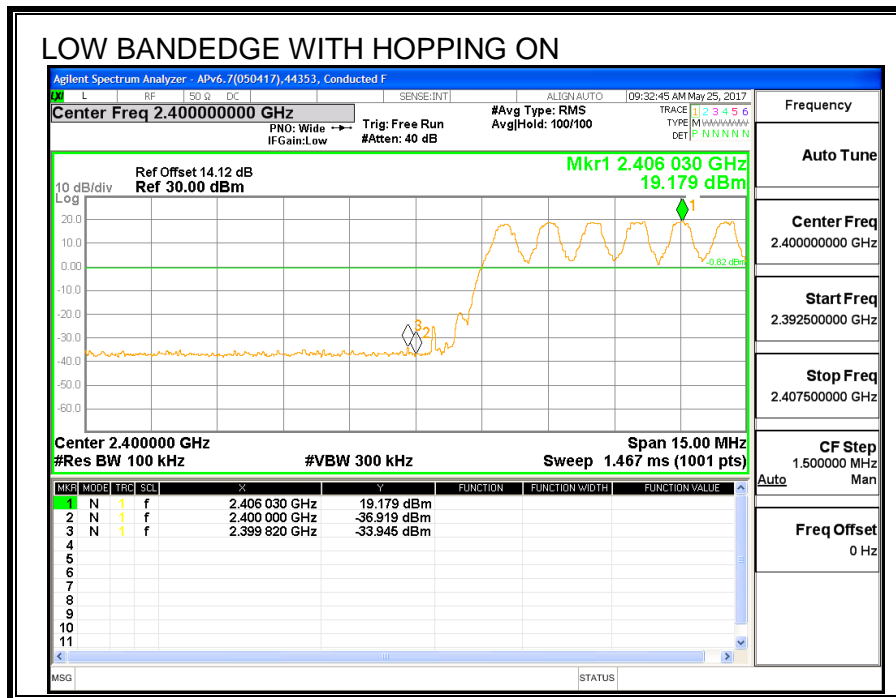

## 8.2. UAT 1, Pmax ENHANCED DATA RATE DQPSK MODULATION

### 8.2.1. OUTPUT POWER

<b>ID:</b>	38806	<b>Date:</b>	7/29/17
------------	-------	--------------	---------

#### LIMITS

§15.247 (b) (1)

RSS-247 (5.4) (b)

The maximum antenna gain is less than 6 dBi, therefore the limit is 30 dBm. Alternatively, frequency hopping systems operating in the 2400-2483.5 MHz band may have hopping channel carrier frequencies that are separated by 25 kHz or two-thirds of the 20 dB bandwidth of the hopping channel, whichever is greater, provided the systems operate with an output power no greater than 125 mW.

#### TEST PROCEDURE

The transmitter output is connected to a wideband peak and average power meter.

#### RESULTS

Channel	Frequency (MHz)	Output Power (dBm)	Limit (dBm)	Margin (dB)
Low	2402	19.65	21	-1.35
Middle	2441	19.71	21	-1.29
High	2480	19.58	21	-1.42

---

### 8.2.2. AVERAGE POWER

<b>ID:</b>	44353	<b>Date:</b>	7/29/17
------------	-------	--------------	---------

#### LIMITS

None; for reporting purposes only.

#### TEST PROCEDURE

The transmitter output is connected to a power meter.

#### RESULTS

The cable assembly insertion loss of 11 dB (including 10 dB pad and 1 dB cable) was entered as an offset in the power meter to allow for direct reading of power.

Channel	Frequency (MHz)	Average Power (dBm)
Low	2402	17.33
Middle	2441	17.37
High	2480	17.29



---

### 8.3. UAT 1, Pmax ENHANCED DATA RATE 8PSK MODULATION

#### 8.3.1. 20 dB AND 99% BANDWIDTH

##### LIMITS

None; for reporting purposes only.

##### TEST PROCEDURE

The transmitter output is connected to a spectrum analyzer. The RBW is set to  $\geq 1\%$  of the 20 dB bandwidth. The VBW is set to  $\geq$  RBW. The sweep time is coupled.

##### RESULTS

Channel	Frequency (MHz)	20 dB Bandwidth (KHz)	99% Bandwidth (KHz)
Low	2402	2096	2123.3
Middle	2441	1421	2125.1
High	2480	1461	1626.7

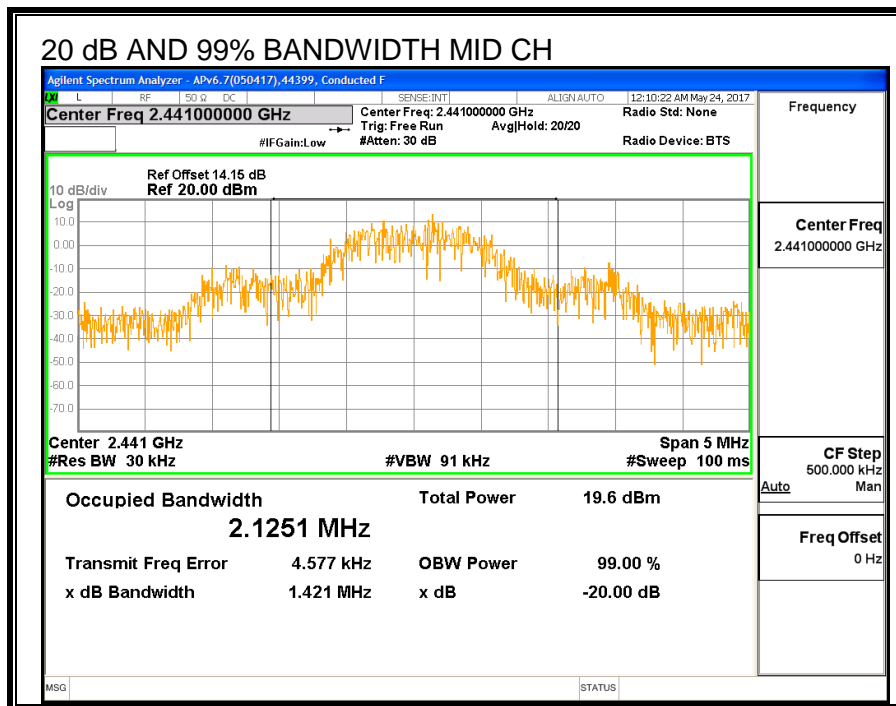
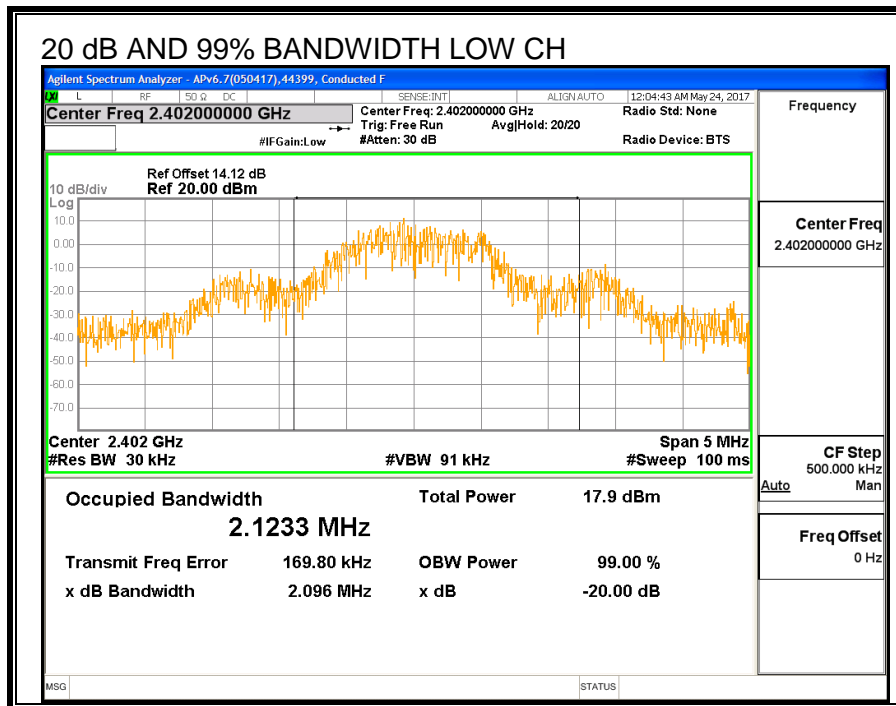

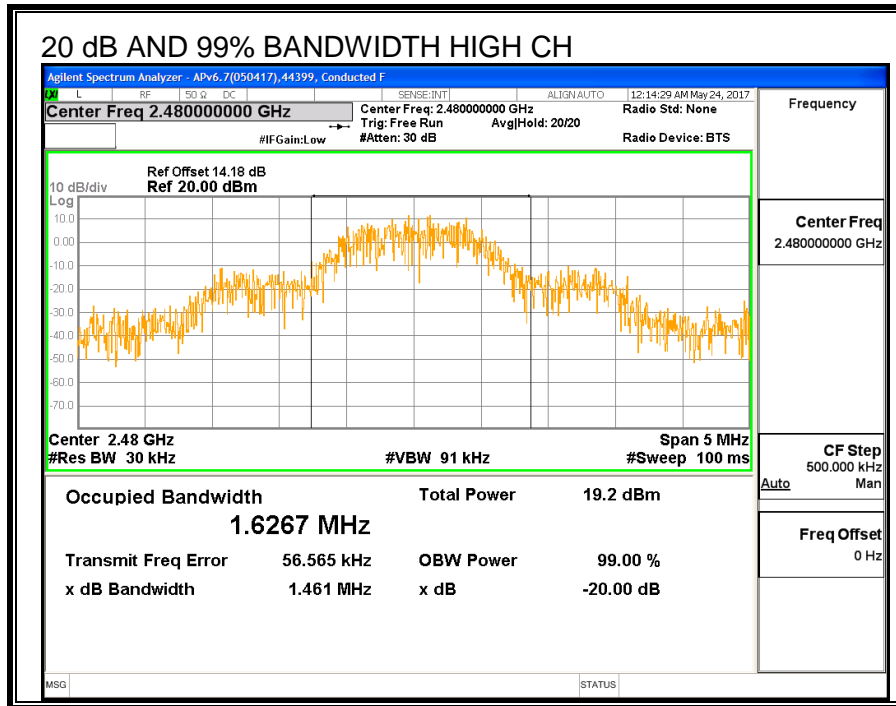

### 8.3.2. HOPPING FREQUENCY SEPARATION

#### LIMITS

FCC §15.247 (a) (1)

IC RSS-247 (5.1) (b)

Frequency hopping systems shall have hopping channel carrier frequencies separated by a minimum of 25 kHz or the 20 dB bandwidth of the hopping channel, whichever is greater.

Alternatively, frequency hopping systems operating in the 2400-2483.5 MHz band may have hopping channel carrier frequencies that are separated by 25 kHz or two-thirds of the 20 dB bandwidth of the hopping channel, whichever is greater, provided the systems operate with an output power no greater than 125 mW.

#### TEST PROCEDURE

The transmitter output is connected to a spectrum analyzer. The RBW is set to 300 kHz and the VBW is set to 910 kHz. The sweep time is coupled.

#### RESULTS

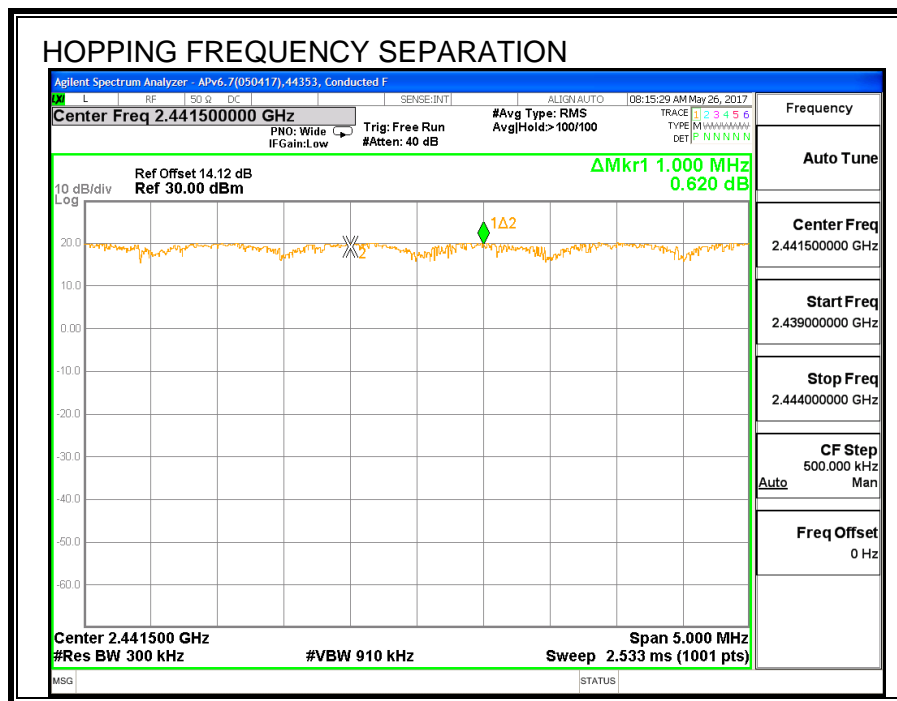

### 8.3.3. NUMBER OF HOPPING CHANNELS

#### LIMITS

FCC §15.247 (a) (1) (iii)

IC RSS-247 (5.1) (d)

Frequency hopping systems in the 2400 – 2483.5 MHz band shall use at least 15 non-overlapping channels.

#### TEST PROCEDURE

The transmitter output is connected to a spectrum analyzer. The span is set to cover the entire authorized band, in either a single sweep or in multiple contiguous sweeps. The RBW is set to a maximum of 1 % of the span. The analyzer is set to Max Hold.

#### RESULTS

Normal Mode: 79 Channels observed.

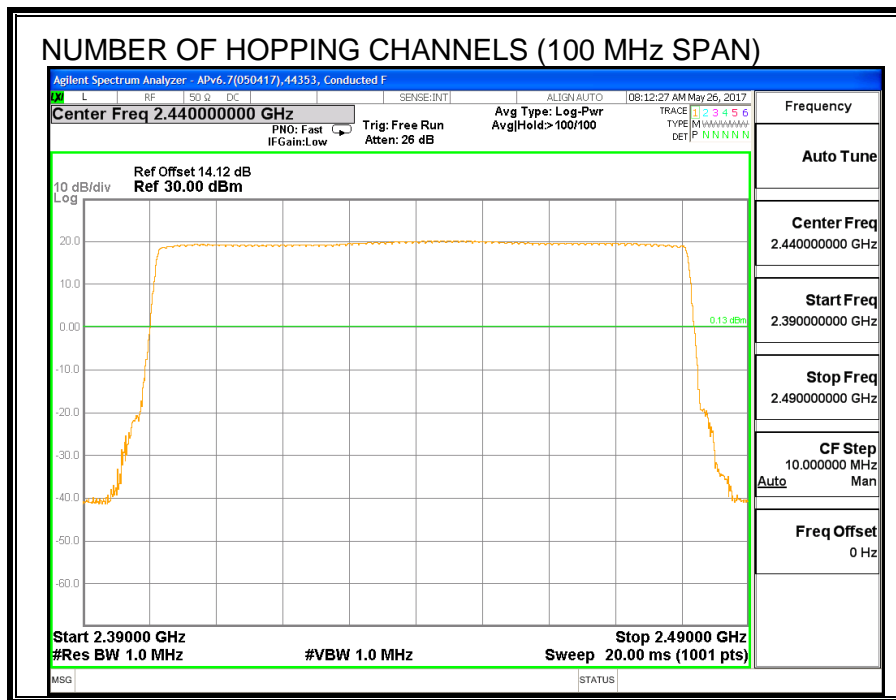

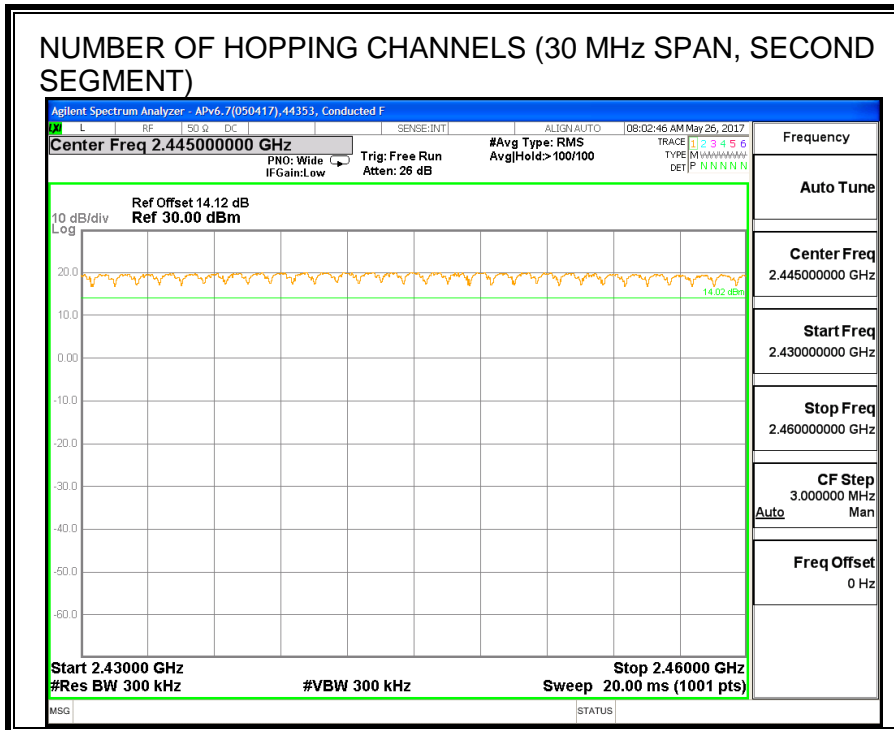
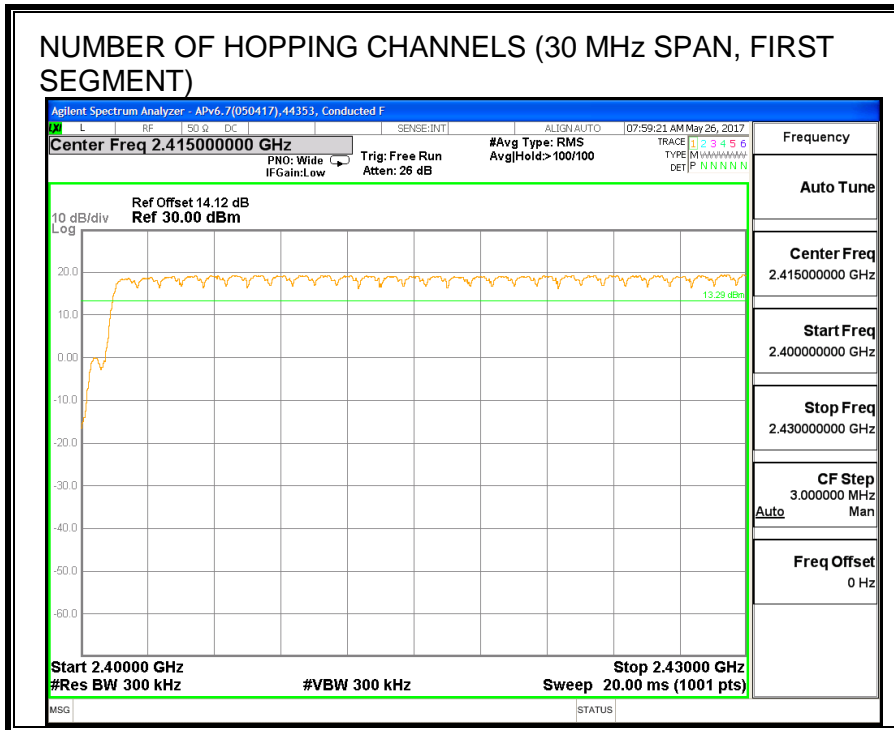

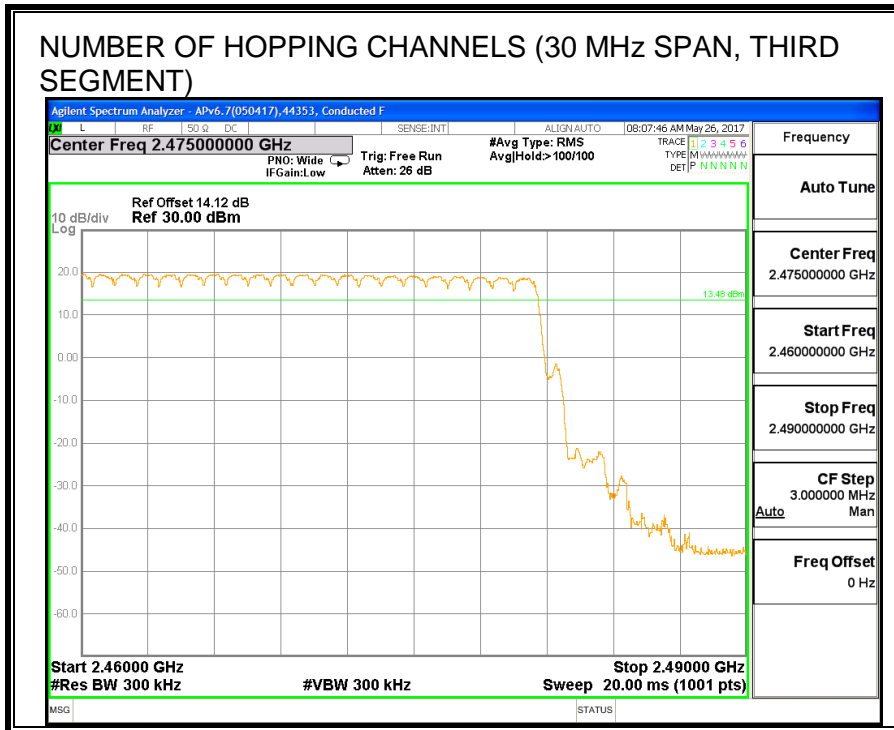

**8.3.4. AVERAGE TIME OF OCCUPANCY**

**LIMITS**

FCC §15.247 (a) (1) (iii)

IC RSS-247 (5.1) (d)

The average time of occupancy on any channel shall not be greater than 0.4 seconds within a period of 0.4 seconds multiplied by the number of hopping channels employed.

**TEST PROCEDURE**

The transmitter output is connected to a spectrum analyzer. The span is set to 0 Hz, centered on a single, selected hopping channel. The width of a single pulse is measured in a fast scan. The number of pulses is measured in a 3.16 second scan, to enable resolution of each occurrence.

The average time of occupancy in the specified 31.6 second period (79 channels \* 0.4 s) is equal to  $10 * (\# \text{ of pulses in } 3.16 \text{ s}) * \text{ pulse width}$ .

For AFH mode, the average time of occupancy in the specified 8 second period (20 channels \* 0.4 seconds) is equal to  $10 * (\# \text{ of pulses in } 0.8 \text{ s}) * \text{ pulse width}$ .

**RESULTS**

DH Packet	Pulse Width (msec)	Number of Pulses in 3.16 seconds	Average Time of Occupancy (sec)	Limit (sec)	Margin (sec)
8PSK (EDR) Mode					
3DH1	0.389	32	0.124	0.4	-0.276
3DH3	1.640	15	0.246	0.4	-0.154
3DH5	2.891	11	0.318	0.4	-0.082



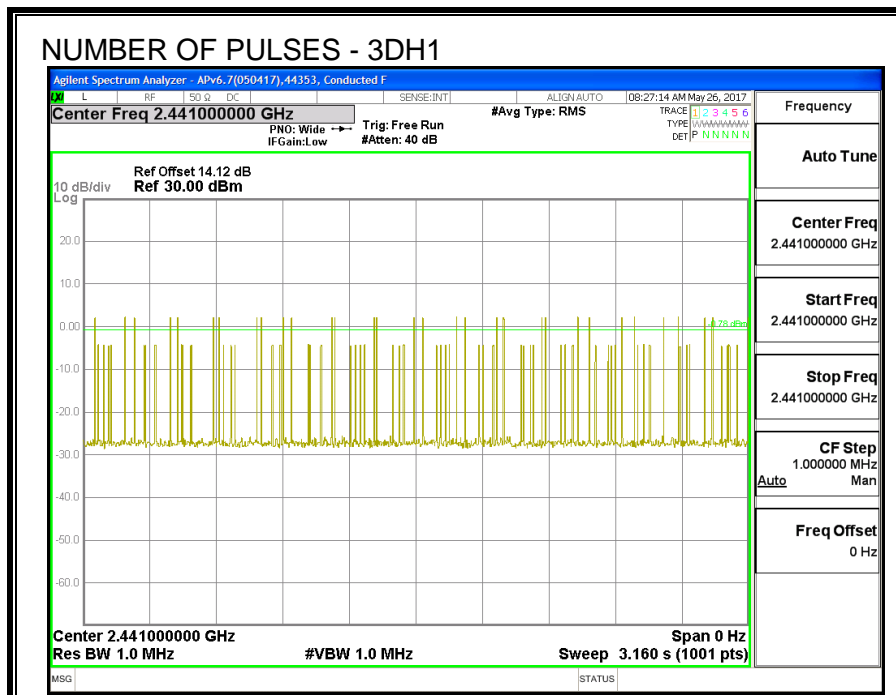
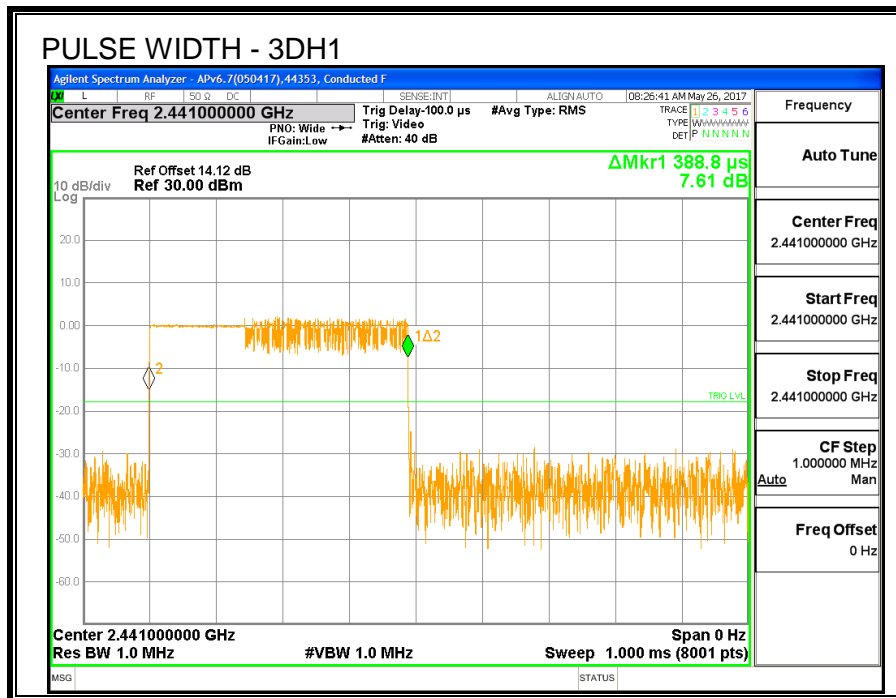

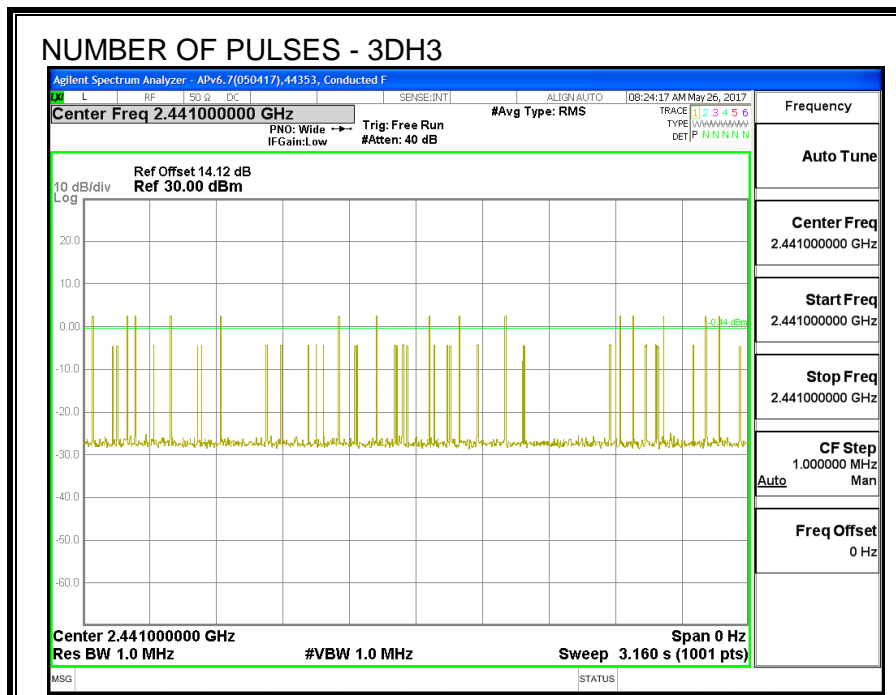
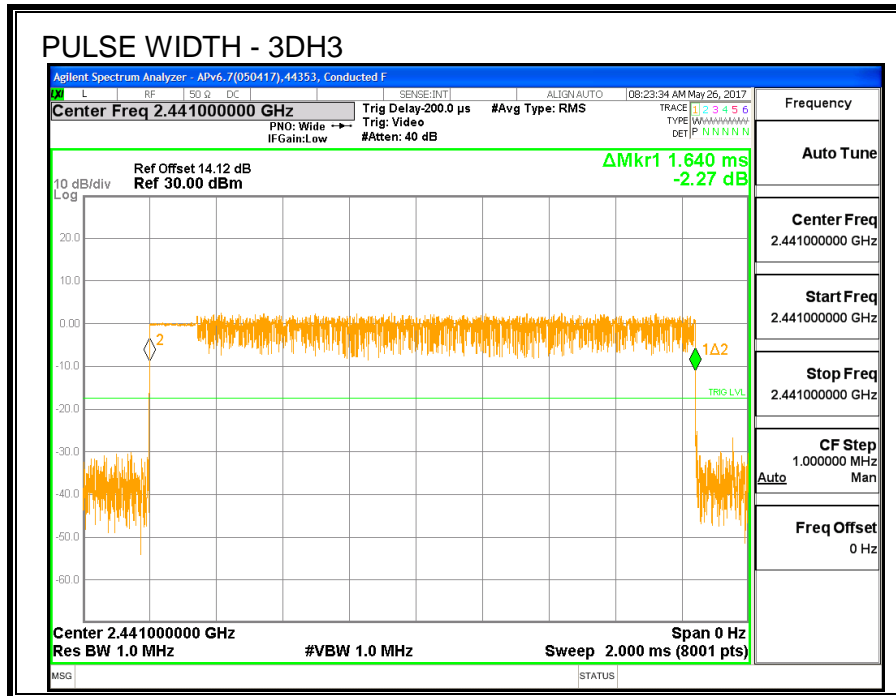

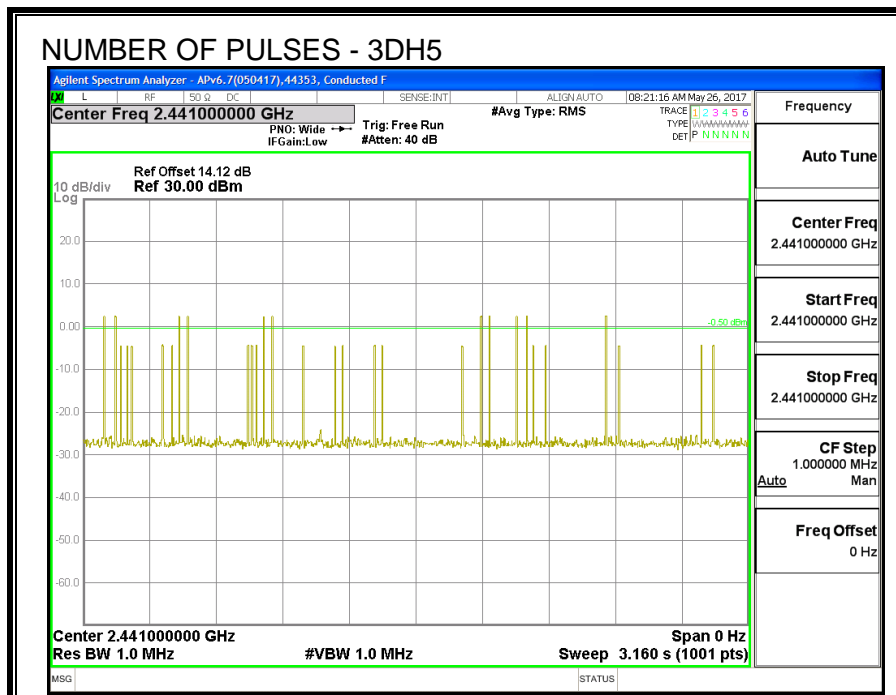
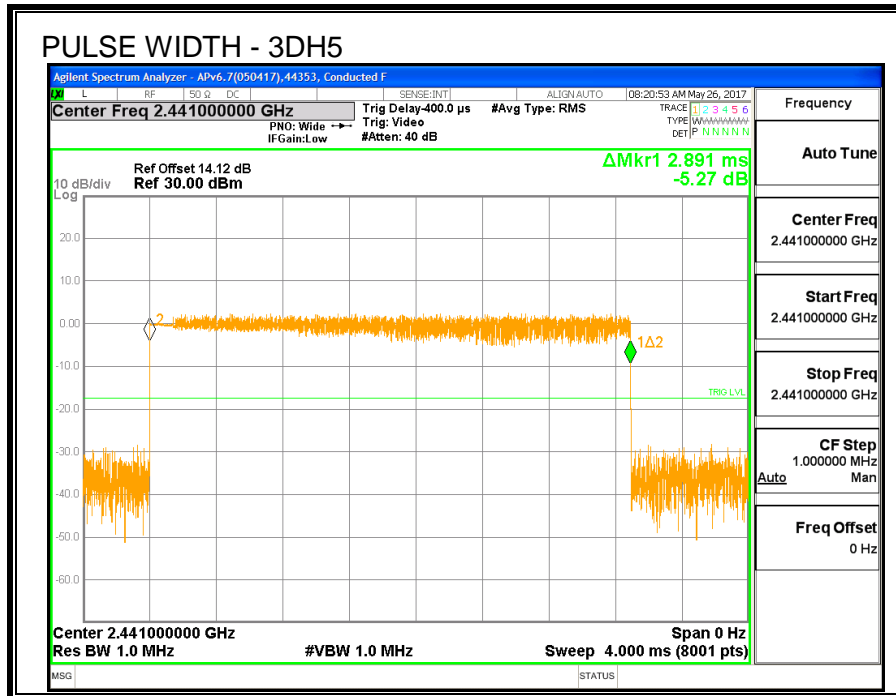

**8.3.5. OUTPUT POWER**

<b>ID:</b>	38806	<b>Date:</b>	7/29/17
------------	-------	--------------	---------

**LIMITS**

§15.247 (b) (1)

RSS-247 (5.4) (b)

The maximum antenna gain is less than 6 dBi, therefore the limit is 30 dBm.

Alternatively, frequency hopping systems operating in the 2400-2483.5 MHz band may have hopping channel carrier frequencies that are separated by 25 kHz or two-thirds of the 20 dB bandwidth of the hopping channel, whichever is greater, provided the systems operate with an output power no greater than 125 mW.

**TEST PROCEDURE**

The transmitter output is connected to a wideband peak and average power meter.

**RESULTS**

<b>Channel</b>	<b>Frequency (MHz)</b>	<b>Output Power (dBm)</b>	<b>Limit (dBm)</b>	<b>Margin (dB)</b>
Low	2402	19.72	21	-1.28
Middle	2441	19.80	21	-1.20
High	2480	19.77	21	-1.23

---

### 8.3.6. AVERAGE POWER

<b>ID:</b>	44353	<b>Date:</b>	7/29/17
------------	-------	--------------	---------

#### LIMITS

None; for reporting purposes only.

#### TEST PROCEDURE

The transmitter output is connected to a power meter.

#### RESULTS

The cable assembly insertion loss of 11 dB (including 10 dB pad and 1 dB cable) was entered as an offset in the power meter to allow for direct reading of power.

Channel	Frequency (MHz)	Average Power (dBm)
Low	2402	17.43
Middle	2441	17.48
High	2480	17.46

### **8.3.7. CONDUCTED SPURIOUS EMISSIONS**

#### **LIMITS**

FCC §15.247 (d)

IC RSS-247 (5.5)

Limit = -20 dBc

#### **TEST PROCEDURE**

The transmitter output is connected to a spectrum analyzer. The resolution bandwidth is set to 100 kHz. The video bandwidth is set to 300 kHz.

The spectrum from 30 MHz to 26 GHz is investigated with the transmitter set to the lowest, middle, and highest channels.

The band edges at 2.4 and 2.4835 GHz are investigated with the transmitter set to the normal hopping mode.

#### **RESULTS**

**CONDUCTED BANDEDGE AND SPURIOUS EMISSIONS**

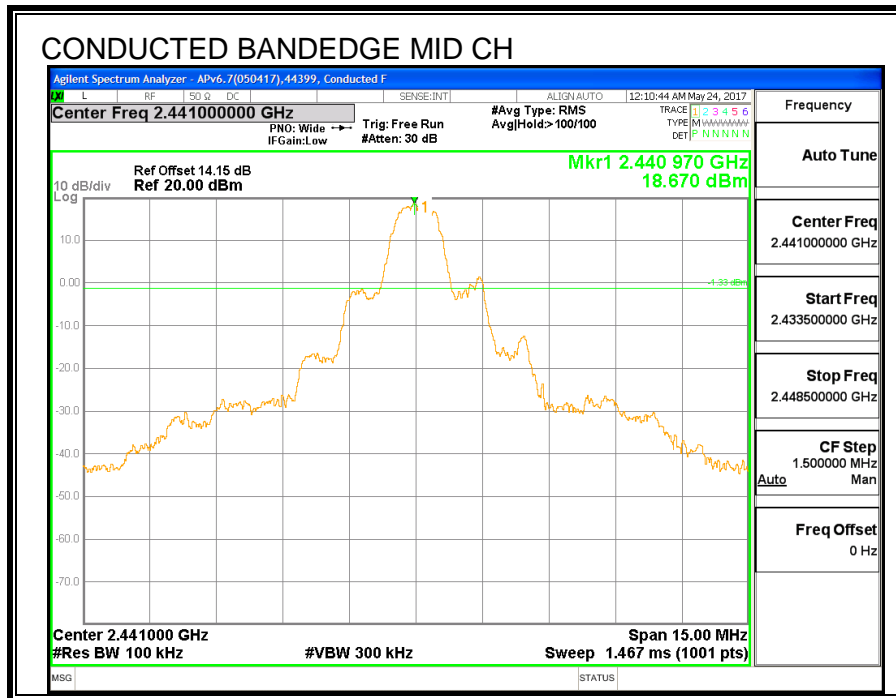
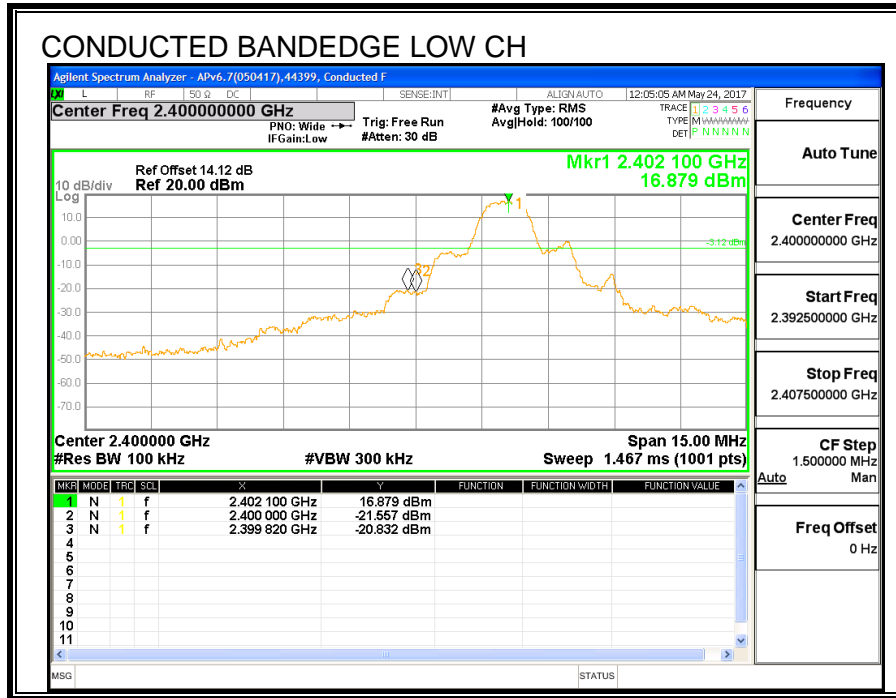

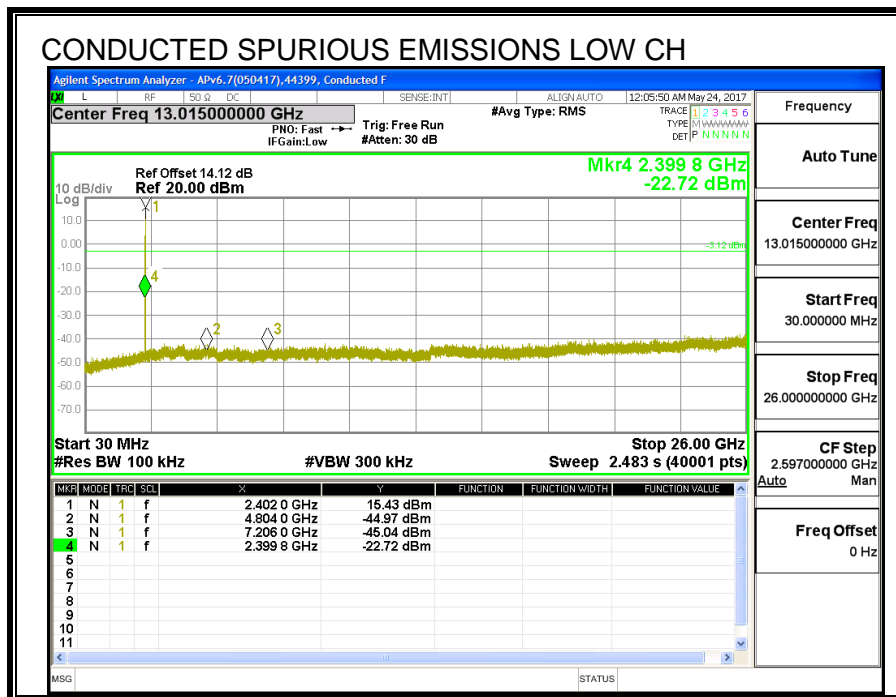
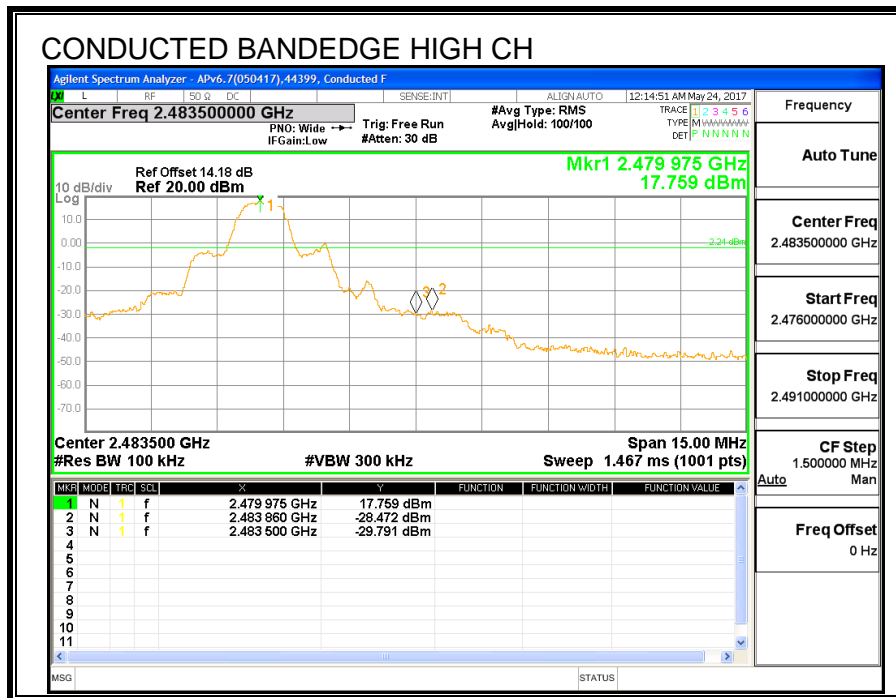



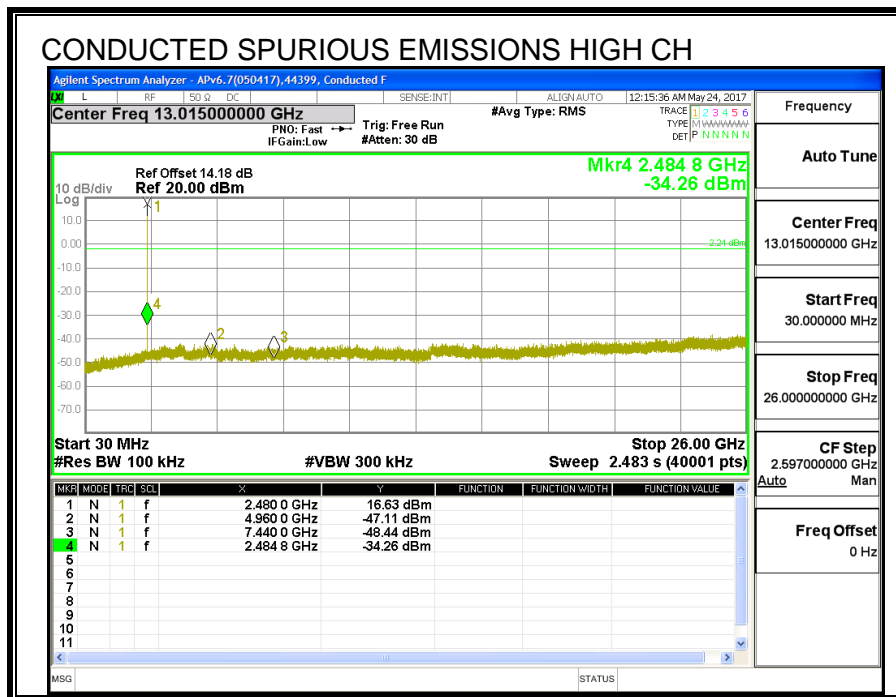
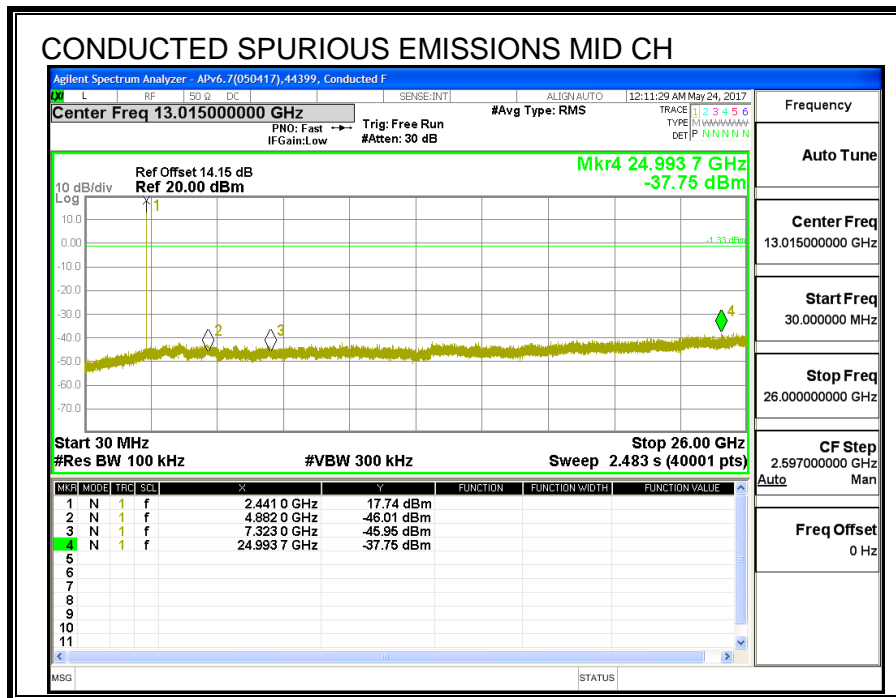

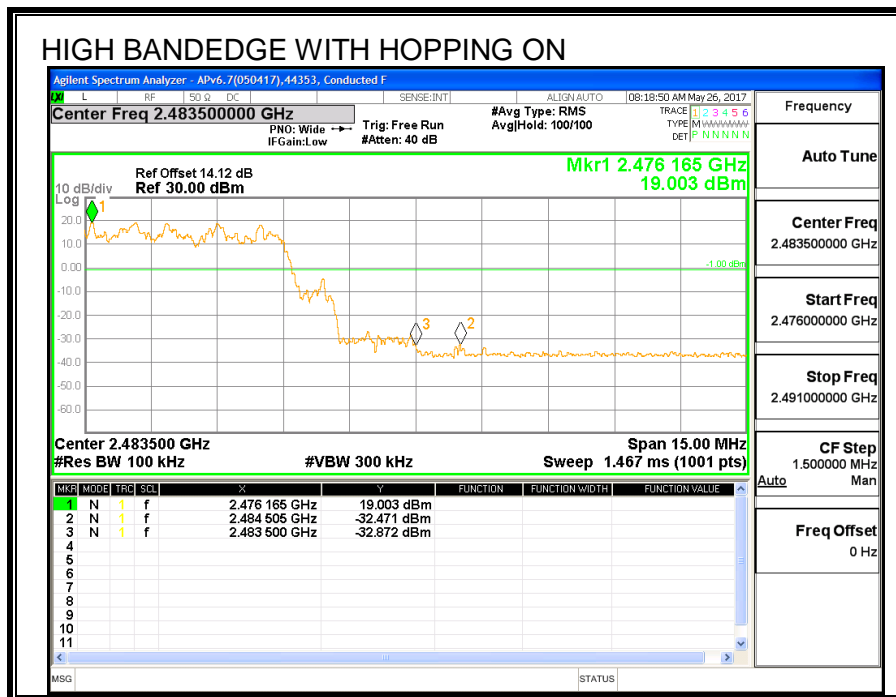
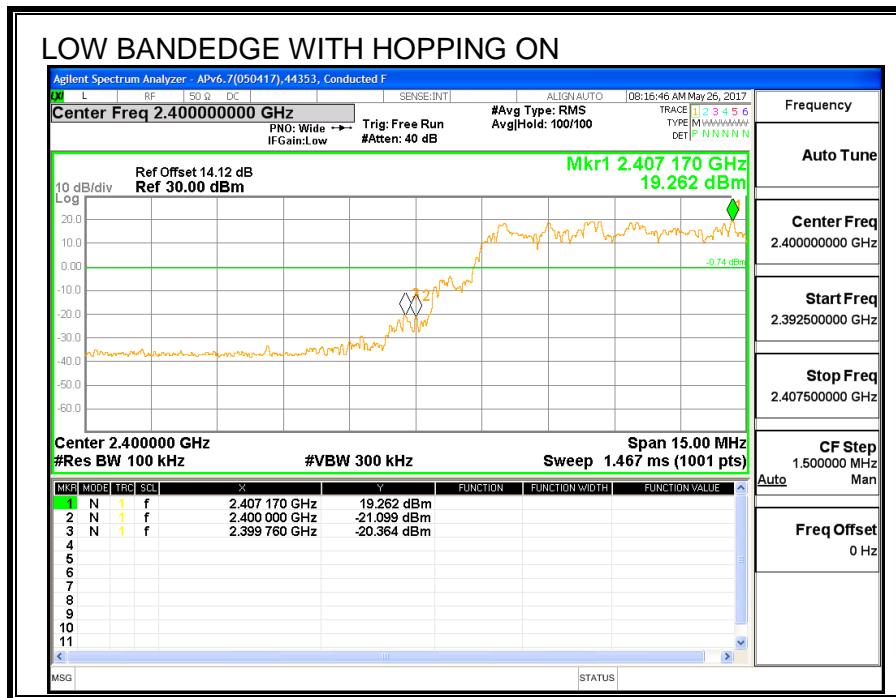

---

## 8.4. UAT 1, Plow BASIC DATA RATE GFSK MODULATION

### 8.4.1. 20 dB AND 99% BANDWIDTH

#### LIMITS

None; for reporting purposes only.

#### TEST PROCEDURE

The transmitter output is connected to a spectrum analyzer. The RBW is set to  $\geq 1\%$  of the 20 dB bandwidth. The VBW is set to  $\geq$  RBW. The sweep time is coupled.

#### RESULTS

Channel	Frequency (MHz)	20 dB Bandwidth (KHz)	99% Bandwidth (KHz)
Low	2402	938.9	925.55
Middle	2441	853.0	858.15
High	2480	913.8	907.17

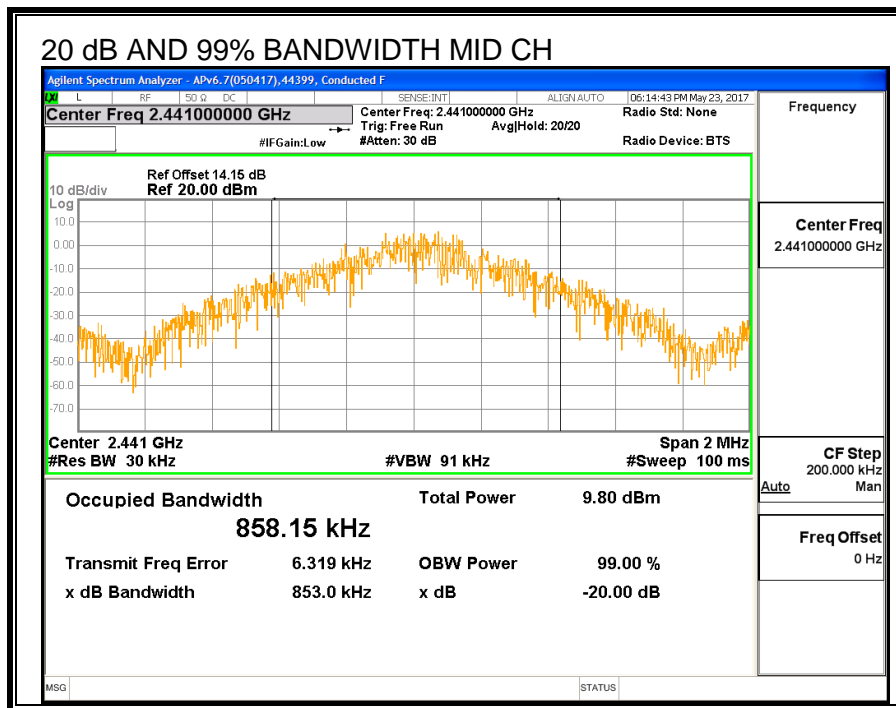
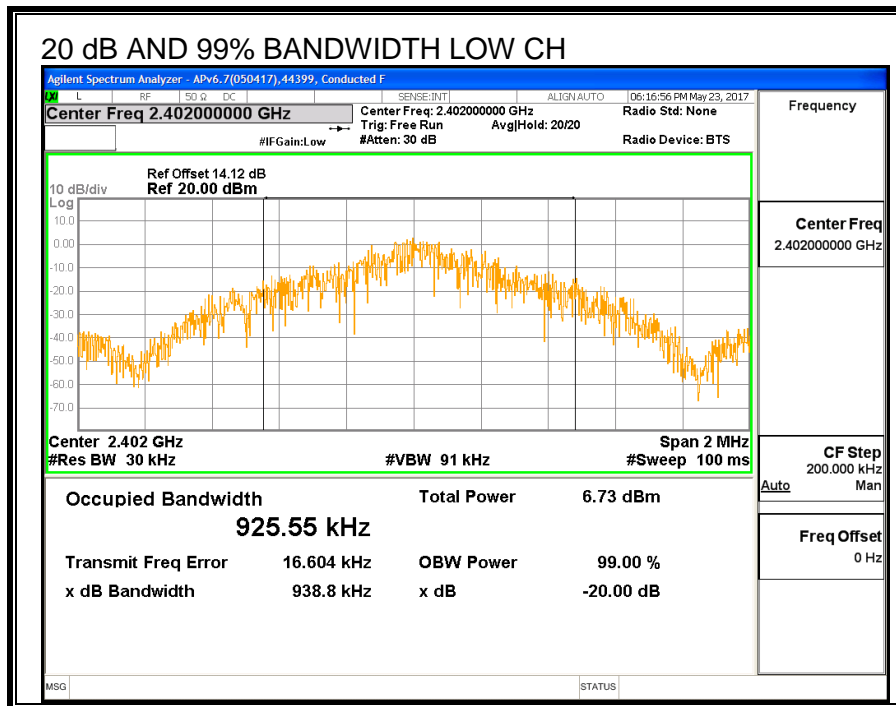

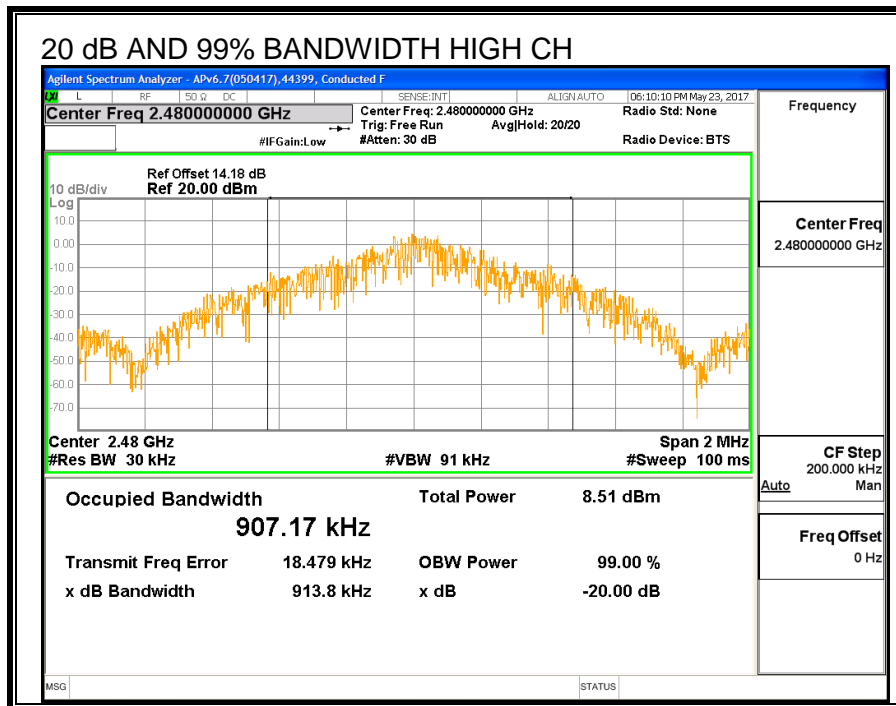

### 8.4.2. HOPPING FREQUENCY SEPARATION

#### LIMITS

FCC §15.247 (a) (1)

IC RSS-247 (5.1) (b)

Frequency hopping systems shall have hopping channel carrier frequencies separated by a minimum of 25 kHz or the 20 dB bandwidth of the hopping channel, whichever is greater.

Alternatively, frequency hopping systems operating in the 2400-2483.5 MHz band may have hopping channel carrier frequencies that are separated by 25 kHz or two-thirds of the 20 dB bandwidth of the hopping channel, whichever is greater, provided the systems operate with an output power no greater than 125 mW.

#### TEST PROCEDURE

The transmitter output is connected to a spectrum analyzer. The RBW is set to 300 kHz and the VBW is set to 910 kHz. The sweep time is coupled.

#### RESULTS

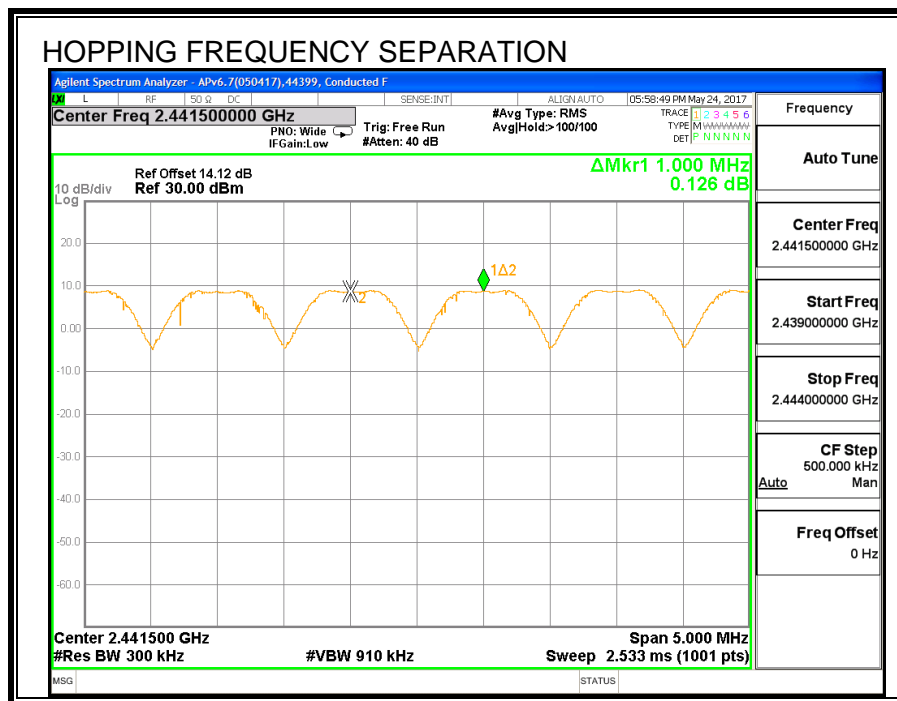

### 8.4.3. NUMBER OF HOPPING CHANNELS

#### LIMITS

FCC §15.247 (a) (1) (iii)

IC RSS-247 (5.1) (d)

Frequency hopping systems in the 2400 – 2483.5 MHz band shall use at least 15 non-overlapping channels.

#### TEST PROCEDURE

The transmitter output is connected to a spectrum analyzer. The span is set to cover the entire authorized band, in either a single sweep or in multiple contiguous sweeps. The RBW is set to a maximum of 1 % of the span. The analyzer is set to Max Hold.

#### RESULTS

Normal Mode: 79 Channels observed.

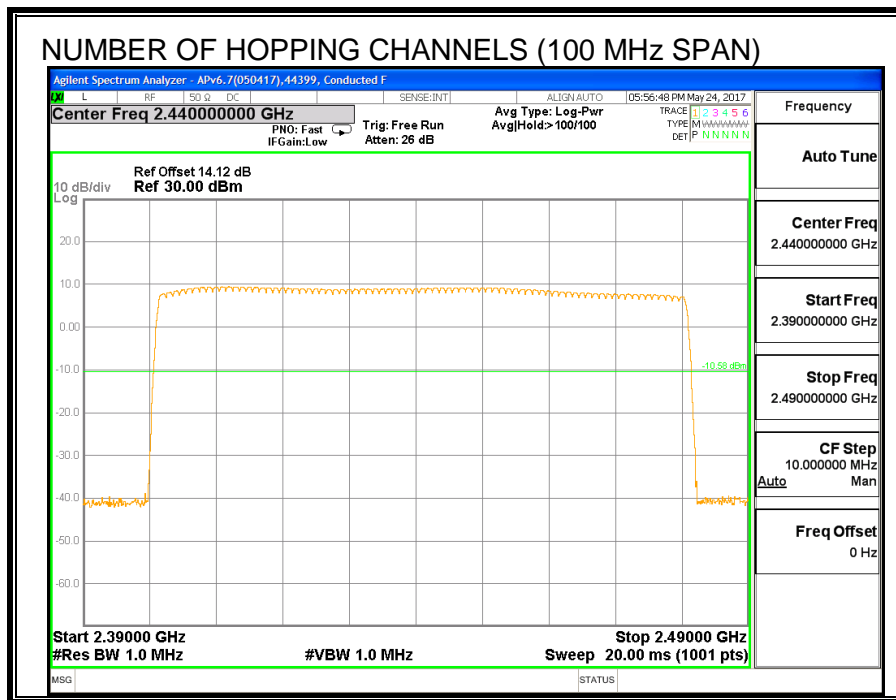

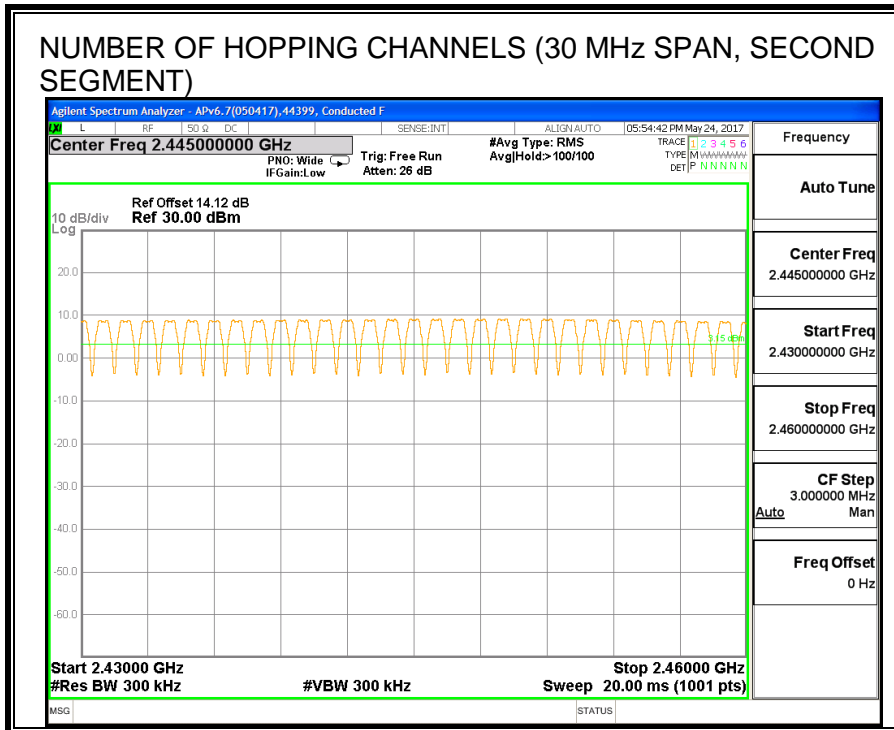
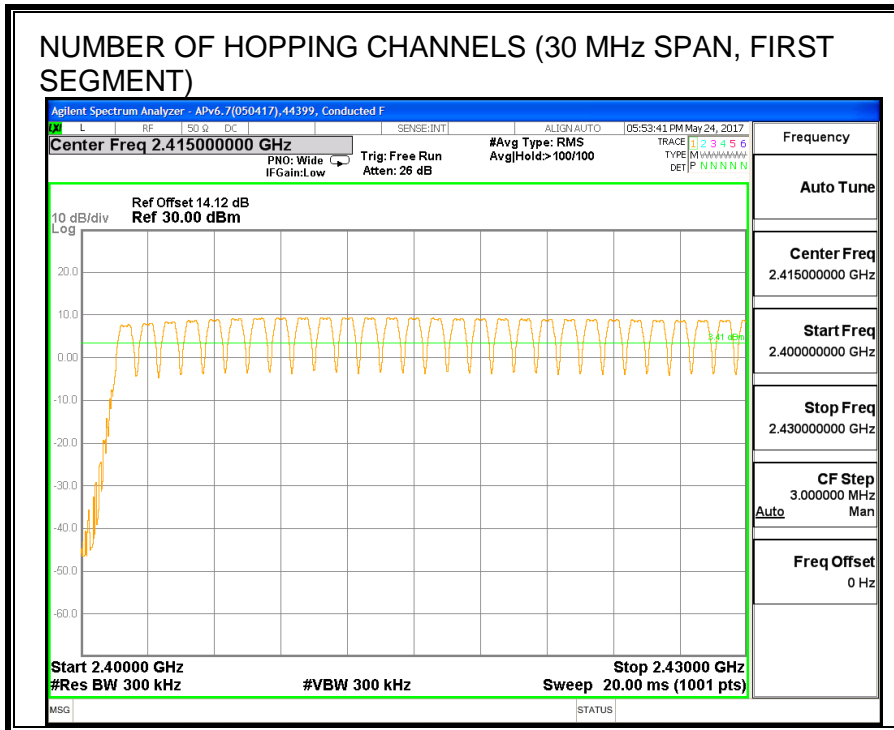



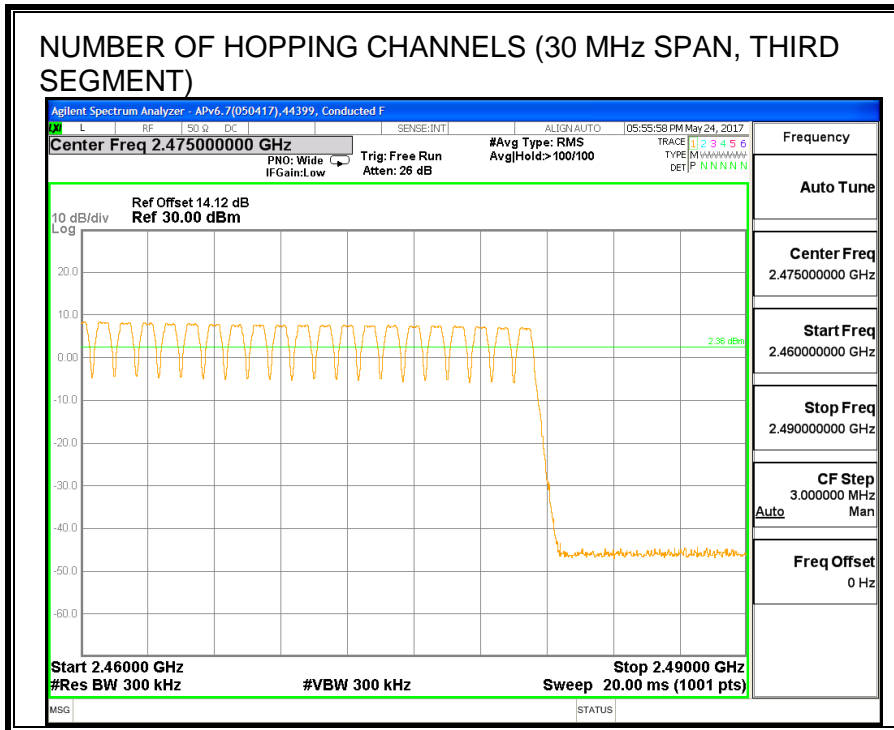

**8.4.4. AVERAGE TIME OF OCCUPANCY**

**LIMITS**

FCC §15.247 (a) (1) (iii)

IC RSS-247 (5.1) (d)

The average time of occupancy on any channel shall not be greater than 0.4 seconds within a period of 0.4 seconds multiplied by the number of hopping channels employed.

**TEST PROCEDURE**

The transmitter output is connected to a spectrum analyzer. The span is set to 0 Hz, centered on a single, selected hopping channel. The width of a single pulse is measured in a fast scan. The number of pulses is measured in a 3.16 second scan, to enable resolution of each occurrence.

The average time of occupancy in the specified 31.6 second period (79 channels \* 0.4 s) is equal to  $10 * (\# \text{ of pulses in } 3.16 \text{ s}) * \text{ pulse width}$ .

For AFH mode, the average time of occupancy in the specified 8 second period (20 channels \* 0.4 seconds) is equal to  $10 * (\# \text{ of pulses in } 0.8 \text{ s}) * \text{ pulse width}$ .

**RESULTS**

DH Packet	Pulse Width (msec)	Number of Pulses in 3.16 seconds	Average Time of Occupancy (sec)	Limit (sec)	Margin (sec)
GFSK Normal Mode					
DH1	0.383	32	0.123	0.4	-0.277
DH3	1.639	15	0.246	0.4	-0.154
DH5	2.887	12	0.347	0.4	-0.054

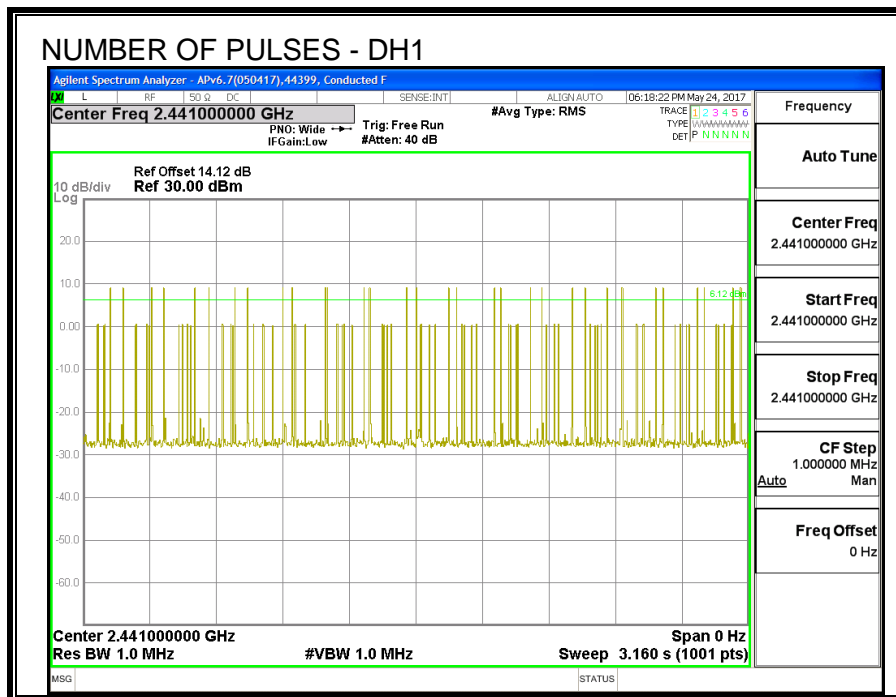

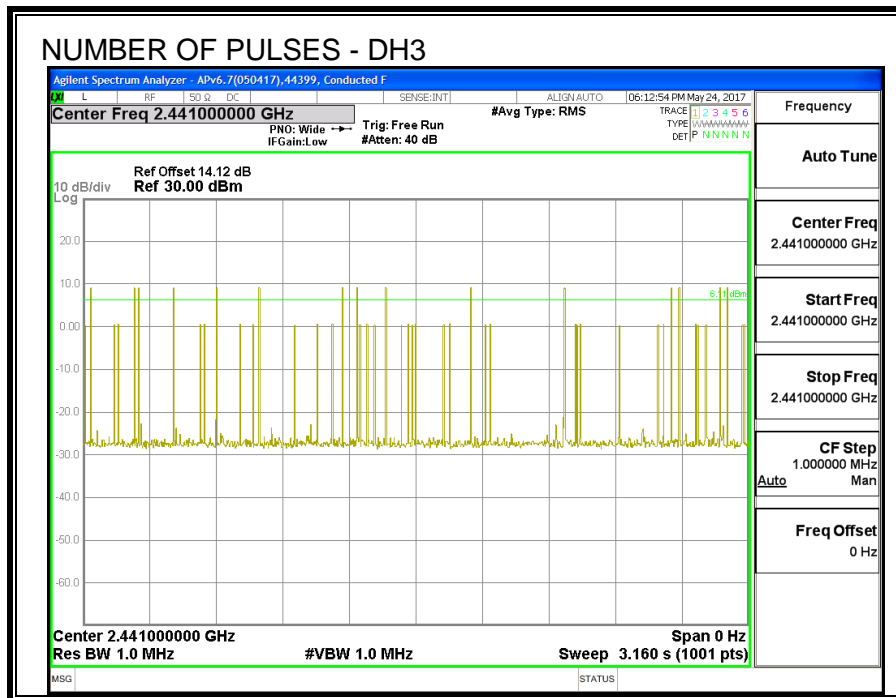
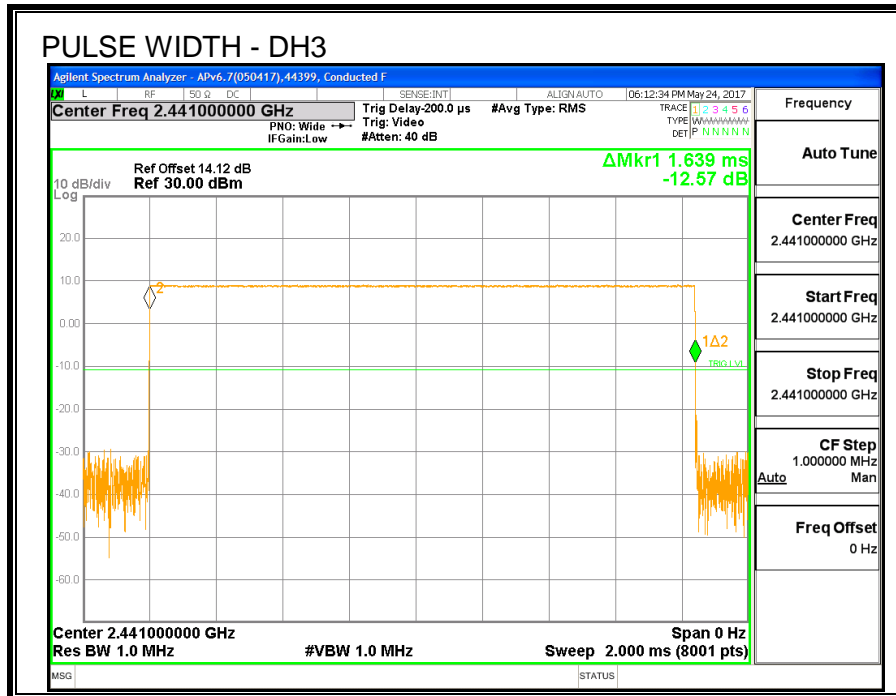

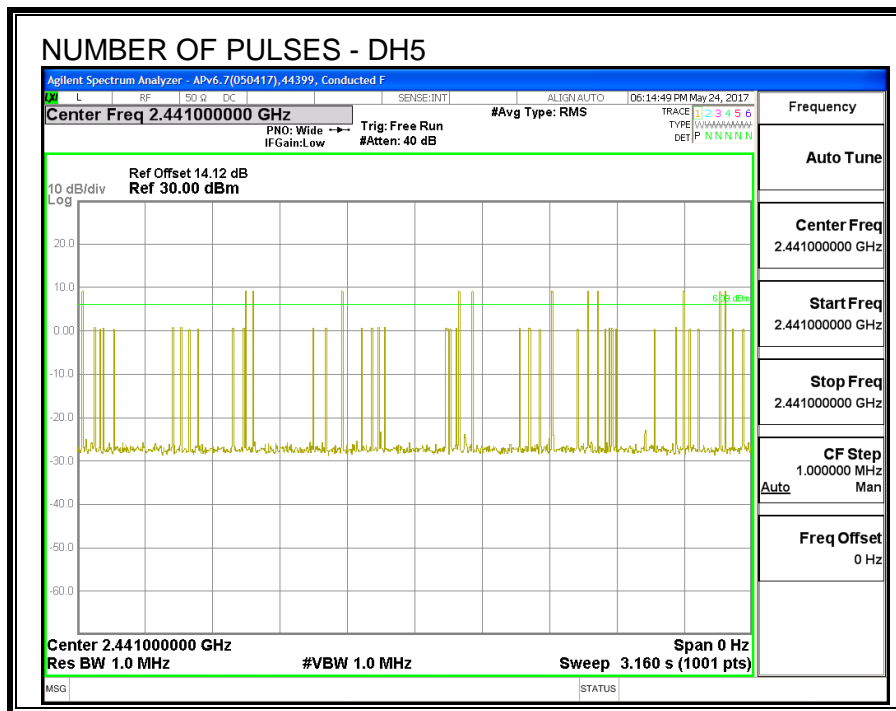
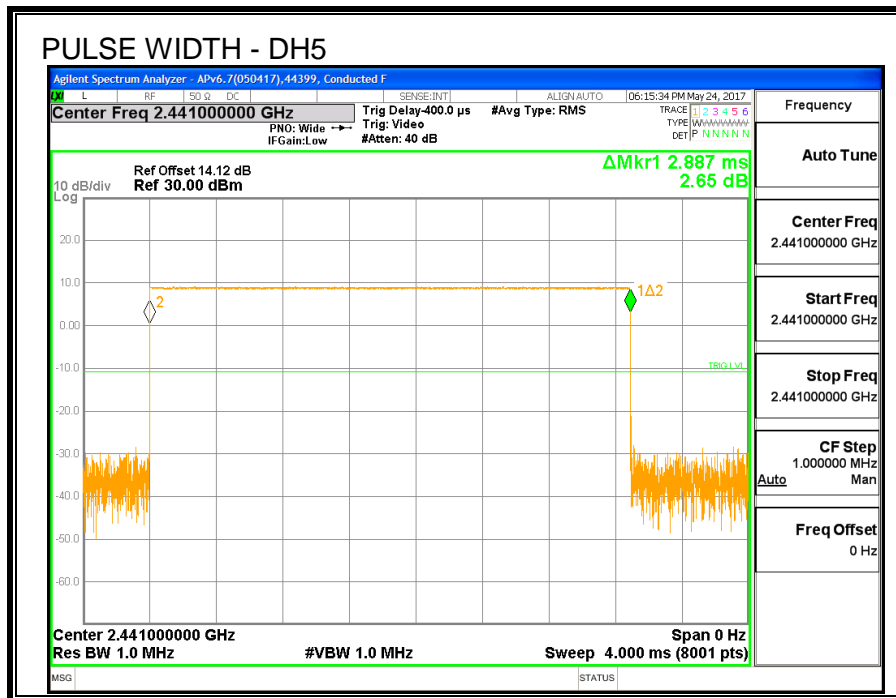

### 8.4.5. OUTPUT POWER

<b>ID:</b>	38806	<b>Date:</b>	7/29/17
------------	-------	--------------	---------

#### LIMITS

§15.247 (b) (1)

RSS-247 (5.4) (b)

The maximum antenna gain is less than 6 dBi, therefore the limit is 30 dBm.

#### TEST PROCEDURE

The transmitter output is connected to a wideband peak and average power meter.

#### RESULTS

Channel	Frequency (MHz)	Output Power (dBm)	Limit (dBm)	Margin (dB)
Low	2402	10.15	30	-19.85
Middle	2441	10.20	30	-19.80
High	2480	10.11	30	-19.89

---

### 8.4.6. AVERAGE POWER

<b>ID:</b>	44353	<b>Date:</b>	7/29/17
------------	-------	--------------	---------

#### LIMITS

None; for reporting purposes only.

#### TEST PROCEDURE

The transmitter output is connected to a power meter.

#### RESULTS

The cable assembly insertion loss of 11 dB (including 10 dB pad and 1 dB cable) was entered as an offset in the power meter to allow for direct reading of power.

Channel	Frequency (MHz)	Average Power (dBm)
Low	2402	9.89
Middle	2441	9.92
High	2480	9.86

### **8.4.7. CONDUCTED SPURIOUS EMISSIONS**

#### **LIMITS**

FCC §15.247 (d)

IC RSS-247 (5.5)

Limit = -20 dBc

#### **TEST PROCEDURE**

The transmitter output is connected to a spectrum analyzer. The resolution bandwidth is set to 100 kHz. The video bandwidth is set to 300 kHz.

The spectrum from 30 MHz to 26 GHz is investigated with the transmitter set to the lowest, middle, and highest channels.

The bandedges at 2.4 and 2.4835 GHz are investigated with the transmitter set to the normal hopping mode.

#### **RESULTS**



**CONDUCTED BANDEDGE AND SPURIOUS EMISSIONS**

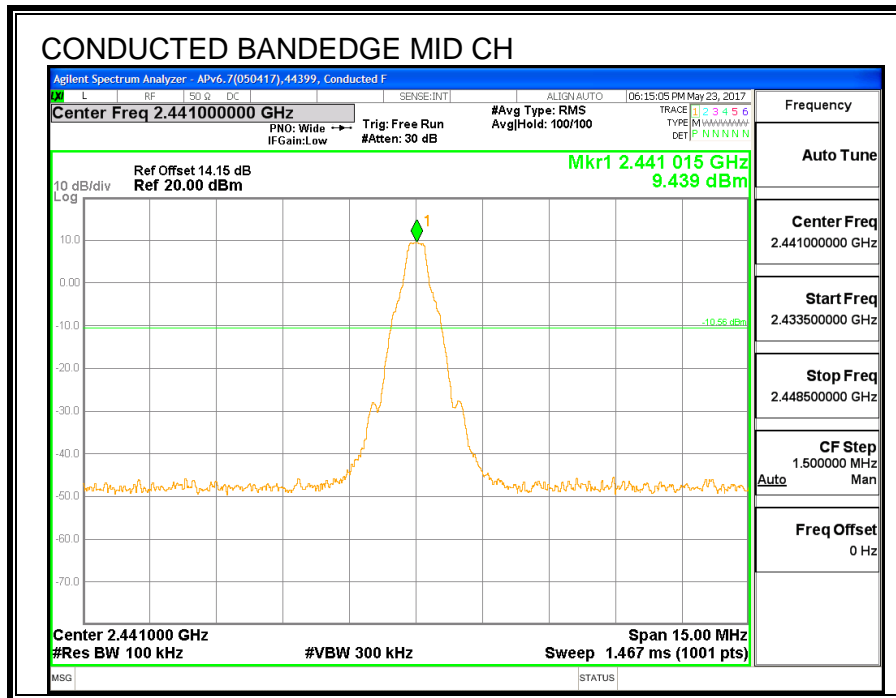
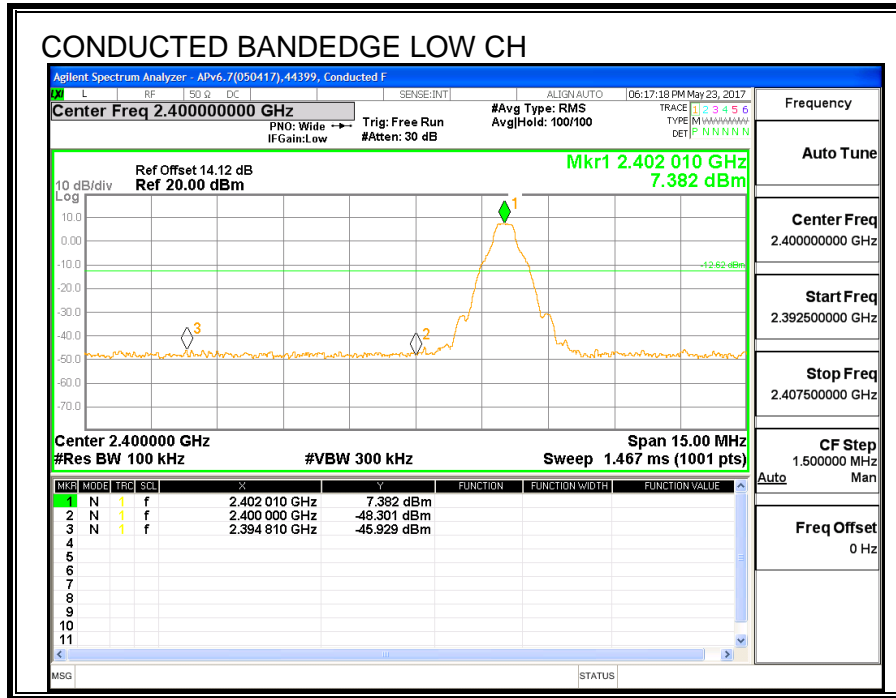

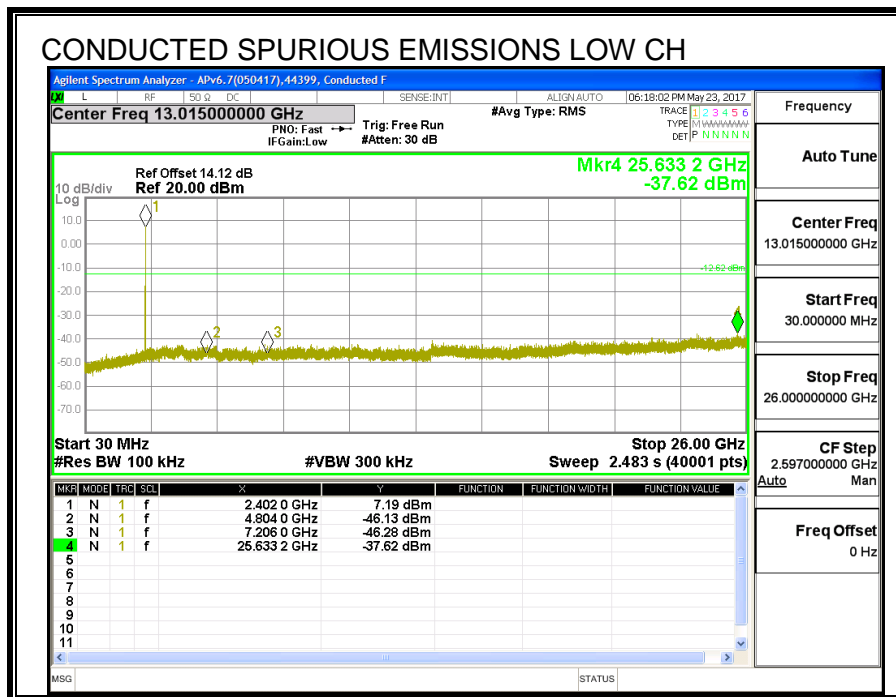
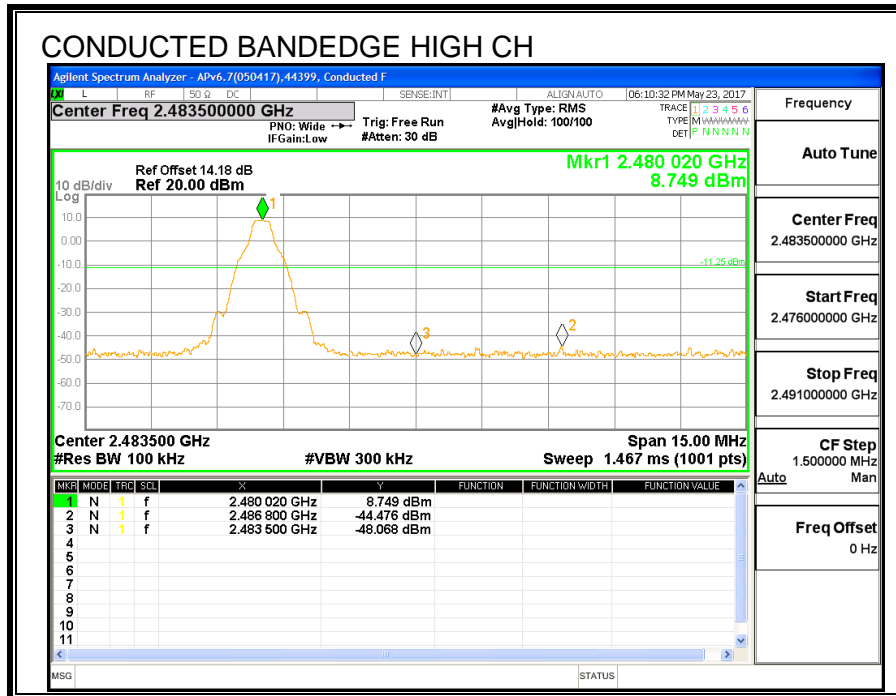

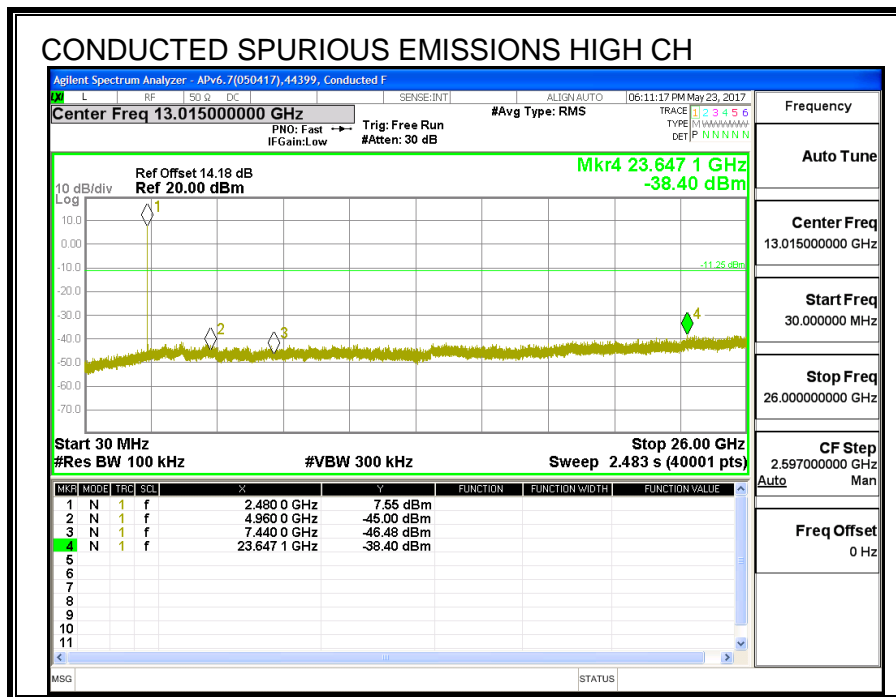
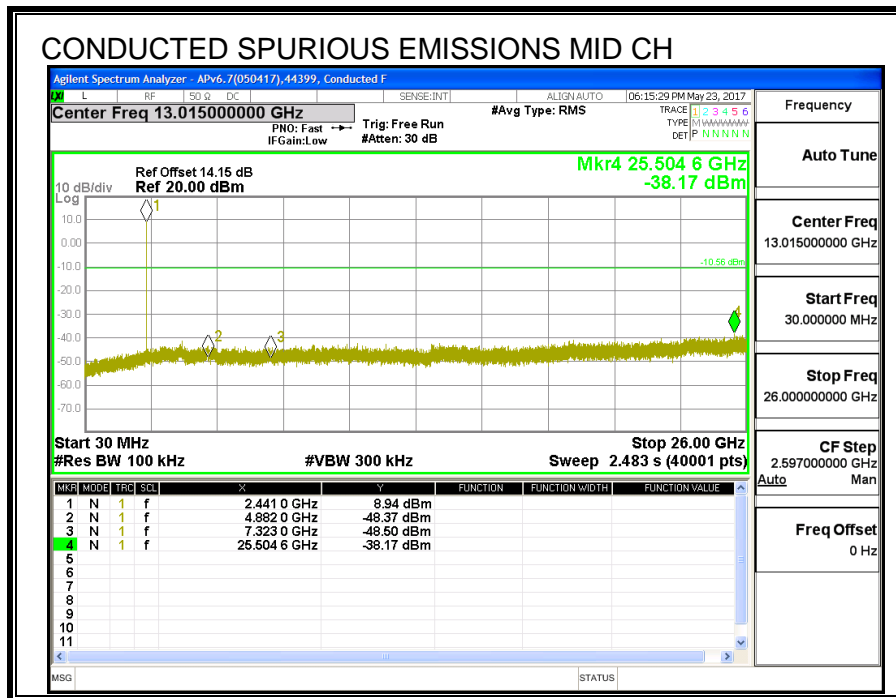

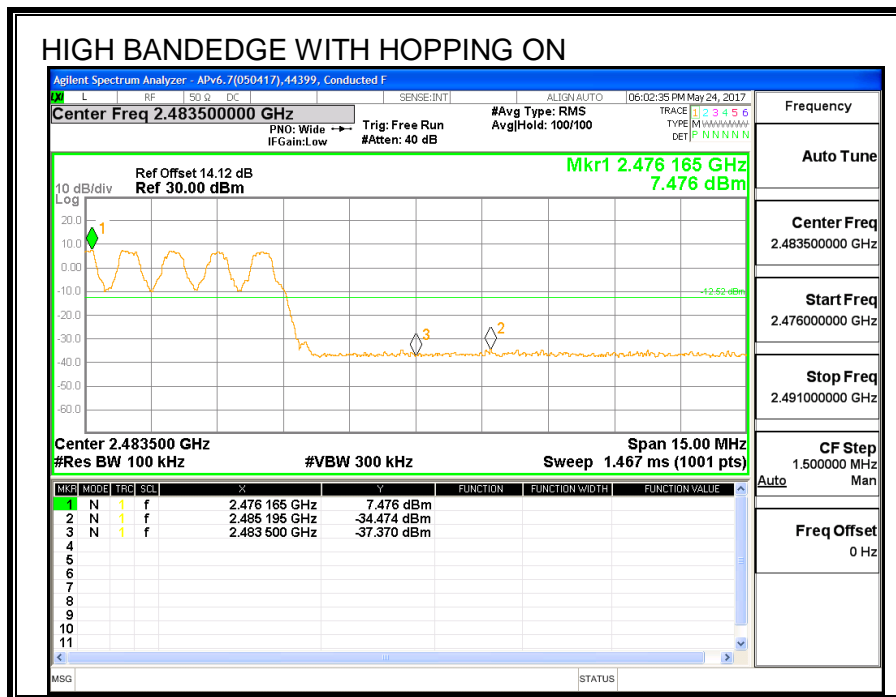
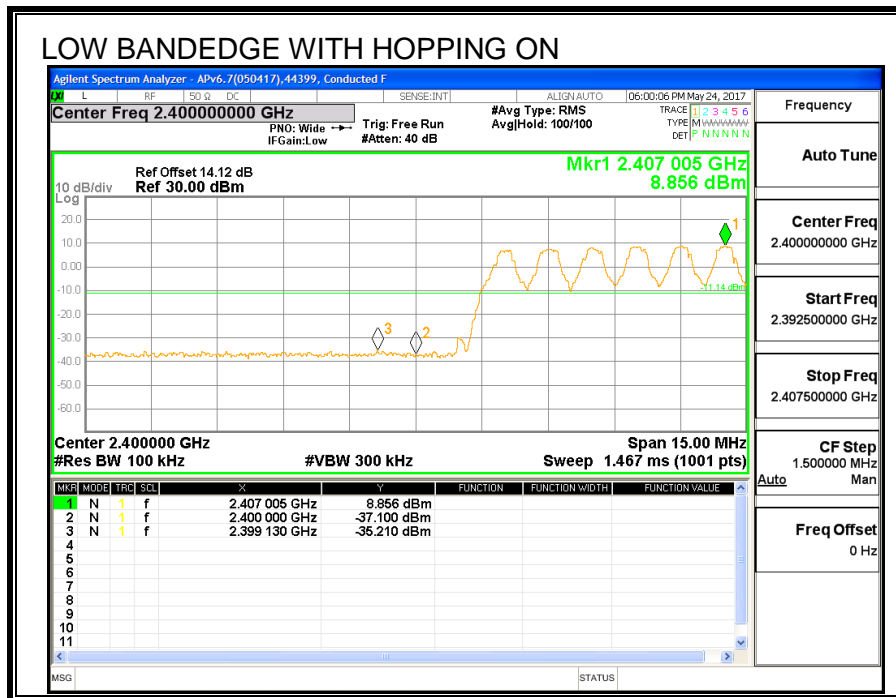

## 8.5. UAT 1, Plow ENHANCED DATA RATE DQPSK MODULATION

### 8.5.1. OUTPUT POWER

<b>ID:</b>	38806	<b>Date:</b>	7/29/17
------------	-------	--------------	---------

#### LIMITS

§15.247 (b) (1)

RSS-247 (5.4) (b)

The maximum antenna gain is less than 6 dBi, therefore the limit is 30 dBm. Alternatively, frequency hopping systems operating in the 2400-2483.5 MHz band may have hopping channel carrier frequencies that are separated by 25 kHz or two-thirds of the 20 dB bandwidth of the hopping channel, whichever is greater, provided the systems operate with an output power no greater than 125 mW

#### TEST PROCEDURE

The transmitter output is connected to a wideband peak and average power meter.

#### RESULTS

Channel	Frequency (MHz)	Output Power (dBm)	Limit (dBm)	Margin (dB)
Low	2402	10.02	21	-10.98
Middle	2441	10.19	21	-10.81
High	2480	10.16	21	-10.84

---

**8.5.2. AVERAGE POWER**

<b>ID:</b>	44353	<b>Date:</b>	7/29/17
------------	-------	--------------	---------

**LIMITS**

None; for reporting purposes only.

**TEST PROCEDURE**

The transmitter output is connected to a power meter.

**RESULTS**

The cable assembly insertion loss of 11 dB (including 10 dB pad and 1 dB cable) was entered as an offset in the power meter to allow for direct reading of power.

<b>Channel</b>	<b>Frequency (MHz)</b>	<b>Average Power (dBm)</b>
Low	2402	7.77
Middle	2441	7.81
High	2480	7.80

---

## 8.6. UAT 1, Plow ENHANCED DATA RATE 8PSK MODULATION

### 8.6.1. 20 dB AND 99% BANDWIDTH

#### LIMITS

None; for reporting purposes only.

#### TEST PROCEDURE

The transmitter output is connected to a spectrum analyzer. The RBW is set to  $\geq 1\%$  of the 20 dB bandwidth. The VBW is set to  $\geq$  RBW. The sweep time is coupled.

#### RESULTS

Channel	Frequency (MHz)	20 dB Bandwidth (KHz)	99% Bandwidth (KHz)
Low	2402	1353	1229.8
Middle	2441	1358	1255.8
High	2480	1388	1247.3

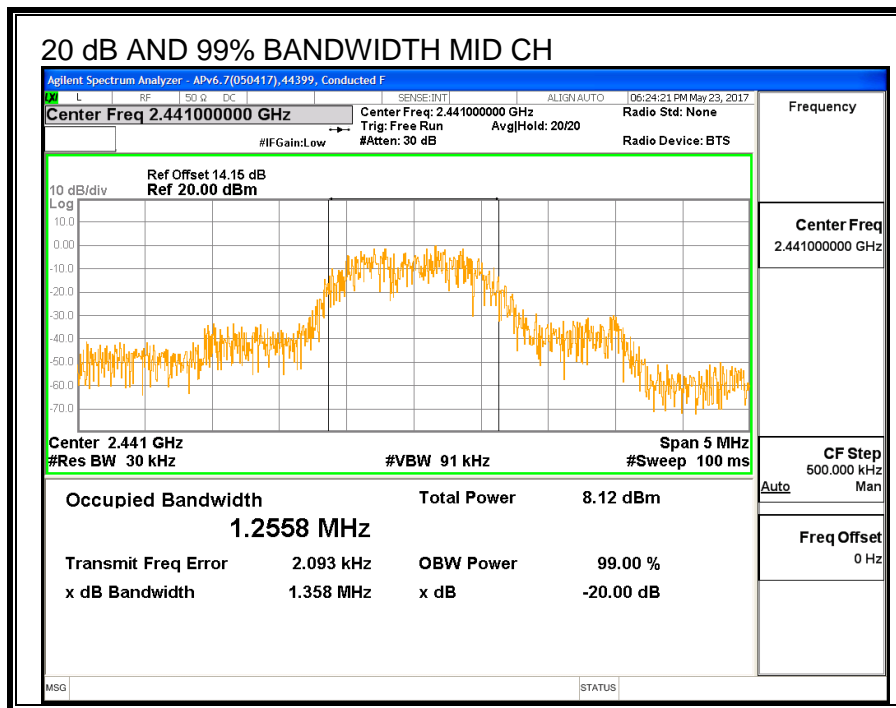
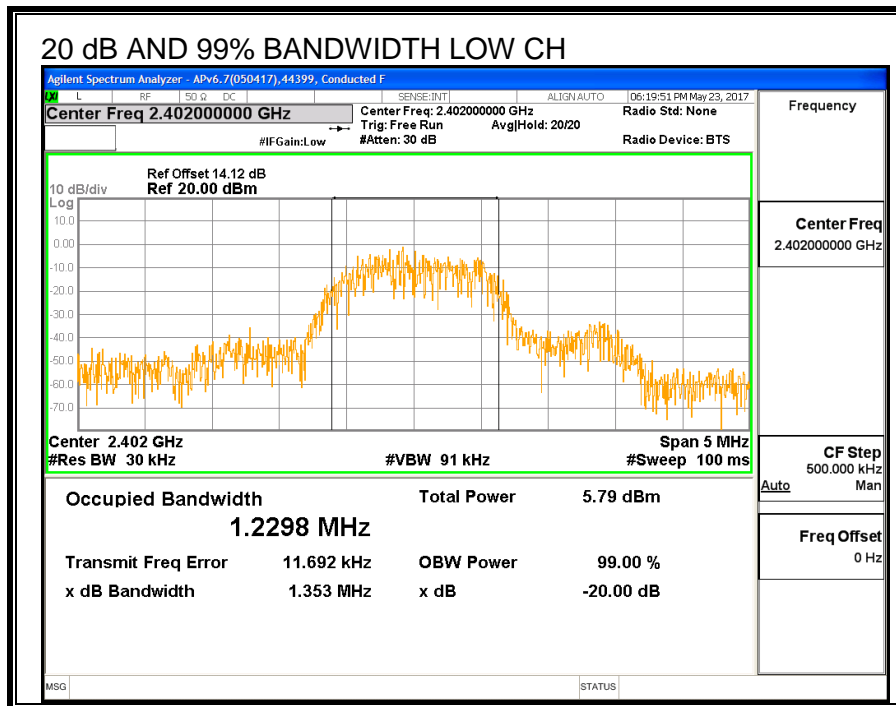



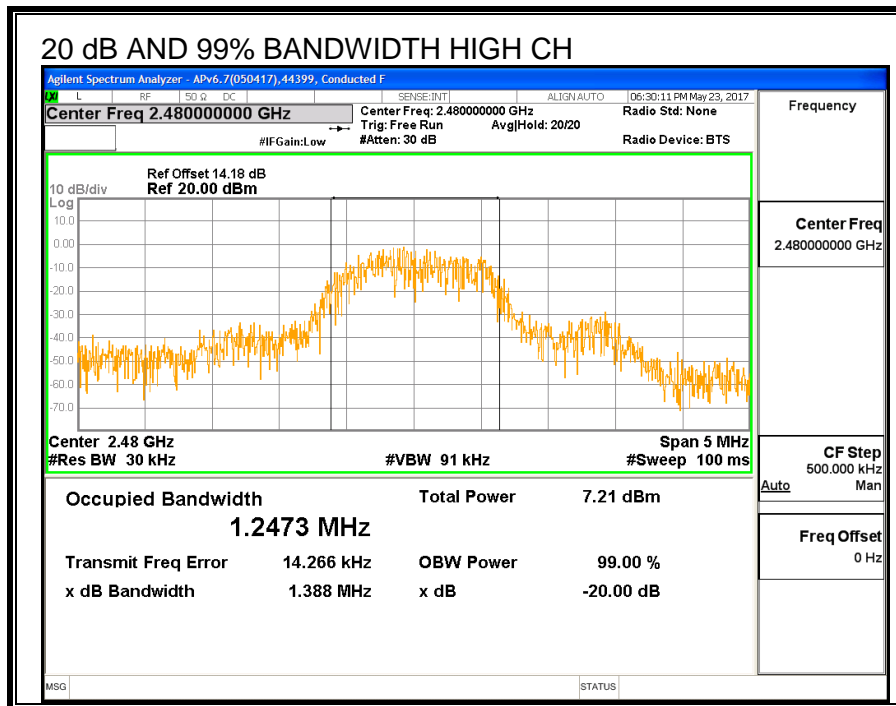

## 8.6.2. HOPPING FREQUENCY SEPARATION

### LIMITS

FCC §15.247 (a) (1)

IC RSS-247 (5.1) (b)

Frequency hopping systems shall have hopping channel carrier frequencies separated by a minimum of 25 kHz or the 20 dB bandwidth of the hopping channel, whichever is greater.

Alternatively, frequency hopping systems operating in the 2400-2483.5 MHz band may have hopping channel carrier frequencies that are separated by 25 kHz or two-thirds of the 20 dB bandwidth of the hopping channel, whichever is greater, provided the systems operate with an output power no greater than 125 mW.

### TEST PROCEDURE

The transmitter output is connected to a spectrum analyzer. The RBW is set to 300 kHz and the VBW is set to 910 kHz. The sweep time is coupled.

### RESULTS

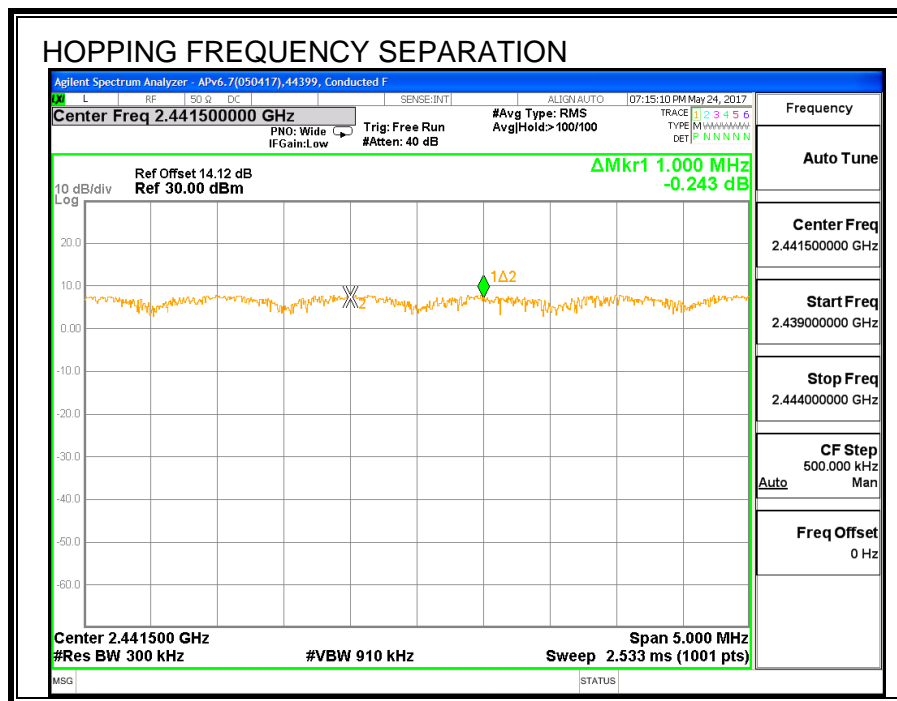

### 8.6.3. NUMBER OF HOPPING CHANNELS

#### LIMITS

FCC §15.247 (a) (1) (iii)

IC RSS-247 (5.1) (d)

Frequency hopping systems in the 2400 – 2483.5 MHz band shall use at least 15 non-overlapping channels.

#### TEST PROCEDURE

The transmitter output is connected to a spectrum analyzer. The span is set to cover the entire authorized band, in either a single sweep or in multiple contiguous sweeps. The RBW is set to a maximum of 1 % of the span. The analyzer is set to Max Hold.

#### RESULTS

Normal Mode: 79 Channels observed.

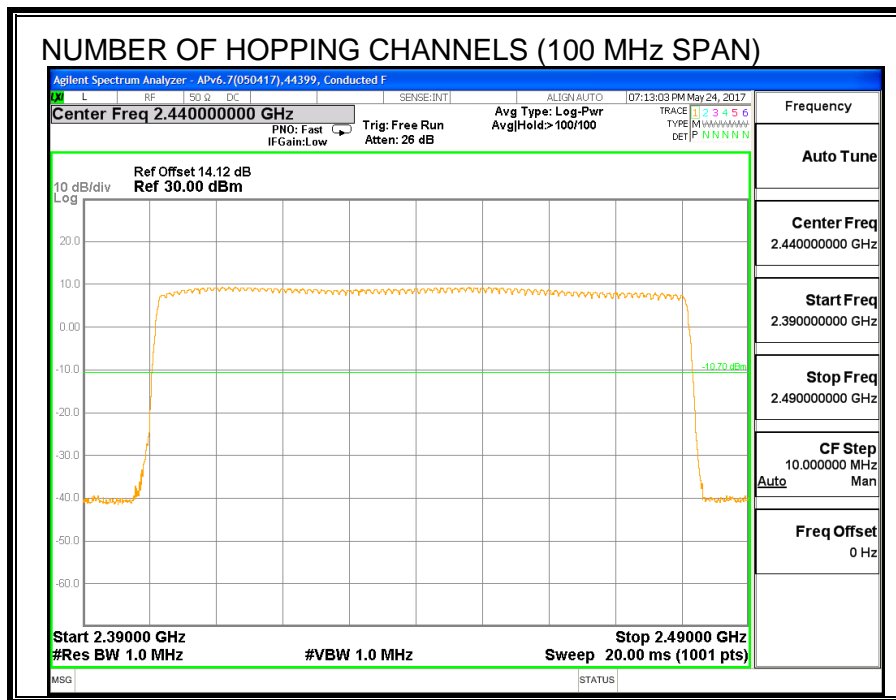

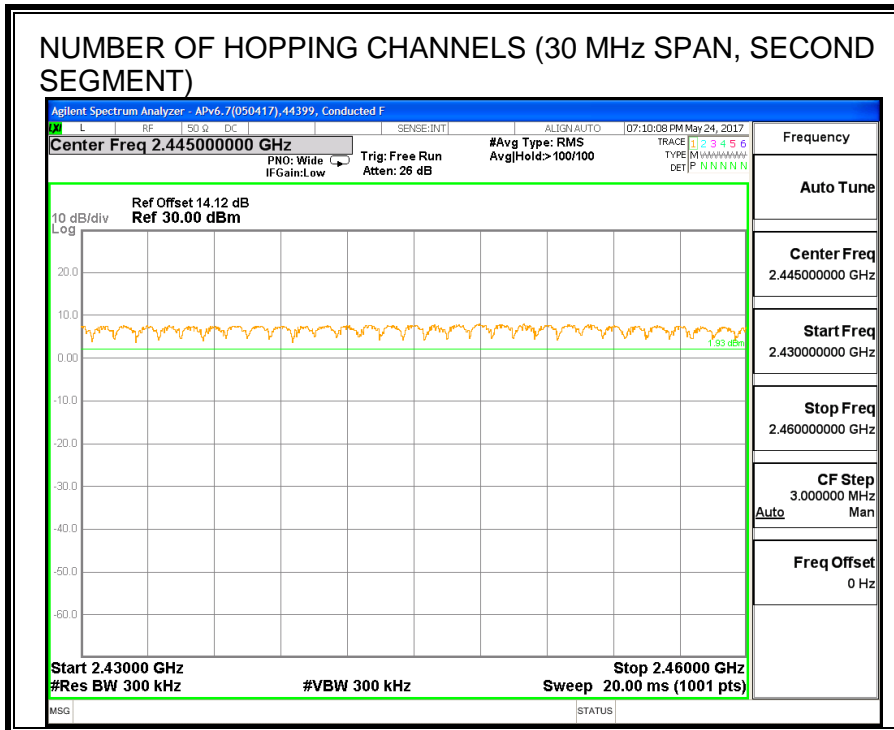
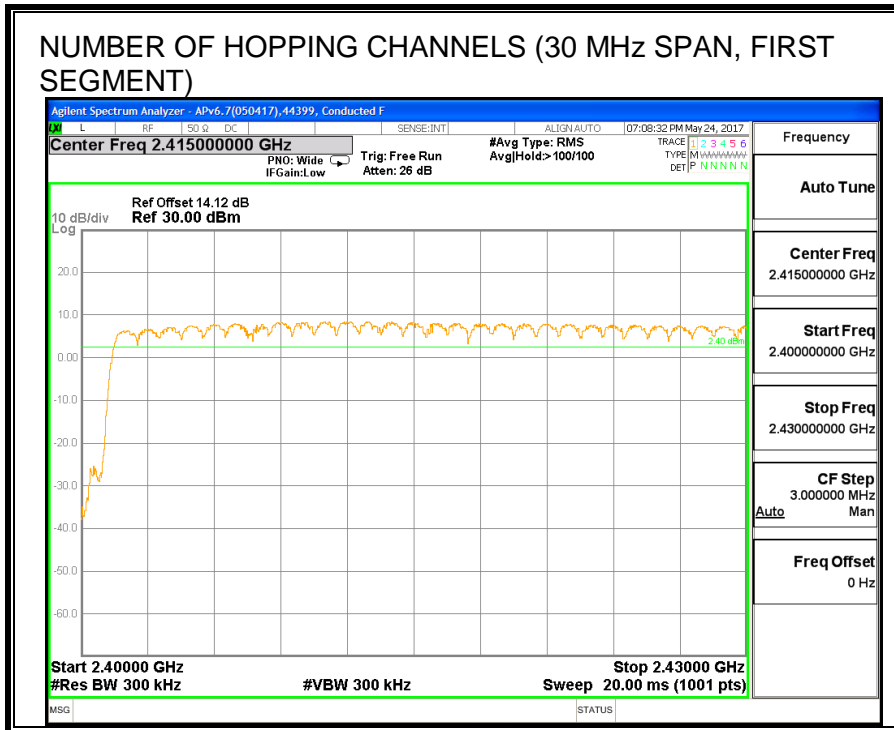

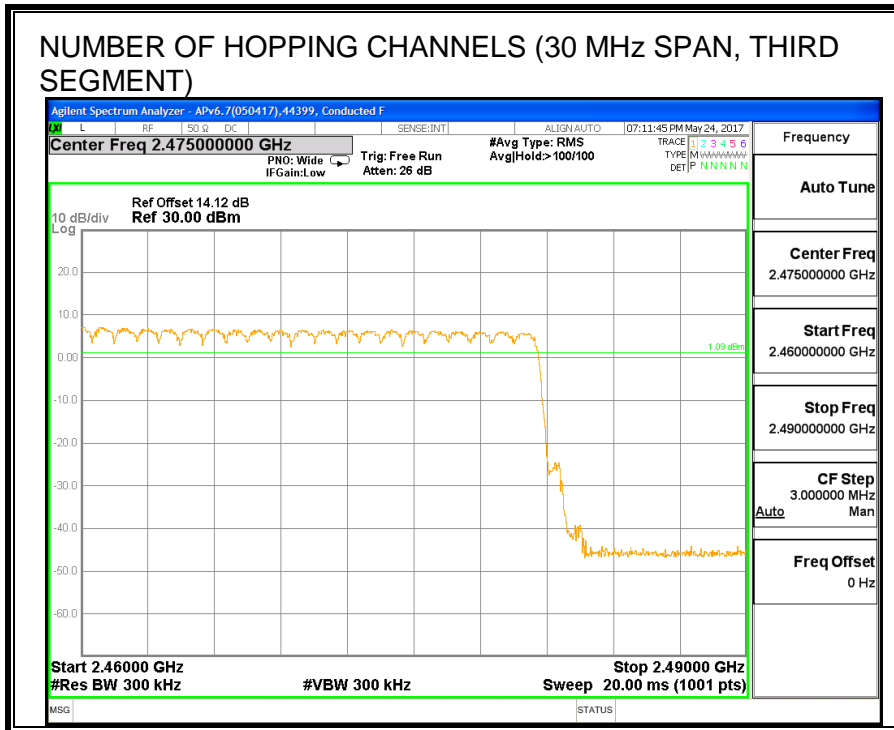

**8.6.4. AVERAGE TIME OF OCCUPANCY**

**LIMITS**

FCC §15.247 (a) (1) (iii)

IC RSS-247 (5.1) (d)

The average time of occupancy on any channel shall not be greater than 0.4 seconds within a period of 0.4 seconds multiplied by the number of hopping channels employed.

**TEST PROCEDURE**

The transmitter output is connected to a spectrum analyzer. The span is set to 0 Hz, centered on a single, selected hopping channel. The width of a single pulse is measured in a fast scan. The number of pulses is measured in a 3.16 second scan, to enable resolution of each occurrence.

The average time of occupancy in the specified 31.6 second period (79 channels \* 0.4 s) is equal to  $10 * (\# \text{ of pulses in } 3.16 \text{ s}) * \text{ pulse width}$ .

For AFH mode, the average time of occupancy in the specified 8 second period (20 channels \* 0.4 seconds) is equal to  $10 * (\# \text{ of pulses in } 0.8 \text{ s}) * \text{ pulse width}$ .

**RESULTS**

DH Packet	Pulse Width (msec)	Number of Pulses in 3.16 seconds	Average Time of Occupancy (sec)	Limit (sec)	Margin (sec)
8PSK (EDR) Mode					
3DH1	0.383	32	0.123	0.4	-0.277
3DH3	1.639	18	0.295	0.4	-0.105
3DH5	2.891	13	0.376	0.4	-0.024

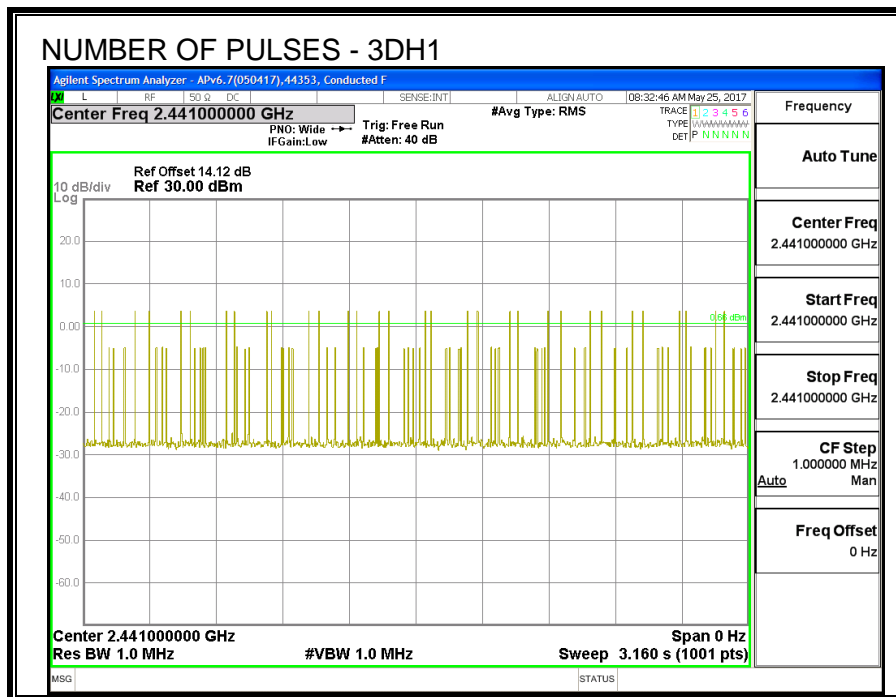







### 8.6.5. OUTPUT POWER

<b>ID:</b>	38806	<b>Date:</b>	7/29/17
------------	-------	--------------	---------

#### LIMITS

§15.247 (b) (1)

RSS-247 (5.4) (b)

The maximum antenna gain is less than 6 dBi, therefore the limit is 30 dBm. Alternatively, frequency hopping systems operating in the 2400-2483.5 MHz band may have hopping channel carrier frequencies that are separated by 25 kHz or two-thirds of the 20 dB bandwidth of the hopping channel, whichever is greater, provided the systems operate with an output power no greater than 125 mW

#### TEST PROCEDURE

The transmitter output is connected to a wideband peak and average power meter.

#### RESULTS

Channel	Frequency (MHz)	Output Power (dBm)	Limit (dBm)	Margin (dB)
Low	2402	10.07	21	-10.93
Middle	2441	10.25	21	-10.75
High	2480	10.21	21	-10.79

**8.6.6. AVERAGE POWER**

<b>ID:</b>	44353	<b>Date:</b>	7/29/17
------------	-------	--------------	---------

**LIMITS**

None; for reporting purposes only.

**TEST PROCEDURE**

The transmitter output is connected to a power meter.

**RESULTS**

The cable assembly insertion loss of 11 dB (including 10 dB pad and 1 dB cable) was entered as an offset in the power meter to allow for direct reading of power.

<b>Channel</b>	<b>Frequency (MHz)</b>	<b>Average Power (dBm)</b>
Low	2402	7.88
Middle	2441	7.94
High	2480	7.91

### **8.6.7. CONDUCTED SPURIOUS EMISSIONS**

#### **LIMITS**

FCC §15.247 (d)

IC RSS-247 (5.5)

Limit = -20 dBc

#### **TEST PROCEDURE**

The transmitter output is connected to a spectrum analyzer. The resolution bandwidth is set to 100 kHz. The video bandwidth is set to 300 kHz.

The spectrum from 30 MHz to 26 GHz is investigated with the transmitter set to the lowest, middle, and highest channels.

The bandedges at 2.4 and 2.4835 GHz are investigated with the transmitter set to the normal hopping mode.

#### **RESULTS**

**CONDUCTED BANDEDGE AND SPURIOUS EMISSIONS**

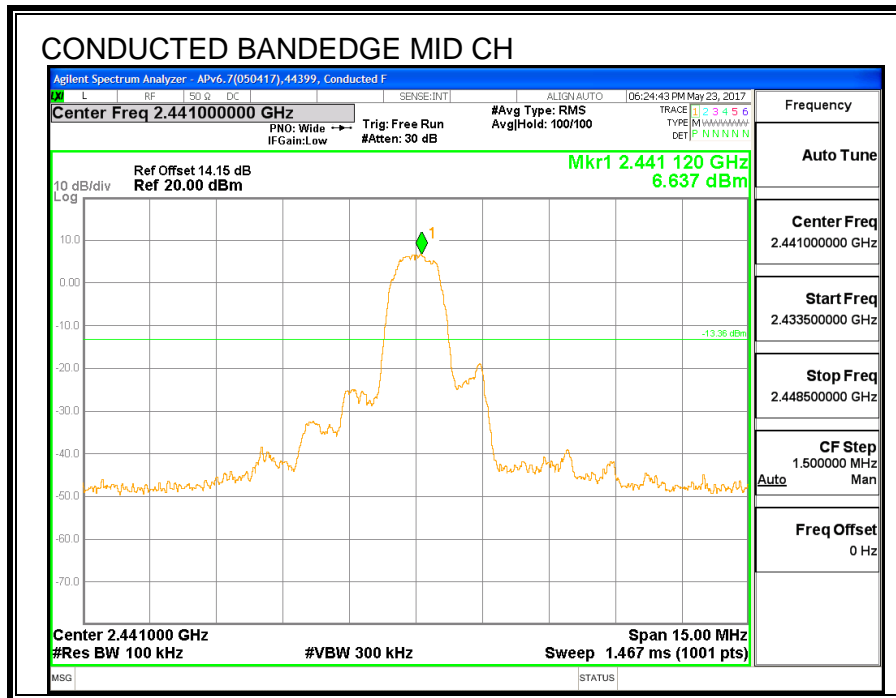
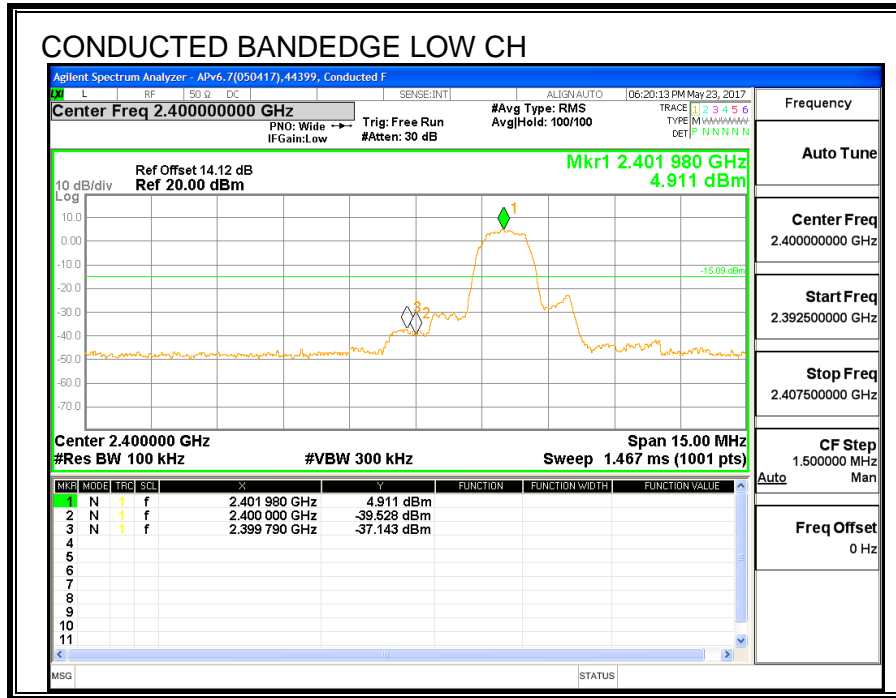

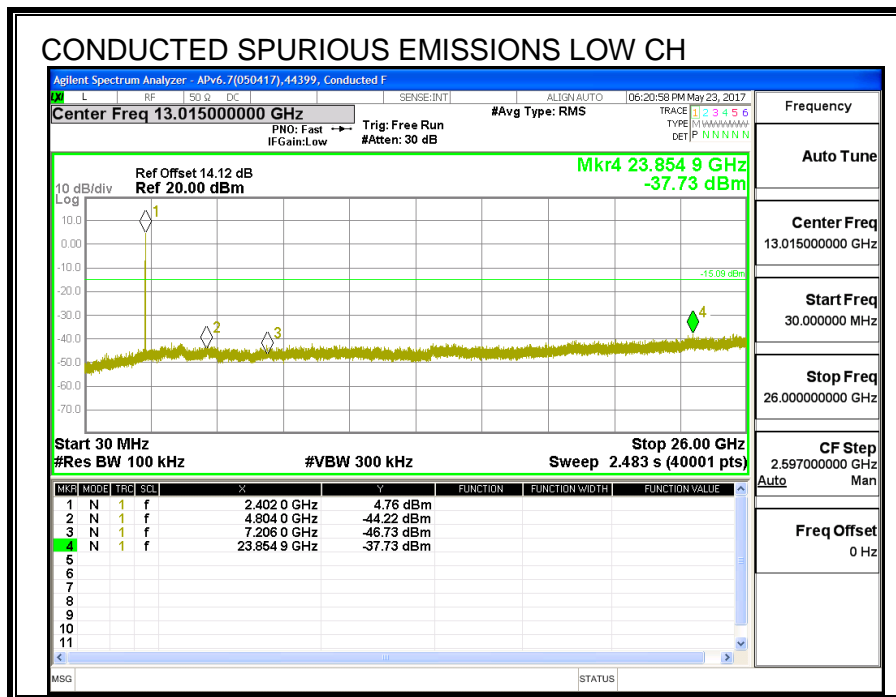
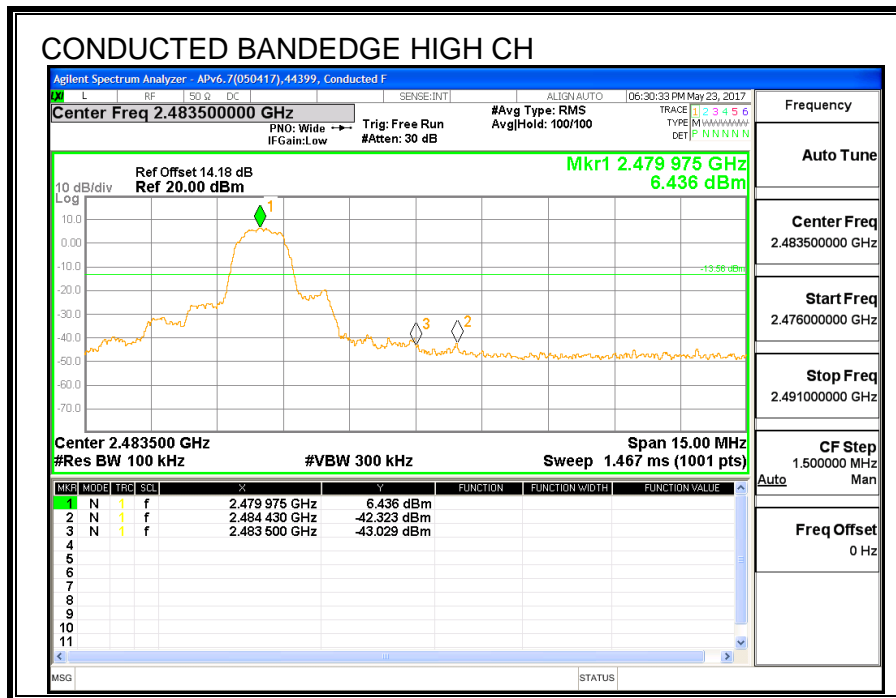

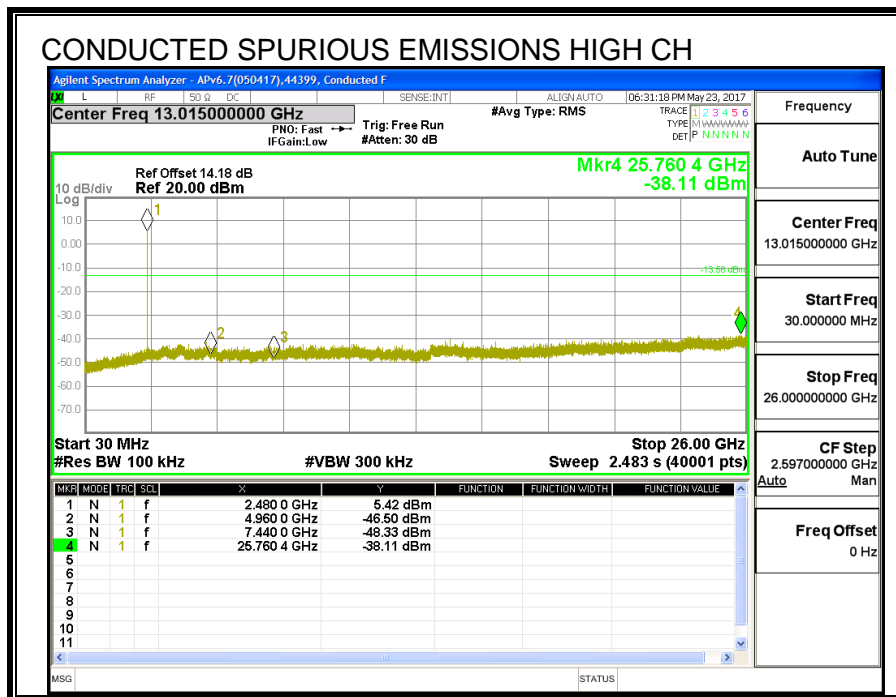
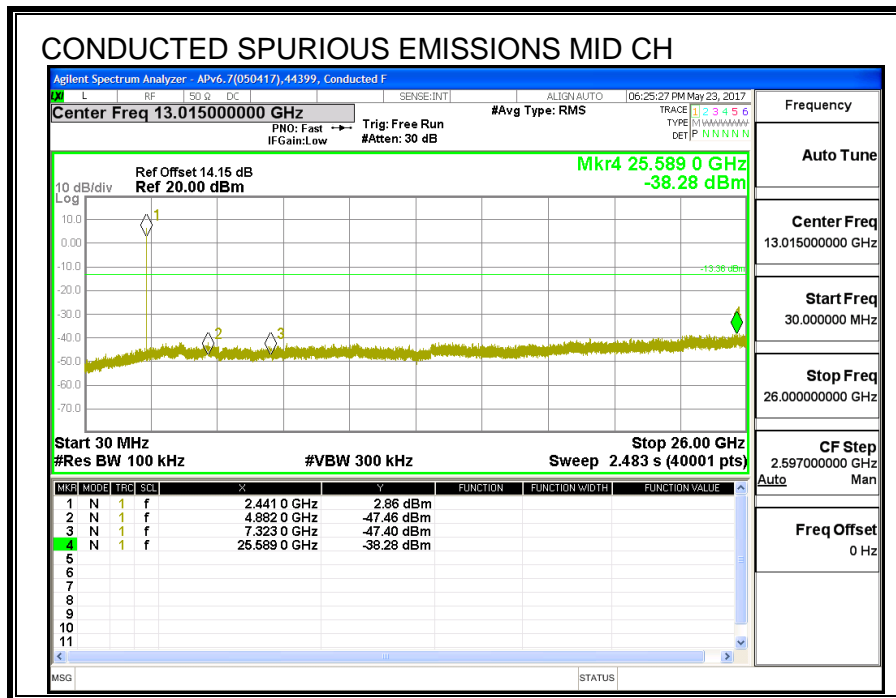

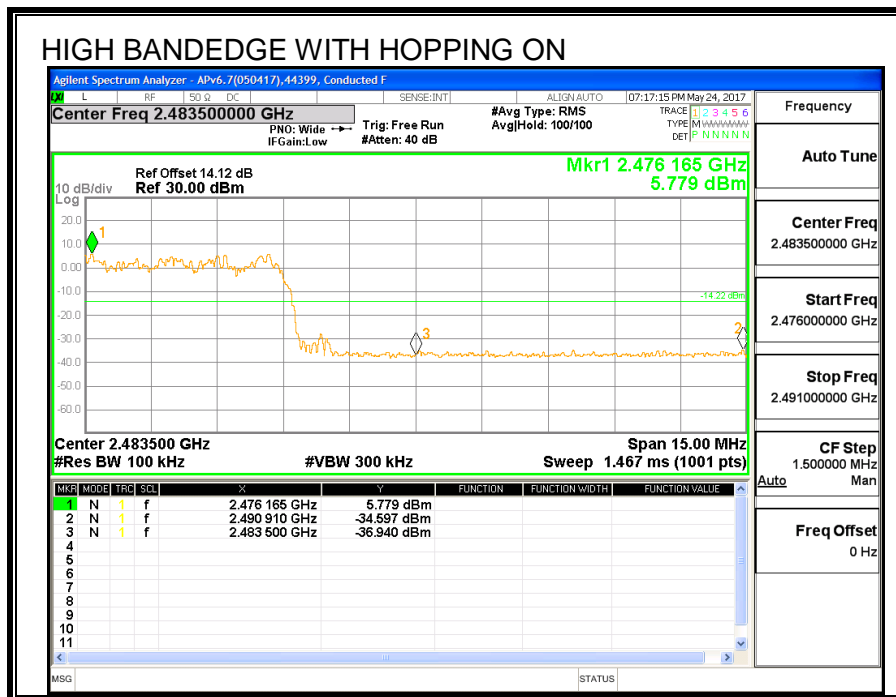
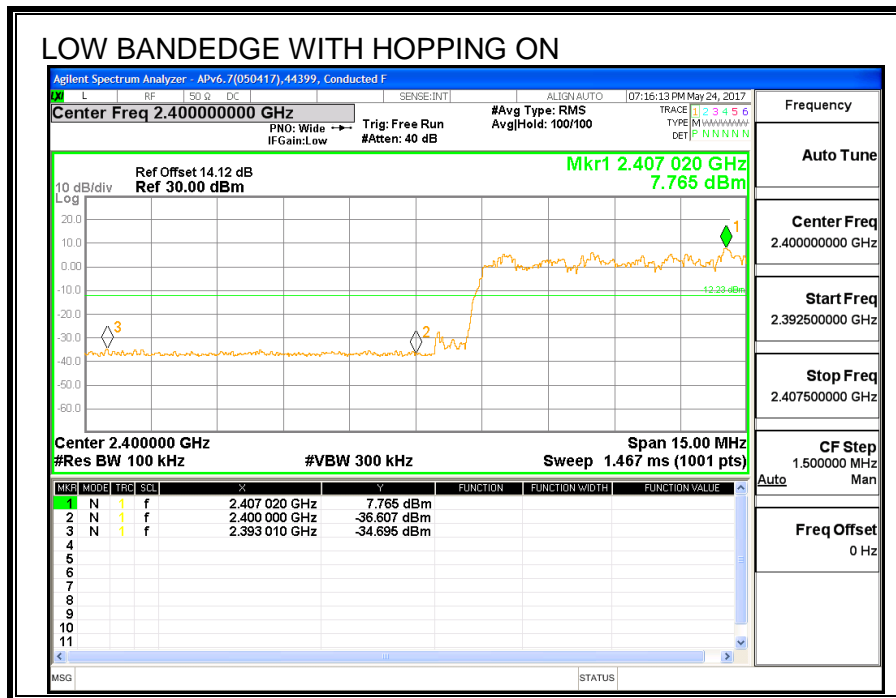



---

## 8.7. LAT 3, Pmax BASIC DATA RATE GFSK MODULATION

### 8.7.1. 20 dB AND 99% BANDWIDTH

#### LIMITS

None; for reporting purposes only.

#### TEST PROCEDURE

The transmitter output is connected to a spectrum analyzer. The RBW is set to  $\geq 1\%$  of the 20 dB bandwidth. The VBW is set to  $\geq$  RBW. The sweep time is coupled.

#### RESULTS

Channel	Frequency (MHz)	20 dB Bandwidth (KHz)	99% Bandwidth (KHz)
Low	2402	890.7	860.22
Middle	2441	838.2	861.09
High	2480	951.4	913.43

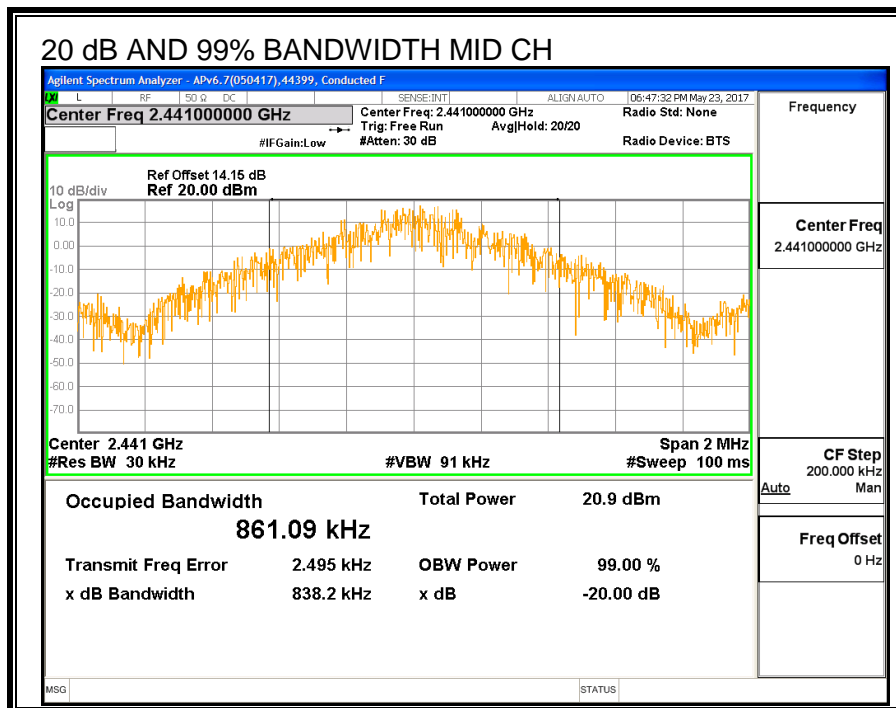
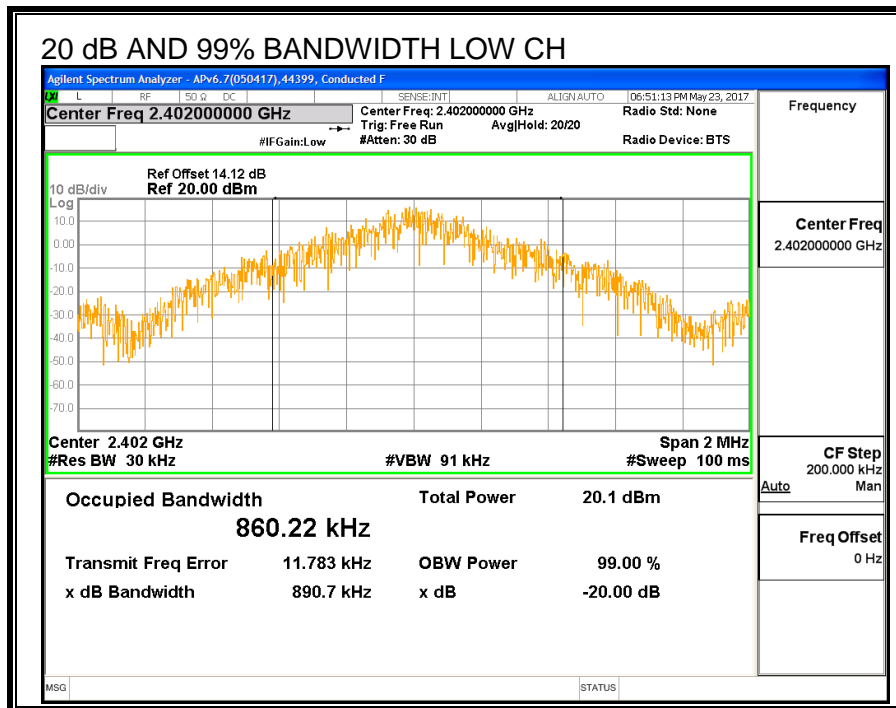

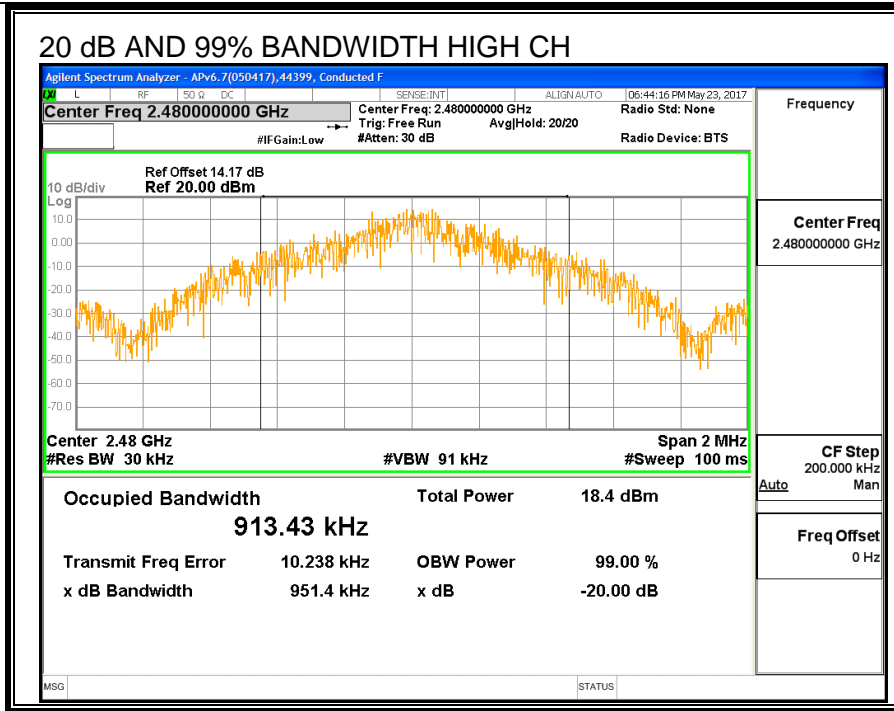

### 8.7.2. HOPPING FREQUENCY SEPARATION

#### LIMITS

FCC §15.247 (a) (1)

IC RSS-247 (5.1) (b)

Frequency hopping systems shall have hopping channel carrier frequencies separated by a minimum of 25 kHz or the 20 dB bandwidth of the hopping channel, whichever is greater.

Alternatively, frequency hopping systems operating in the 2400-2483.5 MHz band may have hopping channel carrier frequencies that are separated by 25 kHz or two-thirds of the 20 dB bandwidth of the hopping channel, whichever is greater, provided the systems operate with an output power no greater than 125 mW.

#### TEST PROCEDURE

The transmitter output is connected to a spectrum analyzer. The RBW is set to 300 kHz and the VBW is set to 910 kHz. The sweep time is coupled.

#### RESULTS

