

# FCC and ISED Test Report

Apple Inc  
Model: A3120



In accordance with FCC 47 CFR Part 15B and ICES-003 and ISED RSS-GEN

Prepared for: Apple Inc  
One Apple Park Way  
Cupertino  
California  
95014  
USA

FCC ID: BCGA3120

IC: 579C-A3120

## COMMERCIAL-IN-CONFIDENCE

Document 75960545-03 Issue 01

### SIGNATURE

NAME	JOB TITLE	RESPONSIBLE FOR	ISSUE DATE
John Laydon	General manager	Authorised Signatory	26-April-2024

Signatures in this approval box have checked this document in line with the requirements of TÜV SÜD document control rules.

### ENGINEERING STATEMENT

The measurements shown in this report were made in accordance with the procedures described on test pages. All reported testing was carried out on a sample equipment to demonstrate limited compliance with FCC 47 CFR Part 15B and ICES-003 and ISED RSS-GEN. The sample tested was found to comply with the requirements defined in the applied rules.

RESPONSIBLE FOR	NAME	DATE	SIGNATURE
Testing	Connor Lee	26-April-2024	
Testing	Jonas Ayipah	26-April-2024	
Testing	Muhammad Enam	26-April-2024	

FCC Accreditation

492497/UK2010 Octagon House, Fareham Test Laboratory

ISED Accreditation

12669A Octagon House, Fareham Test Laboratory

### EXECUTIVE SUMMARY

A sample of this product was tested and found to be compliant with FCC 47 CFR Part 15B, ICES-003 and ISED RSS-GEN: 2022, Issue 7: 2020 and Issue 5 and A2 (2021-02) for the tests detailed in section 1.3.



#### DISCLAIMER AND COPYRIGHT

This non-binding report has been prepared by TÜV SÜD with all reasonable skill and care. The document is confidential to the potential Client and TÜV SÜD. No part of this document may be reproduced without the prior written approval of TÜV SÜD. © 2024 TÜV SÜD. This report relates only to the actual item/items tested.

#### ACCREDITATION

Our UKAS Accreditation does not cover opinions and interpretations and any expressed are outside the scope of our UKAS Accreditation. Results of tests not covered by our UKAS Accreditation Schedule are marked NUA (Not UKAS Accredited). Results of tests covered by our Flexible UKAS Accreditation Schedule are marked FS (Flexible Scope).

TÜV SÜD  
is a trading name of TÜV SÜD Ltd  
Registered in Scotland at East Kilbride,  
Glasgow G75 0QF, United Kingdom  
Registered number: SC215164

TÜV SÜD Ltd is a  
TÜV SÜD Group Company

Phone: +44 (0) 1489 558100  
Fax: +44 (0) 1489 558101  
[www.tuvsud.com/en](http://www.tuvsud.com/en)

TÜV SÜD  
Octagon House  
Concorde Way  
Fareham  
Hampshire PO15 5RL  
United Kingdom



## Contents

<b>1</b>	<b>Report Summary .....</b>	<b>2</b>
1.1	Report Modification Record.....	2
1.2	Introduction.....	2
1.3	Brief Summary of Results .....	3
1.4	Product Information .....	4
1.5	Deviations from the Standard.....	4
1.6	Identification of the EUT .....	4
1.7	EUT Modification Record .....	5
1.8	Test Location .....	5
<b>2</b>	<b>Test Details .....</b>	<b>6</b>
2.1	Conducted Disturbance at Mains Terminals .....	6
2.2	Radiated Disturbance .....	11
<b>3</b>	<b>Test Equipment Information .....</b>	<b>18</b>
3.1	General Test Equipment Used.....	18
<b>4</b>	<b>Incident Reports .....</b>	<b>19</b>
<b>5</b>	<b>Measurement Uncertainty .....</b>	<b>20</b>



# 1 Report Summary

## 1.1 Report Modification Record

Alterations and additions to this report will be issued to the holders of each copy in the form of a complete document.

Issue	Description of Change	Date of Issue
1	First Issue	26-April-2024

**Table 1**

## 1.2 Introduction

Applicant	Apple Inc
Manufacturer	Apple Inc
EUT/Sample Identification	Refer to section 1.6
Test Specification/Issue/Date	FCC 47 CFR Part 15B, ICES-003 and ISED RSS-GEN: 2022, Issue 7: 2020 and Issue 5 and A2 (2021-02)
Start of Test	06-March-2024
Finish of Test	07-March-2024
Name of Engineer(s)	Connor Lee, Jonas Ayipah and Muhammad Enam
Related Document(s)	ANSI C63.4: 2014



### 1.3 Brief Summary of Results

A brief summary of the tests carried out in accordance with FCC 47 CFR Part 15B and ICES-003 and ISED RSS-GEN is shown below.

Section	Specification Clause	Test Description	Result	Comments/Base Standard
Configuration and Mode: AC Powered - Transmitter Idle				
2.1	15.107, 3.1 and 8.8	Conducted Disturbance at Mains Terminals	Pass	ANSI C63.4: 2014
2.2	15.109, 3.2 and 7.1	Radiated Disturbance	Pass	ANSI C63.4: 2014

**Table 2**



**1.4 Product Information**

**1.4.1 Technical Description**

The equipment under test (EUT) was a wireless TrackPad.

**1.4.2 EUT Port/Cable Identification**

Port	Max Cable Length specified	Usage	Type	Screened
Configuration and Mode: AC Powered - Transmitter Idle				
AC Power Port	2 m	Power	AC to DC power adapter with USB-C output	No

**Table 3**

**1.4.3 Test Configuration**

Configuration	Description
AC Powered	The EUT was powered from a 120 V 60 Hz AC Mains supply using an AC to DC power adapter with USB-C output. No other connections to the EUT were made. PSU model: A2164.

**Table 4**

**1.4.4 Modes of Operation**

Mode	Description
Transmitters Idle	The EUT was powered with the Bluetooth transmitter disabled.

**Table 5**

**1.5 Deviations from the Standard**

No deviations from the applicable test standard were made during testing.

**1.6 Identification of the EUT**

The table below details identification of the EUT(s) that have been used to carry out the testing within this report.

Model: A3120			
Serial Number	Hardware Version	Software Version	Firmware
CC2H2D002J5000028F	REV1.0	2.5	-

**Table 6**



### 1.7 EUT Modification Record

The table below details modifications made to the EUT during the test programme.

The modifications incorporated during each test are recorded on the appropriate test pages.

Modification State	Description of Modification still fitted to EUT	Modification Fitted By	Date Modification Fitted
Model: A3120, Serial Number: CC2H2D002J5000028F			
0	As supplied by the customer	Not Applicable	Not Applicable

**Table 7**

### 1.8 Test Location

TÜV SÜD conducted the following tests at our Octagon House Test Laboratory.

Test Name	Name of Engineer(s)	Accreditation
Configuration and Mode: AC Powered - Transmitter Idle		
Conducted Disturbance at Mains Terminals	Connor Lee	UKAS
Radiated Disturbance	Jonas Ayipah and Muhammad Enam	UKAS

**Table 8**

Office Address:

TÜV SÜD  
Octagon House  
Concorde Way  
Fareham  
Hampshire  
PO15 5RL  
United Kingdom



## 2 Test Details

### 2.1 Conducted Disturbance at Mains Terminals

#### 2.1.1 Specification Reference

FCC 47 CFR Part 15B, Clause 15.107  
ICES-003, Clause 3.1  
ISED RSS-GEN, Clause 8.8

#### 2.1.2 Equipment Under Test and Modification State

A3120, S/N: CC2H2D002J5000028F - Modification State 0

#### 2.1.3 Date of Test

07-March-2024

#### 2.1.4 Test Method

The EUT was setup according to ANSI C63.4, clause 5.2.

The EUT was placed on a non-conductive table 0.8 m above a reference ground plane. A vertical coupling plane was placed 0.4 m from the EUT boundary. A Line Impedance Stabilisation Network (LISN) was directly bonded to the ground-plane. The EUT was located so that the distance between the boundary of the EUT and the closest surface of the LISN was 0.8 m.

Interconnecting cables that hanged closer than 0.4 m to the ground plane were folded back and forth in the centre forming a bundle 0.3 m to 0.4 m long.

Input and output cables were terminated with equipment or loads representative of real usage conditions.

The EUT was configured to give the highest level of emissions within reason of a typical installation as described by the manufacturer.

#### 2.1.5 Example Calculation

Quasi-Peak level (dB $\mu$ V) = Receiver level (dB $\mu$ V) + Correction Factor (dB)  
Margin (dB) = Quasi-Peak level (dB $\mu$ V) - Limit (dB $\mu$ V)

CISPR Average level (dB $\mu$ V) = Receiver level (dB $\mu$ V) + Correction Factor (dB)  
Margin (dB) = CISPR Average level (dB $\mu$ V) - Limit (dB $\mu$ V)

### 2.1.6 Example Test Setup Diagram

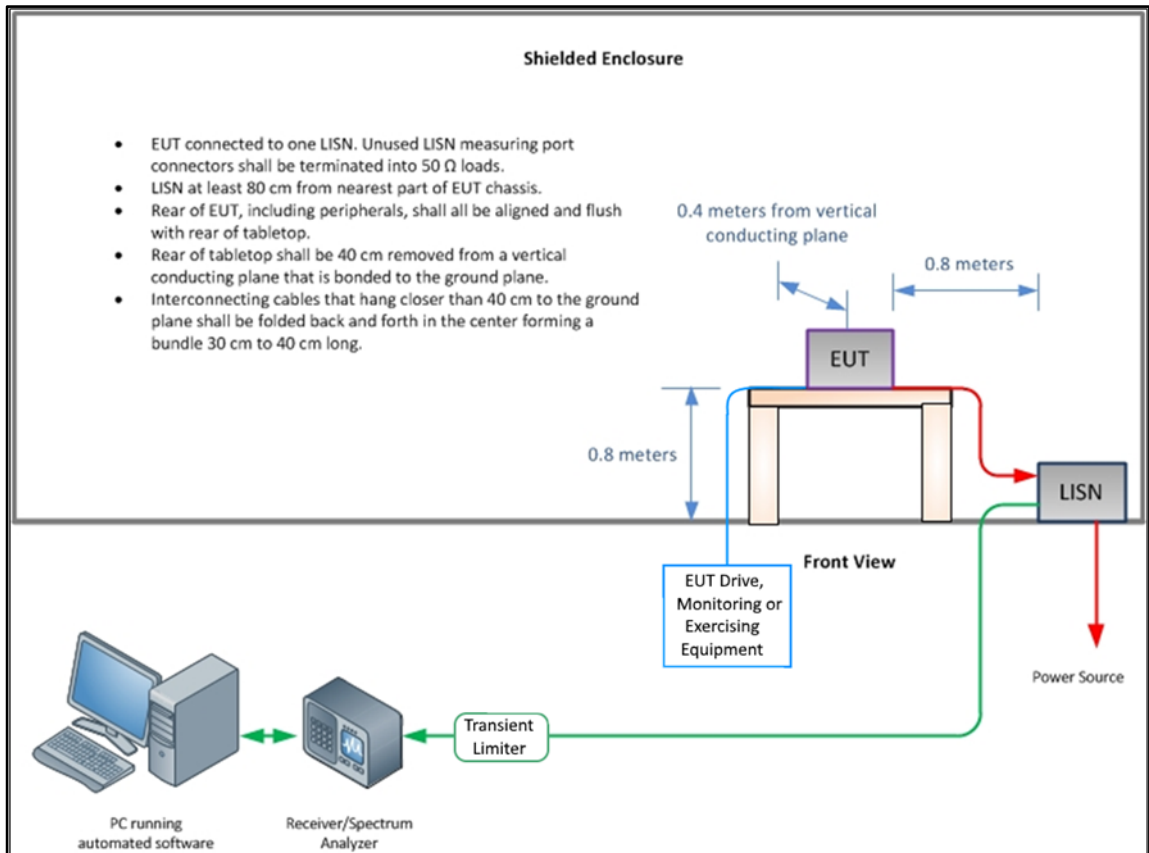

Figure 1 - Conducted Disturbance

### 2.1.7 Environmental Conditions

Ambient Temperature 23.5 °C  
 Relative Humidity 33.1 %  
 Atmospheric Pressure 1008.0 mbar

### 2.1.8 Specification Limits

Required Specification Limits - Class B			
Line Under Test	Frequency Range (MHz)	Quasi-Peak Test Limit (dBµV)	CISPR Average Test Limit (dBµV)
AC Power Port	0.15 to 0.5	66 to 56 <sup>(1)</sup>	56 to 46 <sup>(1)</sup>
	0.5 to 5	56	46
	5 to 30	60	50

**Supplementary information:**  
 Note 1. Decreases with the logarithm of the frequency.

Table 9





**2.1.9 Test Results**

**Results for Configuration and Mode: AC Powered - Transmitter Idle.**

**This test was performed to the requirements of the Class B limits.**

Performance assessment of the EUT made during this test: Pass.

Detailed results are shown below.

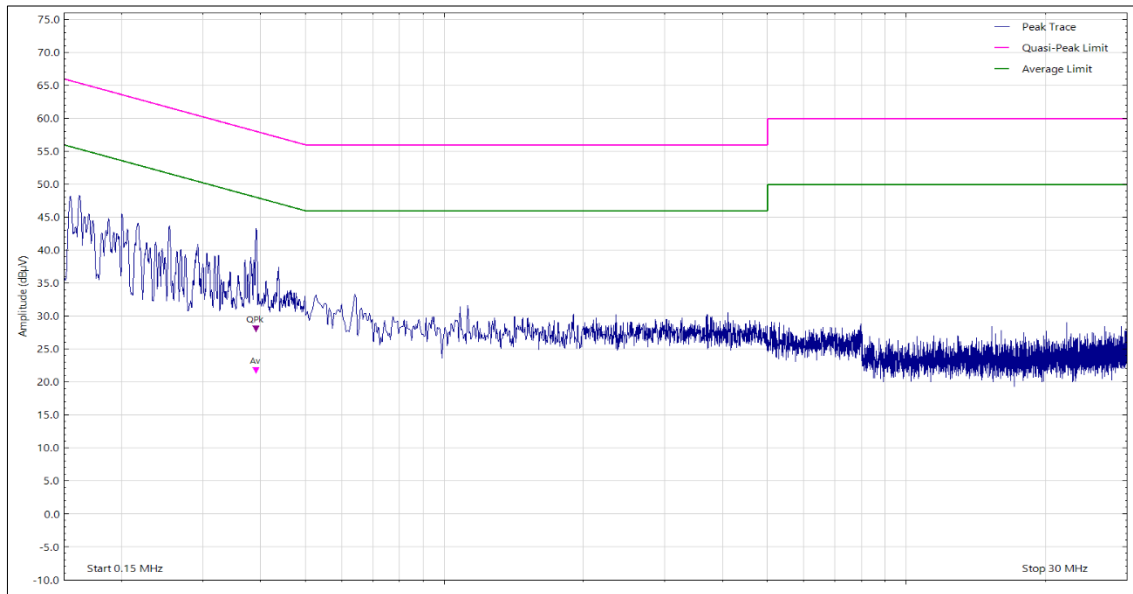
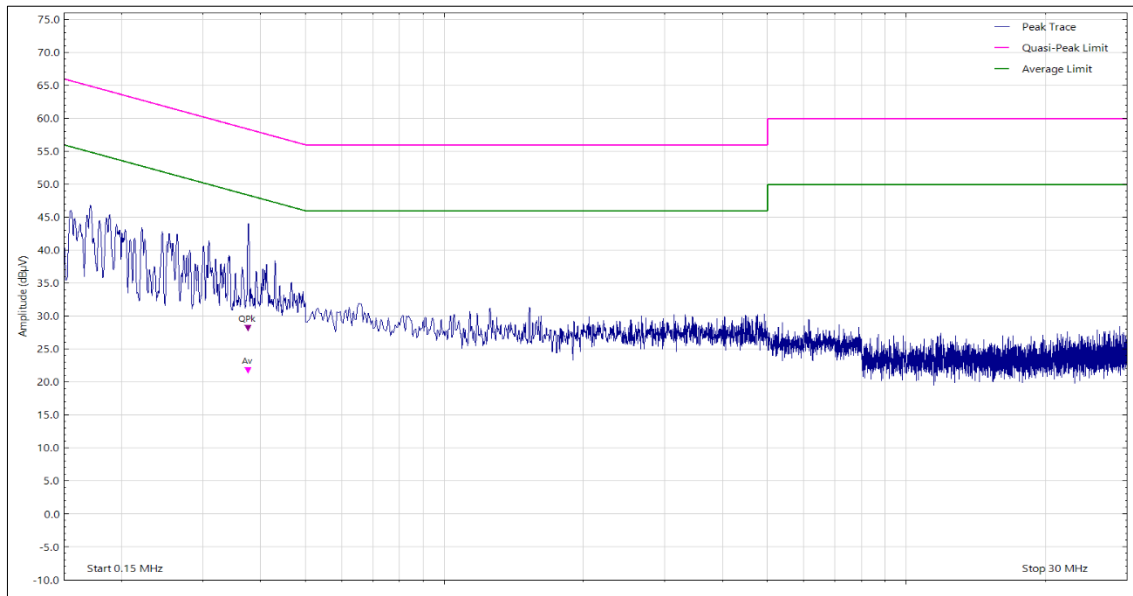

**Figure 2 - Graphical Results - Live Line**

Frequency (MHz)	Level (dBµV)	Limit (dBµV)	Margin (dB)	Detector
0.391	27.44	58.10	-30.66	Q-Peak
0.391	21.12	48.10	-26.98	CISPR Avg

**Table 10**

No other final measurements were made as all other peak emissions seen above the measurement system noise floor during the pre-scan were greater than 6 dB below the CISPR Average test limit.



**Figure 3 - Graphical Results - Neutral Line**

Frequency (MHz)	Level (dBµV)	Limit (dBµV)	Margin (dB)	Detector
0.376	27.51	58.40	-30.89	Q-Peak
0.376	21.16	48.40	-27.24	CISPR Avg

**Table 11**

No other final measurements were made as all other peak emissions seen above the measurement system noise floor during the pre-scan were greater than 6 dB below the CISPR Average test limit.



**2.1.10 Test Location and Test Equipment Used**

This test was carried out in EMC Chamber 12.

Instrument	Manufacturer	Type No	TE No	Calibration Period (months)	Calibration Expires
3m Semi-Anechoic Chamber	MVG	EMC Chamber 12	5621	36	07-Aug-2026
Emissions Software	TUV SUD	EmX V3.2.0	5125	-	Software
Test Receiver	Rohde & Schwarz	ESU40	3506	12	30-Mar-2024
Transient Limiter	Hewlett Packard	11947A	15	12	24-Oct-2024
Termination, N-Type(M) 10W, DC-3GHz	Aaren	AT40T-10E03	6565	12	18-Jun-2024
20dB Attenuator 250W	RF-Lambda	RFS250G1A20NMF	6616	12	29-Jul-2024
1 Meter Cable	Teledyne	PR90-088-1MTR	5194	12	10-Aug-2024
Cable (N-Type, 10 Hz-18 GHz)	Junkosha	MWX221-02000AMSAMS	5724	6	17-Aug-2024
Cable (N-Type to N-Type, 8 m)	Junkosha	MWX221-08000NMSNMS/B	6321	12	04-Feb-2025
LISN (CISPR 16, Single Phase)	Rohde & Schwarz	ESH3-Z5	1390	12	01-Feb-2025

**Table 12**



## 2.2 Radiated Disturbance

### 2.2.1 Specification Reference

FCC 47 CFR Part 15B, Clause 15.109  
ICES-003, Clause 3.2  
ISED RSS-GEN, Clause 7.1

### 2.2.2 Equipment Under Test and Modification State

A3120, S/N: CC2H2D002J5000028F - Modification State 0

### 2.2.3 Date of Test

06-March-2024 to 07-March-2024

### 2.2.4 Test Method

The EUT was set up on a non-conductive table 0.8 m above a reference ground plane.

within a semi-anechoic chamber on a remotely controlled turntable.

A pre-scan of the EUT emissions profile using a peak detector was made at a 3 m antenna distance whilst varying the antenna-to-EUT azimuth and polarisation.

For an EUT which could reasonable be used in multiple planes, pre-scans were performed with the EUT orientated in X, Y and Z planes with reference to the ground plane.

Using a list of the highest emissions detected during the pre-scan along with their bearing and associated antenna polarisation, the EUT was then formally measured using a Quasi-Peak, Peak or CISPR Average detector as appropriate.

The readings were maximised by adjusting the antenna height, polarisation and turntable azimuth, in accordance with the specification.

### 2.2.5 Example Calculation

Below 1 GHz:

$$\begin{aligned} \text{Quasi-Peak level (dB}\mu\text{V/m)} &= \text{Receiver level (dB}\mu\text{V)} + \text{Correction Factor (dB/m)} \\ \text{Margin (dB)} &= \text{Quasi-Peak level (dB}\mu\text{V/m)} - \text{Limit (dB}\mu\text{V/m)} \end{aligned}$$

Above 1 GHz:

$$\begin{aligned} \text{CISPR Average level (dB}\mu\text{V/m)} &= \text{Receiver level (dB}\mu\text{V)} + \text{Correction Factor (dB/m)} \\ \text{Margin (dB)} &= \text{CISPR Average level (dB}\mu\text{V/m)} - \text{Limit (dB}\mu\text{V/m)} \end{aligned}$$

$$\begin{aligned} \text{Peak level (dB}\mu\text{V/m)} &= \text{Receiver level (dB}\mu\text{V)} + \text{Correction Factor (dB/m)} \\ \text{Margin (dB)} &= \text{Peak level (dB}\mu\text{V/m)} - \text{Limit (dB}\mu\text{V/m)} \end{aligned}$$

### 2.2.6 Example Test Setup Diagram

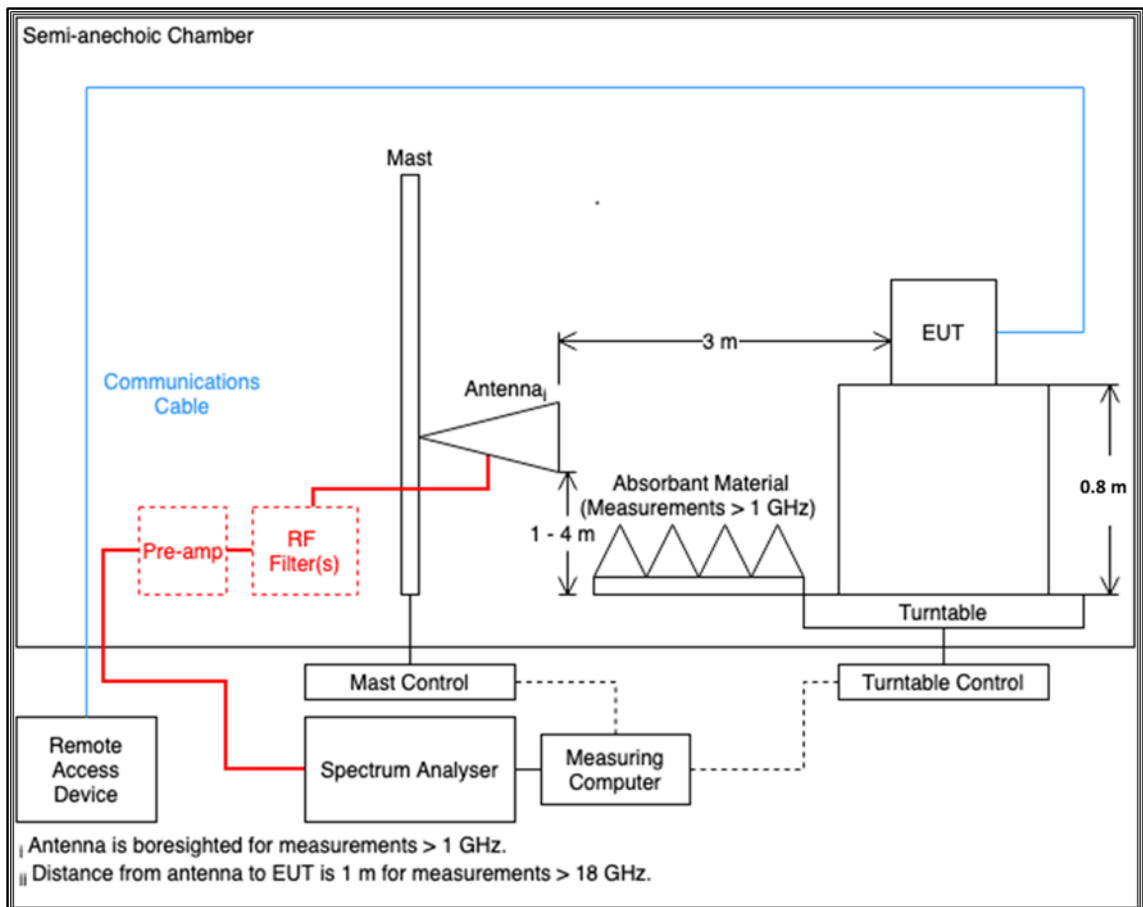

Figure 4 - Radiated Disturbance Example Test Setup

### 2.2.7 Environmental Conditions

Ambient Temperature 23.5 - 27.8 °C  
 Relative Humidity 33.1 - 40.5 %  
 Atmospheric Pressure 1008.0 - 1012.0 mbar

### 2.2.8 Specification Limits

Required Specification Limits, Field Strength - Class B Test Limit at a 3 m Measurement Distance		
Frequency Range (MHz)	Test Limit (µV/m)	Test Limit (dBµV/m)
30 to 88	100	40.0
88 to 216	150	43.5
216 to 960	200	46.0
Above 960	500	54.0

**Supplementary information:**  
 Note 1. A Quasi-peak detector is to be used for measurements below 1 GHz.  
 Note 2. A CISPR Average detector is to be used for measurements above 1 GHz.  
 Note 3. The Peak test limit above 1 GHz is 20 dB higher than the CISPR Average test limit.

Table 13



**2.2.9 Test Results**

**Results for Configuration and Mode: AC Powered - Transmitter Idle.**

**This test was performed to the requirements of the Class B limits.**

Performance assessment of the EUT made during this test: Pass.

Detailed results are shown below.

Highest frequency generated or used within the EUT: 2.4 GHz  
 Which necessitates an upper frequency test limit of: 13 GHz.

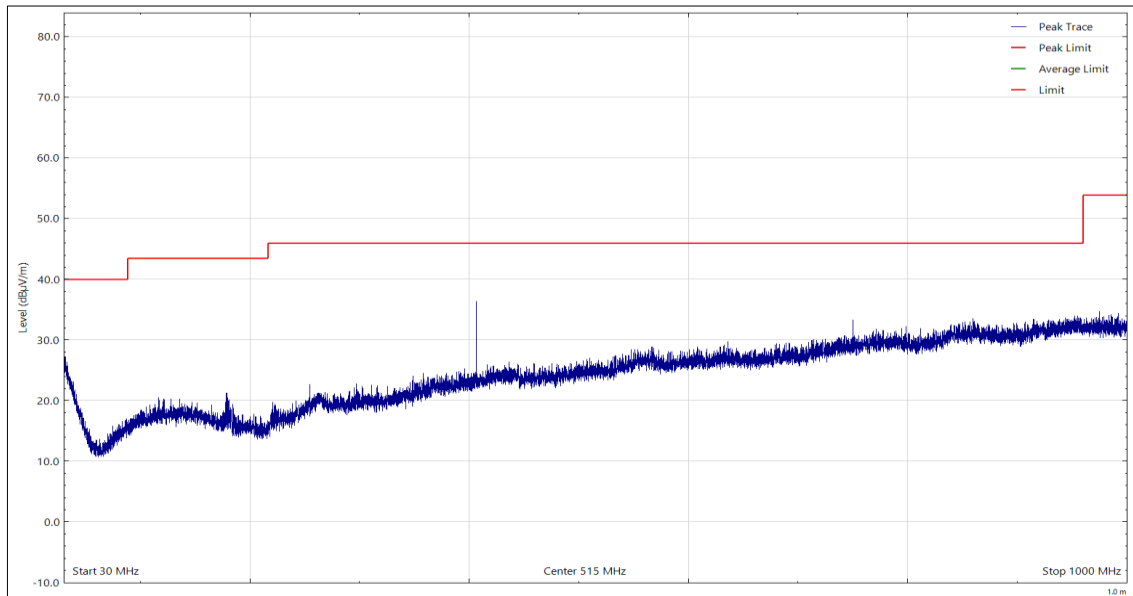
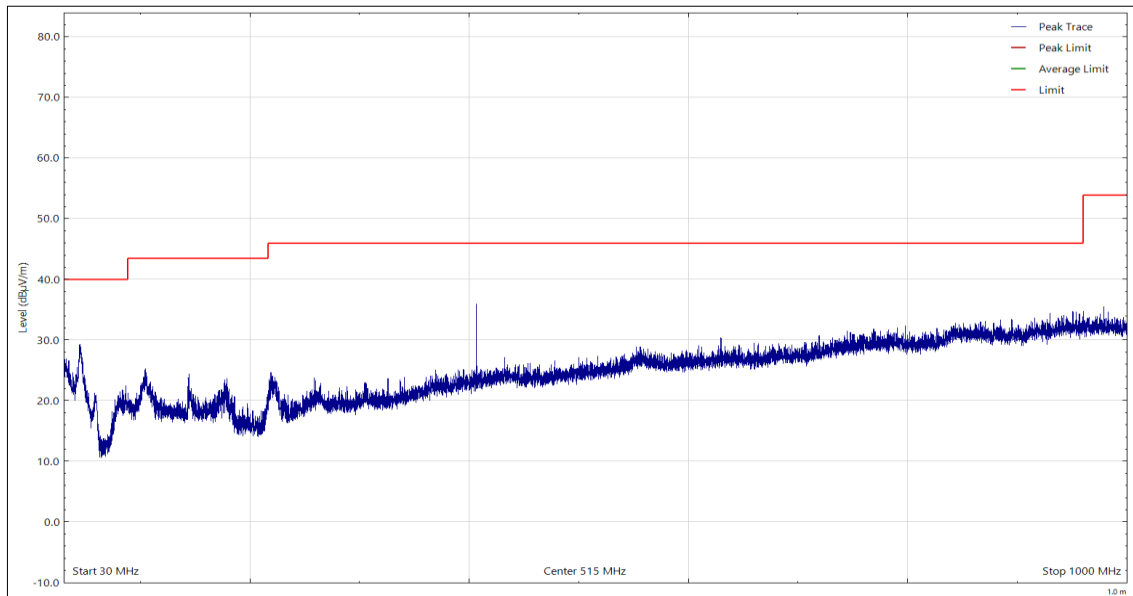

**Figure 5 - 30 MHz to 1 GHz, Horizontal**

Frequency (MHz)	Level (dBµV/m)	Limit (dBµV/m)	Margin (dB)	Detector	Angle (°)	Height (cm)	Polarisation
*							

**Table 14**

\*No final measurements were made as all peak emissions seen above the measurement system noise floor during the pre-scan were greater than 6 dB below the test limit.

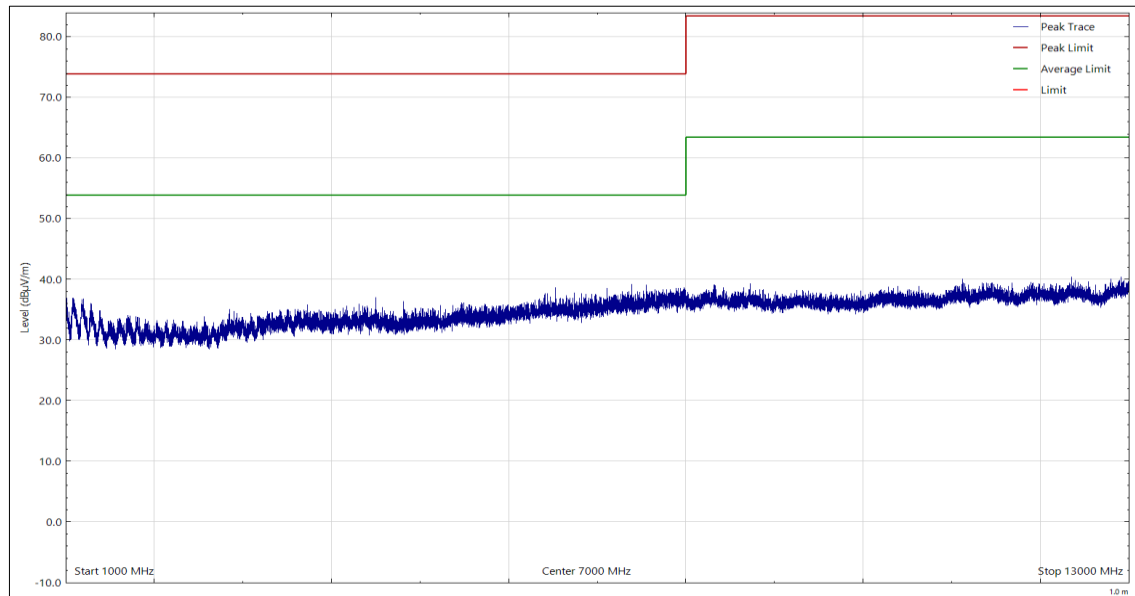

**Figure 6 - 30 MHz to 1 GHz, Vertical**

Frequency (MHz)	Level (dBµV/m)	Limit (dBµV/m)	Margin (dB)	Detector	Angle (°)	Height (cm)	Polarisation
*							

**Table 15**

\*No final measurements were made as all peak emissions seen above the measurement system noise floor during the pre-scan were greater than 6 dB below the test limit.



**Figure 7 - 1 GHz to 13 GHz, Horizontal**

Frequency (MHz)	Level (dBµV/m)	Limit (dBµV/m)	Margin (dB)	Detector	Angle (°)	Height (cm)	Polarisation
*							

**Table 16**

\*No final measurements were made as all peak emissions seen above the measurement system noise floor during the pre-scan were greater than 6 dB below the test limit.



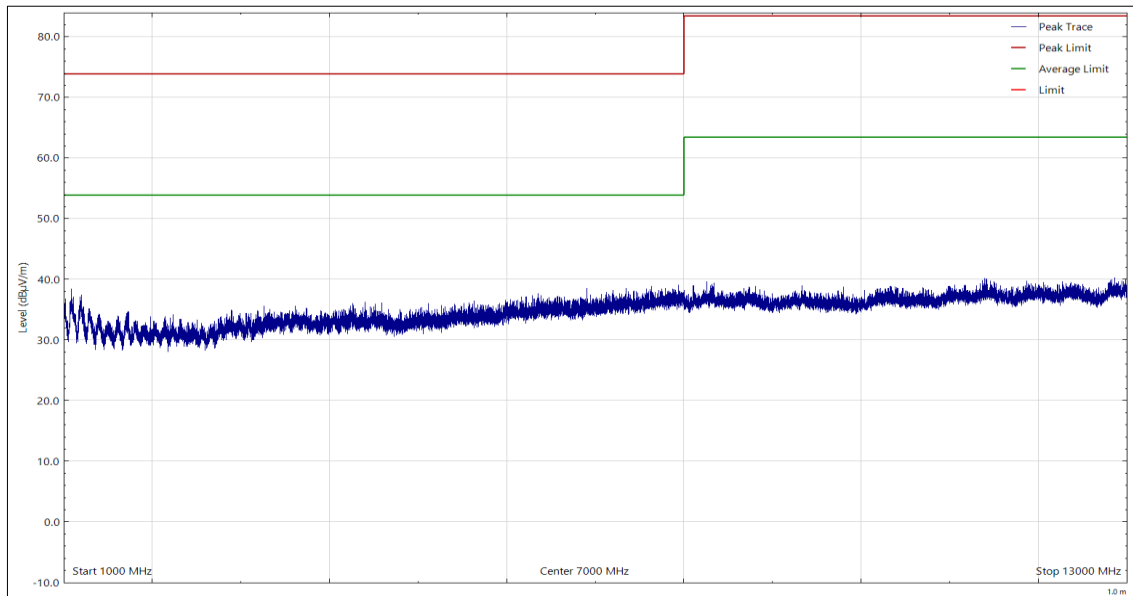

**Figure 8 - 1 GHz to 13 GHz, Vertical**

Frequency (MHz)	Level (dBµV/m)	Limit (dBµV/m)	Margin (dB)	Detector	Angle (°)	Height (cm)	Polarisation
*							

**Table 17**

\*No final measurements were made as all peak emissions seen above the measurement system noise floor during the pre-scan were greater than 6 dB below the test limit.



### 2.2.10 Test Location and Test Equipment Used

This test was carried out in EMC Chamber 12.

Instrument	Manufacturer	Type No	TE No	Calibration Period (months)	Calibration Expires
3m Semi-Anechoic Chamber	MVG	EMC Chamber 12	5621	36	07-Aug-2026
Emissions Software	TUV SUD	EmX V3.2.0	5125	-	Software
EMC Test Receiver	Rohde & Schwarz	ESW44	6334	12	20-Apr-2024
Turntable & Mast Controller	Maturo Gmbh	NCD/498/2799.01	5612	-	TU
Tilt Antenna Mast	Maturo Gmbh	TAM 4.0-P	5613	-	TU
Cable (2.92 mm(f)-N(m), 2 m)	Junkosha	MWX241-02000KFSNMS/B	5443	12	09-Mar-2024
Cable (K-Type to K-Type, 1 m)	Junkosha	MWX241-01000KMSKMS/A	5511	12	21-May-2024
Cable (N-Type to N-Type, 8 m)	Junkosha	MWX221-08000NMSNMS/B	6321	12	04-Feb-2025
Pre-Amplifier (1 GHz to 18 GHz)	Schwarzbeck	BBV 9718 C	5350	12	01-Dec-2024
Pre-Amplifier (8 GHz to 18 GHz)	Wright Technologies	APS06-0061	5596	12	27-Oct-2024
Antenna (Bi-Log, 30 MHz to 1 GHz)	Teseq	CBL6111D	5615	24	15-Mar-2025
Antenna (DRG, 1 GHz to 10.5 GHz)	Schwarzbeck	BBHA9120B	5611	12	15-Oct-2024
Antenna (DRG, 7.5 GHz to 18 GHz)	Schwarzbeck	HWRD750	5610	12	15-Oct-2024

**Table 18**

TU - Traceability Unscheduled



### 3 Test Equipment Information

#### 3.1 General Test Equipment Used

Instrument	Manufacturer	Type No	TE No	Calibration Period (months)	Calibration Expires
Thermo-Hygro-Barometer	PCE Instruments	PCE-THB-40	5478	12	21-Apr-2024

**Table 19**



## 4 Incident Reports

No incidents reports were raised.



## 5 Measurement Uncertainty

For a 95% confidence level, the measurement uncertainties for defined systems are:

Test Name	Measurement Uncertainty
Conducted Disturbance at Mains Terminals	150 kHz to 30 MHz, LISN, $\pm 3.7$ dB
Radiated Disturbance	30 MHz to 1 GHz, Bilog Antenna, SAC, $\pm 5.2$ dB 1 GHz to 6 GHz, Horn Antenna, SAC, $\pm 5.1$ dB 6 GHz to 18 GHz, Horn Antenna, SAC, $\pm 4.9$ dB

**Table 20**

Worst case error for both Time and Frequency measurement 12 parts in  $10^6$ .

### Measurement Uncertainty Decision Rule

Determination of conformity with the specification limits is based on the decision rule according to IEC Guide 115:2021, Clause 4.4.3 (Procedure 2). The measurement results are directly compared with the test limit to determine conformance with the requirements of the standard.

Risk: The uncertainty of measurement about the measured result is negligible with regard to the final pass/fail decision. The measurement result can be directly compared with the test limit to determine conformance with the requirement (compare IEC Guide 115). The level of risk to falsely accept and falsely reject items is further described in ILAC-G8.