

# TEST REPORT

**Test Report No. :** UL-RPT-RP14994598JD02C

**Customer** : Apple Inc.  
**Model No. / HVIN** : A3114  
**PMN** : MacBook Air  
**FCC ID** : BCGA3114  
**ISED Certification No.** : IC: 579C-A3114  
**Technology** : *Bluetooth* – Low Energy (High Power Mode)  
**Test Standard(s)** : FCC Parts 15.209(a) & 15.247  
Innovation, Science and Economic Development Canada  
RSS-247 Issue 2 February 2017  
RSS-Gen Issue 5 February 2021  
**Test Laboratory** : UL International (UK) Ltd, Basingstoke, Hampshire, RG24 8AH,  
United Kingdom

1. This test report shall not be reproduced except in full, without the written approval of UL International (UK) Ltd.
2. The results in this report apply only to the sample(s) tested.
3. The sample tested is in compliance with the above standard(s).
4. The test results in this report are traceable to the national or international standards.
5. Version 1.0.

**Date of Issue:** 14 November 2023

**Checked by:**   
Sarah Williams  
RF Operations Leader, Radio Laboratory

**Company Signatory:**   
Ben Mercer  
Lead Project Engineer, Radio Laboratory



5772

The *Bluetooth*® word mark and logos are owned by the *Bluetooth* SIG, Inc. and any use of such marks by UL International (UK) Ltd is under licence. Other trademarks and trade names are those of their respective owners.

**UL International (UK) LTD**

Unit 1-4 Horizon, Kingsland Business Park, Wade Road, Basingstoke, Hampshire, RG24 8AH, UK  
Telephone: +44 (0)1256 312000

**Customer Information**

<b>Company Name:</b>	Apple Inc.
<b>Address:</b>	One Apple Park Way Cupertino, California 95014 U.S.A.
<b>Contact Name:</b>	Stuart Thomas

**Report Revision History**

<b>Version Number</b>	<b>Issue Date</b>	<b>Revision Details</b>	<b>Revised By</b>
1.0	14/11/2023	Initial Version	Sarah Williams

## **Table of Contents**

<b>Customer Information.....</b>	<b>2</b>
<b>Report Revision History .....</b>	<b>2</b>
<b>Table of Contents.....</b>	<b>3</b>
<b>1 Attestation of Test Results.....</b>	<b>4</b>
1.1 Description of EUT	4
1.2 General Information	4
1.3 Summary of Test Results	4
1.4 Deviations from the Test Specification	4
<b>2 Summary of Testing.....</b>	<b>5</b>
2.1 Facilities and Accreditation	5
2.2 Methods and Procedures	5
2.3 Calibration and Uncertainty	6
2.4 Test and Measurement Equipment	7
<b>3 Equipment Under Test (EUT) .....</b>	<b>9</b>
3.1 Identification of Equipment Under Test (EUT)	9
3.2 Modifications Incorporated in the EUT	9
3.3 Additional Information Related to Testing	10
3.4 Description of Available Antennas	10
3.5 Description of Test Setup	11
<b>4 Antenna Port Test Results .....</b>	<b>17</b>
4.1 Transmitter 99% Occupied Bandwidth	17
4.2 Transmitter Minimum 6 dB Bandwidth	21
4.3 Transmitter Maximum Peak Output Power	25
4.4 Transmitter Power Spectral Density	29
<b>5 Radiated Test Results.....</b>	<b>33</b>
5.1 Transmitter Radiated Emissions <1 GHz	33
5.2 Transmitter Radiated Emissions >1 GHz	35
5.3 Transmitter Band Edge Radiated Emissions	37

## **1 Attestation of Test Results**

### **1.1 Description of EUT**

The equipment under test (EUT) was a portable laptop computer.

### **1.2 General Information**

<b>Specification Reference:</b>	47CFR15.247
<b>Specification Title:</b>	Code of Federal Regulations Volume 47 (Telecommunications): Part 15 Subpart C (Intentional Radiators) – Section 15.247
<b>Specification Reference:</b>	47CFR15.209
<b>Specification Title:</b>	Code of Federal Regulations Volume 47 (Telecommunications): Part 15 Subpart C (Intentional Radiators) – Section 15.209
<b>Specification Reference:</b>	RSS-Gen Issue 5 February 2021
<b>Specification Title:</b>	General Requirements for Compliance of Radio Apparatus
<b>Specification Reference:</b>	RSS-247 Issue 2 February 2017
<b>Specification Title:</b>	Digital Transmission Systems (DTSs), Frequency Hopping Systems (FHSs) and Licence-Exempt Local Area Network (LE-LAN) Devices
<b>Site Registration:</b>	FCC: 685609, ISEDC: 20903
<b>FCC Lab. Designation No.:</b>	UK2011
<b>ISEDC CABID:</b>	UK0001
<b>Location of Testing:</b>	Units 3 & 4 Horizon, Wade Road, Kingsland Business Park, Basingstoke, Hampshire, RG24 8AH, United Kingdom
<b>Test Dates:</b>	13 September 2023 to 20 October 2023

### **1.3 Summary of Test Results**

<b>FCC Reference (47CFR)</b>	<b>ISED Canada Reference</b>	<b>Measurement</b>	<b>Result</b>
N/A	RSS-Gen 6.7	Transmitter 99% Occupied Bandwidth	Complied
Part 15.247(a)(2)	RSS-Gen 6.7 / RSS-247 5.2(a)	Transmitter Minimum 6 dB Bandwidth	Complied
Part 15.247(b)(3)	RSS-Gen 6.12 / RSS-247 5.4(d)	Transmitter Maximum Peak Output Power	Complied
Part 15.247(e)	RSS-247 5.2(b)	Transmitter Power Spectral Density	Complied
Part 15.247(d) & 15.209(a)	RSS-Gen 6.13 / RSS-247 5.5	Transmitter Radiated Emissions	Complied
Part 15.247(d) & 15.209(a)	RSS-Gen 6.13 / RSS-247 5.5	Transmitter Band Edge Radiated Emissions	Complied

### **1.4 Deviations from the Test Specification**

For the measurements contained within this test report, there were no deviations from, additions to, or exclusions from the test specification identified above.

## **2 Summary of Testing**

### **2.1 Facilities and Accreditation**

The test site and measurement facilities used to collect data are located at Unit 3 Horizon, Wade Road, Kingsland Business Park, Basingstoke, Hampshire, RG24 8AH, United Kingdom. The following table identifies which facilities were utilised for radiated emission measurements documented in this report. Specific facilities are also identified in the test results sections.

Site 1	X
Site 2	-
Site 17	X
Site 32	-
Site 33	-

UL International (UK) Ltd is accredited by the United Kingdom Accreditation Service (UKAS). UKAS is one of the signatories to the International Laboratory Accreditation Co-operation (ILAC) Arrangement for the mutual recognition of test reports. The tests reported herein have been performed in accordance with its terms of accreditation.

### **2.2 Methods and Procedures**

<b>Reference:</b>	ANSI C63.10-2013
<b>Title:</b>	American National Standard of Procedures for Compliance Testing of Unlicensed Wireless Devices
<b>Reference:</b>	KDB 558074 D01 15.247 Meas Guidance v05r02, April 2, 2019
<b>Title:</b>	Guidance for Compliance Measurements on Digital Transmission System, Frequency Hopping Spread Spectrum System, and Hybrid System Devices Operating Under Section 15.247 of the FCC Rules
<b>Reference:</b>	KDB 662911 D01 Multiple Transmitter Output v02r01 October 31, 2013
<b>Title:</b>	Emissions Testing of Transmitters with Multiple Outputs in the Same Band

## **2.3 Calibration and Uncertainty**

### **Measuring Instrument Calibration**

In accordance with UKAS requirements all the measurement equipment is on a calibration schedule. All equipment was within the calibration period on the date of testing.

### **Measurement Uncertainty & Decision Rule**

#### **Overview**

No measurement or test can ever be perfect and the imperfections give rise to error of measurement in the results. Consequently the result of a measurement is only an approximation to the value of the measurand (the specific quantity subject to measurement) and is only complete when accompanied by a statement of the uncertainty of the approximation.

The expression of uncertainty of a measurement result allows realistic comparison of results with reference values and limits given in specifications and standards.

#### **Decision Rule**

Measurement system instrumentation shall be used with an accuracy specification meeting the accuracy specification limits according to IEC/IECEE OD-5014.

As applicable, unless specified otherwise in this quotation, the compliance "Decision Rule" is based on Simple Acceptance. If the measured value is on the limit, the result is defined as a pass. In this case the risk of a false positive is 50%. For further information regarding risk assessment refer to ILAC G8:09/2019.

#### **Measurement Uncertainty**

The reported expanded uncertainties below are based on a standard uncertainty multiplied by an appropriate coverage factor such that a confidence level of approximately 95% is maintained. For the purposes of this document "approximately" is interpreted as meaning "effectively" or "for most practical purposes".

<b>Measurement Type</b>	<b>Range</b>	<b>Confidence Level (%)</b>	<b>Calculated Uncertainty</b>
99% Occupied Bandwidth	2.4 GHz to 2.4835 GHz	95%	±3.92 %
Minimum 6 dB Bandwidth	2.4 GHz to 2.4835 GHz	95%	±4.59 %
Spectral Power Density	2.4 GHz to 2.4835 GHz	95%	±1.13 dB
Conducted Maximum Peak Output Power	2.4 GHz to 2.4835 GHz	95%	±0.58 dB
Radiated Spurious Emissions	9 kHz to 30 MHz	95%	±5.32 dB
Radiated Spurious Emissions	30 MHz to 1 GHz	95%	±3.30 dB
Radiated Spurious Emissions	1 GHz to 25 GHz	95%	±3.16 dB

The methods used to calculate the above uncertainties are in line with those recommended within the various measurement specifications. Where measurement specifications do not include guidelines for the evaluation of measurement uncertainty the published guidance of the appropriate accreditation body is followed.

## **2.4 Test and Measurement Equipment**

### **Test Equipment Used for Transmitter Conducted Tests**

<b>Asset No.</b>	<b>Instrument</b>	<b>Manufacturer</b>	<b>Type No.</b>	<b>Serial No.</b>	<b>Date Calibration Due</b>	<b>Cal. Interval (Months)</b>
M2042	Thermohygrometer	Testo	608-H1	45124926	09 Dec 2023	12
M231907	Signal Analyser	Keysight	N9020B	MY63430178	03 Dec 2023	12
A227116	Attenuator	Pasternack	PE7013-10	#1	Calibrated before use	-
A227117	Attenuator	Pasternack	PE7013-10	#2	Calibrated before use	-
M215600	Power Sensor	Boonton	RTP5008	11837	09 Jun 2024	12
M215598	Power Sensor	Boonton	RTP5008	11821	08 Jun 2024	12
A231994	Switching Unit	Mini-Circuits	ZT-400	12211020019	Calibrated before use	-
M1725	Network Analyser	Keysight	E5071C	MY46316169	09 Nov 2023	12

### **Test Measurement Software/Firmware Used for Transmitter Conducted Tests**

<b>Name</b>	<b>Version</b>	<b>Release Date</b>
Phoenix	1.5.1	16/10/2023

**Test and Measurement Equipment (continued)****Test Equipment Used for Transmitter Radiated Emissions Tests**

Asset No.	Instrument	Manufacturer	Type No.	Serial No.	Date Calibration Due	Cal. Interval (Months)
M2040	Thermohygrometer	Testo	608-H1	45124934	09 Dec 2023	12
K0001	3m RSE Chamber	Rainford EMC	N/A	N/A	06 Sep 2024	12
M236226	Test Receiver	Rohde & Schwarz	ESW26	103134	21 Apr 2024	12
A3154	Pre-Amplifier	Com-Power	PAM-103	18020012	21 Aug 2024	12
A3165	Magnetic Loop Antenna	ETS-Lindgren	6502	00224383	13 Apr 2024	12
A231925	Antenna	Teseq	CBL6111D	63584	27 Apr 2024	12
A3010	Attenuator	AtlanTecRF	AN18-06	208801#5	27 Apr 2024	12
A3085	Low Pass Filter	AtlanTecRF	AFL-02000	18051600014	26 Jan 2024	12
M2003	Thermohygrometer	Testo	608-H1	45046641	09 Dec 2023	12
K0017	3m RSE Chamber	Rainford EMC	N/A	N/A	08 Nov 2023	12
M1995	Test Receiver	Rohde & Schwarz	ESU40	100428	02 Nov 2023	12
A3167	Pre-Amplifier	Com-Power	PAM-103	18020010	02 Nov 2023	12
A2863	Pre-Amplifier	Agilent	8449B	3008A02100	07 Nov 2023	12
A223628	Pre-Amplifier	Atlantic Microwave	A-LNAKX-380116-S5S5	210837001	03 Nov 2023	12
A3265	Pre-Amplifier	Schwarzbeck	BBV 9721	9721-069	31 Oct 2023	12
A3161	Antenna	Teseq	CBL6111D	50859	25 Sep 2024	12
A2889	Antenna	Schwarzbeck	BBHA 9120 B	00653	02 Nov 2023	12
A2890	Antenna	Schwarzbeck	HWRD 750	014	02 Nov 2023	12
A2892	Antenna	Schwarzbeck	BBHA 9170	9170-727	31 Oct 2023	12
A3113	Attenuator	AtlanTecRF	AN18-06	219706#3	25 Sep 2024	12
A2916	Attenuator	AtlanTecRF	AN18W5-10	832827#2	25 Jan 2024	12
A3036	Low Pass Filter	AtlanTecRF	AFL-02000	15062902848	25 Jan 2024	12
A2914	High Pass Filter	AtlanTecRF	AFH-03000	2155	25 Jan 2024	12
A2947	High Pass Filter	AtlanTecRF	AFH-07000	1601900001	25 Jan 2024	12

**Test Equipment Used for Transmitter Band Edge Radiated Emissions Tests**

Asset No.	Instrument	Manufacturer	Type No.	Serial No.	Date Calibration Due	Cal. Interval (Months)
M2003	Thermohygrometer	Testo	608-H1	45046641	09 Dec 2023	12
K0017	3m RSE Chamber	Rainford EMC	N/A	N/A	08 Nov 2023	12
M1995	Test Receiver	Rohde & Schwarz	ESU40	100428	02 Nov 2023	12
A2863	Pre-Amplifier	Agilent	8449B	3008A02100	07 Nov 2023	12
A2889	Antenna	Schwarzbeck	BBHA 9120 B	00653	02 Nov 2023	12
A2916	Attenuator	AtlanTecRF	AN18W5-10	832827#2	25 Jan 2024	12



### **3 Equipment Under Test (EUT)**

#### **3.1 Identification of Equipment Under Test (EUT)**

<b>Brand Name:</b>	Apple
<b>Model Name or Number / HVIN:</b>	A3114
<b>PMN:</b>	MacBook Air
<b>Test Sample Serial Number:</b>	LHQYJ7F4Q4 ( <i>Conducted sample #1</i> )
<b>Hardware Version:</b>	REV 1.0
<b>Software Version:</b>	23A32771a
<b>FCC ID:</b>	BCGA3114
<b>ISED Canada Certification Number:</b>	IC: 579C-A3114
<b>Date of Receipt:</b>	12 October 2023

<b>Brand Name:</b>	Apple
<b>Model Name or Number / HVIN:</b>	A3114
<b>PMN:</b>	MacBook Air
<b>Test Sample Serial Number:</b>	GCX4C2H43F ( <i>Radiated sample #1</i> )
<b>Hardware Version:</b>	REV 1.0
<b>Software Version:</b>	23A32771a
<b>FCC ID:</b>	BCGA3114
<b>ISED Canada Certification Number:</b>	IC: 579C-A3114
<b>Date of Receipt:</b>	11 September 2023

<b>Brand Name:</b>	Apple
<b>Model Name or Number / HVIN:</b>	A3114
<b>PMN:</b>	MacBook Air
<b>Test Sample Serial Number:</b>	LH497WX5HX ( <i>Radiated sample #2</i> )
<b>Hardware Version:</b>	REV 1.0
<b>Software Version:</b>	23A32771a
<b>FCC ID:</b>	BCGA3114
<b>ISED Canada Certification Number:</b>	IC: 579C-A3114
<b>Date of Receipt:</b>	11 September 2023

#### **3.2 Modifications Incorporated in the EUT**

No modifications were applied to the EUT during testing.

### 3.3 Additional Information Related to Testing

<b>Technology Tested:</b>	<i>Bluetooth</i> Low Energy (Digital Transmission System)		
<b>Type of Unit:</b>	Transceiver		
<b>Channel Spacing:</b>	2 MHz		
<b>Modulation:</b>	GFSK		
<b>Data Rate: LE1M</b>	1 Mbps		
<b>Data Rate: LE2M</b>	2 Mbps		
<b>Power Supply Requirement(s):</b>	12 VDC via 120 VAC 60 Hz AC/DC supply		
<b>Maximum Conducted Output Power:</b>	17.43 dBm		
<b>Transmit Frequency Range:</b>	2400 MHz to 2483.5 MHz		
<b>Transmit Channels Tested:</b>	<b>Channel ID</b>	<b>Channel Number</b>	<b>Channel Frequency (MHz)</b>
	Bottom	37	2402
	Middle	17	2440
	Top	39	2480

### 3.4 Description of Available Antennas

The radio utilizes two integrated antennas, with the following maximum gains:

Antenna Port	Frequency Range (MHz)	Antenna Gain (dBi)
Core 0	2400 to 2480	5.86
Core 1	2400 to 2480	5.42

The EUT also supports TxBF with unequal gains and equal transmit powers. Calculations for directional gain were in accordance with KDB 662911 D01 v02r01 Section F)2)d)(i). Directional gain of Core 0 & Core 1 was calculated as:

$N_{ANT}=2$ ,  $G_1 = G_{Core\ 0} = 5.86$  dBi,  $G_2 = G_{Core\ 1} = 5.42$  dBi:

$$\begin{aligned} \text{Directional Gain} &= 10 \log \left[ \frac{\left( 10^{\frac{G_1}{20}} + 10^{\frac{G_2}{20}} + \dots + 10^{\frac{G_N}{20}} \right)^2}{N_{ANT}} \right] = 10 \log \left[ \frac{\left( 10^{\frac{G_1}{20}} + 10^{\frac{G_2}{20}} \right)^2}{2} \right] \\ &= 10 \log \left[ \frac{\left( 10^{\frac{5.86}{20}} + 10^{\frac{5.42}{20}} \right)^2}{2} \right] = 8.65 \text{ dBi} \end{aligned}$$

### **3.5 Description of Test Setup**

#### **Support Equipment**

The following support equipment was used to exercise the EUT during testing:

<b>Description:</b>	Test Laptop
<b>Brand Name:</b>	Apple
<b>Model Name or Number:</b>	MacBook Pro
<b>Serial Number:</b>	C02VN1N8HV22

<b>Description:</b>	USB Diagnostic Cable
<b>Brand Name:</b>	Apple
<b>Model Name or Number:</b>	Chimp
<b>Serial Number:</b>	439503

<b>Description:</b>	Test Laptop
<b>Brand Name:</b>	Apple
<b>Model Name or Number:</b>	MacBook Pro
<b>Serial Number:</b>	FVFDH03JQ05G

<b>Description:</b>	USB Diagnostic Cable
<b>Brand Name:</b>	Apple
<b>Model Name or Number:</b>	Chimp
<b>Serial Number:</b>	30A99B

<b>Description:</b>	Test Laptop
<b>Brand Name:</b>	Apple
<b>Model Name or Number:</b>	MacBook Pro
<b>Serial Number:</b>	C02C800FP0CW

<b>Description:</b>	USB Diagnostic Cable
<b>Brand Name:</b>	Apple
<b>Model Name or Number:</b>	Chimp
<b>Serial Number:</b>	428CEB

<b>Description:</b>	AC to DC Power Adaptor
<b>Brand Name:</b>	Apple
<b>Model Name or Number:</b>	A2164
<b>Serial Number:</b>	Not marked or stated

**Support Equipment (continued)**

<b>Description:</b>	USB-C Dock Termination Hub
<b>Brand Name:</b>	Lenovo
<b>Model Name or Number:</b>	LDC-G2
<b>Serial Number:</b>	ZKW1XQRO

<b>Description:</b>	Personal Hands Free (PHF)
<b>Brand Name:</b>	Not marked or stated
<b>Model Name or Number:</b>	Not marked or stated
<b>Serial Number:</b>	Not marked or stated

<b>Description:</b>	USB-C Dock Termination Hub
<b>Brand Name:</b>	Lenovo
<b>Model Name or Number:</b>	40AY
<b>Serial Number:</b>	ZVR03H0H

<b>Description:</b>	USB-A to USB-C Adaptor. Quantity 2
<b>Brand Name:</b>	Not marked or stated
<b>Model Name or Number:</b>	Not marked or stated
<b>Serial Number:</b>	Not marked or stated

<b>Description:</b>	USB-A Cable. Quantity 2. Length 3 m
<b>Brand Name:</b>	Not marked or stated
<b>Model Name or Number:</b>	Not marked or stated
<b>Serial Number:</b>	Not marked or stated

## **Operating Modes**

The EUT was tested in the following operating mode(s):

- Transmitting at maximum power in *Bluetooth* LE mode with modulation, maximum possible data length available and Pseudorandom Bit Sequence 9.
- Transmitting at maximum power in *Bluetooth* LE2M mode with modulation, maximum possible data length available and Pseudorandom Bit Sequence 9.

## **Configuration and Peripherals**

The EUT was tested in the following configuration(s):

- Controlled in test mode using a set of commands entered into a terminal application on the test laptop supplied by the customer. The commands were used to enable a continuous transmission and to select the test channels as required.
- The EUT has two cores which operate in both SISO and TxBF modes. Core 0 & Core 1 are identical but have unequal gains therefore conducted tests have been performed on the Core with the highest antenna gain. Modes tested were.
  - LE1M / SISO / Core 0
  - LE2M / SISO / Core 0
  - LE1M / Beamforming / Core 0 + Core 1
  - LE2M / Beamforming / Core 0 + Core 1
- The customer supplied U.FL RF cables with the EUT in order to perform conducted measurements. This measured additional path loss was included in any path loss calculations.
- The EUT was powered from a 120 VAC 60 Hz single phase mains supply.
- Transmitter radiated spurious emissions tests were performed with the EUT transmitting in LE2M Beamforming Core 0 + Core 1 mode, as this mode was found to transmit the highest power.
- Radiated band edge and spurious emissions were performed with the EUT in the normal position of operation. Tests were performed with the EUT connected to its AC to DC power adaptor, PHF and USB adaptors. All ports were terminated with suitable terminations.

**Test Setup Diagrams**

**Conducted Tests:**

**Test Setup for Transmitter Conducted Tests**

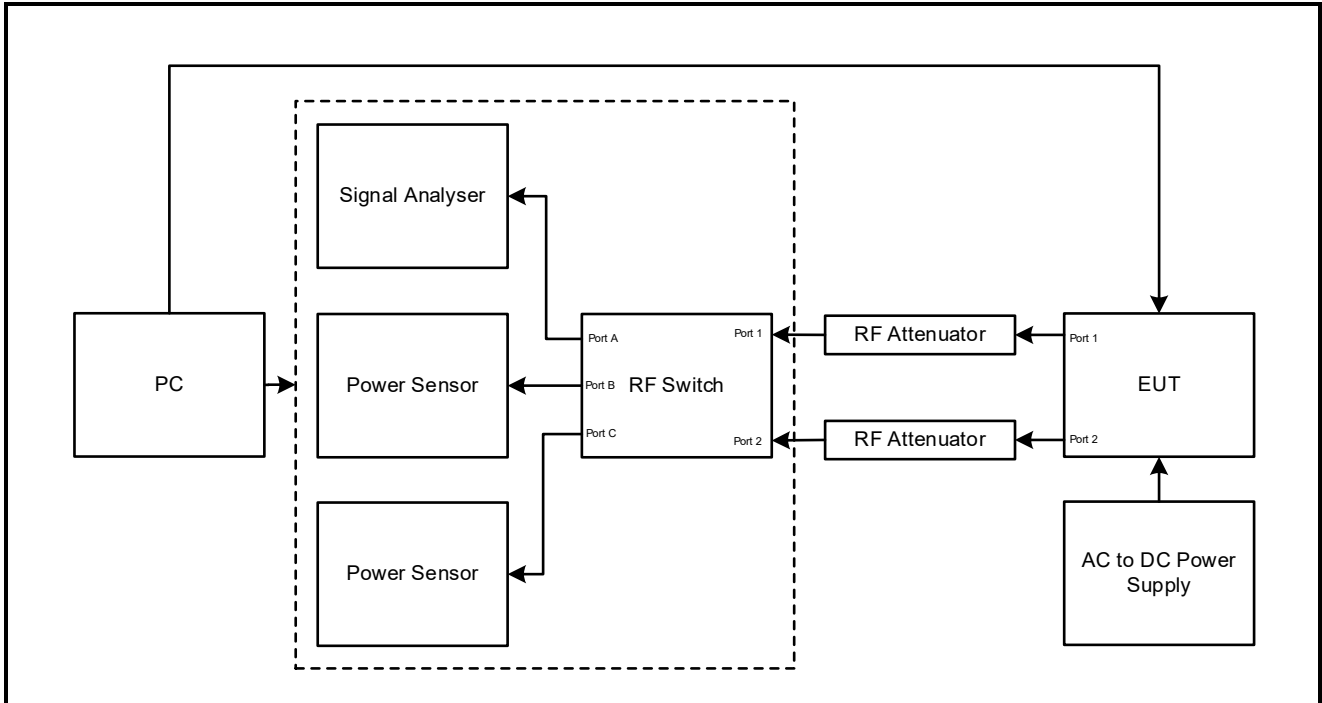

**Test Setup Diagrams (continued)**

**Radiated Tests:**

**Test Setup for Transmitter Radiated Emissions**

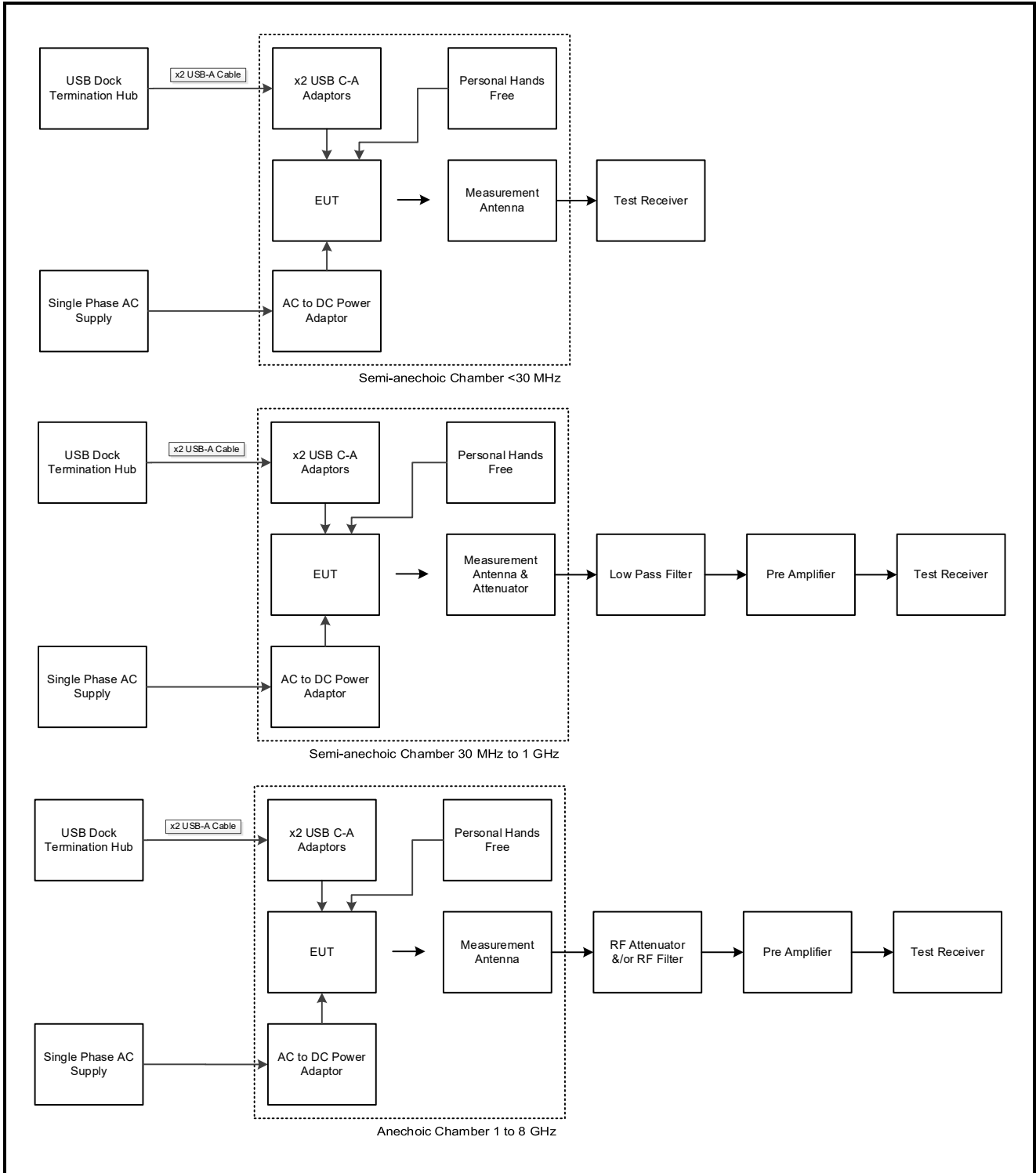

**Test Setup Diagrams (continued)**

**Test Setup for Transmitter Radiated Emissions (continued)**

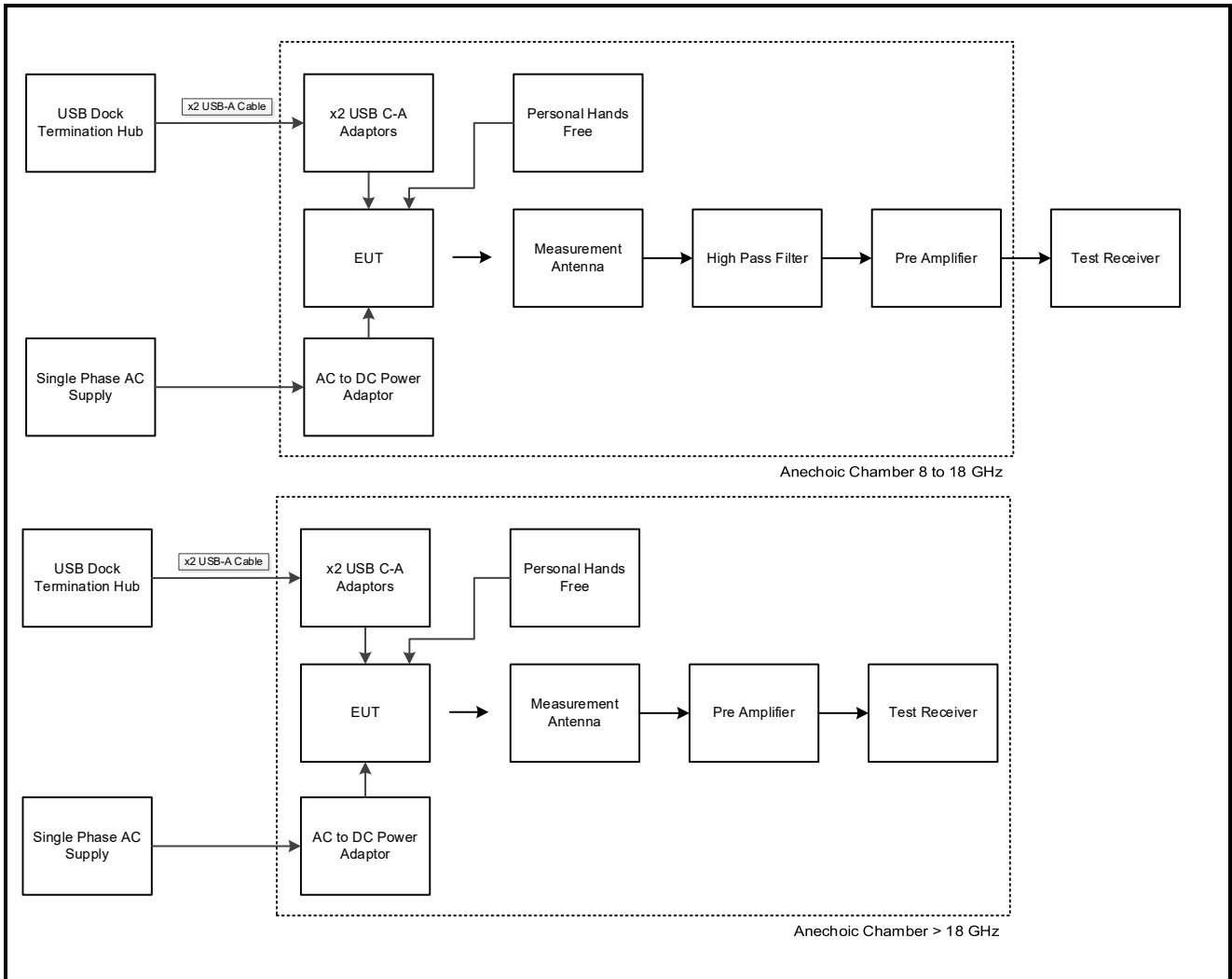



## **4 Antenna Port Test Results**

### **4.1 Transmitter 99% Occupied Bandwidth**

#### **Test Summary:**

<b>Test Engineer:</b>	Max Passell	<b>Test Dates:</b>	18 October 2023 & 19 October 2023
<b>Test Sample Serial Number:</b>	LHQYJ7F4Q4		

#### **Environmental Conditions:**

<b>Temperature (°C):</b>	21 to 23
<b>Relative Humidity (%):</b>	50 to 57

#### **Note(s):**

1. The 99% emission bandwidth was calculated by the test system using the raw trace data from the signal analyser. The resolution bandwidth was set in the range of 1% to 5% of the occupied bandwidth and the video bandwidth set to 3 times the resolution bandwidth. The span was set to capture all products of the modulation process including emission skirts.
2. Example plots of each modulation on middle channel, for one antenna configuration, can be seen below to show setting parameters comply with testing method/procedure. All other plots are archived on the UL IT server and available for inspection if required.

**Transmitter 99% Occupied Bandwidth (continued)**

**Results:**

<b>Frequency Range:</b>	2400-2483.5 MHz	<b>Band:</b>	2.4 GHz
<b>Limit Clause:</b>	RSS-Gen 6.7	<b>Test Method:</b>	ANSI C63.10 6.9.3

<b>Antenna Configuration:</b>	SISO	<b>Mode:</b>	LE
<b>Test Port:</b>	1 (Core 0-C0)	<b>Rate/Modulation:</b>	LE 1M (GFSK)

Test Frequency (MHz)	99% Bandwidth (MHz)				Limit (kHz)
	1	2	3	4	
2402	1.040	-	-	-	-
2440	1.036	-	-	-	-
2480	1.040	-	-	-	-

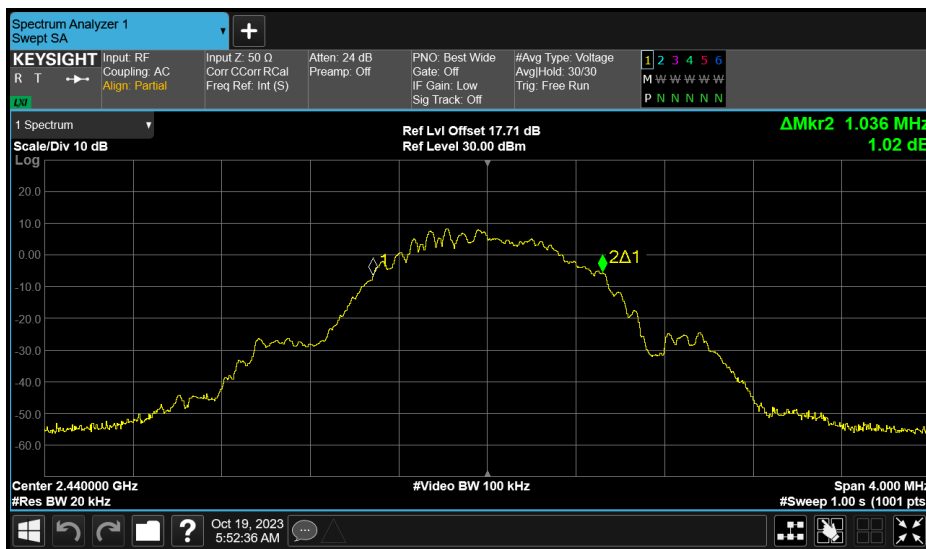

Middle Channel

**Transmitter 99% Occupied Bandwidth (continued)**

<b>Frequency Range:</b>	2400-2483.5 MHz	<b>Band:</b>	2.4 GHz
<b>Limit Clause:</b>	RSS-Gen 6.7	<b>Test Method:</b>	ANSI C63.10 6.9.3

<b>Antenna Configuration:</b>	SISO	<b>Mode:</b>	LE
<b>Test Port:</b>	1 (Core 0-C0)	<b>Rate/Modulation:</b>	LE 2M (GFSK)

Test Frequency (MHz)	99% Bandwidth (MHz)				Limit (kHz)
	1	2	3	4	
2402	2.088	-	-	-	-
2440	2.088	-	-	-	-
2480	2.096	-	-	-	-

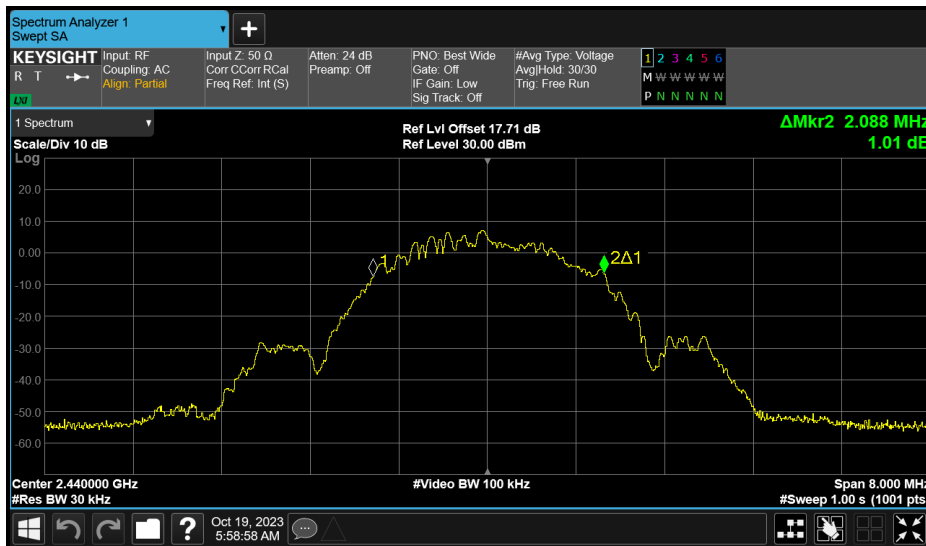

Middle Channel

**Transmitter 99% Occupied Bandwidth (continued)**

<b>Frequency Range:</b>	2400-2483.5 MHz	<b>Band:</b>	2.4 GHz
<b>Limit Clause:</b>	RSS-Gen 6.7	<b>Test Method:</b>	ANSI C63.10 6.9.3

<b>Antenna Configuration:</b>	Beamforming	<b>Mode:</b>	LE
<b>Test Port:</b>	1+2 (Core 0-C0 + Core 1-C1)	<b>Rate/Modulation:</b>	LE 1M (GFSK)

Test Frequency (MHz)	99% Bandwidth (MHz)				Limit (kHz)
	1	2	3	4	
2402	1.032	1.020	-	-	-
2440	1.028	1.016	-	-	-
2480	1.028	1.020	-	-	-

<b>Frequency Range:</b>	2400-2483.5 MHz	<b>Band:</b>	2.4 GHz
<b>Limit Clause:</b>	RSS-Gen 6.7	<b>Test Method:</b>	ANSI C63.10 6.9.3

<b>Antenna Configuration:</b>	Beamforming	<b>Mode:</b>	LE
<b>Test Port:</b>	1+2 (Core 0-C0 + Core 1-C1)	<b>Rate/Modulation:</b>	LE 2M (GFSK)

Test Frequency (MHz)	99% Bandwidth (MHz)				Limit (kHz)
	1	2	3	4	
2402	2.088	2.056	-	-	-
2440	2.072	2.064	-	-	-
2480	2.080	2.064	-	-	-

## **4.2 Transmitter Minimum 6 dB Bandwidth**

### **Test Summary:**

<b>Test Engineer:</b>	Max Passell	<b>Test Dates:</b>	18 October 2023 & 19 October 2023
<b>Test Sample Serial Number:</b>	LHQYJ7F4Q4		

### **Environmental Conditions:**

<b>Temperature (°C):</b>	21 to 23
<b>Relative Humidity (%):</b>	50 to 57

### **Note(s):**

1. 6 dB DTS bandwidth tests were performed using a signal analyser in accordance with ANSI C63.10 Section 11.8.1 Option 1 measurement procedure. The test system signal analyser resolution bandwidth was set to 100 kHz and video bandwidth 300 kHz. A peak detector was used, sweep time was set to auto and the trace mode was Max Hold. The DTS bandwidth was measured at 6 dB down from the peak of the signal.
2. Example plots of each modulation on middle channel, for one antenna configuration, can be seen below to show setting parameters comply with testing method/procedure. All other plots are archived on the UL IT server and available for inspection if required.

**Transmitter Minimum 6 dB Bandwidth (continued)**

**Results:**

<b>Frequency Range:</b>	2400-2483.5 MHz	<b>Band:</b>	2.4 GHz
<b>Limit Clause:</b>	15.247 (a)(2) RSS-Gen 6.7 / RSS-247 5.2 a)	<b>Test Method:</b>	ANSI C63.10 11.8.1

<b>Antenna Configuration:</b>	SISO	<b>Mode:</b>	LE
<b>Test Port:</b>	1 (Core 0-C0)	<b>Rate/Modulation:</b>	LE 1M (GFSK)

Test Frequency (MHz)	6 dB Bandwidth (MHz)				Limit (kHz)
	1	2	3	4	
2402	0.724	-	-	-	≥500
2440	0.720	-	-	-	≥500
2480	0.724	-	-	-	≥500

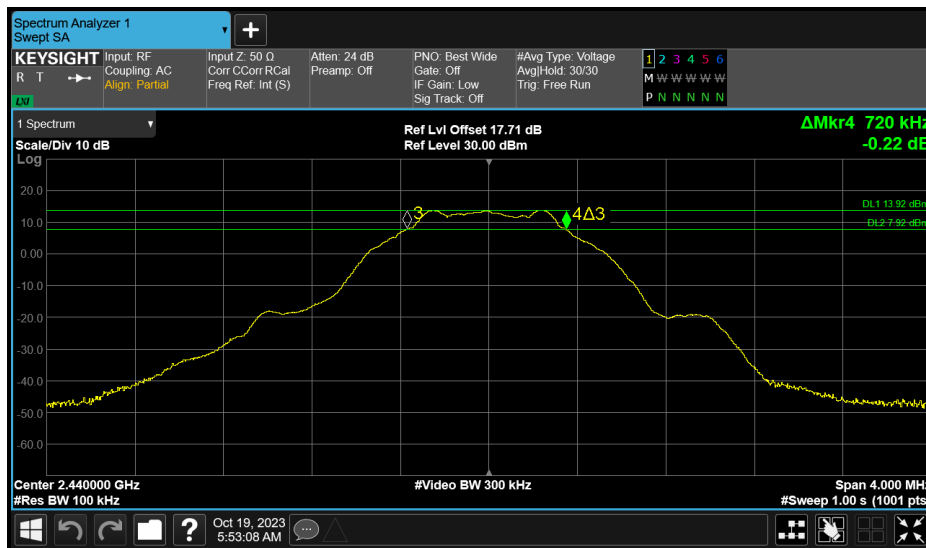

Middle Channel

**Transmitter Minimum 6 dB Bandwidth (continued)**

<b>Frequency Range:</b>	2400-2483.5 MHz	<b>Band:</b>	2.4 GHz
<b>Limit Clause:</b>	15.247 (a)(2) RSS-Gen 6.7 / RSS-247 5.2 a)	<b>Test Method:</b>	ANSI C63.10 11.8.1

<b>Antenna Configuration:</b>	SISO	<b>Mode:</b>	LE
<b>Test Port:</b>	1 (Core 0-C0)	<b>Rate/Modulation:</b>	LE 2M (GFSK)

Test Frequency (MHz)	6 dB Bandwidth (MHz)				Limit (kHz)
	1	2	3	4	
2402	1.264	-	-	-	≥500
2440	1.264	-	-	-	≥500
2480	1.264	-	-	-	≥500

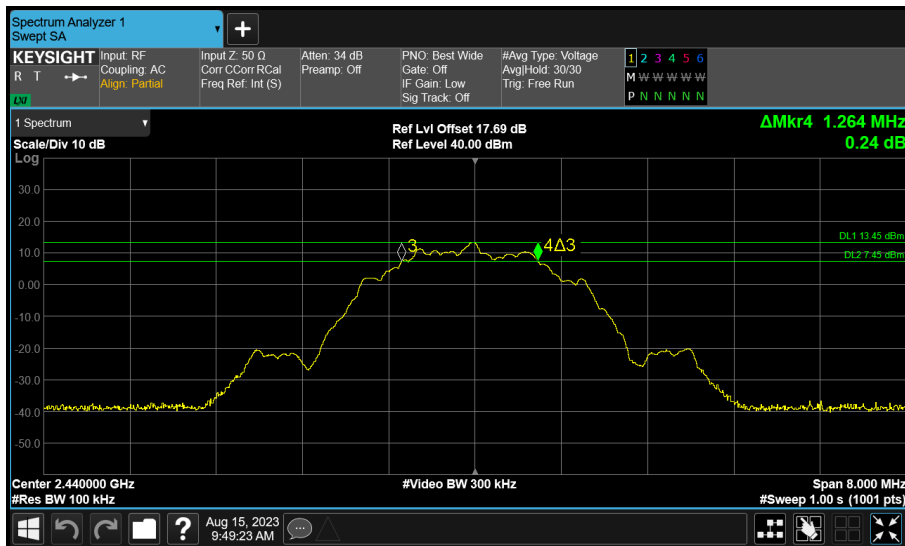

Middle Channel

**Transmitter Minimum 6 dB Bandwidth (continued)**

<b>Frequency Range:</b>	2400-2483.5 MHz	<b>Band:</b>	2.4 GHz
<b>Limit Clause:</b>	15.247 (a)(2) RSS-Gen 6.7 / RSS-247 5.2 a)	<b>Test Method:</b>	ANSI C63.10 11.8.1

<b>Antenna Configuration:</b>	Beamforming	<b>Mode:</b>	LE
<b>Test Port:</b>	1+2 (Core 0-C0 + Core 1-C1)	<b>Rate/Modulation:</b>	LE 1M (GFSK)

Test Frequency (MHz)	6 dB Bandwidth (MHz)				Limit (kHz)
	1	2	3	4	
2402	0.724	0.716	-	-	≥500
2440	0.708	0.720	-	-	≥500
2480	0.720	0.720	-	-	≥500

<b>Frequency Range:</b>	2400-2483.5 MHz	<b>Band:</b>	2.4 GHz
<b>Limit Clause:</b>	15.247 (a)(2) RSS-Gen 6.7 / RSS-247 5.2 a)	<b>Test Method:</b>	ANSI C63.10 11.8.1

<b>Antenna Configuration:</b>	Beamforming	<b>Mode:</b>	LE
<b>Test Port:</b>	1+2 (Core 0-C0 + Core 1-C1)	<b>Rate/Modulation:</b>	LE 2M (GFSK)

Test Frequency (MHz)	6 dB Bandwidth (MHz)				Limit (kHz)
	1	2	3	4	
2402	1.256	1.240	-	-	≥500
2440	1.256	1.256	-	-	≥500
2480	1.248	1.256	-	-	≥500



### **4.3 Transmitter Maximum Peak Output Power**

#### **Test Summary:**

<b>Test Engineer:</b>	Max Passell	<b>Test Dates:</b>	18 October 2023 & 19 October 2023
<b>Test Sample Serial Number:</b>	LHQYJ7F4Q4		

#### **Environmental Conditions:**

<b>Temperature (°C):</b>	21 to 23
<b>Relative Humidity (%):</b>	50 to 57

#### **Note(s):**

1. Conducted power tests were performed using a peak power in accordance with ANSI C63.10 Section 11.9.1.3 with PKPM1 peak power meter method.
2. For beamforming modes, conducted power was measured on Core 0 & Core 1 and then combined using the measure-and-sum technique stated in FCC KDB 662911 D01 Section E)1). For EIRP, the directional antenna gain was added to the conducted output power.
3. For beamforming modes, the limit for conducted output power has been reduced by the same amount in dB that the directional gain of the antenna exceeds 6 dBi, in accordance with 15.247(b)(4).

**Transmitter Maximum Peak Output Power (continued)****Results:**

<b>Frequency Range:</b>	2400-2483.5 MHz	<b>Band:</b>	2.4 GHz
<b>Limit Clause:</b>	15.247 (b)(3) RSS-247 5.4 d)	<b>Test Method:</b>	ANSI C63.10 Section 11.9.1.3

<b>Antenna Configuration:</b>	SISO	<b>Mode:</b>	LE
<b>Test Port:</b>	1 (Core 0-C0)	<b>Rate/Modulation:</b>	LE 1M (GFSK)

<b>Burst Tx</b>	Stability: < ±2%	Duty Cycle (%): 60.59	Period (ms): 0.625	Width (ms): 0.379
-----------------	------------------	-----------------------	--------------------	-------------------

Test Frequency (MHz)	Maximum Conducted Output Power (dBm)					Limit (dBm)	Margin (dB)	Antenna Gain (dBi)	EIRP (dBm)	EIRP Limit (dBm)	EIRP Margin (dB)
	1	2	3	4	Σ						
2402	14.74	-	-	-	-	30.00	15.26	5.86	20.60	36.00	15.40
2440	14.89	-	-	-	-	30.00	15.11	5.86	20.75	36.00	15.25
2480	14.64	-	-	-	-	30.00	15.36	5.86	20.50	36.00	15.50

<b>Frequency Range:</b>	2400-2483.5 MHz	<b>Band:</b>	2.4 GHz
<b>Limit Clause:</b>	15.247 (b)(3) RSS-247 5.4 d)	<b>Test Method:</b>	ANSI C63.10 Section 11.9.1.3

<b>Antenna Configuration:</b>	SISO	<b>Mode:</b>	LE
<b>Test Port:</b>	1 (Core 0-C0)	<b>Rate/Modulation:</b>	LE 2M (GFSK)

<b>Burst Tx</b>	Stability: < ±2%	Duty Cycle (%): 31.30	Period (ms): 0.625	Width (ms): 0.196
-----------------	------------------	-----------------------	--------------------	-------------------

Test Frequency (MHz)	Maximum Conducted Output Power (dBm)					Limit (dBm)	Margin (dB)	Antenna Gain (dBi)	EIRP (dBm)	EIRP Limit (dBm)	EIRP Margin (dB)
	1	2	3	4	Σ						
2402	14.76	-	-	-	-	30.00	15.24	5.86	20.62	36.00	15.38
2440	14.74	-	-	-	-	30.00	15.26	5.86	20.60	36.00	15.40
2480	14.54	-	-	-	-	30.00	15.46	5.86	20.40	36.00	15.60

**Transmitter Maximum Peak Output Power (continued)**

<b>Frequency Range:</b>	2400-2483.5 MHz	<b>Band:</b>	2.4 GHz
<b>Limit Clause:</b>	15.247 (b)(3) RSS-247 5.4 d)	<b>Test Method:</b>	ANSI C63.10 Section 11.9.1.3

<b>Antenna Configuration:</b>	Beamforming	<b>Mode:</b>	LE
<b>Test Port:</b>	1+2 (Core 0-C0 + Core 1-C1)	<b>Rate/Modulation:</b>	LE 1M (GFSK)

<b>Burst Tx</b>	Stability: < ±2%	Duty Cycle (%): 60.58	Period (ms): 0.625	Width (ms): 0.379
-----------------	------------------	-----------------------	--------------------	-------------------

Test Frequency (MHz)	Maximum Conducted Output Power (dBm)					Antenna Gain (dBi)	Limit (dBm)	Margin (dB)
	1	2	3	4	Σ			
2402	14.71	14.10	-	-	17.42	8.65	27.35	9.93
2440	14.72	14.12	-	-	17.40	8.65	27.35	9.95
2480	14.53	13.94	-	-	17.22	8.65	27.35	10.13

**FCC Maximum Conducted (peak) Output Power Results**

Test Frequency (MHz)	Maximum Conducted Output Power (dBm)					Limit (dBm)	Margin (dB)	Antenna Gain (dBi)	EIRP (dBm)	EIRP Limit (dBm)	EIRP Margin (dB)
	1	2	3	4	Σ						
2402	14.71	14.10	-	-	17.42	30.00	12.58	8.65	26.07	36.00	9.93
2440	14.72	14.12	-	-	17.40	30.00	12.60	8.65	26.05	36.00	9.95
2480	14.53	13.94	-	-	17.22	30.00	12.78	8.65	25.87	36.00	10.13

**ISED Maximum Conducted (peak) Output Power Results**

**Transmitter Maximum Peak Output Power (continued)**

<b>Frequency Range:</b>	2400-2483.5 MHz	<b>Band:</b>	2.4 GHz
<b>Limit Clause:</b>	15.247 (b)(3) RSS-247 5.4 d)	<b>Test Method:</b>	ANSI C63.10 Section 11.9.1.3

<b>Antenna Configuration:</b>	Beamforming	<b>Mode:</b>	LE
<b>Test Port:</b>	1+2 (Core 0-C0 + Core 1-C1)	<b>Rate/Modulation:</b>	LE 2M (GFSK)

<b>Burst Tx</b>	Stability: < ±2%	Duty Cycle (%): 31.29	Period (ms): 0.625	Width (ms): 0.196
-----------------	------------------	-----------------------	--------------------	-------------------

Test Frequency (MHz)	Maximum Conducted Output Power (dBm)					Antenna Gain (dBi)	Limit (dBm)	Margin (dB)
	1	2	3	4	Σ			
2402	14.33	14.15	-	-	17.21	8.65	27.35	10.13
2440	14.73	14.15	-	-	17.43	8.65	27.35	9.91
2480	14.65	14.07	-	-	17.34	8.65	27.35	10.01

**FCC Maximum Conducted (peak) Output Power Results**

Test Frequency (MHz)	Maximum Conducted Output Power (dBm)					Limit (dBm)	Margin (dB)	Antenna Gain (dBi)	EIRP (dBm)	EIRP Limit (dBm)	EIRP Margin (dB)
	1	2	3	4	Σ						
2402	14.33	14.15	-	-	17.21	30.00	12.79	8.65	25.87	36.00	10.13
2440	14.73	14.15	-	-	17.43	30.00	12.57	8.65	26.09	36.00	9.91
2480	14.65	14.07	-	-	17.34	30.00	12.66	8.65	25.99	36.00	10.01

**ISED Maximum Conducted (average) Output Power Results**

#### **4.4 Transmitter Power Spectral Density**

##### **Test Summary:**

<b>Test Engineer:</b>	Max Passell	<b>Test Dates:</b>	18 October 2023 & 19 October 2023
<b>Test Sample Serial Number:</b>	LHQYJ7F4Q4		

##### **Environmental Conditions:**

<b>Temperature (°C):</b>	21 to 23
<b>Relative Humidity (%):</b>	50 to 57

##### **Note(s):**

1. Transmitter Power Spectral Density tests were performed using a signal analyser in accordance with ANSI C63.10 Section 11.10.2.
2. For beamforming modes, conducted PSD was measured on Core 0 & Core 1 and then combined using the *measure and sum the spectra across the outputs* technique stated in FCC KDB 662911 D01 Section E)2)b).
3. The test system signal analyser resolution bandwidth was set to 3 kHz and video bandwidth 10 kHz. A Peak detector was used, sweep time was set to auto and the trace mode was Max Hold. The span was set to greater than 1.5 times the measured DTS bandwidth. A marker was placed at the peak of the signal and the results recorded in the table below.
4. Example plots of each modulation on middle channel, for one antenna configuration, can be seen below to show setting parameters comply with testing method/procedure. All other plots are archived on the UL IT server and available for inspection if required.

**Transmitter Power Spectral Density (continued)**

**Results:**

<b>Frequency Range:</b>	2400-2483.5 MHz	<b>Band:</b>	2.4 GHz
<b>Limit Clause:</b>	15.247 (e) RSS-247 5.2 (b)	<b>Test Method:</b>	ANSI C63.10 11.10.2

<b>Antenna Configuration:</b>	SISO	<b>Mode:</b>	LE
<b>Test Port:</b>	1 (Core 0-C0)	<b>Rate/Modulation:</b>	LE 1M (GFSK)

<b>Burst Tx</b>	Stability: < ±2%	Duty Cycle (%): 60.59	Period (ms): 0.625	Width (ms): 0.379
-----------------	------------------	-----------------------	--------------------	-------------------

Test Frequency (MHz)	PSD (dBm/3 kHz)					Limit (dBm/3 kHz)	Margin (dB)
	1	2	3	4	Σ		
2402	-0.81	-	-	-	-	8.00	8.81
2440	-0.79	-	-	-	-	8.00	8.79
2480	-1.03	-	-	-	-	8.00	9.03

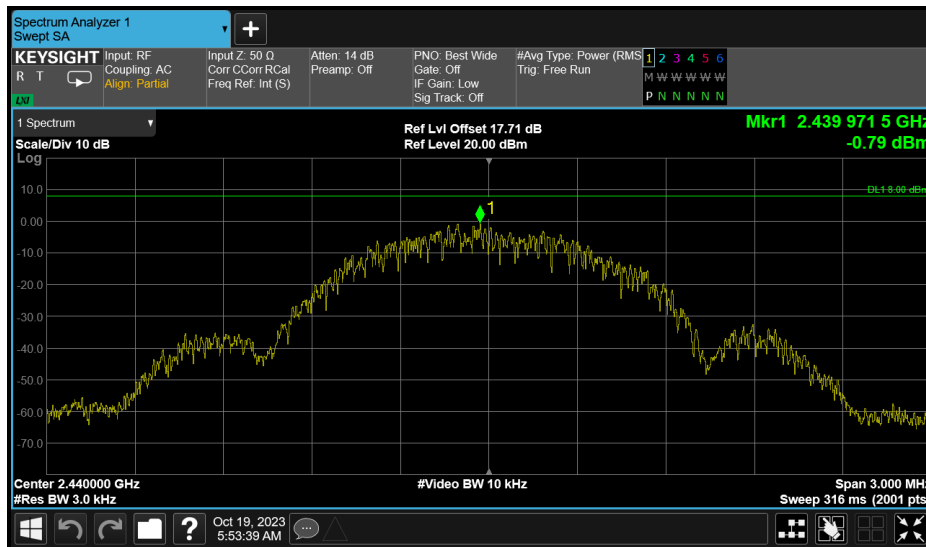

**Middle Channel**

**Transmitter Power Spectral Density (continued)**

<b>Frequency Range:</b>	2400-2483.5 MHz	<b>Band:</b>	2.4 GHz
<b>Limit Clause:</b>	15.247 (e) RSS-247 5.2 (b)	<b>Test Method:</b>	ANSI C63.10 11.10.2

<b>Antenna Configuration:</b>	SISO	<b>Mode:</b>	LE
<b>Test Port:</b>	1 (Core 0-C0)	<b>Rate/Modulation:</b>	LE 2M (GFSK)

<b>Burst Tx</b>	Stability: < ±2%	Duty Cycle (%): 31.30	Period (ms): 0.625	Width (ms): 0.196
-----------------	------------------	-----------------------	--------------------	-------------------

Test Frequency (MHz)	PSD (dBm/3 kHz)					Limit (dBm/3 kHz)	Margin (dB)
	1	2	3	4	Σ		
2402	-3.24	-	-	-	-	8.00	11.24
2440	-3.11	-	-	-	-	8.00	11.11
2480	-3.38	-	-	-	-	8.00	11.38

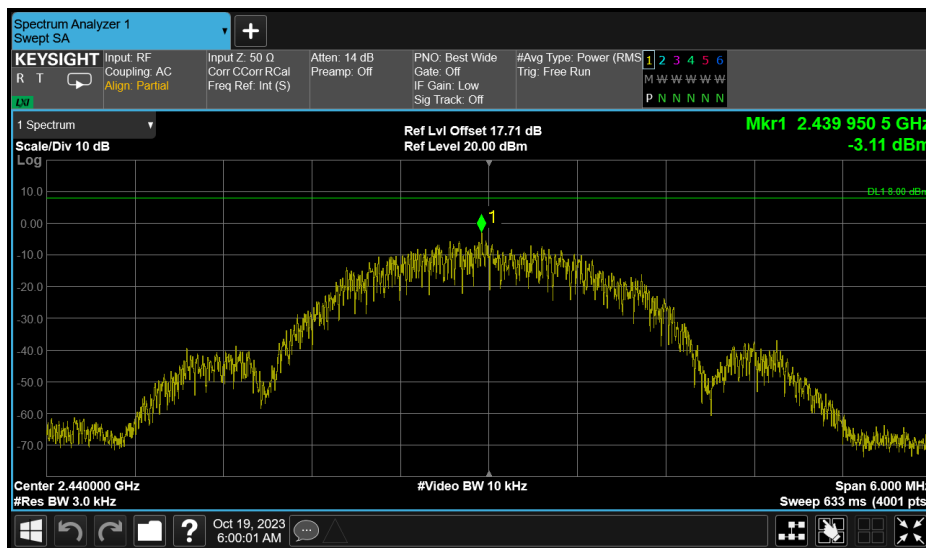

**Middle Channel**

**Transmitter Power Spectral Density (continued)**

<b>Frequency Range:</b>	2400-2483.5 MHz	<b>Band:</b>	2.4 GHz
<b>Limit Clause:</b>	15.247 (e) RSS-247 5.2 (b)	<b>Test Method:</b>	ANSI C63.10 11.10.2

<b>Antenna Configuration:</b>	Beamforming	<b>Mode:</b>	LE
<b>Test Port:</b>	1+2 (Core 0-C0 + Core 1-C1)	<b>Rate/Modulation:</b>	LE 1M (GFSK)

<b>Burst Tx</b>	Stability: < ±2%	Duty Cycle (%): 60.58	Period (ms): 0.625	Width (ms): 0.379
-----------------	------------------	-----------------------	--------------------	-------------------

Test Frequency (MHz)	PSD (dBm/3 kHz)					Limit (dBm/3 kHz)	Margin (dB)
	1	2	3	4	Σ		
2402	-1.20	-1.94	-	-	1.45	8.00	6.55
2440	-1.10	-1.81	-	-	1.57	8.00	6.43
2480	-1.22	-1.95	-	-	1.44	8.00	6.56

<b>Frequency Range:</b>	2400-2483.5 MHz	<b>Band:</b>	2.4 GHz
<b>Limit Clause:</b>	15.247 (e) RSS-247 5.2 (b)	<b>Test Method:</b>	ANSI C63.10 11.10.2

<b>Antenna Configuration:</b>	Beamforming	<b>Mode:</b>	LE
<b>Test Port:</b>	1+2 (Core 0-C0 + Core 1-C1)	<b>Rate/Modulation:</b>	LE 2M (GFSK)

<b>Burst Tx</b>	Stability: < ±2%	Duty Cycle (%): 31.31	Period (ms): 0.625	Width (ms): 0.196
-----------------	------------------	-----------------------	--------------------	-------------------

Test Frequency (MHz)	PSD (dBm/3 kHz)					Limit (dBm/3 kHz)	Margin (dB)
	1	2	3	4	Σ		
2402	-3.98	-4.08	-	-	-1.02	8.00	9.02
2440	-3.30	-3.99	-	-	-0.62	8.00	8.62
2480	-3.42	-4.16	-	-	-0.76	8.00	8.76



## **5 Radiated Test Results**

### **5.1 Transmitter Radiated Emissions <1 GHz**

#### **Test Summary:**

<b>Test Engineers:</b>	Andrew Harding & Jose Bayona	<b>Test Dates:</b>	12 October 2023 & 20 October 2023
<b>Test Sample Serial Number:</b>	GCX4C2H43F		

<b>FCC Reference:</b>	Parts 15.247(d) & 15.209(a)
<b>ISED Canada Reference:</b>	RSS-Gen 6.13 & 8.9 / RSS-247 5.5
<b>Test Method Used:</b>	ANSI C63.10 Sections 6.3, 6.4 and 6.5
<b>Frequency Range</b>	9 kHz to 1000 MHz

#### **Environmental Conditions:**

<b>Temperature (°C):</b>	21 to 23
<b>Relative Humidity (%):</b>	43 to 49

#### **Note(s):**

1. The final measured value, for the given emission, in the table below incorporates the calibrated antenna factor and cable loss.
2. The preliminary scans showed similar emission levels below 1 GHz, for each channel of operation. Therefore final radiated emissions measurements were performed with the EUT set to the middle channel only.
3. All other emissions shown on the pre-scans were investigated and found to be ambient, or > 20 dB below the appropriate limit or below the noise floor of the measurement system.
4. Measurements below 30 MHz were performed in a semi-anechoic chamber (Asset Number K0001) at 3 metres. The EUT was placed at a height of 80 cm above the reference ground plane in the centre of the chamber turntable. The limit was extrapolated to 3 metres in accordance with ANSI C63.10 clause 6.4.3 using the method described in clause 6.4.4.2. ANSI C63.10 clause 5.2 states an alternative test site that can demonstrate equivalence to an open area test site may be used for measurements below 30 MHz. Therefore, measurements were performed in a semi-anechoic chamber. The correlation data between semi-anechoic chamber and an open field test site is available upon request.
5. Measurements from 30 MHz to 1 GHz were performed in a semi-anechoic chamber (Asset Number K0001 & K0017) at a distance of 3 metres. The EUT was placed at a height of 80 cm above the reference ground plane in the centre of the chamber turntable. Maximum emission levels were determined by height searching the measurement antenna over the range 1 metre to 4 metres.
6. Pre-scans were performed and markers placed on the highest measured levels. The test receiver was configured as follows: For 9 kHz to 150 kHz, the resolution bandwidth was set to 300 Hz and video bandwidth 1 kHz. A peak detector was used and trace mode was Max Hold. For 150 kHz to 30 MHz, the resolution bandwidth was set to 10 kHz and video bandwidth 30 kHz, trace mode was Max Hold. For 30 MHz to 1 GHz, the resolution bandwidth was set to 120 kHz and video bandwidth 500 kHz. A peak detector was used, sweep time was set to auto and trace mode was Max Hold.
7. Final measurements were performed on the marker frequencies and the results entered into the table below. The test receiver resolution bandwidth was set to 120 kHz, using a CISPR quasi-peak detector and span wide enough to see the whole emission.

**Transmitter Radiated Emissions (continued)**

**Results: Quasi-Peak / Middle Channel / LE2M / Beamforming / Core 0 + Core 1**

Frequency (MHz)	Antenna Polarity	Level (dB $\mu$ V/m)	Limit (dB $\mu$ V/m)	Margin (dB)	Result
133.531	Vertical	30.3	43.5	13.2	Complied
252.063	Vertical	29.4	46.0	16.6	Complied

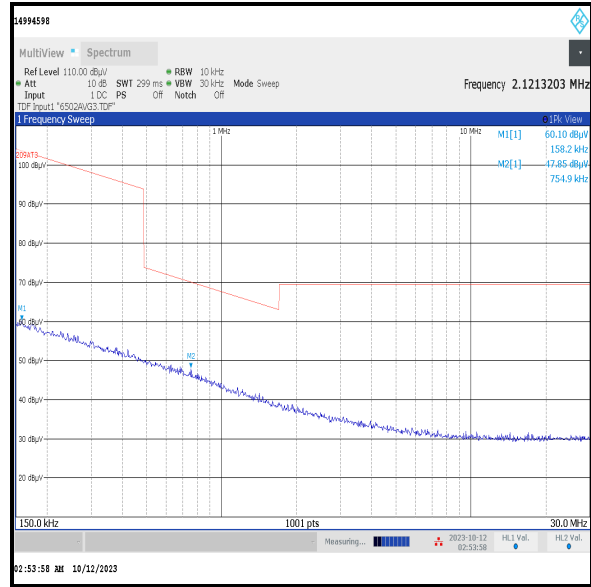
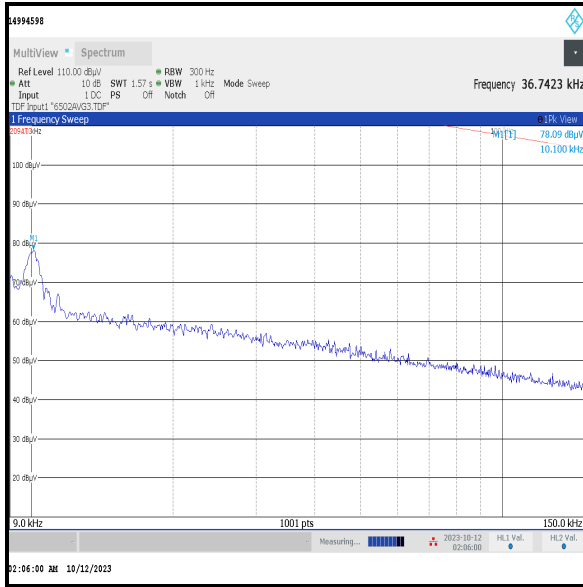

Note: These plots are pre-scans and for indication purposes only. For final measurements, see accompanying table.

## **5.2 Transmitter Radiated Emissions >1 GHz**

### **Test Summary:**

<b>Test Engineer:</b>	Andrew Harding	<b>Test Dates:</b>	10 October 2023 & 11 October 2023
<b>Test Sample Serial Number:</b>	GCX4C2H43F		

<b>FCC Reference:</b>	Parts 15.247(d) & 15.209(a)
<b>ISED Canada Reference:</b>	RSS-Gen 6.13 & 8.9 / RSS-247 5.5
<b>Test Method Used:</b>	FCC KDB 558074 Sections 8.1 c)3), 8.5 & 8.6 referencing ANSI C63.10 Sections 6.3, 6.6, 11.11 & 11.12
<b>Frequency Range</b>	1 GHz to 25 GHz

### **Environmental Conditions:**

<b>Temperature (°C):</b>	24 to 25
<b>Relative Humidity (%):</b>	47 to 48

### **Note(s):**

1. The final measured value, for the given emission, in the table below incorporates the calibrated antenna factor and cable loss.
2. No spurious emissions were detected above the noise floor of the measuring receiver therefore the highest peak and average noise floor readings of the measuring receiver were recorded as shown in the tables below.
3. The emission shown on the 1 GHz to 3 GHz plot at approximately 2440 MHz is the EUT fundamental.
4. Pre-scans above 1 GHz were performed in a fully anechoic chamber (Asset Number K0017) at a distance of 3 metres. The EUT was placed at a height of 1.5 metres above the test chamber floor in the centre of the chamber turntable. All measurement antennas were placed at a fixed height of 1.5 metres above the test chamber floor, in line with the EUT.
5. Pre-scans were performed and a marker placed on the highest measured level of the appropriate plot. The test receiver resolution bandwidth was set to 1 MHz and video bandwidth 3 MHz. The sweep time was set to auto. Peak and average measurements were performed with their own appropriate detectors during the pre-scan measurements.

### **Results: Peak / Middle Channel / LE2M / Beamforming / Core 0 + Core 1**

Frequency (MHz)	Antenna Polarity	Level (dB $\mu$ V/m)	Limit (dB $\mu$ V/m)	Margin (dB)	Result
2915.000	Vertical	56.1	74.0	17.9	Complied

### **Results: Average / Middle Channel / LE2M / Beamforming / Core 0 + Core 1**

Frequency (MHz)	Antenna Polarity	Level (dB $\mu$ V/m)	Limit (dB $\mu$ V/m)	Margin (dB)	Result
2935.000	Vertical	49.1	54.0	4.9	Complied

### Transmitter Radiated Emissions (continued)

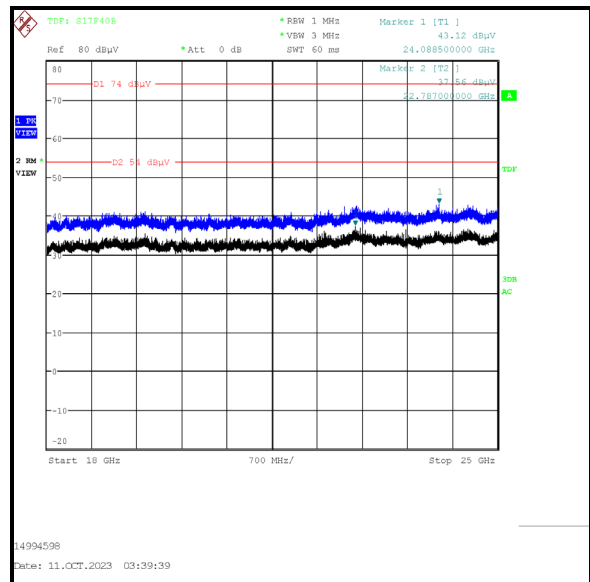
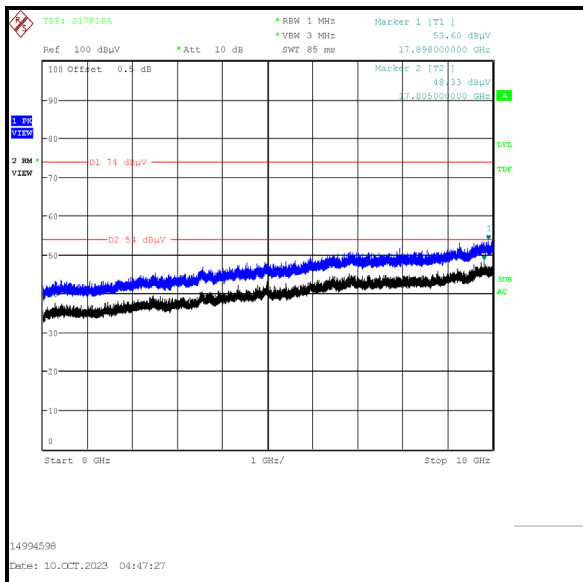
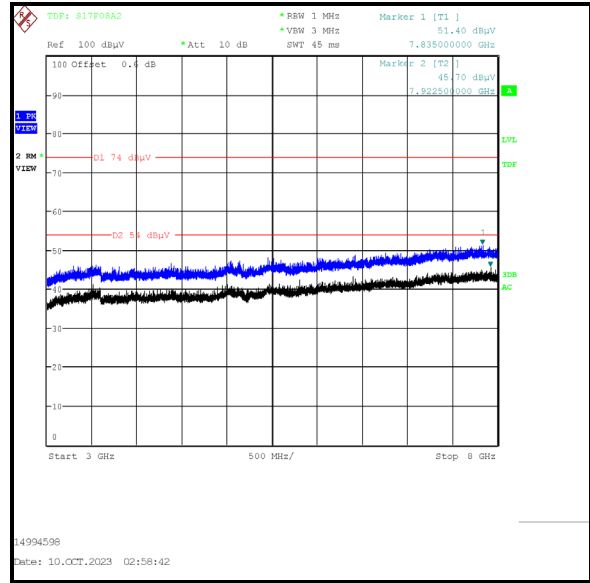
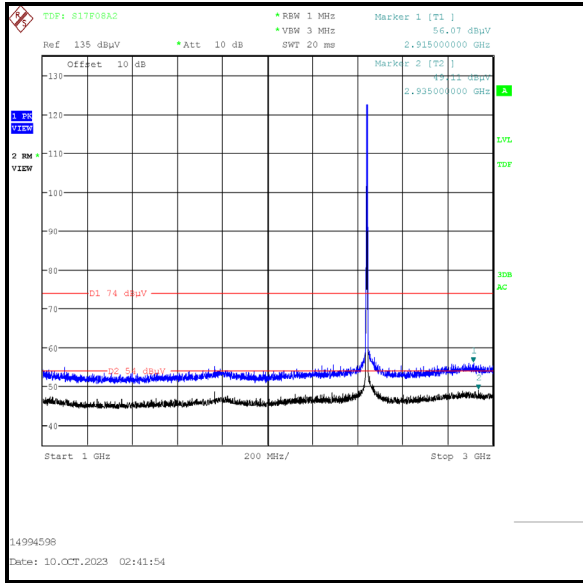

### **5.3 Transmitter Band Edge Radiated Emissions**

#### **Test Summary:**

<b>Test Engineers:</b>	John Ferdinand, Andrew Harding & Nick Steele	<b>Test Dates:</b>	13 September 2023 to 23 September 2023
<b>Test Sample Serial Number:</b>	LH497WX5HX		

<b>FCC Reference:</b>	Parts 15.247(d) & 15.209(a)
<b>ISED Canada Reference:</b>	RSS-Gen 6.13 / RSS-247 5.5
<b>Test Method Used:</b>	KDB 558074 Section 8.7 referencing ANSI C63.10 Sections 11.11, 11.12 & 11.13

#### **Environmental Conditions:**

<b>Temperature (°C):</b>	25 to 27
<b>Relative Humidity (%):</b>	45 to 51

#### **Note(s):**

1. The final measured value, for the given emission, in the table below incorporates the calibrated antenna factor and cable loss.
2. As the lower band edge is adjacent to a non-restricted band, only peak measurements are required. In accordance with ANSI C63.10 Section 11.11.1, the test method in Section 11.11.3 was followed: the test receiver resolution bandwidth was set to 100 kHz and video bandwidth 300 kHz. A peak detector was used, sweep time was set to auto and trace mode was Max Hold. The test receiver was left to sweep for a sufficient length of time in order to maximise the carrier level and out-of-band emissions. A marker and corresponding reference level line were placed on the peak of the carrier. As the maximum peak conducted output power was measured using a peak detector in accordance with ANSI C63.10 Section 11.9.1.1 an out-of-band limit line was placed 20 dB (ANSI C63.10 Section 11.11.1(a)) below the peak level. A marker was placed on the band edge spot frequencies. Marker frequency and levels were recorded.
3. As the upper band edge is adjacent to a restricted band, both peak and average measurements were recorded by placing a marker at the edge of the band. For peak measurements the test receiver resolution bandwidth was set to 1 MHz and the video bandwidth 3 MHz. A peak detector was used, sweep time was set to auto and trace mode was Max Hold. For average measurements the test receiver resolution bandwidth was set to 1 MHz and the video bandwidth 3 MHz. An RMS detector was used, sweep time was set to auto and trace mode was trace averaging over 300 sweeps. A marker was placed on the band edge spot frequencies and a second marker placed on the highest emission level in the adjacent restricted band of operation (where a higher level emission was present). Marker frequencies and levels were recorded.
4. There is a restricted band 10 MHz below the lower band edge. The test receiver was set up as follows: the RBW set to 1 MHz, the VBW set to 3 MHz, with the sweep time set to auto couple. Peak and average measurements were performed with peak and RMS detectors respectively. Markers were placed on the highest point on each trace.
5. \* -20 dBc limit.

**Transmitter Band Edge Radiated Emissions (continued)****Results: LE1M / SISO / Core 0**

Frequency (MHz)	Antenna Polarity	Peak Level (dB $\mu$ V/m)	Limit (dB $\mu$ V/m)	Margin (dB)	Result
2400.0	Vertical	51.0	96.3*	45.3	Complied
2483.5	Vertical	56.7	74.0	17.3	Complied
2483.750	Vertical	57.7	74.0	16.3	Complied

Frequency (MHz)	Antenna Polarity	Average Level (dB $\mu$ V/m)	Limit (dB $\mu$ V/m)	Margin (dB)	Result
2483.5	Vertical	46.8	54.0	7.2	Complied

**Results: 2310 MHz to 2390 MHz Restricted Band / Peak**

Frequency (MHz)	Antenna Polarity	Level (dB $\mu$ V/m)	Limit (dB $\mu$ V/m)	Margin (dB)	Result
2389.359	Vertical	55.6	74.0	18.4	Complied

**Results: 2310 MHz to 2390 MHz Restricted Band / Average**

Frequency (MHz)	Antenna Polarity	Level (dB $\mu$ V/m)	Limit (dB $\mu$ V/m)	Margin (dB)	Result
2389.744	Vertical	44.3	54.0	9.7	Complied

**Transmitter Band Edge Radiated Emissions (continued)**

**Results: LE1M / SISO / Core 0**

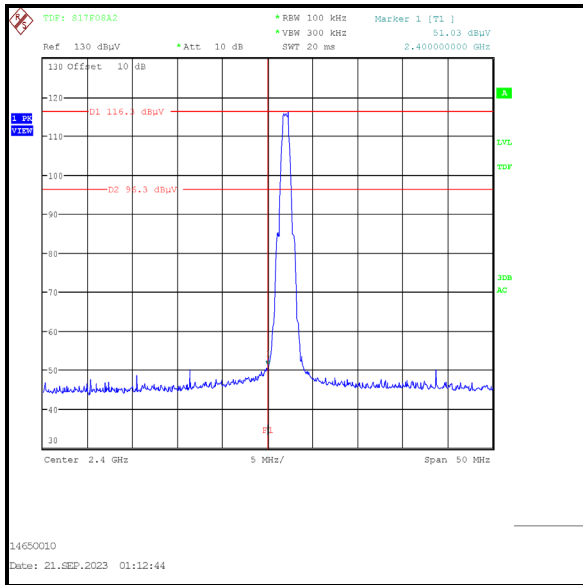

**Lower Band Edge**

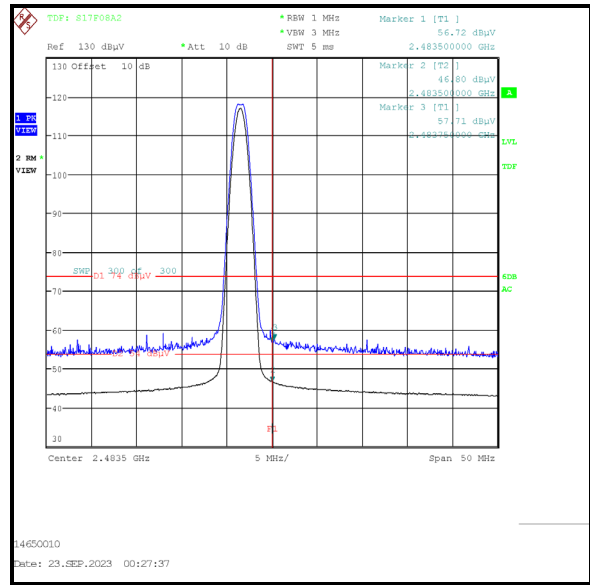

**Upper Band Edge**

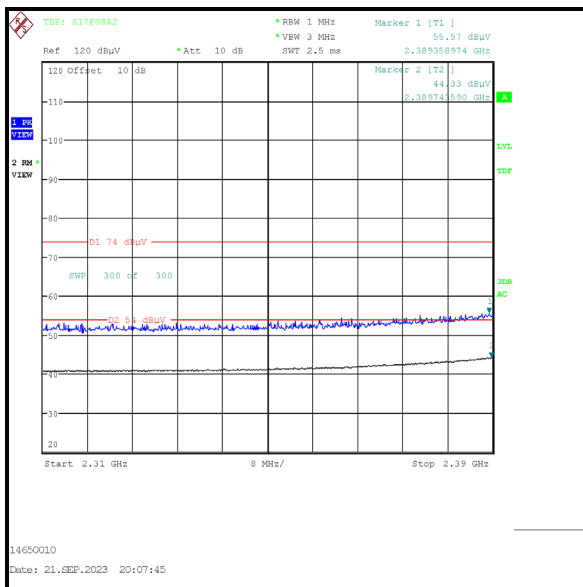

**2310 MHz to 2390 MHz Restricted Band**

**Transmitter Band Edge Radiated Emissions (continued)****Results: LE2M / SISO / Core 0**

Frequency (MHz)	Antenna Polarity	Peak Level (dB $\mu$ V/m)	Limit (dB $\mu$ V/m)	Margin (dB)	Result
2400.0	Vertical	79.5	94.3*	14.8	Complied
2483.5	Vertical	60.2	74.0	13.8	Complied

Frequency (MHz)	Antenna Polarity	Average Level (dB $\mu$ V/m)	Limit (dB $\mu$ V/m)	Margin (dB)	Result
2483.5	Vertical	50.2	54.0	3.8	Complied

**Results: 2310 MHz to 2390 MHz Restricted Band / Peak**

Frequency (MHz)	Antenna Polarity	Level (dB $\mu$ V/m)	Limit (dB $\mu$ V/m)	Margin (dB)	Result
2389.744	Vertical	54.9	74.0	19.1	Complied

**Results: 2310 MHz to 2390 MHz Restricted Band / Average**

Frequency (MHz)	Antenna Polarity	Level (dB $\mu$ V/m)	Limit (dB $\mu$ V/m)	Margin (dB)	Result
2389.744	Vertical	44.1	54.0	9.9	Complied



**Transmitter Band Edge Radiated Emissions (continued)**

**Results: LE2M / SISO / Core 0**

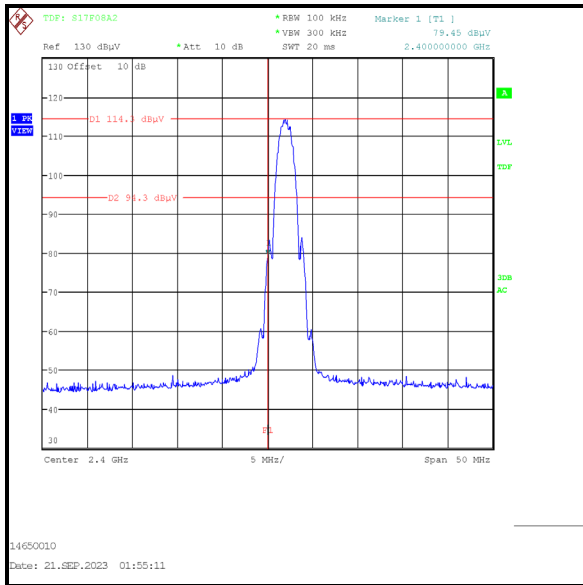

**Lower Band Edge**

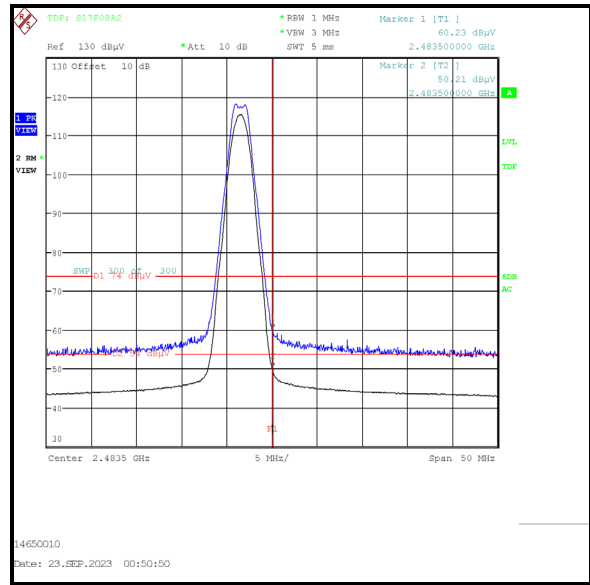

**Upper Band Edge**

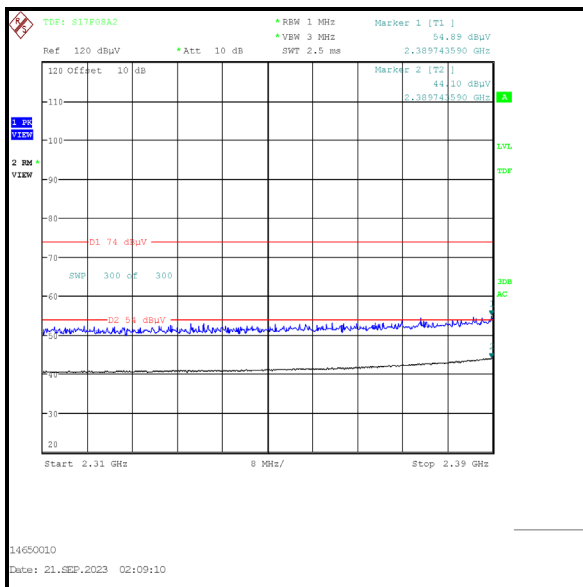

**2310 MHz to 2390 MHz Restricted Band**

**Transmitter Band Edge Radiated Emissions (continued)****Results: LE1M / SISO / Core 1**

Frequency (MHz)	Antenna Polarity	Peak Level (dB $\mu$ V/m)	Limit (dB $\mu$ V/m)	Margin (dB)	Result
2400.0	Vertical	49.9	95.3*	45.4	Complied
2483.5	Vertical	56.8	74.0	17.2	Complied
2483.850	Vertical	57.2	74.0	16.8	Complied

Frequency (MHz)	Antenna Polarity	Average Level (dB $\mu$ V/m)	Limit (dB $\mu$ V/m)	Margin (dB)	Result
2483.5	Vertical	46.1	54.0	7.9	Complied

**Results: 2310 MHz to 2390 MHz Restricted Band / Peak**

Frequency (MHz)	Antenna Polarity	Level (dB $\mu$ V/m)	Limit (dB $\mu$ V/m)	Margin (dB)	Result
2386.410	Vertical	54.6	74.0	19.4	Complied

**Results: 2310 MHz to 2390 MHz Restricted Band / Average**

Frequency (MHz)	Antenna Polarity	Level (dB $\mu$ V/m)	Limit (dB $\mu$ V/m)	Margin (dB)	Result
2389.872	Vertical	43.0	54.0	11.0	Complied

**Transmitter Band Edge Radiated Emissions (continued)**

**Results: LE1M / SISO / Core 1**

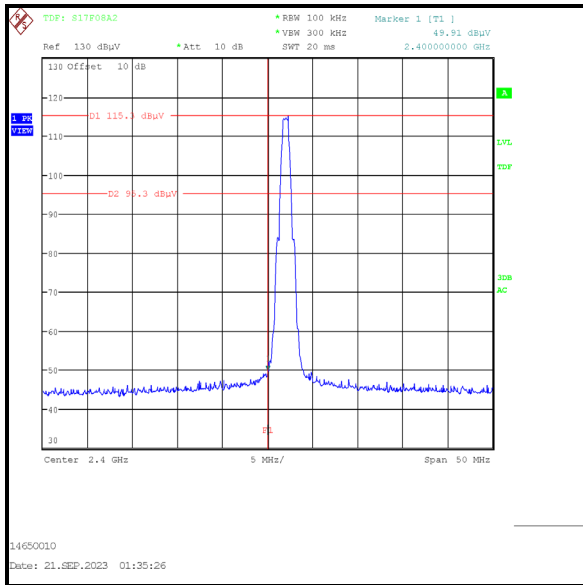

**Lower Band Edge**

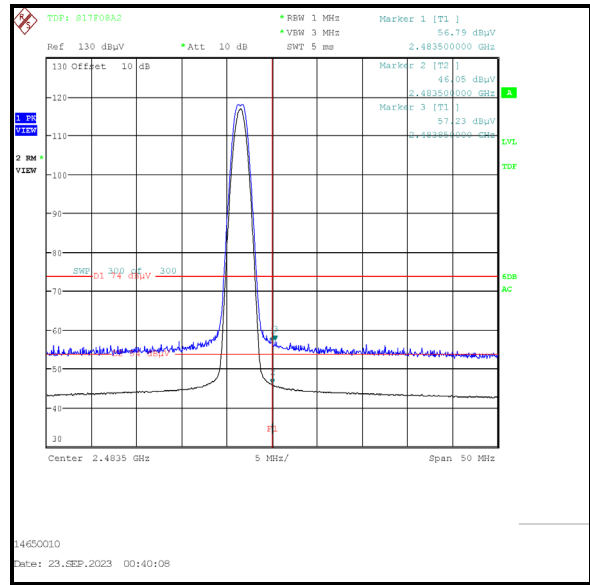

**Upper Band Edge**

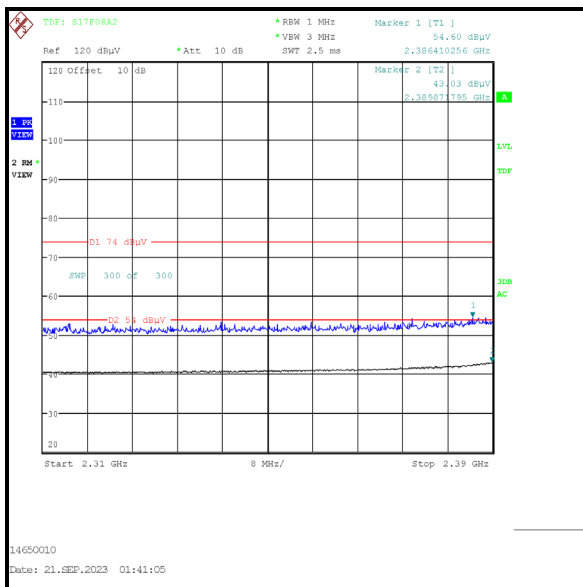

**2310 MHz to 2390 MHz Restricted Band**

**Transmitter Band Edge Radiated Emissions (continued)****Results: LE2M / SISO / Core 1**

Frequency (MHz)	Antenna Polarity	Peak Level (dB $\mu$ V/m)	Limit (dB $\mu$ V/m)	Margin (dB)	Result
2400.0	Vertical	78.7	93.6*	14.9	Complied
2483.5	Vertical	60.7	74.0	13.3	Complied

Frequency (MHz)	Antenna Polarity	Average Level (dB $\mu$ V/m)	Limit (dB $\mu$ V/m)	Margin (dB)	Result
2483.5	Vertical	49.3	54.0	4.7	Complied

**Results: 2310 MHz to 2390 MHz Restricted Band / Peak**

Frequency (MHz)	Antenna Polarity	Level (dB $\mu$ V/m)	Limit (dB $\mu$ V/m)	Margin (dB)	Result
2389.872	Vertical	54.7	74.0	19.3	Complied

**Results: 2310 MHz to 2390 MHz Restricted Band / Average**

Frequency (MHz)	Antenna Polarity	Level (dB $\mu$ V/m)	Limit (dB $\mu$ V/m)	Margin (dB)	Result
2389.872	Vertical	43.4	54.0	10.6	Complied

### Transmitter Band Edge Radiated Emissions (continued)

#### Results: LE2M / SISO / Core 1

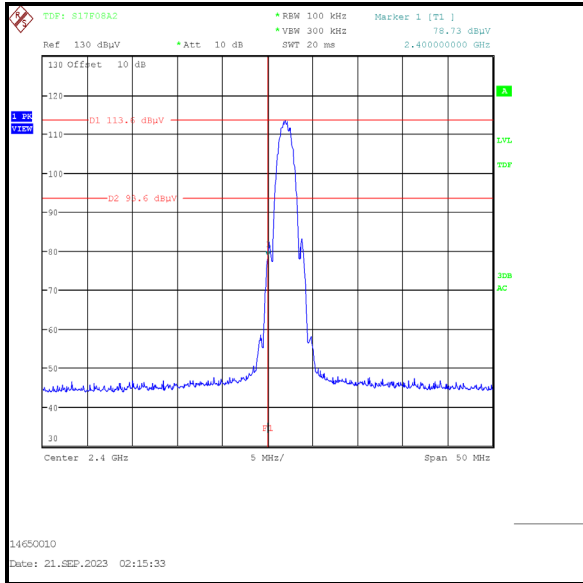

Lower Band Edge

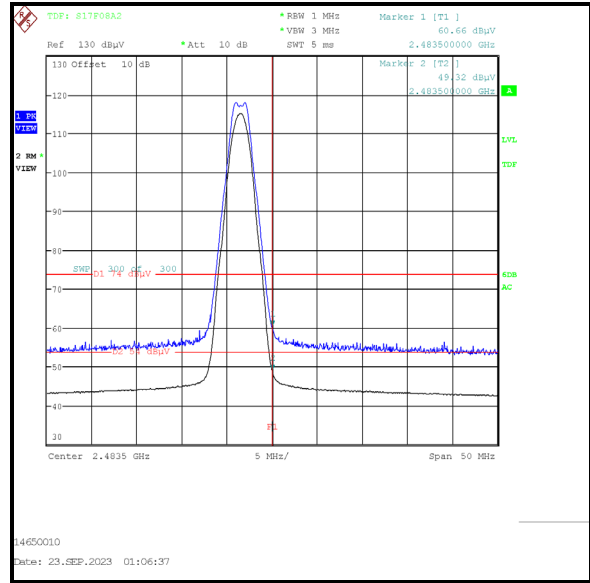

Upper Band Edge

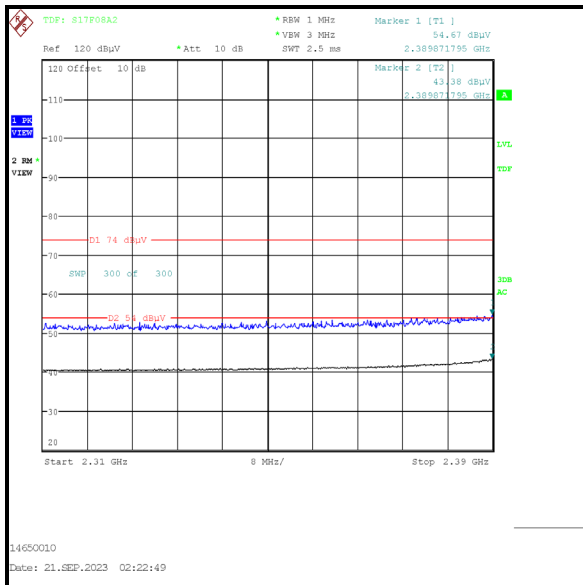

2310 MHz to 2390 MHz Restricted Band

**Transmitter Band Edge Radiated Emissions (continued)****Results: LE1M / Beamforming / Core 0 + Core 1**

Frequency (MHz)	Antenna Polarity	Peak Level (dB $\mu$ V/m)	Limit (dB $\mu$ V/m)	Margin (dB)	Result
2400.0	Vertical	54.5	100.0*	45.5	Complied
2483.5	Vertical	59.4	74.0	14.6	Complied
2483.660	Vertical	60.9	74.0	13.1	Complied

Frequency (MHz)	Antenna Polarity	Average Level (dB $\mu$ V/m)	Limit (dB $\mu$ V/m)	Margin (dB)	Result
2483.5	Vertical	49.5	54.0	4.5	Complied
2483.580	Vertical	49.7	54.0	4.3	Complied

**Results: 2310 MHz to 2390 MHz Restricted Band / Peak / LE1M**

Frequency (MHz)	Antenna Polarity	Level (dB $\mu$ V/m)	Limit (dB $\mu$ V/m)	Margin (dB)	Result
2375.641	Vertical	62.2	74.0	11.8	Complied

**Results: 2310 MHz to 2390 MHz Restricted Band / Average / LE1M**

Frequency (MHz)	Antenna Polarity	Level (dB $\mu$ V/m)	Limit (dB $\mu$ V/m)	Margin (dB)	Result
2389.744	Vertical	44.9	54.0	9.1	Complied

### Transmitter Band Edge Radiated Emissions (continued)

#### Results: LE1M / Beamforming / Core 0 + Core 1

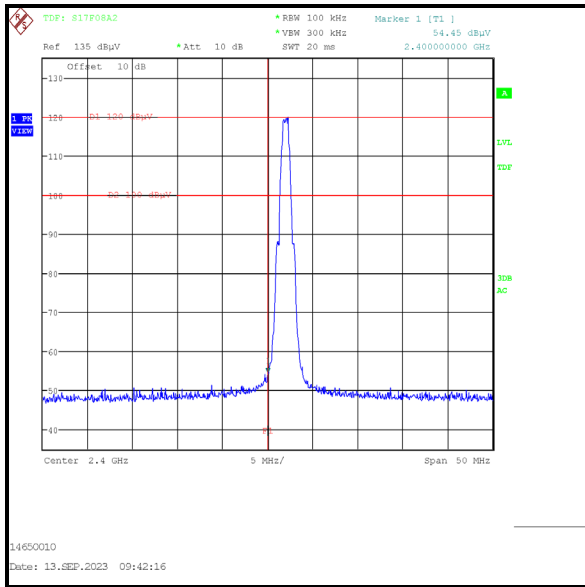

Lower Band Edge

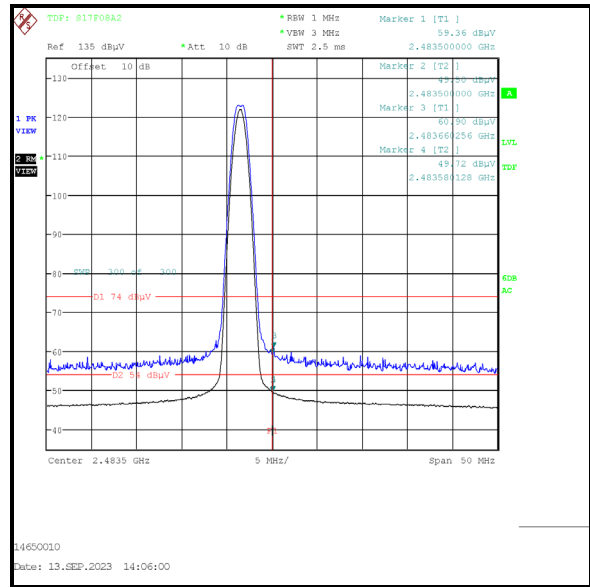

Upper Band Edge

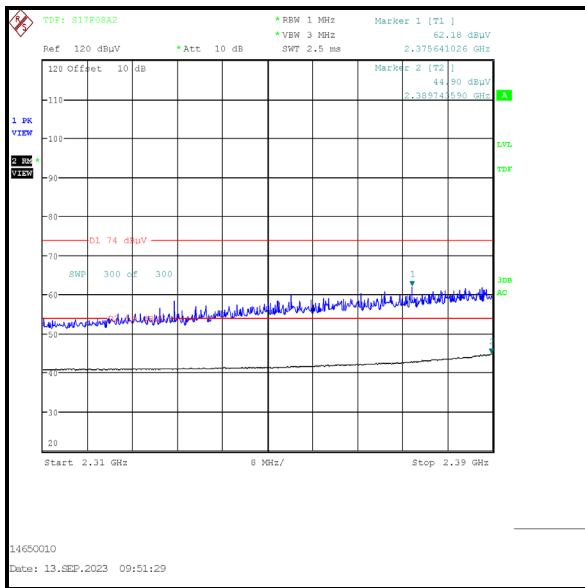

2310 MHz to 2390 MHz Restricted Band

**Transmitter Band Edge Radiated Emissions (continued)****Results: LE2M / Beamforming / Core 0 + Core 1**

Frequency (MHz)	Antenna Polarity	Peak Level (dB $\mu$ V/m)	Limit (dB $\mu$ V/m)	Margin (dB)	Result
2400.0	Vertical	82.8	98.0*	15.2	Complied
2483.5	Vertical	60.1	74.0	13.9	Complied

Frequency (MHz)	Antenna Polarity	Average Level (dB $\mu$ V/m)	Limit (dB $\mu$ V/m)	Margin (dB)	Result
2483.5	Vertical	51.2	54.0	2.8	Complied

**Results: 2310 MHz to 2390 MHz Restricted Band / Peak**

Frequency (MHz)	Antenna Polarity	Level (dB $\mu$ V/m)	Limit (dB $\mu$ V/m)	Margin (dB)	Result
2384.872	Vertical	62.6	74.0	11.4	Complied

**Results: 2310 MHz to 2390 MHz Restricted Band / Average**

Frequency (MHz)	Antenna Polarity	Level (dB $\mu$ V/m)	Limit (dB $\mu$ V/m)	Margin (dB)	Result
2389.615	Vertical	45.3	54.0	8.7	Complied



**Transmitter Band Edge Radiated Emissions (continued)**

**Results: LE2M / Beamforming / Core 0 + Core 1**

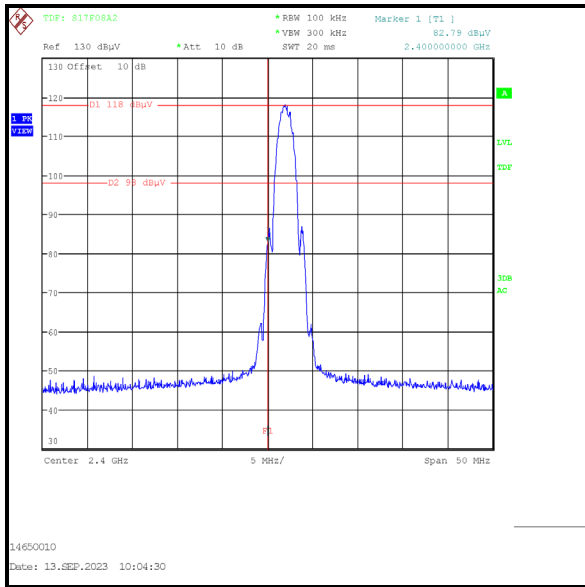

**Lower Band Edge**

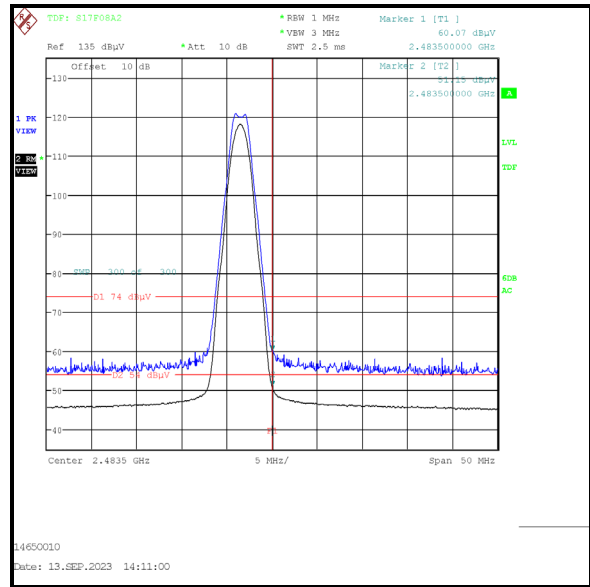

**Upper Band Edge**

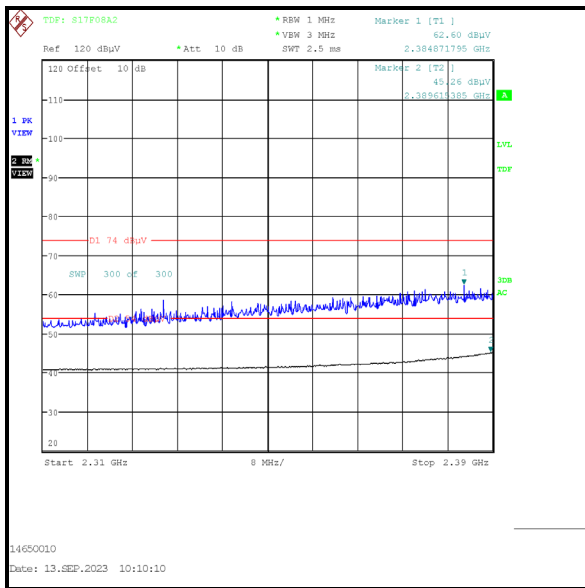

**2310 MHz to 2390 MHz Restricted Band**

**--- END OF REPORT ---**