



Add value.
Inspire trust.

Report on the Specific Absorption Rate Testing of the A3112

Apple Inc.
Model: A3112

In accordance with FCC 47 CFR 2.1093 (2023)

Prepared for: Apple Inc.
One Apple Park Way
Cupertino
California
95014
USA

FCC ID: BCGA3112

COMMERCIAL-IN-CONFIDENCE

Document Number: 75960544-20 Issue:02



SIGNATURE

NAME	JOB TITLE	RESPONSIBLE FOR	ISSUE DATE
Jon Kenny	Technical Director	Authorised Signatory	10 October 2024

Signatories in this approval box have checked this document in line with the requirements of TÜV SÜD document control rules.

EXECUTIVE SUMMARY

A sample of this product was tested and found to be compliant with FCC 47 CFR 2.1093 (2023) for the tests detailed in section 1.

DISCLAIMER AND COPYRIGHT
This non-binding report has been prepared by TÜV SÜD with all reasonable skill and care. The document is confidential to the potential Client and TÜV SÜD. No part of this document may be reproduced without the prior written approval of TÜV SÜD. © 2024 TÜV SÜD. This report relates only to the actual item/items tested.

ACCREDITATION
Results of tests covered by our Flexible UKAS Accreditation Schedule are marked FS (Flexible Scope)
Results of tests not covered by our UKAS Accreditation Schedule are marked NUA (Not UKAS Accredited)
Our UKAS Accreditation does not cover opinions and interpretations and any expressed are outside the scope of our UKAS Accreditation.

TÜV SÜD
is a trading name of TÜV SÜD Ltd
Registered in Scotland at East Kilbride,
Glasgow G75 0QF, United Kingdom
Registered number: SC215164

TUV SUD Ltd is a
TÜV SÜD Group Company

Phone: +44 (0) 1489 558100
Fax: +44 (0) 1489 558101
www.tuv-sud.co.uk

TÜV SÜD
Octagon House
Concorde Way
Fareham
Hampshire PO15 5RL
United Kingdom



CONTENTS

Section	Page No
1	REPORT SUMMARY 3
1.1	Report Modification Record 4
1.2	Introduction 4
1.3	Identification of the EUT 5
1.4	Brief Summary of Results 6
1.5	Test Results Summary 9
1.6	Power Tables (Tune Up Values) 35
1.7	Conducted Power Measurements 75
2	TEST DETAILS 86
2.1	DASY6 Measurement System 87
3	TEST EQUIPMENT USED 95
3.1	Test Equipment Used 96
3.2	Test Software 98
3.3	Test Verification 99
3.4	Dielectric Properties of Simulant Liquids 101
3.5	Test Conditions 102
3.6	Measurement Uncertainty 103
4	ACCREDITATION, DISCLAIMERS AND COPYRIGHT 110
4.1	Accreditation, Disclaimers and Copyright 111
ANNEX A	Probe Calibration Reports A.2
ANNEX B	Dipole Calibration Reports B.2
ANNEX C	SAR Plots C.2
ANNEX D	Thread Technology Duty Factor Correction D.2



SECTION 1

REPORT SUMMARY

Specific Absorption Rate Testing of the A3112



1.1 REPORT MODIFICATION RECORD

Alterations and additions to this report will be issued to the holders of each copy in the form of a complete document.

Issue	Description of Change	Date of Issue
1	First Issue	23 Aug 2024
2	Amending Typographical Error	10-Oct-2024

Table 1

1.2 INTRODUCTION

The information contained in this report is intended to show verification of the Specific Absorption Rate testing of the A3112 to the requirements of FCC 47 CFR 2.1093 (2023).

Objective	To determine the Equipment Under Test's (EUT) compliance with the requirements specified within FCC 47 CFR 2.1093 (2023).
Applicant	Apple Inc.
EUT/Sample Identification	Refer to section 1.3
Test Specification/Issue/Date	FCC 47 CFR 2.1093 (2023)
Start of Test	17-July-2024
Finish of Test	01-August-2024
Related Document(s)	FCC 47 CFR 1.1310 ICNIRP 2020 IEC-IEEE 62209-1528-2020 IEC/IEEE 63195-1:2022 KDB 248227 - D01 v02r02 KDB 447498 - D01 v06 KDB 865664 - D01 v01r04 SPEAG, DASY8 Application Note: SAR, APD & PD at 6 - 10 GHz (Version 6.0), August 2022 October 2020 TCBC Workshop Notes
Name of Engineer(s)	Umesh Kabbur Sruthy Sudevan Sohaib Abbas Bukhari Shahanas Shan Valentinas Luza Prince Elvis Gomes Gualberta Madeira Christopher Sincock



1.3 IDENTIFICATION OF THE EUT

The table below details identification of the EUT(s) that have been used to carry out the testing within this report.

Model: A3112			
Serial Number	Hardware Version	Software Version	Firmware
GF3G6014XR	REV1.0	24A21940x	WLAN: 23.30.16 Bluetooth: 22.1.65.459
LQMRP403G3	REV1.0	24A21940x	WLAN: 23.30.16 Bluetooth: 22.1.65.459
LWTXJL9LWN	REV1.0	24A21940x	WLAN: 23.30.16 Bluetooth: 22.1.65.459
D4WJY3219F	REV1.0	24A21940x	WLAN: 23.30.16 Bluetooth: 22.1.65.459
C93JGXW0FP	REV1.0	24A21940x	WLAN: 23.30.16 Bluetooth: 22.1.65.459
MWHGKN9LF9	REV1.0	24A21940x	WLAN: 23.30.16 Bluetooth: 22.1.65.459

Table 2



1.4 BRIEF SUMMARY OF RESULTS

The measurements shown in this report were made to the requirements of FCC 47 CFR 2.1093 (2023).

1.4.1 Summary of Maximum Values

The maximum 1g volume averaged stand-alone SAR found during this Assessment:

Max 1g SAR (W/kg) Body	0.828 (Measured)	1.054 (Scaled)
The maximum 1g volume averaged SAR level measured for all the tests performed did not exceed the limits for FCC General Population/Uncontrolled Exposure Partial Body of 1.6 W/kg in accordance with FCC 47 CFR 1.1310.		

Table 3

The maximum iPD 4cm² found during this Assessment:

Max iPD 4cm ² (W/m ²)	3.98 (Measured)
The maximum iPD averaged over 4cm ² measured for all the tests performed did not exceed the standalone limits for FCC General Population/Uncontrolled Exposure of 10.00 W/m ² in accordance with FCC 47 CFR 1.1310.	

Table 4

The maximum 1g volume averaged stand-alone Reported SAR found during this assessment for each supported mode:

Technology	Band	Test Configuration	Max Reported SAR (W/kg)
Bluetooth (5 or 6 GHz WLAN OFF)	2450 MHz	Body	0.295
Bluetooth (5 or 6 GHz WLAN ON)	2450 MHz	Body	0.263
Narrowband (2.4 GHz WLAN OFF)	5150-5250 MHz 5725-5850 MHz	Body	0.725
Narrowband (2.4 GHz WLAN ON)	5150-5250 MHz 5725-5850 MHz	Body	0.427
Thread (5 or 6 GHz WLAN OFF)	2450 MHz	Body	0.501*
Thread (5 or 6 GHz WLAN ON)	2450 MHz	Body	0.205*
WLAN	2450 MHz	Body	0.863
WLAN	5200 / 5300 MHz	Body	1.054
WLAN	5500 / 5600 MHz	Body	0.988
WLAN	5800 MHz	Body	1.039
The maximum 1g volume averaged SAR level measured for all the tests performed (including simultaneous transmission analysis results) did not exceed the limits for General Population/Uncontrolled Exposure Partial Body of 1.6 W/kg. *Measured results for Thread were scaled down from 100% duty cycle to 60.96% Refer to Annex D			

Table 5



1.4.2 Simultaneous Transmission

Combinations of Simultaneous Transmission this EUT can achieve are the following:

- 5 or 6 GHz WLAN + 2.4GHz Bluetooth
- 5 or 6 GHz WLAN + 2.4GHz Thread
- 5 or 6 GHz Narrowband + 2.4GHz WLAN

Position	5 or 6GHz WLAN 1g SAR (W/Kg) (Core 0)	2.4GHz Bluetooth 1g SAR (W/Kg) (Core 0)	Sum of 1g SAR (W/Kg)	Peak Location Separation Ratio required?	Peak Location Separation Ratio
Bottom	1.039	0.263	1.302	No	N/A

Table 6

Position	5 or 6GHz WLAN 1g SAR (W/Kg) (Core 0)	2.4GHz Thread 1g SAR (W/kg) (Core 0)	Sum of 1g SAR (W/Kg)	Peak Location Separation Ratio required?	Peak Location Separation Ratio
Bottom	1.039	0.205	1.244	No	N/A

Table 7

Position	Narrowband UNII-3 1g SAR (W/kg) (Core 0)	2.4 GHz WLAN 1g SAR (W/kg) (Core 0)	Sum of 1g SAR (W/Kg)	Peak Location Separation Ratio required?	Peak Location Separation Ratio
Bottom	0.366	0.863	1.229	No	N/A

Table 8



1.4.4 Total Exposure Ratio

5 or 6 GHz WLAN + 2.4GHz Bluetooth

Position	6 GHz WLAN Exposure Ratio iPD Value (Core 1)	Bluetooth Exposure Ratio (Core 1)	Total Exposure Ratio	Total Exposure Ratio less than 1.0
Bottom	0.398	0.137	0.535	Yes

Table 9

5 or 6 GHz WLAN + 2.4GHz Thread

Position	6 GHz WLAN Exposure Ratio iPD Value (Core 1)	Thread Exposure Ratio (Core 1)	Total Exposure Ratio	Total Exposure Ratio less than 1.0
Bottom	0.398	0.110	0.508	Yes

Table 10

Each antenna is separated to the extent that the SAR distributions do not overlap and only same core Simultaneous Transmission is considered.

KDB 447498 D01 - Section 4.3.2: Simultaneous test exclusion is applicable as the sum of 1g SAR of all simultaneously transmitting antennas in an operating mode and exposure condition combination is within the SAR limit or within the Peak Location Separation Ratio.



1.5 TEST RESULTS SUMMARY

1.5.1 Results Summary Tables

Bluetooth - EDR – SISO Core 0 (5 or 6 GHz WLAN OFF) (ePA):
 Specific Absorption Rate (SAR) 1g Results

Test Position	Channel Number	Frequency (MHz)	Measured Average Power (dBm)	Tune Up (dBm)	Measured 1g SAR (W/kg)	Scaled 1g SAR (W/kg)	Scan Figure Number
0mm Rear of Display	39	2441	15.98	16.50	0.090	0.101	-
0mm Bottom	0	2402	15.96	16.50	0.228	0.258	-
0mm Bottom	39	2441	15.98	16.50	0.262	0.295	C.1
0mm Bottom	78	2480	15.85	16.50	0.233	0.271	-
Limit for General Population (Uncontrolled Exposure) 1.6 W/kg (1g)							

Table 11

Bluetooth - EDR - SISO Core 1 (5 or 6 GHz WLAN OFF) (ePA):
 Specific Absorption Rate (SAR) 1g Results

Test Position	Channel Number	Frequency (MHz)	Measured Average Power (dBm)	Tune Up (dBm)	Measured 1g SAR (W/kg)	Scaled 1g SAR (W/kg)	Scan Figure Number
0mm Rear of Display	39	2441	16.22	16.50	0.053	0.057	-
0mm Bottom	0	2402	15.94	16.50	0.157	0.179	-
0mm Bottom	39	2441	16.22	16.50	0.182	0.194	-
0mm Bottom	78	2480	16.05	16.50	0.200	0.222	C.2
Limit for General Population (Uncontrolled Exposure) 1.6 W/kg (1g)							

Table 12



Bluetooth - BDR - SISO Core 2 (5 or 6 GHz WLAN OFF) (iPA):
 Specific Absorption Rate (SAR) 1g Results

Test Position	Channel Number	Frequency (MHz)	Measured Average Power (dBm)	Tune Up (dBm)	Measured 1g SAR (W/kg)	Scaled 1g SAR (W/kg)	Scan Figure Number
0mm Rear of Display	39	2441	11.77	12.00	0.022	0.023	-
0mm Bottom	0	2402	11.71	12.00	0.066	0.071	C.3
0mm Bottom	39	2441	11.77	12.00	0.064	0.067	-
0mm Bottom	78	2480	11.70	12.00	0.064	0.069	-
Limit for General Population (Uncontrolled Exposure) 1.6 W/kg (1g)							

Table 13

Narrowband - UNII-1 - HDR8 - SISO Core 0 (2.4 GHz WLAN OFF) (ePA):
 Body Specific Absorption Rate (SAR) 1g Results

Test Position	Channel Number	Frequency (MHz)	Measured Average Power (dBm)	Tune Up (dBm)	Measured 1g SAR (W/kg)	Scaled 1g SAR (W/kg)	Scan Figure Number
0mm Rear of Display	Bottom	5150	13.92	14.00	0.106	0.108	-
0mm Bottom	Bottom	5150	13.92	14.00	0.323	0.329	-
0mm Bottom	Middle	5200	13.76	14.00	0.442	0.467	-
0mm Bottom	Top	5250	13.66	14.00	0.498	0.539	C.4
Limit for General Population (Uncontrolled Exposure) 1.6 W/kg (1g)							

Table 14



Narrowband - UNII-1 - HDR8 - SISO Core 1 (2.4 GHz WLAN OFF) (ePA):
 Body Specific Absorption Rate (SAR) 1g Results

Test Position	Channel Number	Frequency (MHz)	Measured Average Power (dBm)	Tune Up (dBm)	Measured 1g SAR (W/kg)	Scaled 1g SAR (W/kg)	Scan Figure Number
0mm Rear of Display	Bottom	5150	13.61	14.00	0.255	0.279	-
0mm Bottom	Bottom	5150	13.61	14.00	0.534	0.584	C.5
0mm Bottom	Middle	5200	13.36	14.00	0.391	0.453	-
0mm Bottom	Top	5250	13.57	14.00	0.513	0.566	-
Limit for General Population (Uncontrolled Exposure) 1.6 W/kg (1g)							

Table 15

Narrowband - UNII-3 - HDR4 - SISO Core 0 (2.4 GHz WLAN OFF) (ePA):
 Body Specific Absorption Rate (SAR) 1g Results

Test Position	Channel Number	Frequency (MHz)	Measured Average Power (dBm)	Tune Up (dBm)	Measured 1g SAR (W/kg)	Scaled 1g SAR (W/kg)	Scan Figure Number
0mm Rear of Display	Bottom	5725	14.48	14.50	0.249	0.250	-
0mm Bottom	Bottom	5725	14.48	14.50	0.556	0.559	-
0mm Bottom	Middle	5788	14.41	14.50	0.513	0.524	-
0mm Bottom	Top	5850	14.06	14.50	0.532	0.589	C.6
Limit for General Population (Uncontrolled Exposure) 1.6 W/kg (1g)							

Table 16

Narrowband - UNII-3 - HDR4 - SISO Core 1 (2.4 GHz WLAN OFF) (ePA):
 Body Specific Absorption Rate (SAR) 1g Results

Test Position	Channel Number	Frequency (MHz)	Measured Average Power (dBm)	Tune Up (dBm)	Measured 1g SAR (W/kg)	Scaled 1g SAR (W/kg)	Scan Figure Number
0mm Rear of Display	Top	5850	14.48	14.50	0.437	0.439	-
0mm Bottom	Bottom	5725	14.43	14.50	0.655	0.666	-
0mm Bottom	Middle	5788	14.48	14.50	0.694	0.697	-
0mm Bottom	Top	5850	13.86	14.50	0.626	0.725	C.7
Limit for General Population (Uncontrolled Exposure) 1.6 W/kg (1g)							

Table 17



Bluetooth - EDR - SISO Core 0 (5 or 6 GHz WLAN ON) (ePA):
 Body Specific Absorption Rate (SAR) 1g Results

Test Position	Channel Number	Frequency (MHz)	Measured Average Power (dBm)	Tune Up (dBm)	Measured 1g SAR (W/kg)	Scaled 1g SAR (W/kg)	Scan Figure Number
0mm Rear of Display	39	2441	15.98	16.00	0.090	0.090	-
0mm Bottom	0	2402	15.96	16.00	0.228	0.230	-
0mm Bottom	39	2441	15.98	16.00	0.262	0.263	C.8
0mm Bottom	78	2480	15.85	16.00	0.233	0.241	-
Limit for General Population (Uncontrolled Exposure) 1.6 W/kg (1g)							

Table 18

Bluetooth - BT EDR - SISO Core 1 (5 or 6 GHz WLAN ON) (ePA):
 Body Specific Absorption Rate (SAR) 1g Results

Test Position	Channel Number	Frequency (MHz)	Measured Average Power (dBm)	Tune Up (dBm)	Measured 1g SAR (W/kg)	Scaled 1g SAR (W/kg)	Scan Figure Number
0mm Rear of Display	39	2441	15.56	16.00	0.056	0.062	-
0mm Bottom	0	2402	15.53	16.00	0.123	0.137	-
0mm Bottom	39	2441	15.56	16.00	0.169	0.187	-
0mm Bottom	78	2480	15.38	16.00	0.190	0.219	C.9
Limit for General Population (Uncontrolled Exposure) 1.6 W/kg (1g)							

Table 19



Bluetooth - BT BDR - SISO Core 2 (5 or 6 GHz WLAN ON) (iPA):
 Body Specific Absorption Rate (SAR) 1g Results

Test Position	Channel Number	Frequency (MHz)	Measured Average Power (dBm)	Tune Up (dBm)	Measured 1g SAR (W/kg)	Scaled 1g SAR (W/kg)	Scan Figure Number
0mm Rear of Display	0	2402	11.77	12.00	0.022	0.023	-
0mm Bottom	0	2402	11.77	12.00	0.066	0.071	C.10
0mm Bottom	39	2441	11.71	12.00	0.064	0.067	-
0mm Bottom	78	2480	11.70	12.00	0.064	0.069	-
Limit for General Population (Uncontrolled Exposure) 1.6 W/kg (1g)							

Table 20

Narrowband - UNII-1 - HDR4 - SISO Core 0 (2.4 GHz WLAN ON) (ePA):
 Body Specific Absorption Rate (SAR) 1g Results

Test Position	Channel	Frequency (MHz)	Measured Average Power (dBm)	Tune Up (dBm)	Measured 1g SAR (W/kg)	Scaled 1g SAR (W/kg)	Scan Figure Number
0mm Rear of Display	Bottom	5150	10.99	11.00	0.063	0.063	-
0mm Bottom	Bottom	5150	10.99	11.00	0.184	0.184	-
0mm Bottom	Middle	5200	10.91	11.00	0.266	0.272	-
0mm Bottom	Top	5250	10.81	11.00	0.311	0.325	C.11
Limit for General Population (Uncontrolled Exposure) 1.6 W/kg (1g)							

Table 21



Narrowband - UNII-1 - HDR4 - SISO Core 1 (2.4 GHz WLAN ON) (ePA):
 Body Specific Absorption Rate (SAR) 1g Results

Test Position	Channel	Frequency (MHz)	Measured Average Power (dBm)	Tune Up (dBm)	Measured 1g SAR (W/kg)	Scaled 1g SAR (W/kg)	Scan Figure Number
0mm Rear of Display	Top	5250	10.72	11.00	0.070	0.075	-
0mm Bottom	Bottom	5150	10.52	11.00	0.264	0.295	-
0mm Bottom	Middle	5200	10.56	11.00	0.310	0.343	C.12
0mm Bottom	Top	5250	10.72	11.00	0.319	0.340	-
Limit for General Population (Uncontrolled Exposure) 1.6 W/kg (1g)							

Table 22

Narrowband - UNII-3 - HDR4 - SISO Core 0 (2.4 GHz WLAN ON) (ePA):
 Body Specific Absorption Rate (SAR) 1g Results

Test Position	Channel	Frequency (MHz)	Measured Average Power (dBm)	Tune Up (dBm)	Measured 1g SAR (W/kg)	Scaled 1g SAR (W/kg)	Scan Figure Number
0mm Rear of Display	Top	5850	10.99	11.00	0.120	0.120	-
0mm Bottom	Bottom	5725	10.90	11.00	0.295	0.302	-
0mm Bottom	Middle	5788	10.94	11.00	0.287	0.291	-
0mm Bottom	Top	5850	10.99	11.00	0.365	0.366	C.13
Limit for General Population (Uncontrolled Exposure) 1.6 W/kg (1g)							

Table 23

Narrowband - UNII-3 - HDR4 - SISO Core 1 (2.4 GHz WLAN ON) (ePA):
 Body Specific Absorption Rate (SAR) 1g Results

Test Position	Channel	Frequency (MHz)	Measured Average Power (dBm)	Tune Up (dBm)	Measured 1g SAR (W/kg)	Scaled 1g SAR (W/kg)	Scan Figure Number
0mm Rear of Display	Middle	5788	10.99	11.00	0.164	0.164	-
0mm Bottom	Bottom	5725	10.93	11.00	0.420	0.427	C.14
0mm Bottom	Middle	5788	10.99	11.00	0.413	0.414	-
0mm Bottom	Top	5850	10.75	11.00	0.368	0.390	-
Limit for General Population (Uncontrolled Exposure) 1.6 W/kg (1g)							

Table 24



Thread - SISO Core 0 (5 or 6 GHz WLAN OFF) (ePA):
 Body Specific Absorption Rate (SAR) 1g Results

Test Position	Channel Number	Frequency (MHz)	Measured Average Power (dBm)	Tune Up (dBm)	Measured 1g SAR (W/kg)	Scaled 1g SAR (W/kg)*	Scan Figure Number
0mm Rear of Display	18	2440	19.37	20.00	0.148	0.171	-
0mm Bottom	11	2405	18.97	20.00	0.395	0.501	C.15
0mm Bottom	18	2440	19.37	20.00	0.418	0.483	-
0mm Bottom	26	2480	19.15	20.00	0.375	0.456	-
Limit for General Population (Uncontrolled Exposure) 1.6 W/kg (1g) *Measured results for Thread were scaled down from 100% duty cycle to 60.96%. Refer to Annex D							

Table 25

Thread - SISO Core 1 (5 or 6 GHz WLAN OFF) (ePA):
 Body Specific Absorption Rate (SAR) 1g Results

Test Position	Channel Number	Frequency (MHz)	Measured Average Power (dBm)	Tune Up (dBm)	Measured 1g SAR (W/kg)	Scaled 1g SAR (W/kg)*	Scan Figure Number
0mm Rear of Display	18	2440	19.41	20.00	0.096	0.110	-
0mm Bottom	11	2405	18.51	20.00	0.220	0.310	-
0mm Bottom	18	2440	19.41	20.00	0.277	0.317	-
0mm Bottom	26	2480	18.82	20.00	0.369	0.485	C.16
Limit for General Population (Uncontrolled Exposure) 1.6 W/kg (1g) *Measured results for Thread were scaled down from 100% duty cycle to 60.96%. Refer to Annex D							

Table 26



Thread - SISO Core 2 (5 or 6 GHz WLAN OFF) (iPA):
 Body Specific Absorption Rate (SAR) 1g Results

Test Position	Channel Number	Frequency (MHz)	Measured Average Power (dBm)	Tune Up (dBm)	Measured 1g SAR (W/kg)	Scaled 1g SAR (W/kg)*	Scan Figure Number
0mm Rear of Display	18	2440	11.86	12.50	0.020	0.023	-
0mm Bottom	11	2405	11.85	12.50	0.054	0.062	-
0mm Bottom	18	2440	11.86	12.50	0.060	0.070	C.17
0mm Bottom	26	2480	11.76	12.50	0.054	0.064	-
Limit for General Population (Uncontrolled Exposure) 1.6 W/kg (1g) *Measured results for Thread were scaled down from 100% duty cycle to 60.96%. Refer to Annex D							

Table 27

Thread - SISO Core 0 (5 or 6 GHz WLAN ON) (ePA):
 Body Specific Absorption Rate (SAR) 1g Results

Test Position	Channel Number	Frequency (MHz)	Measured Average Power (dBm)	Tune Up (dBm)	Measured 1g SAR (W/kg)	Scaled 1g SAR (W/kg)*	Scan Figure Number
0mm Rear of Display	18	2440	15.43	16.00	0.055	0.063	-
0mm Bottom	11	2405	15.23	16.00	0.151	0.181	-
0mm Bottom	18	2440	15.43	16.00	0.180	0.205	C.18
0mm Bottom	26	2480	15.18	16.00	0.151	0.182	-
Limit for General Population (Uncontrolled Exposure) 1.6 W/kg (1g) *Measured results for Thread were scaled down from 100% duty cycle to 60.96%. Refer to Annex D							

Table 28



Thread - SISO Core 1 (5 or 6 GHz WLAN ON) (ePA):
 Body Specific Absorption Rate (SAR) 1g Results

Test Position	Channel Number	Frequency (MHz)	Measured Average Power (dBm)	Tune Up (dBm)	Measured 1g SAR (W/kg)	Scaled 1g SAR (W/kg)*	Scan Figure Number
0mm Rear of Display	26	2480	15.27	16.00	0.041	0.049	-
0mm Bottom	11	2405	14.63	16.00	0.085	0.116	-
0mm Bottom	18	2440	15.01	16.00	0.122	0.153	-
0mm Bottom	26	2480	15.27	16.00	0.149	0.176	C.19
Limit for General Population (Uncontrolled Exposure) 1.6 W/kg (1g) *Measured results for Thread were scaled down from 100% duty cycle to 60.96%. Refer to Annex D							

Table 29

Thread - SISO Core 2 (5 or 6 GHz WLAN ON) (iPA):
 Body Specific Absorption Rate (SAR) 1g Results

Test Position	Channel Number	Frequency (MHz)	Measured Average Power (dBm)	Tune Up (dBm)	Measured 1g SAR (W/kg)	Scaled 1g SAR (W/kg)*	Scan Figure Number
0mm Rear of Display	18	2440	11.86	12.50	0.020	0.023	-
0mm Bottom	11	2405	11.85	12.50	0.054	0.062	-
0mm Bottom	18	2440	11.86	12.50	0.060	0.070	C.20
0mm Bottom	26	2480	11.76	12.50	0.054	0.064	-
Limit for General Population (Uncontrolled Exposure) 1.6 W/kg (1g) *Measured results for Thread were scaled down from 100% duty cycle to 60.96%. Refer to Annex D							

Table 30



WLAN - 2.4 GHz - 802.11g OFDM - 20 MHz - 1 Mbps - SISO (Core 0):
 Body Specific Absorption Rate (SAR) 1g Results

Test Position	Channel Number	Frequency (MHz)	Measured Average Power (dBm)	Tune Up (dBm)	Measured 1g SAR (W/kg)	Scaled 1g SAR (W/kg)	Scan Figure Number
0mm Rear of Display	6	2437	19.11	19.50	0.260	0.284	-
0mm Bottom	2	2417	19.04	19.50	0.627	0.697	-
0mm Bottom	6	2437	19.11	19.50	0.713	0.780	-
0mm Bottom	10	2457	18.99	19.50	0.717	0.806	C.21
Limit for General Population (Uncontrolled Exposure) 1.6 W/kg (1g)							

Table 31

WLAN - 2.4 GHz - 802.11g OFDM - 20 MHz - 1 Mbps - SISO (Core 1):
 Body Specific Absorption Rate (SAR) 1g Results

Test Position	Channel Number	Frequency (MHz)	Measured Average Power (dBm)	Tune Up (dBm)	Measured 1g SAR (W/kg)	Scaled 1g SAR (W/kg)	Scan Figure Number
0mm Rear of Display	6	2437	19.60	20.00	0.151	0.166	-
0mm Bottom	2	2417	19.59	20.00	0.438	0.481	-
0mm Bottom	6	2437	19.60	20.00	0.445	0.488	-
0mm Bottom	10	2457	19.50	20.00	0.507	0.569	C.22
Limit for General Population (Uncontrolled Exposure) 1.6 W/kg (1g)							

Table 32

WLAN - 2.4 GHz - 802.11b DSSS - 20 MHz - 1 Mbps - SISO (Core 0):
 Body Specific Absorption Rate (SAR) 1g Results

Test Position	Channel Number	Frequency (MHz)	Measured Average Power (dBm)	Tune Up (dBm)	Measured 1g SAR (W/kg)	Scaled 1g SAR (W/kg)	Scan Figure Number
0mm Rear of Display	11	2462	18.84	19.00	0.277	0.287	-
0mm Bottom	1	2412	18.82	19.00	0.601	0.626	-
0mm Bottom	6	2437	18.58	19.00	0.671	0.739	-
0mm Bottom	11	2462	18.84	19.00	0.726	0.753	C.23
Limit for General Population (Uncontrolled Exposure) 1.6 W/kg (1g)							

Table 33



WLAN - 2.4 GHz - 802.11b DSSS - 20 MHz - 1 Mbps - SISO (Core 1):
 Body Specific Absorption Rate (SAR) 1g Results

Test Position	Channel Number	Frequency (MHz)	Measured Average Power (dBm)	Tune Up (dBm)	Measured 1g SAR (W/kg)	Scaled 1g SAR (W/kg)	Scan Figure Number
0mm Rear of Display	6	2437	18.64	19.00	0.126	0.137	-
0mm Bottom	1	2412	18.50	19.00	0.345	0.387	-
0mm Bottom	6	2437	18.64	19.00	0.383	0.416	-
0mm Bottom	11	2462	18.53	19.00	0.463	0.516	C.24
Limit for General Population (Uncontrolled Exposure) 1.6 W/kg (1g)							

Table 34

WLAN - 2.4 GHz - 802.11n/ac - HT20 - MIMO Core 0 & Core 1:
 Body Specific Absorption Rate (SAR) 1g Results

Test Position	Channel Number	Frequency (MHz)	Measured Average Power (dBm)	Tune Up (dBm)	Measured 1g SAR (W/kg)	Scaled 1g SAR (W/kg)	Scan Figure Number
0mm Rear of Display (Core 0)	10	2457	18.96	19.50	0.261	0.296	-
0mm Rear of Display (Core 1)	10	2457	19.58	20.00	0.168	0.185	
0mm Bottom (Core 0)	2	2417	18.94	19.50	0.636	0.724	-
0mm Bottom (Core 1)	2	2417	19.28	20.00	0.433	0.511	
0mm Bottom (Core 0)	6	2437	18.81	19.50	0.712	0.835	-
0mm Bottom (Core 1)	6	2437	19.52	20.00	0.473	0.528	
0mm Bottom (Core 0)	10	2457	18.96	19.50	0.762	0.863	C.25
0mm Bottom (Core 1)	10	2457	19.58	20.00	0.544	0.599	
Limit for General Population (Uncontrolled Exposure) 1.6 W/kg (1g)							

Table 35



WLAN - U-NII-1 - 802.11ac – VHT80 - SISO Core 0
 Body Specific Absorption Rate (SAR) 1g Results

Test Position	Channel Number	Frequency (MHz)	Measured Average Power (dBm)	Tune Up (dBm)	Measured 1g SAR (W/kg)	Scaled 1g SAR (W/kg)	Scan Figure Number
0mm Rear of Display	42	5210	14.39	14.75	0.204	0.222	-
0mm Bottom	42	5210	14.39	14.75	0.716	0.778	C.26
Limit for General Population (Uncontrolled Exposure) 1.6 W/kg (1g)							

Table 36

WLAN - U-NII-1 - 802.11ac – VHT80 - SISO Core 1
 Body Specific Absorption Rate (SAR) 1g Results

Test Position	Channel Number	Frequency (MHz)	Measured Average Power (dBm)	Tune Up (dBm)	Measured 1g SAR (W/kg)	Scaled 1g SAR (W/kg)	Scan Figure Number
0mm Rear of Display	42	5210	13.82	14.50	0.311	0.364	-
0mm Bottom	42	5210	13.82	14.50	0.734	0.858	C.27
Limit for General Population (Uncontrolled Exposure) 1.6 W/kg (1g)							

Table 37



WLAN - U-NII-1 - 802.11n/ac - HT40 - MIMO Core 0 & Core 1
 Body Specific Absorption Rate (SAR) 1g Results

Test Position	Channel Number	Frequency (MHz)	Measured Average Power (dBm)	Tune Up (dBm)	Measured 1g SAR (W/kg)	Scaled 1g SAR (W/kg)	Scan Figure Number
0mm Rear of Display (Core 0)	46	5230	14.06	14.75	0.214	0.251	-
0mm Rear of Display (Core 1)	46	5230	14.07	14.50	0.225	0.248	
0mm Bottom (Core 0)	38	5190	13.83	14.75	0.614	0.759	-
0mm Bottom (Core 1)	38	5190	13.90	14.50	0.771	0.885	
0mm Bottom (Core 0)	46	5230	14.06	14.75	0.730	0.856	C.28
0mm Bottom (Core 1)	46	5230	14.07	14.50	0.816	0.901	
Limit for General Population (Uncontrolled Exposure) 1.6 W/kg (1g)							

Table 38

WLAN - U-NII-2A - 802.11ac – VHT80 - SISO Core 0
 Body Specific Absorption Rate (SAR) 1g Results

Test Position	Channel Number	Frequency (MHz)	Measured Average Power (dBm)	Tune Up (dBm)	Measured 1g SAR (W/kg)	Scaled 1g SAR (W/kg)	Scan Figure Number
0mm Rear of Display	58	5290	13.34	13.75	0.216	0.237	-
0mm Bottom	58	5290	13.34	13.75	0.697	0.766	C.29
Limit for General Population (Uncontrolled Exposure) 1.6 W/kg (1g)							

Table 39



WLAN - U-NII-2A - 802.11ac – VHT80 - SISO Core 1
 Body Specific Absorption Rate (SAR) 1g Results

Test Position	Channel Number	Frequency (MHz)	Measured Average Power (dBm)	Tune Up (dBm)	Measured 1g SAR (W/kg)	Scaled 1g SAR (W/kg)	Scan Figure Number
0mm Rear of Display	54	5270	13.89	14.50	0.399	0.459	-
0mm Bottom	54	5270	13.89	14.50	0.822	0.946	C.30
0mm Bottom	62	5310	14.13	14.50	0.890	0.969	-
Limit for General Population (Uncontrolled Exposure) 1.6 W/kg (1g)							

Table 40

WLAN - U-NII-2A - 802.11n/ac – VHT40 - MIMO Core 0 & Core 1
 Body Specific Absorption Rate (SAR) 1g Results

Test Position	Channel Number	Frequency (MHz)	Measured Average Power (dBm)	Tune Up (dBm)	Measured 1g SAR (W/kg)	Scaled 1g SAR (W/kg)	Scan Figure Number
0mm Rear of Display (Core 0)	54	5270	12.93	13.75	0.237	0.286	-
0mm Rear of Display (Core 1)	54	5270	13.45	14.50	0.378	0.481	
0mm Bottom (Core 0)	54	5270	12.93	13.75	0.655	0.791	C.31
0mm Bottom (Core 1)	54	5270	13.45	14.50	0.828	1.054	
0mm Bottom (Core 0)	62	5310	13.15	13.75	0.688	0.790	-
0mm Bottom (Core 1)	62	5310	13.39	14.50	0.794	1.025	
Limit for General Population (Uncontrolled Exposure) 1.6 W/kg (1g)							

Table 41



WLAN - U-NII-2C - 802.11ac - VHT80 - SISO Core 0
 Body Specific Absorption Rate (SAR) 1g Results

Test Position	Channel Number	Frequency (MHz)	Measured Average Power (dBm)	Tune Up (dBm)	Measured 1g SAR (W/kg)	Scaled 1g SAR (W/kg)	Scan Figure Number
0mm Rear of Display	106	5530	14.13	14.50	0.329	0.358	-
0mm Bottom	106	5530	14.13	14.50	0.853	0.929	C.32
0mm Bottom	122	5610	14.12	14.50	0.742	0.810	-
0mm Bottom	138	5690	14.14	14.50	0.763	0.829	-
Limit for General Population (Uncontrolled Exposure) 1.6 W/kg (1g)							

Table 42

WLAN - U-NII-2C - 802.11ac - VHT80 - SISO Core 1
 Body Specific Absorption Rate (SAR) 1g Results

Test Position	Channel Number	Frequency (MHz)	Measured Average Power (dBm)	Tune Up (dBm)	Measured 1g SAR (W/kg)	Scaled 1g SAR (W/kg)	Scan Figure Number
0mm Rear of Display	106	5530	12.87	13.75	0.331	0.405	-
0mm Bottom	106	5530	12.87	13.75	0.754	0.923	C.33
0mm Bottom	122	5610	13.36	13.75	0.823	0.900	-
0mm Bottom	138	5690	13.03	13.75	0.780	0.921	-
Limit for General Population (Uncontrolled Exposure) 1.6 W/kg (1g)							

Table 43



WLAN - U-NII-2C - 802.11n/ac - HT40 / VHT80 - MIMO Core 0 & Core 1
 Body Specific Absorption Rate (SAR) 1g Results

Test Position	Channel Number	Frequency (MHz)	Measured Average Power (dBm)	Tune Up (dBm)	Measured 1g SAR (W/kg)	Scaled 1g SAR (W/kg)	Scan Figure Number
0mm Rear of Display (Core 0)	122	5610	13.60	14.50	0.261	0.321	-
0mm Rear of Display (Core 1)	122	5610	13.46	13.75	0.359	0.384	
0mm Bottom (Core 0)	102	5510	13.37	14.50	0.688	0.892	-
0mm Bottom (Core 1)	102	5510	13.40	13.75	0.750	0.813	
0mm Bottom (Core 0)	110	5550	13.35	14.50	0.626	0.816	-
0mm Bottom (Core 1)	110	5550	13.38	13.75	0.812	0.884	
0mm Bottom (Core 0)	122	5610	13.60	14.50	0.663	0.816	C.34
0mm Bottom (Core 1)	122	5610	13.46	13.75	0.924	0.988	
0mm Bottom (Core 0)	138	5690	13.45	14.50	0.589	0.750	-
0mm Bottom (Core 1)	138	5690	13.27	13.75	0.850	0.949	
Limit for General Population (Uncontrolled Exposure) 1.6 W/kg (1g)							

Table 44

WLAN - U-NII-3 - 802.11ac - VHT80 - SISO Core 0
 Body Specific Absorption Rate (SAR) 1g Results

Test Position	Channel Number	Frequency (MHz)	Measured Average Power (dBm)	Tune Up (dBm)	Measured 1g SAR (W/kg)	Scaled 1g SAR (W/kg)	Scan Figure Number
0mm Rear of Display	155	5775	14.25	14.75	0.252	0.283	-
0mm Bottom	155	5775	14.25	14.75	0.652	0.732	C.35
Limit for General Population (Uncontrolled Exposure) 1.6 W/kg (1g)							

Table 45



WLAN - U-NII-3 - 802.11ac - VHT80 - SISO Core 1
 Body Specific Absorption Rate (SAR) 1g Results

Test Position	Channel Number	Frequency (MHz)	Measured Average Power (dBm)	Tune Up (dBm)	Measured 1g SAR (W/kg)	Scaled 1g SAR (W/kg)	Scan Figure Number
0mm Rear of Display	155	5775	12.91	14.00	0.344	0.442	-
0mm Bottom	155	5775	12.91	14.00	0.713	0.916	C.36
Limit for General Population (Uncontrolled Exposure) 1.6 W/kg (1g)							

Table 46

WLAN - U-NII-3 - 802.11ac - VHT80 - MIMO Core 0 & Core 1
 Body Specific Absorption Rate (SAR) 1g Results

Test Position	Channel Number	Frequency (MHz)	Measured Average Power (dBm)	Tune Up (dBm)	Measured 1g SAR (W/kg)	Scaled 1g SAR (W/kg)	Scan Figure Number
0mm Rear of Display (Core 0)	155	5775	13.75	14.75	0.410	0.516	-
0mm Rear of Display (Core 1)	155	5775	13.54	14.00	0.250	0.278	
0mm Bottom (Core 0)	155	5775	13.75	14.75	0.825	1.039	C.37
0mm Bottom (Core 1)	155	5775	13.54	14.00	0.658	0.732	
Limit for General Population (Uncontrolled Exposure) 1.6 W/kg (1g)							

Table 47



WLAN - 6 GHz 802.11ax – HE80/160 - SISO Core 0
 Body Absorbed Power Density (APD) 1g Results

Test Position	Channel Number	Frequency (MHz)	Measured Average Power (dBm)	Tune Up (dBm)	Measured APD 4cm ² (W/m ²)	Scaled APD 4cm ² (W/m ²)	Scan Figure Number
0mm Rear of Display	79	6345	13.11	13.25	1.460	1.508	-
0mm Bottom	15	6025*	12.45	12.75	3.400	3.643	-
0mm Bottom	47	6185	13.05	13.25	3.680	3.853	C.38
0mm Bottom	79	6345	13.11	13.25	3.680	3.801	-
0mm Bottom	143	6665	11.56	11.75	3.500	3.657	-
0mm Bottom	167	6785	11.40	12.00	3.120	3.582	-

The APD values above do not have a regulatory limit. They are provided in line with FCC procedures to derive the maximum iPD test position.
 * Limit for General Population (Uncontrolled Exposure) 1.6 W/kg (1g)

Table 48

WLAN - 6 GHz 802.11ax – HE80/160 - SISO Core 0
 Body Specific Absorption Rate (SAR) 1g Results

Test Position	Channel Number	Frequency (MHz)	Measured Average Power (dBm)	Tune Up (dBm)	Measured 1g SAR (W/kg)	Scaled 1g SAR (W/kg)	Scan Figure Number
0mm Rear of Display	79	6345	13.11	13.25	0.197	0.203	-
0mm Bottom	15	6025*	12.45	12.75	0.460	0.493	C.39
0mm Bottom	47	6185	13.05	13.25	0.494	0.517	-
0mm Bottom	79	6345	13.11	13.25	0.501	0.517	-
0mm Bottom	143	6665	11.56	11.75	0.488	0.510	-
0mm Bottom	167	6785	11.40	12.00	0.432	0.496	-

The APD values above do not have a regulatory limit. They are provided in line with FCC procedures to derive the maximum iPD test position.
 * Limit for General Population (Uncontrolled Exposure) 1.6 W/kg (1g)

Table 49



WLAN - 6 GHz 802.11ax - HE80/160 - SISO Core 1
 Body Absorbed Power Density (APD) 1g Results

Test Position	Channel Number	Frequency (MHz)	Measured Average Power (dBm)	Tune Up (dBm)	Measured APD 4cm ² (W/m ²)	Scaled APD 4cm ² (W/m ²)	Scan Figure Number
0mm Rear of Display	167	6785	13.10	13.75	1.600	1.858	-
0mm Bottom	15	6025*	11.35	11.75	3.360	3.684	-
0mm Bottom	47	6185	11.92	12.25	3.680	3.971	-
0mm Bottom	79	6345	12.15	12.25	3.120	3.193	-
0mm Bottom	143	6665	12.88	13.00	3.880	3.989	C.40
0mm Bottom	167	6785	13.10	13.75	2.940	3.415	-

The APD values above do not have a regulatory limit. They are provided in line with FCC procedures to derive the maximum iPD test position.
 * Limit for General Population (Uncontrolled Exposure) 1.6 W/kg (1g)

Table 50

WLAN - 6 GHz 802.11ax - HE80/160 - SISO Core 1
 Body Specific Absorption Rate (SAR) 1g Results

Test Position	Channel Number	Frequency (MHz)	Measured Average Power (dBm)	Tune Up (dBm)	Measured 1g SAR (W/kg)	Scaled 1g SAR (W/kg)	Scan Figure Number
0mm Rear of Display	167	6785	13.10	13.75	0.210	0.244	-
0mm Bottom	15	6025*	11.35	11.75	0.420	0.461	C.41
0mm Bottom	47	6185	11.92	12.25	0.441	0.476	-
0mm Bottom	79	6345	12.15	12.25	0.380	0.389	-
0mm Bottom	143	6665	12.88	13.00	0.456	0.469	-
0mm Bottom	167	6785	13.10	13.75	0.346	0.402	-

The APD values above do not have a regulatory limit. They are provided in line with FCC procedures to derive the maximum iPD test position.
 * Limit for General Population (Uncontrolled Exposure) 1.6 W/kg (1g)

Table 51



WLAN - 6 GHz - 802.11ax - HE80/160 - MIMO Core 0 & Core 1
 Body Absorbed Power Density (APD) 1g Results

Test Position	Channel Number	Frequency (MHz)	Measured Average Power (dBm)	Tune Up (dBm)	Measured APD 4cm ² (W/m ²)	Scaled APD 4cm ² (W/m ²)	Scan Figure Number
0mm Rear of Display (Core 0)	47	6185	12.97	13.25	1.240	1.323	-
0mm Rear of Display (Core 1)	47	6185	12.12	12.25	1.880	1.937	
0mm Bottom (Core 0)	15	6025*	11.40	12.75	2.620	3.575	-
0mm Bottom (Core 1)	15	6025*	11.48	11.75	3.620	3.852	
0mm Bottom (Core 0)	47	6185	12.97	13.25	2.740	2.922	-
0mm Bottom (Core 1)	47	6185	12.12	12.25	3.020	3.112	
0mm Bottom (Core 0)	79	6345	12.87	13.25	3.540	3.864	-
0mm Bottom (Core 1)	79	6345	11.92	12.25	2.920	3.151	
0mm Bottom (Core 0)	143	6665	11.65	11.75	3.700	3.786	C.40
0mm Bottom (Core 1)	143	6665	11.68	13.00	2.900	3.930	
0mm Bottom (Core 0)	167	6785	11.50	12.00	3.120	3.501	-
0mm Bottom (Core 1)	167	6785	12.95	13.75	2.620	3.150	
The APD values above do not have a regulatory limit. They are provided in line with FCC procedures to derive the maximum iPD test position. * Limit for General Population (Uncontrolled Exposure) 1.6 W/kg (1g)							

Table 52



WLAN - 6 GHz - 802.11ax - HE80/160 - MIMO Core 0 & Core 1
 Body Specific Absorption Rate (SAR) 1g Results

Test Position	Channel Number	Frequency (MHz)	Measured Average Power (dBm)	Tune Up (dBm)	Measured 1g SAR (W/kg)	Scaled 1g SAR (W/kg)	Scan Figure Number
0mm Rear of Display (Core 0)	47	6185	12.97	13.25	0.163	0.174	-
0mm Rear of Display (Core 1)	47	6185	12.12	12.25	0.230	0.237	
0mm Bottom (Core 0)	15	6025	11.40	12.75	0.354	0.483	C.42
0mm Bottom (Core 1)	15	6025	11.48	11.75	0.447	0.476	
0mm Bottom (Core 0)	47	6185	12.97	13.25	0.372	0.397	-
0mm Bottom (Core 1)	47	6185	12.12	12.25	0.361	0.372	
0mm Bottom (Core 0)	79	6345	12.87	13.25	0.484	0.528	-
0mm Bottom (Core 1)	79	6345	11.92	12.25	0.340	0.367	
0mm Bottom (Core 0)	143	6665	11.65	11.75	0.510	0.522	-
0mm Bottom (Core 1)	143	6665	11.68	13.00	0.341	0.462	
0mm Bottom (Core 0)	167	6785	11.50	12.00	0.427	0.479	-
0mm Bottom (Core 1)	167	6785	12.95	13.75	0.313	0.376	
Limit for General Population (Uncontrolled Exposure) 1.6 W/kg (1g)							

Table 53

6 GHz - 802.11ax - HE160 - MCS0 - Core 1
 Incident Power Density (iPD) 4cm² Results

Test Position	Channel Number	Frequency (MHz)	Measured iPD 4cm ² (W/m ²)	Standalone iPD limit (W/m ²)	Exposure Ratio	Scan Figure Number
0mm Bottom	143	6665	3.98	10.00	0.398	C.43

Table 54



1.5.2 Technical Description

The equipment under test (EUT) was a portable laptop computer.

1.5.3 Interim Procedures for FCC Radio Frequency Exposure Evaluations

The interim procedure for FCC Radio Frequency (RF) exposure evaluations of U-NII 6-7 GHz band portable devices have been made available during the TCB workshop in October 2020. The procedure is summarized below:

- Evaluate SAR / APD with DASY Module SAR V16.0 or higher. The configurations to be tested are defined in the relevant Knowledge Database (KDB). The peak spatial averaged SAR (psSAR) and the peak spatial averaged absorbed Power Density (psAPD) are reported.
- For the configuration with the highest SAR / APD, evaluate the PD with DASY Module mmWave V3.0 or higher.

1.5.4 Test Configuration and Modes of Operation

The testing was performed with an integral battery supplied and manufactured by Apple Inc.

Supported technologies are Bluetooth (EDR/BDR/LE/HDR), 2.4 GHz Thread, 5 GHz Narrowband, 2.4 GHz WLAN (802.11b/g/n/ax), 5 GHz WLAN (802.11a/n/ac/ax) and 6 GHz WLAN (802.11a/ax).

2x2 MIMO is supported for WLAN.

Where the device supports Low Power (LP) and Standard Power (SP) in a relevant frequency band of operation, the Standard Power option was always selected. This resulted in the highest output power always being selected where a choice is available.

For each scan, the device was configured into a continuous transmission test mode at a maximum power defined by the customer.

Testing was performed in each position at the frequency that gave the highest output power for each band.

Conducted power measurements were performed on a modified device (accessible conducted port) and the measured SAR results were power scaled to the maximum declared tune-up level.

For each antenna, the bottom surface, and the rear of the EUT display were assessed for SAR.

For the 6 GHz frequency bands the transmission mode used for testing was determined by the 802.11 configuration with the highest declared output power in each frequency band. Where multiple 802.11 configurations have the same specified output power, testing was performed using the mode with the largest channel bandwidth with the lowest order modulation and lowest data rate.

For SAR assessment, the relevant surfaces of the device were placed against an Elliptical phantom with a 0mm separation distance.

The Elliptical Flat Phantom dimensions are 600mm major axis and 400mm minor axis with a shell thickness of 2mm. The phantom was filled to a minimum depth of 150mm with the appropriate liquid. The dielectric properties were in accordance with the requirements specified in KDB 865665.

Included in this report are descriptions of the test method; the equipment used and an analysis of the test uncertainties applicable and diagrams indicating the locations of maximum SAR, APD and iPD for each relevant test position.

1.5.5 Antenna Location Diagram

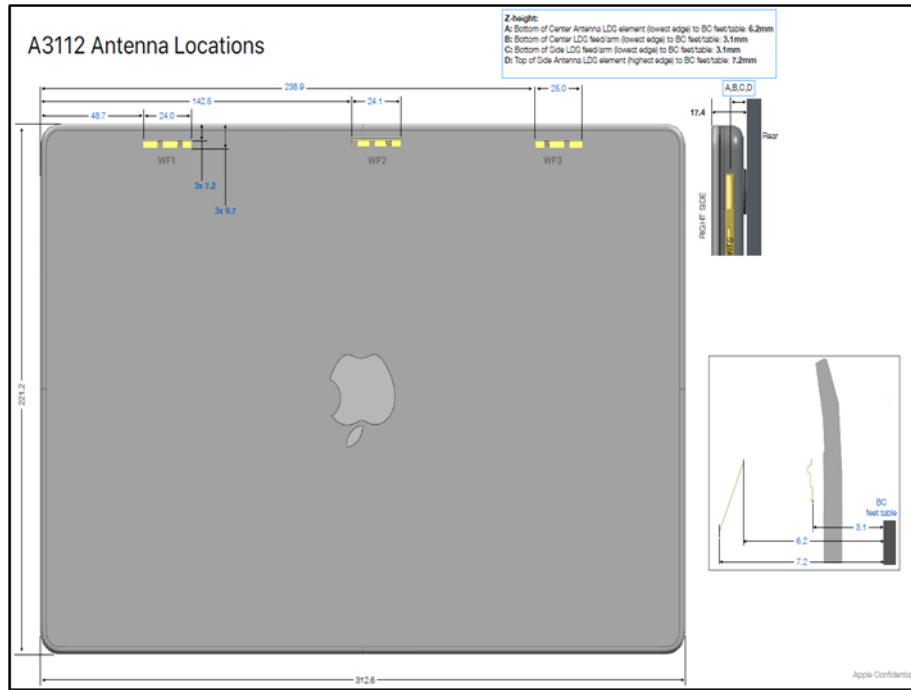

Figure 1

1.5.6 Deviations from Standard

Initially, area scans were completed covering the whole of the bottom surface of the EUT to determine that there were no other RF radiators (unintentional) other than the antennas. The actual SAR measurements were completed using smaller area scans covering the antenna locations only.

2.4 GHz

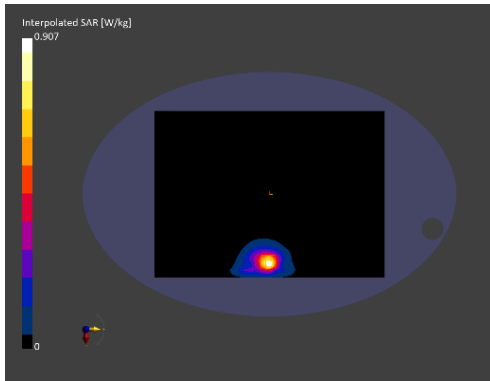

Figure 2 - (Core 0)

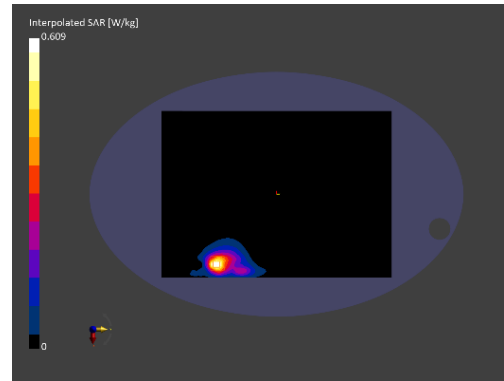

Figure 3 - (Core 1)

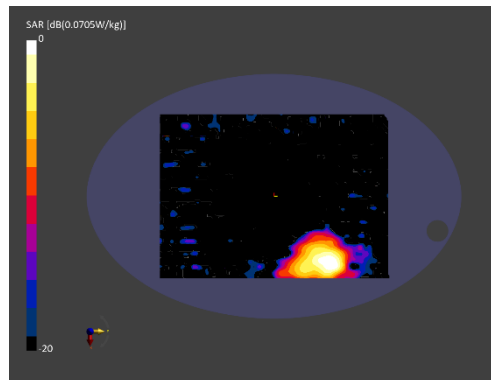

Figure 4 - (Core 2)

5 GHz

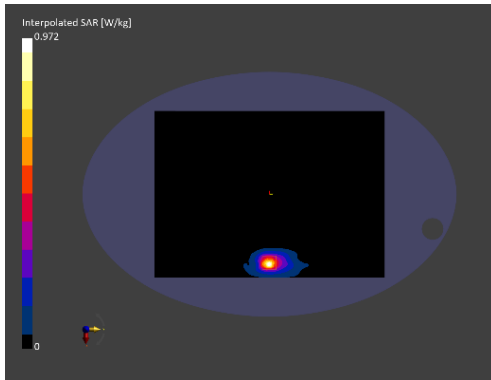

Figure 5 - (Core 0)

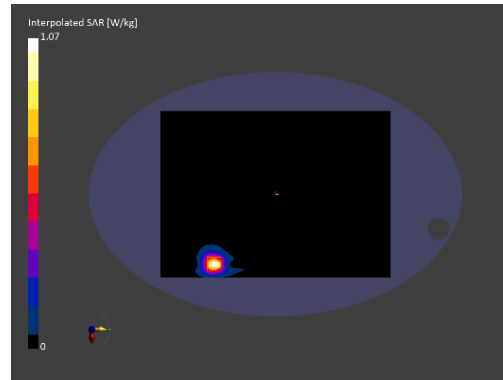

Figure 6 - (Core 1)

6 GHz

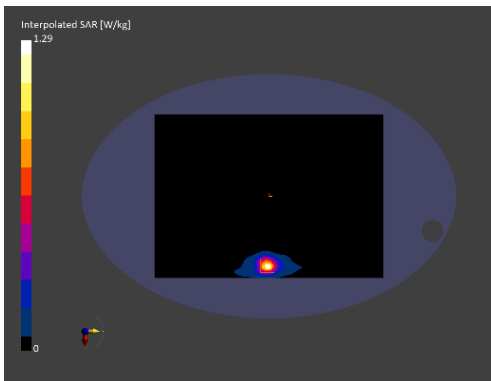

Figure 7 - (Core 0)

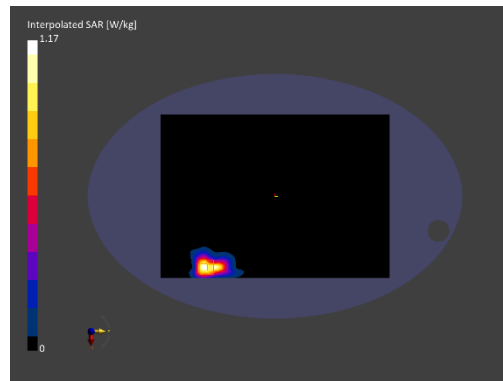

Figure 8 - (Core 1)



1.6 POWER TABLES (TUNE UP VALUES)

Note: All values in dBm
 NS= Not Supported

2.4 GHz Bluetooth 5 GHz OFF

BT Core	PA	Channel	BDR	EDR	LE	HDR4	HDR8
0	iPA	All	13.0	9.5	7.5	6.5	6.5
0	ePA		NS	16.5	15.5	14.5	13.0
1	iPA		13.0	9.5	7.5	6.5	6.5
1	ePA		NS	16.5	16.0	14.5	13.0
2	iPA		12.0	9.5	7.5	6.5	6.5

Table 55

2.4 GHz Bluetooth 5 GHz OFF - TXBF

BT Core	PA	Channel	BDR TXBF	EDR TXBF	LE TXBF	HDR4 TXBF	HDR8 TXBF
0	iPA	All	13.0	9.5	7.5	6.5	6.5
0	ePA		NS	13.5	15.5	14.5	13.0
1	iPA		13.0	9.5	7.5	6.5	6.5
1	ePA		NS	13.5	16.0	14.5	13.0
2	iPA		NS	NS	NS	NS	NS

Table 56

2.4 GHz Bluetooth 5 GHz ON

BT Core	PA	Channel	BDR	EDR	LE	HDR4	HDR8
0	iPA	All	13.0	9.5	7.5	6.5	6.5
0	ePA		NS	16.0	15.5	14.5	13.0
1	iPA		13.0	9.5	7.5	6.5	6.5
1	ePA		NS	16.0	16.0	14.5	13.0
2	iPA		12.0	9.5	7.5	6.5	6.5

Table 57

2.4 GHz Bluetooth 5 GHz ON - TXBF

BT Core	PA	Channel	BDR TXBF	EDR TXBF	LE TXBF	HDR4 TXBF	HDR8 TXBF
0	iPA	All	13.0	9.5	7.5	6.5	6.5
0	ePA		NS	13.5	15.5	14.5	13.0
1	iPA		13.0	9.5	7.5	6.5	6.5
1	ePA		NS	13.5	16.0	14.5	13.0
2	iPA		NS	NS	NS	NS	NS

Table 58



Narrowband UNII-1 - When 2.4 GHz WLAN OFF

NB Core	PA	Channel	BDR	HDR4	HDR8	BDR TXBF	HDR4 TXBF	HDR8 TXBF
0	iPA	All	10.0	4.0	4.0	4.0	4.0	4.0
0	ePA		NS	12.0	14.0	NS	6.0	8.0
1	iPA		10.0	4.0	4.0	4.0	4.0	4.0
1	ePA		NS	12.0	14.0	NS	6.0	8.0

Table 59

Narrowband UNII-1 - When 2.4 GHz WLAN ON

NB Core	PA	Channel	BDR	HDR4	HDR8	BDR TXBF	HDR4 TXBF	HDR8 TXBF
0	iPA	All	10.0	4.0	4.0	4.0	4.0	4.0
0	ePA		NS	11.0	11.0	NS	6.0	8.0
1	iPA		10.0	4.0	4.0	4.0	4.0	4.0
1	ePA		NS	11.0	11.0	NS	6.0	8.0

Table 60

Narrowband UNII-3 - When 2.4 GHz WLAN OFF

NB Core	PA	Channel	BDR	HDR4	HDR8	BDR TXBF	HDR4 TXBF	HDR8 TXBF
0	iPA	All	10.5	4.0	4.0	10.5	4.0	4.0
0	ePA		NS	14.5	14.5	NS	14.5	14.5
1	iPA		10.5	4.0	4.0	10.5	4.0	4.0
1	ePA		NS	14.5	14.5	NS	14.5	14.5

Table 61

Narrowband UNII-3 - When 2.4 GHz WLAN ON

NB Core	PA	Channel	BDR	HDR4	HDR8	BDR TXBF	HDR4 TXBF	HDR8 TXBF
0	iPA	All	10.5	4.0	4.0	10.5	4.0	4.0
0	ePA		NS	11.0	11.0	NS	11.0	11.0
1	iPA		10.5	4.0	4.0	10.5	4.0	4.0
1	ePA		NS	11.0	11.0	NS	11.0	11.0

Table 62



2.4 GHz Thread - When 5 GHz OFF

Core	PA	Channel	Thread (dBm)
0	iPA	All	13.0
0	ePA		20.0
1	iPA		13.0
1	ePA		20.0
2	iPA		12.5
2	ePA		NS

Table 63

2.4 GHz Thread - When 5 GHz ON

Core	PA	Channel	Thread (dBm)
0	iPA	All	13.0
0	ePA		16.0
1	iPA		13.0
1	ePA		16.0
2	iPA		12.5
2	ePA		NS

Table 64

2.4 GHz WLAN SISO Core 0

Channel	Frequency (MHz)	b (SISO)	g (SISO) Low Rate	11n/11ac HT20 (SISO) Low Rate	11ax/be HE20 (SISO) Low Rate	11ax HE20 RU106 (SISO)	11ax HE20 RU52 (SISO)	11ax HE20 RU26 (SISO)
1	2412	19.00	17.50	16.00	15.50	18.50	17.50	14.50
2	2417	19.00	19.50	19.50	19.50	19.50	17.50	14.50
3	2422	19.00	19.50	19.50	19.50	19.50	17.50	14.50
4	2427	19.00	19.50	19.50	19.50	19.50	17.50	14.50
5	2432	19.00	19.50	19.50	19.50	19.50	17.50	14.50
6	2437	19.00	19.50	19.50	19.50	19.50	17.50	14.50
7	2442	19.00	19.50	19.50	19.50	19.50	17.50	14.50
8	2447	19.00	19.50	19.50	19.50	19.50	17.50	14.50
9	2452	19.00	19.50	19.50	19.50	19.50	17.50	14.50
10	2457	19.00	19.50	19.50	19.50	19.50	17.50	14.50
11	2462	19.00	18.00	18.50	17.00	19.00	17.50	14.50
12	2467	17.25	15.50	16.00	14.25	16.00	17.50	14.50
13	2472	15.00	7.50	7.25	7.75	-1.25	-2.00	-4.00

Table 65



2.4 GHz WLAN SISO Core 1

Channel	Frequency (MHz)	b (SISO)	g (SISO) Low Rate	11n/11ac HT20 (SISO) Low Rate	11ax/be HE20 (SISO) Low Rate	11ax HE20 RU106 (SISO)	11ax HE20 RU52 (SISO)	11ax HE20 RU26 (SISO)
1	2412	19.00	17.50	16.00	15.50	18.50	17.50	14.50
2	2417	19.00	20.00	20.00	19.50	20.00	17.50	14.50
3	2422	19.00	20.00	20.00	20.00	20.00	17.50	14.50
4	2427	19.00	20.00	20.00	20.00	20.00	17.50	14.50
5	2432	19.00	20.00	20.00	20.00	20.00	17.50	14.50
6	2437	19.00	20.00	20.00	20.00	20.00	17.50	14.50
7	2442	19.00	20.00	20.00	20.00	20.00	17.50	14.50
8	2447	19.00	20.00	20.00	20.00	20.00	17.50	14.50
9	2452	19.00	20.00	20.00	20.00	20.00	17.50	14.50
10	2457	19.00	20.00	20.00	20.00	19.50	17.50	14.50
11	2462	19.00	18.00	18.50	17.00	19.00	17.50	14.50
12	2467	17.25	15.50	16.00	14.25	16.00	17.50	14.50
13	2472	15.00	7.50	7.25	7.75	-1.25	-2.00	-4.00

Table 66

2.4 GHz WLAN MIMO Core 0

Channel	Frequency (MHz)	11n/11ac HT20 (2Tx, non TxBF) Low Rate	11ax/11be HE20 (2Tx, non TxBF) Low Rate	11ax/11be HE20 RU106 (2Tx, non TxBF)	11ax/11be HE20 RU52 (2Tx, non TxBF)	11ax/11be HE20 RU26 (2Tx, non TxBF)
1	2412	16.00	15.00	19.00	17.50	14.50
2	2417	19.50	19.00	19.50	17.50	14.50
3	2422	19.50	19.50	19.50	17.50	14.50
4	2427	19.50	19.50	19.50	17.50	14.50
5	2432	19.50	19.50	19.50	17.50	14.50
6	2437	19.50	19.50	19.50	17.50	14.50
7	2442	19.50	19.50	19.50	17.50	14.50
8	2447	19.50	19.50	19.50	17.50	14.50
9	2452	19.50	19.50	19.50	17.50	14.50
10	2457	19.50	19.00	19.50	17.50	14.50
11	2462	16.50	15.50	18.25	17.50	14.50
12	2467	14.00	12.75	14.00	16.00	14.50
13	2472	6.00	6.00	-1.00	-3.50	-7.00

Table 67



2.4 GHz WLAN MIMO Core 1

Channel	Frequency (MHz)	11n/11ac HT20 (2Tx, non TxBF) Low Rate	11ax HE20 (2Tx, non TxBF) Low Rate	11ax HE20 RU106 (2Tx, non TxBF)	11ax HE20 RU52 (2Tx, non TxBF)	11ax HE20 RU26 (2Tx, non TxBF)
1	2412	16.00	15.00	19.00	17.50	14.50
2	2417	20.00	19.00	20.00	17.50	14.50
3	2422	20.00	20.00	20.00	17.50	14.50
4	2427	20.00	20.00	20.00	17.50	14.50
5	2432	20.00	20.00	20.00	17.50	14.50
6	2437	20.00	20.00	20.00	17.50	14.50
7	2442	20.00	20.00	20.00	17.50	14.50
8	2447	20.00	20.00	20.00	17.50	14.50
9	2452	20.00	20.00	20.00	17.50	14.50
10	2457	20.00	19.00	20.00	17.50	14.50
11	2462	16.50	15.50	18.25	17.50	14.50
12	2467	14.00	12.75	14.00	16.00	14.50
13	2472	6.00	6.00	-1.00	-3.50	-7.00

Table 68



5 GHz WLAN - 20 MHz BW - SISO Core 0

Channel	Frequency (MHz)	a (SISO) Low Rate	11n/11ac HT20 (SISO) Low Rate	11ax/11be HE20 (SISO) Low Rate	11ax/11be HE20 RU106 (SISO)	11ax/11be HE20 RU52 (SISO)	11ax/11be HE20 RU26 (SISO)
36	5180	14.75	14.75	14.75	14.75	14.50	11.50
40	5200	14.75	14.75	14.75	14.75	14.50	11.50
44	5220	14.75	14.75	14.75	14.75	14.50	11.50
48	5240	14.75	14.75	14.75	14.75	14.50	11.50
52	5260	13.75	13.75	13.75	13.75	13.25	NS
56	5280	13.75	13.75	13.75	13.75	13.25	NS
60	5300	13.75	13.75	13.75	13.75	13.25	NS
64	5320	13.75	13.75	13.75	13.75	13.25	NS
100	5500	14.50	14.50	14.50	14.50	14.00	NS
104	5520	14.50	14.50	14.50	14.50	14.50	NS
108	5540	14.50	14.50	14.50	14.50	14.50	NS
112	5560	14.50	14.50	14.50	14.50	14.50	NS
116	5580	14.50	14.50	14.50	14.50	14.50	NS
120	5600	14.50	14.50	14.50	14.50	14.50	NS
124	5620	14.50	14.50	14.50	14.50	14.50	NS
128	5640	14.50	14.50	14.50	14.50	14.50	NS
132	5660	14.50	14.50	14.50	14.50	14.50	NS
136	5680	14.50	14.50	14.50	14.50	14.50	NS
140	5700	14.50	14.50	14.50	14.50	9.00	NS
144	5720	14.50	14.50	14.50	14.50	14.50	NS
149	5745	14.75	14.75	14.75	14.75	14.75	13.50
153	5765	14.75	14.75	14.75	14.75	14.75	13.50
157	5785	14.75	14.75	14.75	14.75	14.75	13.50
161	5805	14.75	14.75	14.75	14.75	14.75	13.50
165	5825	14.75	14.75	14.75	14.75	14.75	13.50

Table 69



5 GHz WLAN - 20 MHz BW - SISO Core 1

Channel	Frequency (MHz)	a (SISO) Low Rate	11n/11ac HT20 (SISO) Low Rate	11ax/11be HE20 (SISO) Low Rate	11ax/11be HE20 RU106 (SISO)	11ax/11be HE20 RU52 (SISO)	11ax/11be HE20 RU26 (SISO)
36	5180	14.50	14.50	14.50	14.50	14.50	11.50
40	5200	14.50	14.50	14.50	14.50	14.50	11.50
44	5220	14.50	14.50	14.50	14.50	14.50	11.50
48	5240	14.50	14.50	14.50	14.50	14.50	11.50
52	5260	14.50	14.50	14.50	14.50	13.25	NS
56	5280	14.50	14.50	14.50	14.50	13.25	NS
60	5300	14.50	14.50	14.50	14.50	13.25	NS
64	5320	14.50	14.50	14.50	14.50	13.25	NS
100	5500	13.75	13.75	13.75	13.75	13.75	NS
104	5520	13.75	13.75	13.75	13.75	13.75	NS
108	5540	13.75	13.75	13.75	13.75	13.75	NS
112	5560	13.75	13.75	13.75	13.75	13.75	NS
116	5580	13.75	13.75	13.75	13.75	13.75	NS
120	5600	13.75	13.75	13.75	13.75	13.75	NS
124	5620	13.75	13.75	13.75	13.75	13.75	NS
128	5640	13.75	13.75	13.75	13.75	13.75	NS
132	5660	13.75	13.75	13.75	13.75	13.75	NS
136	5680	13.75	13.75	13.75	13.75	13.75	NS
140	5700	13.75	13.75	13.75	13.75	9.00	NS
144	5720	13.75	13.75	13.75	13.75	13.75	NS
149	5745	14.00	14.00	14.00	14.00	14.00	13.50
153	5765	14.00	14.00	14.00	14.00	14.00	13.50
157	5785	14.00	14.00	14.00	14.00	14.00	13.50
161	5805	14.00	14.00	14.00	14.00	14.00	13.50
165	5825	14.00	14.00	14.00	14.00	14.00	13.50

Table 70



5 GHz WLAN - 20 MHz BW - MIMO Core 0 - CDD

Channel	Frequency (MHz)	11n/11ac HT20 (2Tx, CDD, non TxBF) Low Rate	11ax/11be HE20 (2Tx, CDD, non TxBF) Low Rate	11ax/11be HE20 RU106 (2Tx, CDD, non TxBF)	11ax/11be HE20 RU52 (2Tx, CDD, non TxBF)	11ax/11be HE20 RU26 (2Tx, CDD, non TxBF)
36	5180	13.50	13.50	11.50	8.50	5.50
40	5200	13.50	13.50	11.50	8.50	5.50
44	5220	13.50	13.50	11.50	8.50	5.50
48	5240	13.50	13.50	11.50	8.50	5.50
52	5260	12.25	12.25	10.25	7.25	NS
56	5280	12.25	12.25	10.25	7.25	NS
60	5300	12.25	12.25	10.25	7.25	NS
64	5320	12.25	12.25	10.25	7.25	NS
100	5500	14.25	14.25	12.25	9.00	NS
104	5520	14.25	14.25	12.25	9.25	NS
108	5540	14.25	14.25	12.25	9.25	NS
112	5560	14.25	14.25	12.25	9.25	NS
116	5580	14.25	14.25	12.25	9.25	NS
120	5600	14.25	14.25	12.25	9.25	NS
124	5620	14.25	14.25	12.25	9.25	NS
128	5640	14.25	14.25	12.25	9.25	NS
132	5660	14.25	14.25	12.25	9.25	NS
136	5680	14.25	14.25	12.25	9.25	NS
140	5700	14.25	13.50	12.00	9.00	NS
144	5720	14.25	14.25	12.25	9.25	NS
149	5745	14.75	14.75	14.75	14.75	13.50
153	5765	14.75	14.75	14.75	14.75	13.50
157	5785	14.75	14.75	14.75	14.75	13.50
161	5805	14.75	14.75	14.75	14.75	13.50
165	5825	14.75	14.75	14.75	14.75	13.50

Table 71



5 GHz WLAN - 20 MHz BW - MIMO Core 1 - CDD

Channel	Frequency (MHz)	11n/11ac HT20 (2Tx, CDD, non TxBF) Low Rate	11ax/11be HE20 (2Tx, CDD, non TxBF) Low Rate	11ax/11be HE20 RU106 (2Tx, CDD, non TxBF)	11ax/11be HE20 RU52 (2Tx, CDD, non TxBF)	11ax/11be HE20 RU26 (2Tx, CDD, non TxBF)
36	5180	13.50	13.50	11.50	8.50	5.50
40	5200	13.50	13.50	11.50	8.50	5.50
44	5220	13.50	13.50	11.50	8.50	5.50
48	5240	13.50	13.50	11.50	8.50	5.50
52	5260	12.25	12.25	10.25	7.25	NS
56	5280	12.25	12.25	10.25	7.25	NS
60	5300	12.25	12.25	10.25	7.25	NS
64	5320	12.25	12.25	10.25	7.25	NS
100	5500	13.75	13.75	12.25	9.00	NS
104	5520	13.75	13.75	12.25	9.25	NS
108	5540	13.75	13.75	12.25	9.25	NS
112	5560	13.75	13.75	12.25	9.25	NS
116	5580	13.75	13.75	12.25	9.25	NS
120	5600	13.75	13.75	12.25	9.25	NS
124	5620	13.75	13.75	12.25	9.25	NS
128	5640	13.75	13.75	12.25	9.25	NS
132	5660	13.75	13.75	12.25	9.25	NS
136	5680	13.75	13.75	12.25	9.25	NS
140	5700	13.75	13.50	12.00	9.00	NS
144	5720	13.75	13.75	12.25	9.25	NS
149	5745	14.00	14.00	14.00	14.00	13.50
153	5765	14.00	14.00	14.00	14.00	13.50
157	5785	14.00	14.00	14.00	14.00	13.50
161	5805	14.00	14.00	14.00	14.00	13.50
165	5825	14.00	14.00	14.00	14.00	13.50

Table 72



5 GHz WLAN - 20 MHz BW - MIMO Core 0 - SDM

Channel	Frequency (MHz)	11n/11ac HT20 (2Tx, SDM, non TxBF) Low Rate	11ax/11be HE20 (2Tx, SDM, non TxBF) Low Rate	11ax/11be HE20 RU106 (2Tx, SDM, non TxBF)	11ax/11be HE20 RU52 (2Tx, SDM, non TxBF)	11ax/11be HE20 RU26 (2Tx, SDM, non TxBF)	11n/11ac VHT20 (2Tx, TxBF) Low Rate
36	5180	14.75	14.75	14.50	11.50	8.50	13.50
40	5200	14.75	14.75	14.50	11.50	8.50	13.50
44	5220	14.75	14.75	14.50	11.50	8.50	13.50
48	5240	14.75	14.75	14.50	11.50	8.50	13.50
52	5260	13.75	13.75	13.25	10.25	NS	12.25
56	5280	13.75	13.75	13.25	10.25	NS	12.25
60	5300	13.75	13.75	13.25	10.25	NS	12.25
64	5320	13.75	13.75	13.25	10.25	NS	12.25
100	5500	14.50	14.50	14.50	11.50	NS	14.25
104	5520	14.50	14.50	14.50	11.50	NS	14.25
108	5540	14.50	14.50	14.50	11.50	NS	14.25
112	5560	14.50	14.50	14.50	11.50	NS	14.25
116	5580	14.50	14.50	14.50	11.50	NS	14.25
120	5600	14.50	14.50	14.50	11.50	NS	14.25
124	5620	14.50	14.50	14.50	11.50	NS	14.25
128	5640	14.50	14.50	14.50	11.50	NS	14.25
132	5660	14.50	14.50	14.50	11.50	NS	14.25
136	5680	14.50	14.50	14.50	11.50	NS	14.25
140	5700	14.50	13.00	13.75	9.00	NS	13.50
144	5720	14.50	14.50	14.50	11.50	NS	14.25
15.25	15.25	14.75	14.75	14.75	14.75	13.50	14.75
15.25	15.25	14.75	14.75	14.75	14.75	13.50	14.75
15.25	15.25	14.75	14.75	14.75	14.75	13.50	14.75
15.25	15.25	14.75	14.75	14.75	14.75	13.50	14.75
15.25	15.25	14.75	14.75	14.75	14.75	13.50	14.75

Table 73



5 GHz WLAN - 20 MHz BW - MIMO Core 1 - SDM

Channel	Frequency (MHz)	11n/11ac HT20 (2Tx, SDM, non TxBF) Low Rate	11ax/11be HE20 (2Tx, SDM, non TxBF) Low Rate	11ax/11be HE20 RU106 (2Tx, SDM, non TxBF)	11ax/11be HE20 RU52 (2Tx, SDM, non TxBF)	11ax/11be HE20 RU26 (2Tx, SDM, non TxBF)	11n/11ac VHT20 (2Tx, TxBF) Low Rate
36	5180	14.50	14.50	14.50	11.50	8.50	13.50
40	5200	14.50	14.50	14.50	11.50	8.50	13.50
44	5220	14.50	14.50	14.50	11.50	8.50	13.50
48	5240	14.50	14.50	14.50	11.50	8.50	13.50
52	5260	14.50	14.50	13.25	10.25	NS	12.25
56	5280	14.50	14.50	13.25	10.25	NS	12.25
60	5300	14.50	14.50	13.25	10.25	NS	12.25
64	5320	14.50	14.50	13.25	10.25	NS	12.25
100	5500	13.75	13.75	13.75	11.50	NS	13.75
104	5520	13.75	13.75	13.75	11.50	NS	13.75
108	5540	13.75	13.75	13.75	11.50	NS	13.75
112	5560	13.75	13.75	13.75	11.50	NS	13.75
116	5580	13.75	13.75	13.75	11.50	NS	13.75
120	5600	13.75	13.75	13.75	11.50	NS	13.75
124	5620	13.75	13.75	13.75	11.50	NS	13.75
128	5640	13.75	13.75	13.75	11.50	NS	13.75
132	5660	13.75	13.75	13.75	11.50	NS	13.75
136	5680	13.75	13.75	13.75	11.50	NS	13.75
140	5700	13.75	13.00	13.75	9.00	NS	13.50
144	5720	13.75	13.75	13.75	11.50	NS	13.75
15.25	15.25	14.00	14.00	14.00	14.00	13.50	14.00
15.25	15.25	14.00	14.00	14.00	14.00	13.50	14.00
15.25	15.25	14.00	14.00	14.00	14.00	13.50	14.00
15.25	15.25	14.00	14.00	14.00	14.00	13.50	14.00
15.25	15.25	14.00	14.00	14.00	14.00	13.50	14.00

Table 74



5 GHz WLAN - 40 MHz BW - SISO Core 0

Channel	Frequency (MHz)	11n/11ac HT40 (SISO) Low Rate	11ax/11be HE40 (SISO) Low Rate	11ax/11be HE40 RU106 (SISO)	11ax/11be HE40 RU52 (SISO)	11ax/11be HE40 RU26 (SISO)
38	5190	14.75	14.50	14.00	13.50	10.50
46	5230	14.75	14.75	14.75	13.50	10.50
54	5270	13.75	13.75	13.75	13.25	NS
62	5310	13.75	13.75	13.50	10.00	NS
102	5510	14.50	14.50	14.50	13.50	NS
110	5550	14.50	14.50	14.50	13.50	NS
118	5590	14.50	14.50	14.50	13.50	NS
126	5630	14.50	14.50	14.50	13.50	NS
134	5670	14.50	14.50	14.50	13.50	NS
142	5710	14.50	14.50	14.50	13.50	NS
151	5755	14.75	14.75	14.75	13.50	10.50
159	5795	14.75	14.75	14.75	13.50	10.50

Table 75

5 GHz WLAN - 40 MHz BW - SISO Core 1

Channel	Frequency (MHz)	11n/11ac HT40 (SISO) Low Rate	11ax/11be HE40 (SISO) Low Rate	11ax/11be HE40 RU106 (SISO)	11ax/11be HE40 RU52 (SISO)	11ax/11be HE40 RU26 (SISO)
38	5190	14.50	14.50	14.00	13.50	10.50
46	5230	14.50	14.50	14.50	13.50	10.50
54	5270	14.50	14.50	14.50	13.25	NS
62	5310	14.50	14.00	13.50	10.00	NS
102	5510	13.75	13.75	13.75	13.50	NS
110	5550	13.75	13.75	13.75	13.50	NS
118	5590	13.75	13.75	13.75	13.50	NS
126	5630	13.75	13.75	13.75	13.50	NS
134	5670	13.75	13.75	13.75	13.50	NS
142	5710	13.75	13.75	13.75	13.50	NS
151	5755	14.00	14.00	14.00	13.50	10.50
159	5795	14.00	14.00	14.00	13.50	10.50

Table 76



5 GHz WLAN - 40 MHz BW - MIMO Core 0 - CDD

Channel	Frequency (MHz)	11n/11ac HT40 (2Tx, CDD, non TxBF) Low Rate	11ax/11be HE40 (2Tx, CDD, non TxBF) Low Rate	11ax/11be HE40 RU106 (2Tx, CDD, non TxBF)	11ax/11be HE40 RU52 (2Tx, CDD, non TxBF)	11ax/11be HE40 RU26 (2Tx, CDD, non TxBF)
38	5190	14.75	14.75	11.50	8.50	5.50
46	5230	14.75	14.75	11.50	8.50	5.50
54	5270	13.75	13.75	10.25	7.25	NS
62	5310	13.75	13.75	10.00	7.00	NS
102	5510	14.50	14.00	12.25	9.25	NS
110	5550	14.50	14.50	12.25	9.25	NS
118	5590	14.50	14.50	12.25	9.25	NS
126	5630	14.50	14.50	12.25	9.25	NS
134	5670	14.50	14.50	12.25	9.25	NS
142	5710	14.50	14.50	12.25	9.25	NS
151	5755	14.75	14.75	14.75	13.50	10.50
159	5795	14.75	14.75	14.75	13.50	10.50

Table 77

5 GHz WLAN - 40 MHz BW - MIMO Core 1 - CDD

Channel	Frequency (MHz)	11n/11ac HT40 (2Tx, CDD, non TxBF) Low Rate	11ax/11be HE40 (2Tx, CDD, non TxBF) Low Rate	11ax/11be HE40 RU106 (2Tx, CDD, non TxBF)	11ax/11be HE40 RU52 (2Tx, CDD, non TxBF)	11ax/11be HE40 RU26 (2Tx, CDD, non TxBF)
38	5190	14.50	14.50	11.50	8.50	5.50
46	5230	14.50	14.50	11.50	8.50	5.50
54	5270	14.50	14.50	10.25	7.25	NS
62	5310	14.50	13.75	10.00	7.00	NS
102	5510	13.75	13.75	12.25	9.25	NS
110	5550	13.75	13.75	12.25	9.25	NS
118	5590	13.75	13.75	12.25	9.25	NS
126	5630	13.75	13.75	12.25	9.25	NS
134	5670	13.75	13.75	12.25	9.25	NS
142	5710	13.75	13.75	12.25	9.25	NS
151	5755	14.00	14.00	14.00	13.50	10.50
159	5795	14.00	14.00	14.00	13.50	10.50

Table 78



5 GHz WLAN - 40 MHz BW - MIMO Core 0 - SDM

Channel	Frequency (MHz)	11n/11ac HT40 (2Tx, SDM, non TxBF) Low Rate	11ax/11be HE40 (2Tx, SDM, non TxBF) Low Rate	11ax/11be HE40 RU106 (2Tx, SDM, non TxBF)	11ax/11be HE40 RU52 (2Tx, SDM, non TxBF)	11ax/11be HE40 RU26 (2Tx, SDM, non TxBF)	11n/11ac VHT40 (2Tx, TxBF) Low Rate
38	5190	14.75	14.75	12.00	11.50	8.50	14.75
46	5230	14.75	14.75	14.50	11.50	8.50	14.75
54	5270	13.75	13.75	13.25	10.25	NS	13.75
62	5310	13.00	13.75	10.00	7.00	NS	13.50
102	5510	13.75	14.00	14.25	11.00	NS	13.50
110	5550	14.50	14.50	14.25	11.25	NS	14.50
118	5590	14.50	14.50	14.50	11.50	NS	14.50
126	5630	14.50	14.50	14.50	11.50	NS	14.50
134	5670	14.50	14.50	14.25	11.25	NS	14.50
142	5710	14.50	14.50	14.50	11.50	NS	14.50
151	5755	14.75	14.75	14.75	13.50	10.50	14.75
159	5795	14.75	14.75	14.75	13.50	10.50	14.75

Table 79

5 GHz WLAN - 40 MHz BW - MIMO Core 1 - SDM

Channel	Frequency (MHz)	11n/11ac HT40 (2Tx, SDM, non TxBF) Low Rate	11ax/11be HE40 (2Tx, SDM, non TxBF) Low Rate	11ax/11be HE40 RU106 (2Tx, SDM, non TxBF)	11ax/11be HE40 RU52 (2Tx, SDM, non TxBF)	11ax/11be HE40 RU26 (2Tx, SDM, non TxBF)	11n/11ac VHT40 (2Tx, TxBF) Low Rate
38	5190	14.50	14.50	12.00	11.50	8.50	14.50
46	5230	14.50	14.50	14.50	11.50	8.50	14.50
54	5270	14.50	14.50	13.25	10.25	NS	14.50
62	5310	13.00	14.25	10.00	7.00	NS	13.50
102	5510	13.75	13.75	13.75	11.00	NS	13.50
110	5550	13.75	13.75	13.75	11.25	NS	13.75
118	5590	13.75	13.75	13.75	11.50	NS	13.75
126	5630	13.75	13.75	13.75	11.50	NS	13.75
134	5670	13.75	13.75	13.75	11.25	NS	13.75
142	5710	13.75	13.75	13.75	11.50	NS	13.75
151	5755	14.00	14.00	14.00	13.50	10.50	14.00
159	5795	14.00	14.00	14.00	13.50	10.50	14.00

Table 80



5 GHz WLAN - 80 MHz BW - SISO Core 0

Channel	Frequency (MHz)	11ac VHT80 (SISO) Low Rate	11ax/11be HE80 (SISO) Low Rate	11ax/11be HE80 RU106 (SISO)	11ax/11be HE80 RU52 (SISO)	11ax/11be HE80 RU26 (SISO)
42	5210	14.75	14.25	13.50	10.50	7.50
58	5290	13.75	12.50	12.00	10.00	NS
106	5530	14.50	14.50	12.75	10.00	NS
122	5610	14.50	14.50	13.50	10.50	NS
138	5690	14.50	14.50	13.50	10.50	NS
155	5775	14.75	14.75	13.50	10.50	7.50

Table 81

5 GHz WLAN - 80 MHz BW - SISO Core 1

Channel	Frequency (MHz)	11ac VHT80 (SISO) Low Rate	11ax/11be HE80 (SISO) Low Rate	11ax/11be HE80 RU106 (SISO)	11ax/11be HE80 RU52 (SISO)	11ax/11be HE80 RU26 (SISO)
42	5210	14.50	14.25	13.50	10.50	7.50
58	5290	13.75	12.50	12.00	10.00	NS
106	5530	13.75	13.75	12.75	10.00	NS
122	5610	13.75	13.75	13.50	10.50	NS
138	5690	13.75	13.75	13.50	10.50	NS
155	5775	14.00	14.00	13.50	10.50	7.50

Table 82

5 GHz WLAN - 80 MHz BW - MIMO Core 0 - CDD

Channel	Frequency (MHz)	11ac VHT80 (2Tx, CDD, non TxBF) Low Rate	11ax/11be HE80 (2Tx, CDD, non TxBF) Low Rate	11ax/11be HE80 RU106 (2Tx, CDD, non TxBF)	11ax/11be HE80 RU52 (2Tx, CDD, non TxBF)	11ax/11be HE80 RU26 (2Tx, CDD, non TxBF)
42	5210	13.00	14.75	11.50	8.00	5.50
58	5290	12.00	11.50	9.00	7.25	NS
106	5530	14.00	13.50	10.00	6.00	NS
122	5610	14.50	14.50	12.00	9.00	NS
138	5690	14.50	14.50	12.00	9.00	NS
155	5775	14.75	14.75	13.50	10.50	7.50

Table 83



5 GHz WLAN - 80 MHz BW - MIMO Core 1 - CDD

Channel	Frequency (MHz)	11ac VHT80 (2Tx, CDD, non TxBF) Low Rate	11ax/11be HE80 (2Tx, CDD, non TxBF) Low Rate	11ax/11be HE80 RU106 (2Tx, CDD, non TxBF)	11ax/11be HE80 RU52 (2Tx, CDD, non TxBF)	11ax/11be HE80 RU26 (2Tx, CDD, non TxBF)
42	5210	13.00	14.50	11.50	8.00	5.50
58	5290	12.00	11.50	9.00	7.25	NS
106	5530	13.75	13.50	10.00	6.00	NS
122	5610	13.75	13.75	12.00	9.00	NS
138	5690	13.75	13.75	12.00	9.00	NS
155	5775	14.00	14.00	13.50	10.50	7.50

Table 84

5 GHz WLAN - 80 MHz BW - MIMO Core 0 - SDM

Channel	Frequency (MHz)	11ac VHT80 (2Tx, SDM, non TxBF) Low Rate	11ax/11be HE80 (2Tx, SDM, non TxBF) Low Rate	11ax/11be HE80 RU106 (2Tx, SDM, non TxBF)	11ax/11be HE80 RU52 (2Tx, SDM, non TxBF)	11ax/11be HE80 RU26 (2Tx, SDM, non TxBF)	11ac VHT80 (2Tx, TxBF) Low Rate
42	5210	13.00	12.75	11.50	8.00	6.00	12.50
58	5290	11.75	12.50	9.00	7.50	NS	10.00
106	5530	14.00	13.50	10.00	6.00	NS	12.50
122	5610	14.50	14.50	13.50	10.50	NS	14.50
138	5690	14.50	14.50	13.50	10.50	NS	14.50
155	5775	14.75	14.75	13.50	10.50	7.50	14.75

Table 85

5 GHz WLAN - 80 MHz BW - MIMO Core 1 - SDM

Channel	Frequency (MHz)	11ac VHT80 (2Tx, SDM, non TxBF) Low Rate	11ax/11be HE80 (2Tx, SDM, non TxBF) Low Rate	11ax/11be HE80 RU106 (2Tx, SDM, non TxBF)	11ax/11be HE80 RU52 (2Tx, SDM, non TxBF)	11ax/11be HE80 RU26 (2Tx, SDM, non TxBF)	11ac VHT80 (2Tx, TxBF) Low Rate
42	5210	13.00	12.75	11.50	8.00	6.00	12.50
58	5290	11.75	12.50	9.00	7.50	NS	10.00
106	5530	13.75	13.50	10.00	6.00	NS	12.50
122	5610	13.75	13.75	13.50	10.50	NS	13.75
138	5690	13.75	13.75	13.50	10.50	NS	13.75
155	5775	14.00	14.00	13.50	10.50	7.50	14.00

Table 86



5 GHz WLAN - 160 MHz BW - SISO Core 0 & Core1

Channel	Frequency (MHz)	11ac VHT160 (SISO) Low Rate	11ax/11be HE160 (SISO) Low Rate	11ax/11be HE160 RU106 (SISO)	11ax/11be HE160 RU52 (SISO)	11ax/11be HE160 RU26 (SISO)
50	5250	13.25	12.50	10.50	7.50	NS
114	5570	12.25	12.50	10.50	7.50	NS

Table 87

5 GHz WLAN - 160 MHz BW - MIMO Core 0 & Core 1 - CDD

Channel	Frequency (MHz)	11ac VHT160 (2Tx, CDD, non TxBF) Low Rate	11ax/11be HE160 (2Tx, CDD, non TxBF) Low Rate	11ax/11be HE160 RU106 (2Tx, CDD, non TxBF)	11ax/11be HE160 RU52 (2Tx, CDD, non TxBF)	11ax/11be HE160 RU26 (2Tx, CDD, non TxBF)
50	5250	10.25	10.25	10.00	7.25	NS
114	5570	9.50	10.00	10.00	6.00	NS

Table 88

5 GHz WLAN - 160 MHz BW - MIMO Core 0 & Core 1 - SDM

Channel	Frequency (MHz)	11ac VHT160 (2Tx, SDM, non TxBF) Low Rate	11ax/11be HE160 (2Tx, SDM, non TxBF) Low Rate	11ax/11be HE160 RU106 (2Tx, SDM, non TxBF)	11ax/11be HE160 RU52 (2Tx, SDM, non TxBF)
50	5250	10.25	10.25	9.00	7.50
114	5570	9.00	10.00	10.00	6.00

Table 89



6 GHz WLAN - 20 MHz - SISO Core 0 & Core 1 - LP

Channel	Frequency (MHz)	a (SISO) Low Rate	11ax HE20 (SISO) Low Rate	11ax HE20 RU106 (SISO)	11ax HE20 RU52 (SISO)	11ax HE20 RU26 (SISO)
2	5935	NS	NS	NS	NS	NS
1	5955	3.75	3.75	0.75	-2.25	-5.25
5	5975	3.75	3.75	0.75	-2.25	-5.25
9-29	5995-6095	3.75	3.75	0.75	-2.25	-5.25
33-61	6115-6255	3.25	3.25	0.25	-2.75	-5.75
65-85	6275-6375	2.75	2.75	-0.25	-3.25	-6.25
89	6395	2.75	2.75	-0.25	-3.25	-6.25
93	6415	2.75	2.75	-0.25	-3.25	-6.25
97-113	6435-6515	2.75	2.75	-0.25	-3.25	-6.25
117-181	6535-6855	2.50	2.50	-0.50	-3.50	-6.50
185	6875	2.50	2.50	-0.50	-3.50	-6.50
189-225	6895-7075	4.75	4.75	1.75	-1.25	-4.25
229	7095	4.75	4.75	1.75	-1.25	-4.25
233	7115	-3.50	NS	NS	NS	NS

Table 90



6 GHz WLAN - 20 MHz - MIMO Core 0 & Core 1 - CDD - LP

Channel	Frequency (MHz)	11ax HE20 (2Tx, CDD, non TxBF) Low Rate	11ax HE20 RU106 (2Tx, CDD, non TxBF)	11ax HE20 RU52 (2Tx, CDD, non TxBF)	11ax HE20 RU26 (2Tx, CDD, non TxBF)
2	5935	NS	NS	NS	NS
1	5955	-1.25	-4.25	-7.25	NS
5	5975	-1.25	-4.25	-7.25	NS
9-29	5995-6095	-1.25	-4.25	-7.25	NS
33-61	6115-6255	-1.75	-4.75	-7.75	NS
65-85	6275-6375	-1.50	-4.50	-7.50	NS
89	6395	-1.50	-4.50	-7.50	NS
93	6415	-1.50	-4.50	-7.50	NS
97-113	6435-6515	-1.75	-4.75	-7.75	NS
117-181	6535-6855	-2.25	-5.25	-8.25	NS
185	6875	-2.25	-5.25	-8.25	NS
189-225	6895-7075	0.00	-3.00	-6.00	NS
229	7095	0.00	-3.00	-6.00	NS
233	7115	NS	NS	NS	NS

Table 91

6 GHz WLAN - 20 MHz - MIMO Core 0 & Core 1 - SDM - LP

Channel	Frequency (MHz)	11ax HE20 (2Tx, SDM, non TxBF) Low Rate	11ax HE20 RU106 (2Tx, SDM, non TxBF)	11ax HE20 RU52 (2Tx, SDM, non TxBF)	11ax HE20 RU26 (2Tx, SDM, non TxBF)
2	5935	NS	NS	NS	NS
1	5955	1.50	-1.50	-4.50	-7.50
5	5975	1.50	-1.50	-4.50	-7.50
9-29	5995-6095	1.50	-1.50	-4.50	-7.50
33-61	6115-6255	1.25	-1.75	-4.75	-7.75
65-85	6275-6375	1.25	-1.75	-4.75	-7.75
89	6395	1.25	-1.75	-4.75	-7.75
93	6415	1.25	-1.75	-4.75	-7.75
97-113	6435-6515	1.25	-1.75	-4.75	-7.75
117-181	6535-6855	0.50	-2.50	-5.50	-8.50
185	6875	0.50	-2.50	-5.50	-8.50
189-225	6895-7075	3.00	0.00	-3.00	-6.00
229	7095	3.00	0.00	-3.00	-6.00
233	7115	NS	NS	NS	NS

Table 92



6 GHz WLAN - 40 MHz - SISO Core 0 & Core 1 - LP

Channel	Frequency (MHz)	11ax HE40 (SISO) Low Rate	11ax HE40 RU106 (SISO)	11ax HE40 RU52 (SISO)	11ax HE40 RU26 (SISO)
3	5965	6.25	0.75	-2.25	-5.25
11	6005	6.25	0.75	-2.25	-5.25
19-27	6045-6085	6.25	0.75	-2.25	-5.25
35-59	6125-6245	5.75	0.25	-2.75	-5.75
67-75	6285-6325	5.25	-0.25	-3.25	-6.25
83	6365	5.25	-0.25	-3.25	-6.25
91	6405	5.25	-0.25	-3.25	-6.25
99-107	6445-6485	5.25	-0.25	-3.25	-6.25
115	6525	5.00	-0.50	-3.50	-6.50
123-179	6565-6845	5.00	-0.50	-3.50	-6.50
187	6885	5.00	-0.50	-3.50	-6.50
195-219	6925-7045	7.25	1.75	-1.25	-4.25
227	7085	7.25	1.75	-1.25	-4.25

Table 93

6 GHz WLAN - 40 MHz - MIMO Core 0 & Core 1 - CDD - LP

Channel	Frequency (MHz)	11ax HE40 (2Tx, CDD, non TxBF) Low Rate	11ax HE40 RU106 (2Tx, CDD, non TxBF)	11ax HE40 RU52 (2Tx, CDD, non TxBF)	11ax HE40 RU26 (2Tx, CDD, non TxBF)
3	5965	1.25	-4.25	-7.25	NS
11	6005	1.25	-4.25	-7.25	NS
19-27	6045-6085	1.25	-4.25	-7.25	NS
35-59	6125-6245	0.75	-4.75	-7.75	NS
67-75	6285-6325	1.00	-4.50	-7.50	NS
83	6365	1.00	-4.50	-7.50	NS
91	6405	1.00	-4.50	-7.50	NS
99-107	6445-6485	0.75	-4.75	-7.75	NS
115	6525	0.25	-5.25	-8.25	NS
123-179	6565-6845	0.25	-5.25	-8.25	NS
187	6885	0.25	-5.25	-8.25	NS
195-219	6925-7045	2.50	-3.00	-6.00	NS
227	7085	2.50	-3.00	-6.00	NS

Table 94



6 GHz WLAN - 40 MHz - MIMO Core 0 & Core 1 - SDM - LP

Channel	Frequency (MHz)	11ax HE40 (2Tx, SDM, non TxBF) Low Rate	11ax HE40 RU106 (2Tx, SDM, non TxBF)	11ax HE40 RU52 (2Tx, SDM, non TxBF)	11ax HE40 RU26 (2Tx, SDM, non TxBF)	11ax HE40 (2Tx, TxBF) Low Rate
3	5965	4.00	-1.50	-4.50	-7.50	NS
11	6005	4.00	-1.50	-4.50	-7.50	NS
19-27	6045-6085	4.00	-1.50	-4.50	-7.50	NS
35-59	6125-6245	3.75	-1.75	-4.75	-7.75	NS
67-75	6285-6325	3.75	-1.75	-4.75	-7.75	NS
83	6365	3.75	-1.75	-4.75	-7.75	NS
91	6405	3.75	-1.75	-4.75	-7.75	NS
99-107	6445-6485	3.75	-1.75	-4.75	-7.75	NS
115	6525	3.00	-2.50	-5.50	-8.50	NS
123-179	6565-6845	3.00	-2.50	-5.50	-8.50	NS
187	6885	3.00	-2.50	-5.50	-8.50	NS
195-219	6925-7045	5.50	0.00	-3.00	-6.00	2.50
227	7085	5.50	0.00	-3.00	-6.00	2.50

Table 95

6 GHz WLAN - 80 MHz - SISO Core 0 & Core 1 - LP

Channel	Frequency (MHz)	11ax HE80 (SISO) Low Rate	11ax HE80 RU106 (SISO)	11ax HE80 RU52 (SISO)	11ax HE80 RU26 (SISO)
7	5985	9.25	0.75	-2.25	-5.25
23	6065	9.25	0.75	-2.25	-5.25
39-55	6145-6225	8.75	0.25	-2.75	-5.75
71	6305	8.25	-0.25	-3.25	-6.25
87	6385	8.25	-0.25	-3.25	-6.25
103	6465	8.25	-0.25	-3.25	-6.25
119	6545	8.00	-0.50	-3.50	-6.50
135-167	6625-6785	8.00	-0.50	-3.50	-6.50
183	6865	8.00	-0.50	-3.50	-6.50
199	6945	10.25	1.75	-1.25	-4.25
215	7025	10.25	1.75	-1.25	-4.25

Table 96



6 GHz WLAN - 80 MHz - MIMO Core 0 & Core 1 - CDD - LP

Channel	Frequency (MHz)	11ax HE80 (2Tx, CDD, non TxBF) Low Rate	11ax HE80 RU106 (2Tx, CDD, non TxBF)	11ax HE80 RU52 (2Tx, CDD, non TxBF)	11ax HE80 RU26 (2Tx, CDD, non TxBF)
7	5985	4.25	-4.25	-7.25	NS
23	6065	4.25	-4.25	-7.25	NS
39-55	6145-6225	3.75	-4.75	-7.75	NS
71	6305	4.00	-4.50	-7.50	NS
87	6385	4.00	-4.50	-7.50	NS
103	6465	3.75	-4.75	-7.75	NS
119	6545	3.25	-5.25	-8.25	NS
135-167	6625-6785	3.25	-5.25	-8.25	NS
183	6865	3.25	-5.25	-8.25	NS
199	6945	5.50	-3.00	-6.00	NS
215	7025	5.50	-3.00	-6.00	NS

Table 97

6 GHz WLAN - 80 MHz - MIMO Core 0 & Core 1 - SDM - LP

Channel	Frequency (MHz)	11ax HE80 (2Tx, SDM, non TxBF) Low Rate	11ax HE80 RU106 (2Tx, SDM, non TxBF)	11ax HE80 RU52 (2Tx, SDM, non TxBF)	11ax HE80 RU26 (2Tx, SDM, non TxBF)	11ax HE80 (2Tx, TxBF) Low Rate
7	5985	7.00	-1.50	-4.50	-7.50	4.25
23	6065	7.00	-1.50	-4.50	-7.50	4.25
39-55	6145-6225	6.75	-1.75	-4.75	-7.75	3.75
71	6305	6.75	-1.75	-4.75	-7.75	4.00
87	6385	6.75	-1.75	-4.75	-7.75	4.00
103	6465	6.75	-1.75	-4.75	-7.75	3.75
119	6545	6.00	-2.50	-5.50	-8.50	3.25
135-167	6625-6785	6.00	-2.50	-5.50	-8.50	3.25
183	6865	6.00	-2.50	-5.50	-8.50	3.25
199	6945	8.50	0.00	-3.00	-6.00	5.50
215	7025	8.50	0.00	-3.00	-6.00	5.50

Table 98



6 GHz WLAN - 160 MHz - SISO Core 0 - LP

Channel	Frequency (MHz)	11ax HE160 (SISO) Low Rate	11ax HE160 RU106 (SISO)	11ax HE160 RU52 (SISO)	11ax HE160 RU26 (SISO)
15	6025	12.25	0.75	-2.25	-5.25
47	6185	11.75	0.25	-2.75	-5.75
79	6345	11.25	-0.25	-3.25	-6.25
111	6505	11.00	-0.50	-3.50	-6.50
143	6665	11.00	-0.50	-3.50	-6.50
175	6825	11.00	-0.50	-3.50	-6.50
207	6985	12.50	1.75	-1.25	-4.25

Table 99

6 GHz WLAN - 160 MHz - SISO Core 1 - LP

Channel	Frequency (MHz)	11ax HE160 (SISO) Low Rate	11ax HE160 RU106 (SISO)	11ax HE160 RU52 (SISO)	11ax HE160 RU26 (SISO)
15	6025	11.75	0.75	-2.25	-5.25
47	6185	11.75	0.25	-2.75	-5.75
79	6345	11.25	-0.25	-3.25	-6.25
111	6505	11.00	-0.50	-3.50	-6.50
143	6665	11.00	-0.50	-3.50	-6.50
175	6825	11.00	-0.50	-3.50	-6.50
207	6985	13.25	1.75	-1.25	-4.25

Table 100

6 GHz WLAN - 160 MHz - MIMO Core 0 & Core 1 - CDD - LP

Channel	Frequency (MHz)	11ax HE160 (2Tx, CDD, non TxBF) Low Rate	11ax HE160 RU106 (2Tx, CDD, non TxBF)	11ax HE160 RU52 (2Tx, CDD, non TxBF)	11ax HE160 RU26 (2Tx, CDD, non TxBF)
15	6025	7.25	-4.25	-7.25	NS
47	6185	6.75	-4.75	-7.75	NS
79	6345	7.00	-4.50	-7.50	NS
111	6505	6.25	-5.25	-8.25	NS
143	6665	6.25	-5.25	-8.25	NS
175	6825	6.25	-5.25	-8.25	NS
207	6985	8.50	-3.00	-6.00	NS

Table 101



6 GHz WLAN - 160 MHz - MIMO Core 0 & Core 1 - SDM - LP

Channel	Frequency (MHz)	11ax HE160 (2Tx, SDM, non TxBF) Low Rate	11ax HE160 RU106 (2Tx, SDM, non TxBF)	11ax HE160 RU52 (2Tx, SDM, non TxBF)	11ax HE160 RU26 (2Tx, SDM, non TxBF)
15	6025	10.00	-1.50	-4.50	-7.50
47	6185	9.75	-1.75	-4.75	-7.75
79	6345	9.75	-1.75	-4.75	-7.75
111	6505	9.00	-2.50	-5.50	-8.50
143	6665	9.00	-2.50	-5.50	-8.50
175	6825	9.00	-2.50	-5.50	-8.50
207	6985	11.50	0.00	-3.00	-6.00

Table 102

6 GHz WLAN - 20 MHz - Core 0 & Core 1 - VLP

Channel	Centre Frequency (MHz)	a (SISO) Low Rate	11ax/11be HE20 (SISO) Low Rate
2	5935	NS	NS
1	5955	NS	NS
5	5975	NS	NS
9-29	5995-6095	NS	NS
33-61	6115-6255	-0.75	-0.75
65-85	6275-6375	-1.25	-1.25
89	6395	-1.25	-1.25
93	6415	-1.25	-1.25
97-113	6435-6515	NS	NS
117-181	6535-6855	-1.50	-1.50
185	6875	NS	NS
189-225	6895-7075	NS	NS
229	7095	NS	NS
233	7115	NS	NS

Table 103



6 GHz WLAN - 40 MHz - Core 0 & Core 1 - VLP

Channel	Centre Frequency (MHz)	a (SISO) Low Rate	11ax/11be HE20 (SISO) Low Rate
3	5965	NS	NS
11	6005	NS	NS
19-27	6045-6085	NS	NS
35-59	6125-6245	1.75	-0.25
67-75	6285-6325	1.25	-0.25
83	6365	1.25	-0.25
91	6405	1.25	-0.25
99-107	6445-6485	NS	NS
115	6525	NS	NS
123-179	6565-6845	1.00	-1.00
187	6885	NS	NS
195-219	6925-7045	NS	NS
227	7085	NS	NS

Table 104

6 GHz WLAN - 80 MHz - Core 0 & Core 1 - VLP

Channel	Centre Frequency (MHz)	11ax/11be HE80 (SISO) Low Rate	11ax/11be HE80 (2Tx, CDD, non TxBF) Low Rate	11ax/11be HE80 (2Tx, SDM, non TxBF) Low Rate
7	5985	NS	NS	NS
23	6065	NS	NS	NS
39-55	6145-6225	4.75	-0.25	2.75
71	6305	4.25	0.00	2.75
87	6385	4.25	0.00	2.75
103	6465	NS	NS	NS
119	6545	NS	NS	NS
135-167	6625-6785	4.00	-0.75	2.00
183	6865	NS	NS	NS
199	6945	NS	NS	NS
215	7025	NS	NS	NS

Table 105



6 GHz WLAN - 160 MHz - Core 0 & Core 1 - VLP

Channel	Centre Frequency (MHz)	11ax/11be HE160 (SISO) Low Rate	11ax/11be HE160 (2Tx, CDD, non TxBF) Low Rate	11ax/11be HE160 (2Tx, SDM, non TxBF) Low Rate
15	6025	NS	NS	NS
47	6185	7.25	2.75	5.25
79	6345	6.75	3.00	5.25
111	6505	NS	NS	NS
143	6665	6.50	2.25	4.50
175	6825	NS	NS	NS
207	6985	NS	NS	NS

Table 106

6 GHz WLAN - 20 MHz - SISO Core 0 - SP

Channel	Frequency (MHz)	a (SISO) Low Rate	11ax/11be HE20 RU106 (SISO)	11ax/11be HE20 RU52 (SISO)	11ax/11be HE20 RU26 (SISO)
2	5935	NS	NS	NS	NS
1	5955	12.75	12.75	12.75	12.25
5	5975	12.75	12.75	12.75	12.25
9-29	5995-6095	12.75	12.75	12.75	12.25
33-61	6115-6255	13.25	13.25	13.25	11.75
65-85	6275-6375	13.25	13.25	13.25	11.25
89	6395	13.25	13.25	13.25	11.25
93	6415	13.25	13.25	13.25	11.25
97-113	6435-6515	NS	NS	NS	NS
117-128	6535-6590	12.00	12.00	12.00	11.00
129-160	6595-6750	11.75	11.75	11.75	11.00
160-181	6750-6855	12.00	12.00	12.00	11.00
185	6875	NS	NS	NS	NS
189-225	6895-7075	NS	NS	NS	NS
229	7095	NS	NS	NS	NS
233	7115	NS	NS	NS	NS

Table 107



6 GHz WLAN - 20 MHz - SISO Core 1 - SP

Channel	Frequency (MHz)	a (SISO) Low Rate	11ax/11be HE20 RU106 (SISO)	11ax/11be HE20 RU52 (SISO)	11ax/11be HE20 RU26 (SISO)
2	5935	NS	NS	NS	NS
1	5955	11.75	11.75	11.75	11.75
5	5975	11.75	11.75	11.75	11.75
9-29	5995-6095	11.75	11.75	11.75	11.75
33-61	6115-6255	12.25	12.25	12.25	11.75
65-85	6275-6375	12.25	12.25	12.25	11.25
89	6395	12.25	12.25	12.25	11.25
93	6415	12.25	12.25	12.25	11.25
97-113	6435-6515	NS	NS	NS	NS
117-128	6535-6590	13.00	13.00	13.00	11.00
129-160	6595-6750	13.00	13.00	13.00	11.00
160-181	6750-6855	13.75	13.75	13.75	11.00
185	6875	NS	NS	NS	NS
189-225	6895-7075	NS	NS	NS	NS
229	7095	NS	NS	NS	NS
233	7115	NS	NS	NS	NS

Table 108



6 GHz WLAN - 20 MHz - MIMO Core 0 - CDD - SP

Channel	Centre Frequency (MHz)	11ax/11be HE20 (2Tx, CDD, non TxBF) Low Rate	11ax/11be HE20 RU106 (2Tx, CDD, non TxBF)	11ax/11be HE20 RU52 (2Tx, CDD, non TxBF)	11ax/11be HE20 RU26 (2Tx, CDD, non TxBF)
2	5935	NS	NS	NS	NS
1	5955	12.75	12.75	10.25	7.25
5	5975	12.75	12.75	10.25	7.25
9-29	5995-6095	12.75	12.75	10.25	7.25
33-61	6115-6255	13.25	12.75	9.75	6.75
65-85	6275-6375	13.25	13.00	10.00	7.00
89	6395	13.25	13.00	10.00	7.00
93	6415	13.25	13.00	10.00	7.00
97-113	6435-6515	NS	NS	NS	NS
117-128	6535-6590	12.00	12.00	9.25	6.25
129-160	6595-6750	11.75	11.75	9.25	6.25
160-181	6750-6855	12.00	12.00	9.25	6.25
185	6875	NS	NS	NS	NS
189-225	6895-7075	NS	NS	NS	NS
229	7095	NS	NS	NS	NS
233	7115	NS	NS	NS	NS

Table 109



6 GHz WLAN - 20 MHz - MIMO Core 1 - CDD - SP

Channel	Centre Frequency (MHz)	11ax/11be HE20 (2Tx, CDD, non TxBF) Low Rate	11ax/11be HE20 RU106 (2Tx, CDD, non TxBF)	11ax/11be HE20 RU52 (2Tx, CDD, non TxBF)	11ax/11be HE20 RU26 (2Tx, CDD, non TxBF)
2	5935	NS	NS	NS	NS
1	5955	11.75	11.75	10.25	7.25
5	5975	11.75	11.75	10.25	7.25
9-29	5995-6095	11.75	11.75	10.25	7.25
33-61	6115-6255	12.25	12.25	9.75	6.75
65-85	6275-6375	12.25	12.25	10.00	7.00
89	6395	12.25	12.25	10.00	7.00
93	6415	12.25	12.25	10.00	7.00
97-113	6435-6515	NS	NS	NS	NS
117-128	6535-6590	13.00	12.25	9.25	6.25
129-160	6595-6750	13.00	12.25	9.25	6.25
160-181	6750-6855	13.75	12.25	9.25	6.25
185	6875	NS	NS	NS	NS
189-225	6895-7075	NS	NS	NS	NS
229	7095	NS	NS	NS	NS
233	7115	NS	NS	NS	NS

Table 110



6 GHz WLAN - 20 MHz - MIMO Core 0 - SDM - SP

Channel	Centre Frequency (MHz)	11ax/11be HE20 (2Tx, SDM, non TxBF) Low Rate	11ax/11be HE20 RU106 (2Tx, SDM, non TxBF)	11ax/11be HE20 RU52 (2Tx, SDM, non TxBF)	11ax/11be HE20 RU26 (2Tx, SDM, non TxBF)	11ax/11be HE20 (2Tx, TxBF) Low Rate
2	5935	NS	NS	NS	NS	NS
1	5955	12.75	12.75	12.75	10.00	12.75
5	5975	12.75	12.75	12.75	10.00	12.75
9-29	5995-6095	12.75	12.75	12.75	10.00	12.75
33-61	6115-6255	13.25	13.25	12.75	9.75	13.25
65-85	6275-6375	13.25	13.25	12.75	9.75	13.25
89	6395	13.25	13.25	12.75	9.75	13.25
93	6415	13.25	13.25	12.75	9.75	13.25
97-113	6435-6515	NS	NS	NS	NS	NS
117-128	6535-6590	12.00	12.00	12.00	9.00	12.00
129-160	6595-6750	11.75	11.75	11.75	9.00	11.75
160-181	6750-6855	12.00	12.00	12.00	9.00	12.00
185	6875	NS	NS	NS	NS	NS
189-225	6895-7075	NS	NS	NS	NS	NS
229	7095	NS	NS	NS	NS	NS
233	7115	NS	NS	NS	NS	NS

Table 111



6 GHz WLAN - 20 MHz - MIMO Core 1 - SDM - SP

Channel	Centre Frequency (MHz)	11ax/11be HE20 (2Tx, SDM, non TxBF) Low Rate	11ax/11be HE20 RU106 (2Tx, SDM, non TxBF)	11ax/11be HE20 RU52 (2Tx, SDM, non TxBF)	11ax/11be HE20 RU26 (2Tx, SDM, non TxBF)	11ax/11be HE20 (2Tx, TxBF) Low Rate
2	5935	NS	NS	NS	NS	NS
1	5955	11.75	11.75	11.75	10.00	11.75
5	5975	11.75	11.75	11.75	10.00	11.75
9-29	5995-6095	11.75	11.75	11.75	10.00	11.75
33-61	6115-6255	12.25	12.25	12.25	9.75	12.25
65-85	6275-6375	12.25	12.25	12.25	9.75	12.25
89	6395	12.25	12.25	12.25	9.75	12.25
93	6415	12.25	12.25	12.25	9.75	12.25
97-113	6435-6515	NS	NS	NS	NS	NS
117-128	6535-6590	13.00	13.00	12.00	9.00	13.00
129-160	6595-6750	13.00	13.00	12.00	9.00	13.00
160-181	6750-6855	13.75	13.75	12.00	9.00	13.75
185	6875	NS	NS	NS	NS	NS
189-225	6895-7075	NS	NS	NS	NS	NS
229	7095	NS	NS	NS	NS	NS
233	7115	NS	NS	NS	NS	NS

Table 112



6 GHz WLAN - 40 MHz - SISO Core 0 - SP

Channel	Frequency (MHz)	11ax HE40 (SISO) Low Rate	11ax HE40 RU106 (SISO)	11ax HE40 RU52 (SISO)	11ax HE40 RU26 (SISO)
3	5965	12.75	12.75	12.75	10.50
11	6005	12.75	12.75	12.75	10.50
19-27	6045-6085	12.75	12.75	12.75	10.50
35-59	6125-6245	13.25	13.25	13.25	10.50
67-75	6285-6325	13.25	13.25	13.25	10.50
83	6365	13.25	13.25	13.25	10.50
91	6405	13.25	13.25	13.25	10.50
99-107	6445-6485	NS	NS	NS	NS
115	6525	NS	NS	NS	NS
123-128	6565-6590	12.00	12.00	12.00	10.50
129-160	6595-6750	11.75	11.75	11.75	10.50
161-179	6755-6845	12.00	12.00	12.00	10.50
187	6885	NS	NS	NS	NS
195-219	6925-7045	NS	NS	NS	NS
227	7085	NS	NS	NS	NS

Table 113

6 GHz WLAN - 40 MHz - SISO Core 1 - SP

Channel	Frequency (MHz)	11ax HE40 (SISO) Low Rate	11ax HE40 RU106 (SISO)	11ax HE40 RU52 (SISO)	11ax HE40 RU26 (SISO)
3	5965	11.75	11.75	11.75	10.50
11	6005	11.75	11.75	11.75	10.50
19-27	6045-6085	11.75	11.75	11.75	10.50
35-59	6125-6245	12.25	12.25	12.25	10.50
67-75	6285-6325	12.25	12.25	12.25	10.50
83	6365	12.25	12.25	12.25	10.50
91	6405	12.25	12.25	12.25	10.50
99-107	6445-6485	NS	NS	NS	NS
115	6525	NS	NS	NS	NS
123-128	6565-6590	13.00	13.00	13.00	10.50
129-160	6595-6750	13.00	13.00	13.00	10.50
161-179	6755-6845	13.75	13.75	13.50	10.50
187	6885	NS	NS	NS	NS
195-219	6925-7045	NS	NS	NS	NS
227	7085	NS	NS	NS	NS

Table 114



6 GHz WLAN - 40MHz - MIMO Core 0 - CDD - SP

Channel	Frequency (MHz)	11ax/11be HE40 (2Tx, CDD, non TxBF) Low Rate	11ax/11be HE40 RU106 (2Tx, CDD, non TxBF)	11ax/11be HE40 RU52 (2Tx, CDD, non TxBF)	11ax/11be HE40 RU26 (2Tx, CDD, non TxBF)
3	5965	12.75	12.75	10.25	7.25
11	6005	12.75	12.75	10.25	7.25
19-27	6045-6085	12.75	12.75	10.25	7.25
35-59	6125-6245	13.25	12.75	9.75	6.75
67-75	6285-6325	13.25	13.00	10.00	7.00
83	6365	13.25	13.00	10.00	7.00
91	6405	13.25	13.00	10.00	7.00
99-107	6445-6485	NS	NS	NS	NS
115	6525	NS	NS	NS	NS
123-128	6565-6590	12.00	12.00	9.25	6.25
129-160	6595-6750	11.75	11.75	9.25	6.25
161-179	6755-6845	12.00	12.00	9.25	6.25
187	6885	NS	NS	NS	NS
195-219	6925-7045	NS	NS	NS	NS
227	7085	NS	NS	NS	NS

Table 115

6 GHz WLAN - 40 MHz - MIMO Core 1 - CDD - SP

Channel	Centre Frequency (MHz)	11ax/11be HE40 (2Tx, CDD, non TxBF) Low Rate	11ax/11be HE40 RU106 (2Tx, CDD, non TxBF)	11ax/11be HE40 RU52 (2Tx, CDD, non TxBF)	11ax/11be HE40 RU26 (2Tx, CDD, non TxBF)
3	5965	11.75	11.75	10.25	7.25
11	6005	11.75	11.75	10.25	7.25
19-27	6045-6085	11.75	11.75	10.25	7.25
35-59	6125-6245	12.25	12.25	9.75	6.75
67-75	6285-6325	12.25	12.25	10.00	7.00
83	6365	12.25	12.25	10.00	7.00
91	6405	12.25	12.25	10.00	7.00
99-107	6445-6485	NS	NS	NS	NS
115	6525	NS	NS	NS	NS
123-128	6565-6590	13.00	12.25	9.25	6.25
129-160	6595-6750	13.00	12.25	9.25	6.25
161-179	6755-6845	13.75	12.25	9.25	6.25
187	6885	NS	NS	NS	NS
195-219	6925-7045	NS	NS	NS	NS
227	7085	NS	NS	NS	NS

Table 116



6 GHz WLAN - 40 MHz - MIMO Core 0 - SDM - SP

Channel	Centre Frequency (MHz)	11ax/11be HE40 (2Tx, SDM, non TxBF) Low Rate	11ax/11be HE40 RU106 (2Tx, SDM, non TxBF)	11ax/11be HE40 RU52 (2Tx, SDM, non TxBF)	11ax/11be HE40 RU26 (2Tx, SDM, non TxBF)	11ax/11be HE40 (2Tx, TxBF) Low Rate
3	5965	12.75	12.75	12.75	10.00	12.75
11	6005	12.75	12.75	12.75	10.00	12.75
19-27	6045-6085	12.75	12.75	12.75	10.00	12.75
35-59	6125-6245	13.25	13.25	12.75	9.75	13.25
67-75	6285-6325	13.25	13.25	12.75	9.75	13.25
83	6365	13.25	13.25	12.75	9.75	13.25
91	6405	13.25	13.25	12.75	9.75	13.25
99-107	6445-6485	NS	NS	NS	NS	NS
115	6525	NS	NS	NS	NS	NS
123-128	6565-6590	12.00	12.00	12.00	9.00	12.00
129-160	6595-6750	11.75	11.75	11.75	9.00	11.75
161-179	6755-6845	12.00	12.00	12.00	9.00	12.00
187	6885	NS	NS	NS	NS	NS
195-219	6925-7045	NS	NS	NS	NS	NS
227	7085	NS	NS	NS	NS	NS

Table 117



6 GHz WLAN - 40 MHz - MIMO Core 1 - SDM - SP

Channel	Centre Frequency (MHz)	11ax/11be HE40 (2Tx, SDM, non TxBF) Low Rate	11ax/11be HE40 RU106 (2Tx, SDM, non TxBF)	11ax/11be HE40 RU52 (2Tx, SDM, non TxBF)	11ax/11be HE40 RU26 (2Tx, SDM, non TxBF)	11ax/11be HE40 (2Tx, TxBF) Low Rate
3	5965	11.75	11.75	11.75	10.00	11.75
11	6005	11.75	11.75	11.75	10.00	11.75
19-27	6045-6085	11.75	11.75	11.75	10.00	11.75
35-59	6125-6245	12.25	12.25	12.25	9.75	12.25
67-75	6285-6325	12.25	12.25	12.25	9.75	12.25
83	6365	12.25	12.25	12.25	9.75	12.25
91	6405	12.25	12.25	12.25	9.75	12.25
99-107	6445-6485	NS	NS	NS	NS	NS
115	6525	NS	NS	NS	NS	NS
123-128	6565-6590	13.00	13.00	12.00	9.00	13.00
129-160	6595-6750	13.00	13.00	12.00	9.00	13.00
161-179	6755-6845	13.75	13.75	12.00	9.00	13.75
187	6885	NS	NS	NS	NS	NS
195-219	6925-7045	NS	NS	NS	NS	NS
227	7085	NS	NS	NS	NS	NS

Table 118



6 GHz WLAN - 80 MHz - SISO Core 0 - SP

Channel	Centre Frequency (MHz)	11ax/11be HE80 (SISO) Low Rate	11ax/11be HE80 RU106 (SISO)	11ax/11be HE80 RU52 (SISO)	11ax/11be HE80 RU26 (SISO)
7	5985	12.75	12.75	10.50	7.50
23	6065	12.75	12.75	10.50	7.50
39-55	6145-6225	13.25	13.25	10.50	7.50
71	6305	13.25	13.25	10.50	7.50
87	6385	13.25	13.25	10.50	7.50
103	6465	NS	NS	NS	NS
119	6545	NS	NS	NS	NS
135-160	6625-6745	11.75	11.75	10.50	7.50
161-167	6755-6785	12.00	12.00	10.50	7.50
183	6865	NS	NS	NS	NS
199	6945	NS	NS	NS	NS
215	7025	NS	NS	NS	NS

Table 119

6 GHz WLAN - 80 MHz - SISO Core 1 - SP

Channel	Centre Frequency (MHz)	11ax/11be HE80 (SISO) Low Rate	11ax/11be HE80 RU106 (SISO)	11ax/11be HE80 RU52 (SISO)	11ax/11be HE80 RU26 (SISO)
7	5985	11.75	11.75	10.50	7.50
23	6065	11.75	11.75	10.50	7.50
39-55	6145-6225	12.25	12.25	10.50	7.50
71	6305	12.25	12.25	10.50	7.50
87	6385	12.25	12.25	10.50	7.50
103	6465	NS	NS	NS	NS
119	6545	NS	NS	NS	NS
135-160	6625-6745	13.00	13.00	10.50	7.50
161-167	6755-6785	13.75	13.50	10.50	7.50
183	6865	NS	NS	NS	NS
199	6945	NS	NS	NS	NS
215	7025	NS	NS	NS	NS

Table 120



6 GHz WLAN - 80 MHz - MIMO Core 0 - CDD - SP

Channel	Centre Frequency (MHz)	11ax/11be HE80 (2Tx, SDM, non TxBF) Low Rate	11ax/11be HE80 RU106 (2Tx, SDM, non TxBF)	11ax/11be HE80 RU52 (2Tx, SDM, non TxBF)	11ax/11be HE80 RU26 (2Tx, SDM, non TxBF)
7	5985	12.75	12.75	10.50	7.50
23	6065	12.75	12.75	10.50	7.50
39-55	6145-6225	13.25	13.25	10.50	7.50
71	6305	13.25	13.25	10.50	7.50
87	6385	13.25	13.25	10.50	7.50
103	6465	NS	NS	NS	NS
119	6545	NS	NS	NS	NS
135-160	6625-6745	11.75	11.75	10.50	7.50
161-167	6755-6785	12.00	12.00	10.50	7.50
183	6865	NS	NS	NS	NS
199	6945	NS	NS	NS	NS
215	7025	NS	NS	NS	NS

Table 121

6 GHz WLAN - 80 MHz - MIMO Core 1 - CDD - SP

Channel	Centre Frequency (MHz)	11ax/11be HE80 (2Tx, SDM, non TxBF) Low Rate	11ax/11be HE80 RU106 (2Tx, SDM, non TxBF)	11ax/11be HE80 RU52 (2Tx, SDM, non TxBF)	11ax/11be HE80 RU26 (2Tx, SDM, non TxBF)
7	5985	11.75	11.75	10.50	7.50
23	6065	11.75	11.75	10.50	7.50
39-55	6145-6225	12.25	12.25	10.50	7.50
71	6305	12.25	12.25	10.50	7.50
87	6385	12.25	12.25	10.50	7.50
103	6465	NS	NS	NS	NS
119	6545	NS	NS	NS	NS
135-160	6625-6745	13.00	13.00	10.50	7.50
161-167	6755-6785	13.75	13.50	10.50	7.50
183	6865	NS	NS	NS	NS
199	6945	NS	NS	NS	NS
215	7025	NS	NS	NS	NS

Table 122



6 GHz WLAN - 80 MHz - MIMO Core 0 - SDM - SP

Channel	Centre Frequency (MHz)	11ax/11be HE80 (2Tx, CDD, non TxBF) Low Rate	11ax/11be HE80 RU106 (2Tx, CDD, non TxBF)	11ax/11be HE80 RU52 (2Tx, CDD, non TxBF)	11ax/11be HE80 RU26 (2Tx, CDD, non TxBF)
7	5985	12.75	12.75	10.25	7.25
23	6065	12.75	12.75	10.25	7.25
39-55	6145-6225	13.25	12.75	9.75	6.75
71	6305	13.25	13.00	10.00	7.00
87	6385	13.25	13.00	10.00	7.00
103	6465	NS	NS	NS	NS
119	6545	NS	NS	NS	NS
135-160	6625-6745	11.75	11.75	9.25	6.25
161-167	6755-6785	12.00	12.00	9.25	6.25
183	6865	NS	NS	NS	NS
199	6945	NS	NS	NS	NS
215	7025	NS	NS	NS	NS

Table 123

6 GHz WLAN - 80 MHz - MIMO Core 1 - SDM - SP

Channel	Centre Frequency (MHz)	11ax/11be HE80 (2Tx, CDD, non TxBF) Low Rate	11ax/11be HE80 RU106 (2Tx, CDD, non TxBF)	11ax/11be HE80 RU52 (2Tx, CDD, non TxBF)	11ax/11be HE80 RU26 (2Tx, CDD, non TxBF)
7	5985	11.75	11.75	10.25	7.25
23	6065	11.75	11.75	10.25	7.25
39-55	6145-6225	12.25	12.25	9.75	6.75
71	6305	12.25	12.25	10.00	7.00
87	6385	12.25	12.25	10.00	7.00
103	6465	NS	NS	NS	NS
119	6545	NS	NS	NS	NS
135-160	6625-6745	13.00	12.25	9.25	6.25
161-167	6755-6785	13.75	12.25	9.25	6.25
183	6865	NS	NS	NS	NS
199	6945	NS	NS	NS	NS
215	7025	NS	NS	NS	NS

Table 124



6 GHz WLAN - 160 MHz - SISO Core 0 - SP

Channel	Frequency (MHz)	11ax/11be HE160 (SISO) Low Rate	11ax/11be HE160 RU106 (SISO)	11ax/11be HE160 RU52 (SISO)	11ax/11be HE160 RU26 (SISO)
15	6025	12.75	10.50	7.50	4.50
47	6185	13.25	10.50	7.50	4.50
79	6345	13.25	10.50	7.50	4.50
111	6505	NS	NS	NS	NS
143	6665	11.75	10.50	7.50	4.50
175	6825	NS	NS	NS	NS
207	6985	NS	NS	NS	NS

Table 125

6 GHz WLAN - 160 MHz - SISO Core 1 - SP

Channel	Frequency (MHz)	11ax/11be HE160 (SISO) Low Rate	11ax/11be HE160 RU106 (SISO)	11ax/11be HE160 RU52 (SISO)	11ax/11be HE160 RU26 (SISO)
15	6025	11.75	10.50	7.50	4.50
47	6185	12.25	10.50	7.50	4.50
79	6345	12.25	10.50	7.50	4.50
111	6505	NS	NS	NS	NS
143	6665	13.00	10.50	7.50	4.50
175	6825	NS	NS	NS	NS
207	6985	NS	NS	NS	NS

Table 126

6 GHz WLAN - 160 MHz - MIMO Core 0 - CDD - SP

Channel	Frequency (MHz)	11ax/11be HE160 (2Tx, CDD, non TxBF) Low Rate	11ax/11be HE160 RU106 (2Tx, CDD, non TxBF)	11ax/11be HE160 RU52 (2Tx, CDD, non TxBF)	11ax/11be HE160 RU26 (2Tx, CDD, non TxBF)
15	6025	12.75	10.50	7.50	4.50
47	6185	13.25	10.50	7.50	4.50
79	6345	13.25	10.50	7.50	4.50
111	6505	NS	NS	NS	NS
143	6665	11.75	10.50	7.50	4.50
175	6825	NS	NS	NS	NS
207	6985	NS	NS	NS	NS

Table 127



6 GHz WLAN - 160 MHz - MIMO Core 1 - CDD - SP

Channel	Frequency (MHz)	11ax/11be HE160 (2Tx, CDD, non TxBF) Low Rate	11ax/11be HE160 RU106 (2Tx, CDD, non TxBF)	11ax/11be HE160 RU52 (2Tx, CDD, non TxBF)	11ax/11be HE160 RU26 (2Tx, CDD, non TxBF)
15	6025	11.75	10.50	7.50	4.50
47	6185	12.25	10.50	7.50	4.50
79	6345	12.25	10.50	7.50	4.50
111	6505	NS	NS	NS	NS
143	6665	13.00	10.50	7.50	4.50
175	6825	NS	NS	NS	NS
207	6985	NS	NS	NS	NS

Table 128

6 GHz WLAN - 160 MHz - MIMO Core 0 - SDM - SP

Channel	Frequency (MHz)	11ax/11be HE160 (2Tx, SDM, non TxBF) Low Rate	11ax/11be HE160 RU106 (2Tx, SDM, non TxBF)	11ax/11be HE160 RU52 (2Tx, SDM, non TxBF)	11ax/11be HE160 RU26 (2Tx, SDM, non TxBF)
15	6025	12.75	10.50	7.50	4.50
47	6185	13.25	10.50	7.50	4.50
79	6345	13.25	10.50	7.50	4.50
111	6505	NS	NS	NS	NS
143	6665	11.75	10.50	7.50	4.50
175	6825	NS	NS	NS	NS
207	6985	NS	NS	NS	NS

Table 129

6 GHz WLAN - 160 MHz - MIMO Core 1 - SDM - SP

Channel	Frequency (MHz)	11ax/11be HE160 (2Tx, SDM, non TxBF) Low Rate	11ax/11be HE160 RU106 (2Tx, SDM, non TxBF)	11ax/11be HE160 RU52 (2Tx, SDM, non TxBF)	11ax/11be HE160 RU26 (2Tx, SDM, non TxBF)
15	6025	11.75	10.50	7.50	4.50
47	6185	12.25	10.50	7.50	4.50
79	6345	12.25	10.50	7.50	4.50
111	6505	NS	NS	NS	NS
143	6665	13.00	10.50	7.50	4.50
175	6825	NS	NS	NS	NS
207	6985	NS	NS	NS	NS

Table 130



1.7 CONDUCTED POWER MEASUREMENTS

1.7.1 Method

Conducted Power Measurements were made using a power meter.

Bluetooth (When 5 GHz WLAN OFF)

(BT Core 0 - ePA)

Technology	Channel	Modulation	Duty Cycle (%)	Packet Type	Frequency (MHz)	Measured Power (dBm)	Tune Up (dBm)
EDR	0	GFSK	77	3-DH5	2402	15.955	16.50
EDR	39	GFSK	77	3-DH5	2441	15.977	16.50
EDR	78	GFSK	77	3-DH5	2480	15.854	16.50

Table 131

(BT Core 1 - ePA)

Technology	Channel	Modulation	Duty Cycle (%)	Packet Type	Frequency (MHz)	Measured Power (dBm)	Tune Up (dBm)
EDR	0	GFSK	77	3-DH5	2402	15.94	16.50
EDR	39	GFSK	77	3-DH5	2441	16.22	16.50
EDR	78	GFSK	77	3-DH5	2480	16.05	16.50

Table 132

(BT Core 2 - iPA)

Technology	Channel	Modulation	Duty Cycle (%)	Packet Type	Frequency (MHz)	Measured Power (dBm)	Tune Up (dBm)
BDR	0	GFSK	77	3-DH5	2402	11.71	12.00
BDR	39	GFSK	77	3-DH5	2441	11.77	12.00
BDR	78	GFSK	77	3-DH5	2480	11.70	12.00

Table 133

Bluetooth (When 5 GHz WLAN ON)

(BT Core 0 - ePA)

Technology	Channel	Modulation	Duty Cycle (%)	Packet Type	Frequency (MHz)	Measured Power (dBm)	Tune Up (dBm)
EDR	0	GFSK	77	3-DH5	2402	15.96	16.00
EDR	39	GFSK	77	3-DH5	2441	15.98	16.00
EDR	78	GFSK	77	3-DH5	2480	15.85	16.00

Table 134



(BT Core 1 - ePA)

Technology	Channel	Modulation	Duty Cycle (%)	Packet Type	Frequency (MHz)	Measured Power (dBm)	Tune Up (dBm)
EDR	0	GFSK	77	3-DH5	2402	15.53	16.00
EDR	39	GFSK	77	3-DH5	2441	15.56	16.00
EDR	78	GFSK	77	3-DH5	2480	15.38	16.00

Table 135

(BT Core 2 - iPA)

Technology	Channel	Modulation	Duty Cycle (%)	Packet Type	Frequency (MHz)	Measured Power (dBm)	Tune Up (dBm)
BDR	0	GFSK	77	3-DH5	2402	11.71	12.00
BDR	39	GFSK	77	3-DH5	2441	11.77	12.00
BDR	78	GFSK	77	3-DH5	2480	11.70	12.00

Table 136

Narrowband UNII-1 - When 2.4 GHz WLAN OFF

(UNII-1 - Core 0)

Technology	Channel	Modulation	Duty Cycle (%)	Packet Type	Frequency (MHz)	Measured Power (dBm)	Tune Up (dBm)
HDR8	Bottom	8-DPSK	78	8DH5	5150	13.92	14.00
HDR8	Middle	8-DPSK	78	8DH5	5200	13.76	14.00
HDR8	Top	8-DPSK	78	8DH5	5250	13.66	14.00

Table 137

(UNII-1 - Core 1)

Technology	Channel	Modulation	Duty Cycle (%)	Packet Type	Frequency (MHz)	Measured Power (dBm)	Tune Up (dBm)
HDR8	Bottom	8-DPSK	78	8DH5	5150	13.36	14.00
HDR8	Middle	8-DPSK	78	8DH5	5200	13.57	14.00
HDR8	Top	8-DPSK	78	8DH5	5250	13.61	14.00

Table 138



Narrowband UNII-1 - When 2.4 GHz WLAN ON

(UNII-1 - Core 0)

Technology	Channel	Modulation	Duty Cycle (%)	Packet Type	Frequency (MHz)	Measured Power (dBm)	Tune Up (dBm)
HDR8	Bottom	8-DPSK	78	8DH5	5150	10.99	11.00
HDR8	Middle	8-DPSK	78	8DH5	5200	10.91	11.00
HDR8	Top	8-DPSK	78	8DH5	5250	10.81	11.00

Table 139

(UNII-1 - Core 1)

Technology	Channel	Modulation	Duty Cycle (%)	Packet Type	Frequency (MHz)	Measured Power (dBm)	Tune Up (dBm)
HDR8	Bottom	8-DPSK	78	8DH5	5150	10.52	11.00
HDR8	Middle	8-DPSK	78	8DH5	5200	10.56	11.00
HDR8	Top	8-DPSK	78	8DH5	5250	10.72	11.00

Table 140

Narrowband U-NII-3- When 2.4 GHz WLAN OFF

(UNII-3 - Core 0)

Technology	Channel	Modulation	Duty Cycle (%)	Packet Type	Frequency (MHz)	Measured Power (dBm)	Tune Up (dBm)
HDR4	Bottom	8-DPSK	78	4DH5	5725	14.48	14.50
HDR4	Middle	8-DPSK	78	4DH5	5788	14.41	14.50
HDR4	Top	8-DPSK	78	4DH5	5850	14.06	14.50

Table 141

(UNII-3 - Core 1)

Technology	Channel	Modulation	Duty Cycle (%)	Packet Type	Frequency (MHz)	Measured Power (dBm)	Tune Up (dBm)
HDR4	Bottom	8-DPSK	78	4DH5	5725	14.43	14.50
HDR4	Middle	8-DPSK	78	4DH5	5788	14.48	14.50
HDR4	Top	8-DPSK	78	4DH5	5850	13.86	14.50

Table 142



Narrowband U-NII-3 - When 2.4 GHz WLAN ON

(UNII-3 - Core 0)

Technology	Channel	Modulation	Duty Cycle (%)	Packet Type	Frequency (MHz)	Measured Power (dBm)	Tune Up (dBm)
HDR4	Bottom	8-DPSK	78	4DH5	5725	10.90	11.00
HDR4	Middle	8-DPSK	78	4DH5	5788	10.94	11.00
HDR4	Top	8-DPSK	78	4DH5	5850	10.99	11.00

Table 143

(UNII-3 - Core 1)

Technology	Channel	Modulation	Duty Cycle (%)	Packet Type	Frequency (MHz)	Measured Power (dBm)	Tune Up (dBm)
HDR4	Bottom	8-DPSK	78	4DH5	5725	10.93	11.00
HDR4	Middle	8-DPSK	78	4DH5	5788	10.99	11.00
HDR4	Top	8-DPSK	78	4DH5	5850	10.75	11.00

Table 144

Thread (When 5 GHz WLAN OFF)

(Core 0 - ePA)

Technology	Channel	Modulation	Duty Cycle (%)	Packet Type	Frequency (MHz)	Measured Power (dBm)	Tune Up (dBm)
Thread	11	OQPSK	60.96	N/A	2405	19.84	20.00
Thread	18	OQPSK	60.96	N/A	2440	19.82	20.00
Thread	26	OQPSK	60.96	N/A	2480	19.94	20.00

Table 145

(Core 1 - ePA)

Technology	Channel	Modulation	Duty Cycle (%)	Packet Type	Frequency (MHz)	Measured Power (dBm)	Tune Up (dBm)
Thread	11	OQPSK	60.96	N/A	2405	19.59	20.00
Thread	18	OQPSK	60.96	N/A	2440	20.00	20.00
Thread	26	OQPSK	60.96	N/A	2480	19.91	20.00

Table 146



(Core 2 - iPA)

Technology	Channel	Modulation	Duty Cycle (%)	Packet Type	Frequency (MHz)	Measured Power (dBm)	Tune Up (dBm)
Thread	11	OQPSK	60.96	N/A	2405	12.31	12.50
Thread	18	OQPSK	60.96	N/A	2440	12.37	12.50
Thread	26	OQPSK	60.96	N/A	2480	12.41	12.50

Table 147

Thread (When 5 GHz WLAN ON)

(Core 0 - ePA)

Technology	Channel	Modulation	Duty Cycle (%)	Packet Type	Frequency (MHz)	Measured Power (dBm)	Tune Up (dBm)
Thread	11	OQPSK	60.96	N/A	2405	15.95	16.00
Thread	18	OQPSK	60.96	N/A	2440	15.46	16.00
Thread	26	OQPSK	60.96	N/A	2480	15.54	16.00

Table 148

(Core 1 - ePA)

Technology	Channel	Modulation	Duty Cycle (%)	Packet Type	Frequency (MHz)	Measured Power (dBm)	Tune Up (dBm)
Thread	11	OQPSK	60.96	N/A	2405	15.49	16.00
Thread	18	OQPSK	60.96	N/A	2440	15.59	16.00
Thread	26	OQPSK	60.96	N/A	2480	15.64	16.00

Table 149

(Core 2 - iPA)

Technology	Channel	Modulation	Duty Cycle (%)	Packet Type	Frequency (MHz)	Measured Power (dBm)	Tune Up (dBm)
Thread	11	OQPSK	60.96	N/A	2405	12.31	12.50
Thread	18	OQPSK	60.96	N/A	2440	12.37	12.50
Thread	26	OQPSK	60.96	N/A	2480	12.41	12.50

Table 150



WLAN 2.4 GHz - SISO

(Core 0)

Technology	Channel	Modulation	Duty Cycle (%)	Rate (Mbps)	Frequency (MHz)	Measured Power (dBm)	Tune Up (dBm)
802.11g	2	BPSK	100	6.0	2417	19.04	19.50
802.11g	6	BPSK	100	6.0	2437	19.11	19.50
802.11g	10	BPSK	100	6.0	2457	18.99	19.50

Table 151

(Core 1)

Technology	Channel	Modulation	Duty Cycle (%)	Rate (Mbps)	Frequency (MHz)	Measured Power (dBm)	Tune Up (dBm)
802.11g	2	BPSK	100	6.0	2417	19.59	20.00
802.11g	6	BPSK	100	6.0	2437	19.60	20.00
802.11g	10	BPSK	100	6.0	2457	19.50	20.00

Table 152

WLAN 2.4 GHz - SISO

(Core 0)

Technology	Channel	Modulation	Duty Cycle (%)	Rate (Mbps)	Frequency (MHz)	Measured Power (dBm)	Tune Up (dBm)
802.11b	1	BPSK	100	1.0	2412	18.82	19.00
802.11b	6	BPSK	100	1.0	2437	18.58	19.00
802.11b	11	BPSK	100	1.0	2462	18.84	19.00

Table 153

(Core 1)

Technology	Channel	Modulation	Duty Cycle (%)	Rate (Mbps)	Frequency (MHz)	Measured Power (dBm)	Tune Up (dBm)
802.11b	1	BPSK	100	1.0	2412	18.50	19.00
802.11b	6	BPSK	100	1.0	2437	18.64	19.00
802.11b	11	BPSK	100	1.0	2462	18.53	19.00

Table 154



WLAN 2.4 GHz - (2TX, non TXBF) MIMO

Technology	Channel	Modulation	Duty Cycle (%)	Rate (Mbps)	Frequency (MHz)	Measured Power (dBm)	Tune Up (dBm)
802.11n/ac HT20 (Core 0)	2	BPSK	100	6.5	2417	18.94	19.50
802.11n/ac HT20 (Core 1)	2	BPSK	100	6.5	2417	19.28	20.00
802.11n/ac HT20 (Core 0)	6	BPSK	100	6.5	2437	18.81	19.50
802.11n/ac HT20 (Core 1)	6	BPSK	100	6.5	2437	19.52	20.00
802.11n/ac HT20 (Core 0)	10	BPSK	100	6.5	2457	18.96	19.50
802.11n/ac HT20 (Core 1)	10	BPSK	100	6.5	2457	19.58	20.00

Table 155



WLAN U-NII 1/2A - 5.2/5.3 GHz SISO

(Core 0)

Technology	Channel	Modulation	Duty Cycle (%)	Rate/MCS	Frequency (MHz)	Measured Power (dBm)	Tune Up (dBm)
802.11ac VHT80	42	BPSK	100	0	5210	14.39	14.75
802.11ac VHT80	58	BPSK	100	0	5290	13.34	13.75

Table 156

(Core 1)

Technology	Channel	Modulation	Duty Cycle (%)	Rate/MCS	Frequency (MHz)	Measured Power (dBm)	Tune Up (dBm)
802.11ac VHT80	42	BPSK	100	0	5210	13.82	14.50
802.11n/ac HT40	54	BPSK	100	0	5270	13.89	14.50

Table 157

WLAN U-NII 1/2A - 5.2/5.3 GHz MIMO

Technology	Channel	Modulation	Duty Cycle (%)	Rate/MCS	Frequency (MHz)	Measured Power (dBm)	Tune Up (dBm)
802.11n/ac HT40	38	BPSK	100	0	5190	13.83	14.75
802.11n/ac HT40	38	BPSK	100	0	5190	13.90	14.50
802.11n/ac HT40	46	BPSK	100	0	5230	14.06	14.75
802.11n/ac HT40	46	BPSK	100	0	5230	14.07	14.50
802.11n/ac HT40	54	BPSK	100	0	5270	12.93	13.75
802.11n/ac HT40	54	BPSK	100	0	5270	13.45	14.50
802.11n/ac HT40	62	BPSK	100	0	5310	13.15	13.75
802.11n/ac HT40	62	BPSK	100	0	5310	13.39	14.50

Table 158



WLAN U-NII 2C - 5.5 GHz SISO

(Core 0)

Technology	Channel	Modulation	Duty Cycle (%)	Rate/MCS	Frequency (MHz)	Measured Power (dBm)	Tune Up (dBm)
802.11ac VHT80	106	BPSK	100	0	5530	14.13	14.50
802.11ac VHT80	122	BPSK	100	0	5610	14.12	14.50
802.11ac VHT80	138	BPSK	100	0	5690	14.14	14.50

Table 159

(Core 1)

Technology	Channel	Modulation	Duty Cycle (%)	Rate/MCS	Frequency (MHz)	Measured Power (dBm)	Tune Up (dBm)
802.11ac VHT80	106	BPSK	100	0	5530	12.87	13.75
802.11ac VHT80	122	BPSK	100	0	5610	13.36	13.75
802.11ac VHT80	138	BPSK	100	0	5690	13.03	13.75

Table 160

WLAN U-NII 2C - 5.5 GHz (2Tx, CDD, non TxBF) MIMO

Technology	Channel	Modulation	Duty Cycle (%)	Rate/MCS	Frequency (MHz)	Measured Power (dBm)	Tune Up (dBm)
802.11n/ac HT40	102	BPSK	100	0	5510	13.37	14.50
802.11n/ac HT40	102	BPSK	100	0	5510	13.40	13.75
802.11n/ac HT40	110	BPSK	100	0	5550	13.35	14.50
802.11n/ac HT40	110	BPSK	100	0	5550	13.38	13.75
802.11ac VHT80	122	BPSK	100	0	5610	13.60	14.50
802.11ac VHT80	122	BPSK	100	0	5610	13.46	13.75
802.11ac VHT80	138	BPSK	100	0	5690	13.45	14.50
802.11ac VHT80	138	BPSK	100	0	5690	13.27	13.75

Table 161



WLAN U-NII 3 - 5.8GHz SISO

(Core 0)

Technology	Channel	Modulation	Duty Cycle (%)	Rate/MCS	Frequency (MHz)	Measured Power (dBm)	Tune Up (dBm)
802.11ac VHT80	155	BPSK	100	0	5775	14.25	14.75

Table 162

(Core 1)

Technology	Channel	Modulation	Duty Cycle (%)	Rate/MCS	Frequency (MHz)	Measured Power (dBm)	Tune Up (dBm)
802.11ac VHT80	155	BPSK	100	0	5775	12.91	14.00

Table 163

WLAN U-NII 3 - 5.8 GHz MIMO

Technology	Channel	Modulation	Duty Cycle (%)	Rate/MCS	Frequency (MHz)	Measured Power (dBm)	Tune Up (dBm)
802.11ac VHT80	155	BPSK	100	0	5775	13.75	14.75
802.11ac VHT80	155	BPSK	100	0	5775	13.54	14.00

Table 164

WLAN 6 GHz SISO

(Core 0)

Technology	Channel	Modulation	Duty Cycle (%)	Rate/MCS	Frequency (MHz)	Measured Power (dBm)	Tune Up (dBm)
802.11ax HE160	15	BPSK	100	0	6025	12.45	12.75
802.11ax HE160	47	BPSK	100	0	6185	13.05	13.25
802.11ax HE160	79	BPSK	100	0	6345	13.11	13.25
802.11ax HE160	143	BPSK	100	0	6665	11.56	11.75
802.11ax HE80	167	BPSK	100	0	6785	11.40	12.00

Table 165



(Core 1)

Technology	Channel	Modulation	Duty Cycle (%)	Rate/MCS	Frequency (MHz)	Measured Power (dBm)	Tune Up (dBm)
802.11ax HE160	15	BPSK	100	0	6025	11.35	11.75
802.11ax HE160	47	BPSK	100	0	6185	11.92	12.25
802.11ax HE160	79	BPSK	100	0	6345	12.15	12.25
802.11ax HE160	143	BPSK	100	0	6665	12.88	13.00
802.11ax HE80	167	BPSK	100	0	6785	13.10	13.75

Table 166

WLAN 6 GHz MIMO

Technology	Channel	Modulation	Duty Cycle (%)	Rate/MCS	Frequency (MHz)	Measured Power (dBm)	Tune Up (dBm)
802.11ax HE160 (Core 0)	15	BPSK	100	0	6025	11.40	12.75
802.11ax HE160 (Core 1)	15	BPSK	100	0	6025	11.48	11.75
802.11ax HE160 (Core 0)	47	BPSK	100	0	6185	12.97	13.25
802.11ax HE160 (Core 1)	47	BPSK	100	0	6185	12.12	12.25
802.11ax HE160 (Core 0)	79	BPSK	100	0	6345	12.87	13.25
802.11ax HE160 (Core 1)	79	BPSK	100	0	6345	11.92	12.25
802.11ax HE160 (Core 0)	143	BPSK	100	0	6665	11.65	11.75
802.11ax HE160 (Core 1)	143	BPSK	100	0	6665	11.68	13.00
802.11ax HE80 (Core 0)	167	BPSK	100	0	6785	11.50	12.00
802.11ax HE80 (Core 1)	167	BPSK	100	0	6785	12.95	13.75

Table 167



SECTION 2

TEST DETAILS

Specific Absorption Rate Testing of the A3112

2.1 DASY6 MEASUREMENT SYSTEM

2.1.1 System Description

The DASY6 system for performing compliance tests consists of the following items:

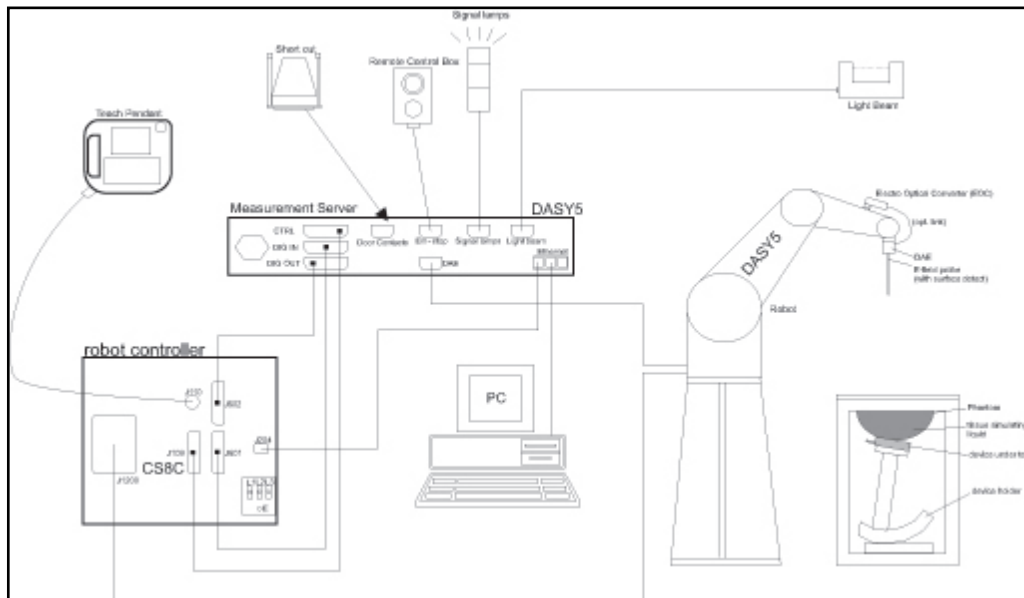

Figure 9 - System Description Diagram

A standard high precision 6-axis robot (Stäubli TX=RX family) with controller, teach pendant and software. An arm extension for accommodating the data acquisition electronics (DAE).

An isotropic field probe optimized and calibrated for the targeted measurement.

A data acquisition electronics (DAE) which performs the signal amplification, signal multiplexing, AD-conversion, offset measurements, mechanical surface detection, collision detection, etc. The unit is battery powered with standard or rechargeable batteries. The signal is optically transmitted to the EOC.

The Electro-optical converter (EOC) performs the conversion from optical to electrical signals for the digital communication to the DAE. To use optical surface detection, a special version of the EOC is required. The EOC signal is transmitted to the measurement server.

The function of the measurement server is to perform the time critical tasks such as signal filtering, control of the robot operation and fast movement interrupts.

The Light Beam used is for probe alignment. This improves the (absolute) accuracy of the probe positioning.

A computer running the DASY6 software to display and interact with the robot and information.

There is a remote control and a teach pendant as well as additional circuitry for robot safety such as warning lamps, etc.

The phantom, the device holder and other accessories according to the targeted measurement.



2.1.2 Probe Specification

The probes used by the DASY system are isotropic E-field probes, constructed with a symmetric design and a triangular core. The probes have built-in shielding against static charges and are contained within a PEEK enclosure material. These probes are specially designed and calibrated for use in liquids with high permittivity. The frequency range of the probes are from 6 MHz to 6 GHz.

2.1.3 Data Acquisition Electronics

The data acquisition electronics (DAE4 or DAE3) consist of a highly sensitive electrometer-grade preamplifier with auto-zeroing, a channel and gain-switching multiplexer, a fast 16 bit AD-converter and a command decoder with a control logic unit. Transmission to the measurement server is accomplished through an optical downlink for data and status information, as well as an optical uplink for commands and the clock.

The mechanical probe mounting device includes two different sensor systems for frontal and sideways probe contacts. They are used for mechanical surface detection and probe collision detection. The input impedance of both the DAE4 as well as of the DAE3 box is 200M Ω ; the inputs are symmetrical and floating. Common mode rejection is above 80 dB.

2.1.4 SAR Evaluation Description

The cDASY6 software includes all numerical procedures necessary to evaluate the spatial peak SAR values.

Fast Area Scan:

The Fast Area Scan provides an easy, time efficient and accurate way to define the optimal power reference location. The location of the power reference and power drift measurements for the subsequent Area, Fast Volume and Zoom Scans will be automatically set at the maximum of the Fast Area Scan.

Area Scan:

Area Scans are used to determine the peak location of the measured field before doing a finer measurement around the hotspot. Peak location can be found accurately even on coarse grids using the advanced interpolation routines implemented in cDASY6 Module SAR. Area Scans measure a two dimensional volume covering the full device under test area. cDASY6 Module SAR uses Fast Averaged SAR algorithm to compute the 1g and 10g of simulated tissue from the Area Scan.

Fast Volume Scans:

Fast Volume Scans are 3D scans used to assess the peak spatial SAR values within an averaging volume containing 1g and 10g of simulated tissue. It is compatible with any phantom. For regular phantoms, the measurement grid is generated by projecting a plane onto the phantom surface as for Area and Zoom scans. For specific phantoms, the measurement grid is generated by a conformal offset to the phantom surface at the desired distances. The grid extents can be set by the end user to cover the DUT dimensions or the whole measurable area of the phantom.



Zoom Scan:

Zoom scans are used to assess the peak spatial SAR values within a cubic averaging volume containing 1g and 10g of simulated tissue. Zoom scans measure a three dimensional volume (cube). The bottom face of the cube is Centred on the maximum of the preceding Area Scan in the same measurement group. For maxima at border of the phantom, the zoom scan can be enabled to automatically extend in order to ensure correct evaluation of peak spatial SAR.

Zoom Scans can be performed in two different modes:

- Smart Mode: the grid settings are adjusted on the fly based on the distribution being measured to fulfill to the IEC 62209-2 Amendment 1 criteria on grid resolution.
- Custom Mode: the user specifies the grid settings to be used. In both modes, Zoom Scans are always anchored to the peak location of the preceding Fast Area / Area / Fast Volume Scan.

2.1.5 DASY 6 Absorbed Power Density Evaluation

The DASY 6 measurement system will output the absorbed power density result values by default from version 16.0 of DASY software onwards. All the measurement details described in this section are utilised to collect the required data which is the converted automatically within the software and displayed for frequencies above 5.9 GHz.

2.2 DASY 6 mmWave PD Module

2.2.1 Measurement System

A DASY 6 Measurement System equipped with the DASY 6 mmWave module was used to carry out the peak spatially averaged power density (psPD) measurements. It consists of a 6-axis industrial robot and controller that provides a highly accurate positioning system, a PC for the system control software, a near field probe (EUmmWVx), a probe alignment sensor and the 5G phantom. The high accuracy positioning system places the near field probe at the key location points of the maximum electromagnetic field.

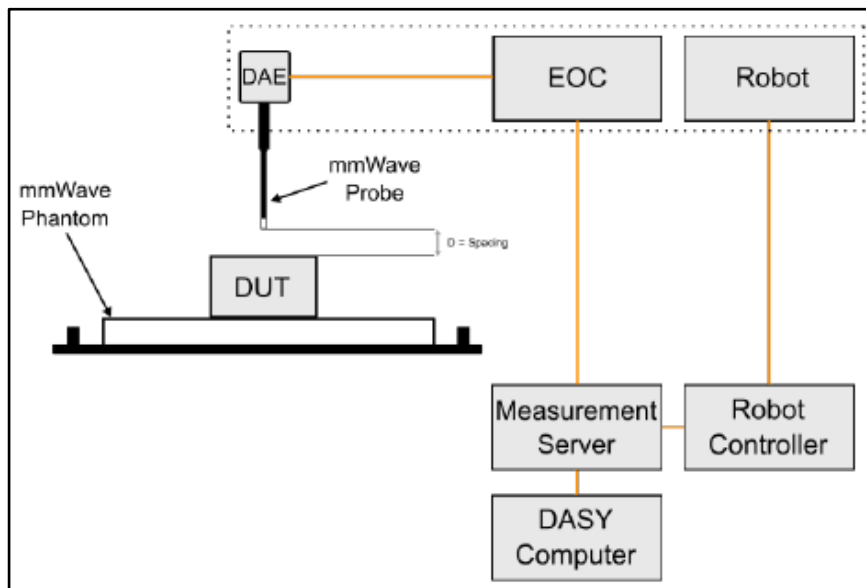

Figure 10 - Typical measurement setup for PD measurement with DASY 6

2.2.2 E UmmWVx E-Field Probe Details

The E UmmWVx probe utilises two dipole elements that are specifically arranged to allow for the generation of pseudo-vector data.

Frequency Range	750 MHz - 110 GHz
Dynamic Range	<20 V/m - 10'000 V/m with PRE-10 (min <20 V/m - 2000 V/m)
Position Precision	<0.2 mm (DASY6)
Dimensions	Overall length: 320 mm (tip: 20 mm) Tip and body diameter: encapsulation 8 mm (internal sensor <1mm) Distance from probe tip to sensor Y cal point:1.5 mm Distance from probe tip to sensor X cal point:1.5 mm
Applications	E-field measurements of 5G devices and other mm-wave transmitters operating above 10GHz in <2 mm distance from device (free-space) Power density, H-field, and far-field analysis using total field reconstruction.
Compatibility	cDASY6 + 5G-Module SW1.0 and higher

Table 1687

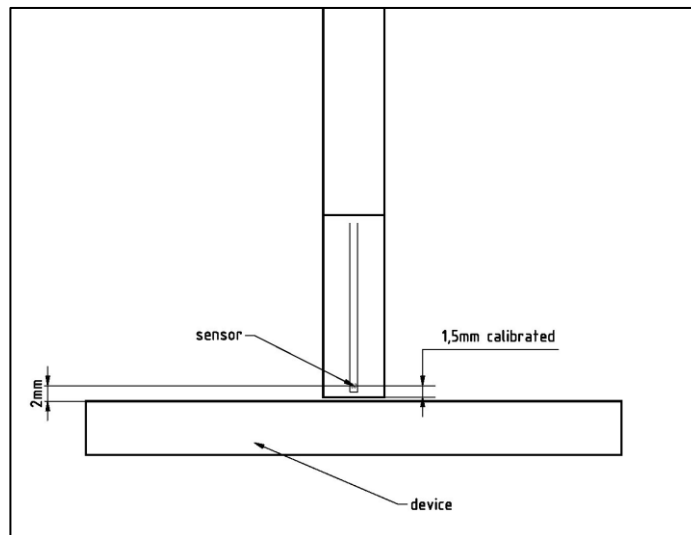

Figure 11 - Diagram of the distance sensor to the EUT surface

2.2.3 Peak Spatially Averaged Power Density Assessment based on E-Field Measurements

Power density was determined for both the electric and magnetic fields within a small distance from the transmitting source. In general, the magnitude and phase of two components of either E-field or H-field are needed on a sufficiently large surface to characterise their total distributions. Despite this being the case, a solution based on the direct measurement of the E and H field can be used to compute power density. The measurement approach to achieve this is given below.

- a) The local E-field is measured at a reference point on the measurement surface where the field is well above the system noise floor. This reference point is re-visited at the end of the measurement routine and re-measured to determine and assess the power drift of the EUT.
- b) The electric field on the measurement surface was scanned using instructions provided by the test system manufacturer. The spatial resolution of the measurement can depend on the measured field characteristic and measurement methodology used by the test system. The planar scan step size is configured to be $\lambda/4$.
- c) DASY6 uses a reconstruction algorithm to calculate the H-field from the measured E-field. As the power density calculation requires amplitude and phase, reconstruction algorithms can also be used to obtain field information from the measured E-field data, for example phase information from the amplitude if only the amplitude is measured. Three measurements per point on two measurement planes separated by $\lambda/4$ are carried out in order for the H-field and phase data to be reconstructed.
- d) Using the equation below the total peak spatially averaged power density (psPD) distribution on the evaluation surface can be determined. The applicable regulatory requirements specify the spatial averaging area A. A circular shape is used.

$$psPD = \frac{1}{2A_{av}} \iint_{A_{av}} ||Re\{E \times H^*\} || dA$$

- e) The final quantity used to determine compliance against the applicable limits is the maximum spatial average on the evaluation.
- f) Following the measurement of the power drift as described in step a) the drift was assessed. If the drift deviated by more than 5% then the power density test and drift measurements shall be repeated.

2.2.4 Reconstruction Algorithm

Computation of the PD in general requires knowledge of the electric (E-) and magnetic (H-) field amplitudes and phases in the plane of incidence. Reconstruction of these quantities from pseudo-vector E-field measurements is feasible, as they are constrained by Maxwell's equations.

The test system utilises a reconstruction approach based on the Gerchberg-Saxton algorithm which benefits from the availability of the E-field polarization ellipse information obtained with the EUmmWVx probe. This reconstruction algorithm, together with the ability of the probe to measure extremely close to the source without perturbing the field, permits reconstruction of the E- and H-fields and the PD on measurement planes located as near as $\lambda/2\pi$.

2.2.5 Standalone PD Limit

The following formula provides the reference levels for local exposure to electromagnetic fields from >6 GHz to 300GHz for general public as referenced in ICNIRP 2020:

$$55/f_G^{0.177}$$

The FCC Oct 2020 TCB workshop states their own incident power density limit of $1\text{mW}/\text{cm}^2$ plane-wave equivalent, averaged over 4 cm^2 as reflected in FCC 47 CFR 1.1310.

2.2.6 Exposure Ratio

The following formulas used to calculate the exposure ratio of SAR, APD and iPD respectively as referenced in ICNIRP 2020:

$$\begin{aligned} \text{SAR} & \sum_{i=100\text{ kHz}}^{300\text{ GHz}} \frac{\text{SAR}_i}{\text{SAR}_{\text{BR}}} \leq 1. \\ \text{APD} & \sum_{i>6\text{ GHz}}^{30\text{ GHz}} \frac{S_{\text{ab},4\text{cm},i}}{S_{\text{ab},4\text{cm},\text{BR}}} \leq 1. \\ \text{iPD} & \sum_{i>6\text{ GHz}}^{30\text{ GHz}} \left(\frac{S_{\text{inc},4\text{cm},i}}{S_{\text{inc},4\text{cm},\text{RL},i}} \right) \leq 1. \end{aligned}$$

2.2.7 Total Exposure Ratio (TER)

The total exposure ratio is the sum of local specific absorption rate (SAR), local absorbed power density (APD) and local incident power density (iPD) referenced in ICNIRP 2020:

where, SAR_i and SAR_{BR} are the local SAR level at frequency i and the local SAR basic restriction given in ICNIRP 2020. $S_{ab,4cm,i}$ and $S_{ab,4cm,BR}$ are the $4cm^2$ absorbed power density level at frequency i and the $4cm^2$ absorbed power density basic restriction given in ICNIRP 2020. $S_{inc,4cm,i}$ and $S_{inc,4cm,RL,i}$ are the local $4cm^2$ incident power density at frequency i and the local $4cm^2$ incident power density reference level at frequency i given in ICNIRP 2020.

$$\begin{aligned} & \sum_{i=100 \text{ kHz}}^{6 \text{ GHz}} \frac{SAR_i}{SAR_{BR}} \\ & + \sum_{i>6 \text{ GHz}}^{30 \text{ GHz}} \frac{S_{ab,4cm,i}}{S_{ab,4cm,BR}} \\ & + \sum_{i>6 \text{ GHz}}^{30 \text{ GHz}} \left(\frac{S_{inc,4cm,i}}{S_{inc,4cm,RL,i}} \right) \leq 1 \end{aligned}$$

TER is applied when simultaneous transmission of the different types of measurement is tested, and basic restriction limits cannot be applied. The TER of the applicable measurements is calculated and summed up to not exceed 1.



SECTION 3

TEST EQUIPMENT USED



3.1 TEST EQUIPMENT USED

The following test equipment was used at TÜV SÜD Product Service:

Instrument Description	Manufacturer	Model Type	TE Number	Cal Period (months)	Calibration Due Date
Directional Coupler	Hewlett Packard	11692D	452	-	TU
Hygrometer	Rotronic	I-1000	2829	12	21-May-2025
SAR 2450 MHz dipole	SPEAG	D2450V2	3875	12	07-Dec-2024
SAR 5GHz Dipole	SPEAG	D5GHzV2	4309	12	14-Dec-2024
Thermometer	LKM Electronics	DTM 3000	4697	12	04-Sep-2024
Dosimetric SAR Probe	SPEAG	EX3DV4	4700	12	14-Dec-2024
Network Analyser	Keysight Technologies	E5063A	5018	12	10-Oct-2024
Flat phantom (Body)	SPEAG	ELI v8.0	5332	-	TU
Measurement server	SPEAG	DASY 6	5337	-	TU
DASY 6 Robot	SPEAG	TX90 XL	5340	-	TU
Power Source for SAR	SPEAG	POWERSOURCE1-SE UMS 160 BA	5371	12	01-Dec-2024
SAR 6.5GHz dipole	SPEAG	D6.5GHzV2 SAAAD650AA	6157	12	04-Jul-2025
Thermo-hygrometer	R.S Components	1364	6352	12	13-Jun-2025
Isotropic E-field Probe	Schmid & Partner Engineering AG	UmmWV4	6353	12	24-Oct-2024
2m Coaxial Cable Assy	Junkosha	MWX221-02000AMSAMS/A	6361	12	16-May-2025
1m Coaxial Cable Assy	Junkosha	MWX221-01000AMSAMS/A	6378	12	16-May-2025
1m Coaxial Cable Assy	Junkosha	MWX221-01000AMSAMS/A	6380	12	16-May-2025
Flat phantom (Body)	SPEAG	ELI v8.0	6491	-	TU
DASY 8 Robot	SPEAG	TX2 90XL	6494	-	TU
Dosimetric SAR Probe	SPEAG	EX3DV4	6498	12	14-Feb-2025
Data Acquisition Electronics	SPEAG	DAE4ip	6500	12	13-Feb-2025
Data Acquisition Electronics	SPEAG	DAE4ip	6501	12	05-Aug-2024



Instrument Description	Manufacturer	Model Type	TE Number	Cal Period (months)	Calibration Due Date
Dielectric Assessment Kit	SPEAG	DAK-3.5	6502	-	TU
Power source for SAR system	SPEAG	POWERSOURCE1-SE UMS 160 CB	6503	12	01-Mar-2025
Diode Power Sensor	Rohde & Schwarz	NRP18S	6533	24	11-Apr-2026
Diode Power Sensor	Rohde & Schwarz	NRP18S	6534	24	17-Apr-2025
Power Meter	Rohde & Schwarz	NRX	6535	-	TU
Amplifier	Mini-Circuits	ZVE-3W-183+	6540	-	TU
Dosimetric SAR Probe	SPEAG	EX3DV4	6573	12	13-May-2025
Data Acquisition Electronics	SPEAG	DAE4ip	6574	12	03-May-2025
Attenuator 5W 30dB DC-18GHz	Aaren	AT40A-4041-D18-30	6672	12	07-Sep-2024
Signal Generator	Rohde & Schwarz	SMR20	6677	12	02-Oct-2024
Patch Antenna 5G Verification Source	SPEAG	P6500V1	6704	12	07-Nov-2024
Attenuator 5W 10dB DC-18GHz	Aaren	AT40A-4041-D18-10	6758	12	08-Mar-2025
Measurement server	SPEAG	DASY 8	SN:10113	-	TU
DASY 8 Robot	SPEAG	TX2 90XL	SN:002	-	TU
Tissue Simulant Liquid	SPEAG	HBBL 600-10000	Batch 3	-	Note 1
Tissue Simulant Liquid	SPEAG	HBBL 600-10000	Batch 5	-	Note 1
Tissue Simulant Liquid	SPEAG	HBBL 600-10000	Batch 6	-	Note 1

Table 169

TU - Traceability Unscheduled

Note 1: The calibration dates for the relevant batches of TSL can be found in the fluid parameter tables within this report.



3.2 TEST SOFTWARE

The following software was used to control the TÜV SÜD Product Service DASY System.

Instrument	Version Number
DASY System	cDASY8 Module SAR V16.2.2.1588
DASY System	cDASY6 Module SAR V16.2.2.1588
DASY System	cDASY6 Module mmWave V3.2.0.1840

Table 170



3.3 TEST VERIFICATION

3.3.1 System Performance Check Results

Prior to formal testing being performed a System Check was performed in accordance with KDB 865664 and the results were compared against the calibration certificates of each corresponding system verification dipole. The following results were obtained and within the $\pm 10\%$ acceptance criteria. A system performance check in DASY Module mmWave was also performed with the Verification Source available at 6500 GHz in accordance with IEC/IEEE 63195.

System Performance Check Results

SAR System Check

Date	Frequency (MHz)	Fluid Type	Measured Max 1g SAR (W/kg) *	Max 1g SAR Target (W/kg)	Percentage Deviation from Target 1g (%)
18/07/2024	2450	HBBL 600-10000	50.88	52.6	-3.27
18/07/2024	2450	HBBL 600-10000	48.88	52.6	-7.07
19/07/2024	5200	HBBL 600-10000	78.01	78.8	-1.00
19/07/2024	5200	HBBL 600-10000	81.81	78.8	3.82
19/07/2024	5800	HBBL 600-10000	79.41	81.1	-2.08
19/07/2024	5800	HBBL 600-10000	80.61	81.1	-0.60
22/07/2024	2450	HBBL 600-10000	48.88	52.6	-7.07
23/07/2024	2450	HBBL 600-10000	51.08	52.6	-2.89
23/07/2024	2450	HBBL 600-10000	48.48	52.6	-7.83
24/07/2024	5200	HBBL 600-10000	74.22	78.8	-5.81
24/07/2024	5600	HBBL 600-10000	86.39	83	4.08
25/07/2024	5500	HBBL 600-10000	89.39	84.6	5.66
25/07/2024	5800	HBBL 600-10000	80.41	81.1	-0.85
26/07/2024	5200	HBBL 600-10000	80.21	78.8	1.79
29/07/2024	6500	HBBL 600-10000	296	297	-0.34
30/07/2024	6500	HBBL 600-10000	294	297	-1.01
31/07/2024	5600	HBBL 600-10000	82.8	83	-0.24

Table 171



APD System Check

Date	Frequency (MHz)	Fluid Type	Absorbed Power Density over 4cm ² (W/m ²) *	Absorbed Power Density Target over 4cm ² (W/m ²)	Percentage Deviation from Target 4cm ² (%)
29/07/2024	6500	HBBL 600-10000	1360	1310	3.82
30/07/2024	6500	HBBL 600-10000	1350	1310	3.05

Table 172

iPD System Check

Date	Frequency (MHz)	Medium	Measured psPDtot + (W/m ²)	Target psPDtot + (W/m ²)	Percentage Deviation from Target (%)
30/07/2024	6500	Air	153	156	-1.92

Table 173

*Normalised to a forward power of 1W.



3.4 DIELECTRIC PROPERTIES OF SIMULANT LIQUIDS

The fluid properties of the simulant fluids used during routine SAR evaluation meet the dielectric properties required in KDB 865664.

The dielectric properties of the tissue simulant liquids used are within the $\pm 10\%$ acceptance criteria for the SAR testing at TÜV SÜD Product Service and are as follows:

Fluid Type and Frequency	Relative Permittivity Measured	Relative Permittivity Target	Conductivity Measured (S/m)	Conductivity Target (S/m)	Date	Fluid Temperature °C
2450	39.89	39.20	1.83	1.80	17/07/2024	19.36
2450	39.85	39.20	1.82	1.80	17/07/2024	20.25
5200	34.17	35.99	4.50	4.66	19/07/2024	19.34
5200	34.25	35.99	4.52	4.66	19/07/2024	19.42
5800	33.03	35.30	5.16	5.27	19/07/2024	19.34
5800	33.10	35.30	5.19	5.27	19/07/2024	19.42
2450	38.89	39.20	1.80	1.80	22/07/2024	21.69
2450	38.91	39.20	1.80	1.80	22/07/2024	20.28
5200	34.39	35.99	4.55	4.66	24/07/2024	20.71
5600	33.63	35.53	4.99	5.07	24/07/2024	20.71
5500	33.82	35.64	4.88	4.96	24/07/2024	20.71
5800	33.26	35.30	5.22	5.27	24/07/2024	20.71
5200	33.65	35.99	4.51	4.66	26/07/2024	19.60
6500	32.18	34.46	6.08	6.07	29/07/2024	19.86

Table 174



3.5 TEST CONDITIONS

3.5.1 Test Laboratory Conditions

Ambient temperature: Within +18.00°C to +25.00°C.

The actual temperature during the testing ranged from 19.94°C to 22.50°C.

The actual humidity during the testing ranged from 36.5% to 57.20% RH.

The temperature of the fluid during testing does not deviate by more than 2°C for each set of tests.

3.5.2 Test Fluid Temperature Range

Frequency	Body / Head Fluid	Min Temperature °C	Max Temperature °C
2450 MHz	Head	19.40	21.69
5200 MHz	Head	19.34	20.10
5300 MHz	Head	19.05	19.90
5500 MHz	Head	19.90	20.30
5600 MHz	Head	19.90	20.09
5800 MHz	Head	19.34	20.30
6500 MHz	Head	19.40	20.40

Table 175



3.6 MEASUREMENT UNCERTAINTY

Full SAR Measurements, 300 MHz to 3 GHz

Source of Uncertainty	Uncertainty \pm %	Probability distribution	Div	c_i (1g)	Standard Uncertainty \pm % (1g)
Measurement System Errors					
Probe Calibration	12.0	Normal	2.00	1.00	6.0
Probe Calibration Drift	1.7	Rectangular	1.73	1.00	1.0
Probe Linearity	4.7	Rectangular	1.73	1.00	2.7
Broadband Signal	3.0	Rectangular	1.73	1.00	1.7
Probe Isotropy	7.6	Rectangular	1.73	1.00	4.4
Data Acquisition	0.3	Normal	1.00	1.00	0.3
RF Ambient	1.8	Normal	1.00	1.00	1.8
Probe Positioning	0.2	Normal	1.00	0.14	0.0
Data Processing	1.2	Normal	1.00	1.00	1.2
Phantom and Device errors					
Liquid Conductivity Meas.	2.5	Normal	1.00	0.78	2.0
Liquid Conductivity Temp	3.3	Rectangular	1.73	0.78	1.5
Phantom Permittivity	14.0	Rectangular	1.73	0.00	0.0
Distance DUT - TSL	2.0	Normal	1.00	2.00	4.0
Device Positioning (± 0.5 mm)	1.0	Normal	1.00	1.00	1.0
Device Holder	3.6	Normal	1.00	1.00	3.6
Device Modulation	2.4	Rectangular	1.73	1.00	1.4
Time-average SAR	2.6	Rectangular	1.73	1.00	1.5
DUT Drift	5.0	Normal	1.00	1.00	5.0
Correction to the SAR results					
Deviation to Target	1.9	Normal	1.00	1.00	1.9
SAR Scaling	0.0	Rectangular	1.73	1.00	0.0
Combined Standard Uncertainty		RSS			11.8
Expanded Standard Uncertainty		K=2			23.7

Table 176



Full SAR Measurements, 3 GHz to 6 GHz

Source of Uncertainty	Uncertainty ± %	Probability distribution	Div	c _i (1g)	Standard Uncertainty ± % (1g)
Measurement System Errors					
Probe Calibration	14.0	Normal	2.00	1.00	7.0
Probe Calibration Drift	1.7	Rectangular	1.73	1.00	1.0
Probe Linearity	4.7	Rectangular	1.73	1.00	2.7
Broadband Signal	2.6	Rectangular	1.73	1.00	1.5
Probe Isotropy	7.6	Rectangular	1.73	1.00	4.4
Data Acquisition	0.3	Normal	1.00	1.00	0.3
RF Ambient	1.8	Normal	1.00	1.00	1.8
Probe Positioning	0.2	Normal	1.00	0.33	0.1
Data Processing	2.3	Normal	1.00	1.00	2.3
Phantom and Device errors					
Liquid Conductivity Meas.	2.5	Normal	1.00	0.78	2.0
Liquid Conductivity Temp	3.4	Rectangular	1.73	0.78	1.5
Phantom Permittivity	14.0	Rectangular	1.73	0.25	2.0
Distance DUT - TSL	2.0	Normal	1.00	2.00	4.0
Device Positioning (±0.5mm)	1.0	Normal	1.00	1.00	1.0
Device Holder	3.6	Normal	1.00	1.00	3.6
Device Modulation	2.4	Rectangular	1.73	1.00	1.4
Time-average SAR	2.6	Rectangular	1.73	1.00	1.5
DUT Drift	5.0	Normal	1.00	1.00	5.0
Correction to the SAR results					
Deviation to Target	1.9	Normal	1.00	1.00	1.9
SAR Scaling	0.0	Rectangular	1.73	1.00	0.0
Combined Standard Uncertainty		RSS			12.7
Expanded Standard Uncertainty		K=2			25.3

Table 177



Full SAR Measurements, 6 GHz to 10 GHz

Source of Uncertainty	Uncertainty ± %	Probability distribution	Div	c _i (1g)	Standard Uncertainty ± % (1g)
Measurement System Errors					
Probe Calibration	18.6	Normal	2.00	1.00	9.3
Probe Calibration Drift	1.7	Rectangular	1.73	1.00	1.0
Probe Linearity	4.7	Rectangular	1.73	1.00	2.7
Broadband Signal	2.8	Rectangular	1.73	1.00	1.6
Probe Isotropy	7.6	Rectangular	1.73	1.00	4.4
Data Acquisition	0.3	Normal	1.00	1.00	0.3
RF Ambient	1.8	Normal	1.00	1.00	1.8
Probe Positioning	0.2	Normal	1.00	0.67	0.1
Data Processing	3.5	Normal	1.00	1.00	3.5
Phantom and Device errors					
Liquid Conductivity Meas.	2.5	Normal	1.00	0.78	2.0
Liquid Conductivity Temp	2.4	Rectangular	1.73	0.78	1.1
Phantom Permittivity	14.0	Rectangular	1.73	0.50	4.0
Distance DUT - TSL	2.0	Normal	1.00	2.00	4.0
Device Positioning (±0.5mm)	1.0	Normal	1.00	1.00	1.0
Device Holder	3.6	Normal	1.00	1.00	3.6
Device Modulation	2.4	Rectangular	1.73	1.00	1.4
Time-average SAR	2.6	Rectangular	1.73	1.00	1.5
DUT Drift	5.0	Normal	1.00	1.00	5.0
Correction to the SAR results					
Deviation to Target	1.9	Normal	1.00	1.00	1.9
SAR Scaling	0.0	Rectangular	1.73	1.00	0.0
Combined Standard Uncertainty		RSS			14.7
Expanded Standard Uncertainty		K=2			29.4

Table 178



Full APD Measurements, 6 GHz to 10 GHz

Symbol	Error Description	Value %	Probability distribution	Divisor	c_i (1 g)	Std Uncertainty (1 g)	c_i (10 g)	Std Uncertainty (10 g)
Measurement System Errors								
<i>CF</i>	Probe Calibration	18.60	normal 2	2.000	1	9.30	1	9.30
<i>CF_{DRIFT}</i>	Probe Calibration Drift	1.70	rectangular	1.732	1	0.98	1	0.98
<i>LIN</i>	Probe Linearity	4.70	rectangular	1.732	1	2.71	1	2.71
<i>BBS</i>	Broadband Signal	2.80	rectangular	1.732	1	1.62	1	1.62
<i>ISO</i>	Probe Isotropy	7.60	rectangular	1.732	1	4.39	1	4.39
<i>DAE</i>	Other Probe+Electronic	0.30	normal 1	1.000	1	0.30	1	0.30
<i>DAE</i>	Boundary Effects + Corrections	4.00	rectangular	1.732	1	2.31	1	2.31
<i>DAE</i>	Sensor Offset & Uncertainty	0.10	normal 1	1.000	1	0.10	1	0.10
<i>AMB</i>	RF Ambient	3.00	normal 1	1.000	1	3.00	1	3.00
Δ_{sys}	Probe Positioning	0.01	normal 1	1.000	0.5	0.00	0.5	0.00
<i>DAT</i>	Data Processing	1.00	rectangular	1.732	1	0.58	1	0.58
Phantom and Device Errors								
<i>LIQ(σ)</i>	Conductivity (meas) ^{DAK}	2.50	normal 1	1.000	0.78	1.95	0.71	1.78
<i>LIQ($T\sigma$)</i>	Conductivity (temp) ^{BB}	2.40	rectangular	1.732	0.78	1.08	0.71	0.98
<i>EPS</i>	Phantom Permittivity	14.00	rectangular	1.732	0.5	4.04	0.5	4.04
<i>DIS</i>	Distance DUT – TSL	2.00	normal 1	1.000	2	4.00	2	4.00
<i>Dxyz</i>	Device Positioning	1.00	normal 1	1.000	1	1.00	1	1.00
<i>H</i>	Device Holder	3.60	normal 1	1.000	1	3.60	1	3.60
<i>MOD</i>	DUT Modulation ^m	2.40	rectangular	1.732	1	1.39	1	1.39
<i>TAS</i>	Time-average SAR	1.70	rectangular	1.732	1	0.98	1	0.98
<i>R_{drift}</i>	DUT drift	5.00	normal 1	1.000	1	5.00	1	5.00
<i>VAL</i>	Val Antenna Unc. ^{val}	0.00	normal 1	1.000	1	0.00	1	0.00
<i>R_{fin}</i>	Unc. Input Power ^{val}	0.00	normal 1	1.000	1	0.00	1	0.00
Correction To The SAR Results								
<i>C(ϵ, σ)</i>	Deviation to Target	1.90	normal 1	1.000	1	1.90	0.84	1.60
<i>C(R)</i>	SAR scaling	0.00	rectangular	1.732	1	0.00	1	0.00
APD								
<i>PDC</i>	Power Density Conversion	13.50	rectangular	1.732	1	7.79	1	7.79
<i>u(ΔSAR)</i>	Combined Standard Uncertainty	-	normal	-	-	16.58	-	16.52
<i>U</i>	Expanded Uncertainty	-	normal k =	2.00	-	33.2	-	33

Table 179



DASY6 Uncertainty Budget for iPD

Symbol	Error Description	Value dB	Probability distribution	Divisor	c_i	$u_i(y)$ dB	$(u_i(y))^2$	v_i or v_{eff}	$u_i^4(y)$
Uncertainty terms dependent on the measurement system									
CAL	Calibration	0.49	normal 1	1.000	1	0.49	0.240	∞	0
COR	Probe correction	0.00	rectangular	1.732	1	0.00	0.000	∞	0
FRS	Frequency response (BW \leq 1 GHz)	0.20	rectangular	1.732	1	0.12	0.013	∞	0
SCC	Sensor cross coupling	0.00	rectangular	1.732	1	0.00	0.000	∞	0
ISO	Isotropy	0.50	rectangular	1.732	1	0.29	0.083	∞	0
LIN	Linearity	0.20	rectangular	1.732	1	0.12	0.013	∞	0
PSC	Probe scattering	0.00	rectangular	1.732	1	0.00	0.000	∞	0
PPO	Probe positioning offset	0.30	rectangular	1.732	1	0.17	0.030	∞	0
PPR	Probe positioning repeatability	0.04	rectangular	1.732	1	0.02	0.001	∞	0
SMO	Sensor mechanical offset	0.00	rectangular	1.732	1	0.00	0.000	∞	0
PSR	Probe spatial resolution	0.00	rectangular	1.732	1	0.00	0.000	∞	0
FLD	Field impedance dependence	0.00	rectangular	1.732	1	0.00	0.000	∞	0
APD	Amplitude and phase drift	0.00	rectangular	1.732	1	0.00	0.000	∞	0
APN	Amplitude and phase noise	0.04	rectangular	1.732	1	0.02	0.001	∞	0
TR	Measurement area truncation	0.00	rectangular	1.732	1	0.00	0.000	∞	0
DAQ	Data acquisition	0.03	normal 1	1.000	1	0.03	0.001	∞	0
SMP	Sampling	0.00	rectangular	1.732	1	0.00	0.000	∞	0
REC	Field reconstruction	0.60	rectangular	1.732	1	0.35	0.120	∞	0
TRA	FTE/MEO	0.70	rectangular	1.732	1	0.40	0.163	∞	0
SCA	Power density scaling	0.00	rectangular	1.732	1	0.00	0.000	∞	0
SAV	Spatial averaging	0.10	rectangular	1.732	1	0.06	0.003	∞	0
SDL	System detection limit	0.04	rectangular	1.732	1	0.02	0.001	∞	0
Uncertainty terms dependent on the DUT and environmental factors									
PC	Probe coupling with DUT	0.00	rectangular	1.732	1	0.00	0.000	∞	0
MOD	Modulation response	0.40	rectangular	1.732	1	0.23	0.053	∞	0
IT	Integration time	0.00	rectangular	1.732	1	0.00	0.000	∞	0
RT	Response time	0.00	rectangular	1.732	1	0.00	0.000	∞	0
DH	Device holder influence	0.10	rectangular	1.732	1	0.06	0.003	∞	0
DA	DUT alignment	0.00	rectangular	1.732	1	0.00	0.000	∞	0
REF	Reflections in laboratory	0.10	rectangular	1.732	1	0.06	0.003	∞	0
TEM	Laboratory temperature	0.10	rectangular	1.732	1	0.06	0.003	∞	0
AC	RF ambient conditions	0.04	rectangular	1.732	1	0.02	0.001	∞	0
AR	Ambient reflections	0.04	rectangular	1.732	1	0.02	0.001	∞	0
MSI	Immunity / secondary reception	0.00	rectangular	1.732	1	0.00	0.000	∞	0
DRI	Drift of the DUT	0.00	rectangular	1.732	1	0.00	0.000	∞	0
$u_c(F_s)$	Combined Standard Uncertainty (w/ FTE/MEO)	-	normal	-	-	0.86	0.734	∞	0
$U(F_s)$	Expanded Uncertainty (w/ FTE/MEO)	-	normal k =	2.00	-	1.7	-	∞	-

Table 180



DASY6 mmWave Uncertainty Budget - System Performance Check

Symbol	Error Description	Value dB	Probability distribution	Divisor	c_i	$u_i(y)$ dB	$(u_i(y))^2$ dB	v_i or v_{eff}	$u_i^4(y)$
Uncertainty terms dependent on the measurement system									
CAL	Calibration Repeatability	0.21	normal 1	1.000	1	0.21	0.044	∞	0
COR	Probe correction	0.00	rectangular	1.732	1	0.00	0.000	∞	0
FRS	Frequency response (BW \leq 1 GHz)	0.20	rectangular	1.732	0	0.00	0.000	∞	0
SCC	Sensor cross coupling	0.00	rectangular	1.732	1	0.00	0.000	∞	0
ISO	Isotropy	0.30	rectangular	1.732	1	0.17	0.030	∞	0
LIN	Linearity	0.20	rectangular	1.732	1	0.12	0.013	∞	0
PSC	Probe scattering	0.00	rectangular	1.732	1	0.00	0.000	∞	0
PPO	Probe positioning offset	0.11	rectangular	1.732	1	0.06	0.004	∞	0
PPR	Probe positioning repeatability	0.04	rectangular	1.732	1	0.02	0.001	∞	0
SMO	Sensor mechanical offset	0.00	rectangular	1.732	1	0.00	0.000	∞	0
PSR	Probe spatial resolution	0.00	rectangular	1.732	1	0.00	0.000	∞	0
FLD	Field impedance dependence	0.00	rectangular	1.732	1	0.00	0.000	∞	0
APD	Amplitude and phase drift	0.00	rectangular	1.732	1	0.00	0.000	∞	0
APN	Amplitude and phase noise	0.04	rectangular	1.732	0	0.00	0.000	∞	0
TR	Measurement area truncation	0.00	rectangular	1.732	1	0.00	0.000	∞	0
DAQ	Data acquisition	0.03	normal 1	1.000	1	0.03	0.001	∞	0
SMP	Sampling	0.00	rectangular	1.732	1	0.00	0.000	∞	0
REC	Field reconstruction	0.60	rectangular	1.732	0.3	0.10	0.011	∞	0
TRA	Forward transformation	0.00	rectangular	1.732	1	0.00	0.000	∞	0
SCA	Power density scaling	0.00	rectangular	1.732	1	0.00	0.000	∞	0
SAV	Spatial averaging	0.10	rectangular	1.732	0	0.00	0.000	∞	0
SDL	System detection limit	0.04	rectangular	1.732	1	0.02	0.001	∞	0
Uncertainty terms dependent on the DUT and environmental factors									
PC	Probe coupling with DUT	0.00	rectangular	1.732	1	0.00	0.000	∞	0
MOD	Modulation response	0.40	rectangular	1.732	0	0.00	0.000	∞	0
IT	Integration time	0.00	rectangular	1.732	1	0.00	0.000	∞	0
RT	Response time	0.00	rectangular	1.732	1	0.00	0.000	∞	0
DH	Device holder influence	0.10	rectangular	1.732	0	0.00	0.000	∞	0
REF	Reflections in laboratory	0.10	rectangular	1.732	1	0.06	0.003	∞	0
TEM	Laboratory temperature	0.10	rectangular	1.732	1	0.06	0.003	∞	0
DA	DUT alignment	0.00	rectangular	1.732	1	0.00	0.000	∞	0
AC	RF ambient conditions	0.04	rectangular	1.732	1	0.02	0.001	∞	0
AR	Ambient reflections	0.04	rectangular	1.732	1	0.02	0.001	∞	0
MSI	Immunity / secondary reception	0.00	rectangular	1.732	0	0.00	0.000	∞	0
DRI	Drift of the DUT	0.10	rectangular	1.732	1	0.06	0.003	∞	0
$u_c(F_s)$	Combined Standard Uncertainty (w/ FTE/MEO)	-	normal	-	-	0.34	0.115	∞	0
$U(F_s)$	Expanded Uncertainty (w/ FTE/MEO)	-	normal k =	2.00	-	0.7		∞	-

Table 181



3.6.1 Decision Rule

Accuracy Method

Determination of conformity with the specification limits is based on the decision rule according to IEC Guide 115: 2007, Clause 4.4.3 and 4.5.1. (Procedure 2). The measurement results are directly compared with the test limit to determine conformance with the requirements of the standard.

Risk: The uncertainty of measurement about the measured result is negligible with regard to the final pass/fail decision. The measurement result can be directly compared with the test limit to determine conformance with the requirement (compare IEC Guide 115). The level of risk to falsely accept and falsely reject items is further described in ILAC-G8.”



SECTION 4

ACCREDITATION, DISCLAIMERS AND COPYRIGHT

4.1 ACCREDITATION, DISCLAIMERS AND COPYRIGHT



This non-binding report has been prepared by TÜV SÜD with all reasonable skill and care.

The document is confidential to the potential Client and TÜV SÜD. No part of this document may be reproduced without the prior written approval of TÜV SÜD.

© 2024 TÜV SÜD.

This report relates only to the actual item/items tested.

Results of tests covered by our Flexible UKAS Accreditation Schedule are marked FS (Flexible Scope).

Results of tests not covered by our UKAS Accreditation Schedule are marked NUA (Not UKAS Accredited)

Our UKAS Accreditation does not cover opinions and interpretations and any expressed are outside the scope of our UKAS Accreditation



ANNEX A

PROBE CALIBRATION REPORT



**Calibration Laboratory of
 Schmid & Partner
 Engineering AG**
 Zeughausstrasse 43, 8004 Zurich, Switzerland



S Schweizerischer Kalibrierdienst
C Service suisse d'étalonnage
S Servizio svizzero di taratura
S Swiss Calibration Service

Accredited by the Swiss Accreditation Service (SAS)
 The Swiss Accreditation Service is one of the signatories to the EA
 Multilateral Agreement for the recognition of calibration certificates

Accreditation No.: **SCS 0108**

Client	TÜV SÜD Fareham, United Kingdom	Certificate No.	EX-7805_Feb24
--------	---	-----------------	----------------------

CALIBRATION CERTIFICATE

Object	EX3DV4 - SN:7805
Calibration procedure(s)	QA CAL-01.v10, QA CAL-12.v10, QA CAL-14.v7, QA CAL-23.v6, QA CAL-25.v8 Calibration procedure for dosimetric E-field probes
Calibration date	February 14, 2024

This calibration certificate documents the traceability to national standards, which realize the physical units of measurements (SI).
 The measurements and the uncertainties with confidence probability are given on the following pages and are part of the certificate.
 All calibrations have been conducted in the closed laboratory facility: environment temperature (22 ± 3) °C and humidity < 70%.
 Calibration Equipment used (M&TE critical for calibration)

Primary Standards	ID	Cal Date (Certificate No.)	Scheduled Calibration
Power meter NRP2	SN: 104778	30-Mar-23 (No. 217-03804/03805)	Mar-24
Power sensor NRP-Z91	SN: 103244	30-Mar-23 (No. 217-03804)	Mar-24
OCP DAK-3.5 (weighted)	SN: 1249	05-Oct-23 (OCP-DAK3.5-1249_Oct23)	Oct-24
OCP DAK-12	SN: 1016	05-Oct-23 (OCP-DAK12-1016_Oct23)	Oct-24
Reference 20 dB Attenuator	SN: CC2552 (20x)	30-Mar-23 (No. 217-03809)	Mar-24
DAE4	SN: 660	16-Mar-23 (No. DAE4-660_Mar23)	Mar-24
Reference Probe EX3DV4	SN: 7349	03-Nov-23 (No. EX3-7349_Nov23)	Nov-24

Secondary Standards	ID	Check Date (in house)	Scheduled Check
Power meter E4419B	SN: GB41293874	06-Apr-16 (in house check Jun-22)	In house check: Jun-24
Power sensor E4412A	SN: MY41498087	06-Apr-16 (in house check Jun-22)	In house check: Jun-24
Power sensor E4412A	SN: 000110210	06-Apr-16 (in house check Jun-22)	In house check: Jun-24
RF generator HP 8648C	SN: US3642U01700	04-Aug-99 (in house check Jun-22)	In house check: Jun-24
Network Analyzer E8358A	SN: US41080477	31-Mar-14 (in house check Oct-22)	In house check: Oct-24

	Name	Function	Signature
Calibrated by	Jeffrey Katzman	Laboratory Technician	
Approved by	Sven Kühn	Technical Manager	

Issued: February 14, 2024

This calibration certificate shall not be reproduced except in full without written approval of the laboratory.



**Calibration Laboratory of
Schmid & Partner
Engineering AG**

Zeughausstrasse 43, 8004 Zurich, Switzerland



S Schweizerischer Kallbrlerdienst
C Service suisse d'etalonnage
S Servizio svizzero di taratura
S Swiss Calibration Service

Accredited by the Swiss Accreditation Service (SAS)
The Swiss Accreditation Service is one of the signatories to the EA
Multilateral Agreement for the recognition of calibration certificates

Accreditation No.: **SCS 0108**

Glossary

TSL	tissue simulating liquid
NORM _{x,y,z}	sensitivity in free space
ConvF	sensitivity in TSL / NORM _{x,y,z}
DCP	diode compression point
CF	crest factor (1/duty_cycle) of the RF signal
A, B, C, D	modulation dependent linearization parameters
Polarization φ	φ rotation around probe axis
Polarization ϑ	ϑ rotation around an axis that is in the plane normal to probe axis (at measurement center), i.e., $\vartheta = 0$ is normal to probe axis
Connector Angle	information used in DASY system to align probe sensor X to the robot coordinate system

Calibration is Performed According to the Following Standards:

- a) IEC/IEEE 62209-1528, "Measurement Procedure For The Assessment Of Specific Absorption Rate Of Human Exposure To Radio Frequency Fields From Hand-Held And Body-Worn Wireless Communication Devices – Part 1528: Human Models, Instrumentation And Procedures (Frequency Range of 4 MHz to 10 GHz)", October 2020.
- b) KDB 865664, "SAR Measurement Requirements for 100 MHz to 6 GHz"

Methods Applied and Interpretation of Parameters:

- **NORM_{x,y,z}**: Assessed for E-field polarization $\vartheta = 0$ ($f \leq 900$ MHz in TEM-cell; $f > 1800$ MHz: R22 waveguide). NORM_{x,y,z} are only intermediate values, i.e., the uncertainties of NORM_{x,y,z} does not affect the E²-field uncertainty inside TSL (see below ConvF).
- **NORM(f)_{x,y,z} = NORM_{x,y,z} * frequency_response** (see Frequency Response Chart). This linearization is implemented in DASY4 software versions later than 4.2. The uncertainty of the frequency response is included in the stated uncertainty of ConvF.
- **DCP_{x,y,z}**: DCP are numerical linearization parameters assessed based on the data of power sweep with CW signal. DCP does not depend on frequency nor media.
- **PAR**: PAR is the Peak to Average Ratio that is not calibrated but determined based on the signal characteristics
- **A_{x,y,z}; B_{x,y,z}; C_{x,y,z}; D_{x,y,z}; VR_{x,y,z}**: A, B, C, D are numerical linearization parameters assessed based on the data of power sweep for specific modulation signal. The parameters do not depend on frequency nor media. VR is the maximum calibration range expressed in RMS voltage across the diode.
- **ConvF and Boundary Effect Parameters**: Assessed in flat phantom using E-field (or Temperature Transfer Standard for $f \leq 800$ MHz) and inside waveguide using analytical field distributions based on power measurements for $f > 800$ MHz. The same setups are used for assessment of the parameters applied for boundary compensation (alpha, depth) of which typical uncertainty values are given. These parameters are used in DASY4 software to improve probe accuracy close to the boundary. The sensitivity in TSL corresponds to NORM_{x,y,z} * ConvF whereby the uncertainty corresponds to that given for ConvF. A frequency dependent ConvF is used in DASY version 4.4 and higher which allows extending the validity from ± 50 MHz to ± 100 MHz.
- **Spherical isotropy (3D deviation from isotropy)**: in a field of low gradients realized using a flat phantom exposed by a patch antenna.
- **Sensor Offset**: The sensor offset corresponds to the offset of virtual measurement center from the probe tip (on probe axis). No tolerance required.
- **Connector Angle**: The angle is assessed using the information gained by determining the NORM_x (no uncertainty required).



EX3DV4 - SN:7805

February 14, 2024

Parameters of Probe: EX3DV4 - SN:7805

Basic Calibration Parameters

	Sensor X	Sensor Y	Sensor Z	Unc (k = 2)
Norm ($\mu V/(V/m)^2$) ^A	0.62	0.61	0.71	±10.1%
DCP (mV) ^B	106.5	106.8	106.3	±4.7%

Calibration Results for Modulation Response

UID	Communication System Name		A dB	B dB $\sqrt{\mu V}$	C	D dB	VR mV	Max dev.	Max Unc ^E k = 2
0	CW	X	0.00	0.00	1.00	0.00	143.0	±2.5%	±4.7%
		Y	0.00	0.00	1.00		131.9		
		Z	0.00	0.00	1.00		121.0		
10352	Pulse Waveform (200Hz, 10%)	X	1.54	60.76	6.34	10.00	60.0	±3.0%	±9.6%
		Y	1.39	60.12	6.21		60.0		
		Z	1.47	60.41	6.23		60.0		
10353	Pulse Waveform (200Hz, 20%)	X	22.00	74.00	9.00	6.99	80.0	±2.7%	±9.6%
		Y	0.82	60.00	5.11		80.0		
		Z	0.83	60.00	4.93		80.0		
10354	Pulse Waveform (200Hz, 40%)	X	0.04	125.69	0.10	3.98	95.0	±3.0%	±9.6%
		Y	0.41	158.60	17.89		95.0		
		Z	24.00	72.00	7.00		95.0		
10355	Pulse Waveform (200Hz, 60%)	X	7.72	159.15	26.25	2.22	120.0	±1.5%	±9.6%
		Y	0.33	60.00	3.30		120.0		
		Z	9.77	158.08	12.75		120.0		
10387	QPSK Waveform, 1 MHz	X	0.57	65.44	13.50	1.00	150.0	±2.8%	±9.6%
		Y	0.94	73.38	18.15		150.0		
		Z	0.55	64.20	12.89		150.0		
10388	QPSK Waveform, 10 MHz	X	1.40	67.23	14.48	0.00	150.0	±0.9%	±9.6%
		Y	1.76	70.92	16.71		150.0		
		Z	1.36	66.42	14.19		150.0		
10396	64-QAM Waveform, 100 kHz	X	1.63	64.08	15.63	3.01	150.0	±0.9%	±9.6%
		Y	1.84	66.27	16.88		150.0		
		Z	1.71	64.70	15.80		150.0		
10399	64-QAM Waveform, 40 MHz	X	2.87	66.92	15.41	0.00	150.0	±1.3%	±9.6%
		Y	2.94	67.43	15.91		150.0		
		Z	2.82	66.49	15.20		150.0		
10414	WLAN CCDF, 64-QAM, 40 MHz	X	3.82	66.52	15.49	0.00	150.0	±2.1%	±9.6%
		Y	3.97	67.19	16.00		150.0		
		Z	3.77	66.07	15.29		150.0		

Note: For details on UID parameters see Appendix

The reported uncertainty of measurement is stated as the standard uncertainty of measurement multiplied by the coverage factor k=2, which for a normal distribution corresponds to a coverage probability of approximately 95%.

^A The uncertainties of Norm X,Y,Z do not affect the E²-field uncertainty inside TSL (see Pages 5 and 6).
^B Linearization parameter uncertainty for maximum specified field strength.
^E Uncertainty is determined using the max. deviation from linear response applying rectangular distribution and is expressed for the square of the field value.



EX3DV4 - SN:7805

February 14, 2024

Parameters of Probe: EX3DV4 - SN:7805

Sensor Model Parameters

	C1 fF	C2 fF	α V^{-1}	T1 msV^{-2}	T2 msV^{-1}	T3 ms	T4 V^{-2}	T5 V^{-1}	T6
x	8.8	62.84	32.91	4.19	0.00	4.90	0.50	0.00	1.00
y	9.0	63.68	32.62	4.61	0.00	4.90	0.56	0.00	1.00
z	9.2	65.89	32.77	3.99	0.00	4.90	0.58	0.00	1.00

Other Probe Parameters

Sensor Arrangement	Triangular
Connector Angle	-7.5°
Mechanical Surface Detection Mode	enabled
Optical Surface Detection Mode	disabled
Probe Overall Length	337 mm
Probe Body Diameter	10 mm
Tip Length	9 mm
Tip Diameter	2.5 mm
Probe Tip to Sensor X Calibration Point	1 mm
Probe Tip to Sensor Y Calibration Point	1 mm
Probe Tip to Sensor Z Calibration Point	1 mm
Recommended Measurement Distance from Surface	1.4 mm

Note: Measurement distance from surface can be increased to 3–4 mm for an Area Scan job.