

FCC and ISED Test Report

Apple Inc
Model: A2991

In accordance with FCC 47 CFR Part 15B, ICES-003 and ISED RSS-GEN

Prepared for: Apple Inc
One Apple Park Way
Cupertino
California
95014
USA

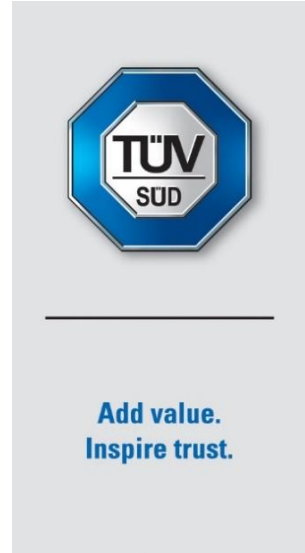

FCC ID: BCGA2991

IC: 579C-A2991

COMMERCIAL-IN-CONFIDENCE

Document 75957632-66 Issue 01

SIGNATURE

NAME	JOB TITLE	RESPONSIBLE FOR	ISSUE DATE
Jensen Adams	Manager (Technical Solutions)	Authorised Signatory	03 October 2023

Signatures in this approval box have checked this document in line with the requirements of TÜV SÜD document control rules.

ENGINEERING STATEMENT

The measurements shown in this report were made in accordance with the procedures described on test pages. All reported testing was carried out on a sample equipment to demonstrate limited compliance with FCC 47 CFR Part 15B and ICES-003 and ISED RSS-GEN. The sample tested was found to comply with the requirements defined in the applied rules.

RESPONSIBLE FOR	NAME	DATE	SIGNATURE
Testing	Jonas Ayipah	03 October 2023	
Testing	James Cumming	03 October 2023	

FCC Accreditation

492497/UK2010 Octagon House, Fareham Test Laboratory

ISED Accreditation

12669A Octagon House, Fareham Test Laboratory

EXECUTIVE SUMMARY

A sample of this product was tested and found to be compliant with FCC 47 CFR Part 15B, ICES-003 and ISED RSS-GEN: 2021, Issue 7: 2020 and Issue 5 and A2 (2021-02) for the tests detailed in section 1.3.



DISCLAIMER AND COPYRIGHT

This non-binding report has been prepared by TÜV SÜD with all reasonable skill and care. The document is confidential to the potential Client and TÜV SÜD. No part of this document may be reproduced without the prior written approval of TÜV SÜD. © 2023 TÜV SÜD. This report relates only to the actual item/items tested.

ACCREDITATION

Our UKAS Accreditation does not cover opinions and interpretations and any expressed are outside the scope of our UKAS Accreditation. Results of tests not covered by our UKAS Accreditation Schedule are marked NUA (Not UKAS Accredited).

TÜV SÜD
is a trading name of TÜV SÜD Ltd
Registered in Scotland at East Kilbride,
Glasgow G75 0QF, United Kingdom
Registered number: SC215164

TÜV SÜD Ltd is a
TÜV SÜD Group Company

Phone: +44 (0) 1489 558100
Fax: +44 (0) 1489 558101
www.tuvsud.com/en

TÜV SÜD
Octagon House
Concorde Way
Fareham
Hampshire PO15 5RL
United Kingdom



Contents

1	Report Summary	2
1.1	Report Modification Record.....	2
1.2	Introduction.....	2
1.3	Brief Summary of Results	3
1.4	Product Information	4
1.5	Deviations from the Standard.....	4
1.6	EUT Modification Record	5
1.7	Test Location	5
2	Test Details	6
2.1	Conducted Disturbance at Mains Terminals	6
2.2	Radiated Disturbance.....	11
3	Test Equipment Information	18
3.1	General Test Equipment Used.....	18
4	Incident Reports	19
5	Measurement Uncertainty	20



1 Report Summary

1.1 Report Modification Record

Alterations and additions to this report will be issued to the holders of each copy in the form of a complete document.

Issue	Description of Change	Date of Issue
1	First Issue	03 Oct 2023

Table 1

1.2 Introduction

Applicant	Apple Inc
Manufacturer	Apple Inc
Model Number(s)	A2991
Serial Number(s)	HVQ2QYD74F YY6D64HH6P
Hardware Version(s)	REV1.0
Software Version(s)	23A300
Number of Samples Tested	2
Test Specification/Issue/Date	FCC 47 CFR Part 15B, 2021 ICES-003, Issue 7: 2020 ISED RSS-GEN, Issue 5, A2 (2021-02)
Start of Test	28-July-2023
Finish of Test	01-August-2023
Name of Engineer(s)	Jonas Ayipah and James Cumming
Related Document(s)	ANSI C63.4: 2014



1.3 Brief Summary of Results

A brief summary of the tests carried out in accordance with FCC 47 CFR Part 15B and ICES-003 and ISED RSS-GEN is shown below.

Section	Specification Clause	Test Description	Result	Comments/Base Standard
Configuration and Mode: AC Powered - Transmitter Idle				
2.1	15.107, 3.1 and 8.8	Conducted Disturbance at Mains Terminals	Pass	ANSI C63.4: 2014
2.2	15.109, 3.2 and 7.1	Radiated Disturbance	Pass	ANSI C63.4: 2014

Table 2



1.4 Product Information

1.4.1 Technical Description

The equipment under test (EUT) was a portable laptop computer.

1.4.2 EUT Port/Cable Identification

Port	Max Cable Length specified	Usage	Type	Screened
Configuration and Mode: AC Powered - Transmitter Idle				
AC Power Port	2 m	Power	AC to DC Power Adapter with USB-C Output	No
USB Port 1	2 m	Data	USB Type-C	No
USB Port 2	Unterminated	Data	USB Type-C	No
USB Port 3	Unterminated	Data	USB Type-C	No
HDMI Port	2 m	Data	HDMI	No
Audio Jack Port	0.5 m	Audio Output	3.5 mm Jack	No

Table 3

1.4.3 Test Configuration

Configuration	Description
AC Powered	The EUT was powered from a 115 V 60 Hz AC supply using an AC to DC adapter using a USB-C output. A set of headphones was used to terminate the EUT's 3.5 mm audio jack port. A USB-C to USB-A adapter and optical mouse were used to terminate the USB Type-C port 1. A HDMI cable and monitor were used to terminate the EUT's HDMI port. Type-C Port 2 and Type-C Port 3 were unterminated.

Table 4

1.4.4 Modes of Operation

Mode	Description
Transmitter Idle	The EUT's intentional transmitters were turned Off. The EUT was configured to display video on the EUT screen whilst playing audio through the headphones. The display was set to maximum brightness and sleep mode was disabled.

Table 5

1.5 Deviations from the Standard

No deviations from the applicable test standard were made during testing.



1.6 EUT Modification Record

The table below details modifications made to the EUT during the test programme.

The modifications incorporated during each test are recorded on the appropriate test pages.

Modification State	Description of Modification still fitted to EUT	Modification Fitted By	Date Modification Fitted
Model: A2991, Serial Number: HVQ2QYD74F			
0	As supplied by the customer	Not Applicable	Not Applicable
Model: A2991, Serial Number: YY6D64HH6P			
0	As supplied by the customer	Not Applicable	Not Applicable

Table 6

1.7 Test Location

TÜV SÜD conducted the following tests at our Octagon House Test Laboratory.

Test Name	Name of Engineer(s)	Accreditation
Configuration and Mode: AC Powered - Transmitter Idle		
Conducted Disturbance at Mains Terminals	Jonas Ayipah	UKAS
Radiated Disturbance	James Cumming	UKAS

Table 7

Office Address:

TÜV SÜD
Octagon House
Concorde Way
Fareham
Hampshire
PO15 5RL
United Kingdom



2 Test Details

2.1 Conducted Disturbance at Mains Terminals

2.1.1 Specification Reference

FCC 47 CFR Part 15B, Clause 15.107
ICES-003, Clause, 3.1
ISED RSS-GEN, Clause 8.8

2.1.2 Equipment Under Test and Modification State

A2991, S/N: YY6D64HH6P - Modification State 0

2.1.3 Date of Test

28-July-2023

2.1.4 Test Method

The EUT was setup according to ANSI C63.4, clause 5.2.

The EUT was placed on a non-conductive table 0.8 m above a reference ground plane. A vertical coupling plane was placed 0.4 m from the EUT boundary.

A Line Impedance Stabilisation Network (LISN) was directly bonded to the ground-plane. The EUT was located so that the distance between the boundary of the EUT and the closest surface of the LISN was 0.8 m.

Interconnecting cables that hanged closer than 0.4 m to the ground plane were folded back and forth in the centre forming a bundle 0.3 m to 0.4 m long.

Input and output cables were terminated with equipment or loads representative of real usage conditions.

The EUT was configured to give the highest level of emissions within reason of a typical installation as described by the manufacturer.

2.1.5 Example Calculation

Quasi-Peak level (dB μ V) = Receiver level (dB μ V) + Correction Factor (dB)
Margin (dB) = Quasi-Peak level (dB μ V) - Limit (dB μ V)

CISPR Average level (dB μ V) = Receiver level (dB μ V) + Correction Factor (dB)
Margin (dB) = CISPR Average level (dB μ V) - Limit (dB μ V)

2.1.6 Example Test Setup Diagram

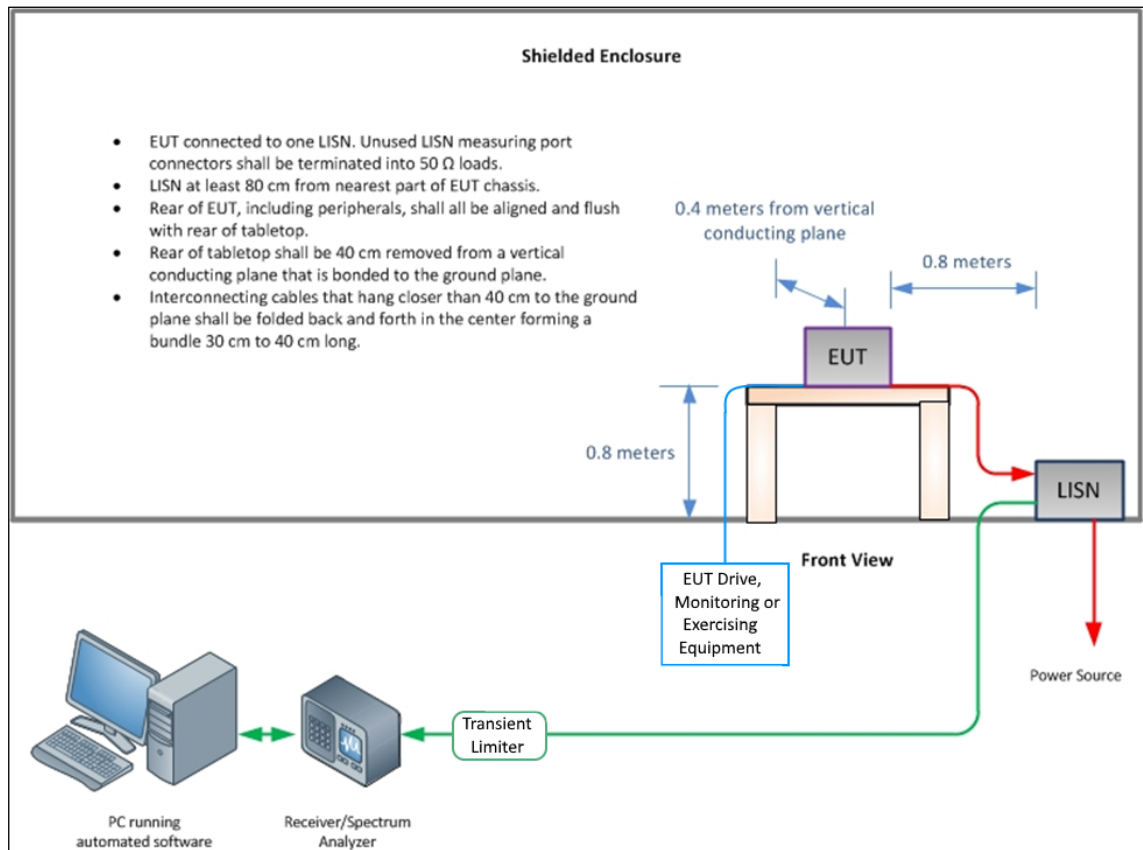

Figure 1 - Conducted Disturbance

2.1.7 Environmental Conditions

Ambient Temperature 24.0 °C
 Relative Humidity 57.4 %
 Atmospheric Pressure 999.0 mbar

2.1.8 Specification Limits

Required Specification Limits - Class B			
Line Under Test	Frequency Range (MHz)	Quasi-Peak Test Limit (dBµV)	CISPR Average Test Limit (dBµV)
AC Power Port	0.15 to 0.5	66 to 56 ⁽¹⁾	56 to 46 ⁽¹⁾
	0.5 to 5	56	46
	5 to 30	60	50

Supplementary information:
 Note 1. Decreases with the logarithm of the frequency.

Table 8



2.1.9 Test Results

Results for Configuration and Mode: AC Powered - Transmitter Idle.

This test was performed to the requirements of the Class B limits.

Performance assessment of the EUT made during this test: Pass.

Detailed results are shown below.

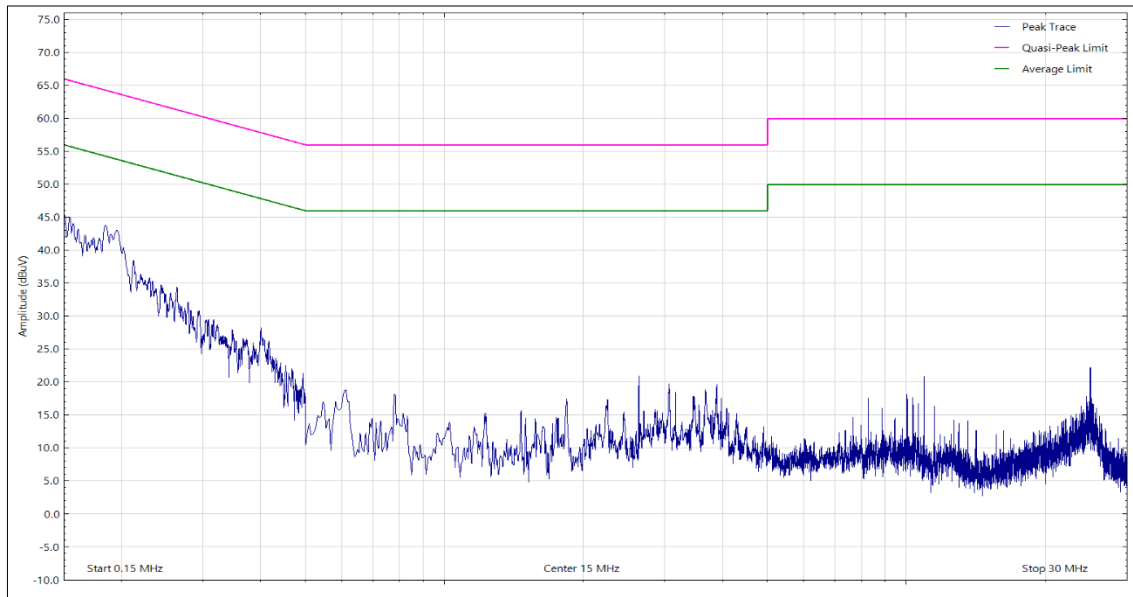

Figure 2 - Graphical Results - AC Power Live Line

Frequency (MHz)	Level (dBµV)	Limit (dBµV)	Margin (dB)	Detector
*				

Table 9

*No final measurements were made as all peak emissions seen above the measurement system noise floor during the pre-scan were greater than 6 dB below the CISPR Average test limit.

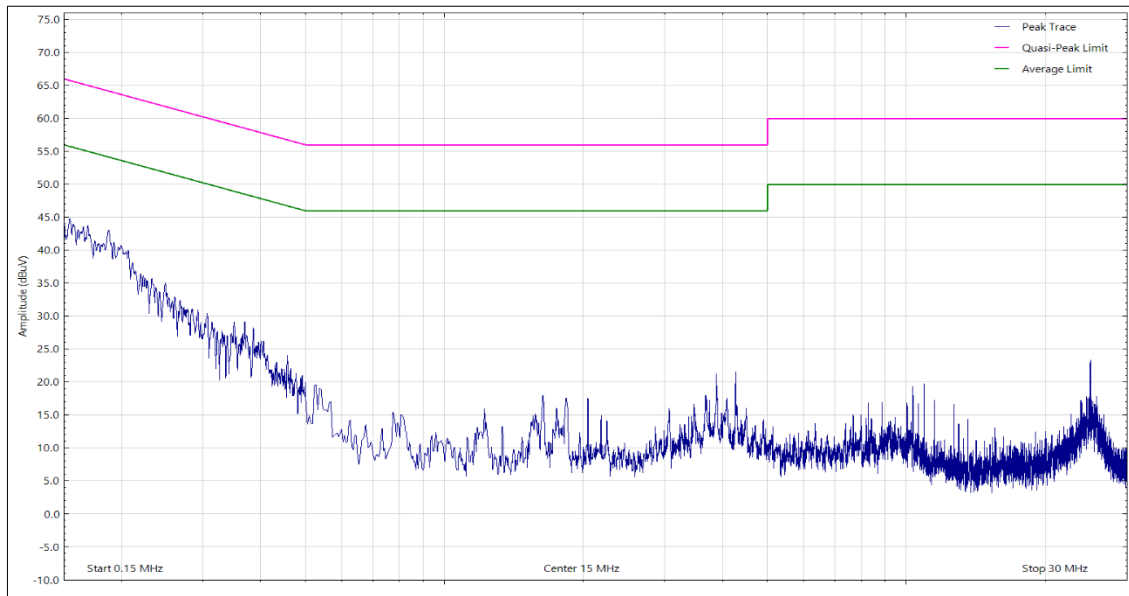

Figure 3 - Graphical Results - AC Power Neutral Line

Frequency (MHz)	Level (dBµV)	Limit (dBµV)	Margin (dB)	Detector
*				

Table 10

*No final measurements were made as all peak emissions seen above the measurement system noise floor during the pre-scan were greater than 6 dB below the CISPR Average test limit.



2.1.10 Test Location and Test Equipment Used

This test was carried out in EMC Chamber 12.

Instrument	Manufacturer	Type No	TE No	Calibration Period (months)	Calibration Expires
Emissions Software	TUV SUD	EmX V3.1.12	5125	-	Software
Test Receiver	Rohde & Schwarz	ESU40	3506	12	30-Mar-2024
Transient Limiter	Hewlett Packard	11947A	2377	12	02-Mar-2024
Termination (50ohm)	JFW	50T-054	3952	12	22-Mar-2024
Cable (SMA to N-Type, 2 m)	Junkosha	MWX241/B	5817	6	04-Aug-2023
Cable (N-Type to N-Type, 8 m)	Junkosha	MWX221-08000NMSNMS/B	6321	12	04-Feb-2024
LISN (CISPR 16, Single Phase)	Chase	MN 2050	336	12	03-Jul-2024
LISN (CISPR 16, Single Phase)	Rohde & Schwarz	ESH3-Z5	1390	12	02-Feb-2024

Table 11



2.2 Radiated Disturbance

2.2.1 Specification Reference

FCC 47 CFR Part 15B, Clause 15.109
ICES-003, Clause 3.2
ISED RSS-GEN, Clause 7.1

2.2.2 Equipment Under Test and Modification State

A2991, S/N: HVQ2QYD74F - Modification State 0

2.2.3 Date of Test

31-July-2023 to 01-August-2023

2.2.4 Test Method

The EUT was set up on a non-conductive table 0.8 m above a reference ground plane within a semi-anechoic chamber on a remotely controlled turntable.

A pre-scan of the EUT emissions profile using a peak detector was made at a 3 m antenna distance whilst varying the antenna-to-EUT azimuth and polarisation.

For an EUT which could reasonable be used in multiple planes, pre-scans were performed with the EUT orientated in X, Y and Z planes with reference to the ground plane.

Using a list of the highest emissions detected during the pre-scan along with their bearing and associated antenna polarisation, the EUT was then formally measured using a Quasi-Peak, Peak or CISPR Average detector as appropriate.

The readings were maximised by adjusting the antenna height, polarisation and turntable azimuth, in accordance with the specification.

2.2.5 Example Calculation

Below 1 GHz:

$$\begin{aligned} \text{Quasi-Peak level (dB}\mu\text{V/m)} &= \text{Receiver level (dB}\mu\text{V)} + \text{Correction Factor (dB/m)} \\ \text{Margin (dB)} &= \text{Quasi-Peak level (dB}\mu\text{V/m)} - \text{Limit (dB}\mu\text{V/m)} \end{aligned}$$

Above 1 GHz:

$$\begin{aligned} \text{CISPR Average level (dB}\mu\text{V/m)} &= \text{Receiver level (dB}\mu\text{V)} + \text{Correction Factor (dB/m)} \\ \text{Margin (dB)} &= \text{CISPR Average level (dB}\mu\text{V/m)} - \text{Limit (dB}\mu\text{V/m)} \end{aligned}$$

$$\begin{aligned} \text{Peak level (dB}\mu\text{V/m)} &= \text{Receiver level (dB}\mu\text{V)} + \text{Correction Factor (dB/m)} \\ \text{Margin (dB)} &= \text{Peak level (dB}\mu\text{V/m)} - \text{Limit (dB}\mu\text{V/m)} \end{aligned}$$

2.2.6 Example Test Setup Diagram

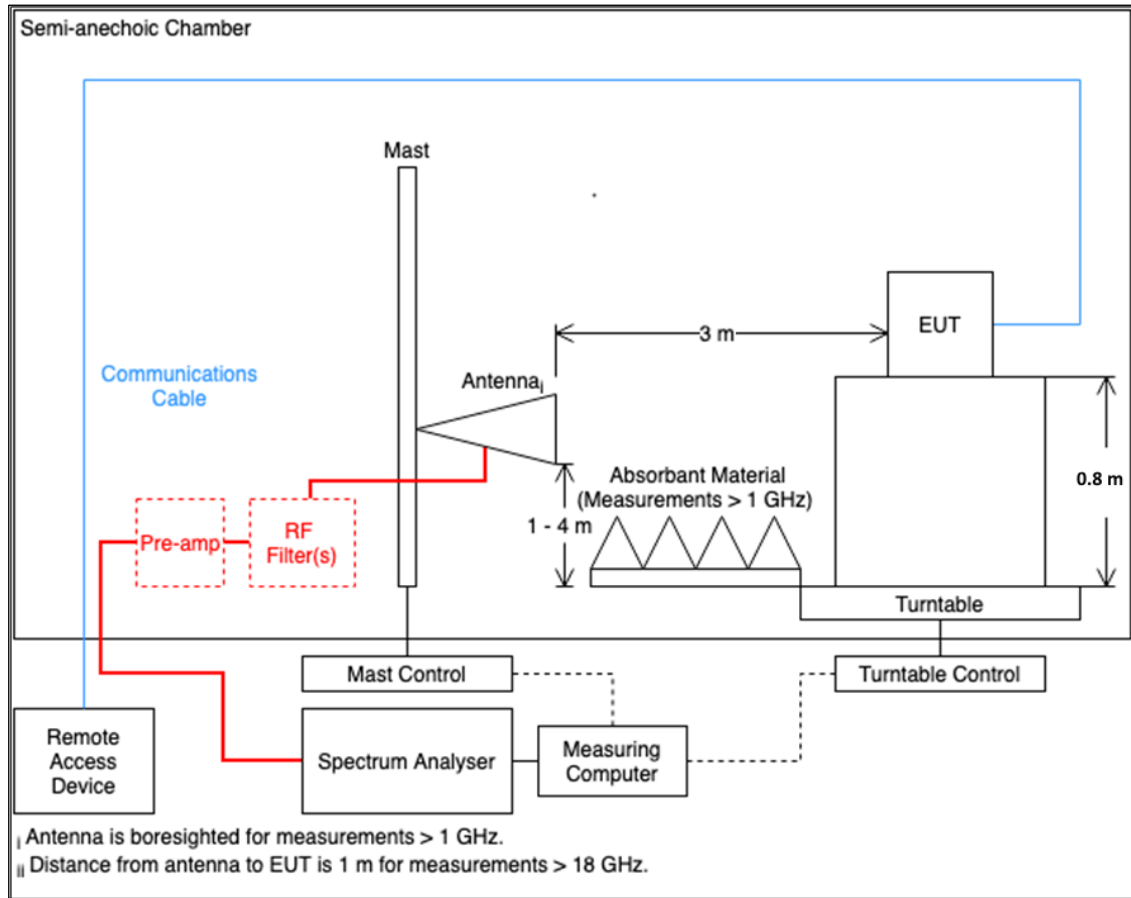

Figure 4 - Radiated Disturbance Example Test Setup

2.2.7 Environmental Conditions

Ambient Temperature 21.5 °C
 Relative Humidity 42.7 %
 Atmospheric Pressure 996.0 mbar

2.2.8 Specification Limits

Required Specification Limits, Field Strength - Class B Test Limit at a 3 m Measurement Distance		
Frequency Range (MHz)	Test Limit (µV/m)	Test Limit (dBµV/m)
30 to 88	100	40.0
88 to 216	150	43.5
216 to 960	200	46.0
Above 960	500	54.0

Supplementary information:
 Note 1. A Quasi-peak detector is to be used for measurements below 1 GHz.
 Note 2. A CISPR Average detector is to be used for measurements above 1 GHz.
 Note 3. The Peak test limit above 1 GHz is 20 dB higher than the CISPR Average test limit.

Table 12



2.2.9 Test Results

Results for Configuration and Mode: AC Powered - Transmitter Idle.

This test was performed to the requirements of the Class B limits.

Performance assessment of the EUT made during this test: Pass.

Detailed results are shown below.

Highest frequency generated or used within the EUT: 7125 MHz
 Which necessitates an upper frequency test limit of: 36 GHz

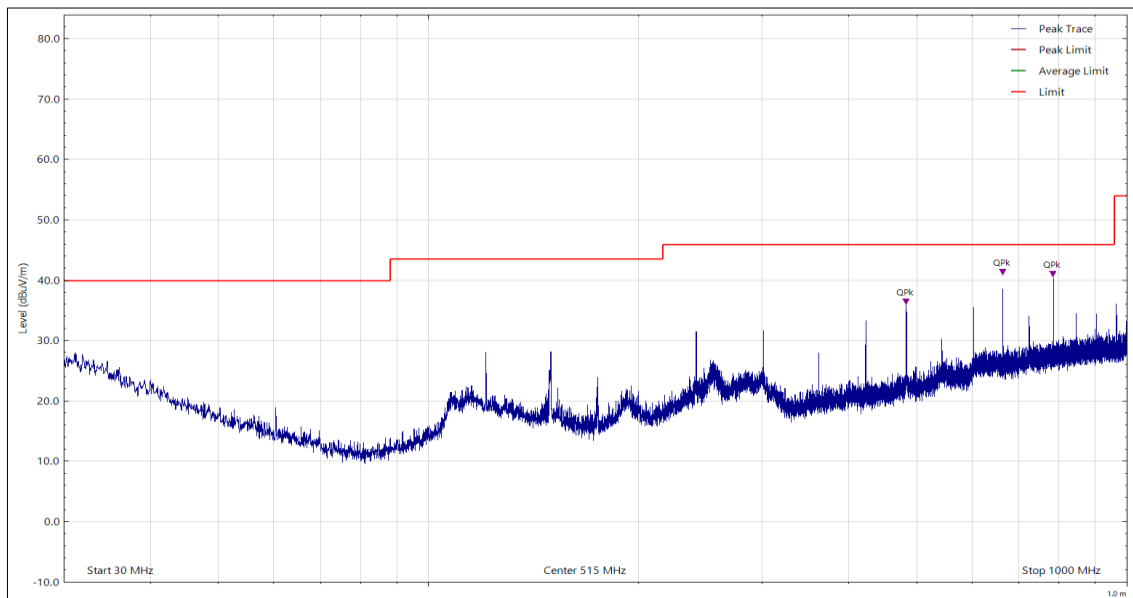

Figure 5 - 30 MHz to 1 GHz, Quasi-Peak, Horizontal

Frequency (MHz)	Level (dBµV/m)	Limit (dBµV/m)	Margin (dB)	Detector	Angle (°)	Height (cm)	Polarisation
482.643	35.68	46	-10.32	Q-Peak	307	100	Horizontal
663.652	40.55	46.00	-5.45	Q-Peak	70	114	Horizontal
784.319	40.26	46.00	-5.74	Q-Peak	46	103	Horizontal

Table 13

No other final measurements were made as all other peak emissions seen above the measurement system noise floor during the pre-scan were greater than 10 dB below the test limit.

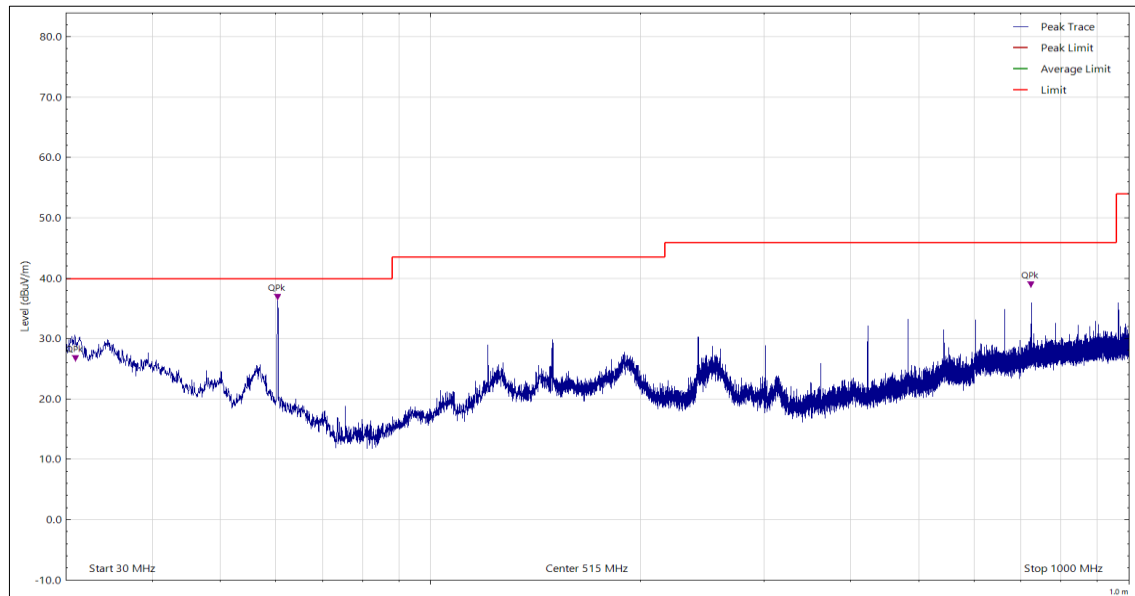

Figure 6 - 30 MHz to 1 GHz, Quasi-Peak, Vertical

Frequency (MHz)	Level (dBµV/m)	Limit (dBµV/m)	Margin (dB)	Detector	Angle (°)	Height (cm)	Polarisation
31.003	26.01	40	-13.99	Q-Peak	208	100	Vertical
60.338	36.16	40.00	-3.84	Q-Peak	143	100	Vertical
724.501	38.24	46.00	-7.76	Q-Peak	190	100	Vertical

Table 14

No other final measurements were made as all other peak emissions seen above the measurement system noise floor during the pre-scan were greater than 10 dB below the test limit.

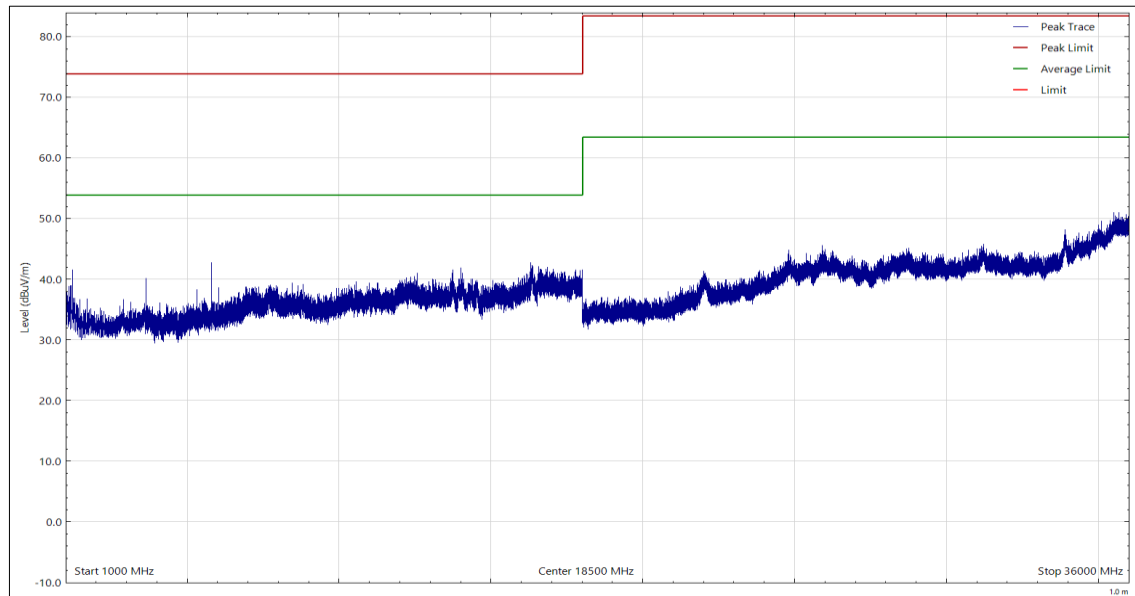

Figure 7 - 1 GHz to 36 GHz, Horizontal

Frequency (MHz)	Level (dBµV/m)	Limit (dBµV/m)	Margin (dB)	Detector	Angle (°)	Height (cm)	Polarisation
*							

Table 15

*No final measurements were made as all peak emissions seen above the measurement system noise floor during the pre-scan were greater than 10 dB below the test limit.

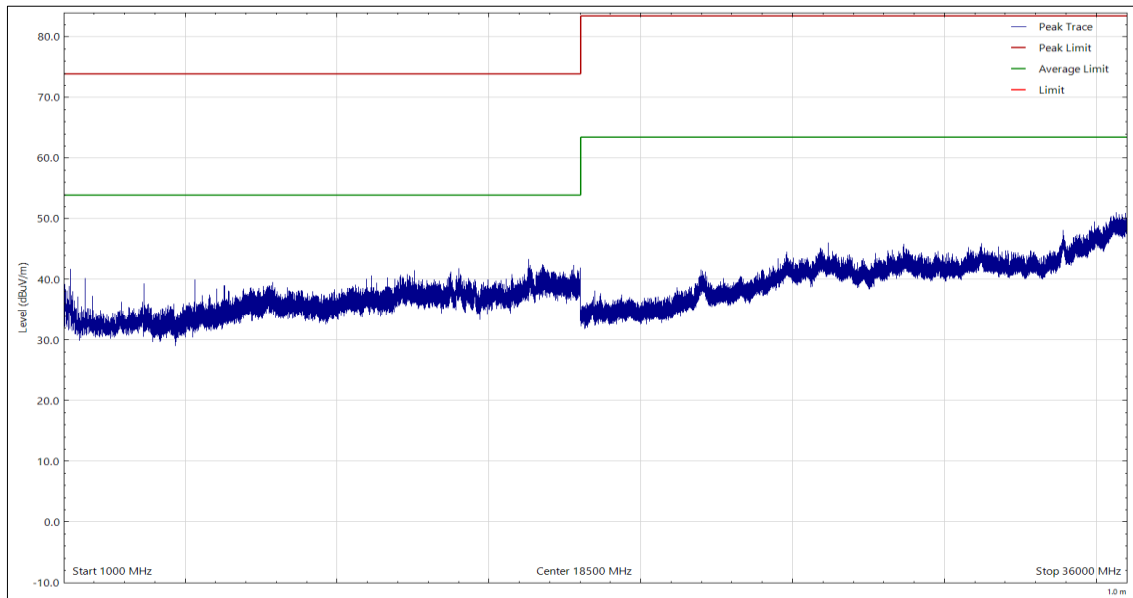

Figure 8 - 1 GHz to 36 GHz, Vertical

Frequency (MHz)	Level (dBµV/m)	Limit (dBµV/m)	Margin (dB)	Detector	Angle (°)	Height (cm)	Polarisation
*							

Table 16

*No final measurements were made as all peak emissions seen above the measurement system noise floor during the pre-scan were greater than 10 dB below the test limit.



2.2.10 Test Location and Test Equipment Used

This test was carried out in EMC Chamber 12.

Instrument	Manufacturer	Type No	TE No	Calibration Period (months)	Calibration Expires
Screened Room (12)	MVG	EMC-3	5621	36	11-Aug-2023
Emissions Software	TUV SUD	EmX V3.1.12	5125	-	Software
Test Receiver	Rohde & Schwarz	ESU40	3506	12	30-Mar-2024
Turntable & Mast Controller	Maturo Gmbh	NCD/498/2799.01	5612	-	TU
Tilt Antenna Mast	Maturo Gmbh	TAM 4.0-P	5613	-	TU
Cable (N(m)-N(m), 8 m)	Teledyne	PR90-088-8MTR	5450	6	21-Nov-2023
Cable (K-Type to K-Type, 1 m)	Junkosha	MWX241-01000KMSKMS/A	5511	12	21-May-2024
Cable (SMA to N-Type, 2 m)	Junkosha	MWX241/B	5817	6	04-Aug-2023
Pre-Amplifier (1 GHz to 10 GHz)	Miteq Corp	AFS5-01001000-20-10P-5	1200	12	27-Feb-2024
Pre-Amplifier (8 GHz to 18 GHz)	Phase One	PS04-0086	1533	12	20-Feb-2024
Pre-Amplifier (18 GHz to 40 GHz)	Narda	NARDA DB02-0447	237	12	21-Oct-2023
Antenna (Bilog with attenuator, 30 MHz to 3 GHz)	Schaffner	CBL6143	287	24	02-Dec-2024
Antenna (DRG, 1 GHz to 10.5 GHz)	Schwarzbeck	BBHA9120B	5611	12	16-Oct-2023
Antenna (DRG, 7.5 GHz to 18 GHz)	Schwarzbeck	HWRD750	5348	12	16-Oct-2023
Antenna (DRG, 18 GHz to 40 GHz)	Link Microtek Ltd	AM180HA-K-TU2	230	24	23-Sep-2024

Table 17

TU - Traceability Unscheduled



3 Test Equipment Information

3.1 General Test Equipment Used

Instrument	Manufacturer	Type No	TE No	Calibration Period (months)	Calibration Expires
Thermo-Hygro-Barometer	PCE Instruments	PCE-THB-40	5478	12	21-Apr-2024

Table 18



4 Incident Reports

No incidents reports were raised.



5 Measurement Uncertainty

For a 95% confidence level, the measurement uncertainties for defined systems are:

Test Name	Measurement Uncertainty
Conducted Disturbance at Mains Terminals	150 kHz to 30 MHz, LISN, ± 3.7 dB
Radiated Disturbance	30 MHz to 1 GHz, Bilog Antenna, ± 5.2 dB 1 GHz to 40 GHz, Horn Antenna, ± 6.3 dB

Table 19

Worst case error for both Time and Frequency measurement 12 parts in 10^6 .

Measurement Uncertainty Decision Rule

Determination of conformity with the specification limits is based on the decision rule according to IEC Guide 115:2021, Clause 4.4.3 (Procedure 2). The measurement results are directly compared with the test limit to determine conformance with the requirements of the standard.

Risk: The uncertainty of measurement about the measured result is negligible with regard to the final pass/fail decision. The measurement result can be directly compared with the test limit to determine conformance with the requirement (compare IEC Guide 115). The level of risk to falsely accept and falsely reject items is further described in ILAC-G8.