



80 MHz Bandwidth - Core 0 + Core 1 (SDM)

Mode	Data Rate/ MCS	Resource Size	Resource Index	TX Frequency (MHz)	Band Edge Frequency (MHz)	Peak Level (dBμV/m)
802.11ac VHT80	MCS2x2	-	-	5530	5470	63.53
802.11ax HE80	MCS4x2	SU	-	5530	5470	63.50
802.11ax HE80	MCS11x2	106	53	5530	5470	63.10
802.11ac VHT80	MCS8x2	-	-	5775	5725	63.31
802.11ax HE80	MCS4x2	SU	-	5775	5725	63.60
802.11ax HE80	MCS11x2	106	60	5775	5725	59.05
802.11ac VHT80	MCS4x2	-	-	5610	5725	63.18
802.11ax HE80	MCS4x2	SU	-	5610	5725	63.43
802.11ax HE80	MCS11x2	52	37	5610	5725	60.99
802.11ac VHT80	MCS8x2	-	-	5690	5850	62.82
802.11ac VHT80	MCS8x2	-	-	5775	5850	63.20
802.11ax HE80	MCS11x2	SU	-	5690	5850	62.73
802.11ax HE80	MCS11x2	106	53	5690	5850	58.42
802.11ax HE80	MCS4x2	SU	-	5775	5850	65.19
802.11ax HE80	MCS11x2	106	60	5775	5850	58.03

Table 715 - SDM Authorised Band Edge Results

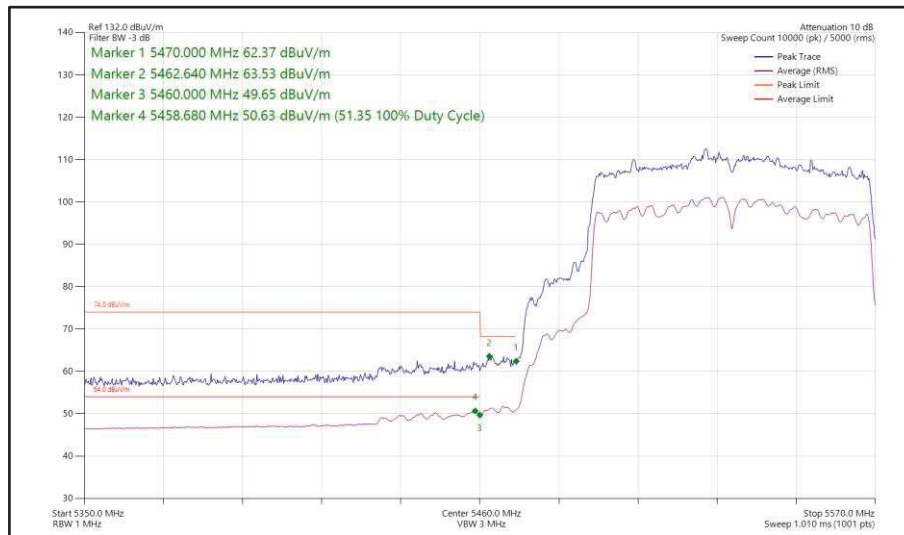
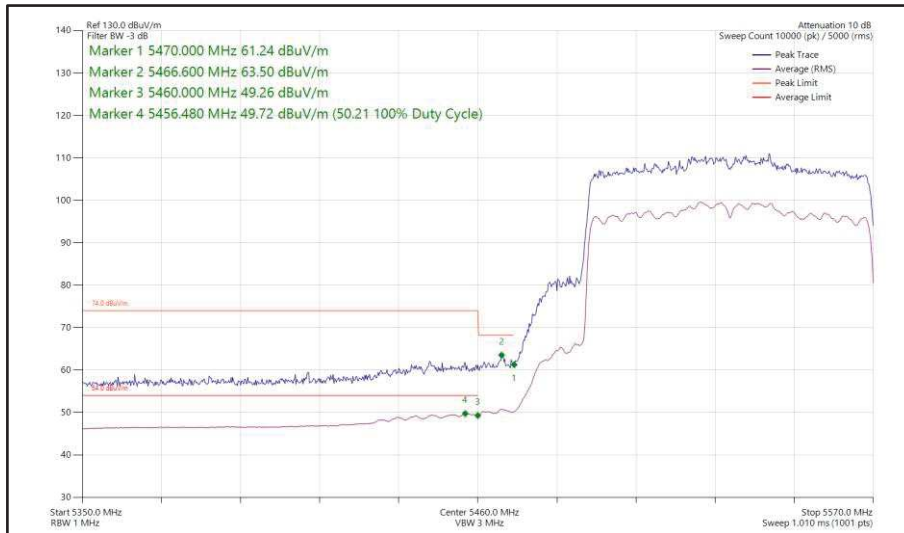
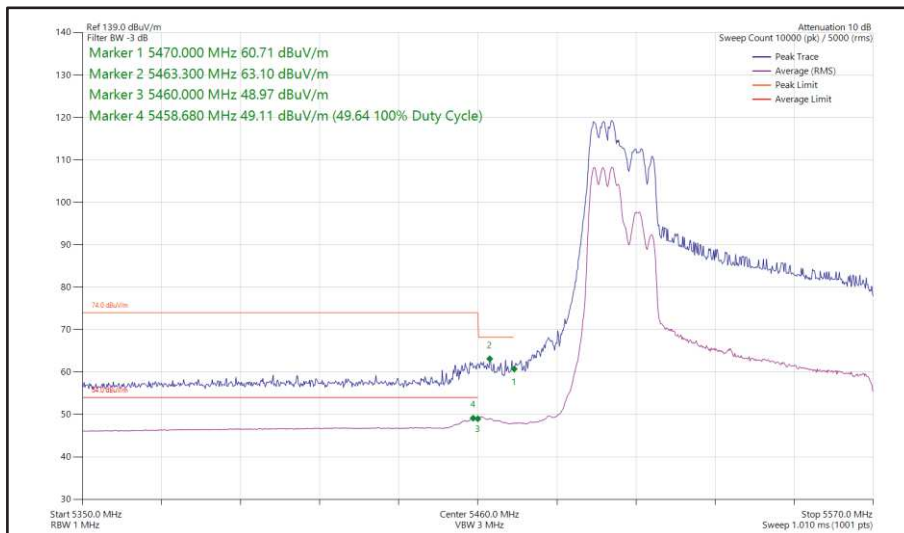

Figure 571 - 802.11ac VHT80, SDM, Core 0 + Core 1 - 5530 MHz
 Band Edge Frequency 5470 MHz



**Figure 572 - 802.11ax HE80, SU, SDM, Core 0 + Core 1 - 5530 MHz
Band Edge Frequency 5470 MHz**



**Figure 573 - 802.11ax HE80, RU 106-53, SDM, Core 0 + Core 1 - 5530 MHz
Band Edge Frequency 5470 MHz**

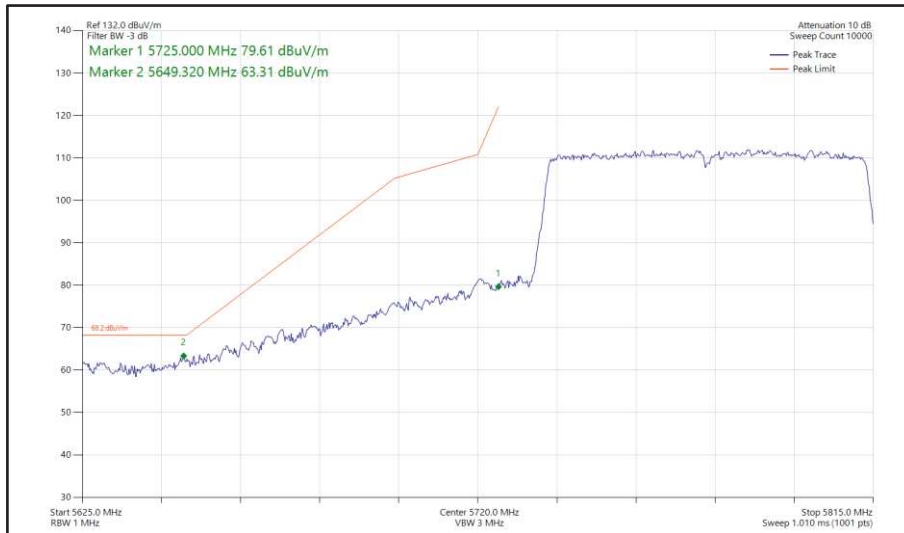

**Figure 574 - 802.11ac VHT80, SDM, Core 0 + Core 1 - 5775 MHz
Band Edge Frequency 5725 MHz**

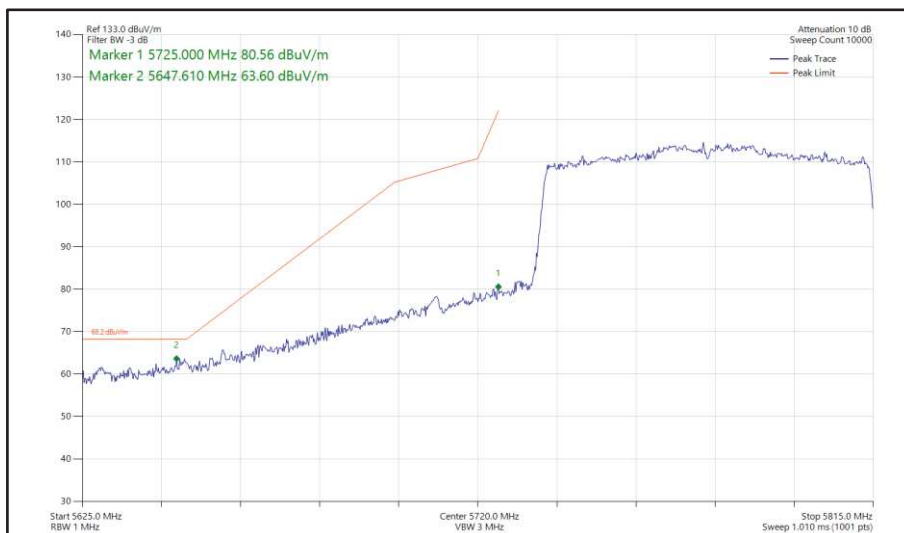

**Figure 575 - 802.11ax HE80, SU, SDM, Core 0 + Core 1 - 5775 MHz
Band Edge Frequency 5725 MHz**

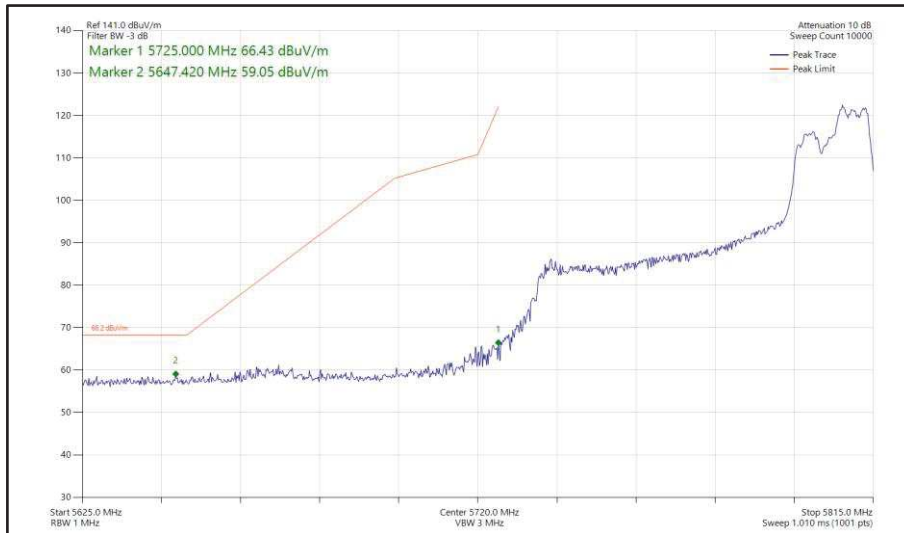

**Figure 576 - 802.11ax HE80, RU 106-60, SDM, Core 0 + Core 1 - 5775 MHz
Band Edge Frequency 5725 MHz**

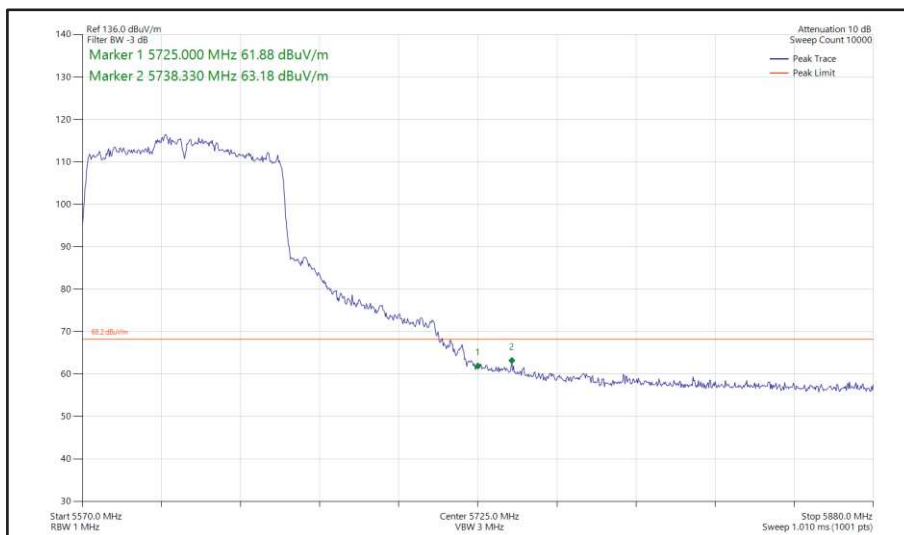

**Figure 577 - 802.11ac VHT80, SDM, Core 0 + Core 1 - 5610 MHz
Band Edge Frequency 5725 MHz**

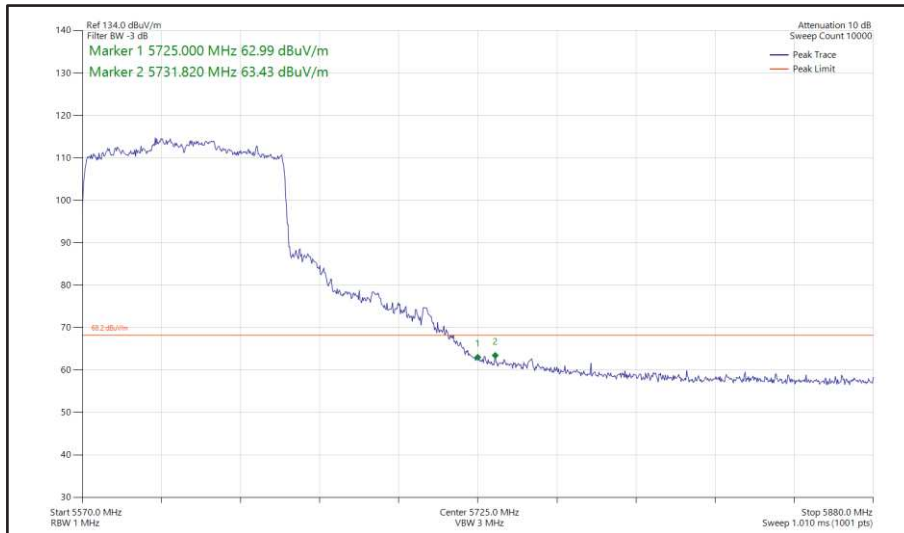

**Figure 578 - 802.11ax HE80, SU, SDM, Core 0 + Core 1 - 5610 MHz
Band Edge Frequency 5725 MHz**

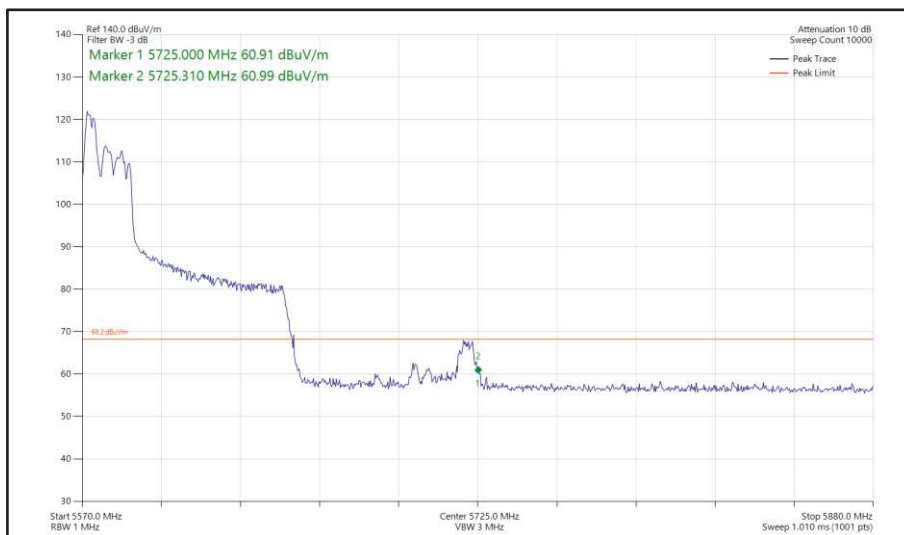

**Figure 579 - 802.11ax HE80, RU 52-37, SDM, Core 0 + Core 1 - 5610 MHz
Band Edge Frequency 5725 MHz**

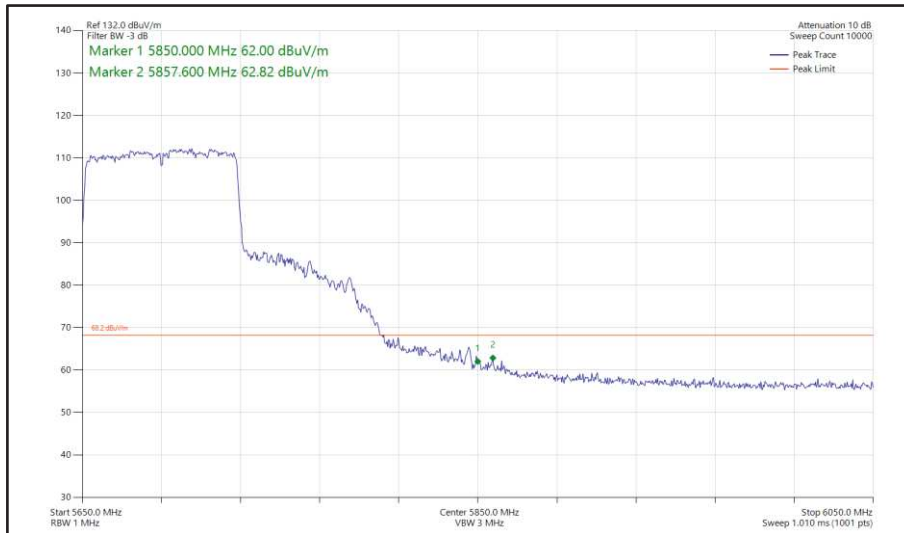

**Figure 580 - 802.11ac VHT80, SDM, Core 0 + Core 1 - 5690 MHz
Band Edge Frequency 5850 MHz**

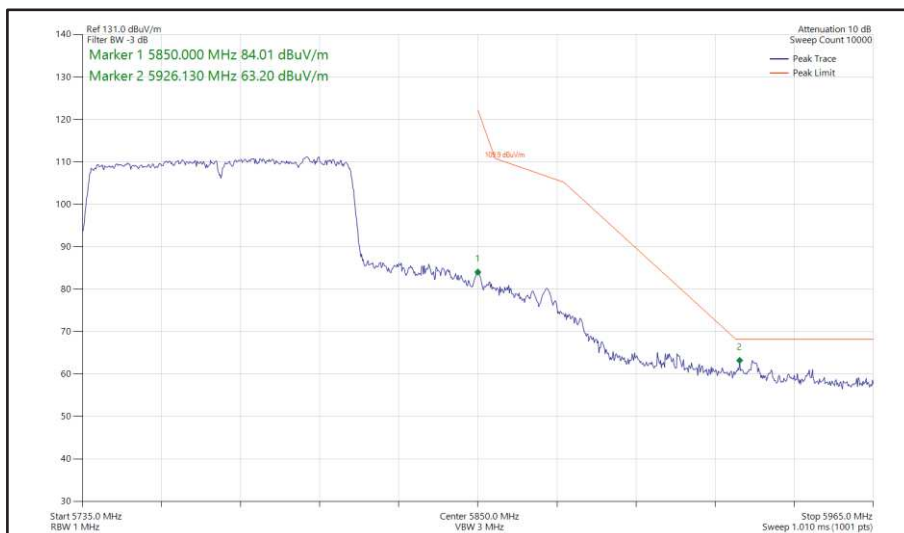

**Figure 581 - 802.11ac VHT80, SDM, Core 0 + Core 1 - 5775 MHz
Band Edge Frequency 5850 MHz**

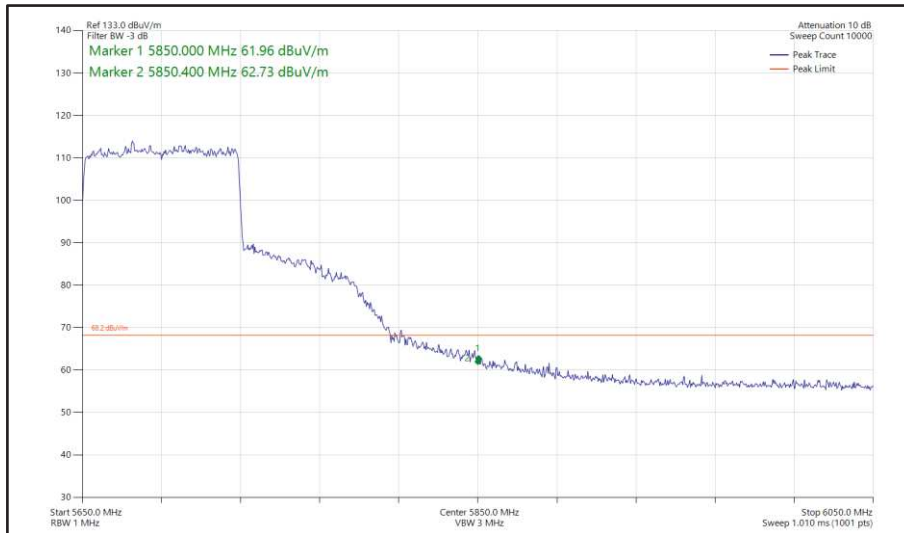

**Figure 582 - 802.11ax HE80, SU, SDM, Core 0 + Core 1 - 5690 MHz
Band Edge Frequency 5850 MHz**

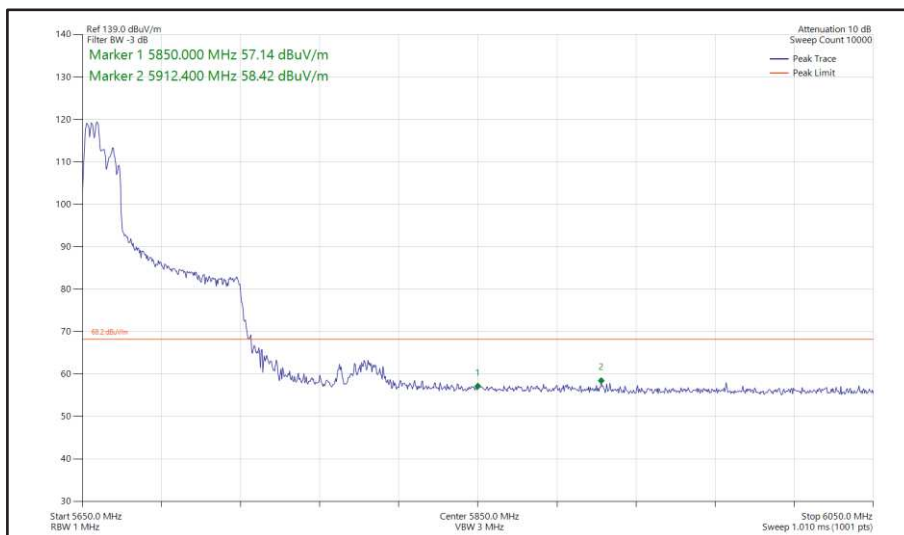

**Figure 583 - 802.11ax HE80, RU 106-53, SDM, Core 0 + Core 1 - 5690 MHz
Band Edge Frequency 5850 MHz**

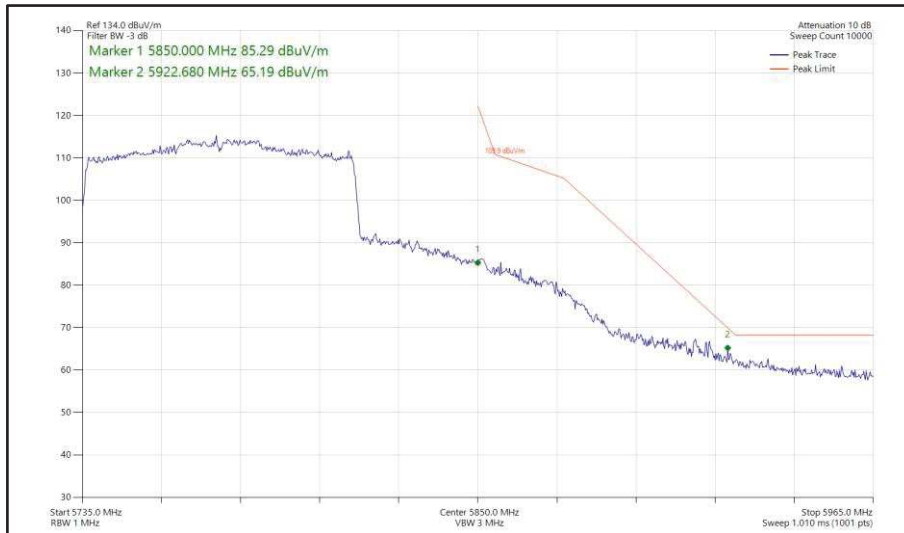

**Figure 584 - 802.11ax HE80, SU, SDM, Core 0 + Core 1 - 5775 MHz
Band Edge Frequency 5850 MHz**

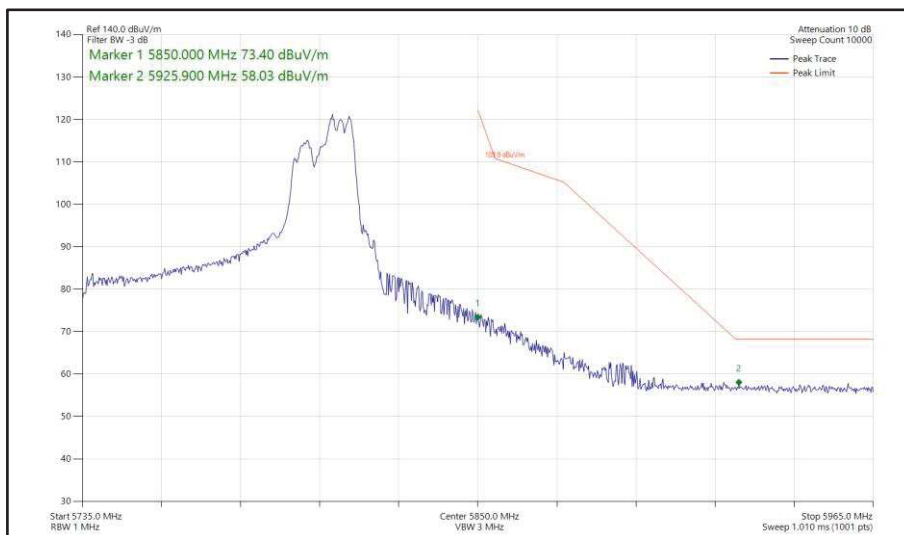

**Figure 585 - 802.11ax HE80, RU 106-60, SDM, Core 0 + Core 1 - 5775 MHz
Band Edge Frequency 5850 MHz**



80 MHz Bandwidth - Core 0 + Core 1 (TxBF)

Mode	Data Rate/MCS	Resource Size	Resource Index	TX Frequency (MHz)	Band Edge Frequency (MHz)	Peak Level (dBµV/m)
802.11ac VHT80	MCS8x1	-	-	5530	5470	63.39
802.11ac VHT80	MCS2x1	-	-	5775	5725	63.93
802.11ac VHT80	MCS8x1	-	-	5610	5725	63.64
802.11ac VHT80	MCS2x1	-	-	5690	5850	62.83
802.11ac VHT80	MCS8x1	-	-	5775	5850	63.43

Table 716 - TxBF Authorised Band Edge Results

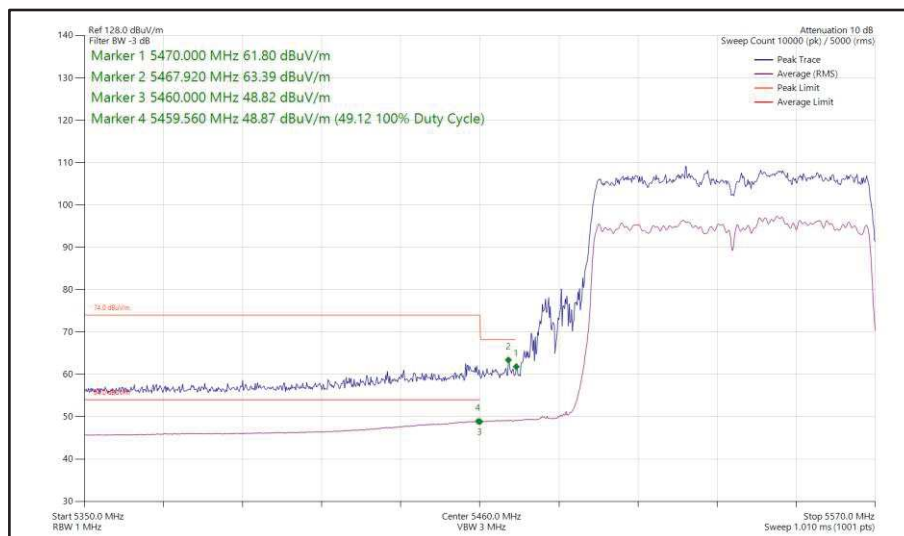

Figure 586 - 802.11ac VHT80, TxBF, Core 0 + Core 1 - 5530 MHz Band Edge Frequency 5470 MHz

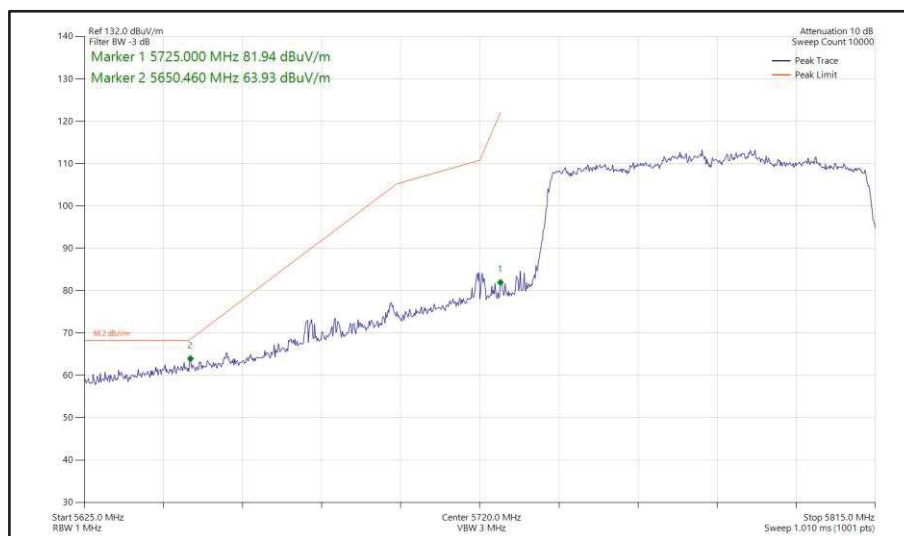
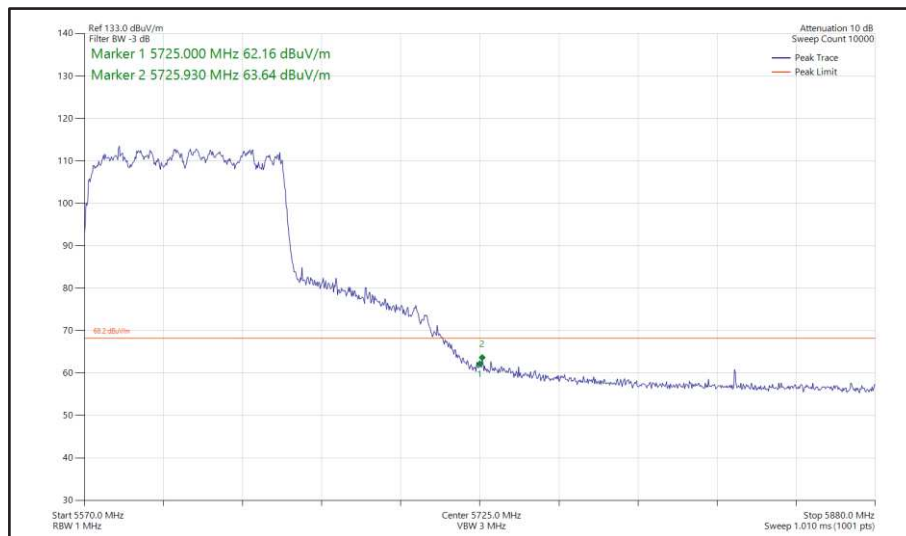
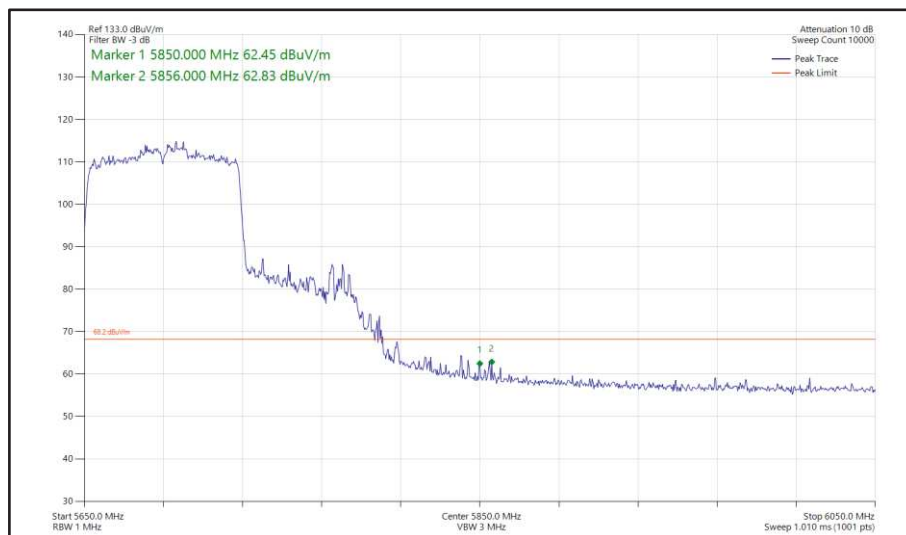

Figure 587 - 802.11ac VHT80, TxBF, Core 0 + Core 1 - 5775 MHz Band Edge Frequency 5725 MHz



**Figure 588 - 802.11ac VHT80, TxBF, Core 0 + Core 1 - 5610 MHz
Band Edge Frequency 5725 MHz**



**Figure 589 - 802.11ac VHT80, TxBF, Core 0 + Core 1 - 5690 MHz
Band Edge Frequency 5850 MHz**

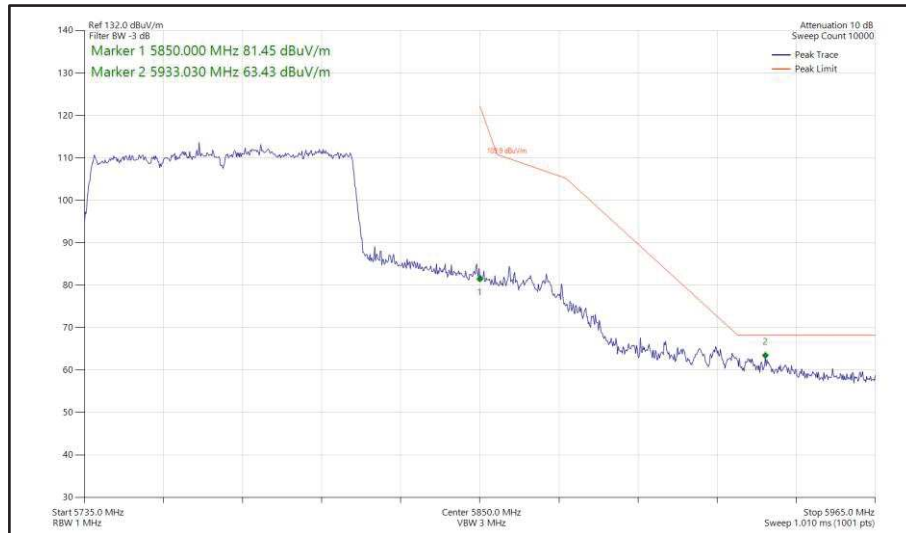

**Figure 590 - 802.11ac VHT80, TxBF, Core 0 + Core 1 - 5775 MHz
Band Edge Frequency 5850 MHz**



160 MHz Bandwidth - Core 0 (SISO)

Mode	Data Rate/MCS	Resource Size	Resource Index	TX Frequency (MHz)	Band Edge Frequency (MHz)	Peak Level (dBμV/m)
802.11ac VHT160	MCS8x1	-	-	5570	5470	61.82
802.11ax HE160	MCS2x1	SU	-	5570	5470	62.82
802.11ax HE160	MCS11x1	106	53	5570	5470	63.52
802.11ac VHT160	MCS8x1	-	-	5570	5725	63.49
802.11ax HE160	MCS11x1	SU	-	5570	5725	63.43
802.11ax HE160	MCS11x1	106	60	5570	5725	62.61

Table 717 - SISO Authorised Band Edge Results

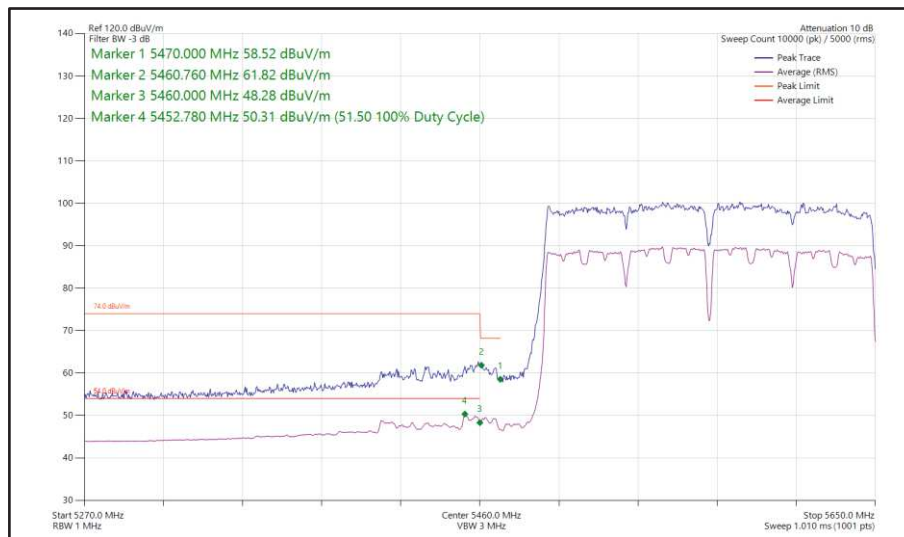

Figure 591 - 802.11ac VHT160, SISO, Core 0 - 5570 MHz
 Band Edge Frequency 5470 MHz

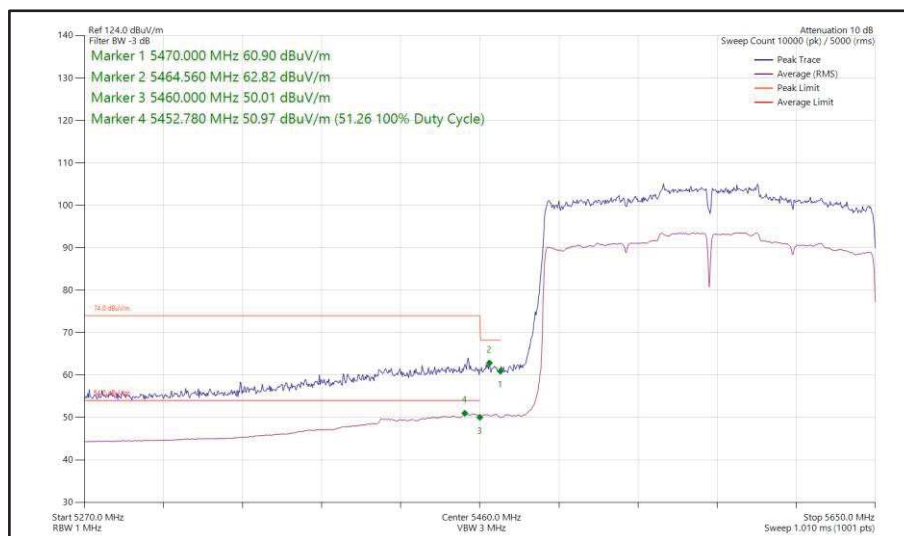
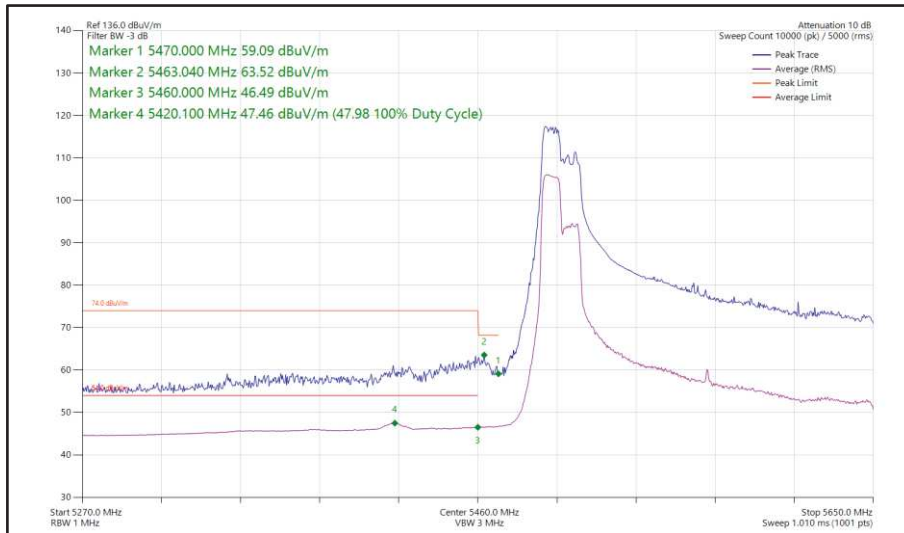
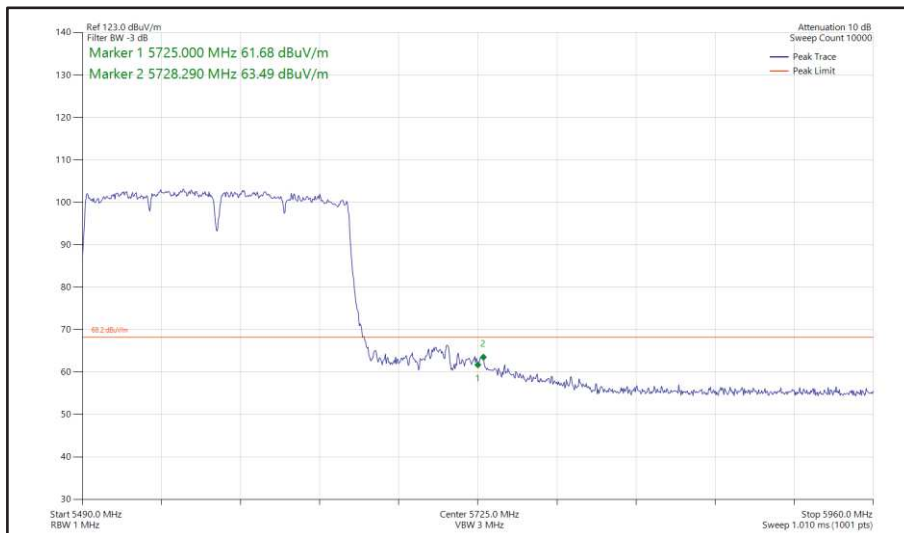

Figure 592 - 802.11ax HE160, SU, SISO, Core 0 - 5570 MHz
 Band Edge Frequency 5470 MHz



**Figure 593 - 802.11ax HE160, RU 106-53, SISO, Core 0 - 5570 MHz
Band Edge Frequency 5470 MHz**



**Figure 594 - 802.11ac VHT160, SISO, Core 0 - 5570 MHz
Band Edge Frequency 5725 MHz**

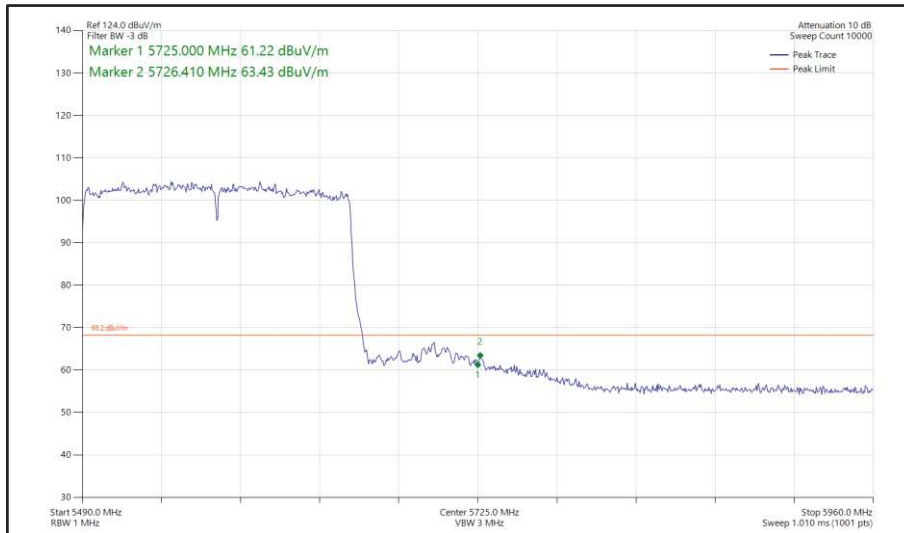

**Figure 595 - 802.11ax HE160, SU, SISO, Core 0 - 5570 MHz
Band Edge Frequency 5725 MHz**

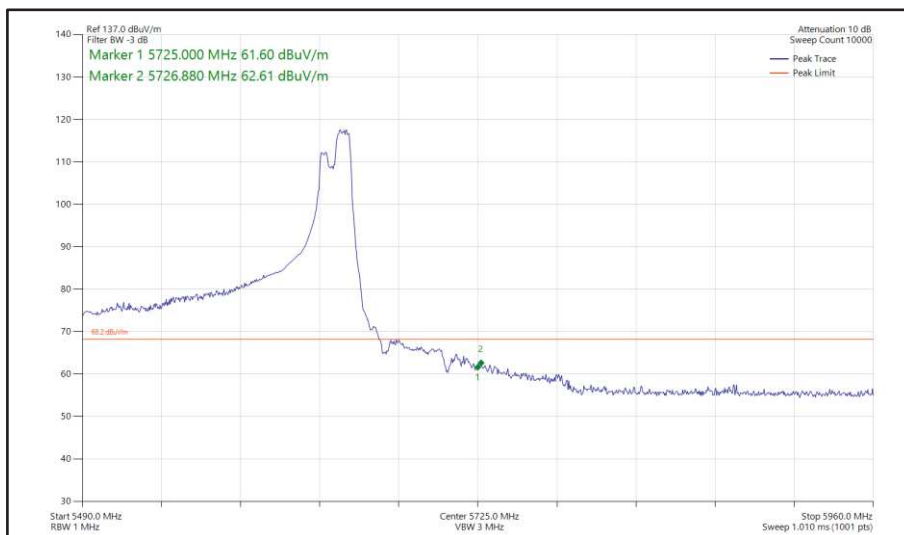

**Figure 596 - 802.11ax HE160, RU 106-60, SISO, Core 0 - 5570 MHz
Band Edge Frequency 5725 MHz**



160 MHz Bandwidth - Core 1 (SISO)

Mode	Data Rate/MCS	Resource Size	Resource Index	TX Frequency (MHz)	Band Edge Frequency (MHz)	Peak Level (dBμV/m)
802.11ac VHT160	MCS2x1	-	-	5570	5470	61.86
802.11ax HE160	MCS11x1	SU	-	5570	5470	63.03
802.11ax HE160	MCS11x1	106	53	5570	5470	63.31
802.11ac VHT160	MCS2x1	-	-	5570	5725	63.63
802.11ax HE160	MCS11x1	SU	-	5570	5725	63.57
802.11ax HE160	MCS11x1	106	60	5570	5725	63.28

Table 718 - SISO Authorised Band Edge Results

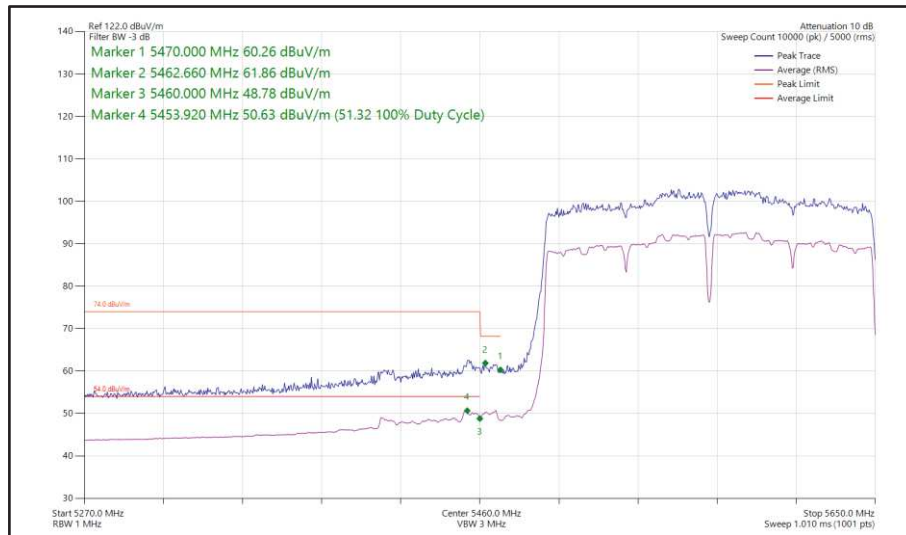

Figure 597 - 802.11ac VHT160, SISO, Core 1 - 5570 MHz
 Band Edge Frequency 5470 MHz

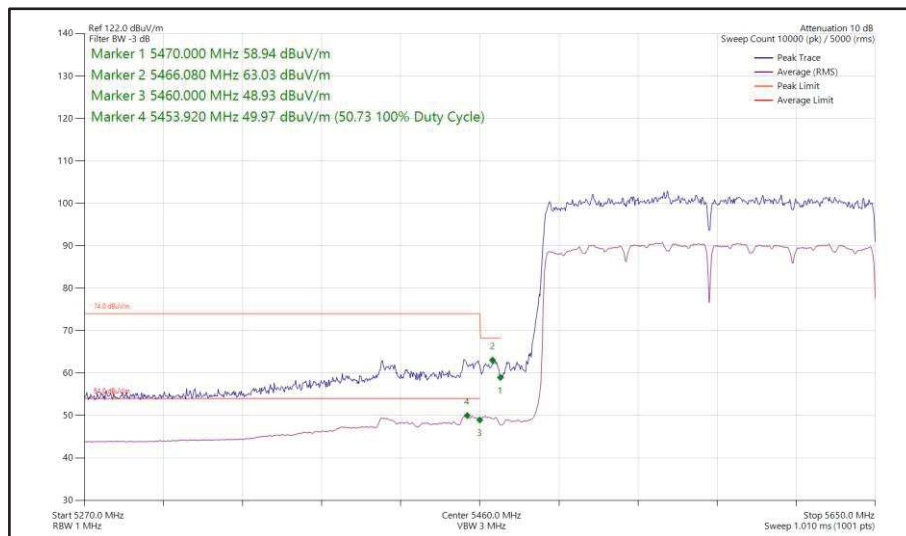
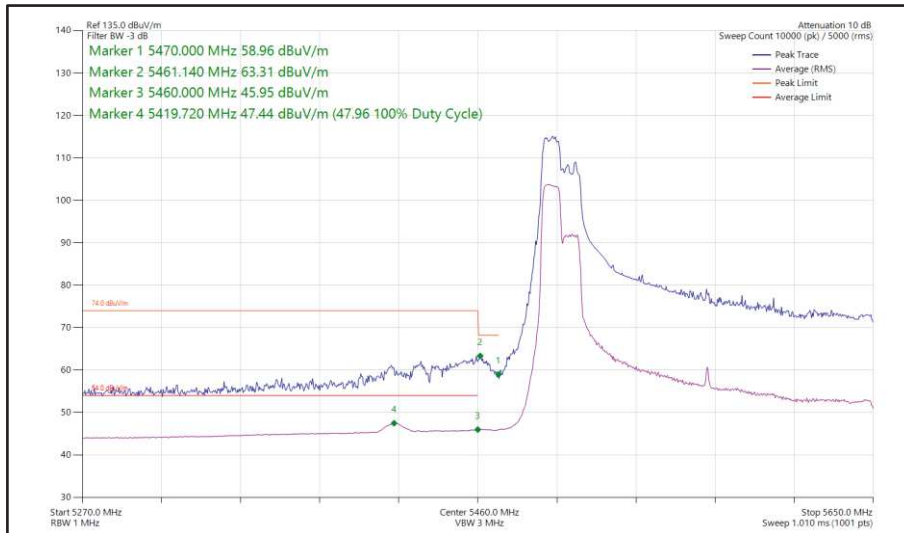
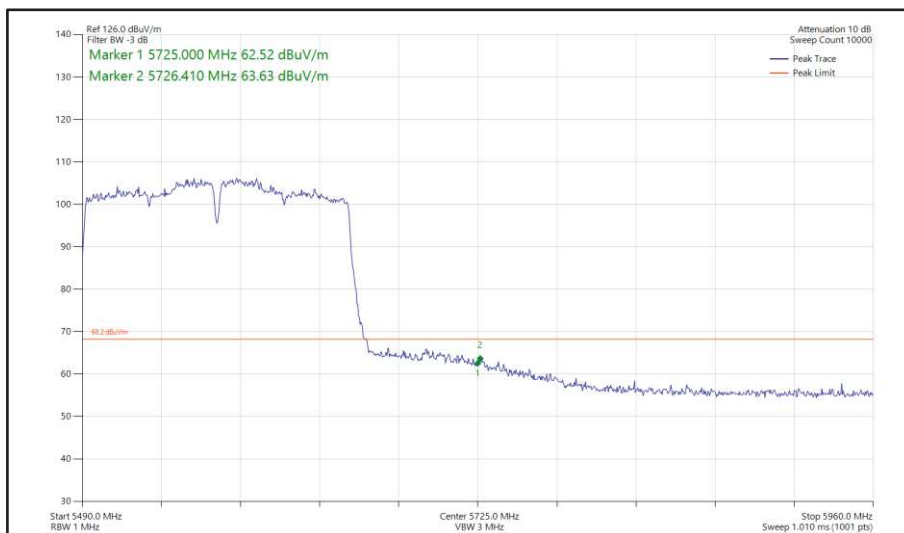

Figure 598 - 802.11ax HE160, SU, SISO, Core 1 - 5570 MHz
 Band Edge Frequency 5470 MHz



**Figure 599 - 802.11ax HE160, RU 106-53, SISO, Core 1 - 5570 MHz
Band Edge Frequency 5470 MHz**



**Figure 600 - 802.11ac VHT160, SISO, Core 1 - 5570 MHz
Band Edge Frequency 5725 MHz**

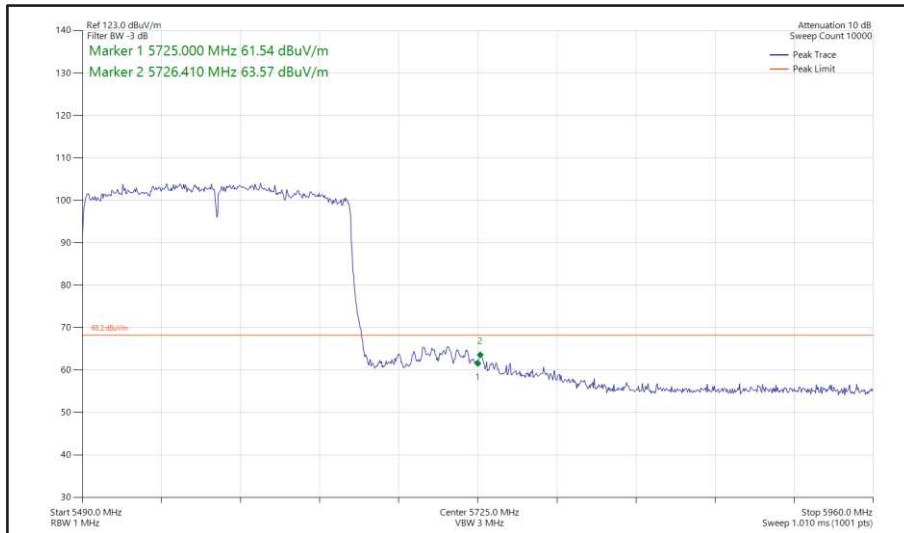

**Figure 601 - 802.11ax HE160, SU, SISO, Core 1 - 5570 MHz
Band Edge Frequency 5725 MHz**

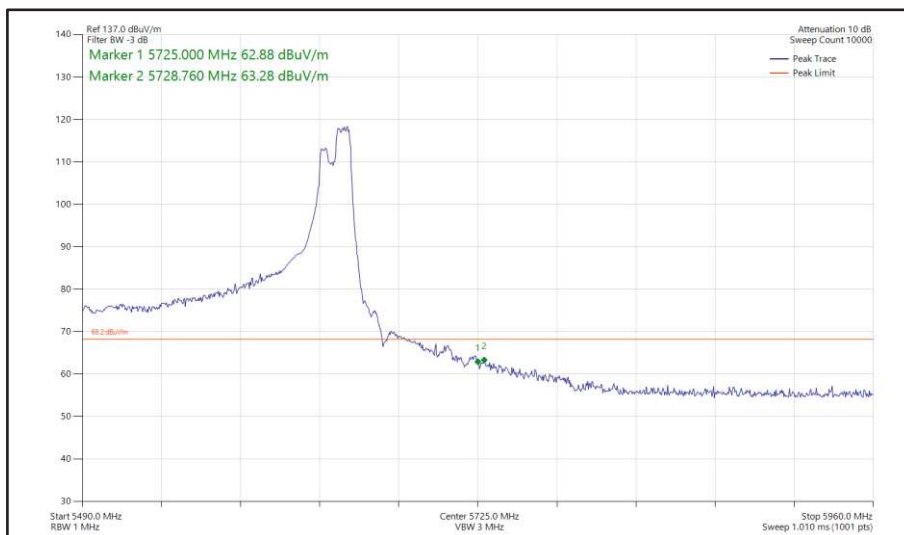

**Figure 602 - 802.11ax HE160, RU 106-60, SISO, Core 1 - 5570 MHz
Band Edge Frequency 5725 MHz**



160 MHz Bandwidth - Core 0 + Core 1 (CDD)

Mode	Data Rate/ MCS	Resource Size	Resource Index	TX Frequency (MHz)	Band Edge Frequency (MHz)	Peak Level (dB μ V/m)
802.11ac VHT160	MCS8x1	-	-	5570	5470	62.68
802.11ax HE160	MCS4x1	SU	-	5570	5470	63.32
802.11ax HE160	MCS11x1	106	53	5570	5470	63.23
802.11ac VHT160	MCS4x1	-	-	5570	5725	63.65
802.11ax HE160	MCS11x1	SU	-	5570	5725	63.59
802.11ax HE160	MCS11x1	52	52	5570	5725	63.54

Table 719 - CDD Authorised Band Edge Results

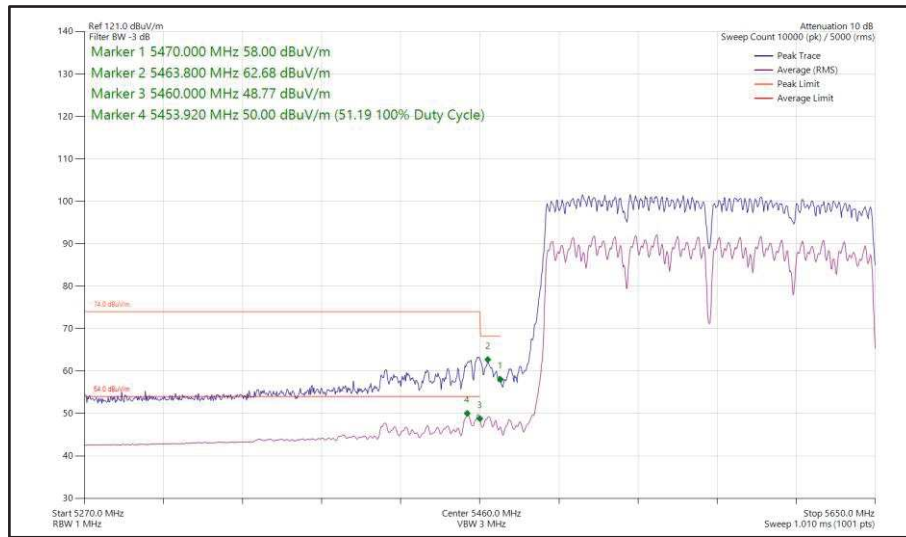

Figure 603 - 802.11ac VHT160, CDD, Core 0 + Core 1 - 5570 MHz
 Band Edge Frequency 5470 MHz

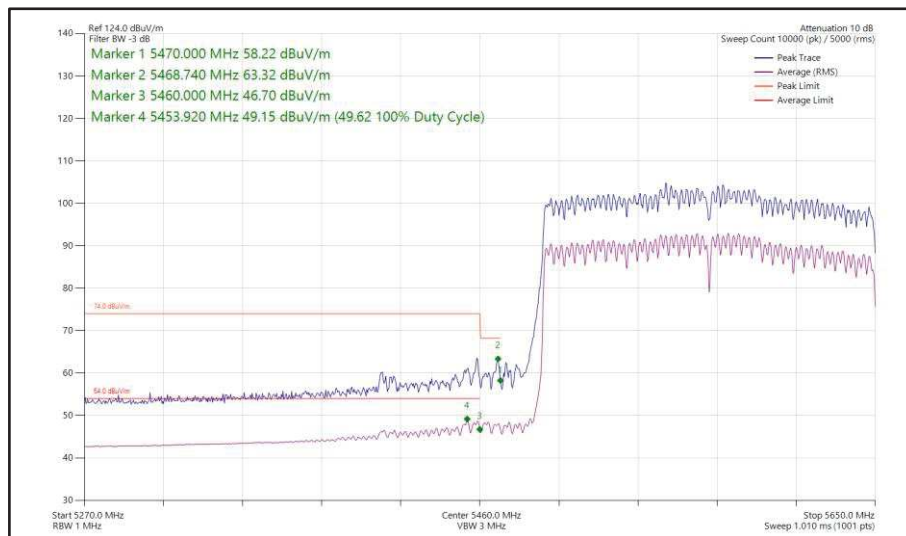
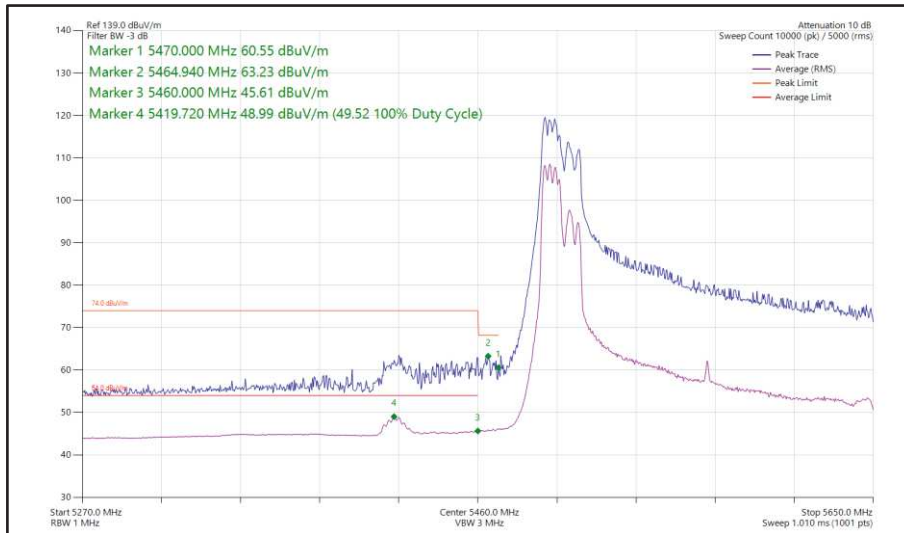
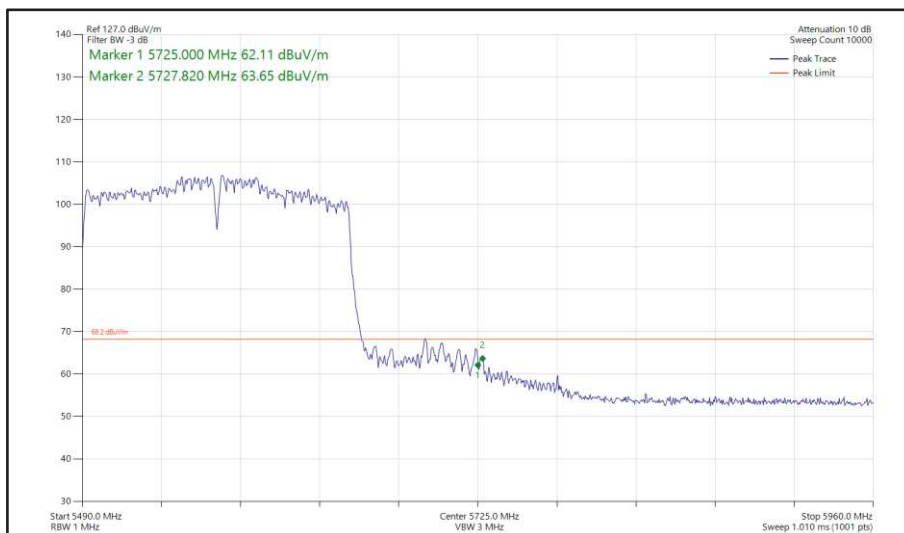

Figure 604 - 802.11ax HE160, SU, CDD, Core 0 + Core 1 - 5570 MHz
 Band Edge Frequency 5470 MHz



**Figure 605 - 802.11ax HE160, RU 106-53, CDD, Core 0 + Core 1 - 5570 MHz
Band Edge Frequency 5470 MHz**



**Figure 606 - 802.11ac VHT160, CDD, Core 0 + Core 1 - 5570 MHz
Band Edge Frequency 5725 MHz**

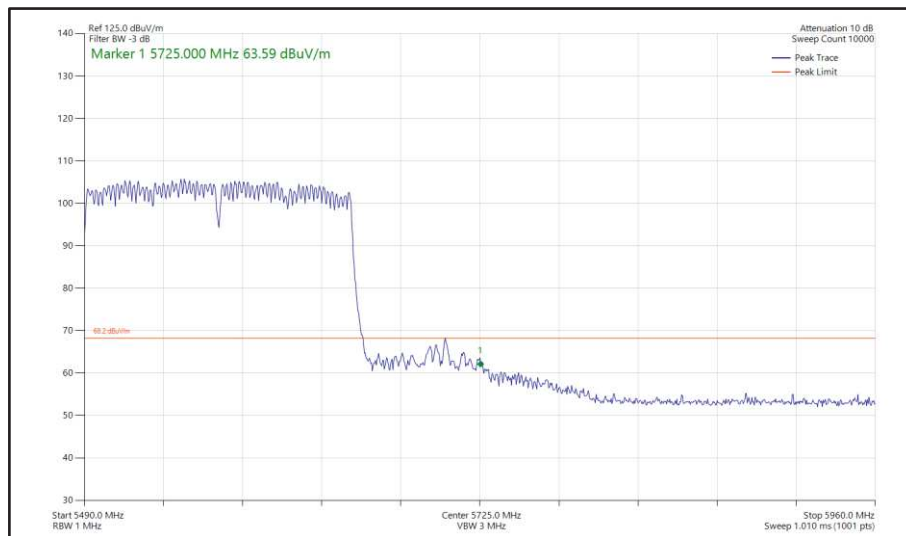

**Figure 607 - 802.11ax HE160, SU, CDD, Core 0 + Core 1 - 5570 MHz
Band Edge Frequency 5725 MHz**

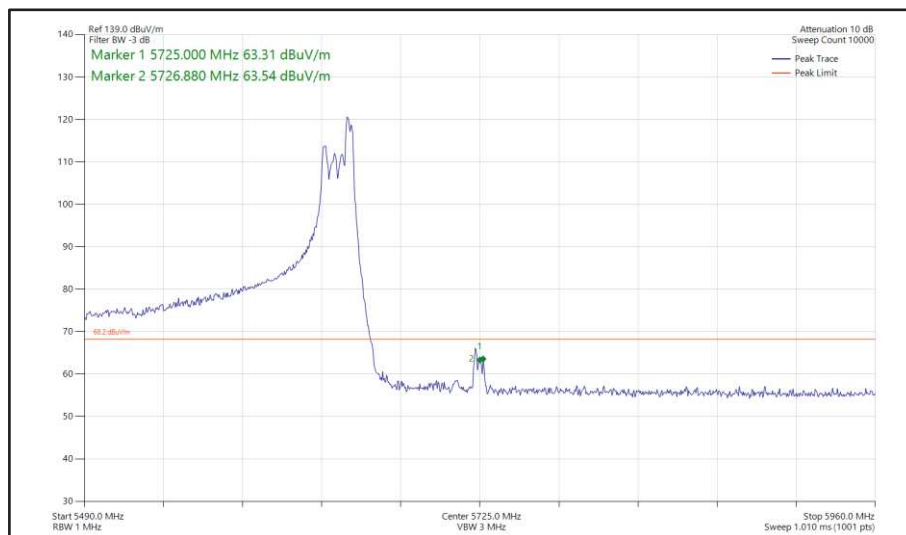

**Figure 608 - 802.11ax HE160, RU 52-52, CDD, Core 0 + Core 1 - 5570 MHz
Band Edge Frequency 5725 MHz**



160 MHz Bandwidth - Core 0 + Core 1 (SDM)

Mode	Data Rate/ MCS	Resource Size	Resource Index	TX Frequency (MHz)	Band Edge Frequency (MHz)	Peak Level (dB μ V/m)
802.11ac VHT160	MCS2x2	-	-	5570	5470	63.47
802.11ax HE160	MCS4x2	SU	-	5570	5470	63.44
802.11ax HE160	MCS11x2	52	37	5570	5470	63.26
802.11ac VHT160	MCS8x2	-	-	5570	5725	63.62
802.11ax HE160	MCS2x2	SU	-	5570	5725	63.56
802.11ax HE160	MCS11x2	52	52	5570	5725	63.67

Table 720 - SDM Authorised Band Edge Results

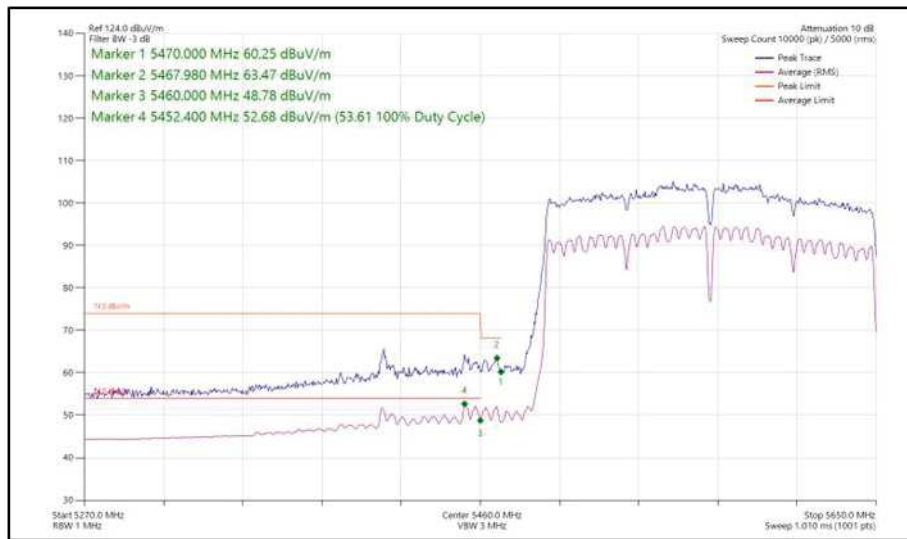

Figure 609 - 802.11ac VHT160, SDM, Core 0 + Core 1 - 5570 MHz
 Band Edge Frequency 5470 MHz

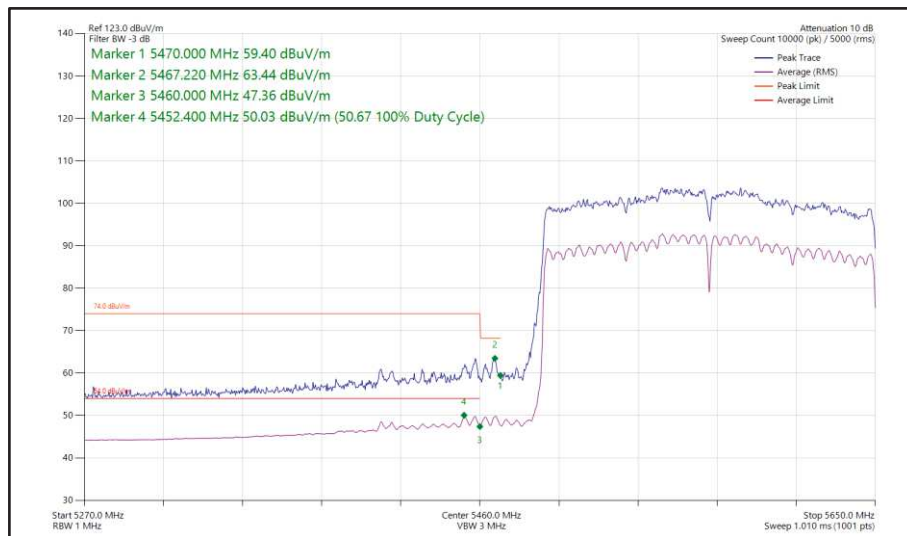
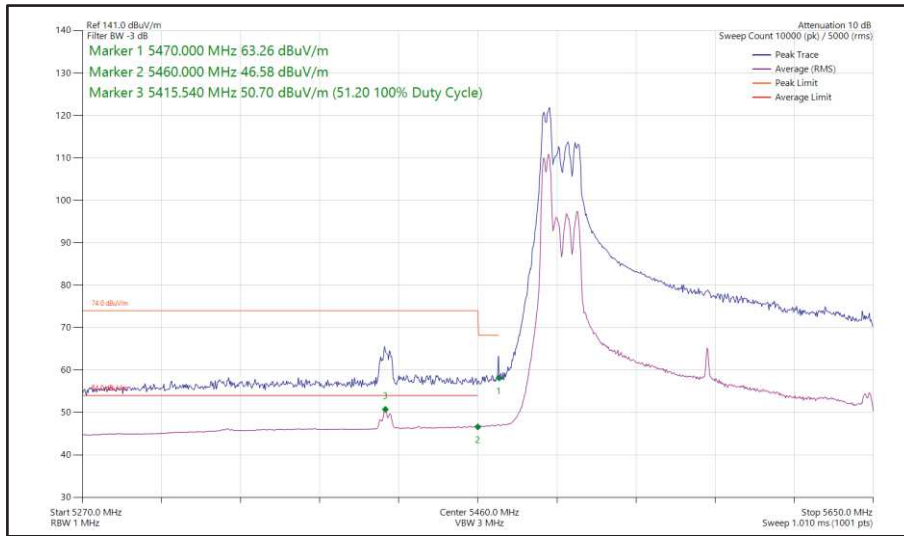
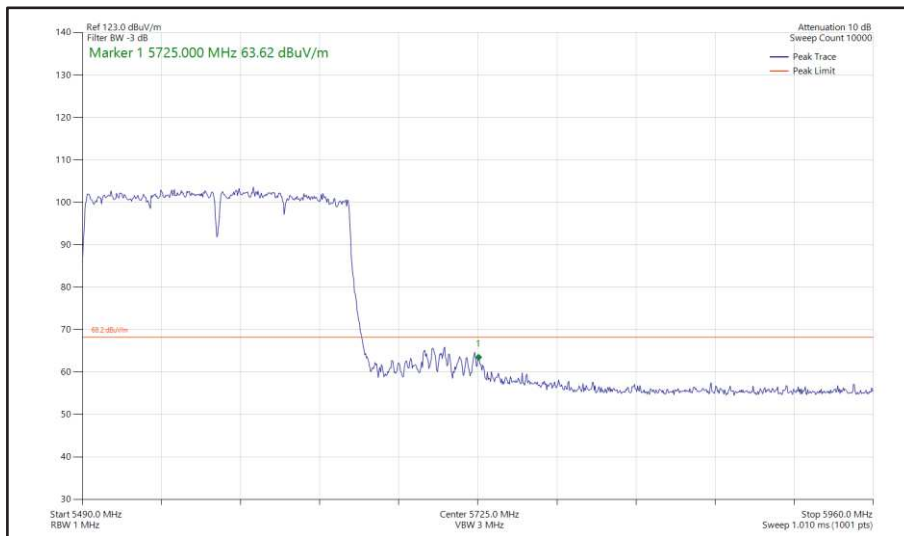

Figure 610 - 802.11ax HE160, SU, SDM, Core 0 + Core 1 - 5570 MHz
 Band Edge Frequency 5470 MHz



**Figure 611 - 802.11ax HE160, RU 52-37, SDM, Core 0 + Core 1 - 5570 MHz
Band Edge Frequency 5470 MHz**



**Figure 612 - 802.11ac VHT160, SDM, Core 0 + Core 1 - 5570 MHz
Band Edge Frequency 5725 MHz**

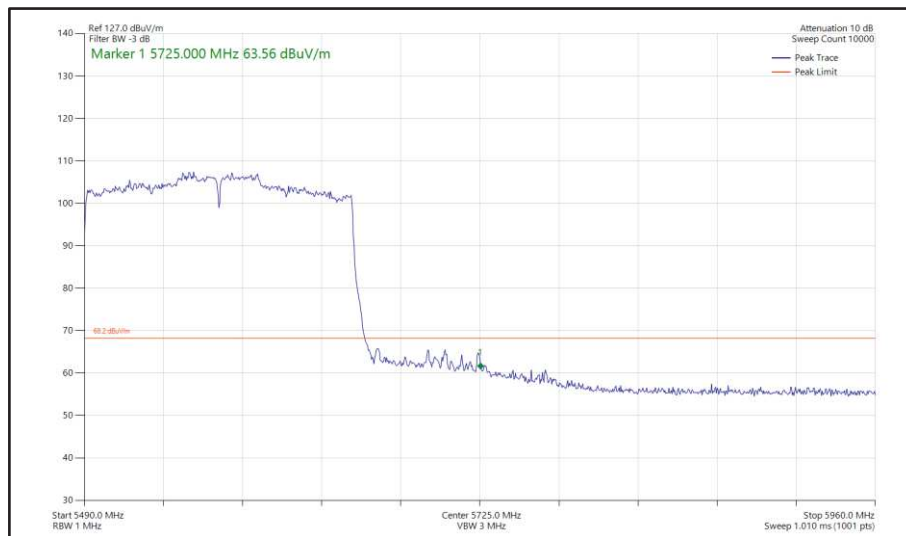

**Figure 613 - 802.11ax HE160, SU, SDM, Core 0 + Core 1 - 5570 MHz
Band Edge Frequency 5725 MHz**

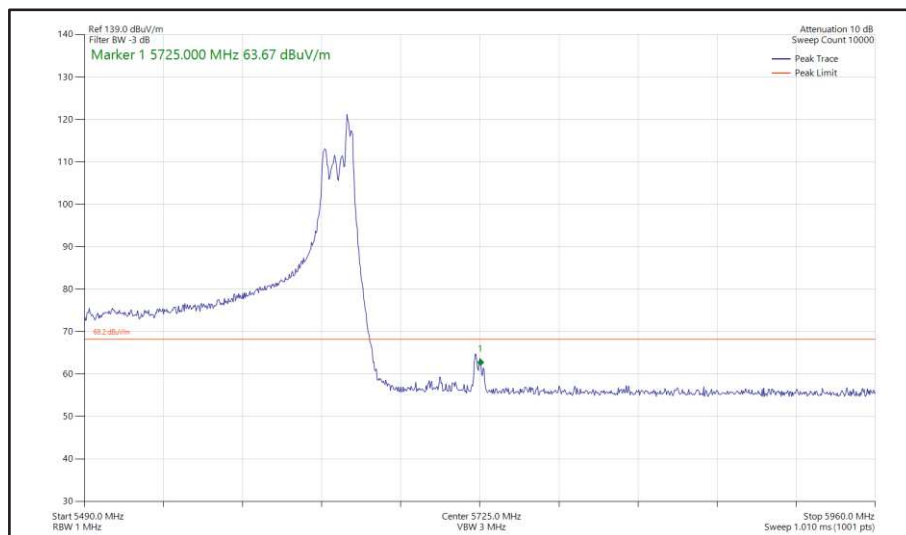

**Figure 614 - 802.11ax HE160, RU 52-52, SDM, Core 0 + Core 1 - 5570 MHz
Band Edge Frequency 5725 MHz**



FCC 47 CFR Part 15E, Limit Clause 15.407(b)(1)(2)(3)(4)

For transmitters operating in the 5.15-5.25 GHz band: ≤ -27 dBm/MHz outside 5150-5350 MHz.

For transmitters operating in the 5.25-5.35 GHz band: ≤ -27 dBm/MHz outside 5150-5350 MHz.

For transmitters operating in the 5.47-5.725 GHz band: ≤ -27 dBm/MHz outside 5470-5725 MHz

For transmitters operating in the 5.725-5.85 GHz band: All emissions shall be limited to a level of -27 dBm/MHz at 75 MHz or more above or below the band edge increasing linearly to 10 dBm/MHz at 25 MHz above or below the band edge, and from 25 MHz above or below the band edge increasing linearly to a level of 15.6 dBm/MHz at 5 MHz above or below the band edge, and from 5 MHz above or below the band edge increasing linearly to a level of 27 dBm/MHz at the band edge.

ISED RSS-247, Limit Clause 6.2.1.2, 6.2.2.2, 6.2.3.2 and 6.2.4.2

For transmitters with operating frequencies in the band 5150-5250 MHz, all emissions outside the band 5150-5350 MHz shall not exceed -27 dBm/MHz e.i.r.p. Any unwanted emissions that fall into the band 5250-5350 MHz shall be attenuated below the channel power by at least 26 dB.

For transmitters with operating frequencies in the bands 5250-5350 MHz and 5470-5725 MHz, all emissions outside the band 5250-5350 MHz and 5470-5725 MHz shall not exceed -27 dBm/MHz e.i.r.p.

Devices operating in the band 5725-5850 MHz shall have e.i.r.p. of unwanted emissions comply with the following:

- a) 27 dBm/MHz at frequencies from the band edges decreasing linearly to 15.6 dBm/MHz at 5 MHz above or below the band edges;
- b) 15.6 dBm/MHz at 5 MHz above or below the band edges decreasing linearly to 10 dBm/MHz at 25 MHz above or below the band edges;
- c) 10 dBm/MHz at 25 MHz above or below the band edges decreasing linearly to -27 dBm/MHz at 75 MHz above or below the band edges; and
- d) -27 dBm/MHz at frequencies more than 75 MHz above or below the band edges.



2.5.7 Test Location and Test Equipment Used

This test was carried out in RF Chamber 14 and RF Chamber 15.

Instrument	Manufacturer	Type No.	TE No.	Calibration Period (months)	Calibration Expiry Date
Cable (18 GHz)	Rosenberger	LU7-071-1000	5096	12	23-Oct-2023
Emissions Software	TUV SUD	EmX V3.1.12	5125	-	Software
Pre-amplifier (30 dB, 1GHz to 18GHz)	Schwarzbeck	BBV 9718 C	5261	12	14-Apr-2024
EMI Test Receiver	Rohde & Schwarz	ESW44	5911	12	05-May-2024
Test Receiver	Rohde & Schwarz	ESW44	5914	12	24-Feb-2024
1500W (300V 12A) AC Power Supply	iTech	IT7324	5955	-	O/P Mon
1500W (300V 12A) AC Power Supply	iTech	IT7324	5956	-	O/P Mon
5m Semi-Anechoic Chamber (Dual-Axis)	Albatross Projects	RF Chamber 14	5958	36	26-Apr-2025
Mast & Turntable Controller	Maturo Gmbh	FCU3.0	5960	-	TU
Tilt Antenna Mast	Maturo Gmbh	BAM4.5-P	5961	-	TU
Turntable	Maturo Gmbh	TT1.5SI	5962	-	TU
5m Semi-Anechoic Chamber (Dual-Axis)	Albatross Projects	RF Chamber 15	5963	36	28-Apr-2025
Mast & Turntable Controller	Maturo Gmbh	FCU3.0	5966	-	TU
Tilt Antenna Mast	Maturo Gmbh	BAM4.5-P	5967	-	TU
Turntable	Maturo Gmbh	TT1.5SI	5968	-	TU
Cable (SMA to SMA 6.5m)	Junkosha	MWX221-06500AMSAMS/B	6003	12	05-Jun-2024
Cable (SMA to SMA 6.5m)	Junkosha	MWX221-06500AMSAMS/B	6014	12	08-Aug-2023
Horn Antenna (1-10 GHz)	Schwarzbeck	BBHA9120B	6140	12	21-Aug-2023
Horn Antenna (1-10 GHz)	Schwarzbeck	BBHA9120B	6141	12	21-Aug-2023
Digital Multimeter	Fluke	115	6145	12	15-Jun-2024
Digital Multimeter	Fluke	115	6147	12	16-Jun-2024
Humidity & Temperature meter	R.S Components	1364	6149	12	17-Sep-2023
SAC Switch Unit	TUV SUD	TUV_SSU_001	6191	12	12-Dec-2023
Cable (SMA to SMA 1m)	Junkosha	MWX221-01000AMSAMS/A	6315	12	04-Feb-2024
Humidity and Temperature Meter	R.S Components	1364	6486	12	18-Apr-2024

Table 721

TU - Traceability Unscheduled
 O/P Mon – Output Monitored using calibrated equipment



2.6 Spurious Radiated Emissions

2.6.1 Specification Reference

FCC 47 CFR Part 15E, Clause 15.209 and 15.407 (b)
ISED RSS-247, Clause 6.2
ISED RSS-GEN, Clause 6.13 and 8.9

2.6.2 Equipment Under Test and Modification State

A2991, S/N: N7RTH0WPW3 - Modification State 0

2.6.3 Date of Test

20-July-2023 to 26-July-2023

2.6.4 Test Method

Testing was performed in accordance with ANSI C63.10, clause 6.3, 6.5 and 6.6.

Tests were performed at maximum output power in HT20 CDD MIMO mode, 802.11a SISO modes (both Core 0 & 1), and HE20 CDD mode with the narrowest supported RU size for each band. Measurements were undertaken from 30 MHz to 40 GHz on channel 36 and 165. Testing was limited to 1 GHz to 40 GHz on channels 64, 100, 140 and 149. All testing was performed using the lowest data rate/modulation scheme for the applicable mode.

Plots for average measurements were taken in accordance with ANSI C63.10, clause 12.7.7.2 with max hold trace to characterize the EUT. Where emissions were detected, final average measurements were taken using trace averaging.

The plots shown are the characterization of the EUT. The limits on the plots represent the most stringent case for restricted bands, (54/74 dBuV/m @ 3 m and 64/84 dBuV/m @ 1m) when compared to -27 dBm/MHz EIRP outside restricted bands. The limits shown have been used as a threshold to determine where further measurements are necessary. Where results are within 10dB of the limits shown on the plots, further investigation was carried out and reported in results tables.

The following conversion can be applied to convert from dB μ V/m to μ V/m:
 $10^{(\text{Field Strength in dB}\mu\text{V/m}/20)}$.

EIRP was converted to field strength at 3m using the following formula:
Field Strength (dB μ V/m at 3 m) = EIRP (dBm) + 95.2 dB.

2.6.5 Test Setup Diagram

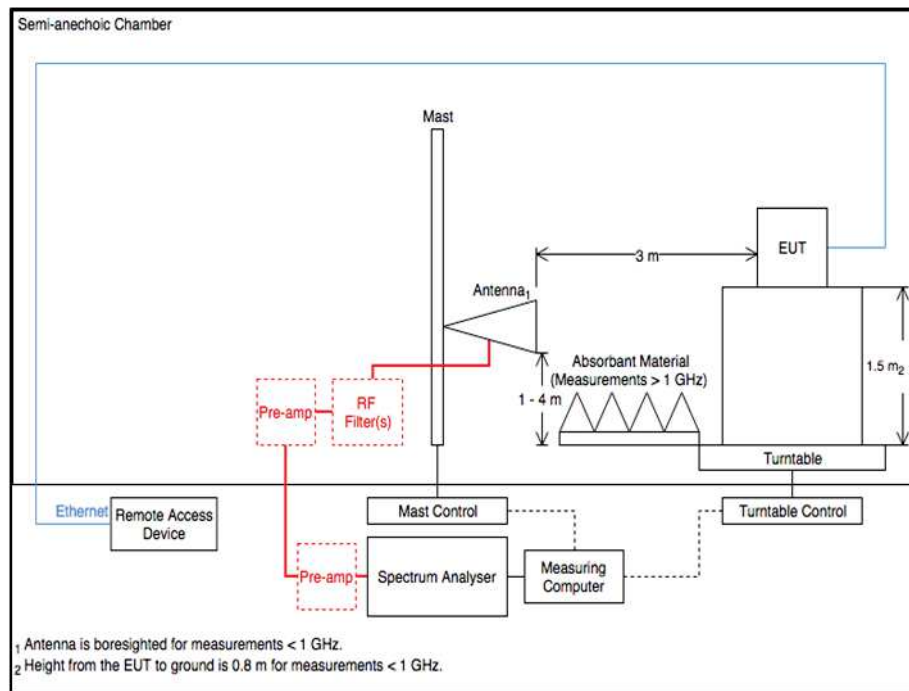

Figure 615 - Radiated Emissions Test Setup Diagram

2.6.6 Environmental Conditions

Ambient Temperature 21.2 - 23.0 °C
Relative Humidity 35.2 - 51.0 %



2.6.7 Test Results

5 GHz WLAN

Frequency (MHz)	Level (dBuV/m)	Limit (dBuV/m)	Margin (dB)	Detector	Angle (°)	Height (cm)	Polarisation
68.847	37.01	40.00	-2.99	Q-Peak	213	100	Vertical
69.128	25.52	40.00	-14.48	Q-Peak	0	345	Horizontal
15539.840	34.80	54.00	-19.20	RMS	285	100	Vertical

Table 722 - U-NII-1 - 5180 MHz (CH36), HT20, CDD, Core 0 + Core 1, 30 MHz to 40 GHz

No other emissions found within 10 dB of the limit.

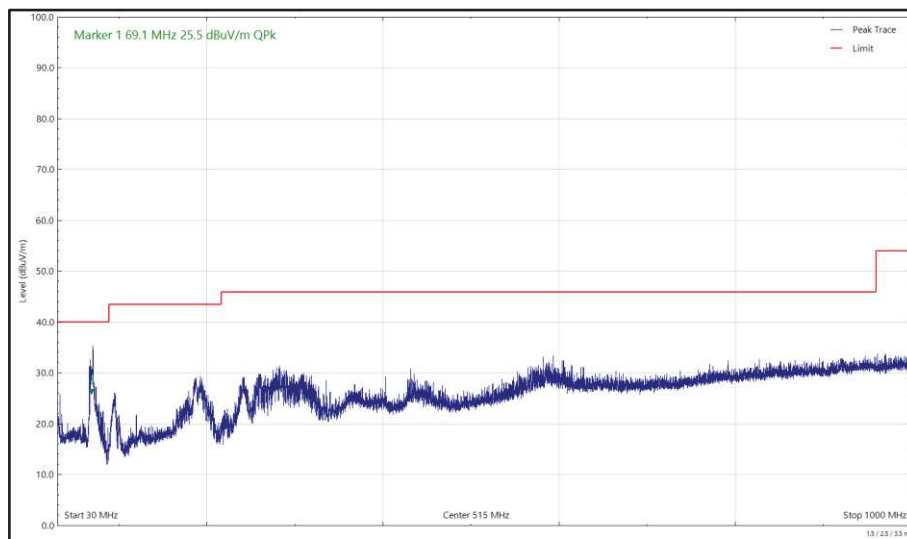

Figure 616 - U-NII-1 - 5180 MHz (CH36), HT20, CDD, Core 0 + Core 1, 30 MHz to 1 GHz, Horizontal (Peak)

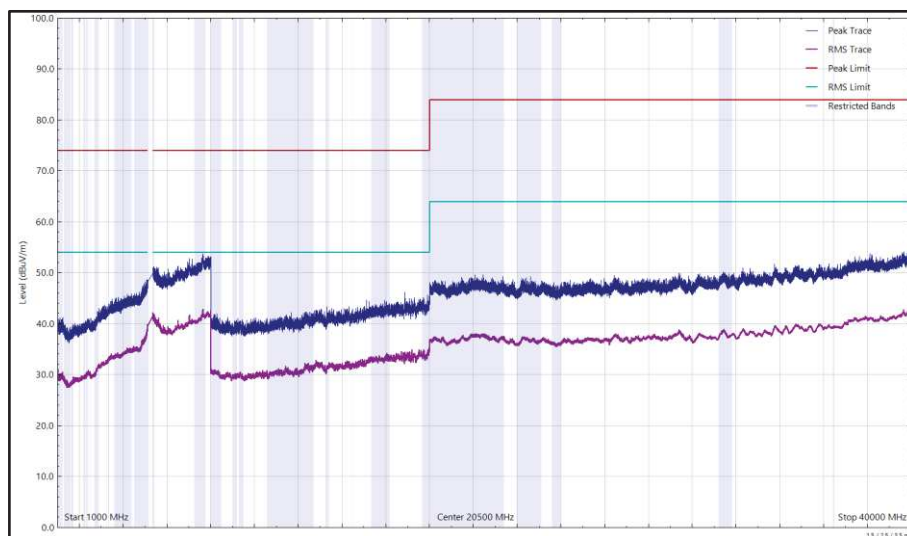

Figure 617 - U-NII-1 - 5180 MHz (CH36), HT20, CDD, Core 0 + Core 1, 1 GHz to 40 GHz, Horizontal

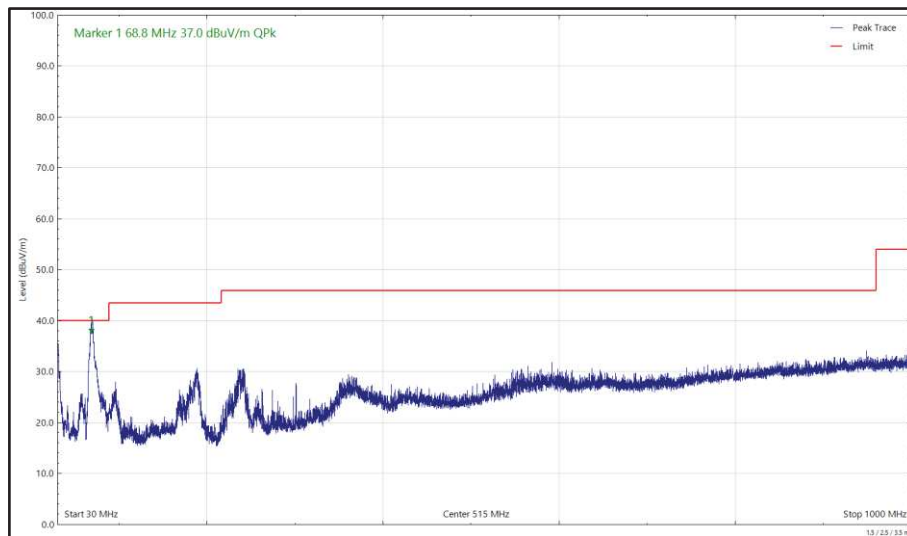

Figure 618 - U-NII-1 - 5180 MHz (CH36), HT20, CDD, Core 0 + Core 1, 30 MHz to 1 GHz, Vertical (Peak)

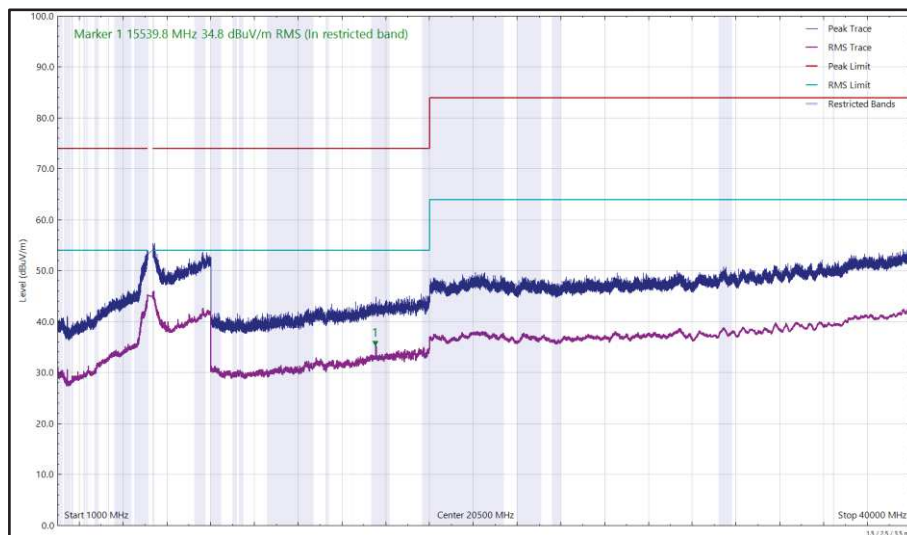

Figure 619 - U-NII-1 - 5180 MHz (CH36), HT20, CDD, Core 0 + Core 1, 1 GHz to 40 GHz, Vertical



Frequency (MHz)	Level (dBuV/m)	Limit (dBuV/m)	Margin (dB)	Detector	Angle (°)	Height (cm)	Polarisation
*							

Table 723 - U-NII-2A - 5320 MHz (CH64), HT20, CDD, Core 0 + Core 1, 1 GHz to 40 GHz

*No emissions found within 10 dB of the limit.

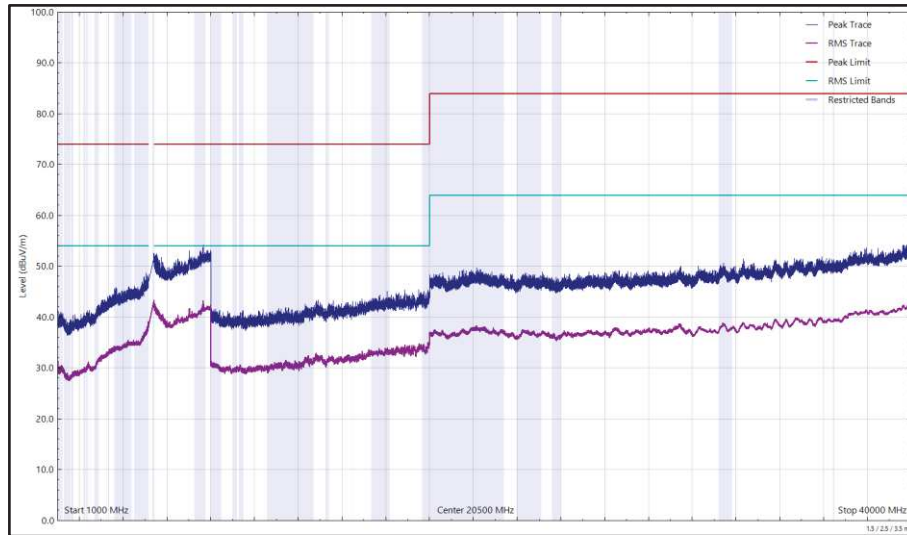

Figure 620 - U-NII-2A - 5320 MHz (CH64), HT20, CDD, Core 0 + Core 1, 1 GHz to 40 GHz, Horizontal

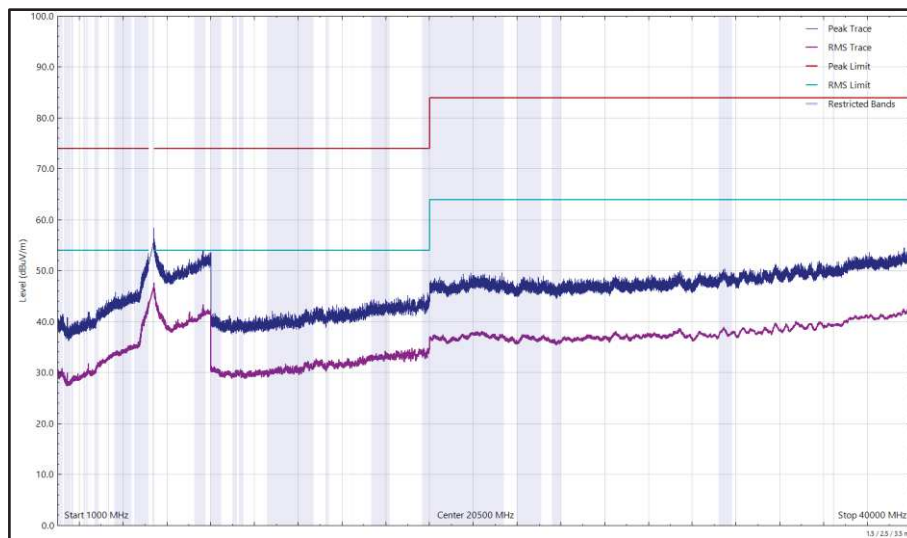

Figure 621 - U-NII-2A - 5320 MHz (CH64), HT20, CDD, Core 0 + Core 1, 1 GHz to 40 GHz, Vertical



Frequency (MHz)	Level (dBuV/m)	Limit (dBuV/m)	Margin (dB)	Detector	Angle (°)	Height (cm)	Polarisation
*							

Table 724 - U-NII-2C - 5500 MHz (CH100), HT20, CDD, Core 0 + Core 1, 1 GHz to 40 GHz

*No emissions found within 10 dB of the limit.

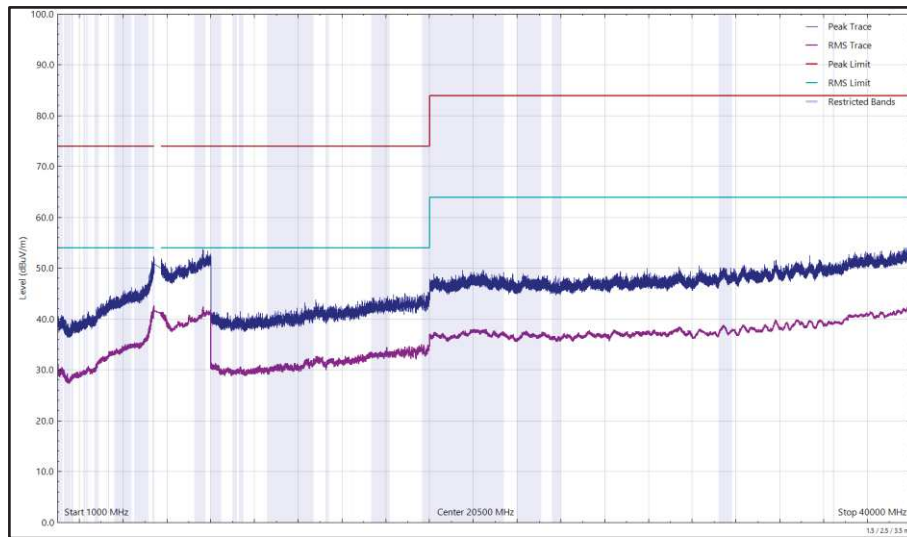

Figure 622 - U-NII-2C - 5500 MHz (CH100), HT20, CDD, Core 0 + Core 1, 1 GHz to 40 GHz, Horizontal

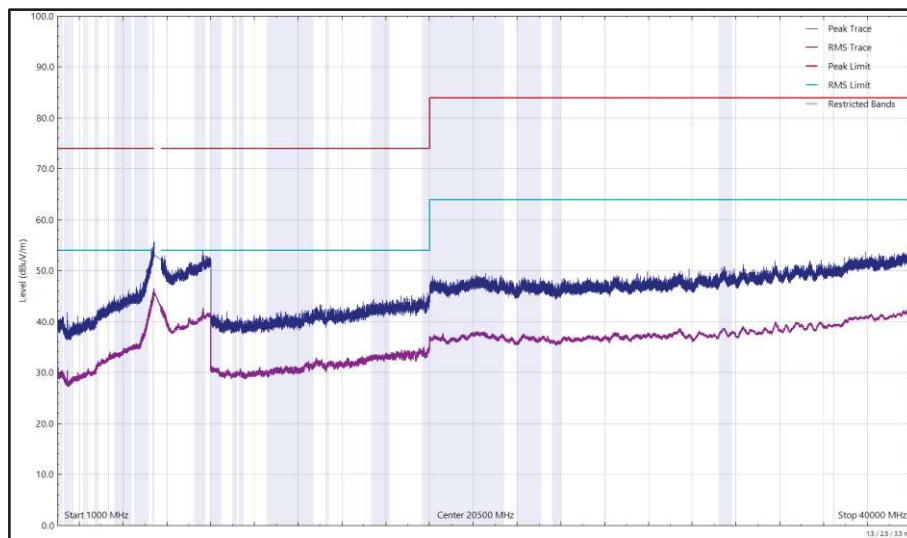

Figure 623 - U-NII-2C - 5500 MHz (CH100), HT20, CDD, Core 0 + Core 1, 1 GHz to 40 GHz, Vertical



Frequency (MHz)	Level (dBuV/m)	Limit (dBuV/m)	Margin (dB)	Detector	Angle (°)	Height (cm)	Polarisation
*							

Table 725 - U-NII-2C - 5700 MHz (CH140), HT20, CDD, Core 0 + Core 1, 1 GHz to 40 GHz

*No emissions found within 10 dB of the limit.

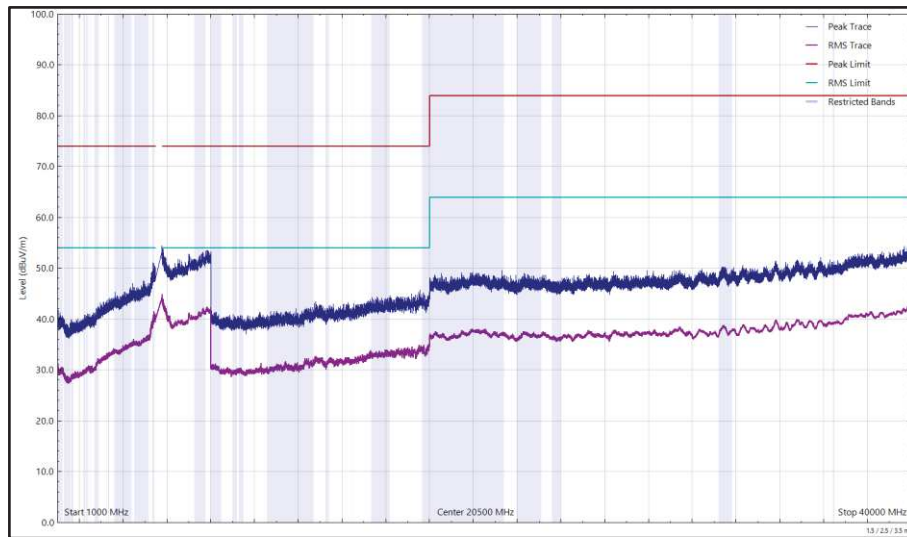

Figure 624 - U-NII-2C - 5700 MHz (CH140), HT20, CDD, Core 0 + Core 1, 1 GHz to 40 GHz, Horizontal

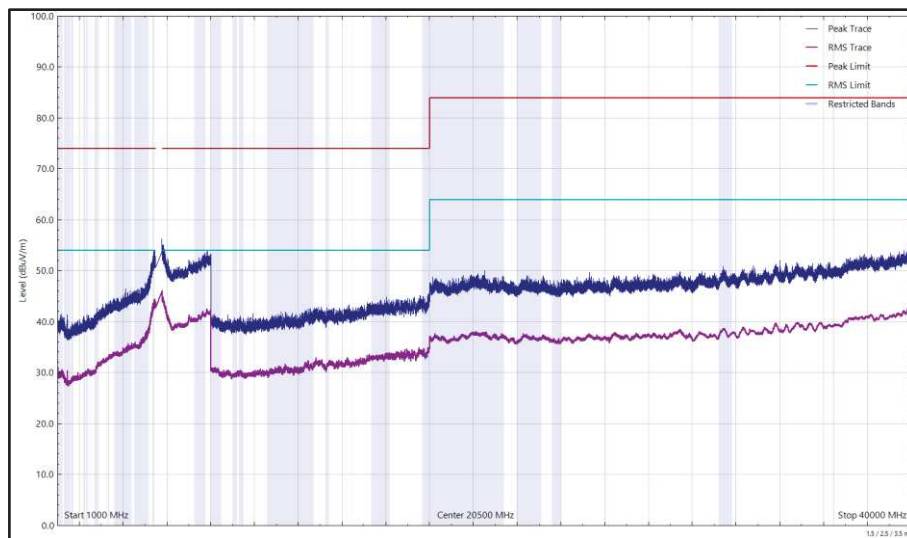

Figure 625 - U-NII-2C - 5700 MHz (CH140), HT20, CDD, Core 0 + Core 1, 1 GHz to 40 GHz, Vertical



Frequency (MHz)	Level (dBuV/m)	Limit (dBuV/m)	Margin (dB)	Detector	Angle (°)	Height (cm)	Polarisation
*							

Table 726 - U-NII-3 - 5745 MHz (CH149), HT20, CDD, Core 0 + Core 1, 1 GHz to 40 GHz

*No emissions found within 10 dB of the limit.

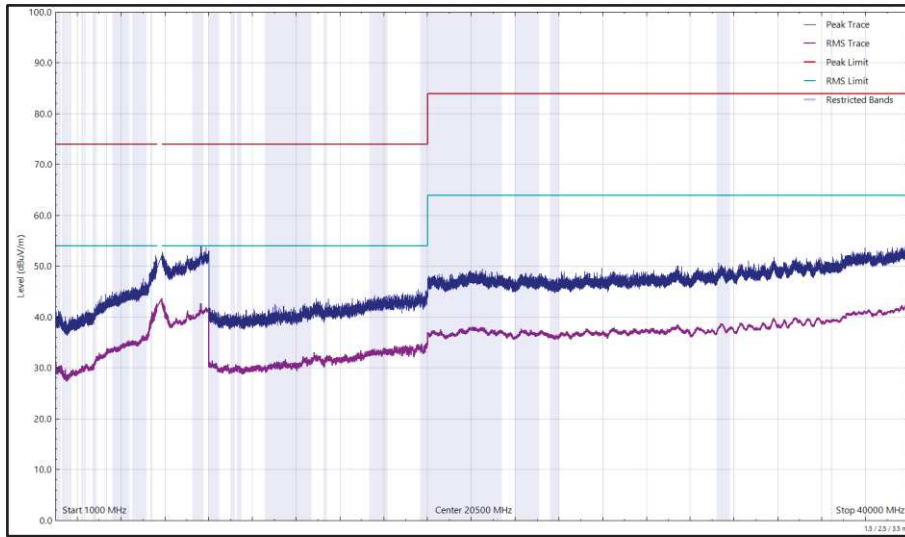

Figure 626 - U-NII-3 - 5745 MHz (CH149), HT20, CDD, Core 0 + Core 1, 1 GHz to 40 GHz, Horizontal

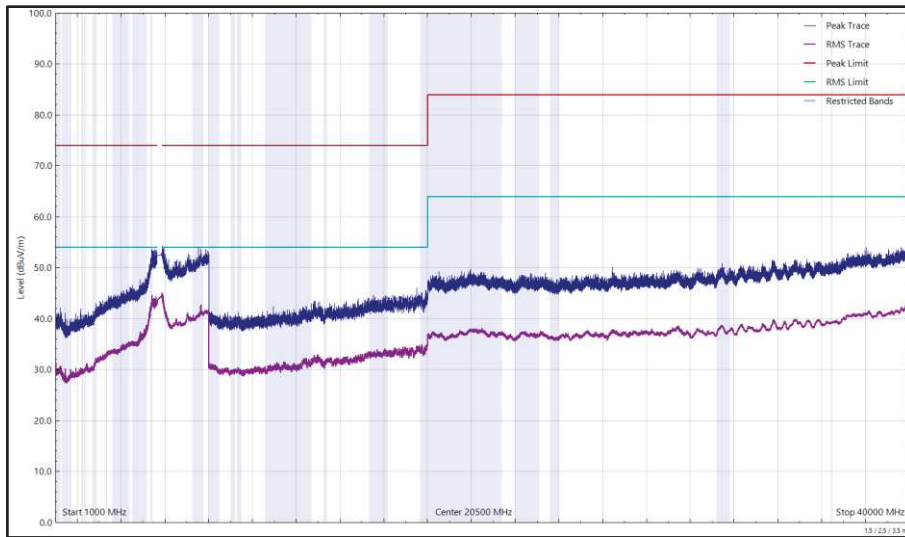

Figure 627 - U-NII-3 - 5745 MHz (CH149), HT20, CDD, Core 0 + Core 1, 1 GHz to 40 GHz, Vertical



Frequency (MHz)	Level (dBuV/m)	Limit (dBuV/m)	Margin (dB)	Detector	Angle (°)	Height (cm)	Polarisation
69.178	36.87	40.00	-3.13	Q-Peak	225	105	Vertical
69.261	25.44	40.00	-14.56	Q-Peak	1	350	Horizontal

Table 727 - U-NII-3 - 5825 MHz (CH165), HT20, CDD, Core 0 + Core 1, 30 MHz to 40 GHz

No other emissions found within 10 dB of the limit.

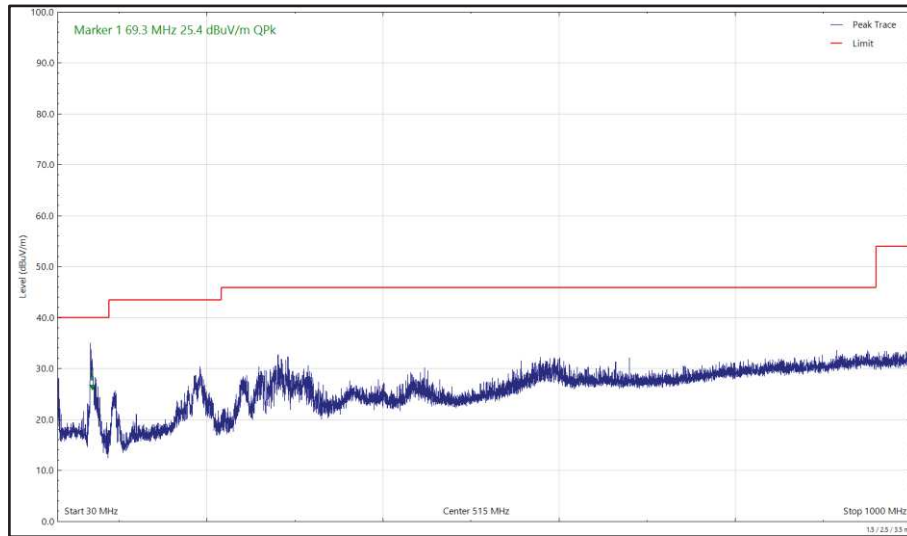

Figure 628 - U-NII-3 - 5825 MHz (CH165), HT20, CDD, Core 0 + Core 1, 30 MHz to 1 GHz, Horizontal (Peak)

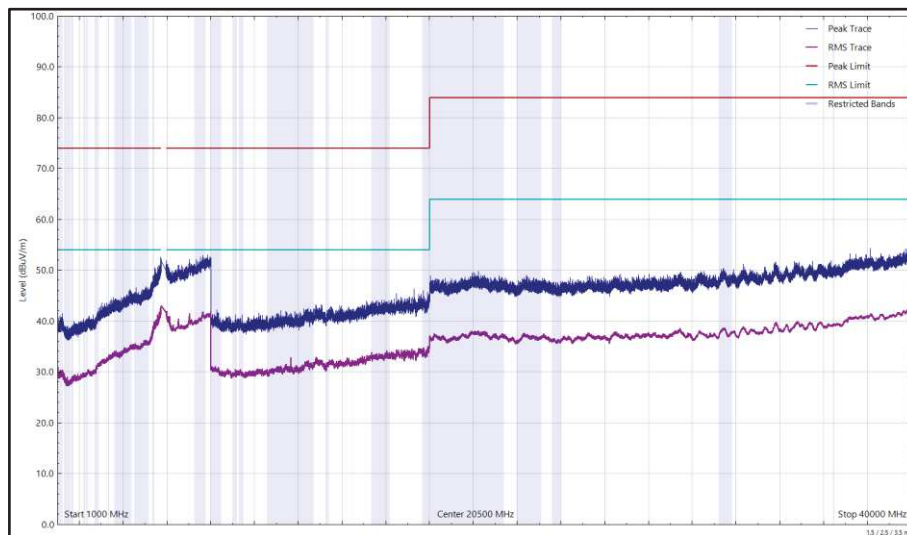

Figure 629 - U-NII-3 - 5825 MHz (CH165), HT20, CDD, Core 0 + Core 1, 1 GHz to 40 GHz, Horizontal

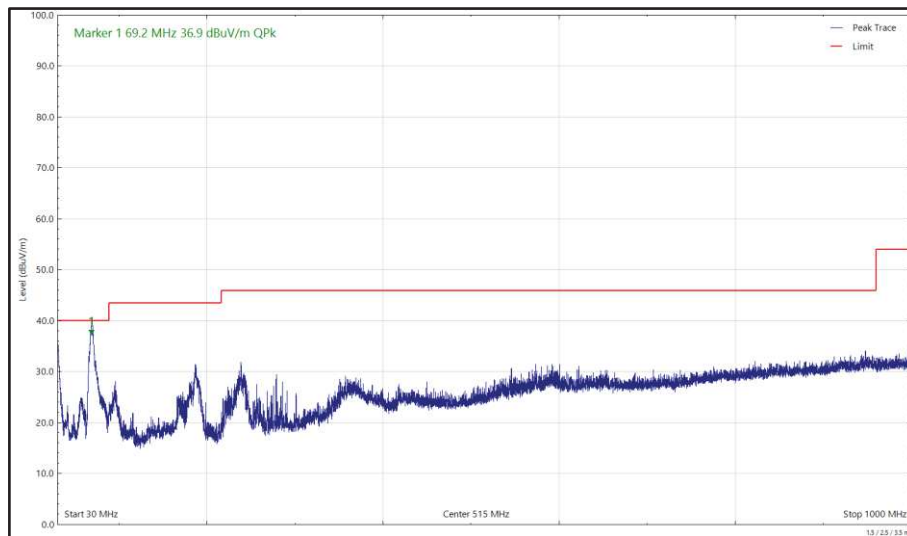

Figure 630 - U-NII-3 - 5825 MHz (CH165), HT20, CDD, Core 0 + Core 1, 30 MHz to 1 GHz, Vertical (Peak)

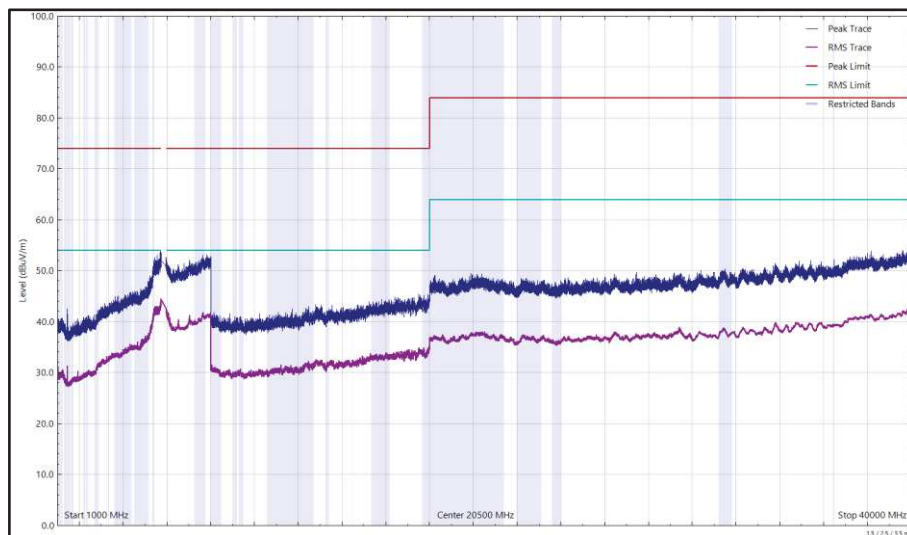

Figure 631 - U-NII-3 - 5825 MHz (CH165), HT20, CDD, Core 0 + Core 1, 1 GHz to 40 GHz, Vertical



Frequency (MHz)	Level (dBuV/m)	Limit (dBuV/m)	Margin (dB)	Detector	Angle (°)	Height (cm)	Polarisation
68.806	24.61	40.00	-15.39	Q-Peak	5	357	Horizontal
69.335	36.82	40.00	-3.18	Q-Peak	218	136	Vertical
15514.562	42.31	54.00	-11.69	RMS	286	132	Vertical
15514.927	33.02	54.00	-20.98	RMS	233	242	Horizontal
15515.460	55.10	74.00	-18.90	Peak	45	100	Vertical

Table 728 - U-NII-1 - 5180 MHz (CH36), HE20, RU26-0, CDD, Core 0 + Core 1, 30 MHz to 40 GHz

No other emissions found within 10 dB of the limit.

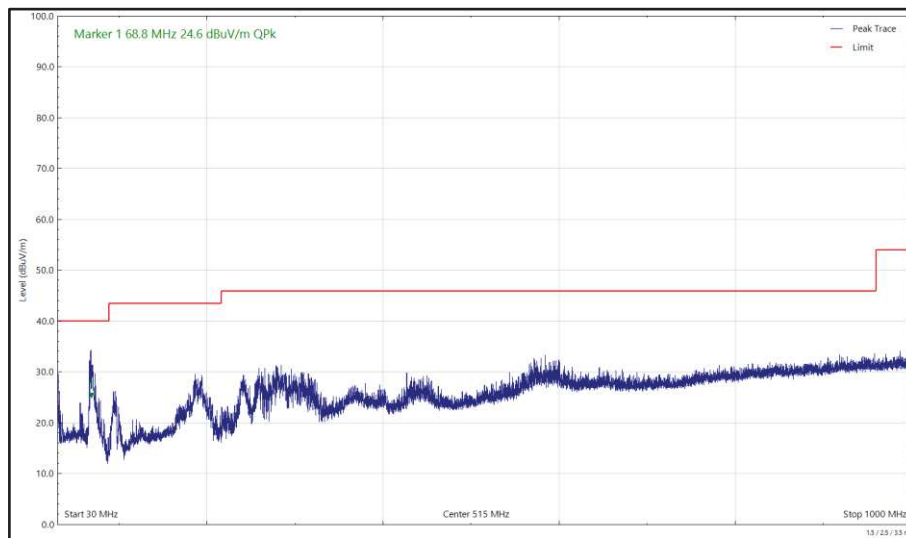

Figure 632 - U-NII-1 - 5180 MHz (CH36), HE20, RU26-0, CDD, Core 0 + Core 1, 30 MHz to 1 GHz, Horizontal (Peak)

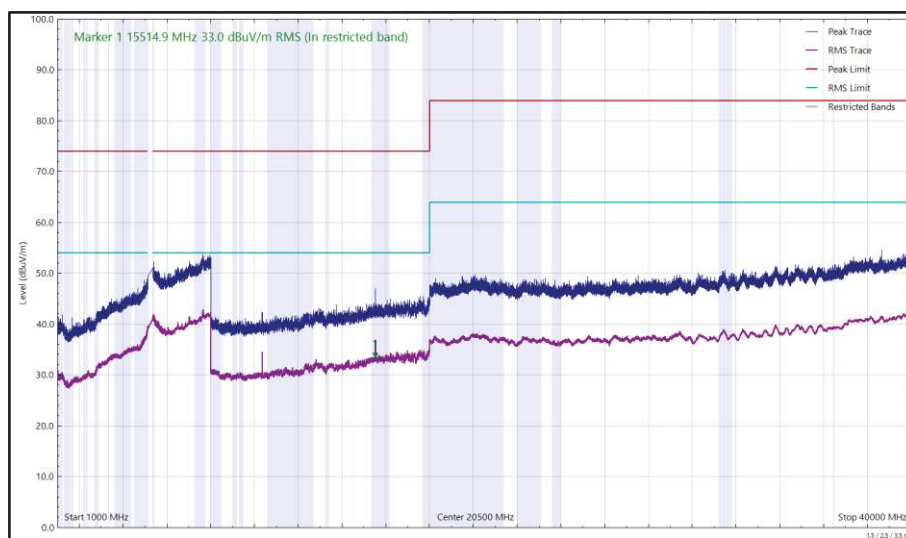

Figure 633 - U-NII-1 - 5180 MHz (CH36), HE20, RU26-0, CDD, Core 0 + Core 1, 1 GHz to 40 GHz, Horizontal

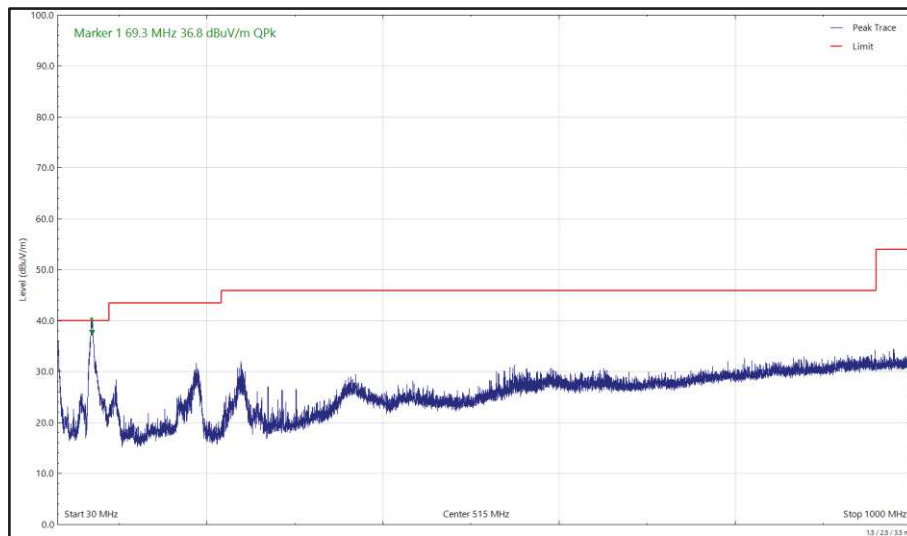

Figure 634 - U-NII-1 - 5180 MHz (CH36), HE20, RU26-0, CDD, Core 0 + Core 1, 30 MHz to 1 GHz, Vertical (Peak)

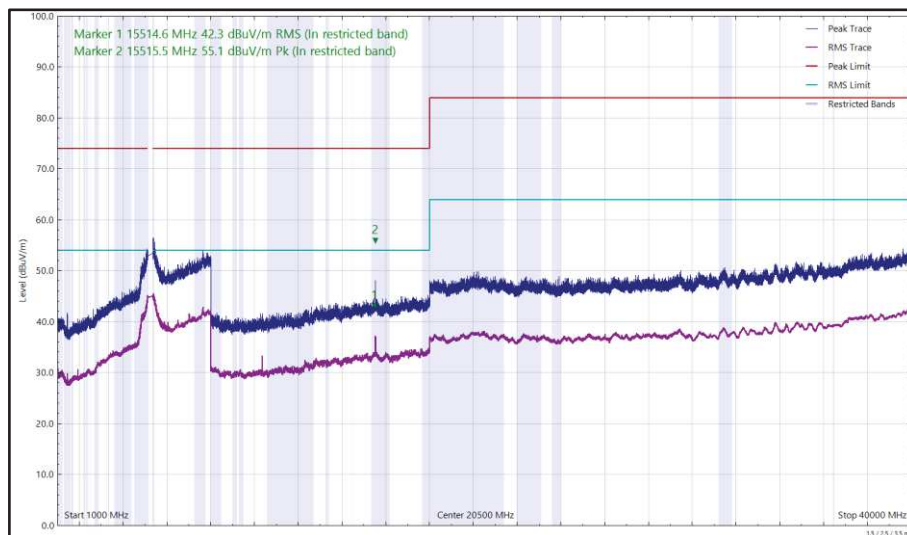

Figure 635 - U-NII-1 - 5180 MHz (CH36), HE20, RU26-0, CDD, Core 0 + Core 1, 1 GHz to 40 GHz, Vertical



Frequency (MHz)	Level (dBuV/m)	Limit (dBuV/m)	Margin (dB)	Detector	Angle (°)	Height (cm)	Polarisation
15938.992	36.46	54.00	-17.54	RMS	283	155	Vertical

Table 729 - U-NII-2A - 5320 MHz (CH64), HE20, RU52-37, CDD, Core 0 + Core 1, 1 GHz to 40 GHz

No other emissions found within 10 dB of the limit.

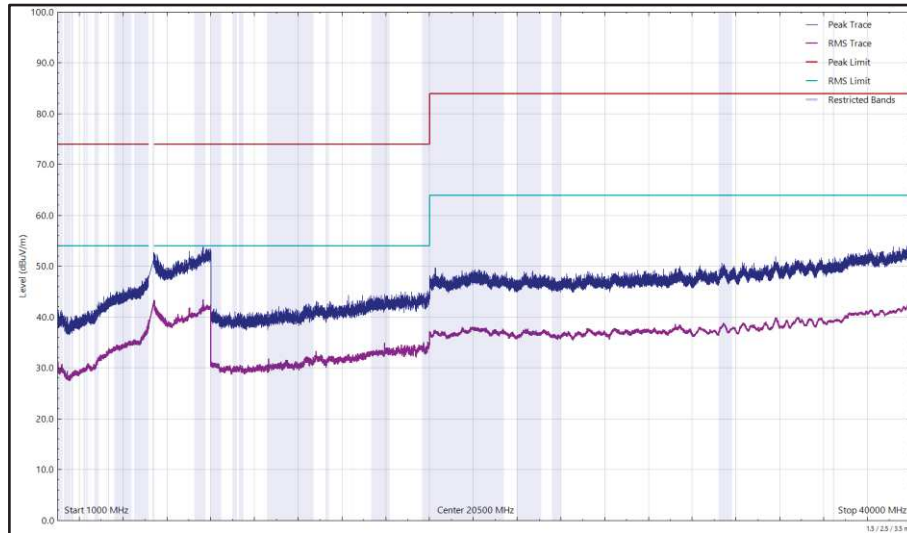

Figure 636 - U-NII-2A - 5320 MHz (CH64), HE20, RU52-37, CDD, Core 0 + Core 1, 1 GHz to 40 GHz, Horizontal

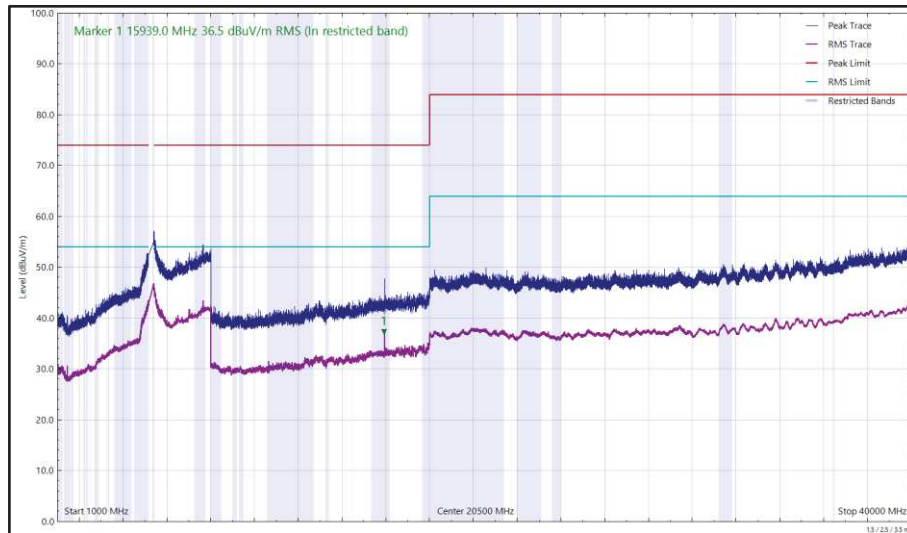

Figure 637 - U-NII-2A - 5320 MHz (CH64), HE20, RU52-37, CDD, Core 0 + Core 1, 1 GHz to 40 GHz, Vertical



Frequency (MHz)	Level (dBuV/m)	Limit (dBuV/m)	Margin (dB)	Detector	Angle (°)	Height (cm)	Polarisation
*							

Table 730 - U-NII-2C - 5500 MHz (CH100), HE20, RU52-37, CDD, Core 0 + Core 1, 1 GHz to 40 GHz

*No emissions found within 10 dB of the limit.

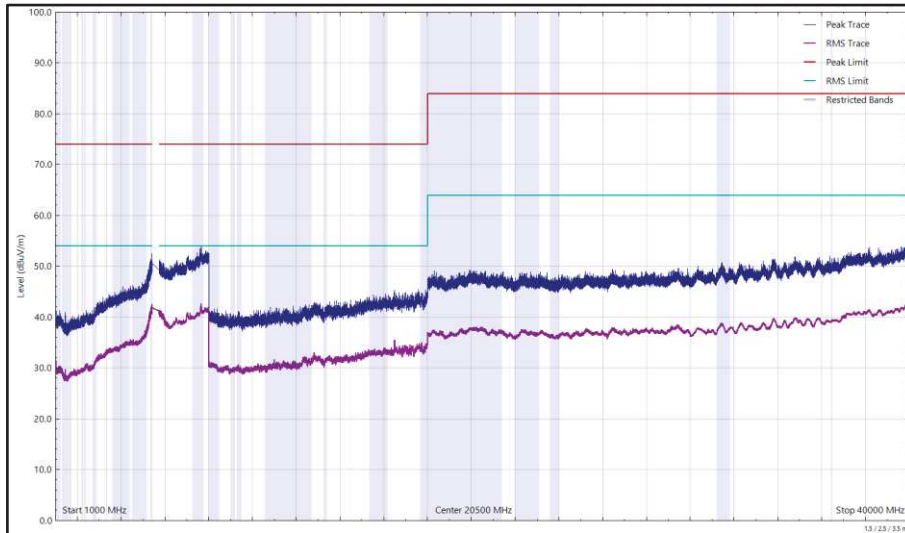

Figure 638 - U-NII-2C - 5500 MHz (CH100), HE20, RU52-37, CDD, Core 0 + Core 1, 1 GHz to 40 GHz, Horizontal

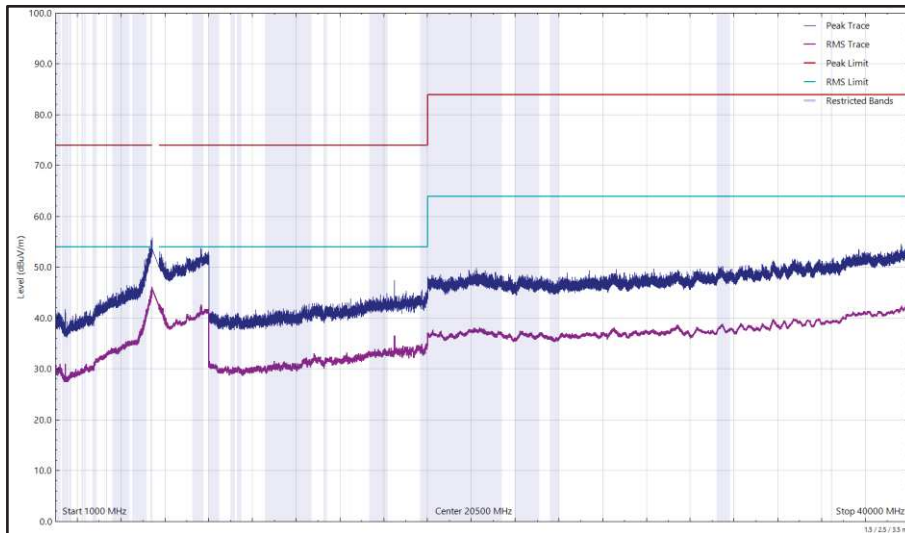

Figure 639 - U-NII-2C - 5500 MHz (CH100), HE20, RU52-37, CDD, Core 0 + Core 1, 1 GHz to 40 GHz, Vertical



Frequency (MHz)	Level (dBuV/m)	Limit (dBuV/m)	Margin (dB)	Detector	Angle (°)	Height (cm)	Polarisation
*							

Table 731 - U-NII-2C - 5700 MHz (CH140), HE20, RU52-37, CDD, Core 0 + Core 1, 1 GHz to 40 GHz

*No emissions found within 10 dB of the limit.

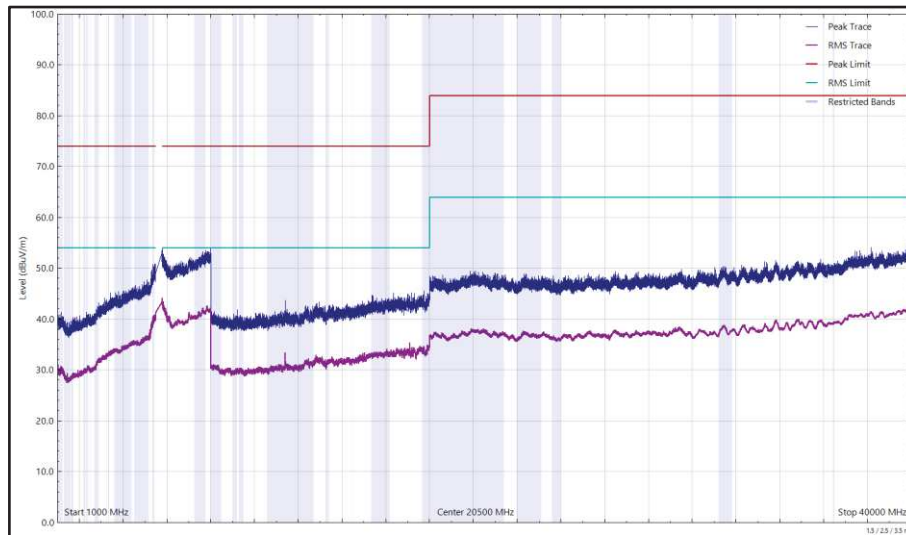

Figure 640 - U-NII-2C - 5700 MHz (CH140), HE20, RU52-37, CDD, Core 0 + Core 1, 1 GHz to 40 GHz, Horizontal

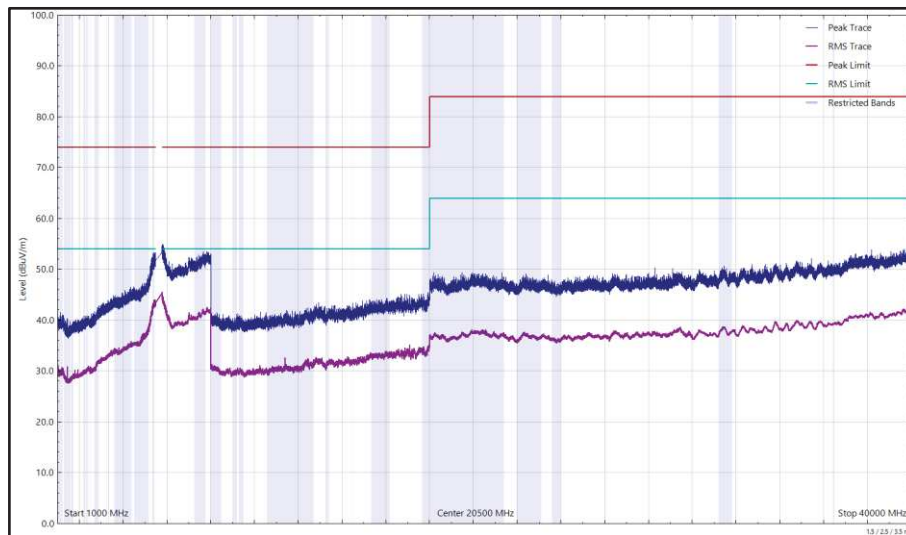

Figure 641 - U-NII-2C - 5700 MHz (CH140), HE20, RU52-37, CDD, Core 0 + Core 1, 1 GHz to 40 GHz, Vertical



Frequency (MHz)	Level (dBuV/m)	Limit (dBuV/m)	Margin (dB)	Detector	Angle (°)	Height (cm)	Polarisation
*							

Table 732 - U-NII-3 - 5745 MHz (CH149), HE20, RU26-0, CDD, Core 0 + Core 1, 1 GHz to 40 GHz

*No emissions found within 10 dB of the limit.

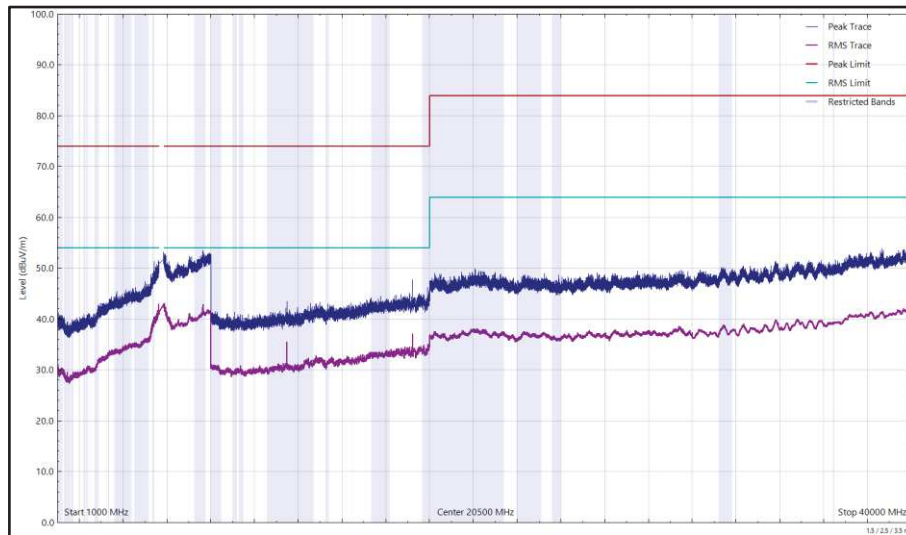

Figure 642 - U-NII-3 - 5745 MHz (CH149), HE20, RU26-0, CDD, Core 0 + Core 1, 1 GHz to 40 GHz, Horizontal

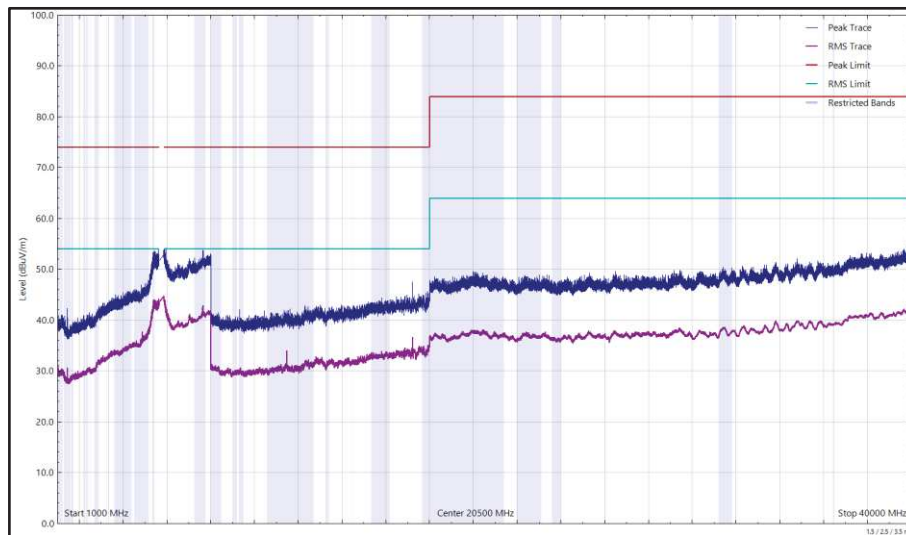

Figure 643 - U-NII-3 - 5745 MHz (CH149), HE20, RU26-0, CDD, Core 0 + Core 1, 1 GHz to 40 GHz, Vertical



Frequency (MHz)	Level (dBuV/m)	Limit (dBuV/m)	Margin (dB)	Detector	Angle (°)	Height (cm)	Polarisation
68.927	36.95	40.00	-3.05	Q-Peak	221	100	Vertical
68.930	26.26	40.00	-13.74	Q-Peak	0	362	Horizontal
11632.540	34.83	54.00	-19.17	RMS	146	393	Horizontal
11632.791	33.99	54.00	-20.01	RMS	57	247	Vertical

Table 733 - U-NII-3 - 5825 MHz (CH165), HE20, RU26-0, CDD, Core 0 + Core 1, 30 MHz to 40 GHz

No other emissions found within 10 dB of the limit.

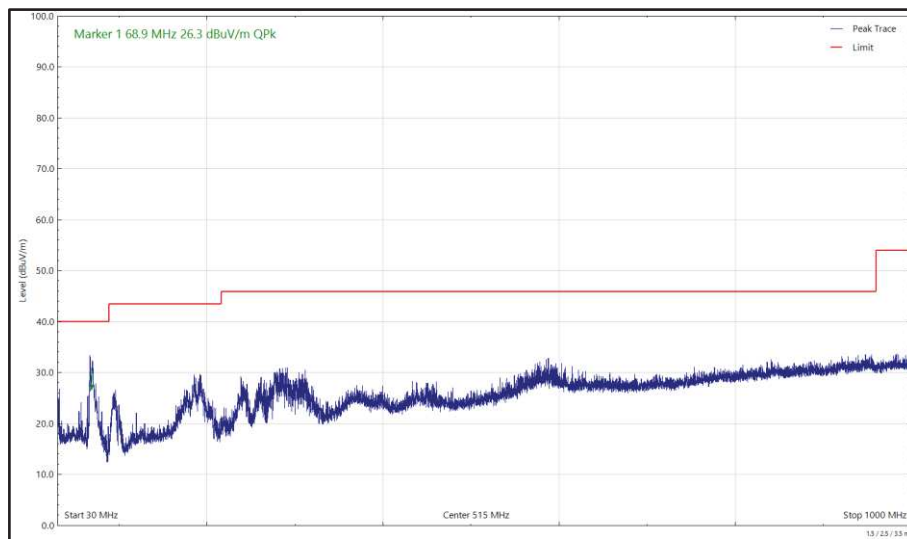

Figure 644 - U-NII-3 - 5825 MHz (CH165), HE20, RU26-0, CDD, Core 0 + Core 1, 30 MHz to 1 GHz, Horizontal (Peak)

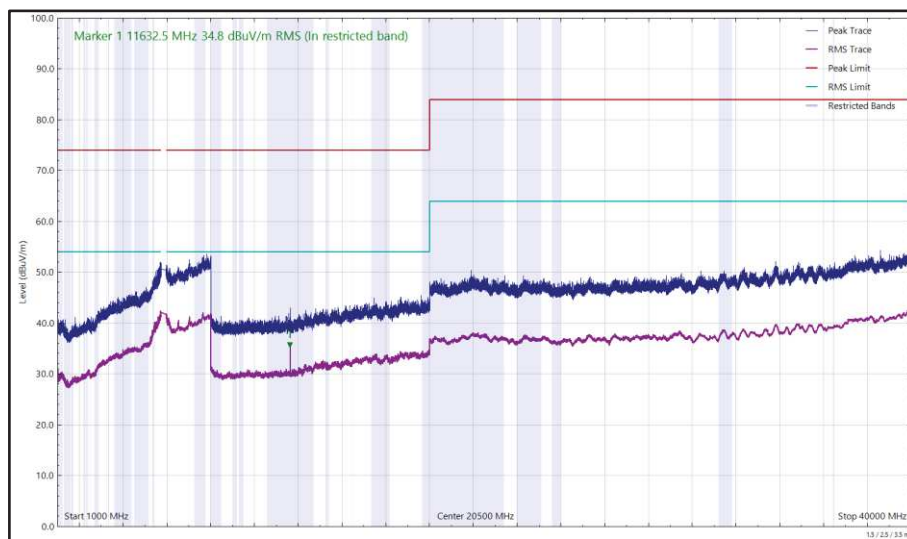

Figure 645 - U-NII-3 - 5825 MHz (CH165), HE20, RU26-0, CDD, Core 0 + Core 1, 1 GHz to 40 GHz, Horizontal

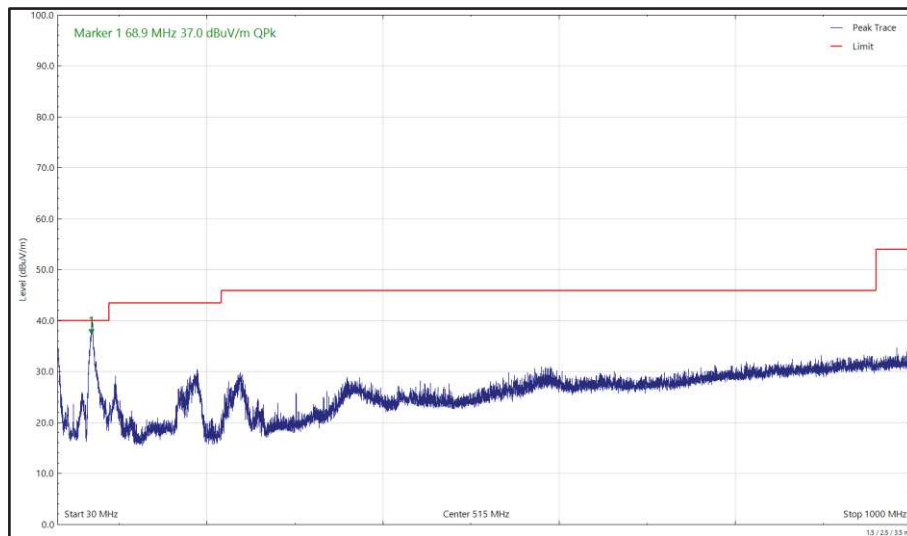

Figure 646 - U-NII-3 - 5825 MHz (CH165), HE20, RU26-0, CDD, Core 0 + Core 1, 30 MHz to 1 GHz, Vertical (Peak)

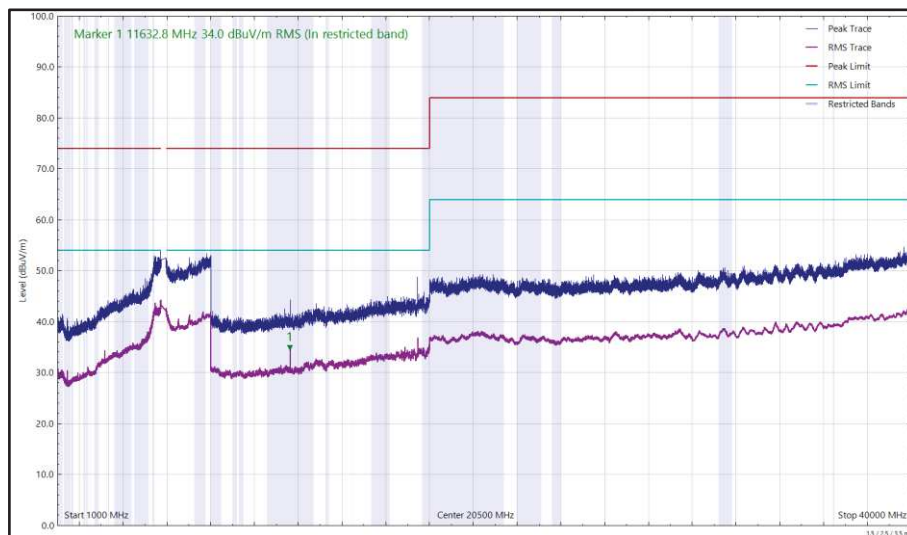

Figure 647 - U-NII-3 - 5825 MHz (CH165), HE20, RU26-0, CDD, Core 0 + Core 1, 1 GHz to 40 GHz, Vertical



Frequency (MHz)	Level (dBuV/m)	Limit (dBuV/m)	Margin (dB)	Detector	Angle (°)	Height (cm)	Polarisation
69.106	36.58	40.00	-3.42	Q-Peak	211	100	Vertical
69.212	26.49	40.00	-13.51	Q-Peak	294	369	Horizontal

Table 734 - U-NII-1 - 5180 MHz (CH36), 802.11a, Core 0, 30 MHz to 40 GHz

No other emissions found within 10 dB of the limit.

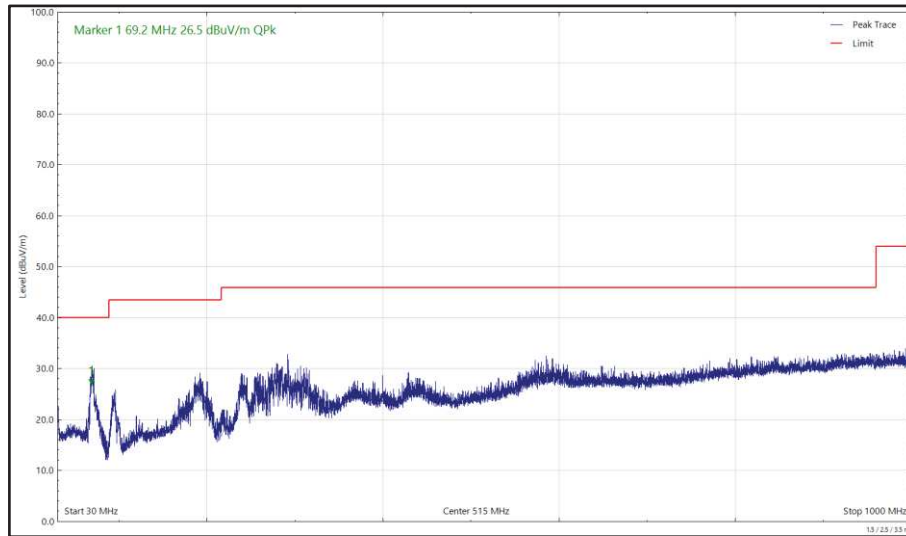

Figure 648 - U-NII-1 - 5180 MHz (CH36), 802.11a, Core 0, 30 MHz to 1 GHz, Horizontal (Peak)

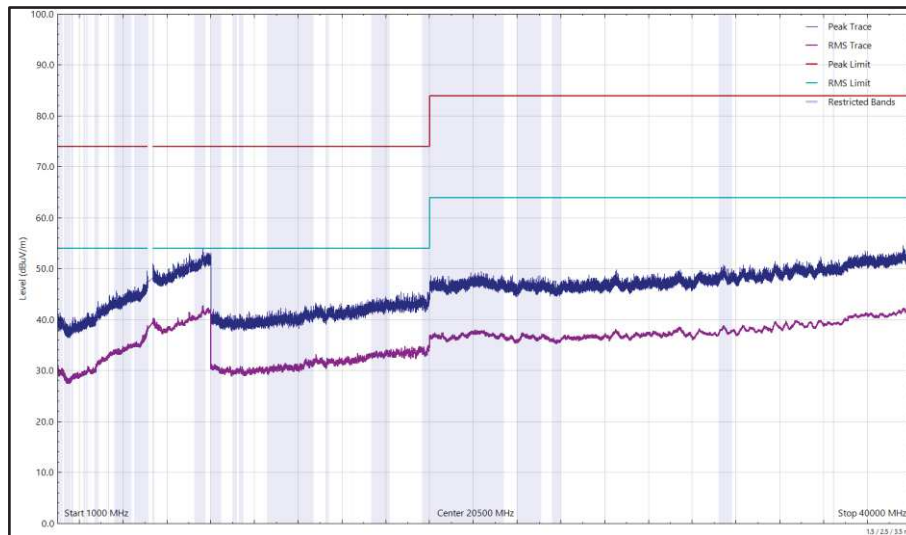

Figure 649 - U-NII-1 - 5180 MHz (CH36), 802.11a, Core 0, 1 GHz to 40 GHz, Horizontal

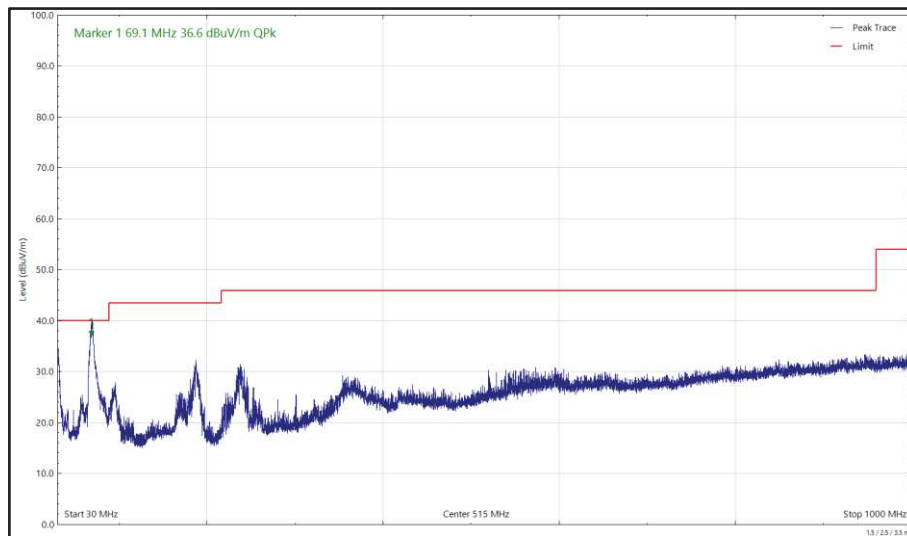

Figure 650 - U-NII-1 - 5180 MHz (CH36), 802.11a, Core 0, 30 MHz to 1 GHz, Vertical (Peak)

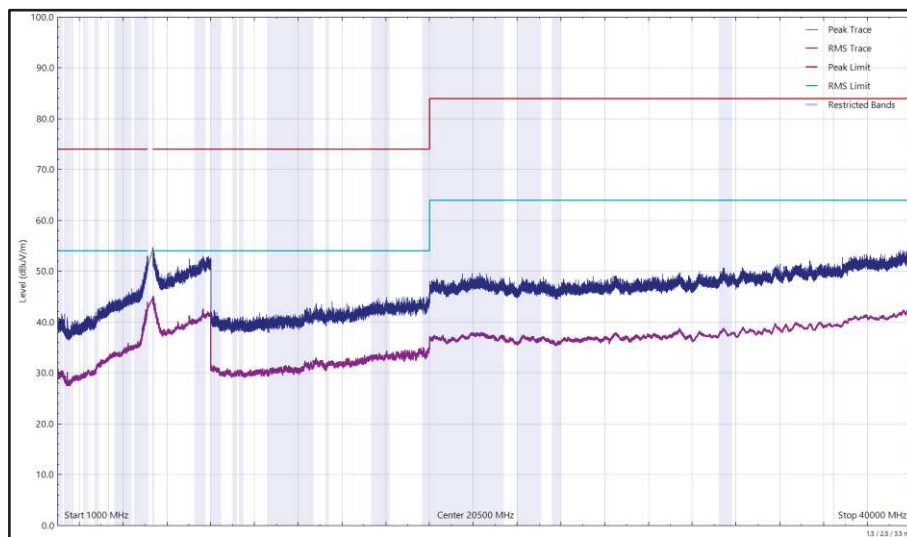

Figure 651 - U-NII-1 - 5180 MHz (CH36), 802.11a, Core 0, 1 GHz to 40 GHz, Vertical



Frequency (MHz)	Level (dBuV/m)	Limit (dBuV/m)	Margin (dB)	Detector	Angle (°)	Height (cm)	Polarisation
*							

Table 735 - U-NII-2A - 5320 MHz (CH64), 802.11a, Core 0, 1 GHz to 40 GHz

*No emissions found within 10 dB of the limit.

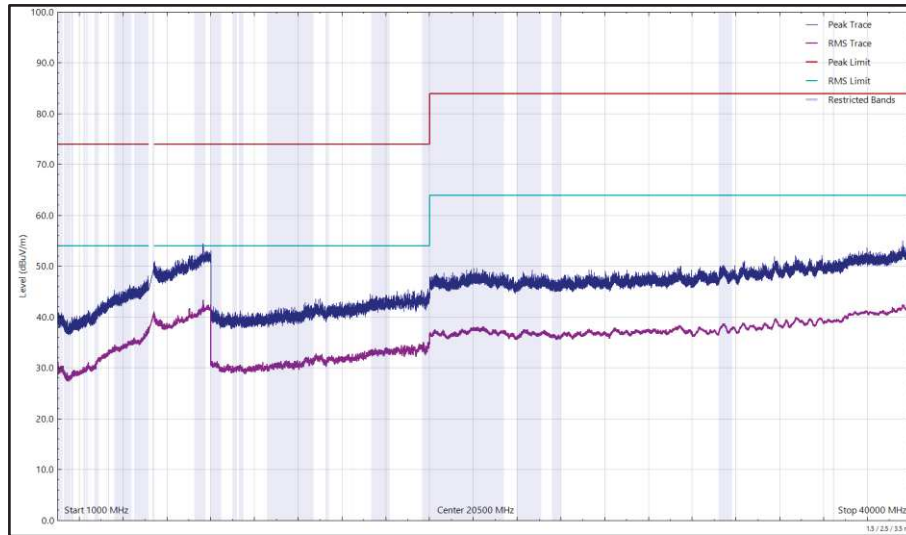

Figure 652 - U-NII-2A - 5320 MHz (CH64), 802.11a, Core 0, 1 GHz to 40 GHz, Horizontal

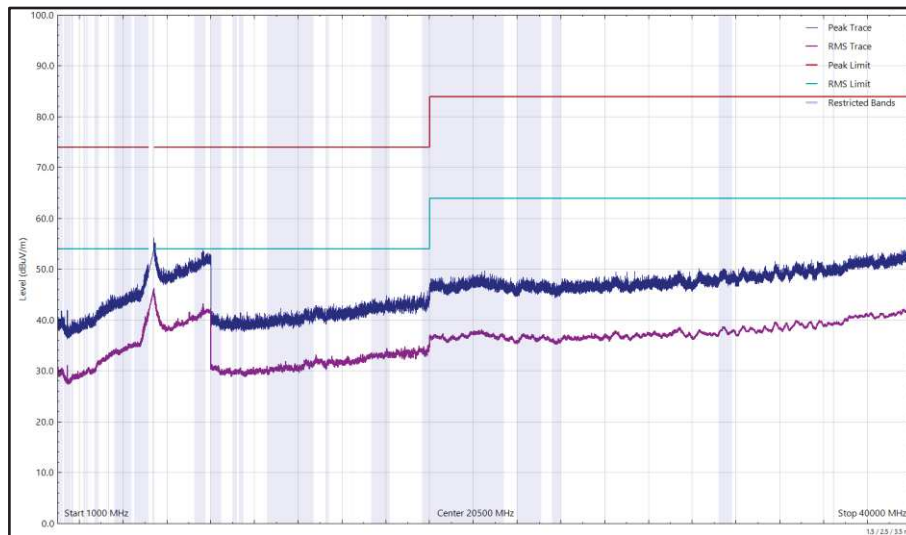

Figure 653 - U-NII-2A - 5320 MHz (CH64), 802.11a, Core 0, 1 GHz to 40 GHz, Vertical



Frequency (MHz)	Level (dBuV/m)	Limit (dBuV/m)	Margin (dB)	Detector	Angle (°)	Height (cm)	Polarisation
*							

Table 736 - U-NII-2C - 5500 MHz (CH100), 802.11a, Core 0, 1 GHz to 40 GHz

*No emissions found within 10 dB of the limit.

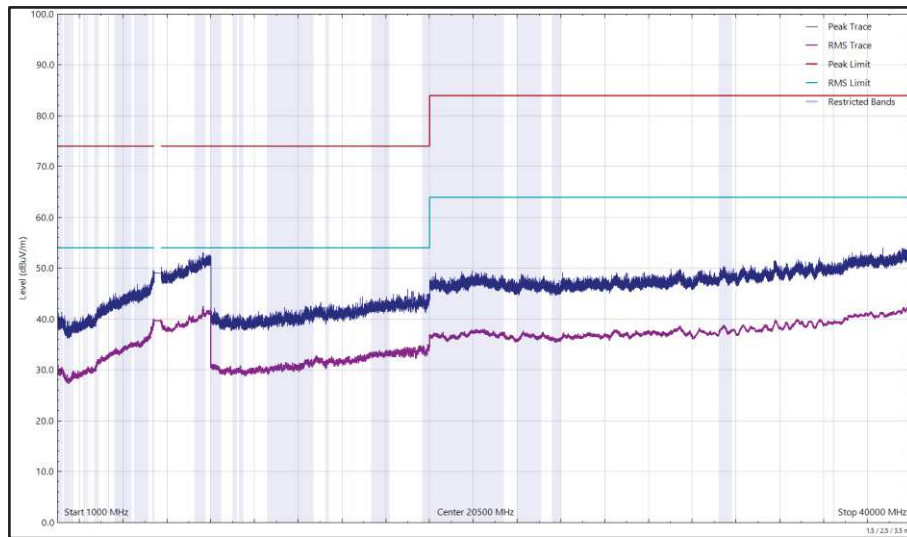

Figure 654 - U-NII-2C - 5500 MHz (CH100), 802.11a, Core 0, 1 GHz to 40 GHz, Horizontal

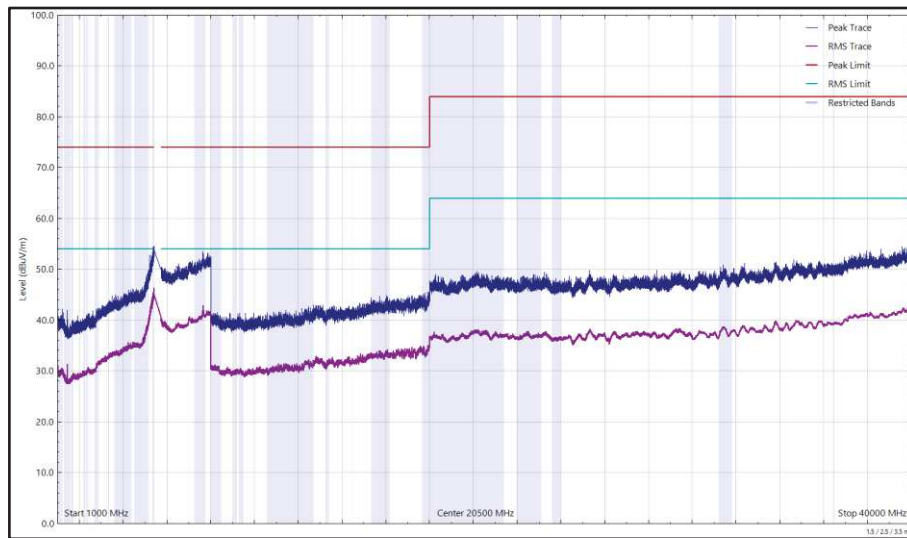

Figure 655 - U-NII-2C - 5500 MHz (CH100), 802.11a, Core 0, 1 GHz to 40 GHz, Vertical



Frequency (MHz)	Level (dBuV/m)	Limit (dBuV/m)	Margin (dB)	Detector	Angle (°)	Height (cm)	Polarisation
*							

Table 737 - U-NII-2C - 5700 MHz (CH140), 802.11a, Core 0, 1 GHz to 40 GHz

*No emissions found within 10 dB of the limit.

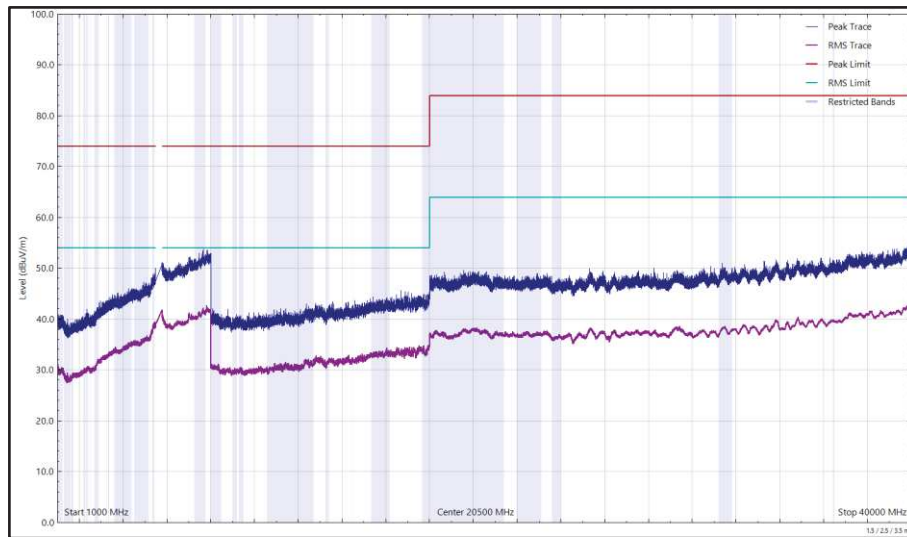

Figure 656 - U-NII-2C - 5700 MHz (CH140), 802.11a, Core 0, 1 GHz to 40 GHz, Horizontal

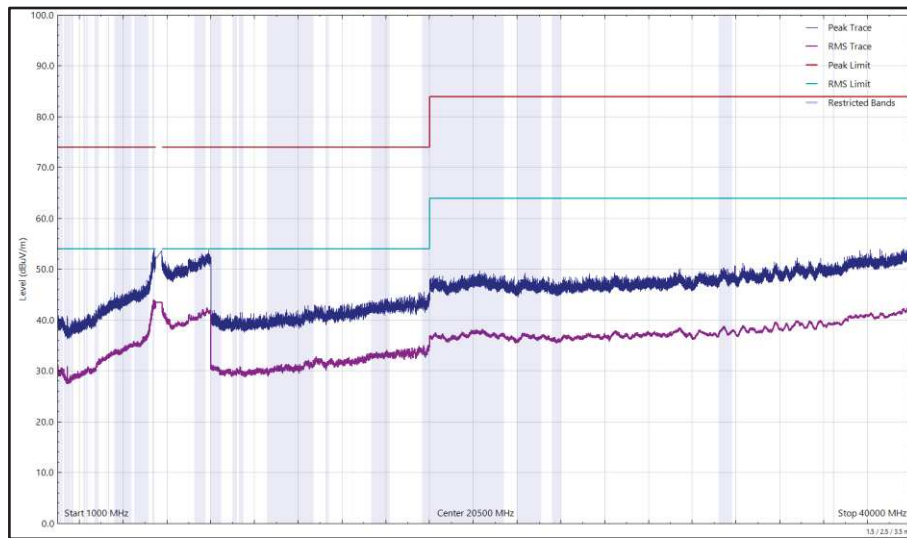

Figure 657 - U-NII-2C - 5700 MHz (CH140), 802.11a, Core 0, 1 GHz to 40 GHz, Vertical



Frequency (MHz)	Level (dBuV/m)	Limit (dBuV/m)	Margin (dB)	Detector	Angle (°)	Height (cm)	Polarisation
*							

Table 738 - U-NII-3 - 5745 MHz (CH149), 802.11a, Core 0, 1 GHz to 40 GHz

*No emissions found within 10 dB of the limit.

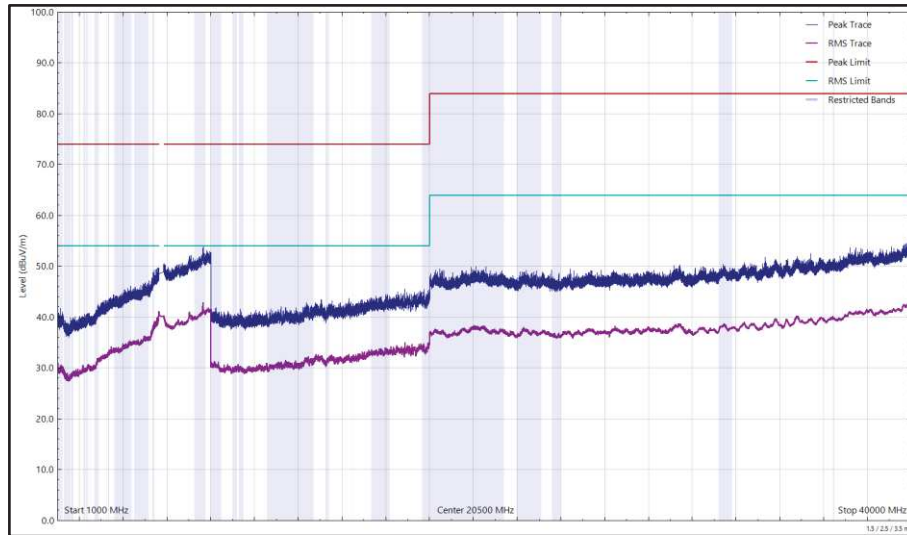

Figure 658 - U-NII-3 - 5745 MHz (CH149), 802.11a, Core 0, 1 GHz to 40 GHz, Horizontal

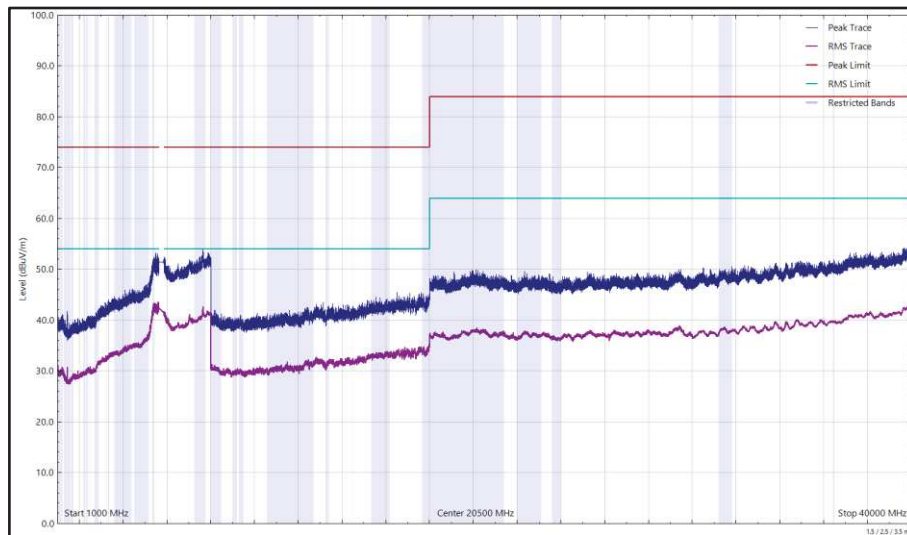

Figure 659 - U-NII-3 - 5745 MHz (CH149), 802.11a, Core 0, 1 GHz to 40 GHz, Vertical



Frequency (MHz)	Level (dBuV/m)	Limit (dBuV/m)	Margin (dB)	Detector	Angle (°)	Height (cm)	Polarisation
68.996	36.84	40.00	-3.16	Q-Peak	222	100	Vertical
69.123	23.69	40.00	-16.31	Q-Peak	0	351	Horizontal

Table 739 - U-NII-3 - 5825 MHz (CH165), 802.11a, Core 0, 30 MHz to 40 GHz

No other emissions found within 10 dB of the limit.

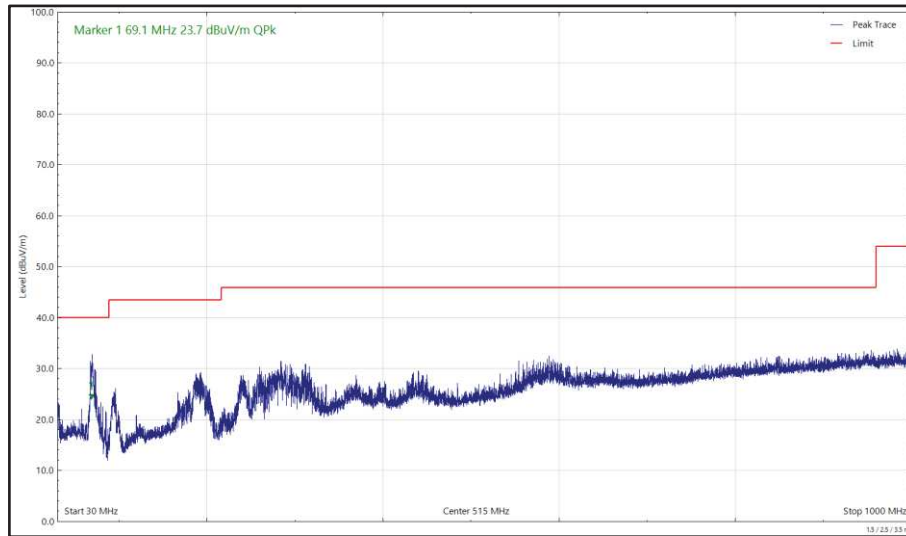

Figure 660 - U-NII-3 - 5825 MHz (CH165), 802.11a, Core 0, 30 MHz to 1 GHz, Horizontal (Peak)

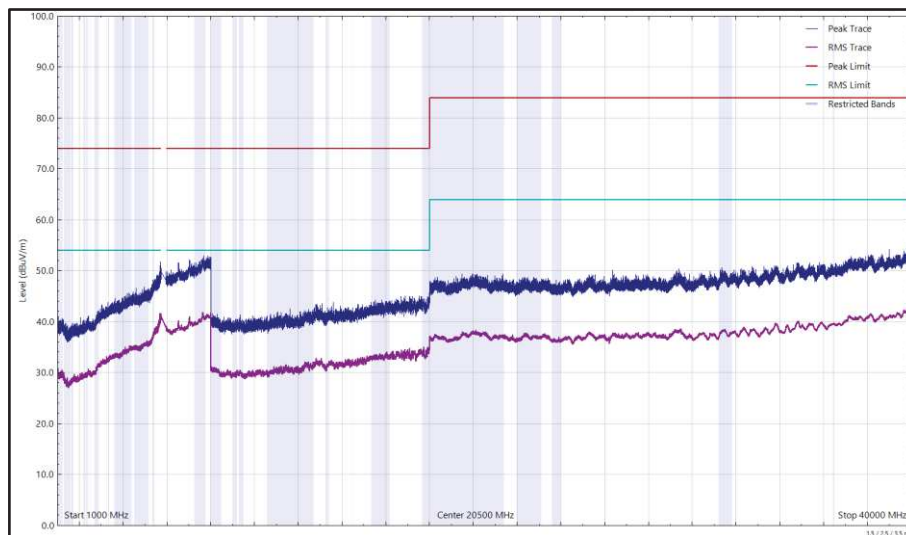

Figure 661 - U-NII-3 - 5825 MHz (CH165), 802.11a, Core 0, 1 GHz to 40 GHz, Horizontal

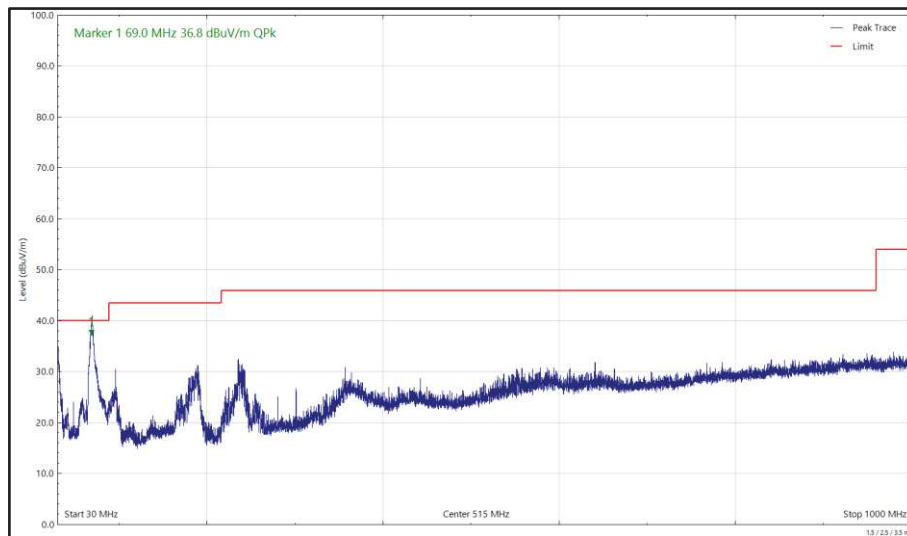

Figure 662 - U-NII-3 - 5825 MHz (CH165), 802.11a, Core 0, 30 MHz to 1 GHz, Vertical (Peak)

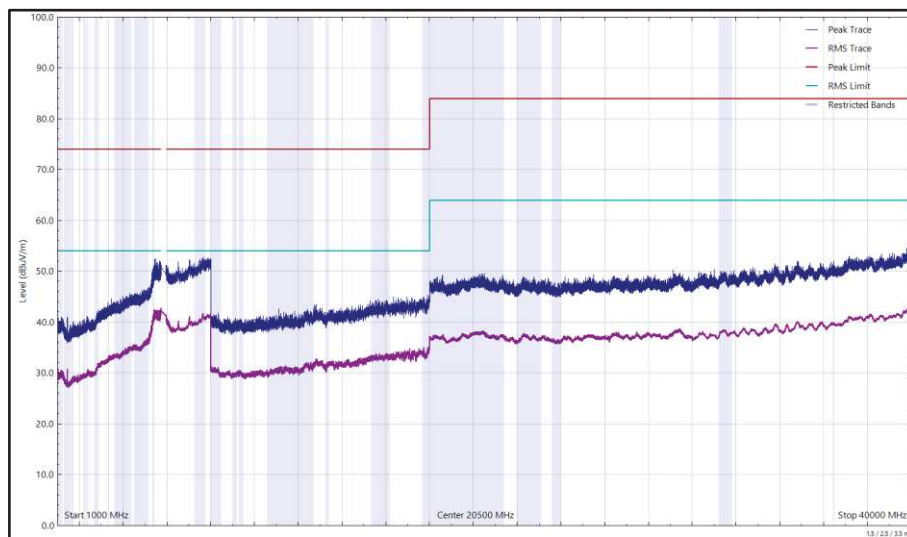

Figure 663 - U-NII-3 - 5825 MHz (CH165), 802.11a, Core 0, 1 GHz to 40 GHz, Vertical



Frequency (MHz)	Level (dBuV/m)	Limit (dBuV/m)	Margin (dB)	Detector	Angle (°)	Height (cm)	Polarisation
68.944	36.64	40.00	-3.36	Q-Peak	211	100	Vertical
69.242	25.88	40.00	-14.12	Q-Peak	135	304	Horizontal

Table 740 - U-NII-1 - 5180 MHz (CH36), 802.11a, Core 1, 30 MHz to 40 GHz

No other emissions found within 10 dB of the limit.

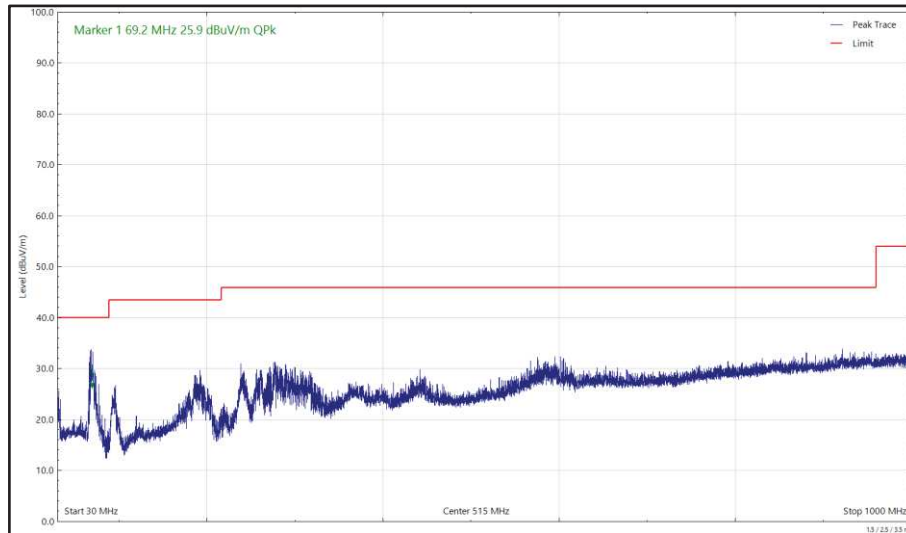

Figure 664 - U-NII-1 - 5180 MHz (CH36), 802.11a, Core 1, 30 MHz to 1 GHz, Horizontal (Peak)

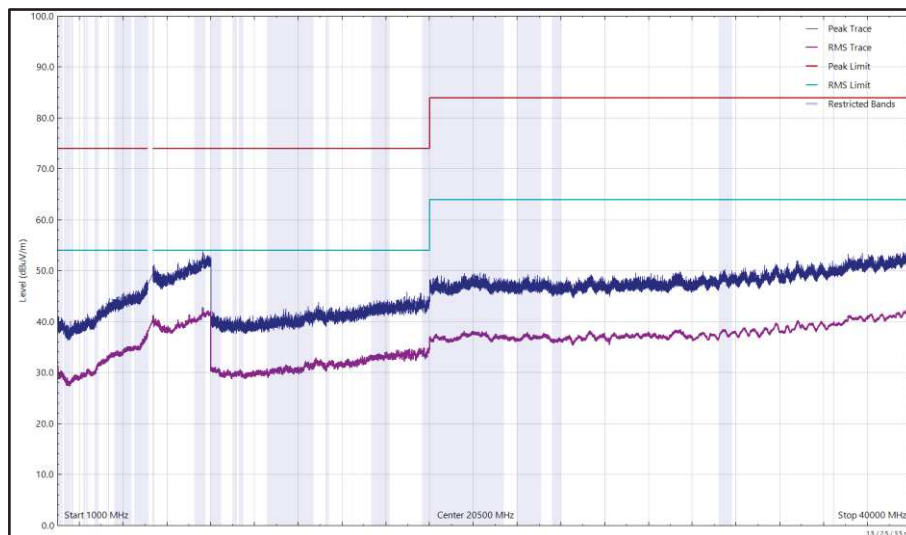

Figure 665 - U-NII-1 - 5180 MHz (CH36), 802.11a, Core 1, 1 GHz to 40 GHz, Horizontal

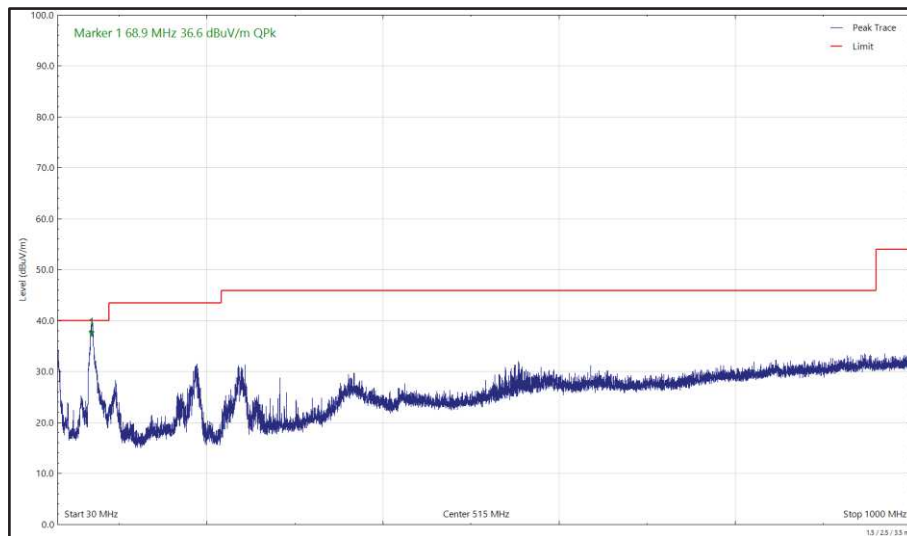

Figure 666 - U-NII-1 - 5180 MHz (CH36), 802.11a, Core 1, 30 MHz to 1 GHz, Vertical (Peak)

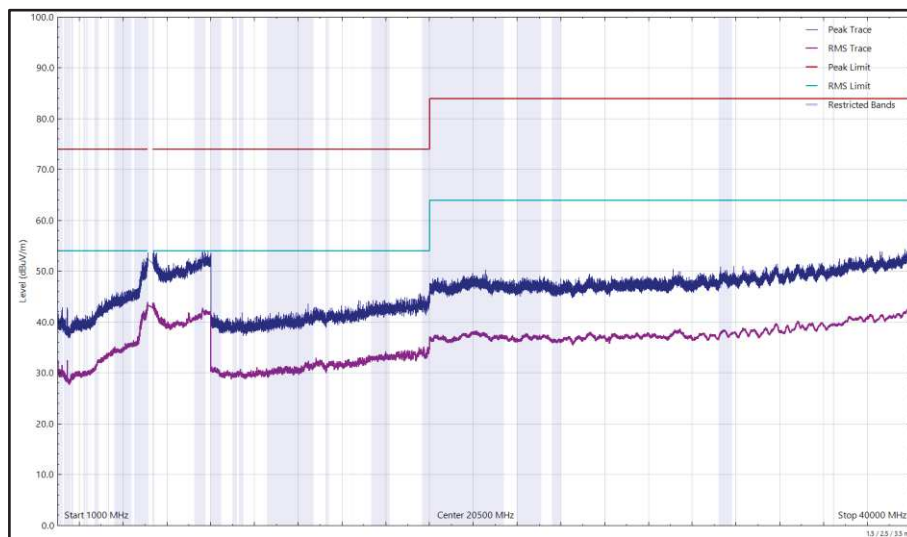

Figure 667 - U-NII-1 - 5180 MHz (CH36), 802.11a, Core 1, 1 GHz to 40 GHz, Vertical



Frequency (MHz)	Level (dBuV/m)	Limit (dBuV/m)	Margin (dB)	Detector	Angle (°)	Height (cm)	Polarisation
*							

Table 741 - U-NII-2A - 5320 MHz (CH64), 802.11a, Core 1, 1 GHz to 40 GHz

*No emissions found within 10 dB of the limit.

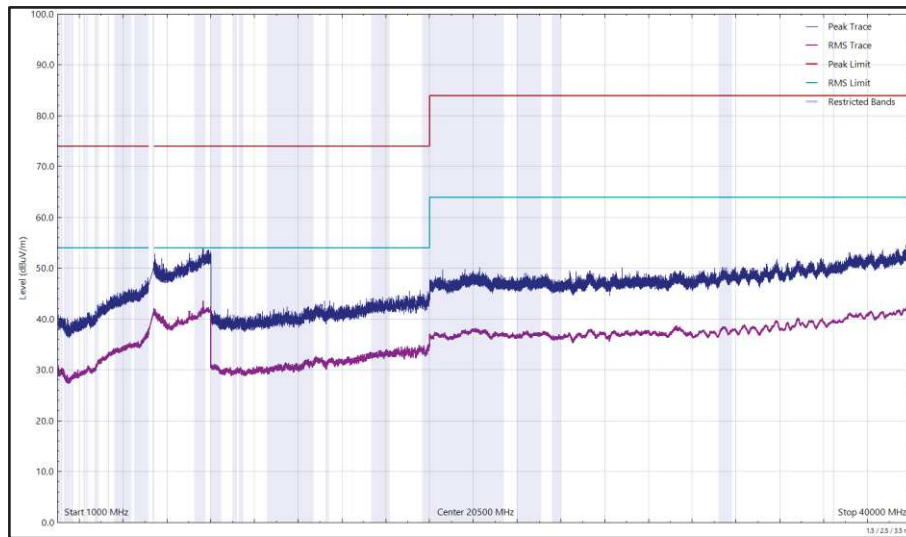

Figure 668 - U-NII-2A - 5320 MHz (CH64), 802.11a, Core 1, 1 GHz to 40 GHz, Horizontal

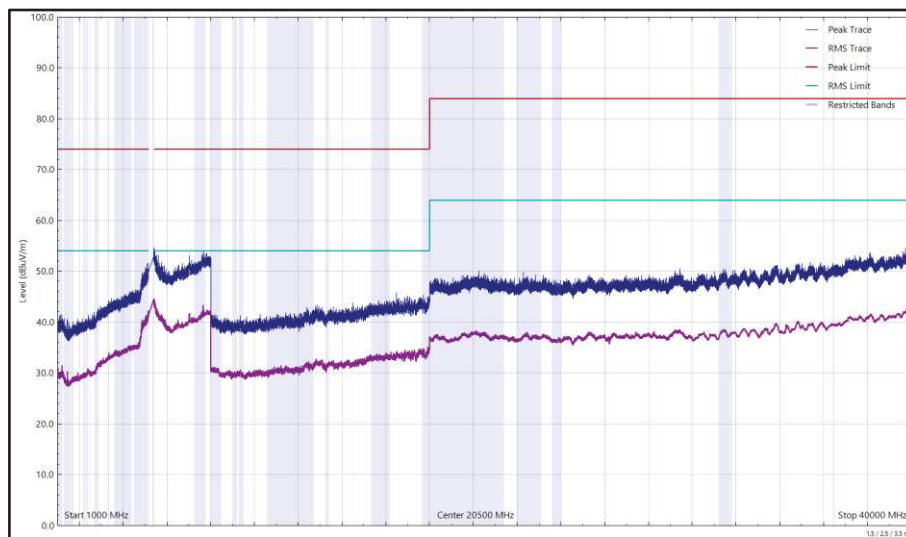

Figure 669 - U-NII-2A - 5320 MHz (CH64), 802.11a, Core 1, 1 GHz to 40 GHz, Vertical



Frequency (MHz)	Level (dBuV/m)	Limit (dBuV/m)	Margin (dB)	Detector	Angle (°)	Height (cm)	Polarisation
*							

Table 742 - U-NII-2C - 5500 MHz (CH100), 802.11a, Core 1, 1 GHz to 40 GHz

*No emissions found within 10 dB of the limit.

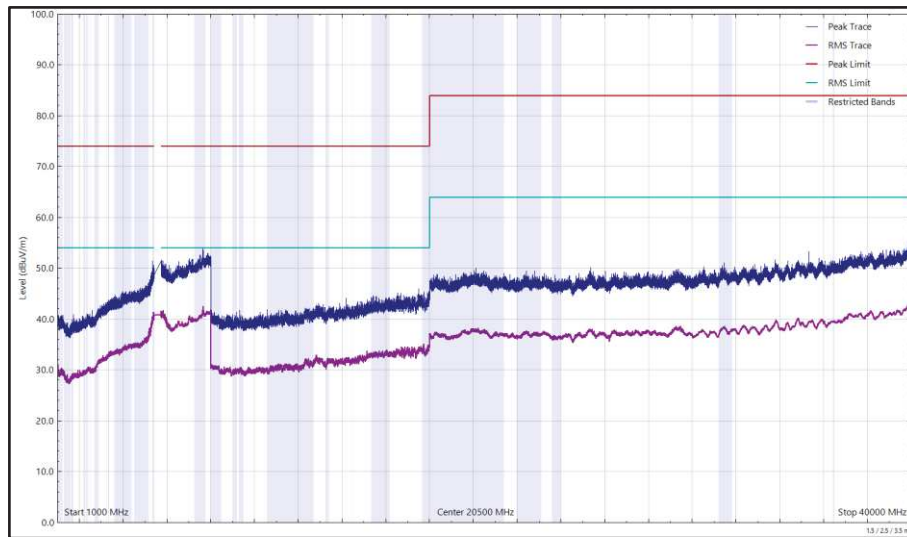

Figure 670 - U-NII-2C - 5500 MHz (CH100), 802.11a, Core 1, 1 GHz to 40 GHz, Horizontal

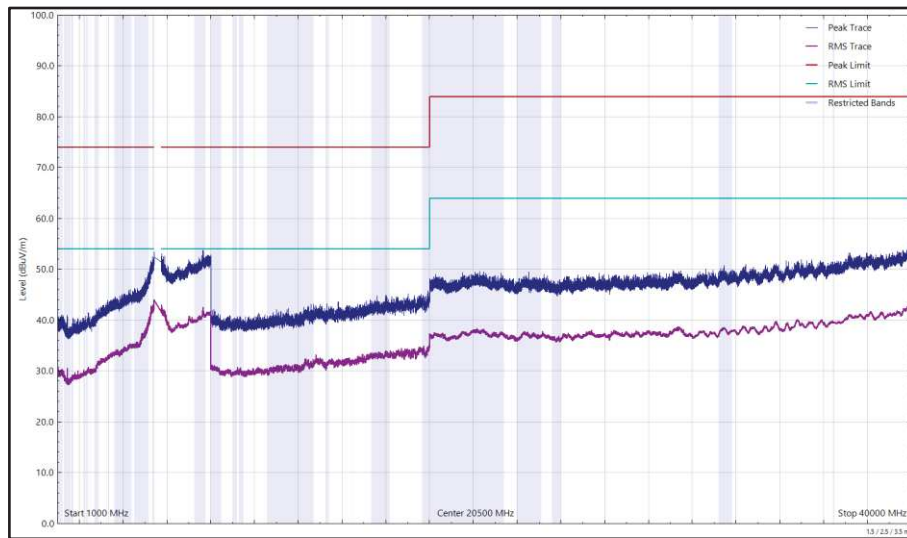

Figure 671 - U-NII-2C - 5500 MHz (CH100), 802.11a, Core 1, 1 GHz to 40 GHz, Vertical



Frequency (MHz)	Level (dBuV/m)	Limit (dBuV/m)	Margin (dB)	Detector	Angle (°)	Height (cm)	Polarisation
*							

Table 743 - U-NII-2C - 5700 MHz (CH140), 802.11a, Core 1, 1 GHz to 40 GHz

*No emissions found within 10 dB of the limit.

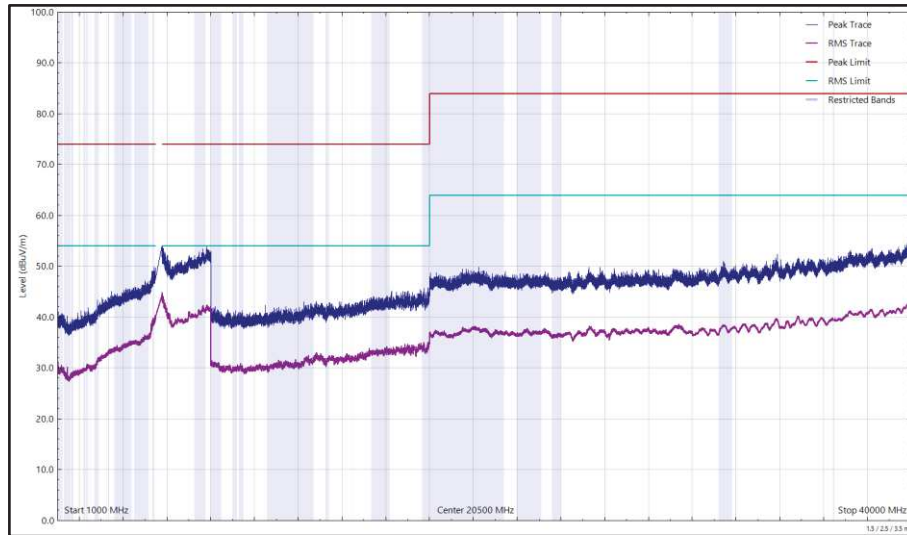

Figure 672 - U-NII-2C - 5700 MHz (CH140), 802.11a, Core 1, 1 GHz to 40 GHz, Horizontal

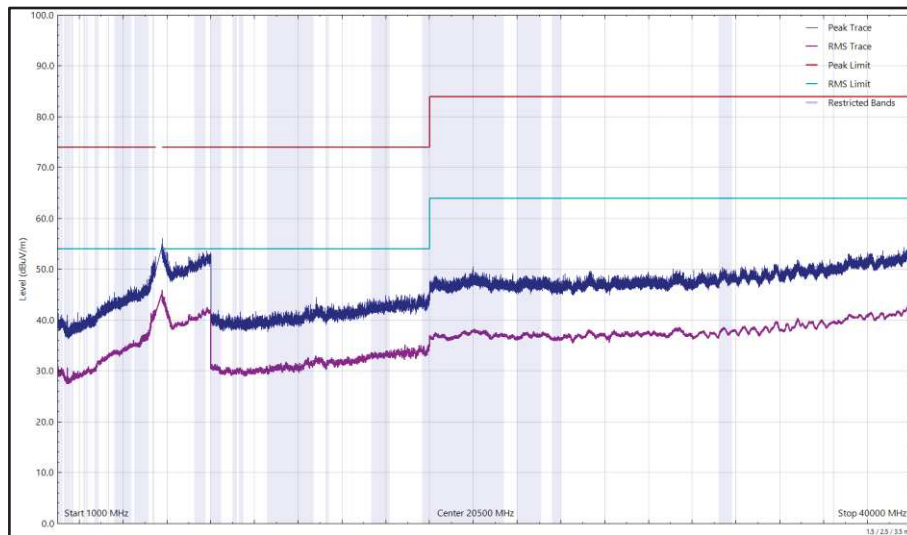

Figure 673 - U-NII-2C - 5700 MHz (CH140), 802.11a, Core 1, 1 GHz to 40 GHz, Vertical



Frequency (MHz)	Level (dBuV/m)	Limit (dBuV/m)	Margin (dB)	Detector	Angle (°)	Height (cm)	Polarisation
*							

Table 744 - U-NII-3 - 5745 MHz (CH149), 802.11a, Core 1, 1 GHz to 40 GHz

*No emissions found within 10 dB of the limit.

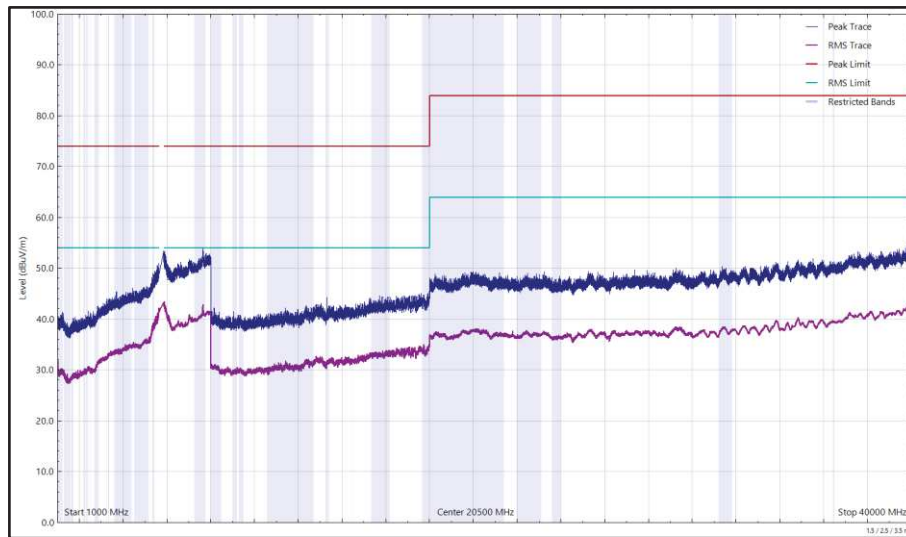

Figure 674 - U-NII-3 - 5745 MHz (CH149), 802.11a, Core 1, 1 GHz to 40 GHz, Horizontal

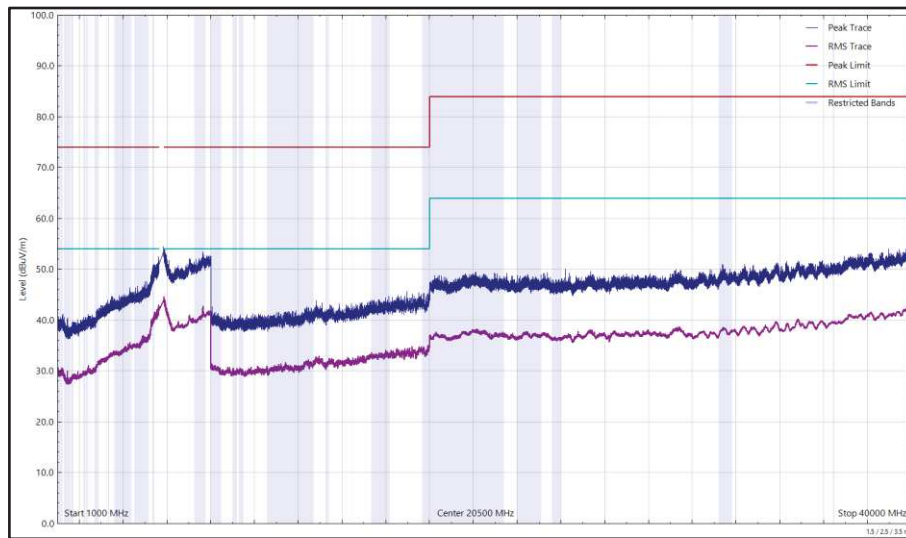

Figure 675 - U-NII-3 - 5745 MHz (CH149), 802.11a, Core 1, 1 GHz to 40 GHz, Vertical



Frequency (MHz)	Level (dBuV/m)	Limit (dBuV/m)	Margin (dB)	Detector	Angle (°)	Height (cm)	Polarisation
69.087	36.59	40.00	-3.41	Q-Peak	213	100	Vertical
69.333	24.43	40.00	-15.57	Q-Peak	2	394	Horizontal

Table 745 - U-NII-3 - 5825 MHz (CH165), 802.11a, Core 1, 30 MHz to 40 GHz

No other emissions found within 10 dB of the limit.

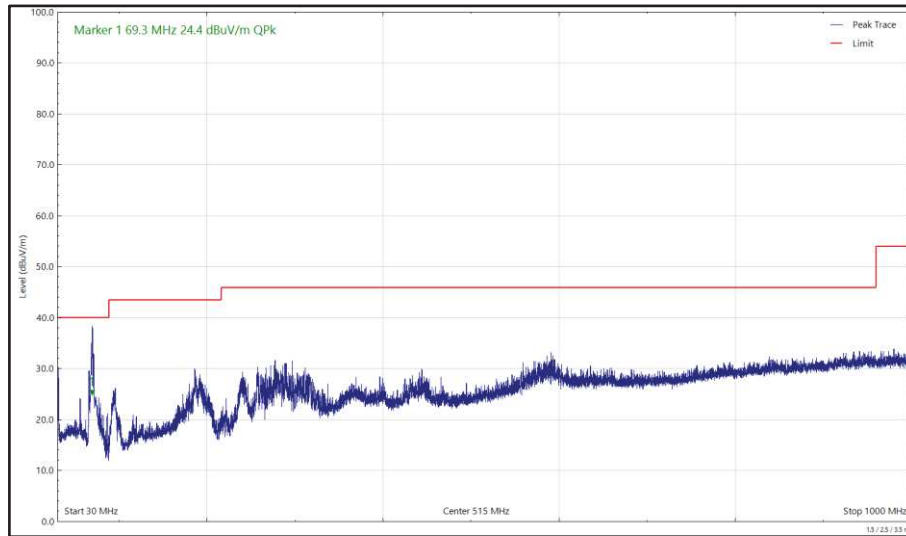

Figure 676 - U-NII-3 - 5825 MHz (CH165), 802.11a, Core 1, 30 MHz to 1 GHz, Horizontal (Peak)

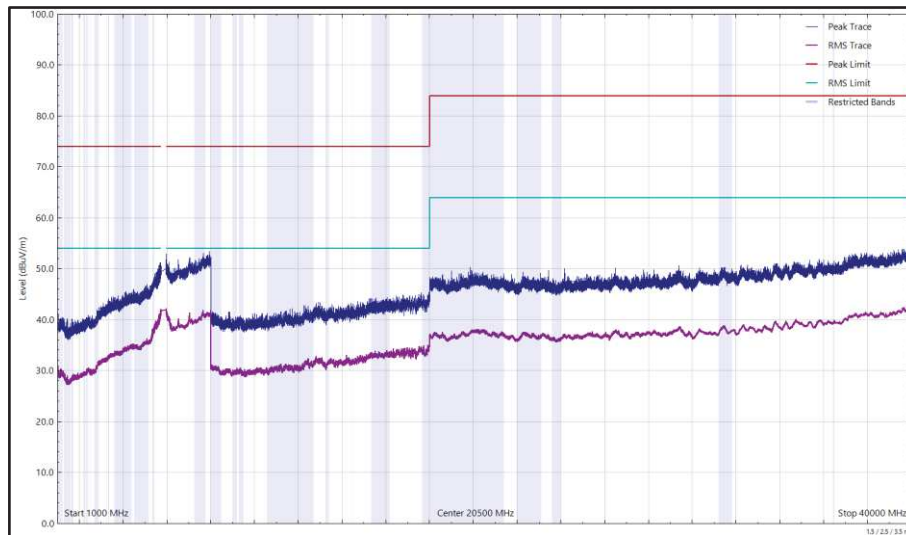

Figure 677 - U-NII-3 - 5825 MHz (CH165), 802.11a, Core 1, 1 GHz to 40 GHz, Horizontal

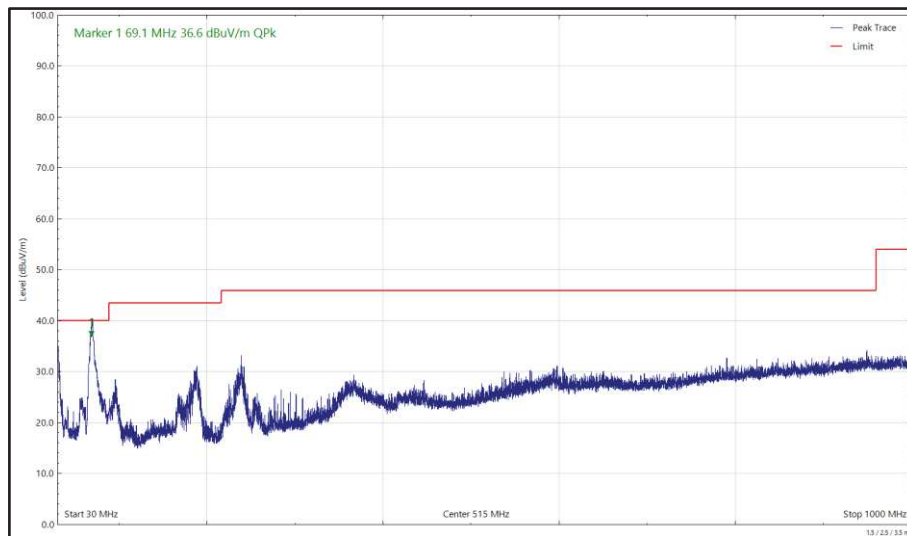

Figure 678 - U-NII-3 - 5825 MHz (CH165), 802.11a, Core 1, 30 MHz to 1 GHz, Vertical (Peak)

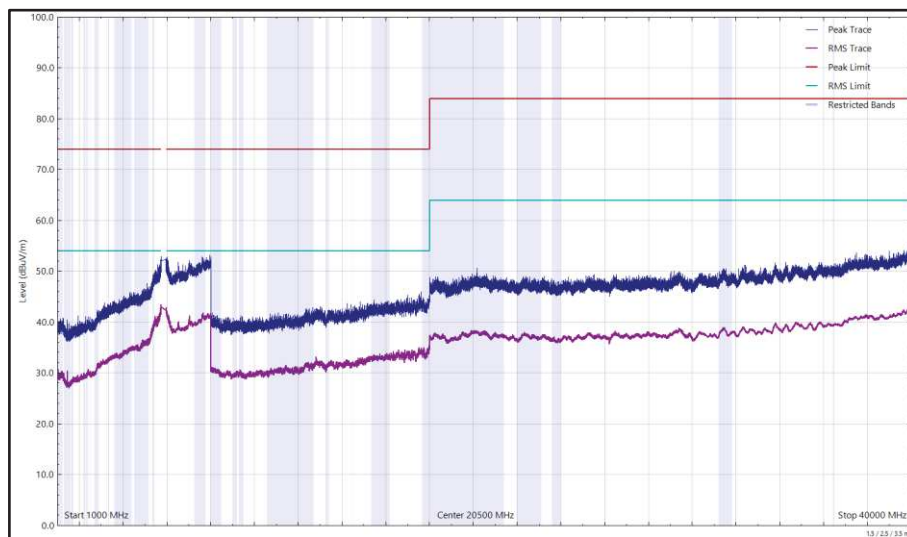

Figure 679 - U-NII-3 - 5825 MHz (CH165), 802.11a, Core 1, 1 GHz to 40 GHz, Vertical



FCC 47 CFR Part 15, Limit Clause 15.407(b)(1)(2)(3)(4)

Emissions not falling within the restricted bands listed in FCC 47 CFR Part 15.209:

For transmitters operating in the 5.15-5.25 GHz band: ≤ -27 dBm/MHz outside 5150-5350 MHz.

For transmitters operating in the 5.25-5.35 GHz band: ≤ -27 dBm/MHz outside 5150-5350 MHz.

For transmitters operating in the 5.47-5.725 GHz band: ≤ -27 dBm/MHz outside 5470-5725 MHz

For transmitters operating in the 5.725-5.85 GHz band: All emissions shall be limited to a level of -27 dBm/MHz at 75 MHz or more above or below the band edge increasing linearly to 10 dBm/MHz at 25 MHz above or below the band edge, and from 25 MHz above or below the band edge increasing linearly to a level of 15.6 dBm/MHz at 5 MHz above or below the band edge, and from 5 MHz above or below the band edge increasing linearly to a level of 27 dBm/MHz at the band edge.

Emissions within the restricted bands listed in FCC 47 CFR Part 15.209:

Frequency (MHz)	Field Strength (μ V/m) at 3m	Field Strength Limit (dB μ V/m) at 3m
30 to 88	100	40.00
88 to 216	150	43.52
216 to 960	200	46.02
Above 960	500	53.98

Table 746 - Radiated Emissions Limit Table (FCC)



ISED RSS-247, Limit Clause 6.2.1.2, 6.2.2.2, 6.2.3.2 and 6.2.4.2 and ISED RSS-GEN, Limit Clause 8.9

Emissions not falling within the restricted bands listed in ISED RSS-GEN, Clause 8.10:

For transmitters with operating frequencies in the band 5150-5250 MHz, all emissions outside the band 5150-5350 MHz shall not exceed -27 dBm/MHz e.i.r.p. Any unwanted emissions that fall into the band 5250-5350 MHz shall be attenuated below the channel power by at least 26 dB.

For transmitters with operating frequencies in the bands 5250-5350 MHz and 5470-5725 MHz, all emissions outside the band 5250-5350 MHz and 5470-5725 MHz shall not exceed -27 dBm/MHz e.i.r.p.

Devices operating in the band 5725-5850 MHz shall have e.i.r.p. of unwanted emissions comply with the following:

- a) 27 dBm/MHz at frequencies from the band edges decreasing linearly to 15.6 dBm/MHz at 5 MHz above or below the band edges;
- b) 15.6 dBm/MHz at 5 MHz above or below the band edges decreasing linearly to 10 dBm/MHz at 25 MHz above or below the band edges;
- c) 10 dBm/MHz at 25 MHz above or below the band edges decreasing linearly to -27 dBm/MHz at 75 MHz above or below the band edges; and
- d) -27 dBm/MHz at frequencies more than 75 MHz above or below the band edges.

Emissions falling within the restricted bands listed in ISED RSS-GEN, Clause 8.10:

Frequency (MHz)	Field Strength ($\mu\text{V}/\text{m}$) at 3m	Field Strength Limit ($\text{dB}\mu\text{V}/\text{m}$) at 3m
30 to 88	100	40.00
88 to 216	150	43.52
216 to 960	200	46.02
Above 960	500	53.98

Table 747 - Radiated Emissions Limit Table (ISED)



2.6.8 Test Location and Test Equipment Used

This test was carried out in RF Chamber 15.

Instrument	Manufacturer	Type No.	TE No.	Calibration Period (months)	Calibration Expiry Date
Cable (18 GHz)	Rosenberger	LU7-071-1000	5096	12	23-Oct-2023
Emissions Software	TUV SUD	EmX V3.1.12	5125	-	Software
EMI Test Receiver	Rohde & Schwarz	ESW44	5912	12	17-Apr-2024
DRG Horn Antenna (7.5-18GHz)	Schwarzbeck	HWRD750	5940	12	09-Jul-2024
TRILOG Super Broadband Test Antenna	Schwarzbeck	VULB 9168	5944	24	03-Feb-2024
1500W (300V 12A) AC Power Supply	iTech	IT7324	5956	-	O/P Mon
5m Semi-Anechoic Chamber (Dual-Axis), Chamber 15	Albatross Projects	RF Chamber 15	5963	36	28-Apr-2025
Compact Antenna Mast	Maturo Gmbh	CAM4.0-P	5964	-	TU
Mast & Turntable Controller	Maturo Gmbh	FCU3.0	5966	-	TU
Tilt Antenna Mast	Maturo Gmbh	BAM4.5-P	5967	-	TU
Turntable	Maturo Gmbh	TT1.5SI	5968	-	TU
Cable (SMA to SMA 1m)	Junkosha	MWX221-01000AMSAMS/A	5996	12	05-Jun-2024
Cable (N to N 8m)	Junkosha	MWX221-08000NMSNMS/A	6006	12	05-Jun-2024
Cable (SMA to SMA 1m)	Junkosha	MWX221-01000AMSAMS/A	6007	12	05-Jun-2024
Cable (SMA to SMA 6.5m)	Junkosha	MWX221-06500AMSAMS/B	6014	12	08-Aug-2023
Cable (N to N 7m)	Junkosha	MWX221-07000NMSNMS/B	6016	12	05-Jun-2024
Cable (SMA to SMA 1m)	Junkosha	MWX221-01000AMSAMS/B	6019	12	05-Jun-2024
Horn Antenna (1-10 GHz)	Schwarzbeck	BBHA9120B	6140	12	28-Aug-2023
Digital Multimeter	Fluke	115	6147	12	16-Jun-2024
Double Ridge Active Horn Antenna (18-40 GHz)	Com-Power	AHA-840	6187	24	02-Jun-2024
SAC Switch Unit	TUV SUD	TUV_SSU_001	6191	12	12-Dec-2023
8 GHz Highpass Filter	Wainwright	WHKX 7150 8000 18000 50SS	6195	12	24-Jul-2024*
Pre-Amp 8 - 18 GHz	Wright Technologies	APS06 0061	6200	12	14-Jul-2024
Attenuator (4 dB)	Pasternack	PE7074-4	6202	24	16-Jul-2024
Cable (SMA to SMA 20cm)	TUV SUD	MH-FH 8-18	6214	12	25-Jul-2023
Cable (SMA to SMA 20cm)	TUV SUD	MH-FH 8-18	6214	12	24-Jul-2024
Cable (SMA to SMA 1m)	Junkosha	MWX221-01000AMSAMS/A	6315	12	04-Feb-2024
Cable (K Type 2m)	Junkosha	MWX241-02000KMSKMS/B	6324	12	04-Feb-2024



Instrument	Manufacturer	Type No.	TE No.	Calibration Period (months)	Calibration Expiry Date
Humidity and Temperature Meter	R.S Components	1364	6346	12	28-Feb-2024
DRG Horn Antenna	Schwarzbeck	HWRD750	6458	12	09-Jul-2024

Table 748

TU - Traceability Unscheduled
O/P Mon - Output Monitored using calibrated equipment

*NOTE: Only used within its calibration period.



2.7 Channel Move Time, Channel Closing Transmission Time and Non-Occupancy Period

2.7.1 Specification Reference

FCC 47 CFR Part 15E, Clause 15.407 (h)(2)(iii)(iv)
ISED RSS-247, Clause 6.3.2(c)(d)(e)

2.7.2 Equipment Under Test and Modification State

A2991, S/N: J042FJ2R12 - Modification State 0

2.7.3 Date of Test

12-August-2023 to 30-August-2023

2.7.4 Test Method

This test was performed in accordance with FCC KDB 905462 D02, clause 7.8.3.

Radar Pulse Type 0 was then transmitted, and the spectrum monitored. The transmissions from the UUT were observed for a period of 12 seconds after the final injected Radar Pulse.

It was checked that all transmissions stopped within the 10 second period defined from the point of the end of the final Radar pulse + 10 seconds. In addition, the aggregate on time during the first 200ms and the following 9.8 seconds of the Channel Move Time was computed.

The markers on the trace data correspond to the following time periods:

Yellow - End of Radar Burst, (T0)

Purple - End of Channel Move Time, (T0 + 10 seconds)

To verify the non-occupancy period, the external trigger was used to trigger a 30-minute sweep from the moment the radar burst sequence was injected. It was verified that no transmissions occurred on the test channel during this time period.

2.7.5 Environmental Conditions

Ambient Temperature 23.7 - 24.3 °C

Relative Humidity 39.5 - 44.9 %

2.7.6 Test Results

5 GHz WLAN - Master to Client - 802.11ac VHT160

The equipment was set up as shown in the diagram below.

The test laptop was configured to run iPerf, transmitting UDP data to the EUT via the DFS Master. The channel loading was set to >17% by adjusting the bandwidth specified in the iPerf UDP transfer.

To calibrate the level of the radar at the input to the companion device, the companion device was replaced by the spectrum analyser and the output of the vector signal generator adjusted to give -62 dBm.

Radar Type	Pulse Width (μ s)	PRI (μ s)	Number of Pulses
0	1	1428	18

Table 749 - Radar Pulse Type 0 Characteristics

Manufacturer	Model	Serial Number	FCC ID
ASUS	GT-AXE11000	N51G0X400280MY7	MSQ-RTAXJF00

Table 750 - Details of Master Device used to support testing

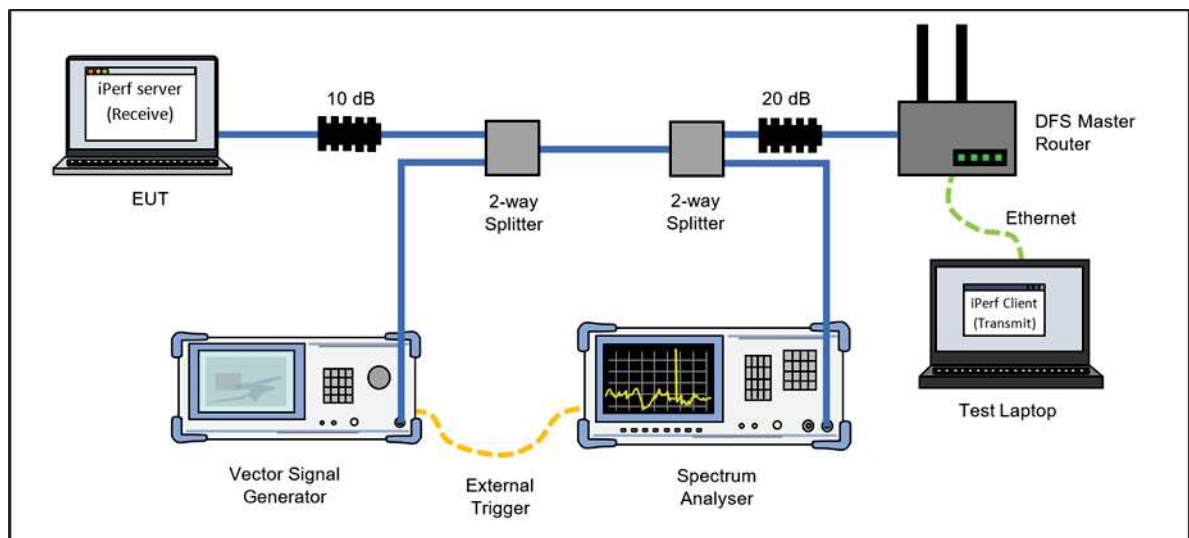

Figure 680 - Test Equipment Setup Diagram for Client without Radar Detection with Injection at the Master

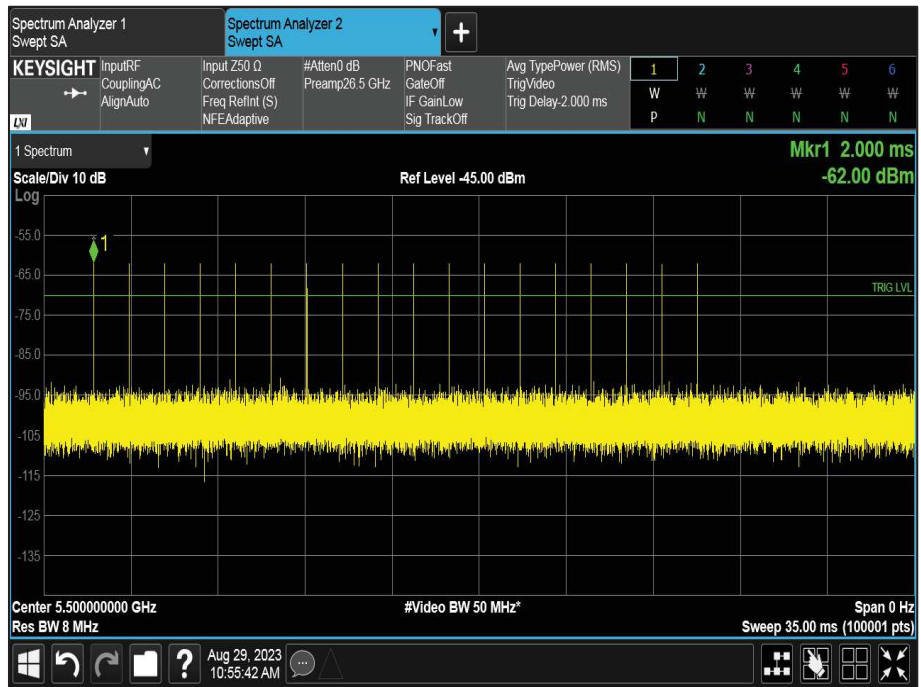

Figure 681- Verification of Radar Type 0

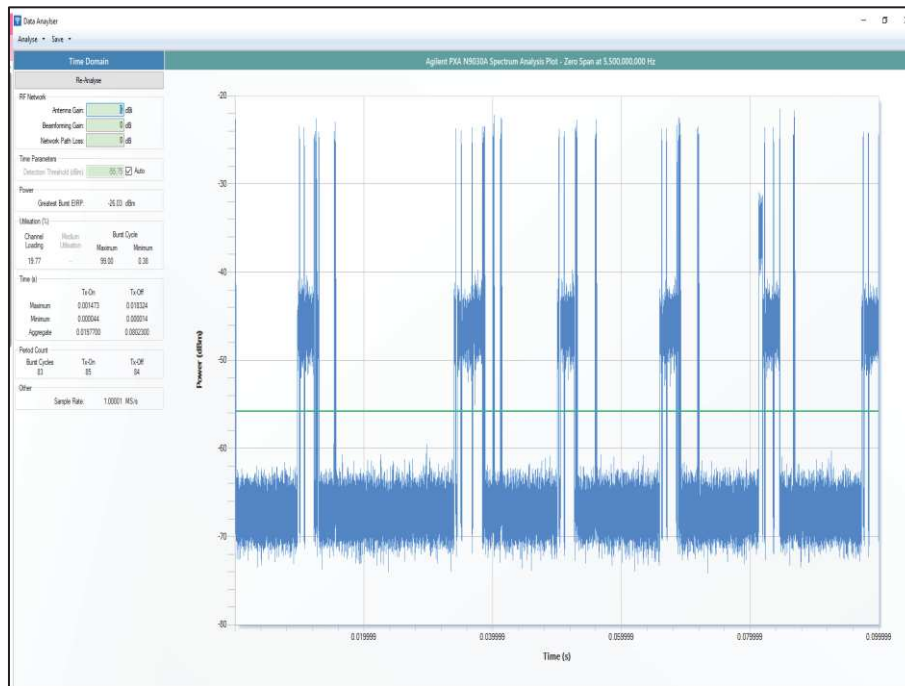

Figure 682- Channel Loading

The channel loading was 19.77%



Maximum Transmit Power	Value (Notes 1 and 2)
≥ 200 milliwatt	-64 dBm
< 200 milliwatt	-62 dBm
Note 1: This is the level at the input of the receiver assuming a 0 dBi receive antenna. Note 2: Throughout these test procedures an additional 1 dB has been added to the amplitude of the test transmission waveforms to account for variations in measurement equipment. This will ensure that the test signal is at or above the detection threshold level to trigger a DFS response.	

Table 751 - DFS Detection Thresholds for Master Devices and Client Devices with Radar Detection

Test Parameter	Result
Test Channel	CH114 (5570 MHz), Control CH100 (5500 MHz)
Channel Move Time	0.101 ms
Channel Closing Time (Aggregate Time During 200 ms)	4.440 ms
Channel Closing Time (Aggregate Time During 200 ms to 10 s)	0.000 ms
Channel Closing Time (Aggregate Time During 10 s)	4.440 ms
Transmission Observed During Non-Occupancy Period	No

Table 752 - In-Service Monitoring Test Results

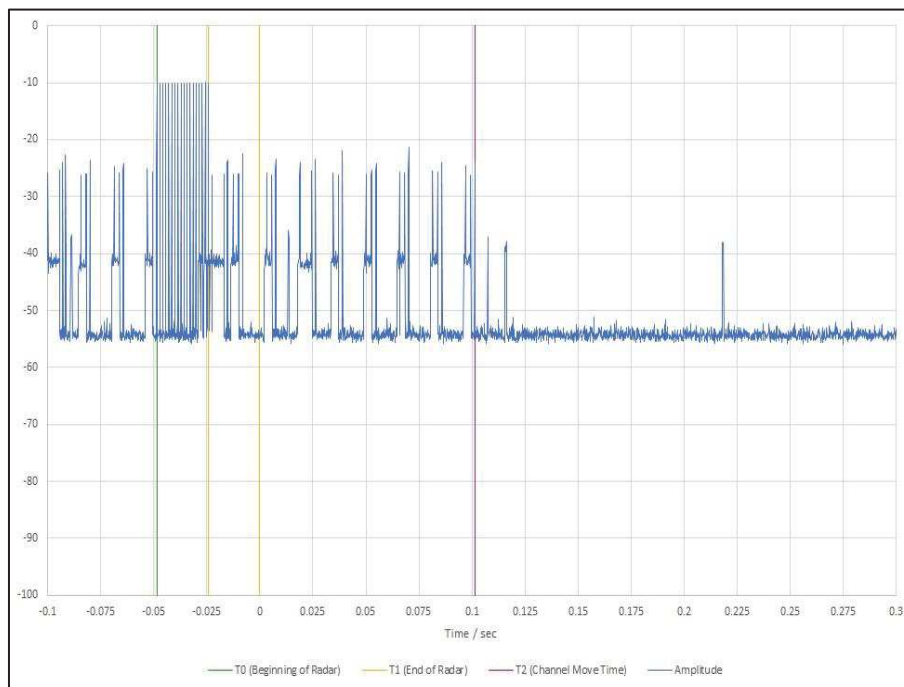

Figure 683 - First 200 ms of Channel Shutdown Period

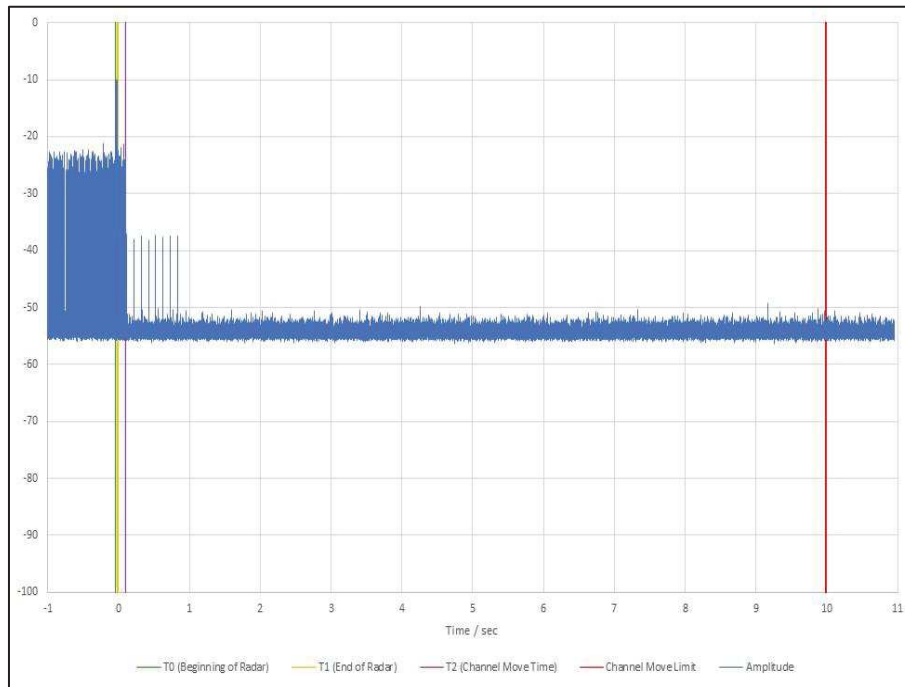

Figure 684 - First 12 s of Channel Shutdown Period



Figure 685 - 30 minute Non-Occupancy Period

5 GHz WLAN - Client to Client - 802.11ac VHT80

The equipment was set up as shown in the diagram below.

The EUT and a 2nd client device were both connected to the DFS Master device. The EUT was set to stream video directly to the 2nd client device using the AirPlay protocol, while under the supervision of the DFS master (but without the DFS master re-transmitting the data packets).

To calibrate the level of the radar at the input to the DFS Master, the DFS Master device was replaced by the spectrum analyser and the output of the vector signal generator adjusted to give -62 dBm.

Radar Type	Pulse Width (μ s)	PRI (μ s)	Number of Pulses
0	1	1428	18

Table 753 - Radar Pulse Type 0 Characteristics

Manufacturer	Model	Serial Number	FCC ID
ASUS	GT-AXE11000	N51G0X400280MY7	MSQ-RTAXJF00

Table 754 - Details of Master Device used to support testing

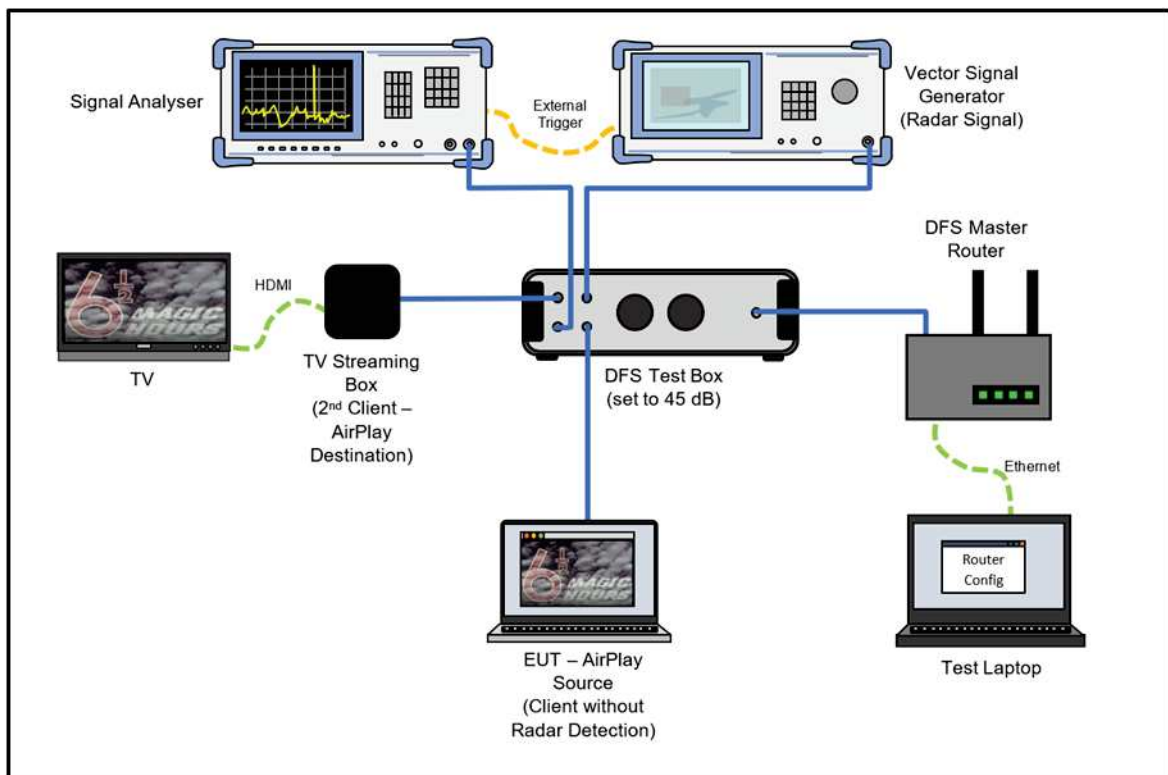

Figure 686- Test Equipment Setup Diagram for Client without Radar Detection with Injection at the Master

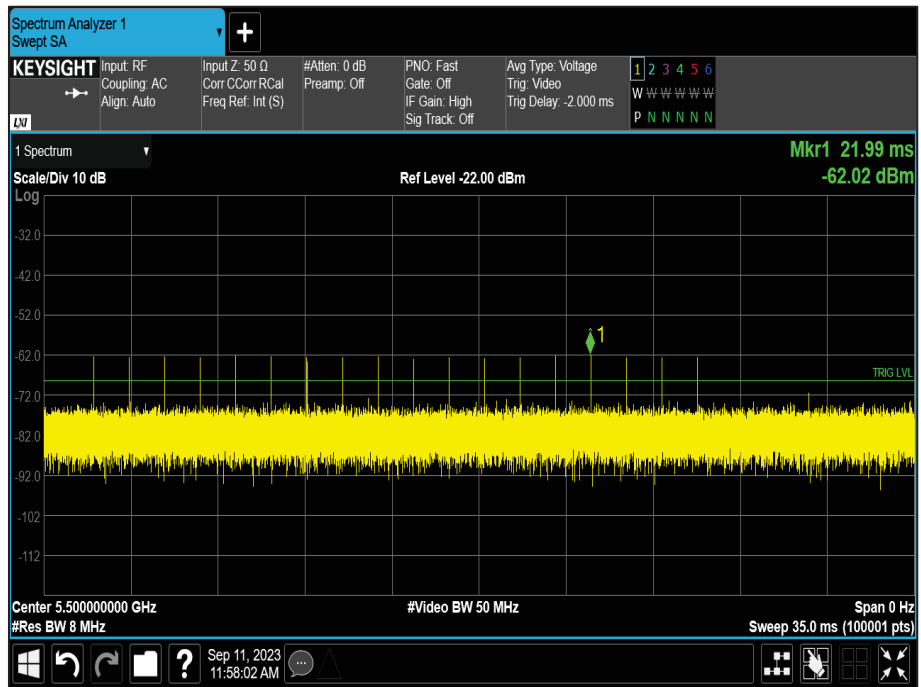

Figure 687- Verification of Radar Type 0

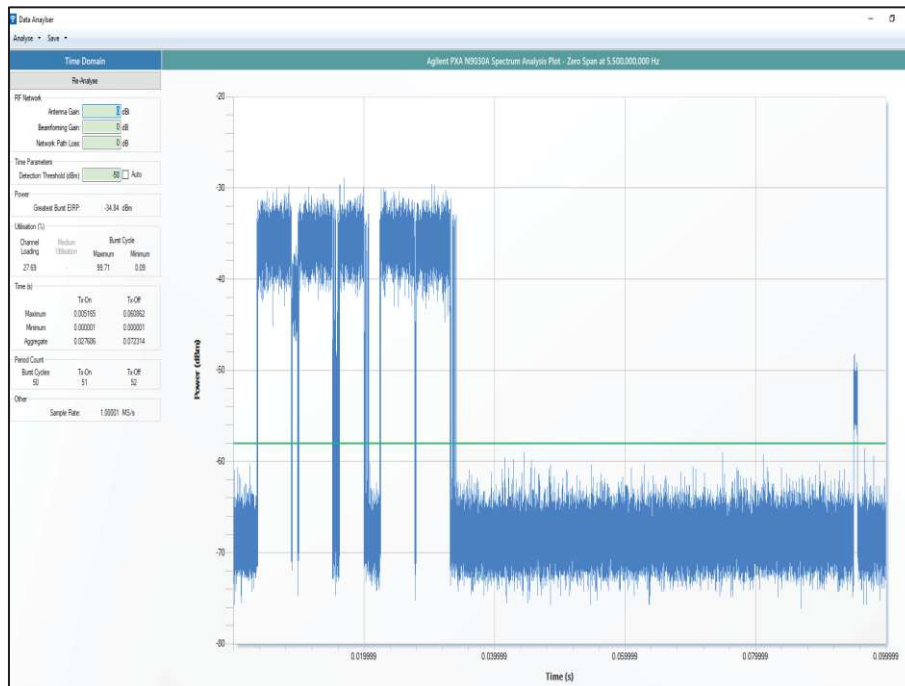

Figure 688- Channel Loading

The channel loading was 27.69%



Maximum Transmit Power	Value (Notes 1 and 2)
≥ 200 milliwatt	-64 dBm
< 200 milliwatt	-62 dBm
Note 1: This is the level at the input of the receiver assuming a 0 dBi receive antenna. Note 2: Throughout these test procedures an additional 1 dB has been added to the amplitude of the test transmission waveforms to account for variations in measurement equipment. This will ensure that the test signal is at or above the detection threshold level to trigger a DFS response.	

Table 755 - DFS Detection Thresholds for Master Devices and Client Devices with Radar Detection

Test Parameter	Result
Test Channel	CH114 (5570 MHz), Control CH100 (5500 MHz)
Channel Move Time	0.175 s
Channel Closing Time (Aggregate Time During 200 ms)	0.840 ms
Channel Closing Time (Aggregate Time During 200 ms to 10 s)	0.000 ms
Channel Closing Time (Aggregate Time During 10 s)	0.840 ms
Transmission Observed During Non-Occupancy Period	No

Table 756 - In-Service Monitoring Test Results

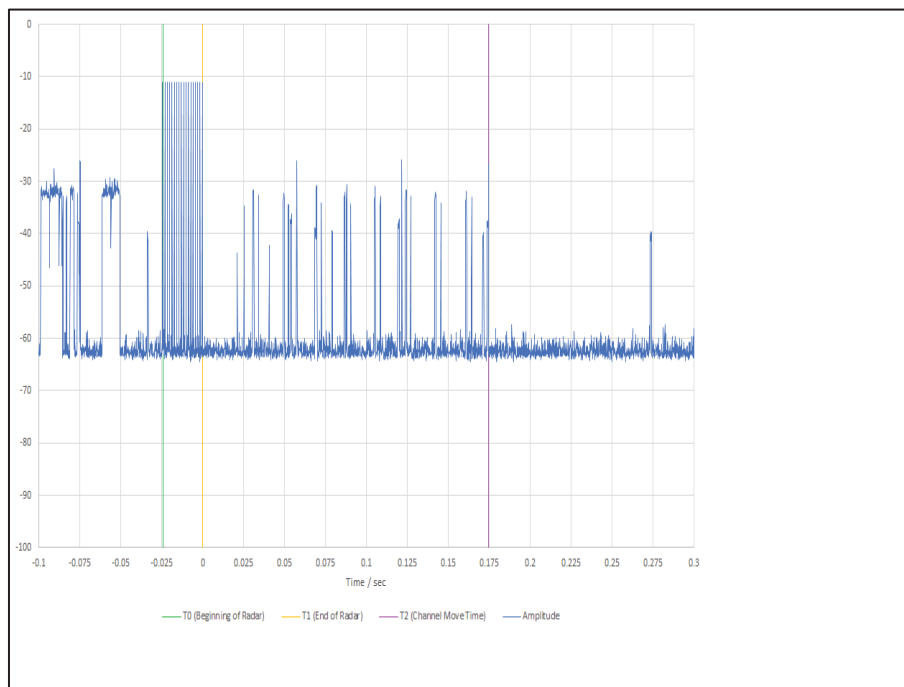

Figure 689 - First 200 ms of Channel Shutdown Period

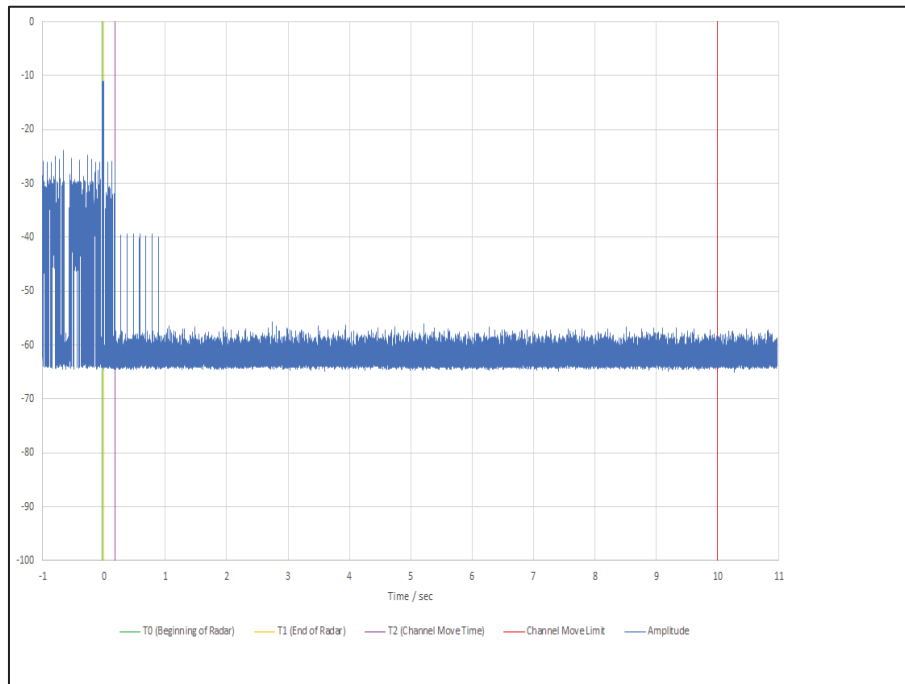

Figure 690 - First 12 s of Channel Shutdown Period



Figure 691 - 30 minute Non-Occupancy Period



FCC 47 CFR Part 15, Limit Clause 15.407 (h)(2)(iii)

Channel Move Time	<10 seconds
Channel Closing Time (Aggregate Time During 200ms)	<200 ms
Channel Closing Time (Aggregate Time During +200ms to 10s)	<60 ms

Table 757 - Channel Move Time and Channel Closing Transmission Time Limit

FCC 47 CFR Part 15, Limit Clause 15.407 (h)(2)(iv)

Non-occupancy Period	> 30 minutes
----------------------	--------------

Table 758 - Non-Occupancy Limit

ISED RSS-247, Limit Clause 6.3.2

Devices shall comply with the following requirements, however, the requirement for in-service monitoring does not apply to slave devices without radar detection.

In-service monitoring: an LE-LAN device shall be able to monitor the operating channel to check that a co-channel radar has not moved or started operation within range of the LE-LAN device. During in-service monitoring, the LE-LAN radar detection function continuously searches for radar signals between normal LE-LAN transmissions.

Channel availability check time: the device shall check whether there is a radar system already operating on the channel before it initiates a transmission on a channel and when it moves to a channel. The device may start using the channel if no radar signal with a power level greater than the interference threshold value specified in Section 6.3.1 above is detected within 60 seconds. This requirement only applies in the master operational mode.

Channel move time: after a radar signal is detected, the device shall cease all transmissions on the operating channel within 10 seconds.

Channel closing transmission time: is comprised of 200 ms starting at the beginning of the channel move time plus any additional intermittent control signals required to facilitate a channel move (an aggregate of 60 ms) over the remaining 10-second period of the channel move time.

Non-occupancy period: a channel that has been flagged as containing a radar signal, either by a channel availability check or in-service monitoring, is subject to a 30-minute non-occupancy period where the channel cannot be used by the LE-LAN device. The non-occupancy period starts from the time that the radar signal is detected.



2.7.7 Test Location and Test Equipment Used

This test was carried out in Shielded Laboratory 1.

Instrument	Manufacturer	Type No.	TE No.	Calibration Period (months)	Calibration Expiry Date
EXA Signal Analyser	Keysight Technologies	N9010B	4968	24	19-Jan-2024
Cable (40 GHz)	Rosenberger	LU1-001-500	5021	12	29-Jan-2024
Cable (18 GHz)	Rosenberger	LU7-071-1000	5103	12	18-Dec-2023
Cable (18 GHz)	Rosenberger	LU7-071-2000	5107	12	18-Dec-2023
Cable (18 GHz)	Rosenberger	LU7-071-2000	5110	12	18-Jun-2024
Cable 2.92m	Junkosha	MWX241-01000KMS	5413	12	21-May-2024
Thermo-Hygro-Barometer	PCE Instruments	PCE-THB 40	5605	12	06-Oct-2023
2-Way Power Divider (2-8 GHz)	Aaren	AT30A-TE0208-2-AF	5685	12	21-Oct-2023
2-Way Power Divider (2-8 GHz)	Aaren	AT30A-TE0208-2-AF	5687	12	23-Oct-2024
Vector Signal Generator	Rohde & Schwarz	SMM100A	5915	36	01-Mar-2026
Cable (K Type 2m)	Junkosha	MWX241-02000KMSKMS/B	5936	12	21-May-2024
Cable (K Type 2m)	Junkosha	MWX241-02000KMSKMS/B	5938	12	21-May-2024
WiFi 6E Tri-Band Gaming Router	Asus	GT-AXE110000	6251	-	TU
Cable (SMA to SMA 1m)	Junkosha	MWX221/B	6305	12	04-Feb-2024
MXA Signal Analyzer	Keysight Technologies	N9020B	6415	24	22-Mar-2025
Test Coupling Network	TUV SUD	TUV_RxTest_001	6441	12	24-Apr-2024
Vector Signal Generator (7.5GHz)	Rohde & Schwarz	SMM100A	6532	36	11-Apr-2026
Attenuator 5W 10dB DC-18GHz	Aaren	AT40A-4041-D18-10	6549	12	18-Jun-2024
Attenuator 5W 20dB DC-18GHz	Aaren	AT40A-4041-D18-20	6554	12	18-Jun-2024

Table 759

TU - Traceability Unscheduled



3 Measurement Uncertainty

For a 95% confidence level, the measurement uncertainties for defined systems are:

Test Name	Measurement Uncertainty
Restricted Band Edges	± 6.3 dB
Emission Bandwidth	± 3.91 MHz
Maximum Conducted Output Power	± 1.38 dB
Maximum Conducted Power Spectral Density	± 1.49 dB
Authorised Band Edges	± 6.3 dB
Spurious Radiated Emissions	30 MHz to 1 GHz: ± 5.2 dB 1 GHz to 40 GHz: ± 6.3 dB
Channel Move Time, Channel Closing Transmission Time and Non-Occupancy Period	Time: ± 0.47 % Power: ± 1.29 dB

Table 760

Measurement Uncertainty Decision Rule – Accuracy Method

Determination of conformity with the specification limits is based on the decision rule according to IEC Guide 115:2021, Clause 4.4.3 (Procedure 2). The measurement results are directly compared with the test limit to determine conformance with the requirements of the standard.

Risk: The uncertainty of measurement about the measured result is negligible with regard to the final pass/fail decision. The measurement result can be directly compared with the test limit to determine conformance with the requirement (compare IEC Guide 115). The level of risk to falsely accept and falsely reject items is further described in ILAC-G8.