

FCC and ISED Test Report

Apple Inc
Model: A2918

In accordance with FCC 47 CFR Part 15, ISED RSS-247, ISED RSS-248 and ISED RSS-GEN (2.4 GHz Bluetooth, 2.4 GHz WLAN, 5 GHz WLAN, 6 GHz WLAN, Narrowband and Thread)

Prepared for: Apple Inc
One Apple Park Way
Cupertino
California
95014
USA

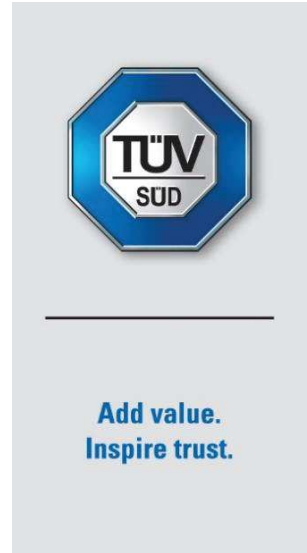

Digitally signed by
TUV SUD
Date: 2023.10.11
13:53:58 +01'00'

FCC ID: BCGA2918

IC: 579C-A2918

COMMERCIAL-IN-CONFIDENCE

Document 75957632-27 Issue 02

SIGNATURE			
NAME	JOB TITLE	RESPONSIBLE FOR	ISSUE DATE
Steve Marshall	Senior Engineer	Authorised Signatory	11 October 2023

Signatures in this approval box have checked this document in line with the requirements of TÜV SÜD document control rules.

ENGINEERING STATEMENT

The measurements shown in this report were made in accordance with the procedures described on test pages. All reported testing was carried out on a sample equipment to demonstrate limited compliance with FCC 47 CFR Part 15, ISED RSS-247, ISED RSS-248 and ISED RSS-GEN. The sample tested was found to comply with the requirements defined in the applied rules.

RESPONSIBLE FOR	NAME	DATE	SIGNATURE
Report Generation	Lauren Walters	11 October 2023	

FCC Accreditation

553713/UK2026 Concorde Park, Fareham Test Laboratory

ISED Accreditation

28798 Concorde Park, Fareham Test Laboratory

EXECUTIVE SUMMARY

A sample of this product was tested and found to be compliant with FCC 47 CFR Part 15: 2021, ISED RSS-247: Issue 2 (2017-02), ISED RSS-248: Issue 2 (2022-12) and ISED RSS-GEN: Issue 5 (2018-04) + A2 (2021-02) for the tests detailed in section 1.3.

		DISCLAIMER AND COPYRIGHT This non-binding report has been prepared by TÜV SÜD with all reasonable skill and care. The document is confidential to the potential Client and TÜV SÜD. No part of this document may be reproduced without the prior written approval of TÜV SÜD. © 2023 TÜV SÜD. This report relates only to the actual item/items tested.
		ACCREDITATION Our UKAS Accreditation does not cover opinions and interpretations and any expressed are outside the scope of our UKAS Accreditation. Results of tests not covered by our UKAS Accreditation Schedule are marked NUA (Not UKAS Accredited).

TÜV SÜD
is a trading name of TÜV SÜD Ltd
Registered in Scotland at East Kilbride,
Glasgow G75 0QF, United Kingdom
Registered number: SC215164

TÜV SÜD Ltd is a
TÜV SÜD Group Company

Phone: +44 (0) 1489 558100
Fax: +44 (0) 1489 558101
www.tuvsud.com/en

TÜV SÜD
Octagon House
Concorde Way
Fareham
Hampshire PO15 5RL
United Kingdom



Contents

1	Report Summary	2
1.1	Report Modification Record.....	2
1.2	Introduction.....	2
1.3	Brief Summary of Results	3
1.4	Product Information	4
1.5	Deviations from the Standard.....	4
1.6	EUT Modification Record	4
1.7	Test Location	5
2	Test Details	6
2.1	Radiated Spurious Emissions (Simultaneous Transmission)	6
3	Measurement Uncertainty	63



1 Report Summary

1.1 Report Modification Record

Alterations and additions to this report will be issued to the holders of each copy in the form of a complete document.

Issue	Description of Change	Date of Issue
1	First Issue	30-May-2023
2	Update to FCC/ISED Accreditation Number Update to RSS 248 issue 2	11-October-2023

Table 1

1.2 Introduction

Applicant	Apple Inc
Manufacturer	Apple Inc
Model Number(s)	A2918
Serial Number(s)	D5WW0J3220
Hardware Version(s)	REV 1.0
Software Version(s)	22E21820r
Number of Samples Tested	1
Test Specification/Issue/Date	FCC 47 CFR Part 15: 2021 ISED RSS-247: Issue 2 (2017-02) ISED RSS-248: Issue 2 (2022-12) ISED RSS-GEN: Issue 5 (2018-04) + A2 (2021-02)
Start of Test	28-March-2023
Finish of Test	16-May-2023
Name of Engineer(s)	Ioan-Alexandru Bogatu, Nicolae Mihailiuc, James Woods, Mohammad Malik and Akhil Rajendran Bhaskaran Nair
Related Document(s)	ANSI C63.10: 2013 ANSI C63.10: 2020 ANSI C63.4 (2014) KDB 789033



1.3 Brief Summary of Results

A brief summary of the tests carried out in accordance with FCC 47 CFR Part 15, ISED RSS-247, ISED RSS-248 and ISED RSS-GEN is shown below.

Section	Specification Clause				Test Description	Result	Comments/Base Standard
	Part 15	RSS-247	RSS-248	RSS-GEN			
Configuration and Mode: CoTx - 2.4 GHz Bluetooth and 5 GHz WLAN							
2.1	15.209, 15.247(d) and 15.407(b)	5.5 and 6.2	-	6.13 and 8.9	Radiated Spurious Emissions (Simultaneous Transmission)	Pass	
Configuration and Mode: CoTx - 2.4 GHz Bluetooth and 6 GHz WLAN							
2.1	15.209, 15.247(d) and 15.407(b)	5.5	4.6	6.13 and 8.9	Radiated Spurious Emissions (Simultaneous Transmission)	Pass	
Configuration and Mode: CoTx - 2.4 GHz WLAN and Narrowband							
2.1	15.209, 15.247(d) and 15.407(b)	5.5 and 6.2	-	6.13 and 8.9	Radiated Spurious Emissions (Simultaneous Transmission)	Pass	
Configuration and Mode: CoTx - Thread and 5 GHz WLAN							
2.1	15.209, 15.247(d) and 15.407(b)	5.5 and 6.2	-	6.13 and 8.9	Radiated Spurious Emissions (Simultaneous Transmission)	Pass	
Configuration and Mode: CoTx - Thread and 6 GHz WLAN							
2.1	15.209, 15.247(d) and 15.407(b)	5.5	4.6	6.13 and 8.9	Radiated Spurious Emissions (Simultaneous Transmission)	Pass	

Table 2



1.4 Product Information

1.4.1 Technical Description

The equipment under test (EUT) was a portable laptop computer.

1.5 Deviations from the Standard

No deviations from the applicable test standard were made during testing.

1.6 EUT Modification Record

The table below details modifications made to the EUT during the test programme.

The modifications incorporated during each test are recorded on the appropriate test pages.

Modification State	Description of Modification still fitted to EUT	Modification Fitted By	Date Modification Fitted
Model: A2918, Serial Number: D5WW0J3220			
0	As supplied by the customer	Not Applicable	Not Applicable

Table 3



1.7 Test Location

TÜV SÜD conducted the following tests at our Concorde Park Test Laboratory.

Test Name	Name of Engineer(s)	Accreditation
Configuration and Mode: CoTx - 2.4 GHz Bluetooth and 5 GHz WLAN		
Radiated Spurious Emissions (Simultaneous Transmission)	Ioan-Alexandru Bogatu and Nicolae Mihailiuc	UKAS
Configuration and Mode: CoTx - 2.4 GHz Bluetooth and 6 GHz WLAN		
Radiated Spurious Emissions (Simultaneous Transmission)	Ioan-Alexandru Bogatu and Nicolae Mihailiuc	UKAS
Configuration and Mode: CoTx - 2.4 GHz WLAN and Narrowband		
Radiated Spurious Emissions (Simultaneous Transmission)	Ioan-Alexandru Bogatu and Nicolae Mihailiuc	UKAS
Configuration and Mode: CoTx - Thread and 5 GHz WLAN		
Radiated Spurious Emissions (Simultaneous Transmission)	James Woods and Mohammad Malik	UKAS
Configuration and Mode: CoTx - Thread and 6 GHz WLAN		
Radiated Spurious Emissions (Simultaneous Transmission)	Ioan-Alexandru Bogatu, Akhil Rajendran Bhaskaran Nair and Nicolae Mihailiuc	UKAS

Table 4

Office Address:

TÜV SÜD
 Concorde Park
 Concorde Way
 Fareham
 Hampshire
 PO15 5FG
 United Kingdom



2 Test Details

2.1 Radiated Spurious Emissions (Simultaneous Transmission)

2.1.1 Specification Reference

FCC 47 CFR Part 15, Clause 15.209, 15.247(d) and 15.407(b)
ISED RSS-247, Clause 5.5 and 6.2
ISED RSS-248, Clause 4.6
ISED RSS-GEN, Clause 6.13 and 8.9

2.1.2 Equipment Under Test and Modification State

A2918, S/N: D5WW0J3220 - Modification State 0

2.1.3 Date of Test

28-March-2023 to 16-May-2023

2.1.4 Test Method

This test was performed in accordance with ANSI C63.10, clause 6.3, 6.5 and 6.6.

The EUT was placed on the non-conducting platform in a manner typical of a normal installation.

Ports on the EUT were terminated with loads as described in ANSI C63.4 clause 6.2.4 for each type of port on the EUT.

For frequencies > 1 GHz, plots for average measurements were taken in accordance with ANSI C63.10, clause 4.1.4.2.5 to characterize the EUT. Where emissions were detected, final average measurements were taken in accordance with ANSI C63.10, clause 4.1.4.2.2, 11.11, 11.12, 12.7.2 or 12.7.3 depending on the nature of the emission measured.

The plots shown are the characterisation of the EUT. The limits on the plots represent the most stringent case for restricted bands, (74/54 dBuV/m) when compared to non-restricted band limits. The limits shown have been used as a threshold to determine where further measurements are necessary. Where results are within 10 dB of the limits shown on the plots, further investigation was carried out and reported in results tables.

The following conversion can be applied to convert from dBµV/m to µV/m:
 $10^{(\text{Field Strength in dB}\mu\text{V/m}/20)}$.

At a measurement distance of 1 meter the limit line was increased by $20 \cdot \text{LOG}(3/1) = 9.54$ dB.

.

2.1.5 Example Test Setup Diagram

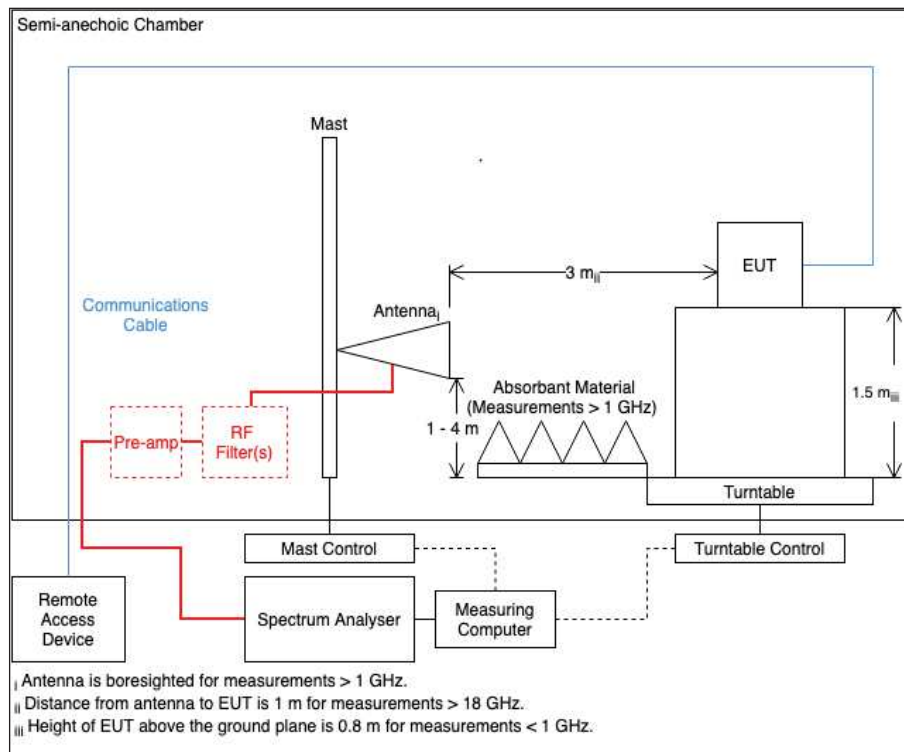

Figure 1

2.1.6 Environmental Conditions

Ambient Temperature	20.9 - 22.9 °C
Relative Humidity	32.5 - 46.2 %



2.1.7 Test Results

CoTx - 2.4 GHz Bluetooth and 5 GHz WLAN

Frequency (MHz)	Level (dBuV/m)	Limit (dBuV/m)	Margin (dB)	Detector	Angle (°)	Height (cm)	Polarisation
2800.509	33.51	54.00	-20.49	RMS	3	372	Horizontal
4881.723	42.05	54.00	-11.95	CISPR Avg	27	256	Horizontal

Table 5 - 2441 MHz (CH39), 2-DH5, ePA, Core 0 + Core 1 and U-NII-1 - 5240 MHz (CH48), VHT20, Core 0 + Core 1, 30 MHz to 40 GHz

No other emissions found within 10 dB of the limit.

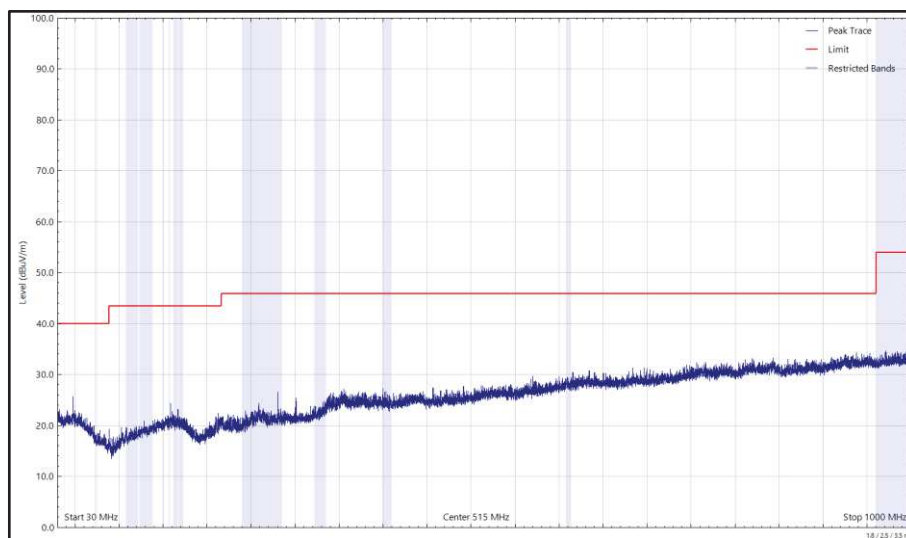

Figure 2 - 2441 MHz (CH39), 2-DH5, ePA, Core 0 + Core 1 and U-NII-1 - 5240 MHz (CH48), VHT20, Core 0 + Core 1, 30 MHz to 1 GHz, Horizontal (Peak)

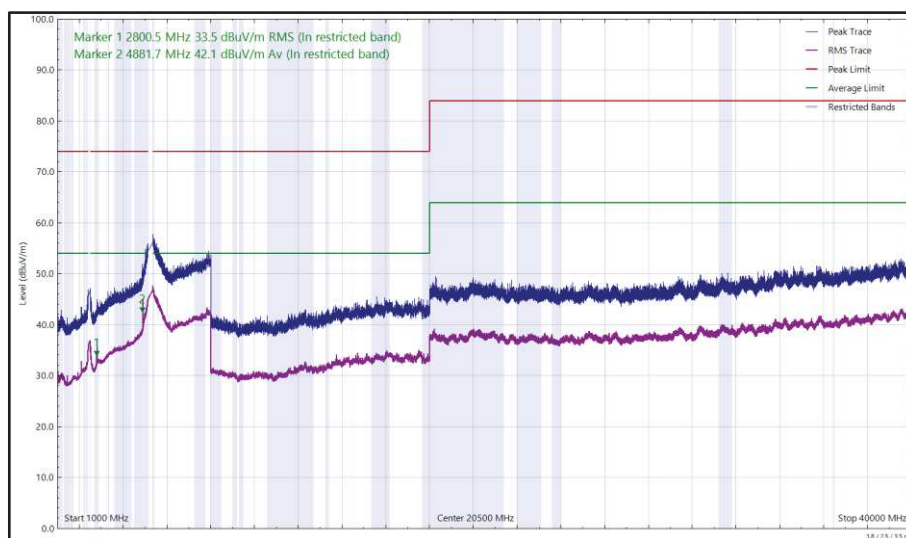

Figure 3 - 2441 MHz (CH39), 2-DH5, ePA, Core 0 + Core 1 and U-NII-1 - 5240 MHz (CH48), VHT20, Core 0 + Core 1, 1 GHz to 40 GHz, Horizontal

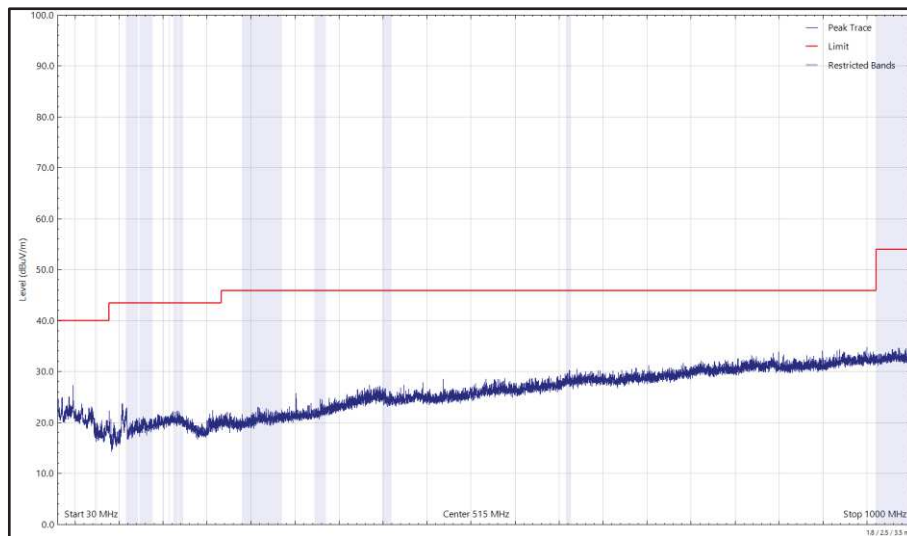

Figure 4 - 2441 MHz (CH39), 2-DH5, ePA, Core 0 + Core 1 and U-NII-1 - 5240 MHz (CH48), VHT20, Core 0 + Core 1, 30 MHz to 1 GHz, Vertical (Peak)

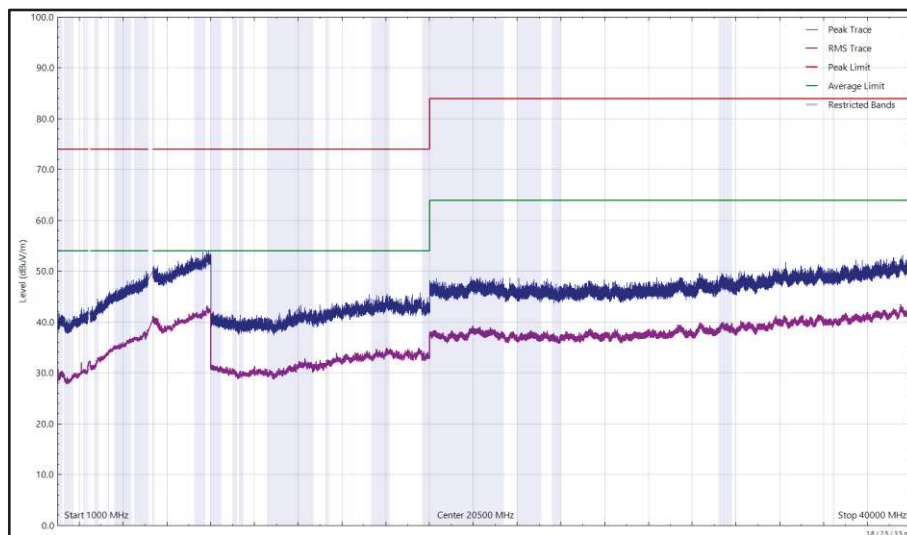

Figure 5 - 2441 MHz (CH39), 2-DH5, ePA, Core 0 + Core 1 and U-NII-1 - 5240 MHz (CH48), VHT20, Core 0 + Core 1, 1 GHz to 40 GHz, Vertical



Frequency (MHz)	Level (dBuV/m)	Limit (dBuV/m)	Margin (dB)	Detector	Angle (°)	Height (cm)	Polarisation
4881.668	40.79	54.00	-13.21	CISPR Avg	24	280	Horizontal

Table 6 - 2441 MHz (CH39), 2-DH5, ePA, Core 0 + Core 1 and U-NII-2C - 5640 MHz (CH128), VHT20, Core 0 + Core 1, 30 MHz to 40 GHz

No other emissions found within 10 dB of the limit.

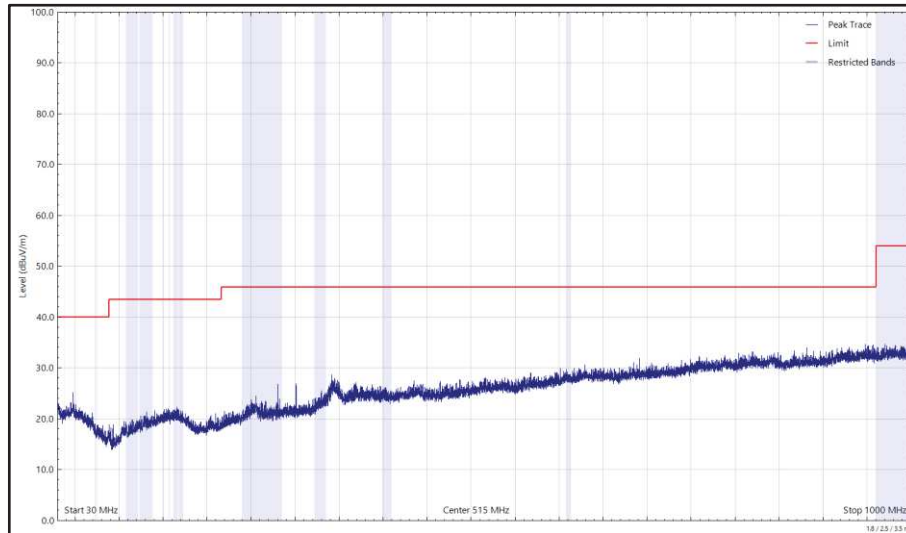

Figure 6 - 2441 MHz (CH39), 2-DH5, ePA, Core 0 + Core 1 and U-NII-2C - 5640 MHz (CH128), VHT20, Core 0 + Core 1, 30 MHz to 1 GHz, Horizontal (Peak)

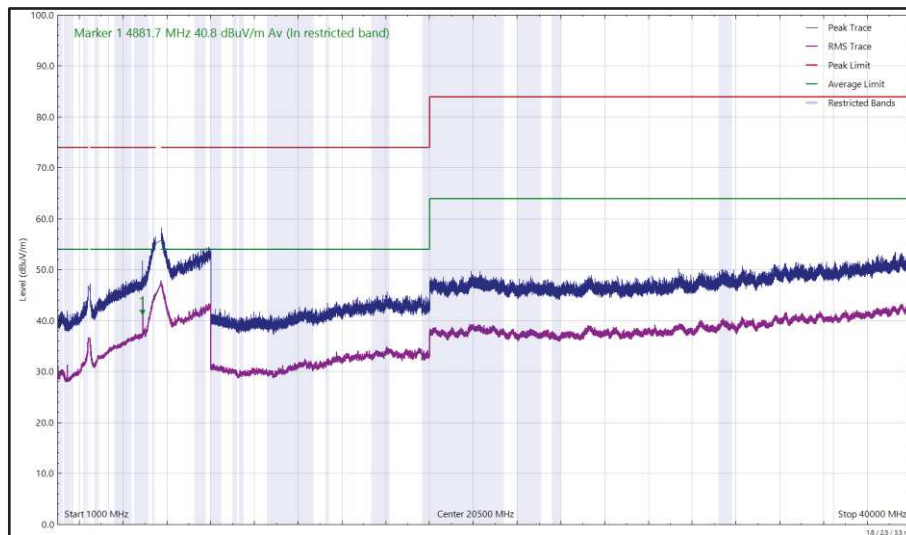

Figure 7 - 2441 MHz (CH39), 2-DH5, ePA, Core 0 + Core 1 and U-NII-2C - 5640 MHz (CH128), VHT20, Core 0 + Core 1, 1 GHz to 40 GHz, Horizontal

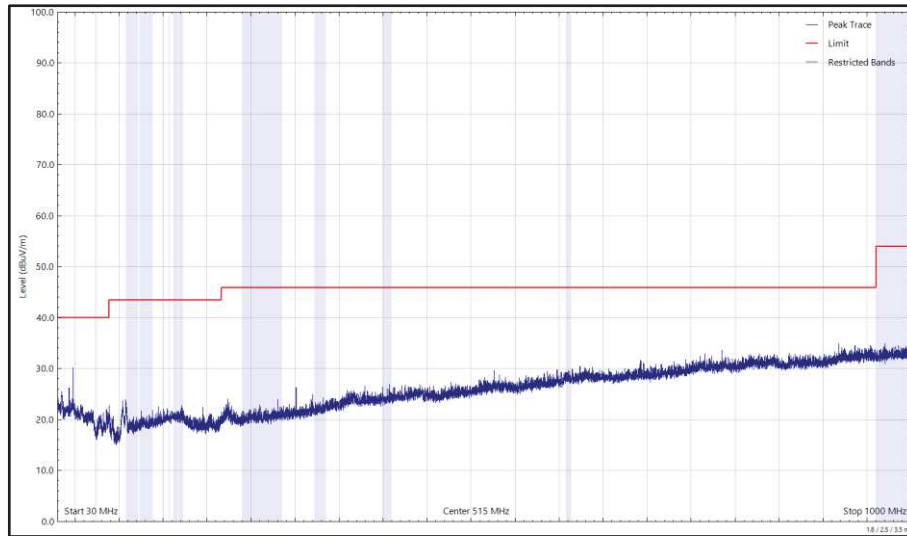

Figure 8 - 2441 MHz (CH39), 2-DH5, ePA, Core 0 + Core 1 and U-NII-2C - 5640 MHz (CH128), VHT20, Core 0 + Core 1, 30 MHz to 1 GHz, Vertical (Peak)

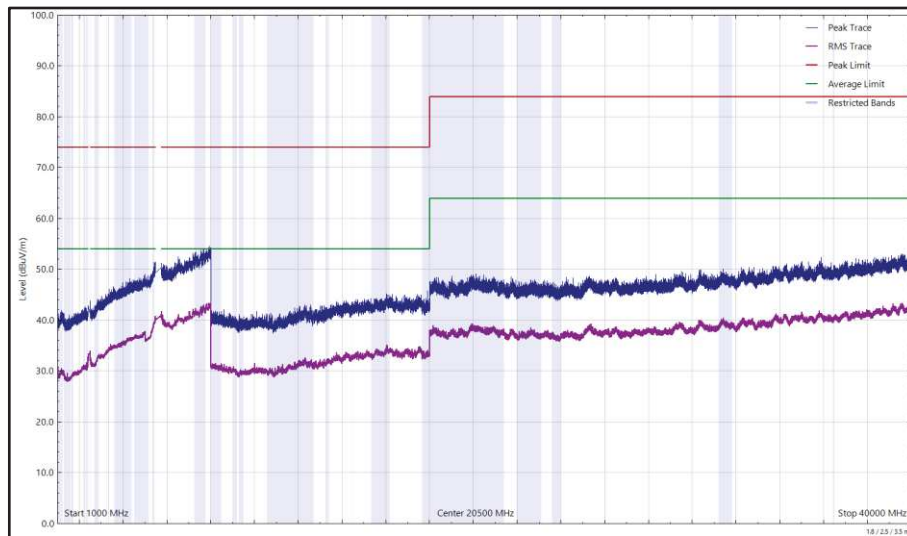

Figure 9 - 2441 MHz (CH39), 2-DH5, ePA, Core 0 + Core 1 and U-NII-2C - 5640 MHz (CH128), VHT20, Core 0 + Core 1, 1 GHz to 40 GHz, Vertical



Frequency (MHz)	Level (dBuV/m)	Limit (dBuV/m)	Margin (dB)	Detector	Angle (°)	Height (cm)	Polarisation
4881.763	41.61	54.00	-12.39	CISPR Avg	26	272	Horizontal

Table 7 - 2441 MHz (CH39), 2-DH5, ePA, Core 0 + Core 1 and U-NII-3 - 5785 MHz (CH157), VHT20, Core 0 + Core 1, 30 MHz to 40 GHz

No other emissions found within 10 dB of the limit.

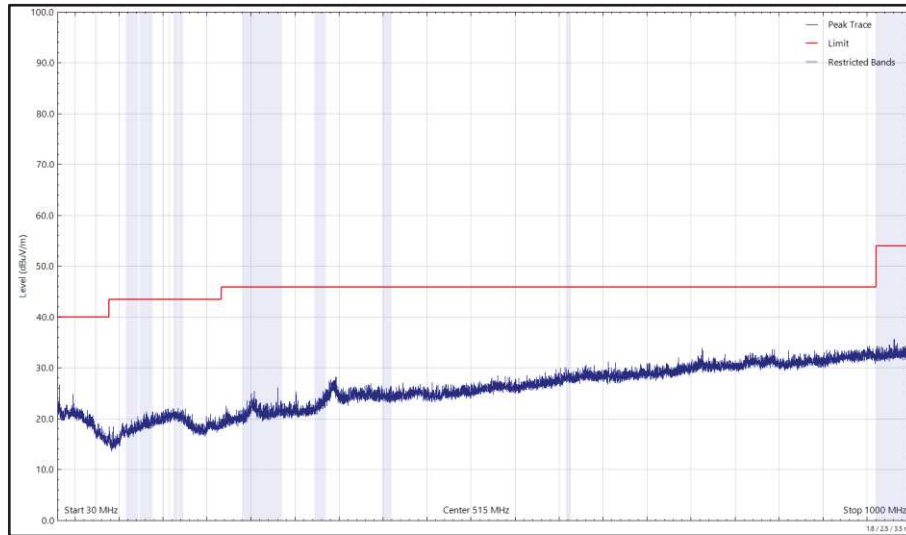

Figure 10 - 2441 MHz (CH39), 2-DH5, ePA, Core 0 + Core 1 and U-NII-3 - 5785 MHz (CH157), VHT20, Core 0 + Core 1, 30 MHz to 1 GHz, Horizontal (Peak)

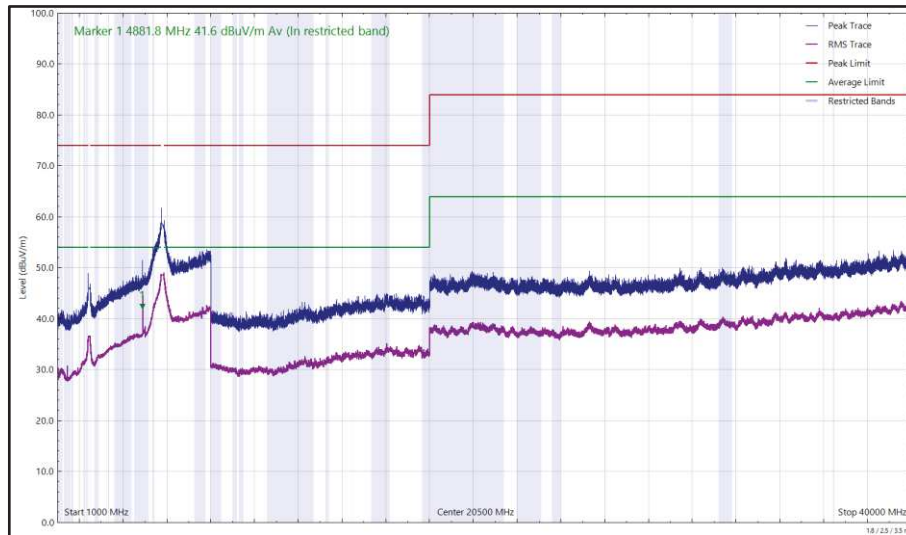

Figure 11 - 2441 MHz (CH39), 2-DH5, ePA, Core 0 + Core 1 and U-NII-3 - 5785 MHz (CH157), VHT20, Core 0 + Core 1, 1 GHz to 40 GHz, Horizontal

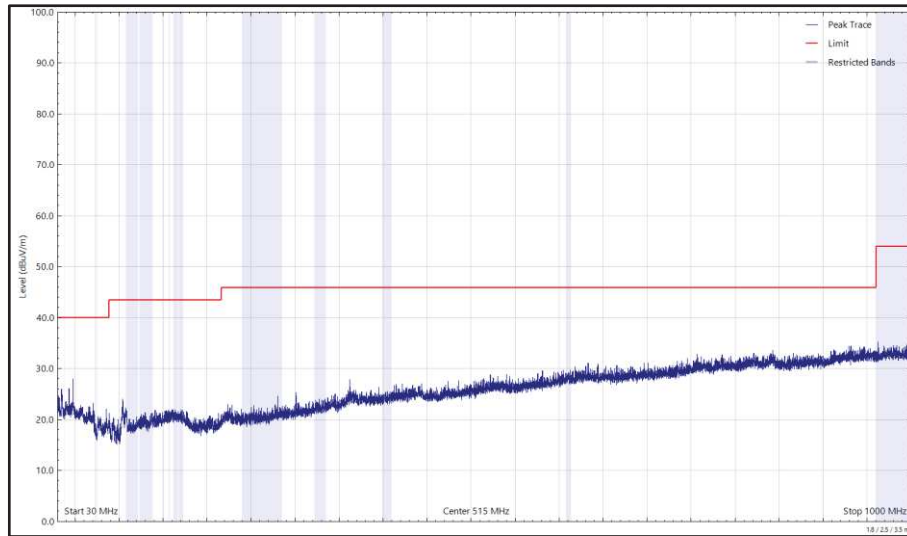

Figure 12 - 2441 MHz (CH39), 2-DH5, ePA, Core 0 + Core 1 and U-NII-3 - 5785 MHz (CH157), VHT20, Core 0 + Core 1, 30 MHz to 1 GHz, Vertical (Peak)

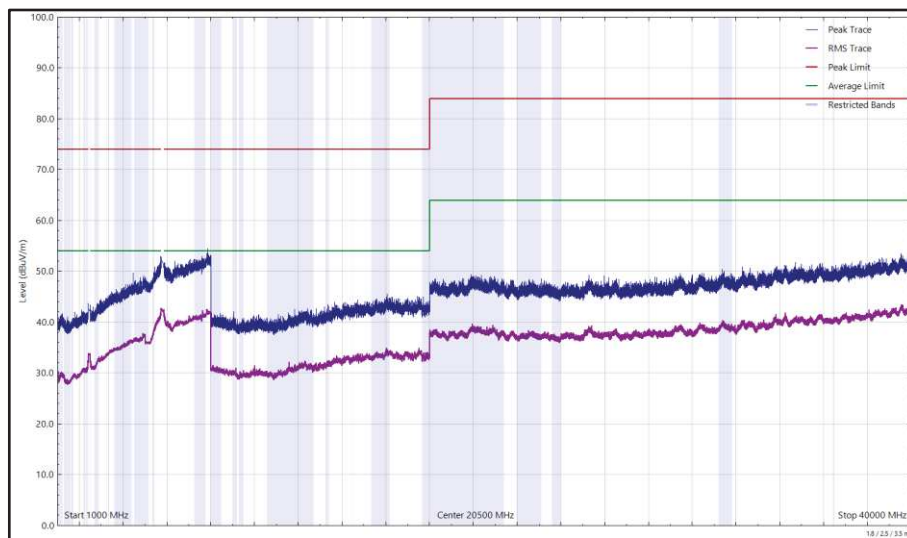

Figure 13 - 2441 MHz (CH39), 2-DH5, ePA, Core 0 + Core 1 and U-NII-3 - 5785 MHz (CH157), VHT20, Core 0 + Core 1, 1 GHz to 40 GHz, Vertical



FCC 47 CFR Part 15, ISED RSS-247 and ISED RSS-GEN

The least stringent limit from the applicable rule parts was used to determine compliance for Radiated Emissions testing of multiple transmission sources.

The least stringent applicable limit was:

Clause	Limit
Part 15 247 (d) / RSS-247 Clause 5.5	-20 dBc
Part 15.407 (b) / RSS-247 Clause 6.2	-27 dBm e.i.r.p
Part 15.209 / RSS-GEN Clause 8.9	Peak: 74 dB μ V/m at 3m, Average 54 dB μ V/m at 3m (Restricted bands > 1 GHz)

Table 8



CoTx - 2.4 GHz Bluetooth and 6 GHz WLAN

Frequency (MHz)	Level (dBuV/m)	Limit (dBuV/m)	Margin (dB)	Detector	Angle (°)	Height (cm)	Polarisation
4881.688	37.81	54.00	-16.19	CISPR Avg	351	307	Horizontal
7322.817	42.64	54.00	-11.36	CISPR Avg	288	357	Vertical
7322.954	41.07	54.00	-12.93	CISPR Avg	294	446	Horizontal

Table 9 - 2441 MHz (CH39), 2-DH5, Core 0 + Core 1, ePA and U-NII-5 - 5955 MHz (CH1), HE20, SU, CDD, Core 0 + Core 1, 30 MHz to 40 GHz

No other emissions found within 10 dB of the limit.

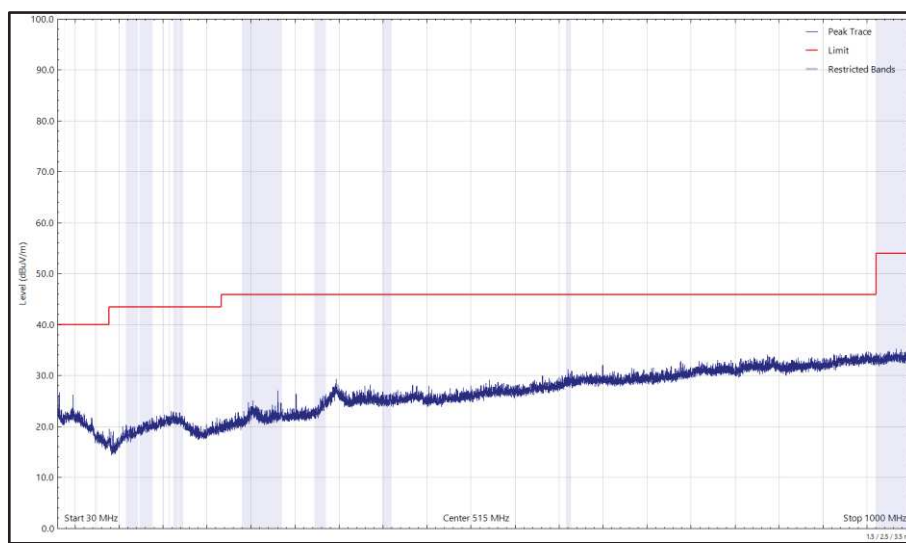

Figure 14 - 2441 MHz (CH39), 2-DH5, Core 0 + Core 1, ePA and U-NII-5 - 5955 MHz (CH1), HE20, SU, CDD, Core 0 + Core 1, 30 MHz to 1 GHz, Horizontal (Peak)

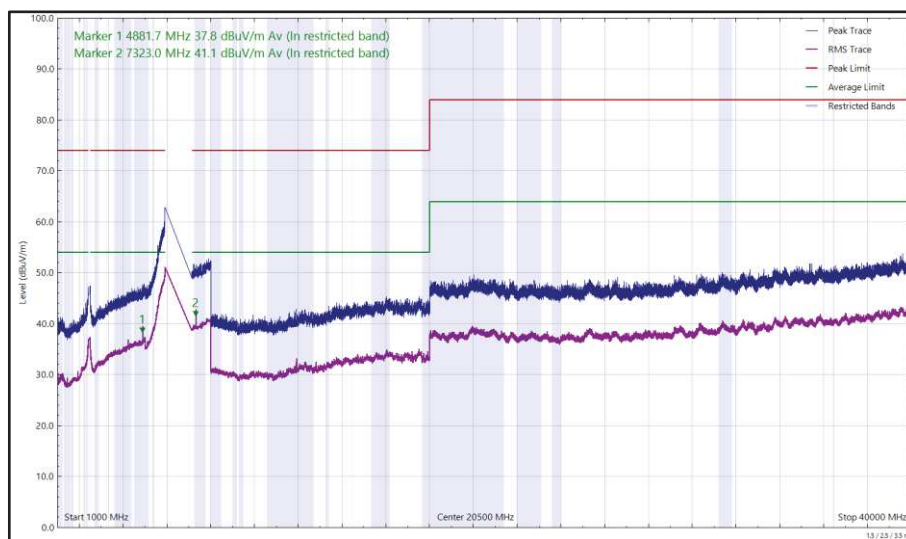

Figure 15 - 2441 MHz (CH39), 2-DH5, Core 0 + Core 1, ePA and U-NII-5 - 5955 MHz (CH1), HE20, SU, CDD, Core 0 + Core 1, 1 GHz to 40 GHz, Horizontal

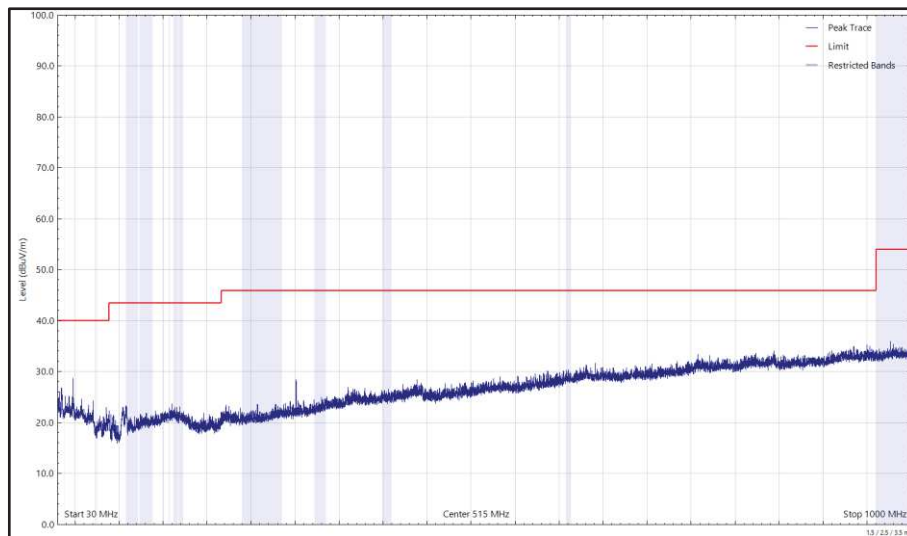

Figure 16 - 2441 MHz (CH39), 2-DH5, Core 0 + Core 1, ePA and U-NII-5 - 5955 MHz (CH1), HE20, SU, CDD, Core 0 + Core 1, 30 MHz to 1 GHz, Vertical (Peak)

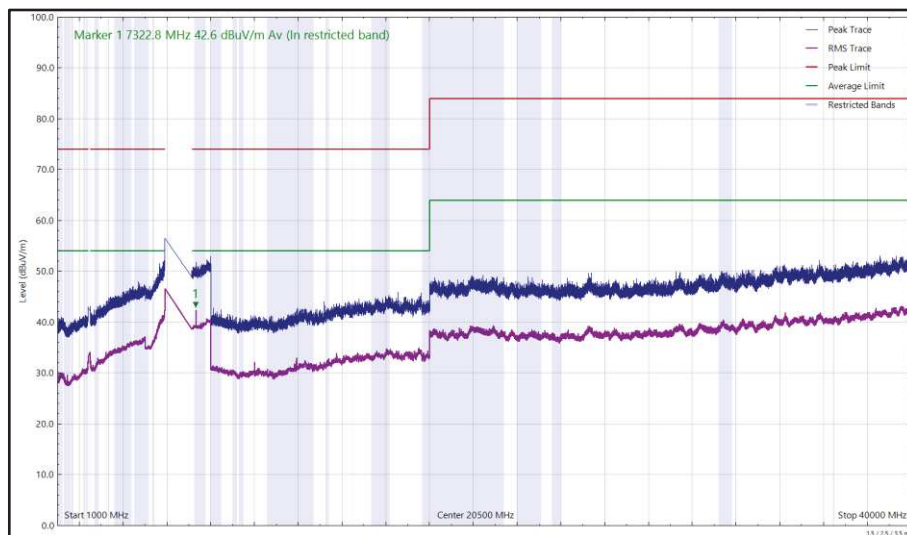

Figure 17 - 2441 MHz (CH39), 2-DH5, Core 0 + Core 1, ePA and U-NII-5 - 5955 MHz (CH1), HE20, SU, CDD, Core 0 + Core 1, 1 GHz to 40 GHz, Vertical



Frequency (MHz)	Level (dBuV/m)	Limit (dBuV/m)	Margin (dB)	Detector	Angle (°)	Height (cm)	Polarisation
2239.138	34.25	54.00	-19.75	RMS	360	362	Horizontal
2241.575	32.93	54.00	-21.07	RMS	355	112	Vertical
4881.695	38.16	54.00	-15.84	CISPR Avg	220	199	Horizontal
5341.860	48.04	68.20	-20.16	RMS	360	295	Horizontal
7322.728	44.72	54.00	-9.28	CISPR Avg	346	300	Horizontal

Table 10 - 2441 MHz (CH39), 2-DH5, Core 0 + Core 1, ePA and U-NII-8 - 7115 MHz (CH233), HE20, SU, CDD, Core 0 + Core 1, 30 MHz to 40 GHz

No other emissions found within 10 dB of the limit.

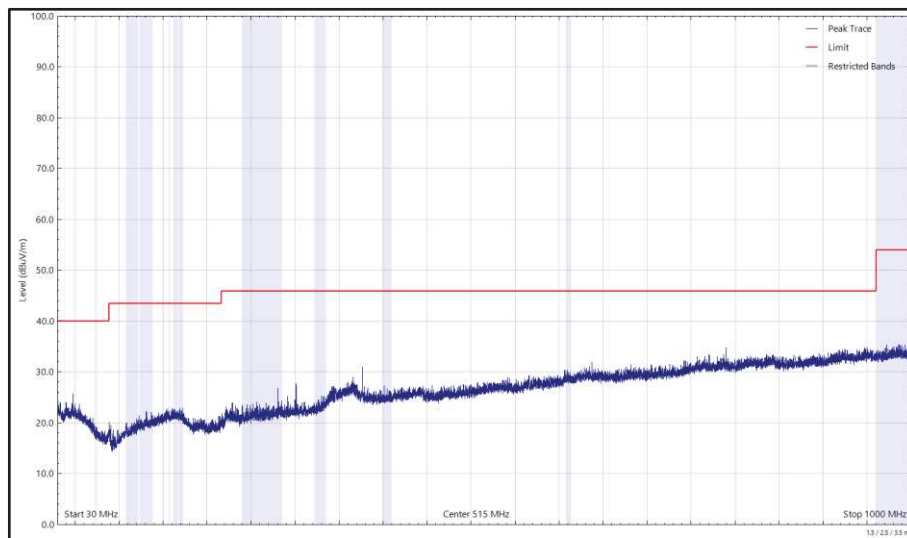

Figure 18 - 2441 MHz (CH39), 2-DH5, Core 0 + Core 1, ePA and U-NII-8 - 7115 MHz (CH233), HE20, SU, CDD, Core 0 + Core 1, 30 MHz to 1 GHz, Horizontal (Peak)

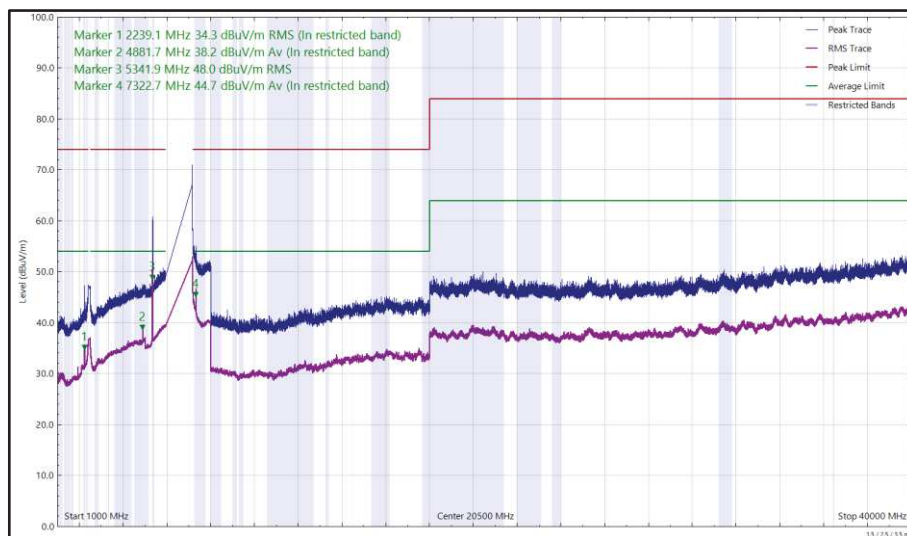

Figure 19 - 2441 MHz (CH39), 2-DH5, Core 0 + Core 1, ePA and U-NII-8 - 7115 MHz (CH233), HE20, SU, CDD, Core 0 + Core 1, 1 GHz to 40 GHz, Horizontal

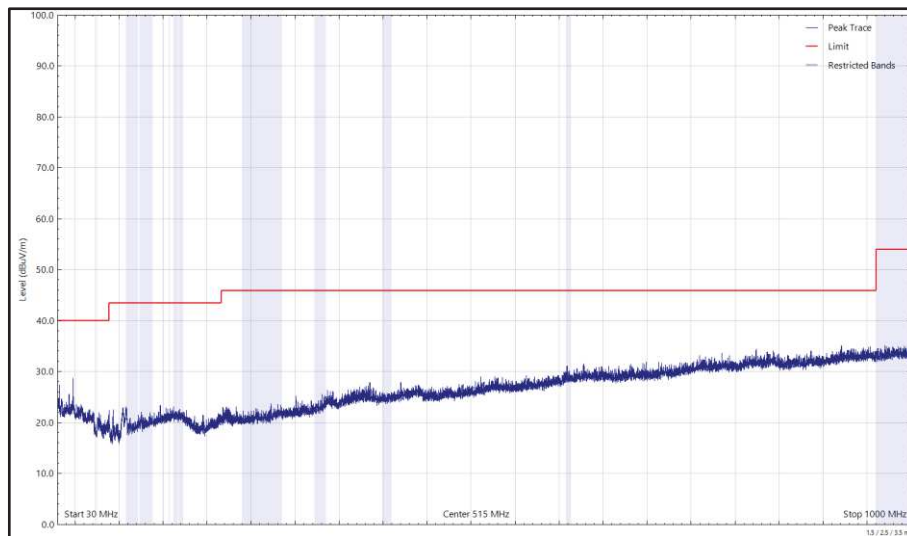

Figure 20 - 2441 MHz (CH39), 2-DH5, Core 0 + Core 1, ePA and U-NII-8 - 7115 MHz (CH233), HE20, SU, CDD, Core 0 + Core 1, 30 MHz to 1 GHz, Vertical (Peak)

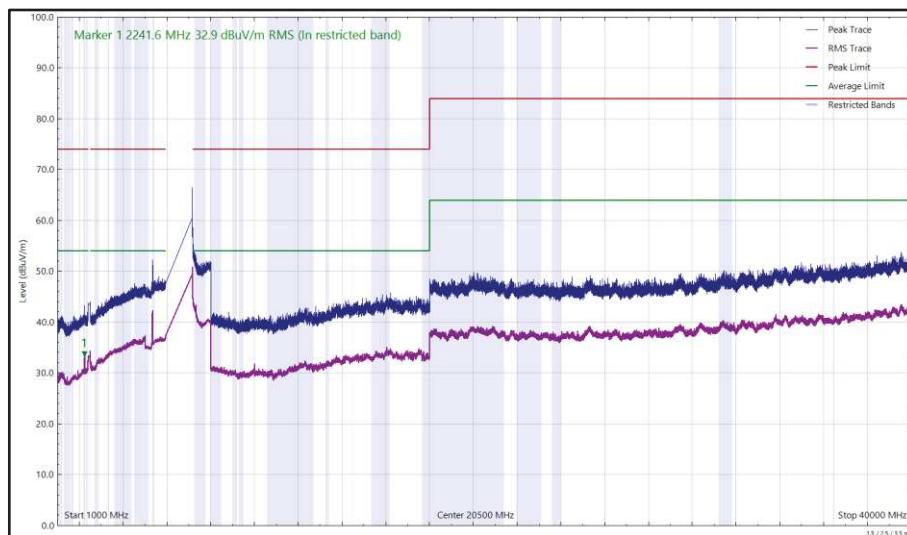

Figure 21 - 2441 MHz (CH39), 2-DH5, Core 0 + Core 1, ePA and U-NII-8 - 7115 MHz (CH233), HE20, SU, CDD, Core 0 + Core 1, 1 GHz to 40 GHz, Vertical



FCC 47 CFR Part 15, ISED RSS-247, ISED RSS-248 and ISED RSS-GEN

The least stringent limit from the applicable rule parts was used to determine compliance for Radiated Emissions testing of multiple transmission sources.

The least stringent applicable limit was:

Clause	Limit
Part 15 247 (d) / RSS-247 Clause 5.5	-20 dBc
Part 15.407 (b) / RSS-248 Clause 4.6.2	Peak: -7 dBm/MHz e.i.r.p, Average: -27 dBm/MHz e.i.r.p
Part 15.209 / RSS-GEN Clause 8.9	Peak: 74 dB μ V/m at 3m, Average 54 dB μ V/m at 3m (Restricted bands > 1 GHz)

Table 11



CoTx - 2.4 GHz WLAN and Narrowband

Frequency (MHz)	Level (dBuV/m)	Limit (dBuV/m)	Margin (dB)	Detector	Angle (°)	Height (cm)	Polarisation
4873.121	40.35	54.00	-13.65	RMS	22	304	Horizontal
4875.645	55.05	74.00	-18.95	Peak	360	280	Horizontal

Table 12 - 2437 MHz (CH6), HT20, Core 0 and 5204 MHz, HDR8, Core 1, ePA, 30 MHz to 40 GHz

No other emissions found within 10 dB of the limit.

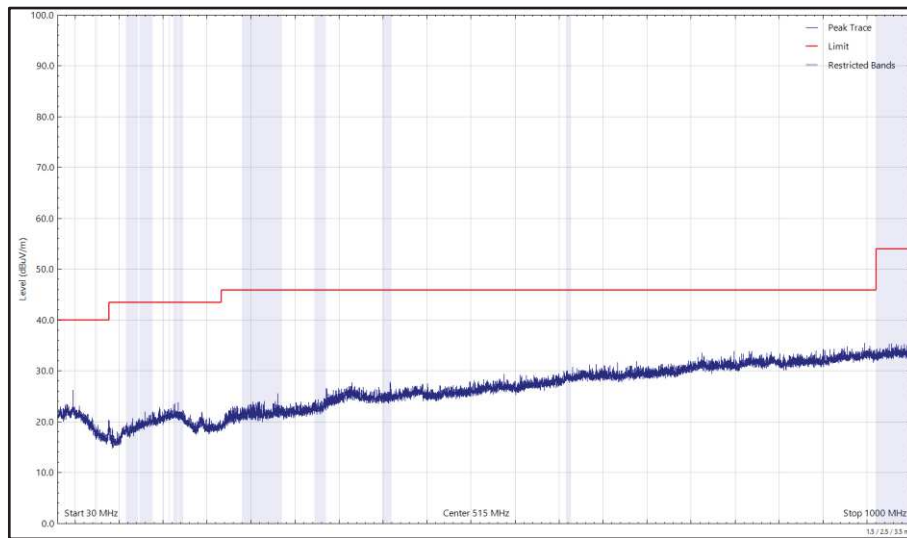

Figure 22 - 2437 MHz (CH6), HT20, Core 0 and 5204 MHz, HDR8, Core 1, ePA, 30 MHz to 1 GHz, Horizontal (Peak)

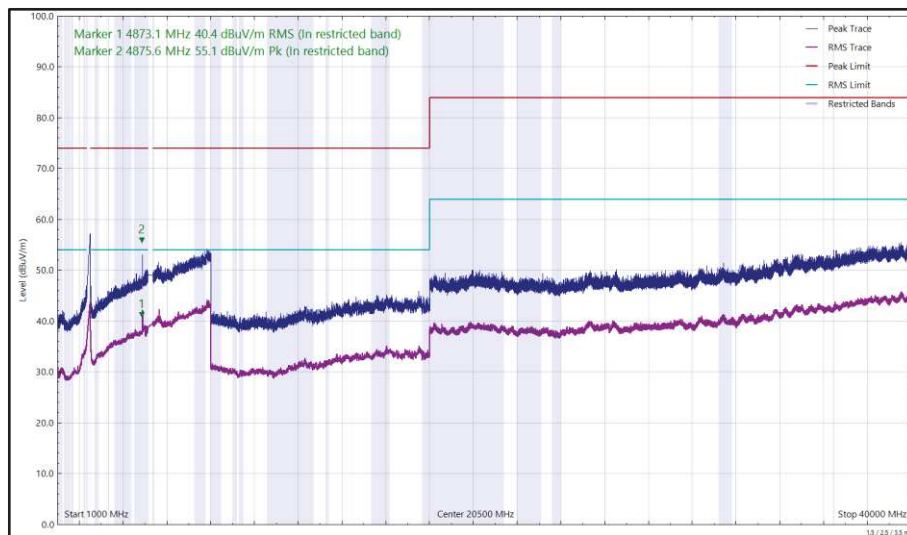

Figure 23 - 2437 MHz (CH6), HT20, Core 0 and 5204 MHz, HDR8, Core 1, ePA, 1 GHz to 40 GHz, Horizontal

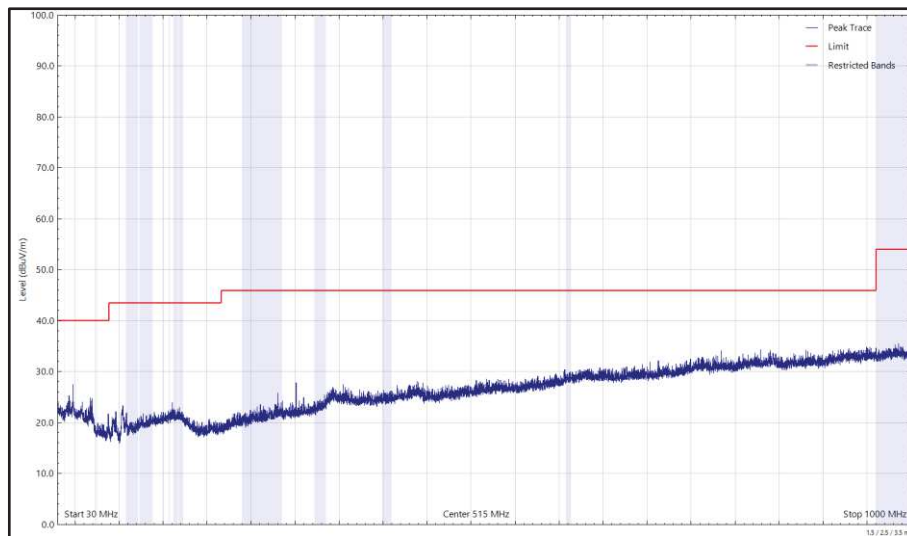

Figure 24 - 2437 MHz (CH6), HT20, Core 0 and 5204 MHz, HDR8, Core 1, ePA, 30 MHz to 1 GHz, Vertical (Peak)

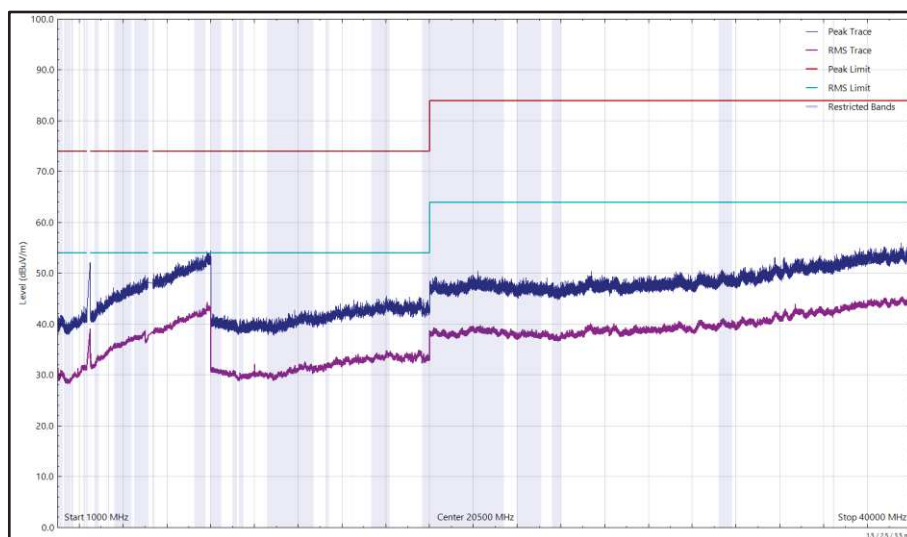

Figure 25 - 2437 MHz (CH6), HT20, Core 0 and 5204 MHz, HDR8, Core 1, ePA, 1 GHz to 40 GHz, Vertical



Frequency (MHz)	Level (dBuV/m)	Limit (dBuV/m)	Margin (dB)	Detector	Angle (°)	Height (cm)	Polarisation
5374.547	40.51	54.00	-13.49	RMS	31	121	Horizontal
11567.861	33.27	54.00	-20.73	RMS	0	183	Horizontal
11575.950	35.06	54.00	-18.94	RMS	290	151	Vertical

Table 13 - 2437 MHz (CH6), HT20, Core 0 and 5788 MHz, HDR4, Core 1, ePA, 30 MHz to 40 GHz

No other emissions found within 10 dB of the limit.

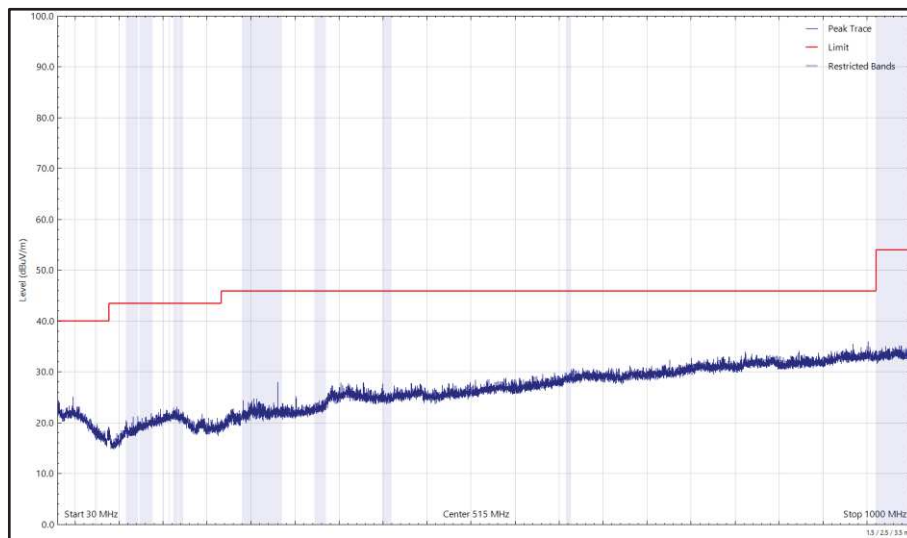

Figure 26 - 2437 MHz (CH6), HT20, Core 0 and 5788 MHz, HDR4, Core 1, ePA, 30 MHz to 1 GHz, Horizontal (Peak)

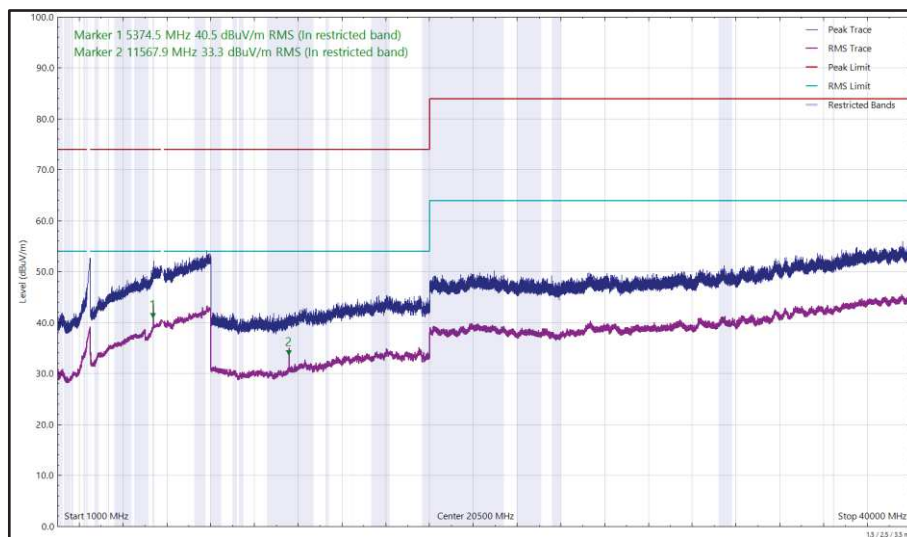

Figure 27 - 2437 MHz (CH6), HT20, Core 0 and 5788 MHz, HDR4, Core 1, ePA, 1 GHz to 40 GHz, Horizontal

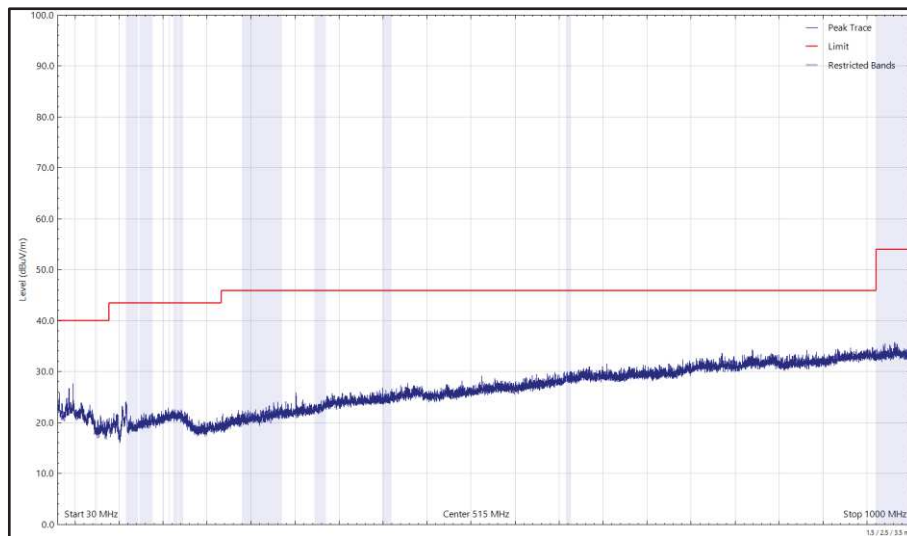

Figure 28 - 2437 MHz (CH6), HT20, Core 0 and 5788 MHz, HDR4, Core 1, ePA, 30 MHz to 1 GHz, Vertical (Peak)

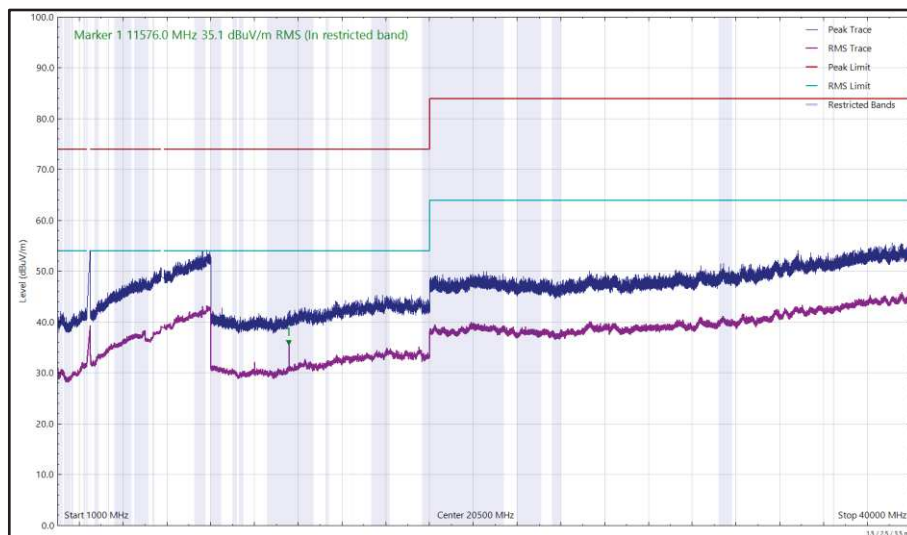

Figure 29 - 2437 MHz (CH6), HT20, Core 0 and 5788 MHz, HDR4, Core 1, ePA, 1 GHz to 40 GHz, Vertical



Frequency (MHz)	Level (dBuV/m)	Limit (dBuV/m)	Margin (dB)	Detector	Angle (°)	Height (cm)	Polarisation
4870.527	61.05	74.00	-12.95	Peak	33	100	Horizontal
4873.270	47.52	54.00	-6.48	RMS	0	287	Horizontal
4877.505	53.76	74.00	-20.24	Peak	46	387	Vertical
4890.787	42.62	54.00	-11.38	RMS	154	378	Vertical

Table 14 - 2437 MHz (CH6), HT20, Core 1 and 5204 MHz, HDR8, Core 0, ePA, 30 MHz to 40 GHz

No other emissions found within 10 dB of the limit.

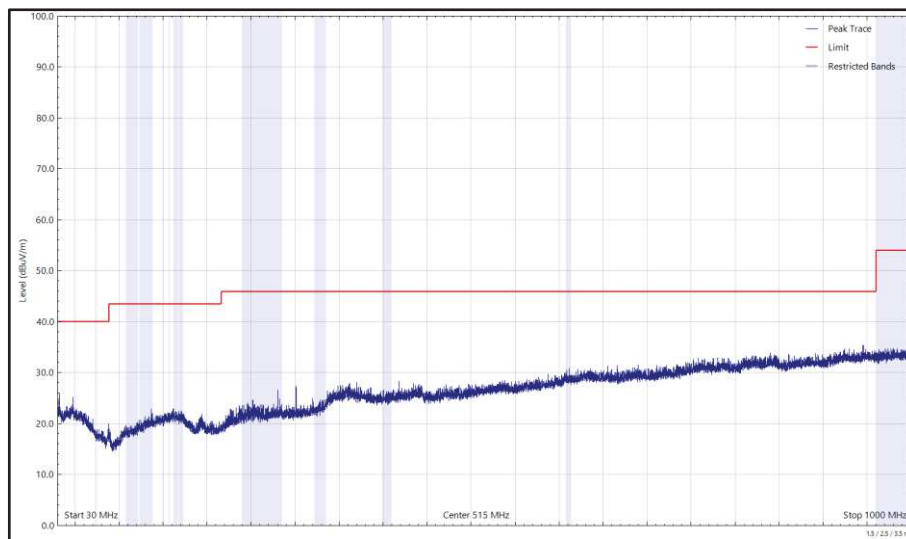

Figure 30 - 2437 MHz (CH6), HT20, Core 1 and 5204 MHz, HDR8, Core 0, ePA, 30 MHz to 1 GHz, Horizontal (Peak)

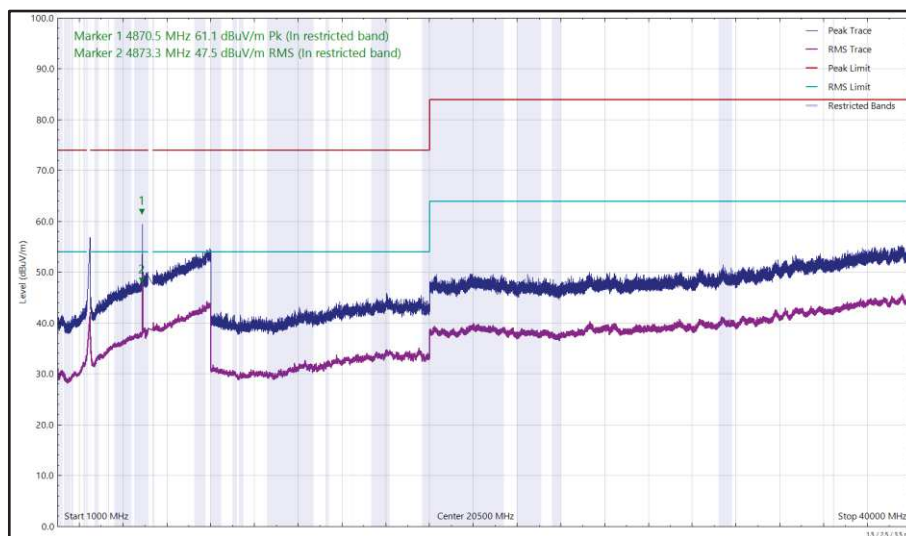

Figure 31 - 2437 MHz (CH6), HT20, Core 1 and 5204 MHz, HDR8, Core 0, ePA, 1 GHz to 40 GHz, Horizontal

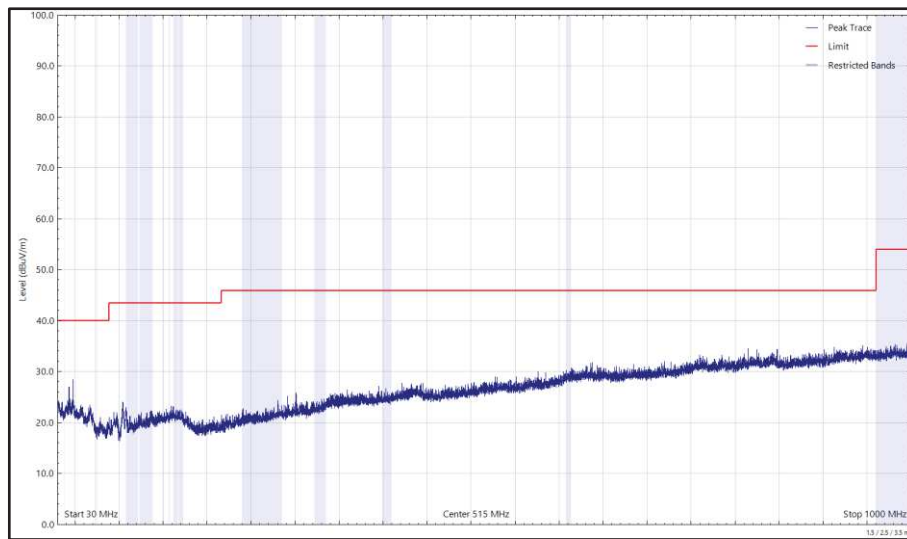

Figure 32 - 2437 MHz (CH6), HT20, Core 1 and 5204 MHz, HDR8, Core 0, ePA, 30 MHz to 1 GHz, Vertical (Peak)

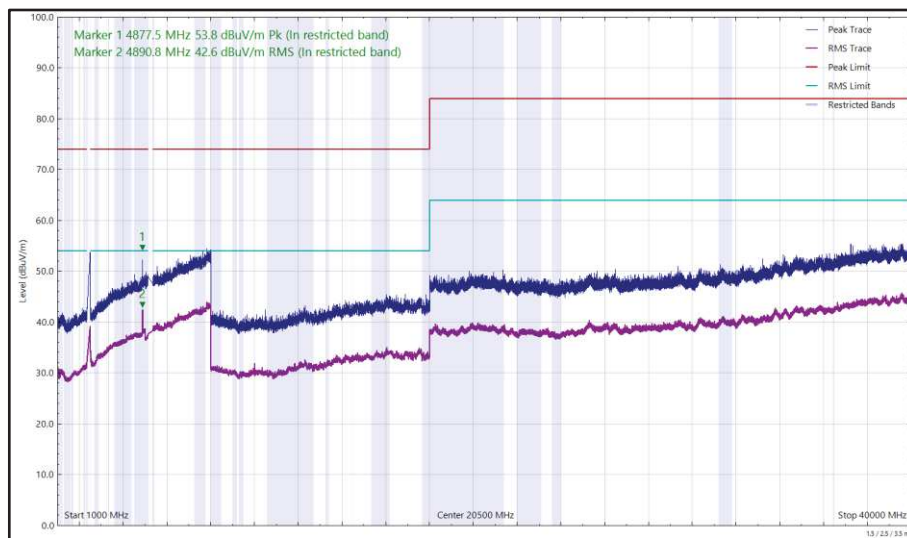

Figure 33 - 2437 MHz (CH6), HT20, Core 1 and 5204 MHz, HDR8, Core 0, ePA, 1 GHz to 40 GHz, Vertical



Frequency (MHz)	Level (dBuV/m)	Limit (dBuV/m)	Margin (dB)	Detector	Angle (°)	Height (cm)	Polarisation
4874.275	55.69	74.00	-18.31	Peak	33	103	Vertical
4875.070	43.62	54.00	-10.38	RMS	35	100	Vertical
5374.507	42.70	54.00	-11.30	RMS	343	313	Vertical

Table 15 - 2437 MHz (CH6), HT20, Core 1 and 5788 MHz, HDR4, Core 0, ePA, 30 MHz to 40 GHz

No other emissions found within 10 dB of the limit.

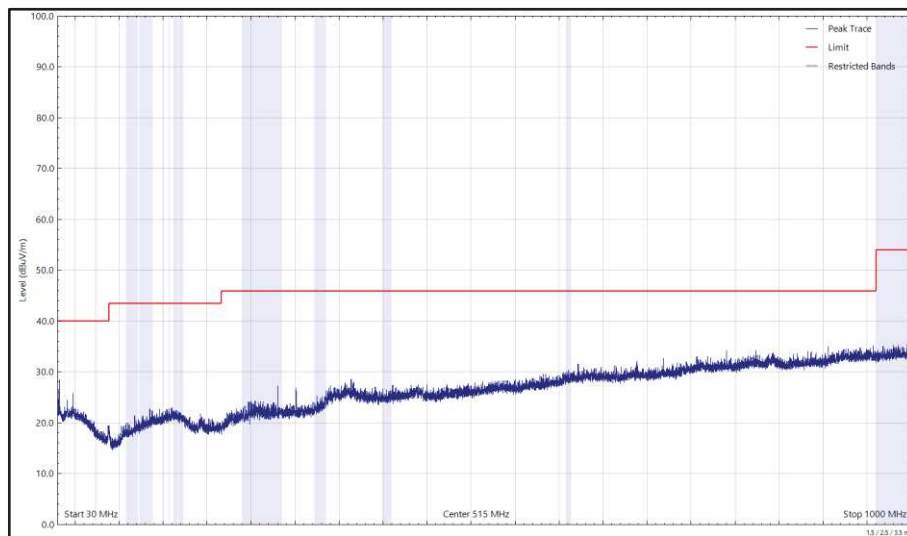

Figure 34 - 2437 MHz (CH6), HT20, Core 1 and 5788 MHz, HDR4, Core 0, ePA, 30 MHz to 1 GHz, Horizontal (Peak)

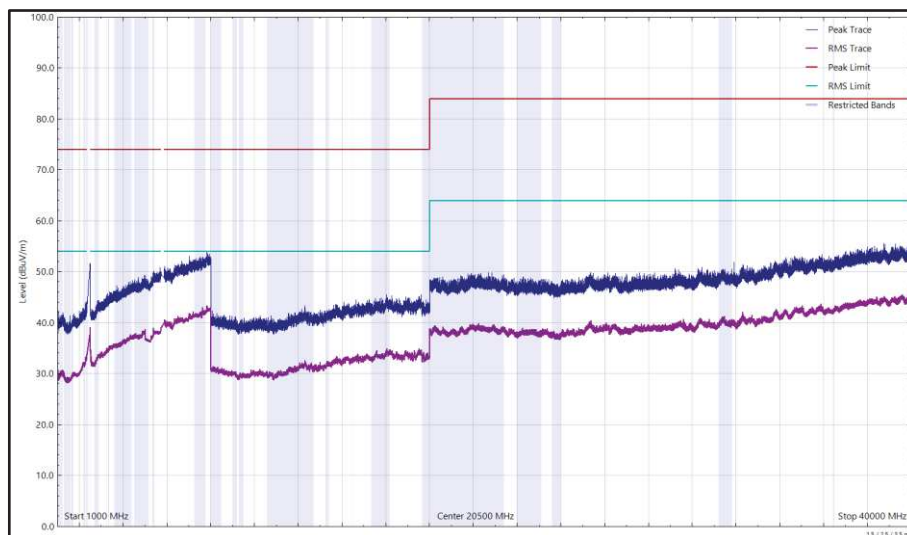

Figure 35 - 2437 MHz (CH6), HT20, Core 1 and 5788 MHz, HDR4, Core 0, ePA, 1 GHz to 40 GHz, Horizontal

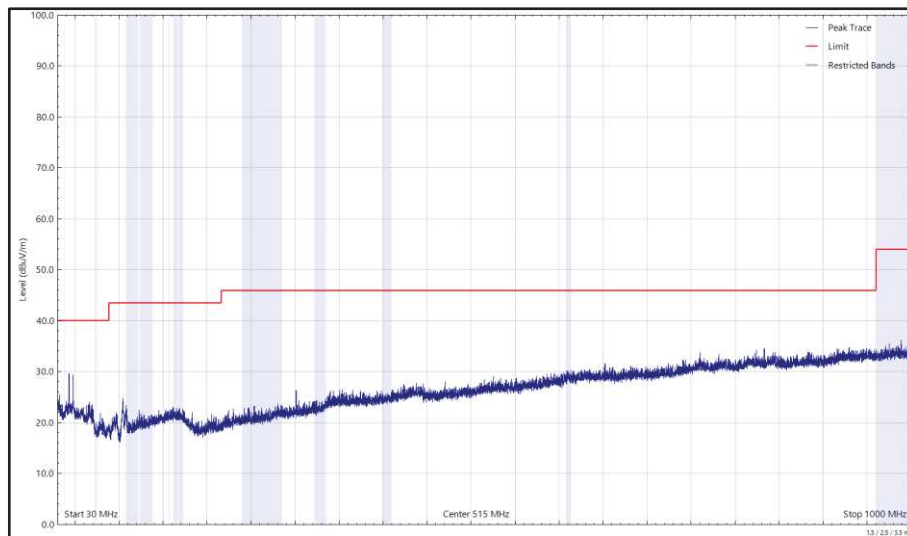

Figure 36 - 2437 MHz (CH6), HT20, Core 1 and 5788 MHz, HDR4, Core 0, ePA, 30 MHz to 1 GHz, Vertical (Peak)

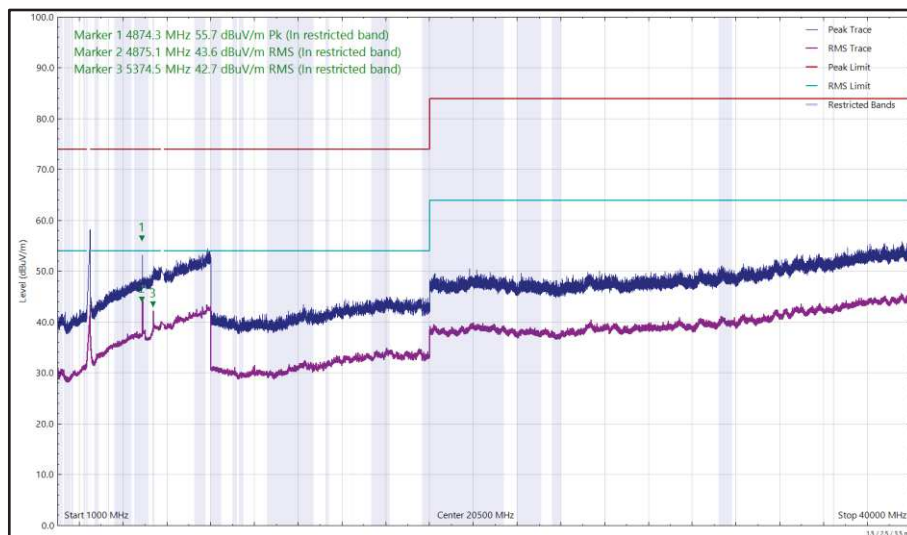

Figure 37 - 2437 MHz (CH6), HT20, Core 1 and 5788 MHz, HDR4, Core 0, ePA, 1 GHz to 40 GHz, Vertical



FCC 47 CFR Part 15, ISED RSS-247 and ISED RSS-GEN

The least stringent limit from the applicable rule parts was used to determine compliance for Radiated Emissions testing of multiple transmission sources.

The least stringent applicable limit was:

Clause	Limit
Part 15.247 (d) / RSS-247 Clause 5.5	-30 dBc
Part 15.407 (b) / RSS-247 Clause 6.2	-27 dBm e.i.r.p
Part 15.209 / RSS-GEN Clause 8.9	Peak: 74 dB μ V/m at 3m, Average 54 dB μ V/m at 3m (Restricted bands > 1 GHz)

Table 16



CoTx - Thread and 5 GHz WLAN

Frequency (MHz)	Level (dBuV/m)	Limit (dBuV/m)	Margin (dB)	Detector	Angle (°)	Height (cm)	Polarisation
*							

Table 17 - 2440 MHz (CH18), Thread, ePA, Core 0 and U-NII-3 - 5785 MHz (CH157), VHT20, CDD, Core 0 + Core 1, 30 MHz to 40 GHz

*No emissions found within 10 dB of the limit.

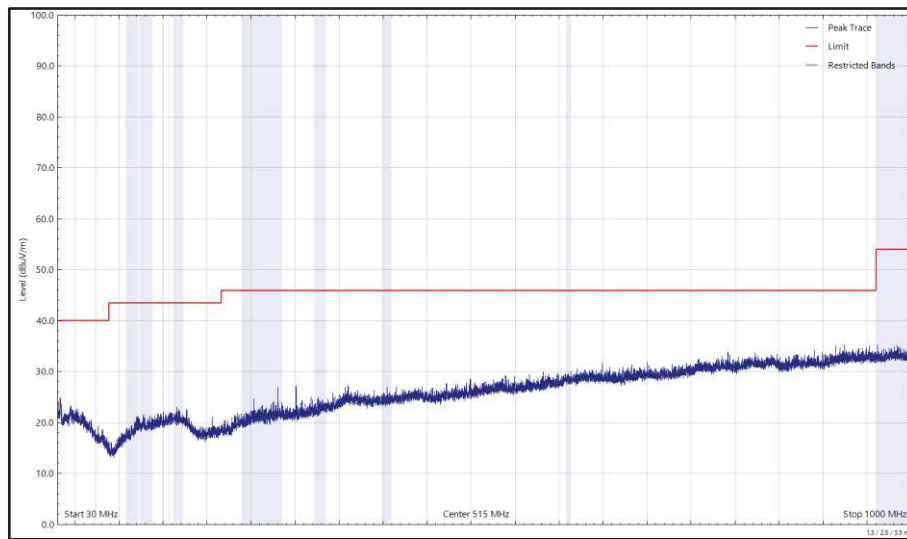

Figure 38 - 2440 MHz (CH18), Thread, ePA, Core 0 and U-NII-3 - 5785 MHz (CH157), VHT20, CDD, Core 0 + Core 1, 30 MHz to 1 GHz, Horizontal (Peak)

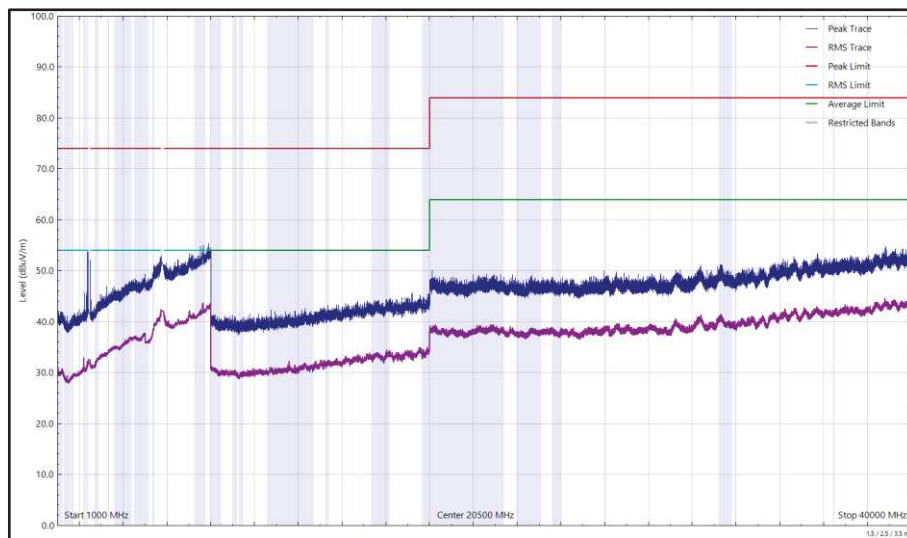

Figure 39 - 2440 MHz (CH18), Thread, ePA, Core 0 and U-NII-3 - 5785 MHz (CH157), VHT20, CDD, Core 0 + Core 1, 1 GHz to 40 GHz, Horizontal

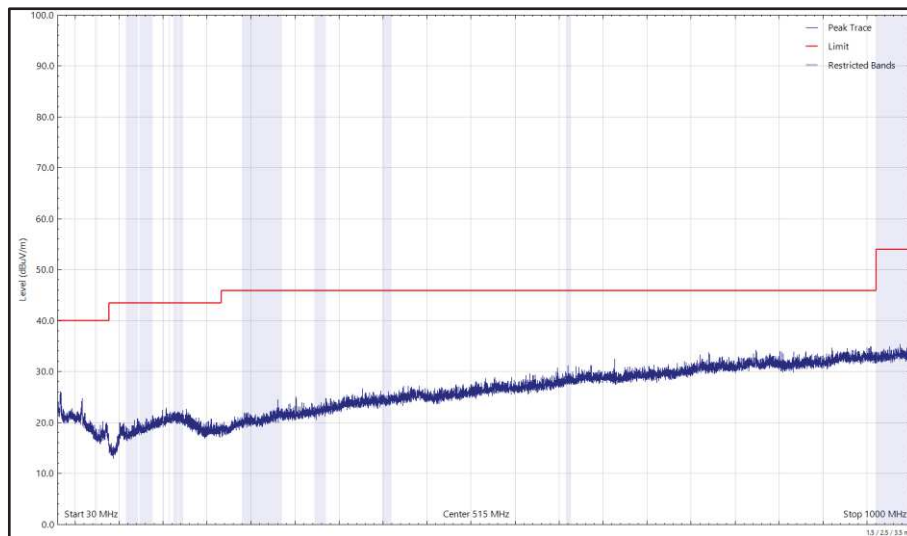

Figure 40 - 2440 MHz (CH18), Thread, ePA, Core 0 and U-NII-3 - 5785 MHz (CH157), VHT20, CDD, Core 0 + Core 1, 30 MHz to 1 GHz, Vertical (Peak)

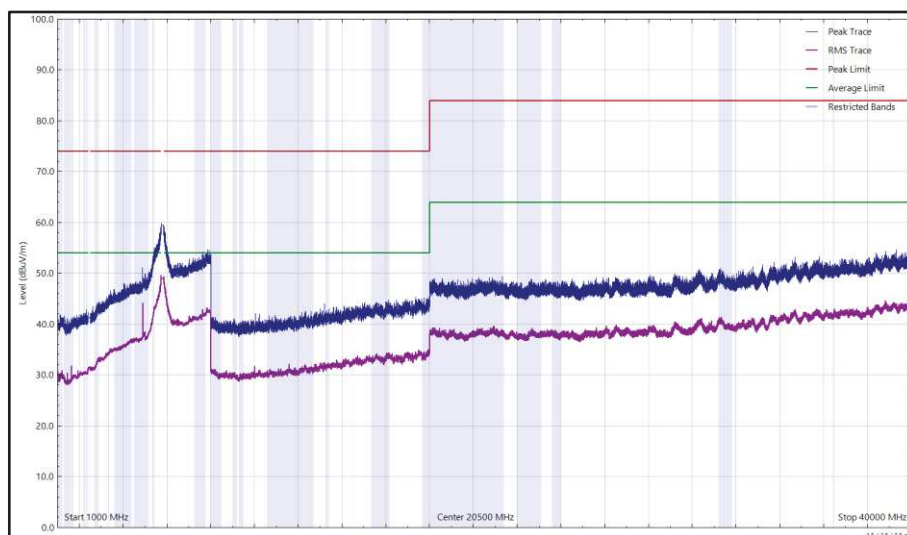

Figure 41 - 2440 MHz (CH18), Thread, ePA, Core 0 and U-NII-3 - 5785 MHz (CH157), VHT20, CDD, Core 0 + Core 1, 1 GHz to 40 GHz, Vertical



Frequency (MHz)	Level (dBuV/m)	Limit (dBuV/m)	Margin (dB)	Detector	Angle (°)	Height (cm)	Polarisation
2368.627	65.68	74.00	-8.32	Peak	45	375	Vertical
2377.714	58.10	74.00	-15.90	Peak	323	357	Horizontal
2385.813	65.25	74.00	-8.75	Peak	350	355	Vertical
2387.111	34.94	54.00	-19.06	RMS	350	355	Vertical
4880.920	43.45	54.00	-10.55	RMS	0	291	Vertical

Table 18 - 2440 MHz (CH18), Thread, ePA, Core 1 and U-NII-3 - 5785 MHz (CH157), VHT20, CDD, Core 0 + Core 1, 30 MHz to 40 GHz

No other emissions found within 10 dB of the limit.

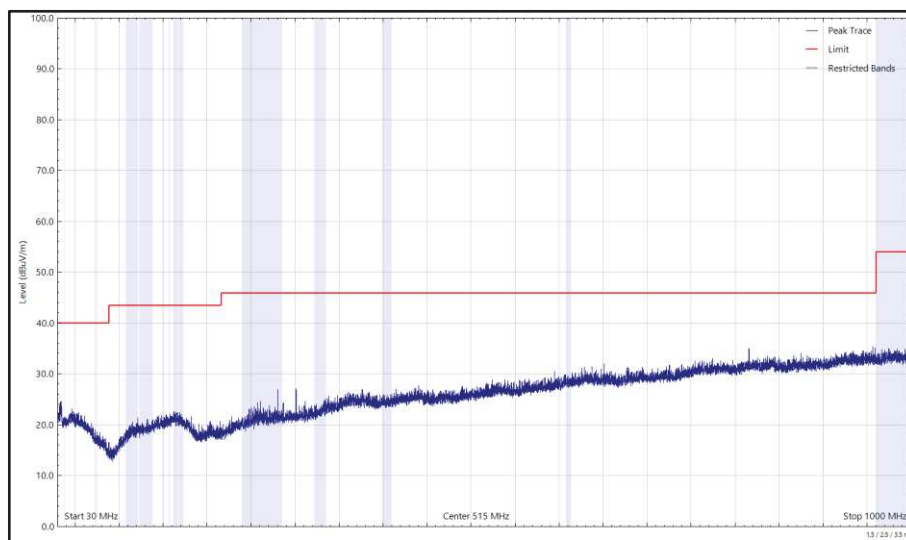

Figure 42 - 2440 MHz (CH18), Thread, ePA, Core 1 and U-NII-3 - 5785 MHz (CH157), VHT20, CDD, Core 0 + Core 1, 30 MHz to 1 GHz, Horizontal (Peak)

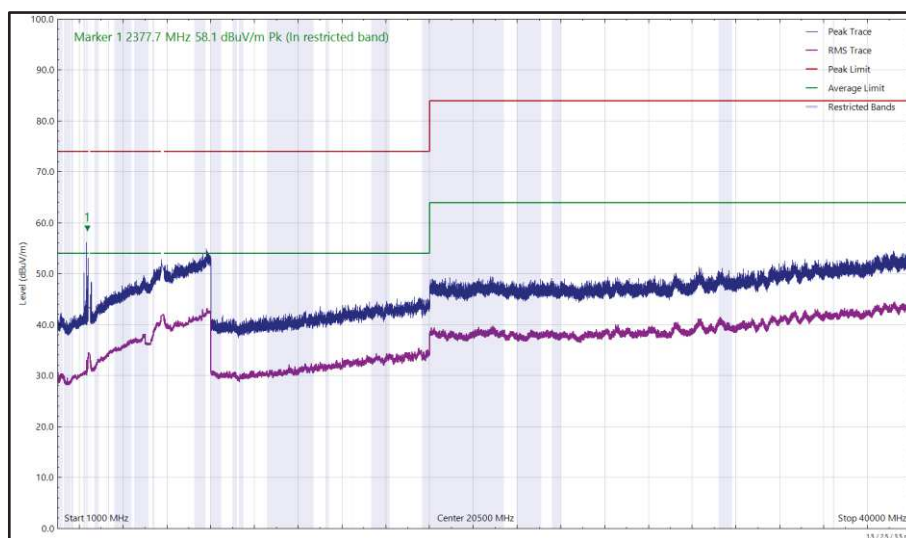

Figure 43 - 2440 MHz (CH18), Thread, ePA, Core 1 and U-NII-3 - 5785 MHz (CH157), VHT20, CDD, Core 0 + Core 1, 1 GHz to 40 GHz, Horizontal

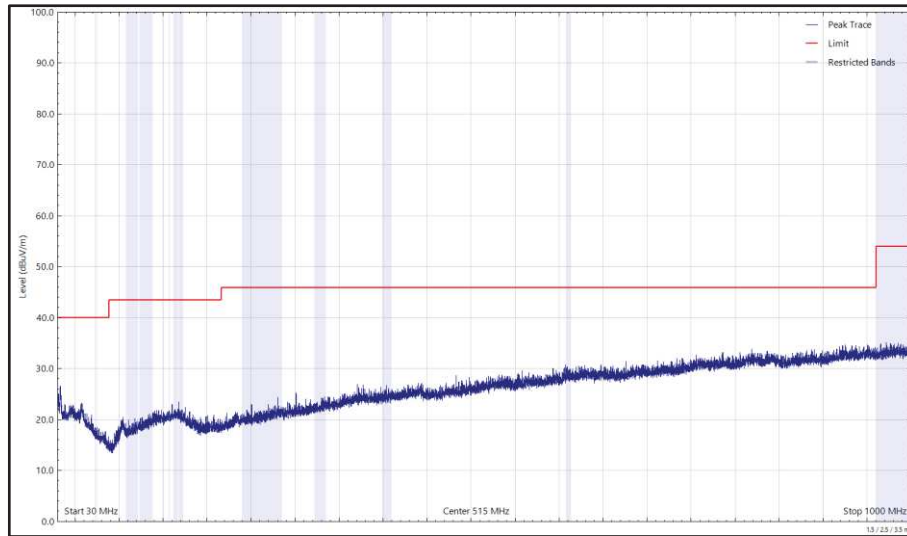

Figure 44 - 2440 MHz (CH18), Thread, ePA, Core 1 and U-NII-3 - 5785 MHz (CH157), VHT20, CDD, Core 0 + Core 1, 30 MHz to 1 GHz, Vertical (Peak)

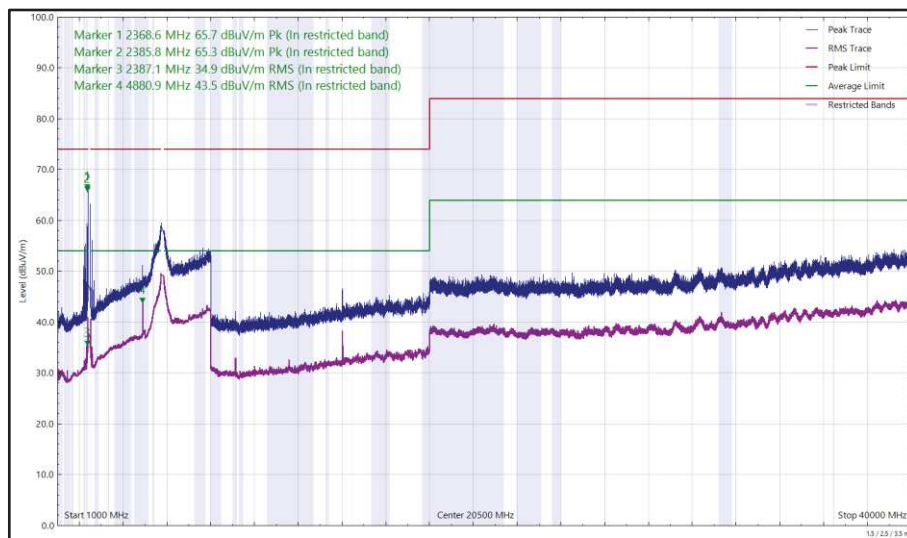

Figure 45 - 2440 MHz (CH18), Thread, ePA, Core 1 and U-NII-3 - 5785 MHz (CH157), VHT20, CDD, Core 0 + Core 1, 1 GHz to 40 GHz, Vertical



Frequency (MHz)	Level (dBuV/m)	Limit (dBuV/m)	Margin (dB)	Detector	Angle (°)	Height (cm)	Polarisation
4879.020	43.57	54.00	-10.43	RMS	355	304	Vertical

Table 19 - 2440 MHz (CH18), Thread, ePA, Core 2 and U-NII-3 - 5785 MHz (CH157), VHT20, CDD, Core 0 + Core 1, 30 MHz to 40 GHz

No other emissions found within 10 dB of the limit.

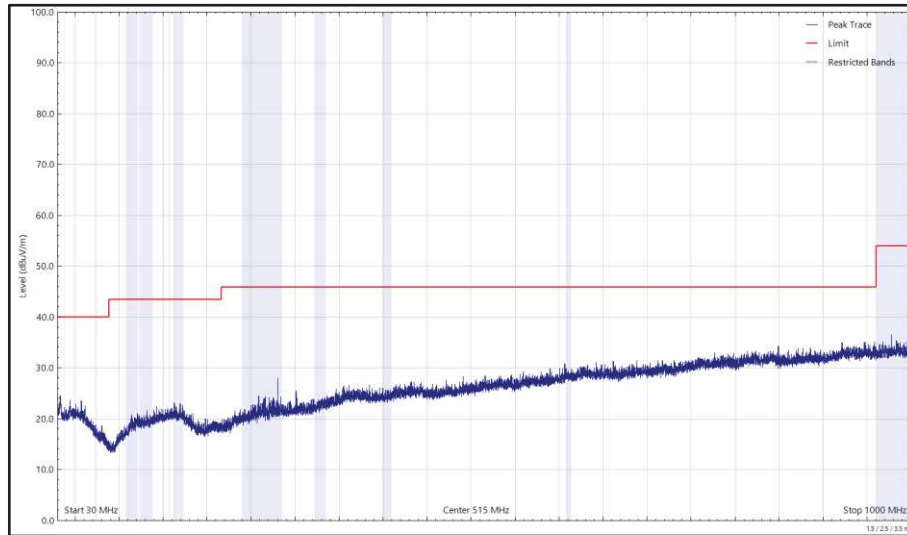

Figure 46 - 2440 MHz (CH18), Thread, ePA, Core 2 and U-NII-3 - 5785 MHz (CH157), VHT20, CDD, Core 0 + Core 1, 30 MHz to 1 GHz, Horizontal (Peak)

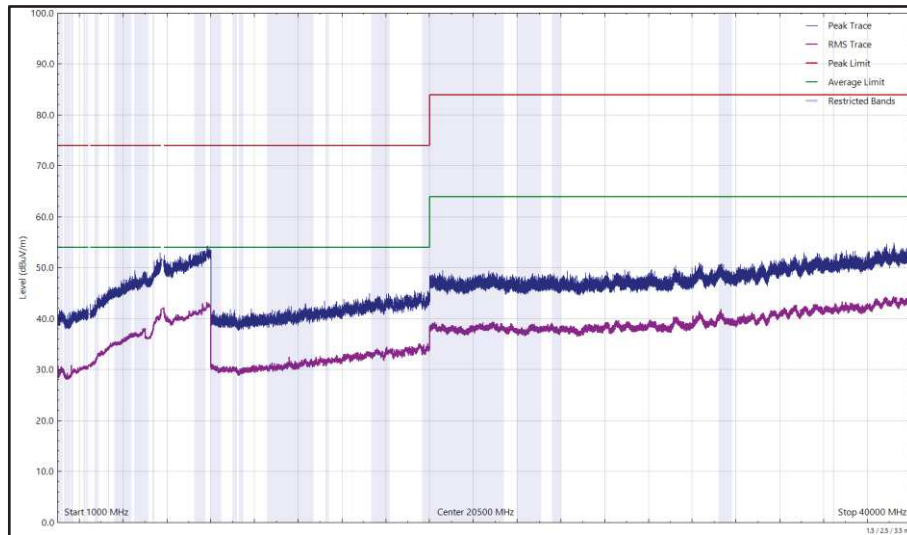

Figure 47 - 2440 MHz (CH18), Thread, ePA, Core 2 and U-NII-3 - 5785 MHz (CH157), VHT20, CDD, Core 0 + Core 1, 1 GHz to 40 GHz, Horizontal

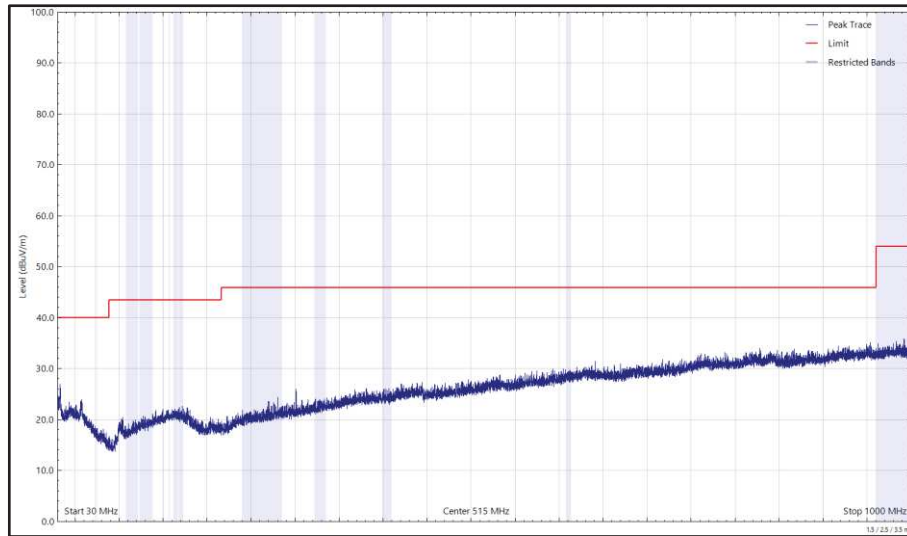

Figure 48 - 2440 MHz (CH18), Thread, ePA, Core 2 and U-NII-3 - 5785 MHz (CH157), VHT20, CDD, Core 0 + Core 1, 30 MHz to 1 GHz, Vertical (Peak)

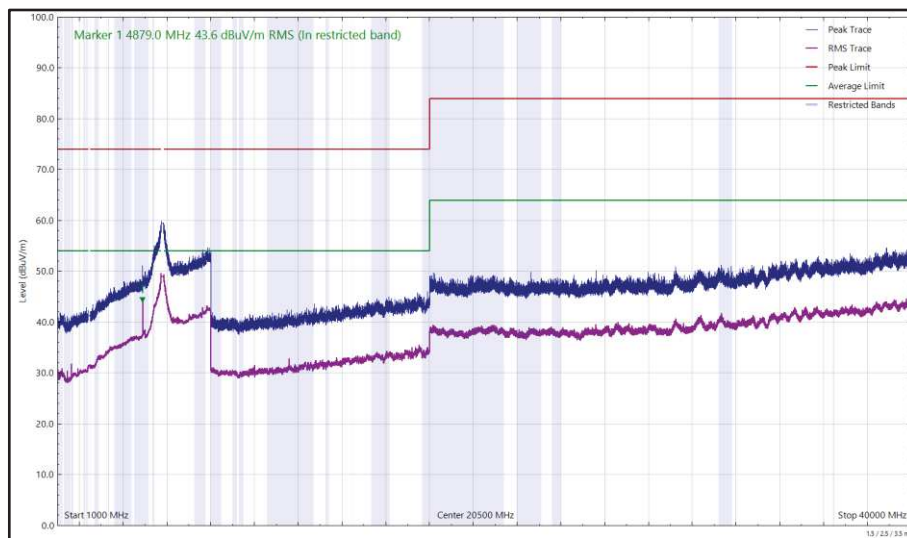

Figure 49 - 2440 MHz (CH18), Thread, ePA, Core 2 and U-NII-3 - 5785 MHz (CH157), VHT20, CDD, Core 0 + Core 1, 1 GHz to 40 GHz, Vertical



Frequency (MHz)	Level (dBuV/m)	Limit (dBuV/m)	Margin (dB)	Detector	Angle (°)	Height (cm)	Polarisation
2228.973	59.18	74.00	-14.82	Peak	4	316	Vertical
2272.179	59.69	74.00	-14.31	Peak	1	348	Vertical
2343.810	64.33	74.00	-9.67	Peak	4	344	Vertical
2347.438	34.16	54.00	-19.84	RMS	4	344	Vertical
2377.438	61.18	74.00	-12.82	Peak	305	440	Horizontal
2379.649	37.38	54.00	-16.62	RMS	0	320	Vertical
4879.028	43.77	54.00	-10.23	RMS	10	319	Vertical

Table 20 - 2440 MHz (CH18), Thread, ePA, Core 0 and U-NII-1 - 5240 MHz (CH48), VHT20, CDD, Core 0 + Core 1, 30 MHz to 40 GHz

No other emissions found within 10 dB of the limit.

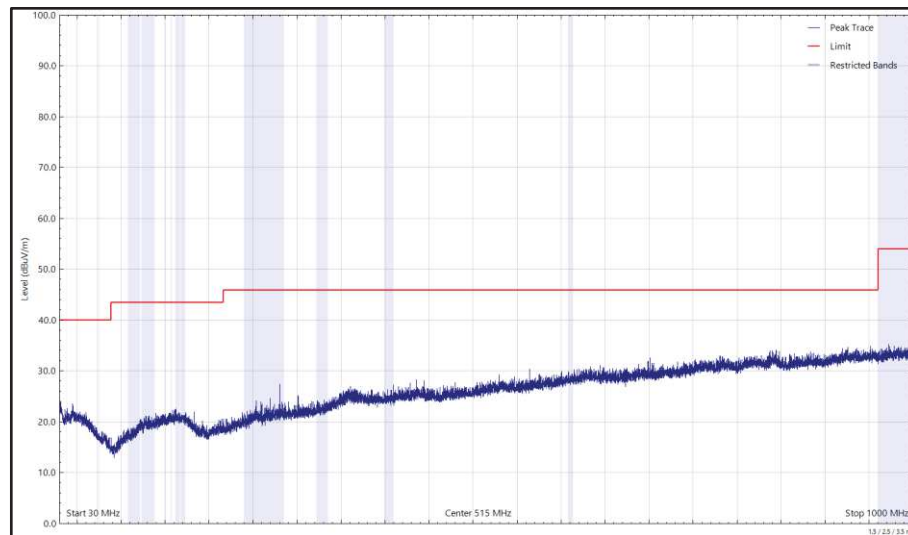

Figure 50 - 2440 MHz (CH18), Thread, ePA, Core 0 and U-NII-1 - 5240 MHz (CH48), VHT20, CDD, Core 0 + Core 1, 30 MHz to 1 GHz, Horizontal (Peak)

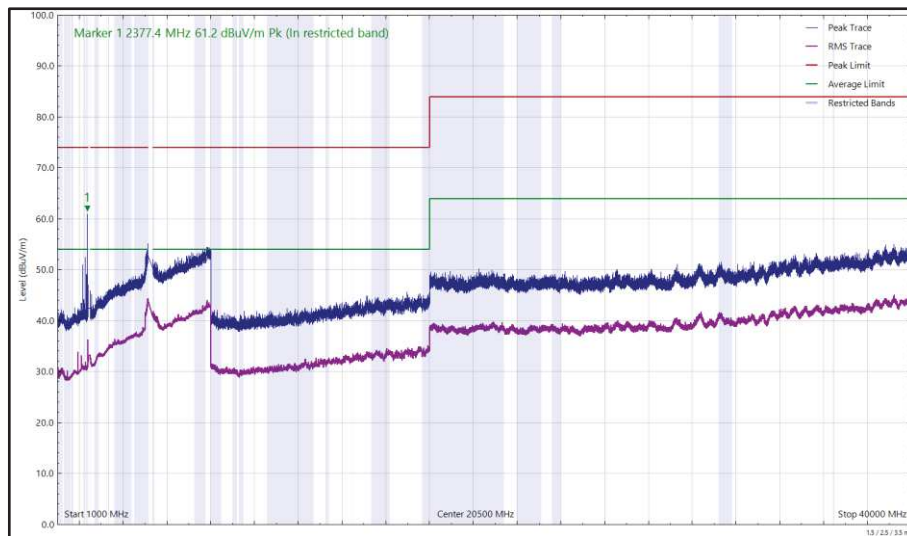

Figure 51 - 2240 MHz (CH18), Thread, ePA, Core 0 and U-NII-1 - 5240 MHz (CH48), VHT20, CDD, Core 0 + Core 1, 1 GHz to 40 GHz, Horizontal

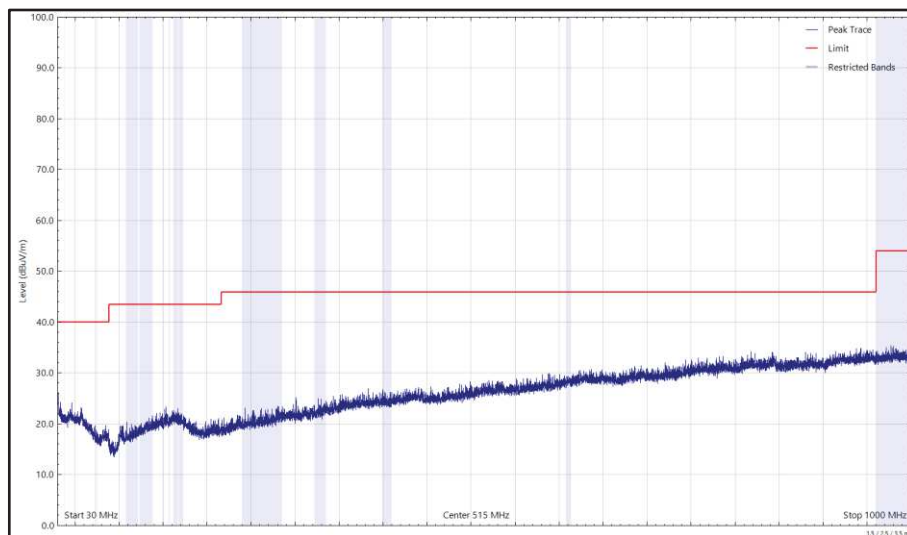

Figure 52 - 2440 MHz (CH18), Thread, ePA, Core 0 and U-NII-1 - 5240 MHz (CH48), VHT20, CDD, Core 0 + Core 1, 30 MHz to 1 GHz, Vertical (Peak)

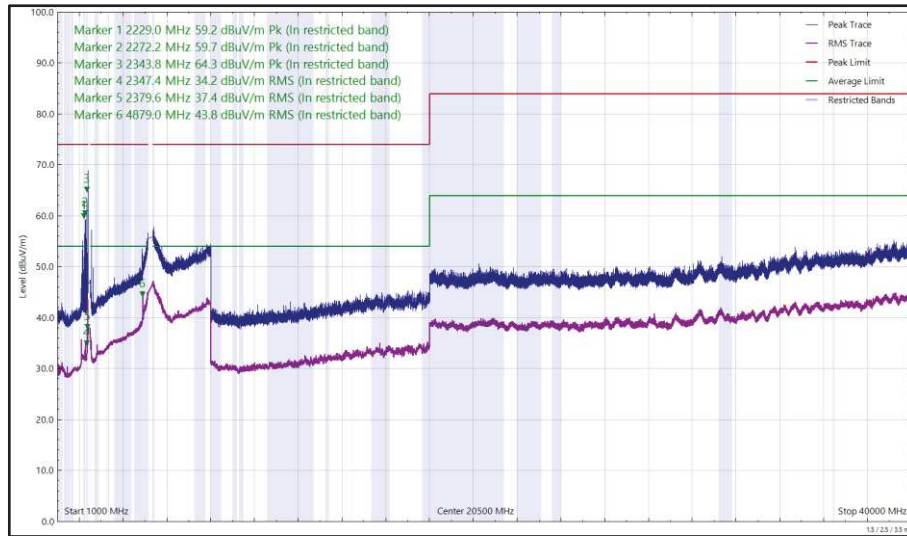

Figure 53 - 2440 MHz (CH18), Thread, ePA, Core 0 and U-NII-1 - 5240 MHz (CH48), VHT20, CDD, Core 0 + Core 1, 1 GHz to 40 GHz, Vertical



Frequency (MHz)	Level (dBuV/m)	Limit (dBuV/m)	Margin (dB)	Detector	Angle (°)	Height (cm)	Polarisation
*							

Table 21 - 2440 MHz (CH18), Thread, ePA, Core 1 and U-NII-1 - 5240 MHz (CH48), VHT20, CDD, Core 0 + Core 1, 30 MHz to 40 GHz

*No emissions found within 10 dB of the limit.

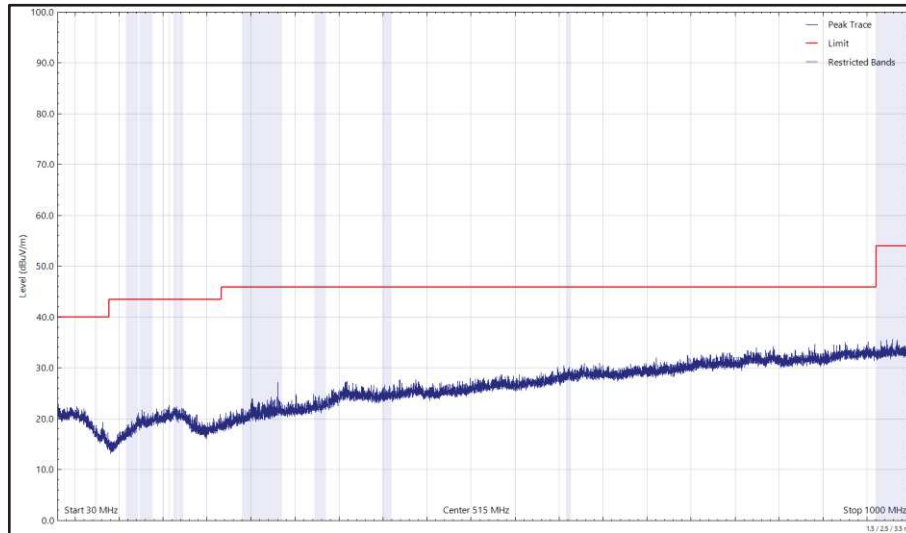

Figure 54 - 2440 MHz (CH18), Thread, ePA, Core 1 and U-NII-1 - 5240 MHz (CH48), VHT20, CDD, Core 0 + Core 1, 30 MHz to 1 GHz, Horizontal (Peak)

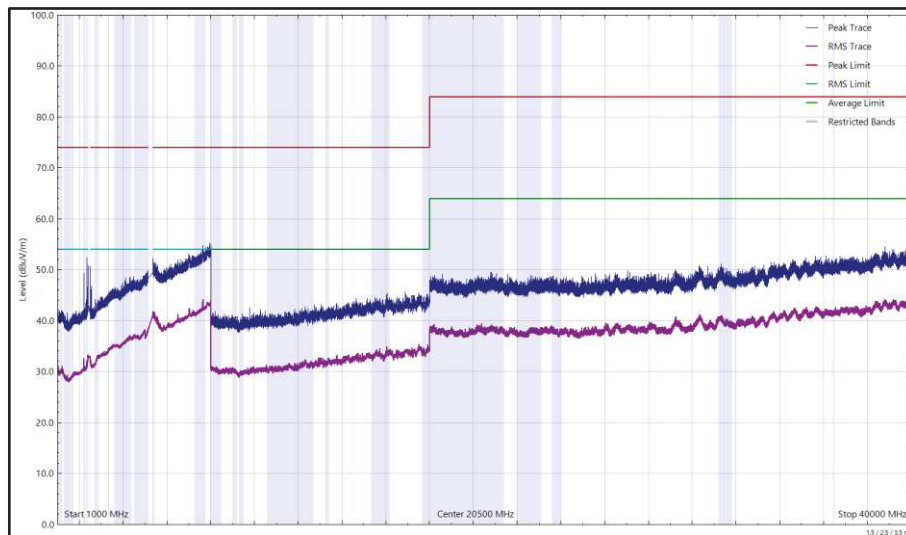

Figure 55 - 2440 MHz (CH18), Thread, ePA, Core 1 and U-NII-1 - 5240 MHz (CH48), VHT20, CDD, Core 0 + Core 1, 1 GHz to 40 GHz, Horizontal

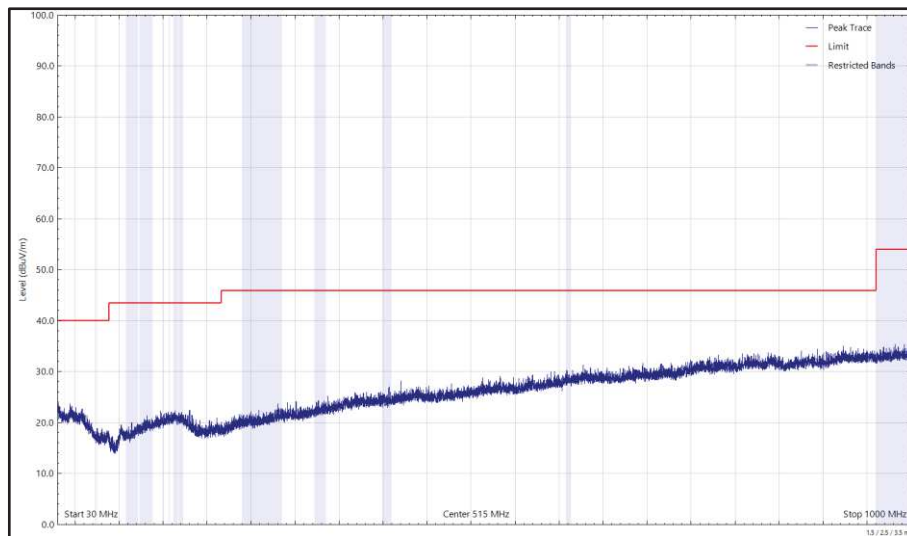

Figure 56 - 2440 MHz (CH18), Thread, ePA, Core 1 and U-NII-1 - 5240 MHz (CH48), VHT20, CDD, Core 0 + Core 1, 30 MHz to 1 GHz, Vertical (Peak)

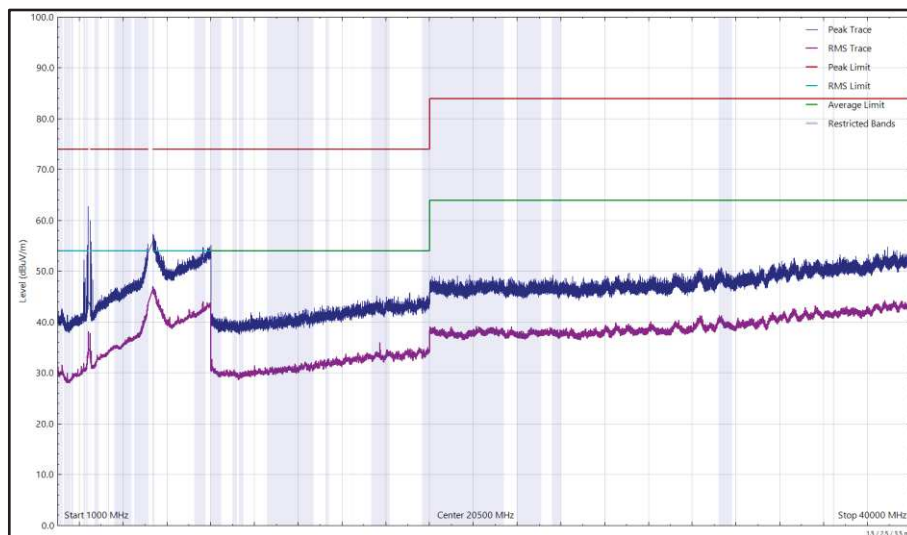

Figure 57 - 2440 MHz (CH18), Thread, ePA, Core 1 and U-NII-1 - 5240 MHz (CH48), VHT20, CDD, Core 0 + Core 1, 1 GHz to 40 GHz, Vertical



Frequency (MHz)	Level (dBuV/m)	Limit (dBuV/m)	Margin (dB)	Detector	Angle (°)	Height (cm)	Polarisation
4879.013	44.16	54.00	-9.84	RMS	354	304	Vertical

Table 22 - 2440 MHz (CH18), Thread, ePA, Core 2 and U-NII-1 - 5240 MHz (CH48), VHT20, CDD, Core 0 + Core 1, 30 MHz to 40 GHz

No other emissions found within 10 dB of the limit.

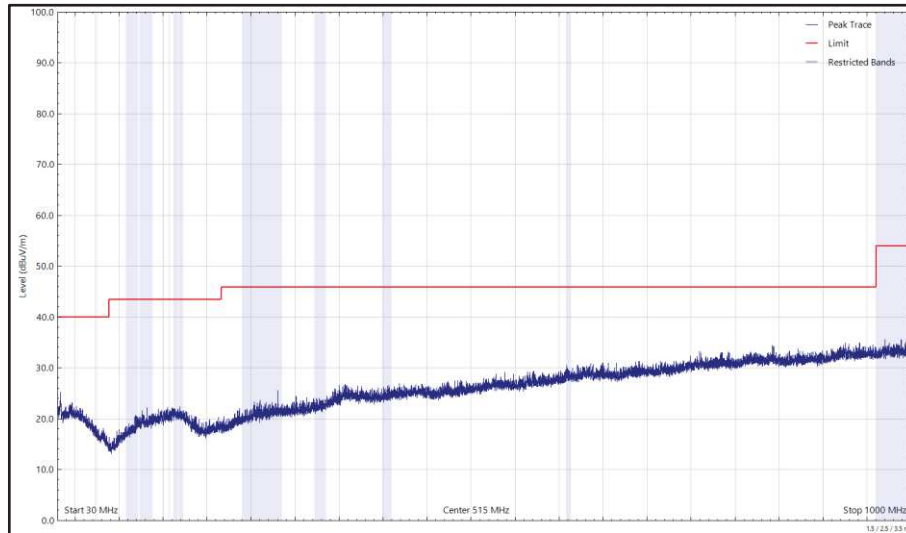

Figure 58 - 2440 MHz (CH18), Thread, ePA, Core 2 and U-NII-1 - 5240 MHz (CH48), VHT20, CDD, Core 0 + Core 1, 30 MHz to 1 GHz, Horizontal (Peak)

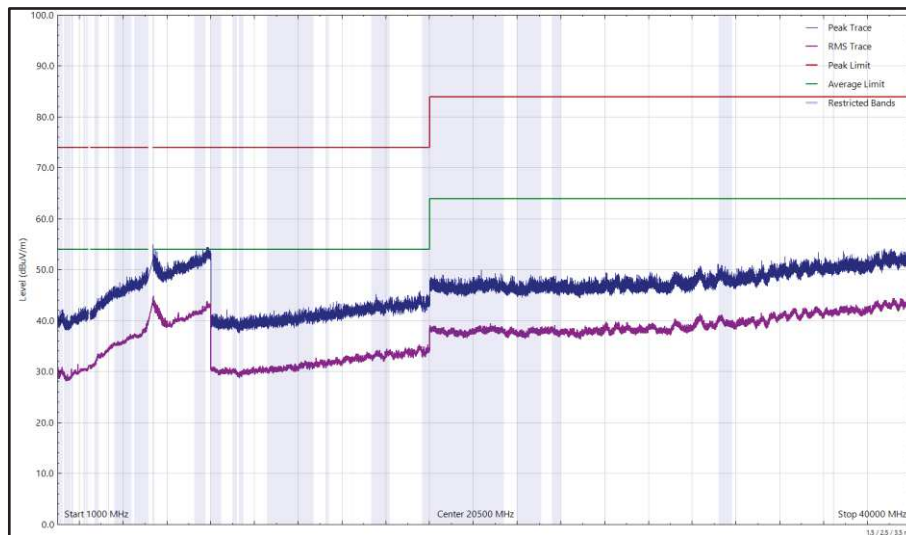

Figure 59 - 2440 MHz (CH18), Thread, ePA, Core 2 and U-NII-1 - 5240 MHz (CH48), VHT20, CDD, Core 0 + Core 1, 1 GHz to 40 GHz, Horizontal

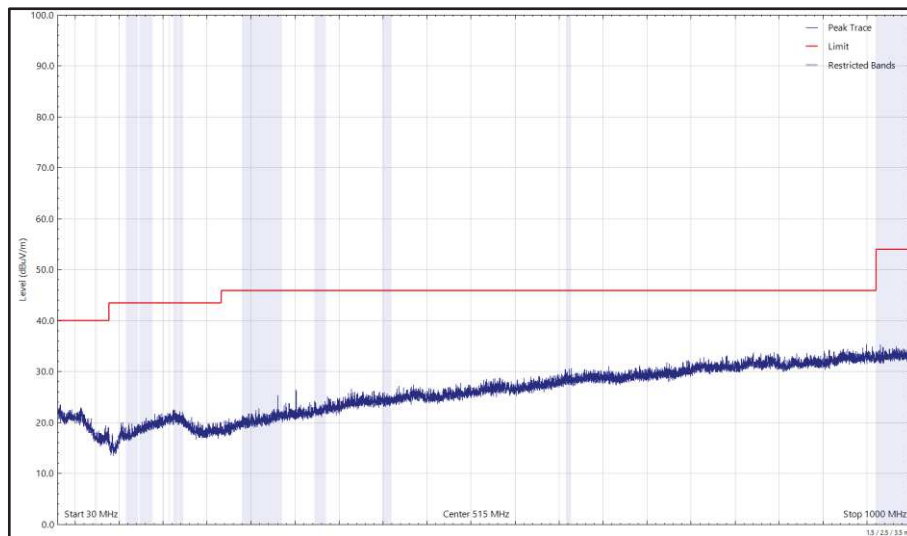

Figure 60 - 2440 MHz (CH18), Thread, ePA, Core 2 and U-NII-1 - 5240 MHz (CH48), VHT20, CDD, Core 0 + Core 1, 30 MHz to 1 GHz, Vertical (Peak)

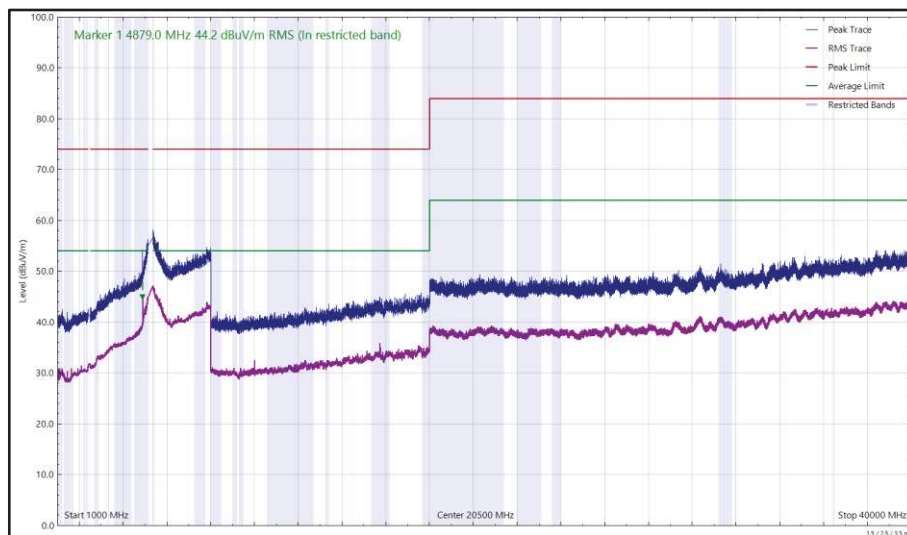

Figure 61 - 2440 MHz (CH18), Thread, ePA, Core 2 and U-NII-1 - 5240 MHz (CH48), VHT20, CDD, Core 0 + Core 1, 1 GHz to 40 GHz, Vertical



Frequency (MHz)	Level (dBuV/m)	Limit (dBuV/m)	Margin (dB)	Detector	Angle (°)	Height (cm)	Polarisation
*							

Table 23 - 2440 MHz (CH18), Thread, ePA, Core 0 and U-NII-2C - 5640 (CH128), VHT20, CDD, Core 0 + Core 1, 30 MHz to 40 GHz

*No emissions found within 10 dB of the limit.

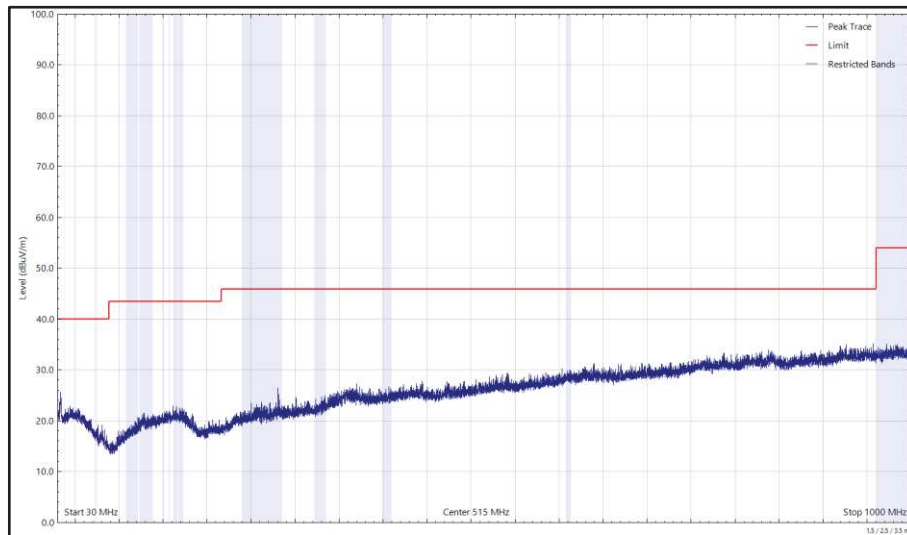

Figure 62 - 2440 MHz (CH18), Thread, ePA, Core 0 and U-NII-2C - 5640 (CH128), VHT20, CDD, Core 0 + Core 1, 30 MHz to 1 GHz, Horizontal (Peak)

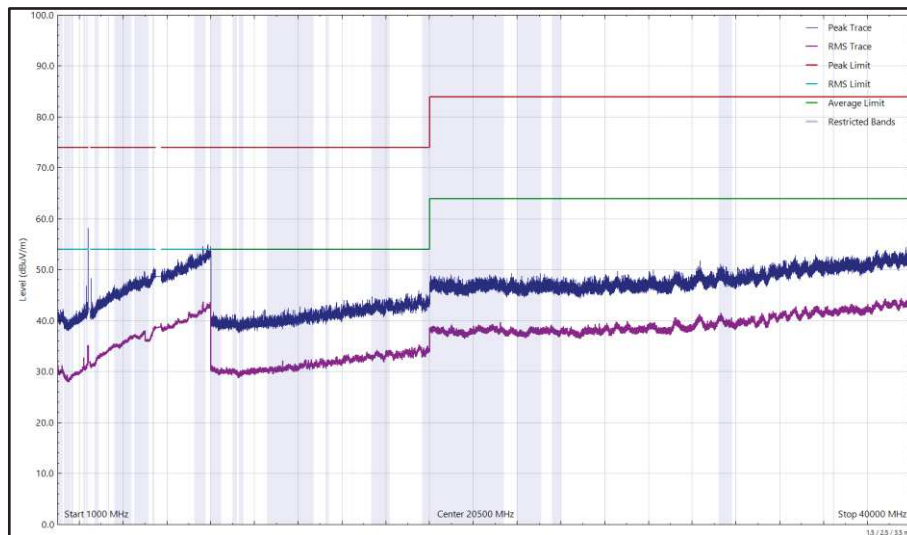

Figure 63 - 2440 MHz (CH18), Thread, ePA, Core 0 and U-NII-2C - 5640 (CH128), VHT20, CDD, Core 0 + Core 1, 1 GHz to 40 GHz, Horizontal

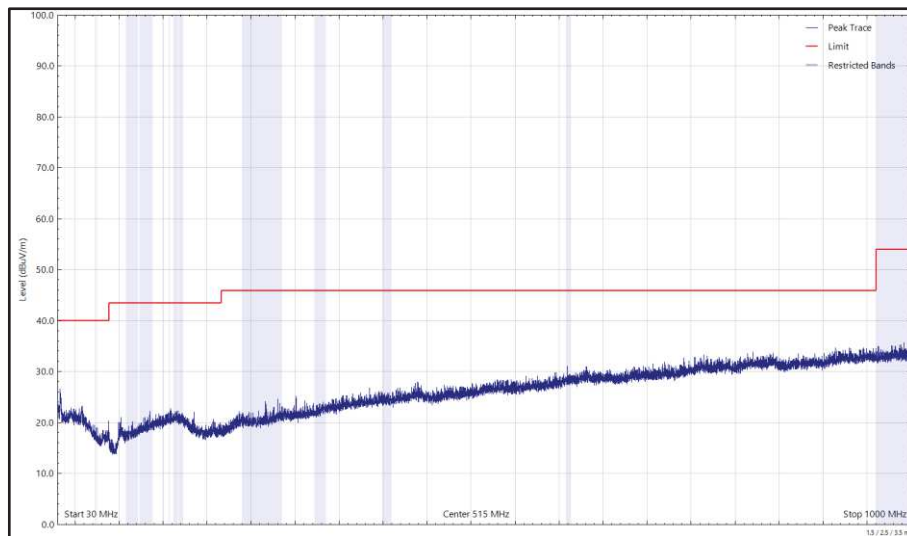

Figure 64 - 2440 MHz (CH18), Thread, ePA, Core 0 and U-NII-2C - 5640 (CH128), VHT20, CDD, Core 0 + Core 1, 30 MHz to 1 GHz, Vertical (Peak)

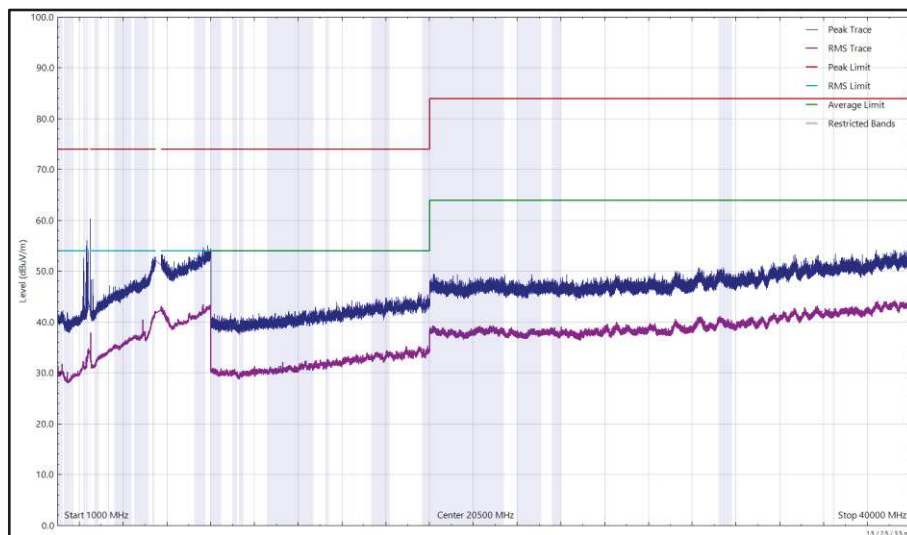

Figure 65 - 2440 MHz (CH18), Thread, ePA, Core 0 and U-NII-2C - 5640 (CH128), VHT20, CDD, Core 0 + Core 1, 1 GHz to 40 GHz, Vertical



Frequency (MHz)	Level (dBuV/m)	Limit (dBuV/m)	Margin (dB)	Detector	Angle (°)	Height (cm)	Polarisation
2367.160	60.67	74.00	-13.33	Peak	334	306	Vertical
2386.289	58.68	74.00	-15.32	Peak	324	349	Horizontal
2490.451	35.41	54.00	-18.59	RMS	10	295	Vertical
2493.510	66.70	74.00	-7.30	Peak	10	295	Vertical
4878.989	42.28	54.00	-11.72	RMS	10	322	Vertical

Table 24 - 2440 MHz (CH18), Thread, ePA, Core 1 and U-NII-2C - 5640 (CH128), VHT20, CDD, Core 0 + Core 1, 30 MHz to 40 GHz

No other emissions found within 10 dB of the limit.

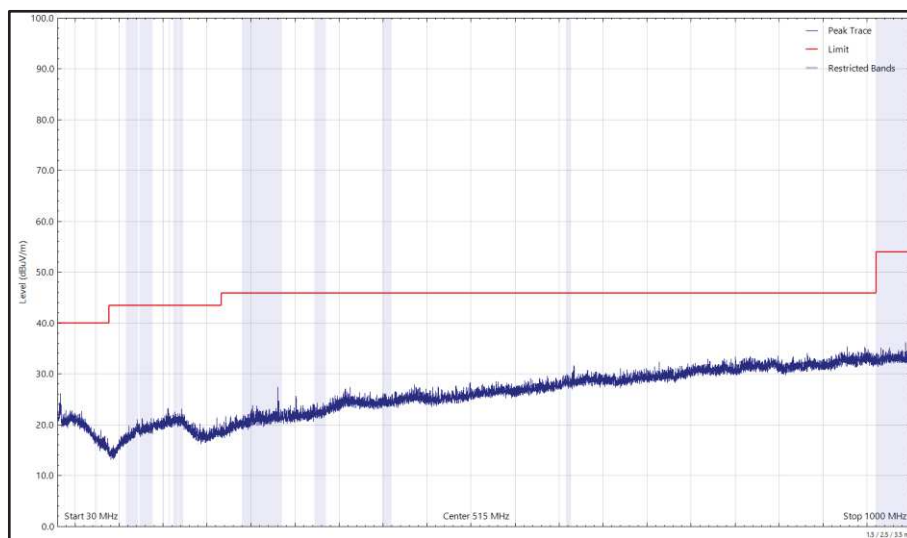

Figure 66 - 2440 MHz (CH18), Thread, ePA, Core 1 and U-NII-2C - 5640 (CH128), VHT20, CDD, Core 0 + Core 1, 30 MHz to 1 GHz, Horizontal (Peak)

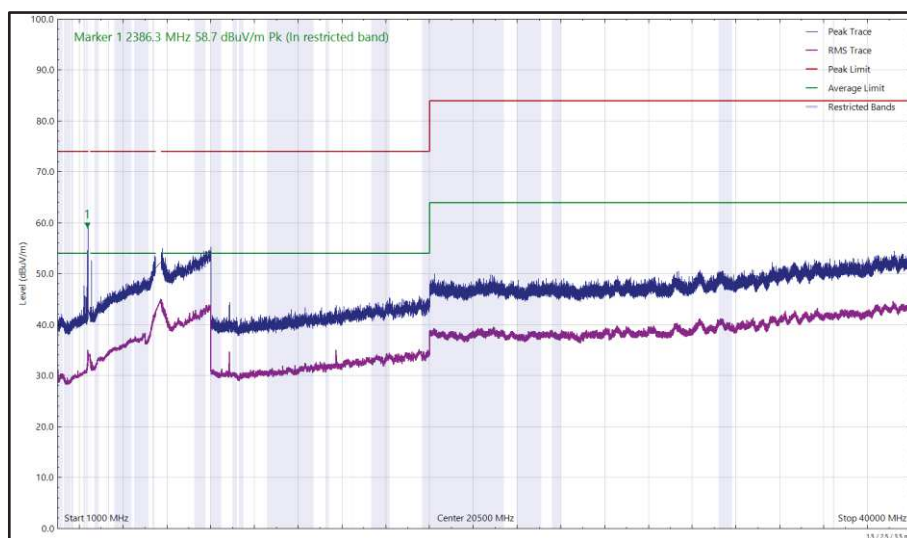

Figure 67 - 2440 MHz (CH18), Thread, ePA, Core 1 and U-NII-2C - 5640 (CH128), VHT20, CDD, Core 0 + Core 1, 1 GHz to 40 GHz, Horizontal

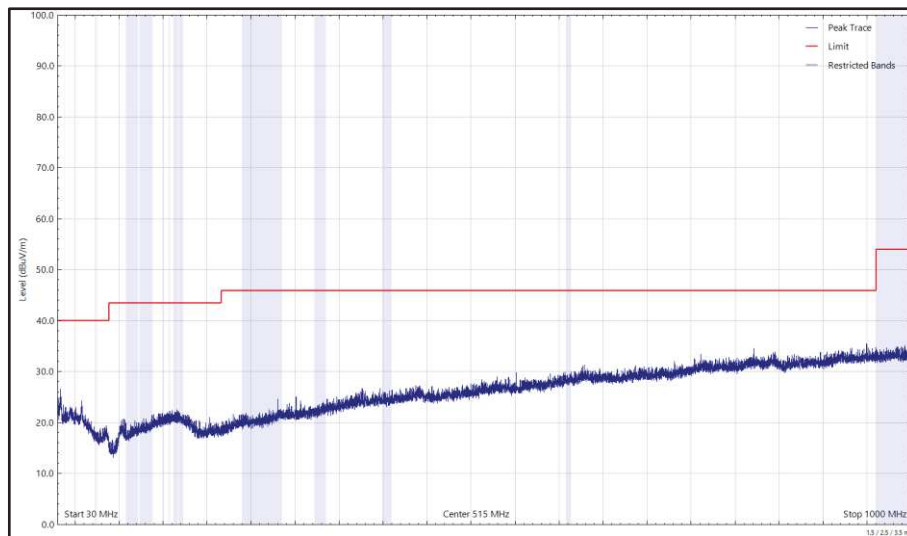

Figure 68 - 2440 MHz (CH18), Thread, ePA, Core 1 and U-NII-2C - 5640 (CH128), VHT20, CDD, Core 0 + Core 1, 30 MHz to 1 GHz, Vertical (Peak)

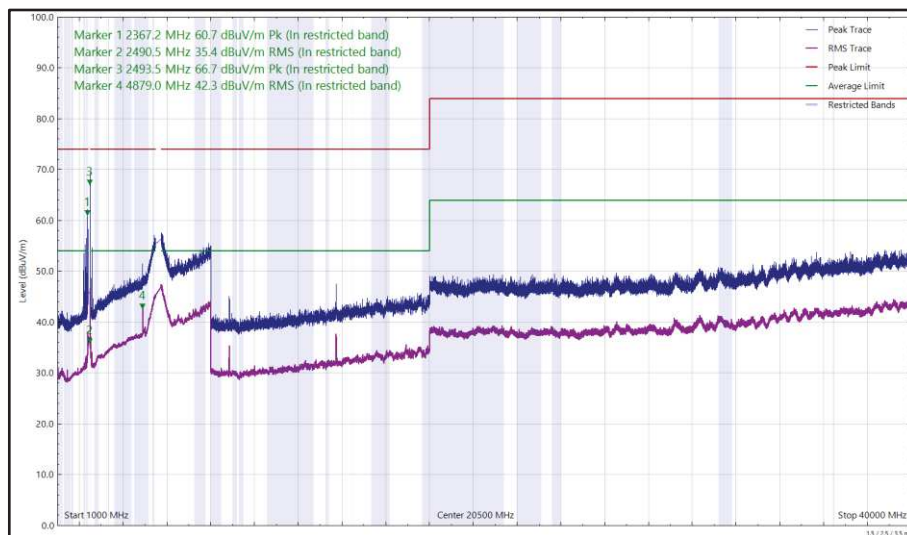

Figure 69 - 2440 MHz (CH18), Thread, ePA, Core 1 and U-NII-2C - 5640 (CH128), VHT20, CDD, Core 0 + Core 1, 1 GHz to 40 GHz, Vertical



Frequency (MHz)	Level (dBuV/m)	Limit (dBuV/m)	Margin (dB)	Detector	Angle (°)	Height (cm)	Polarisation
4880.973	42.14	54.00	-11.86	RMS	27	285	Vertical

Table 25 - 2440 MHz (CH18), Thread, ePA, Core 2 and U-NII-2C - 5640 (CH128), VHT20, CDD, Core 0 + Core 1, 30 MHz to 40 GHz

No other emissions found within 10 dB of the limit.

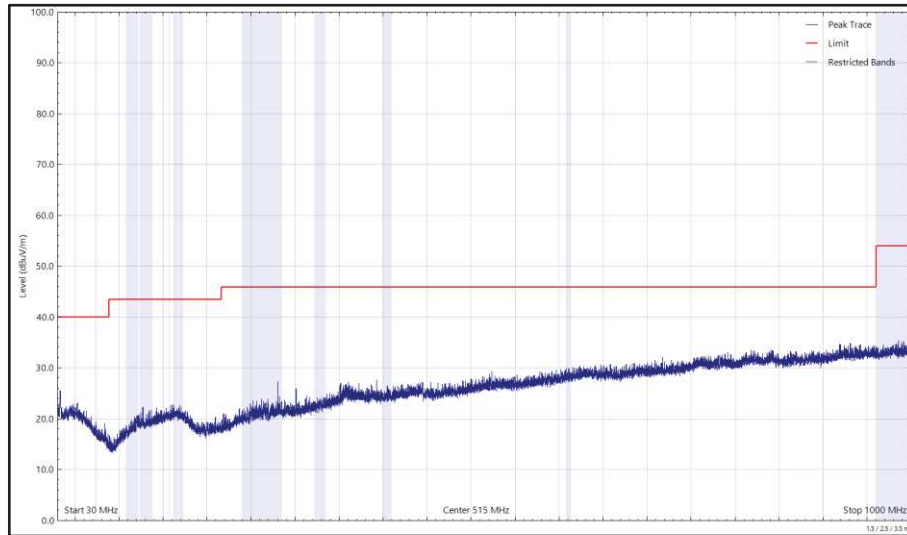

Figure 70 - 2440 MHz (CH18), Thread, ePA, Core 2 and U-NII-2C - 5640 (CH128), VHT20, CDD, Core 0 + Core 1, 30 MHz to 1 GHz, Horizontal (Peak)

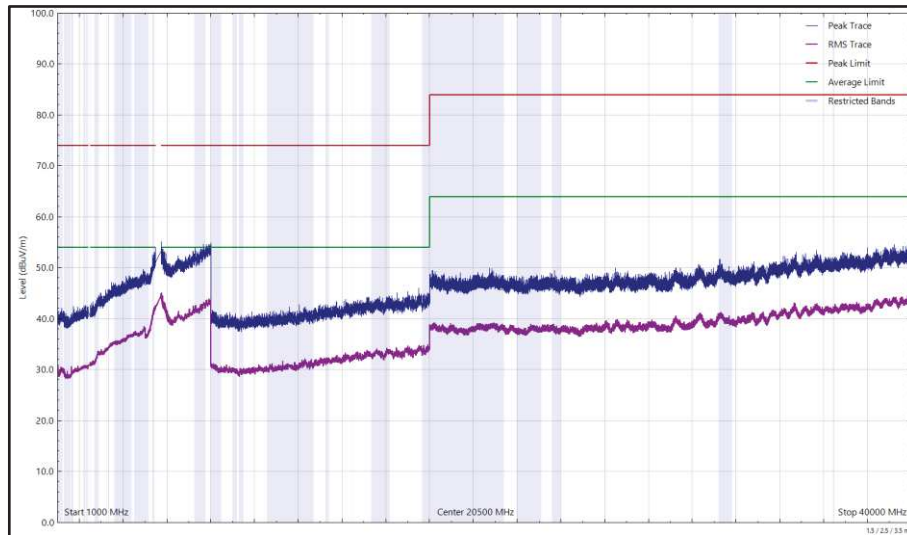

Figure 71 - 2440 MHz (CH18), Thread, ePA, Core 2 and U-NII-2C - 5640 (CH128), VHT20, CDD, Core 0 + Core 1, 1 GHz to 40 GHz, Horizontal

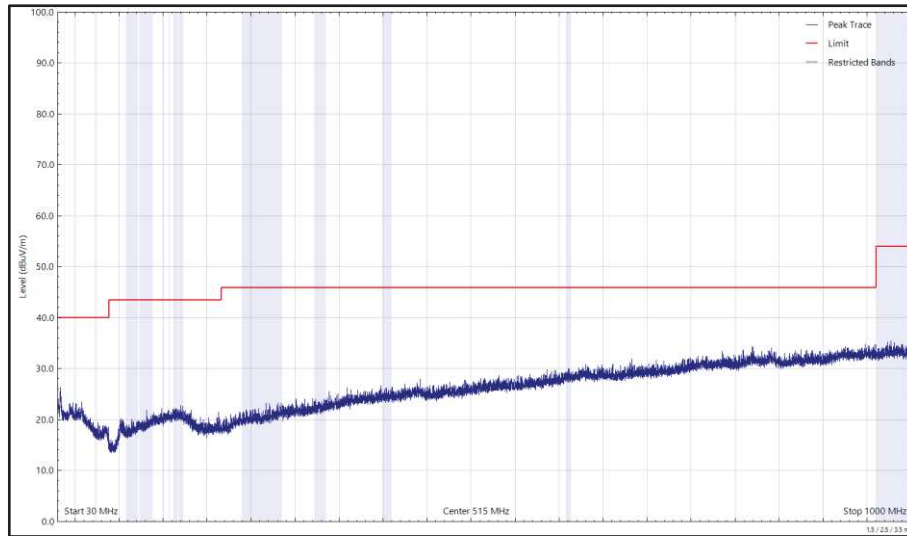

Figure 72 - 2440 MHz (CH18), Thread, ePA, Core 2 and U-NII-2C - 5640 (CH128), VHT20, CDD, Core 0 + Core 1, 30 MHz to 1 GHz, Vertical (Peak)

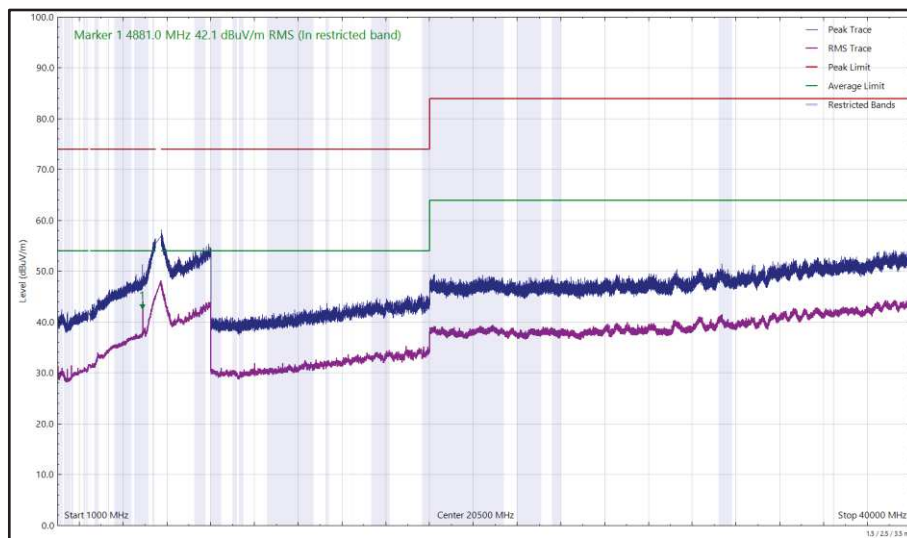

Figure 73 - 2440 MHz (CH18), Thread, ePA, Core 2 and U-NII-2C - 5640 (CH128), VHT20, CDD, Core 0 + Core 1, 1 GHz to 40 GHz, Vertical



FCC 47 CFR Part 15, ISED RSS-247 and ISED RSS-GEN

The least stringent limit from the applicable rule parts was used to determine compliance for Radiated Emissions testing of multiple transmission sources.

The least stringent applicable limit was:

Clause	Limit
Part 15.247 (d) / RSS-247 Clause 5.5	-20 dBc
Part 15.407 (b) / RSS-247 Clause 6.2	-27 dBm e.i.r.p
Part 15.209 / RSS-GEN Clause 8.9	Peak: 74 dB μ V/m at 3m, Average 54 dB μ V/m at 3m (Restricted bands > 1 GHz)

Table 26



CoTx - Thread and 6 GHz WLAN

Frequency (MHz)	Level (dBuV/m)	Limit (dBuV/m)	Margin (dB)	Detector	Angle (°)	Height (cm)	Polarisation
*							

Table 27 - 2440 MHz (CH18), Thread, ePA, Core 0 and U-NII-5 - 5955 MHz (CH1), HE20, SU, CDD, Core 0 + Core 1, 30 MHz to 40 GHz

*No emissions found within 10 dB of the limit.

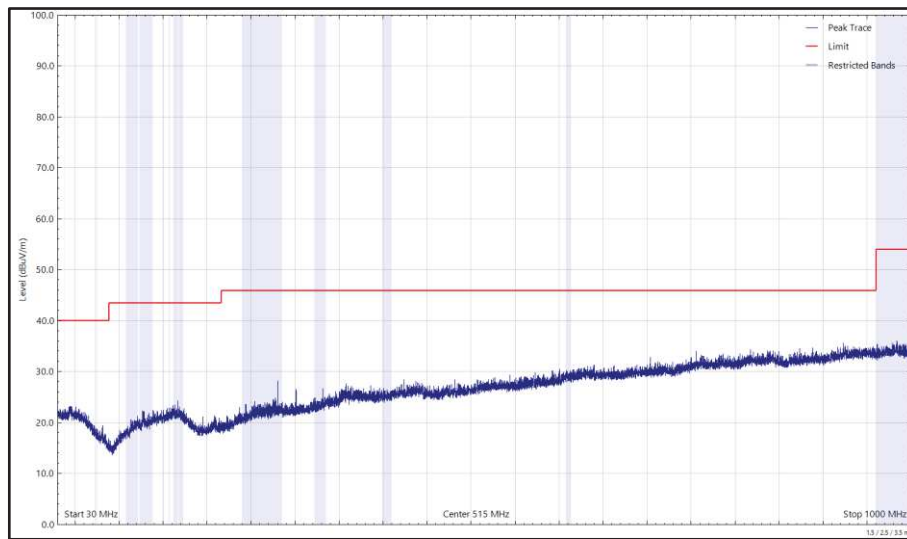

Figure 74 - 2440 MHz (CH18), Thread, ePA, Core 0 and U-NII-5 - 5955 MHz (CH1), HE20, SU, CDD, Core 0 + Core 1, 30 MHz to 1 GHz, Horizontal (Peak)

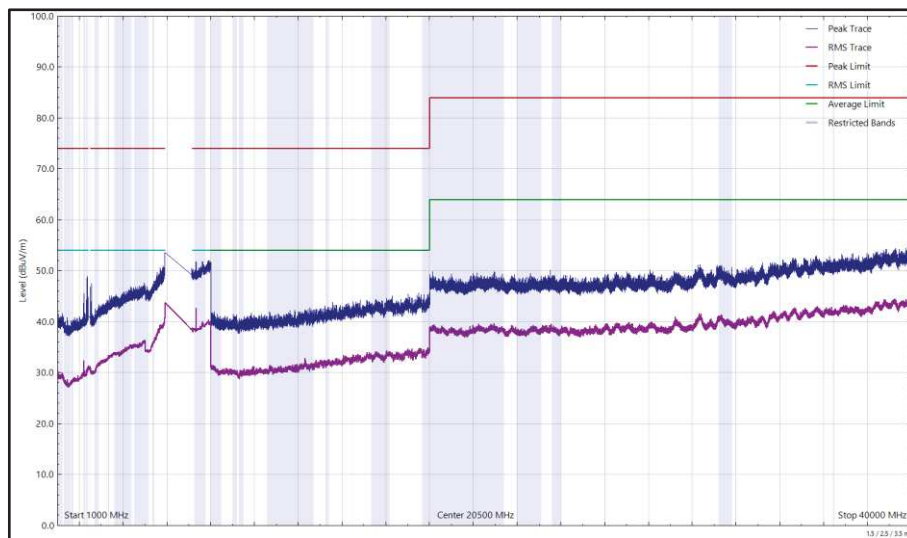

Figure 75 - 2440 MHz (CH18), Thread, ePA, Core 0 and U-NII-5 - 5955 MHz (CH1), HE20, SU, CDD, Core 0 + Core 1, 1 GHz to 40 GHz, Horizontal

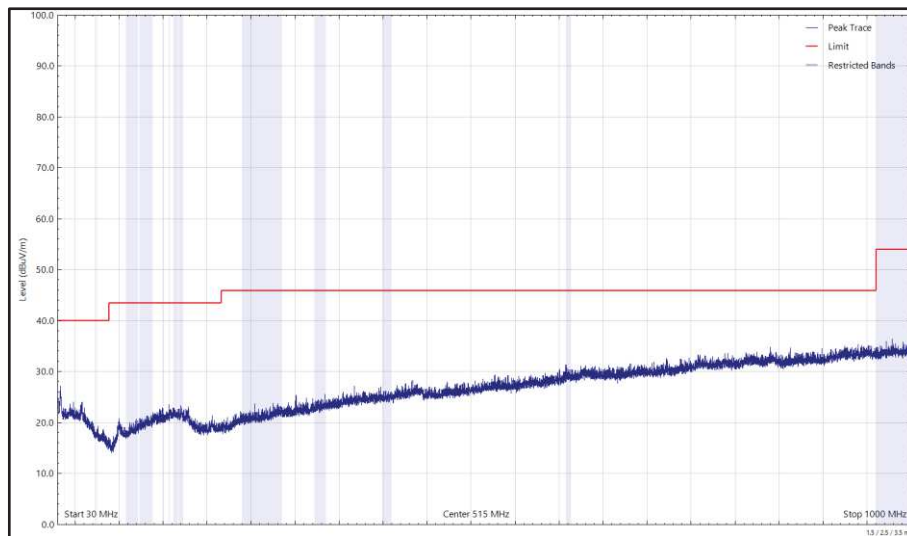

Figure 76 - 2440 MHz (CH18), Thread, ePA, Core 0 and U-NII-5 - 5955 MHz (CH1), HE20, SU, CDD, Core 0 + Core 1, 30 MHz to 1 GHz, Vertical (Peak)

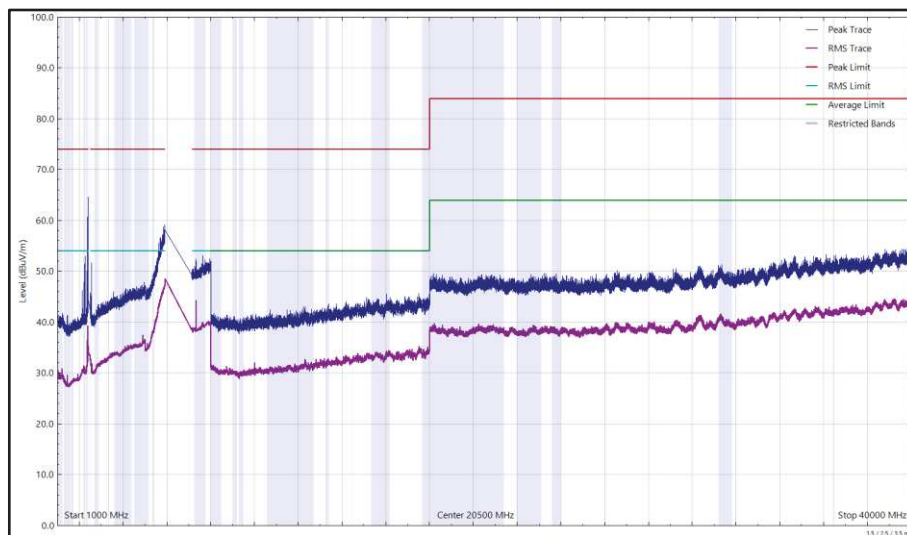

Figure 77 - 2440 MHz (CH18), Thread, ePA, Core 0 and U-NII-5 - 5955 MHz (CH1), HE20, SU, CDD, Core 0 + Core 1, 1 GHz to 40 GHz, Vertical



Frequency (MHz)	Level (dBuV/m)	Limit (dBuV/m)	Margin (dB)	Detector	Angle (°)	Height (cm)	Polarisation
*							

Table 28 - 2440 MHz (CH18), Thread, ePA, Core 1 and U-NII-5 - 5955 MHz (CH1), HE20, SU, CDD, Core 0 + Core 1, 30 MHz to 40 GHz

*No emissions found within 10 dB of the limit.

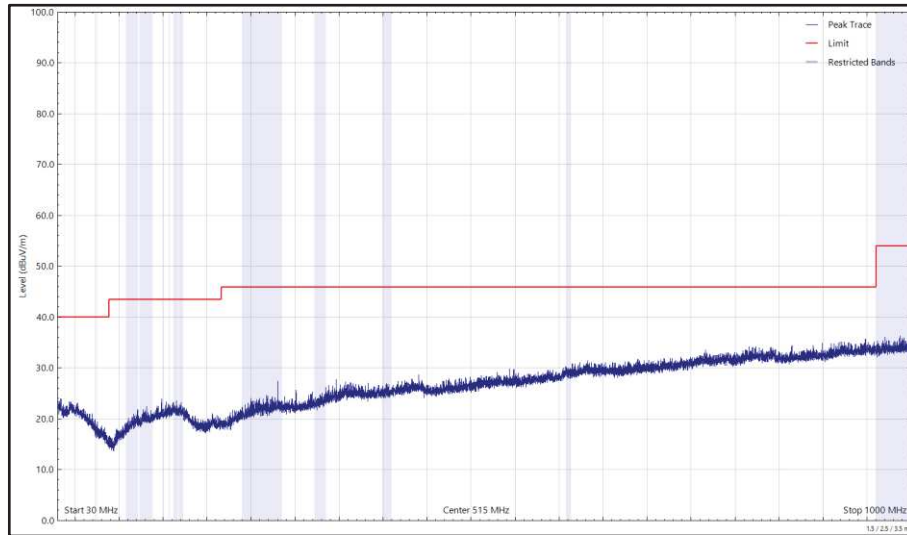

Figure 78 - 2440 MHz (CH18), Thread, ePA, Core 1 and U-NII-5 - 5955 MHz (CH1), HE20, SU, CDD, Core 0 + Core 1, 30 MHz to 1 GHz, Horizontal (Peak)

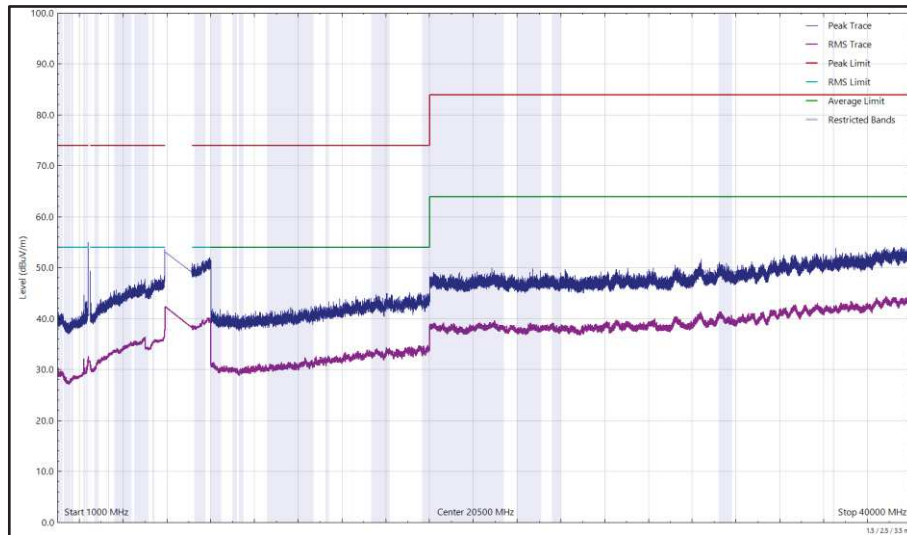

Figure 79 - 2440 MHz (CH18), Thread, ePA, Core 1 and U-NII-5 - 5955 MHz (CH1), HE20, SU, CDD, Core 0 + Core 1, 1 GHz to 40 GHz, Horizontal

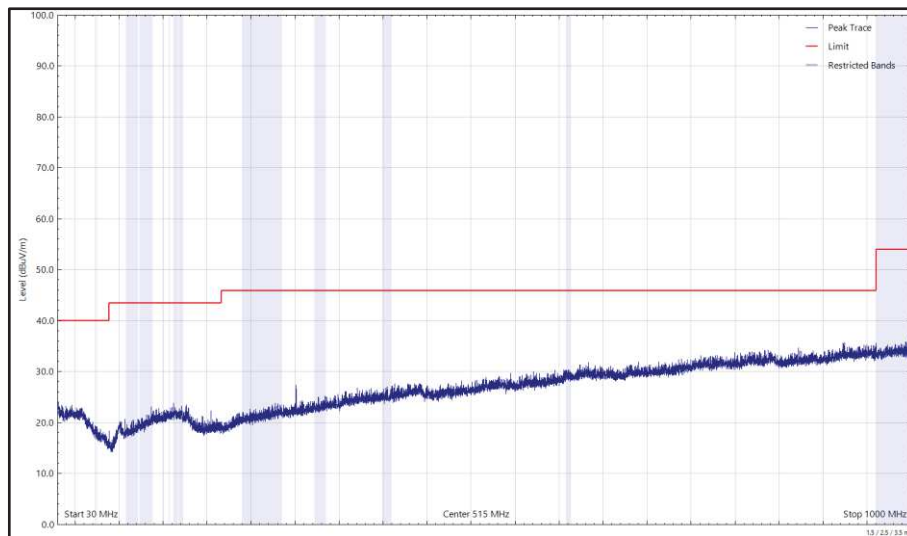

Figure 80 - 2440 MHz (CH18), Thread, ePA, Core 1 and U-NII-5 - 5955 MHz (CH1), HE20, SU, CDD, Core 0 + Core 1, 30 MHz to 1 GHz, Vertical (Peak)

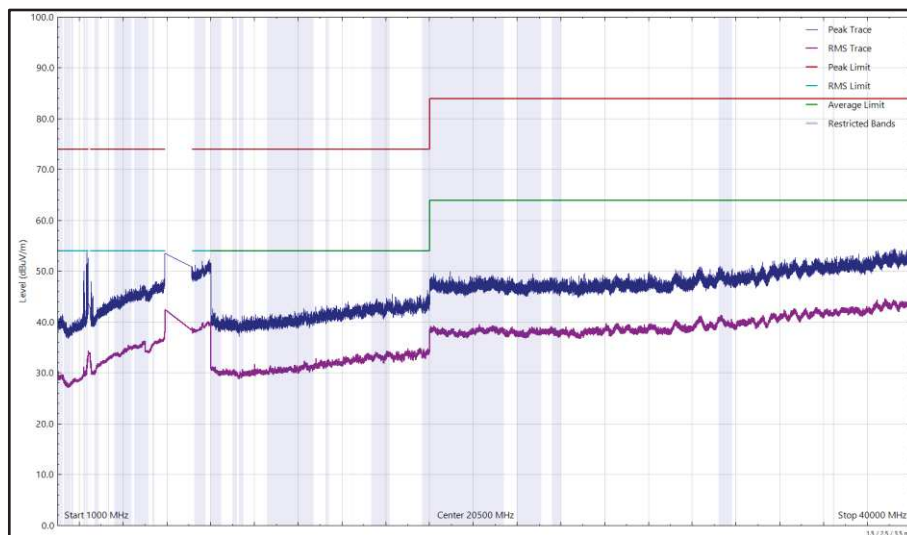

Figure 81 - 2440 MHz (CH18), Thread, ePA, Core 1 and U-NII-5 - 5955 MHz (CH1), HE20, SU, CDD, Core 0 + Core 1, 1 GHz to 40 GHz, Vertical



Frequency (MHz)	Level (dBuV/m)	Limit (dBuV/m)	Margin (dB)	Detector	Angle (°)	Height (cm)	Polarisation
4878.989	40.22	54.00	-13.78	RMS	353	320	Vertical
7318.242	38.84	54.00	-15.16	RMS	262	401	Horizontal
7321.474	44.78	54.00	-9.22	RMS	56	245	Vertical

Table 29 - 2440 MHz (CH18), Thread, ePA, Core 2 and U-NII-5 - 5955 MHz (CH1), HE20, SU, CDD, Core 0 + Core 1, 30 MHz to 40 GHz

No other emissions found within 10 dB of the limit.

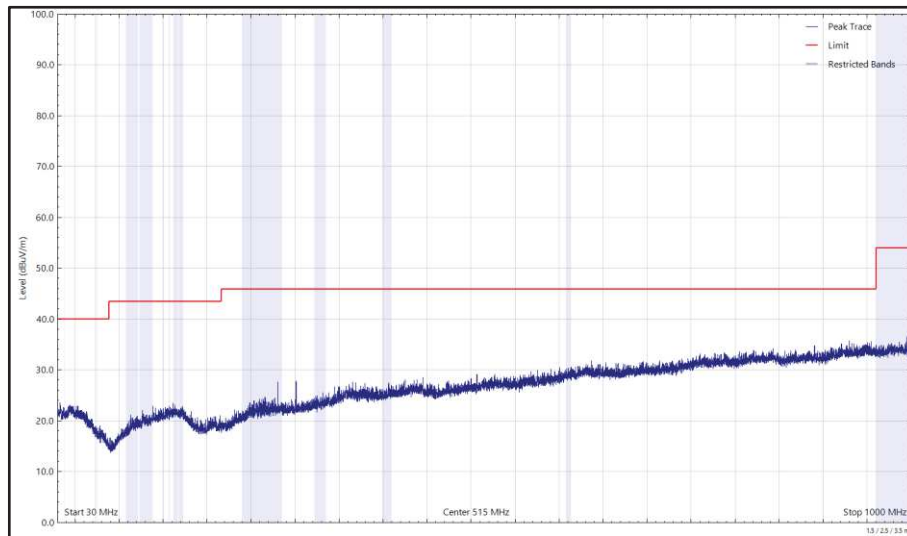

Figure 82 - 2440 MHz (CH18), Thread, ePA, Core 2 and U-NII-5 - 5955 MHz (CH1), HE20, SU, CDD, Core 0 + Core 1, 30 MHz to 1 GHz, Horizontal (Peak)

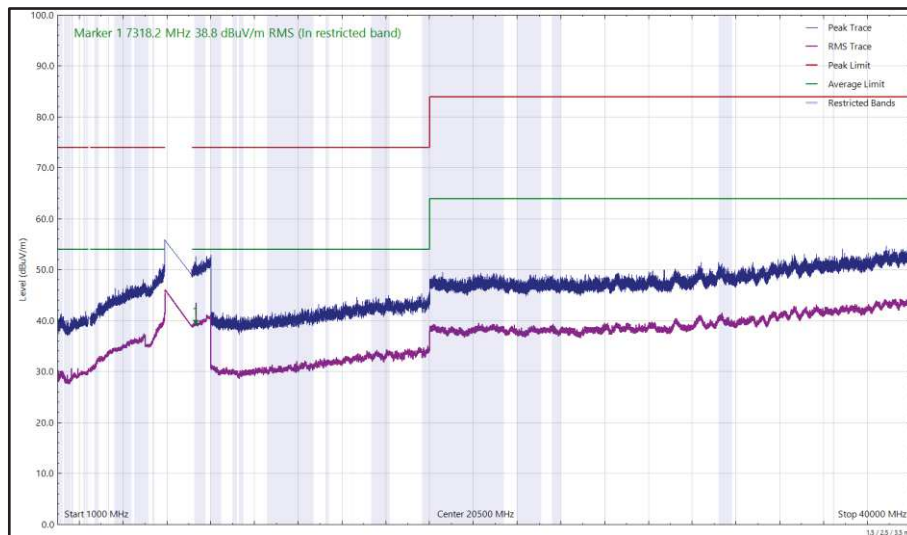

Figure 83 - 2440 MHz (CH18), Thread, ePA, Core 2 and U-NII-5 - 5955 MHz (CH1), HE20, SU, CDD, Core 0 + Core 1, 1 GHz to 40 GHz, Horizontal

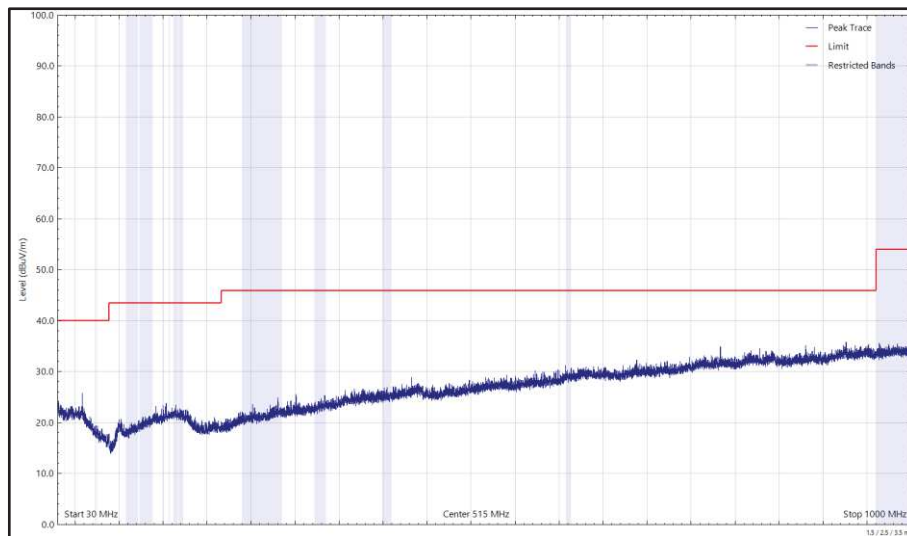

Figure 84 - 2440 MHz (CH18), Thread, ePA, Core 2 and U-NII-5 - 5955 MHz (CH1), HE20, SU, CDD, Core 0 + Core 1, 30 MHz to 1 GHz, Vertical (Peak)

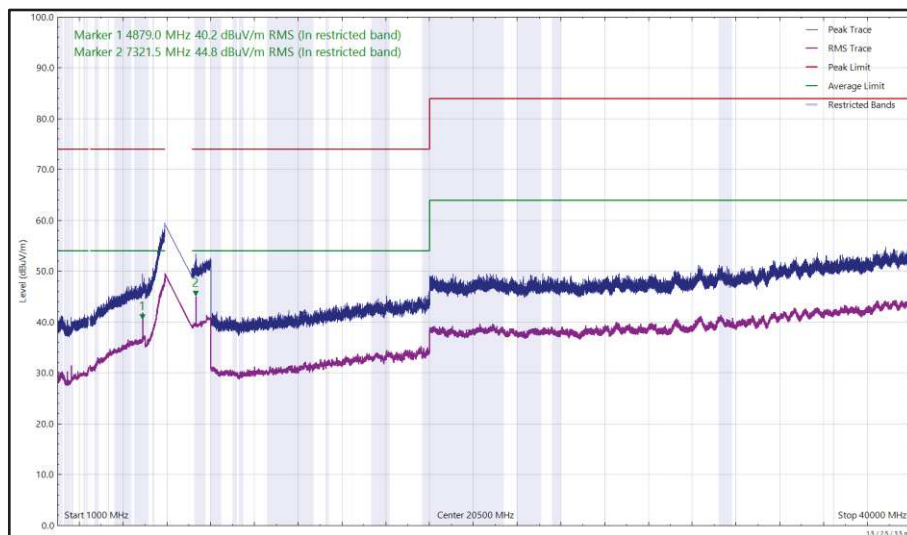

Figure 85 - 2440 MHz (CH18), Thread, ePA, Core 2 and U-NII-5 - 5955 MHz (CH1), HE20, SU, CDD, Core 0 + Core 1, 1 GHz to 40 GHz, Vertical



Frequency (MHz)	Level (dBuV/m)	Limit (dBuV/m)	Margin (dB)	Detector	Angle (°)	Height (cm)	Polarisation
*							

Table 30 - 2440 MHz (CH18), Thread, ePA, Core 0 and U-NII-8 - 7115 MHz (CH233), HE20, SU, CDD, Core 0 + Core 1, 30 MHz to 40 GHz

*No emissions found within 10 dB of the limit.

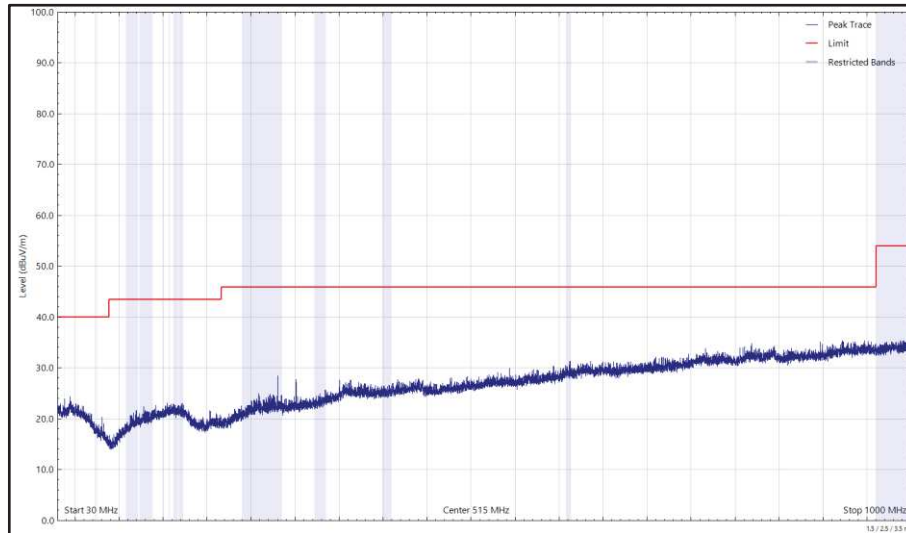

Figure 86 - 2440 MHz (CH18), Thread, ePA, Core 0 and U-NII-8 - 7115 MHz (CH233), HE20, SU, CDD, Core 0 + Core 1, 30 MHz to 1 GHz, Horizontal (Peak)

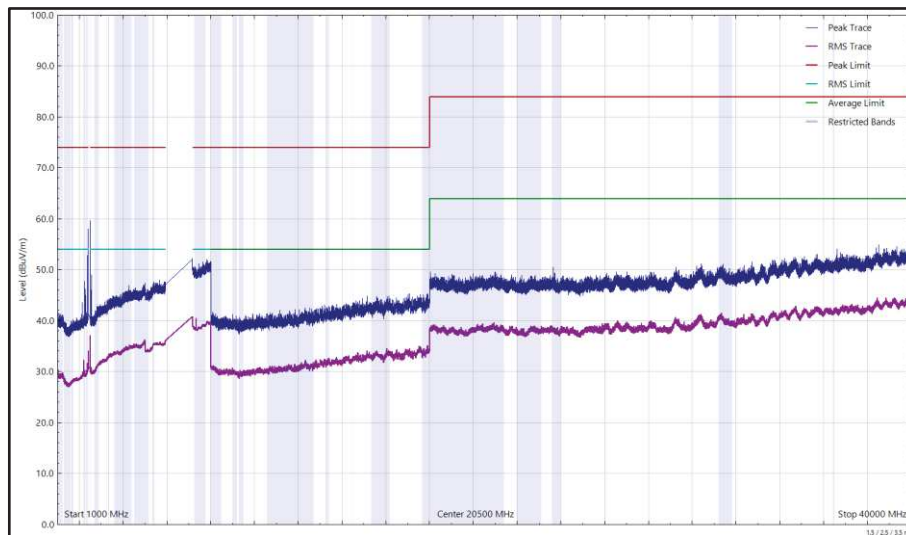

Figure 87 - 2440 MHz (CH18), Thread, ePA, Core 0 and U-NII-8 - 7115 MHz (CH233), HE20, SU, CDD, Core 0 + Core 1, 1 GHz to 40 GHz, Horizontal

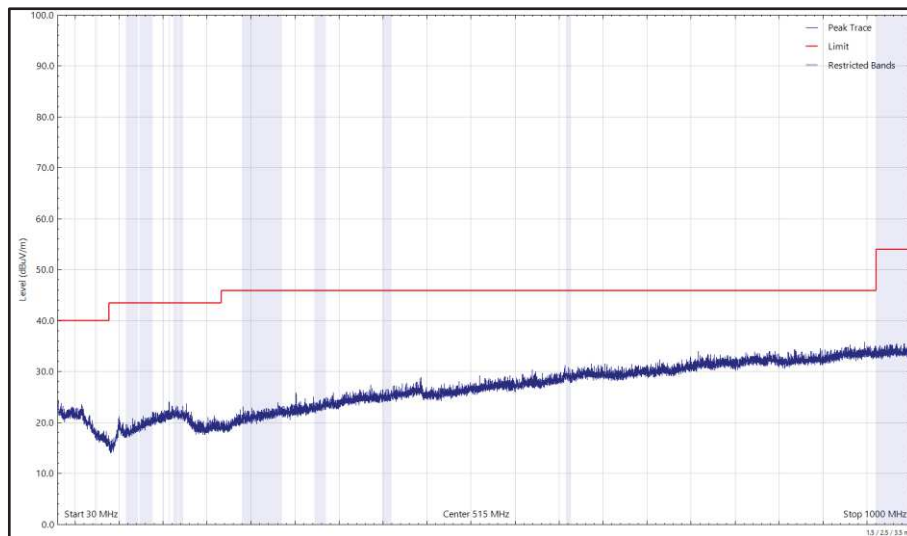

Figure 88 - 2440 MHz (CH18), Thread, ePA, Core 0 and U-NII-8 - 7115 MHz (CH233), HE20, SU, CDD, Core 0 + Core 1, 30 MHz to 1 GHz, Vertical (Peak)

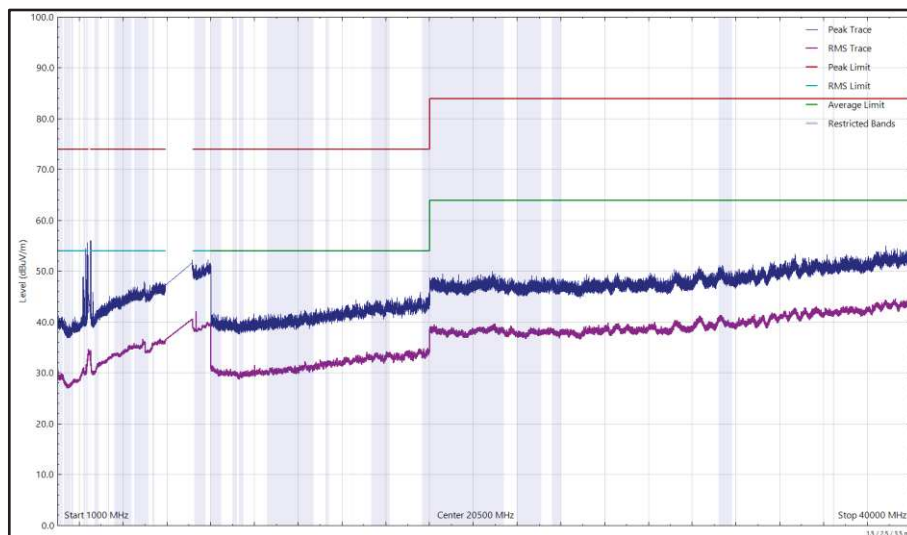

Figure 89 - 2440 MHz (CH18), Thread, ePA, Core 0 and U-NII-8 - 7115 MHz (CH233), HE20, SU, CDD, Core 0 + Core 1, 1 GHz to 40 GHz, Vertical



Frequency (MHz)	Level (dBuV/m)	Limit (dBuV/m)	Margin (dB)	Detector	Angle (°)	Height (cm)	Polarisation
2361.443	64.29	74.00	-9.71	Peak	50	432	Vertical
2382.592	65.59	74.00	-8.41	Peak	350	323	Vertical
7318.409	38.51	54.00	-15.49	RMS	352	440	Horizontal
7318.467	46.11	54.00	-7.89	RMS	348	238	Vertical

Table 31 - 2440 MHz (CH18), Thread, ePA, Core 1 and U-NII-8 - 7115 MHz (CH233), HE20, SU, CDD, Core 0 + Core 1, 30 MHz to 40 GHz

No other emissions found within 10 dB of the limit.

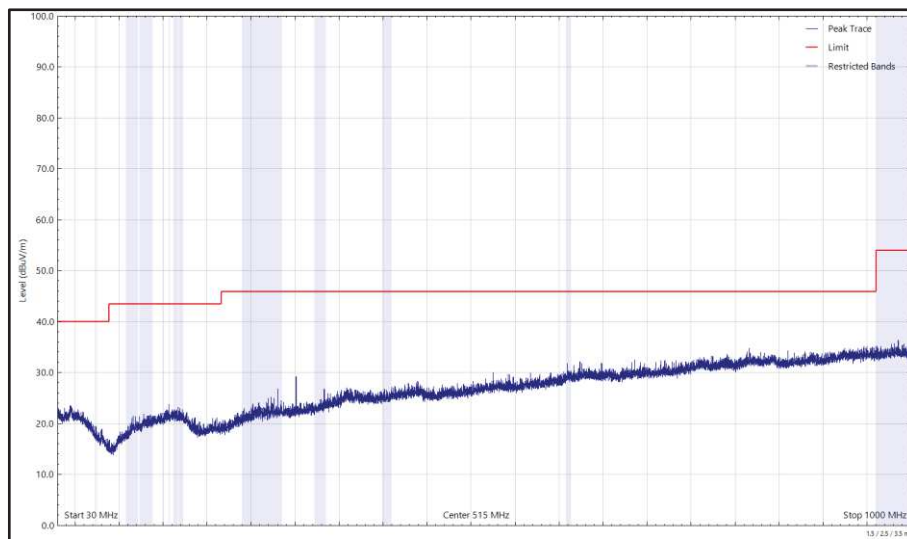

Figure 90 - 2440 MHz (CH18), Thread, ePA, Core 1 and U-NII-8 - 7115 MHz (CH233), HE20, SU, CDD, Core 0 + Core 1, 30 MHz to 1 GHz, Horizontal (Peak)

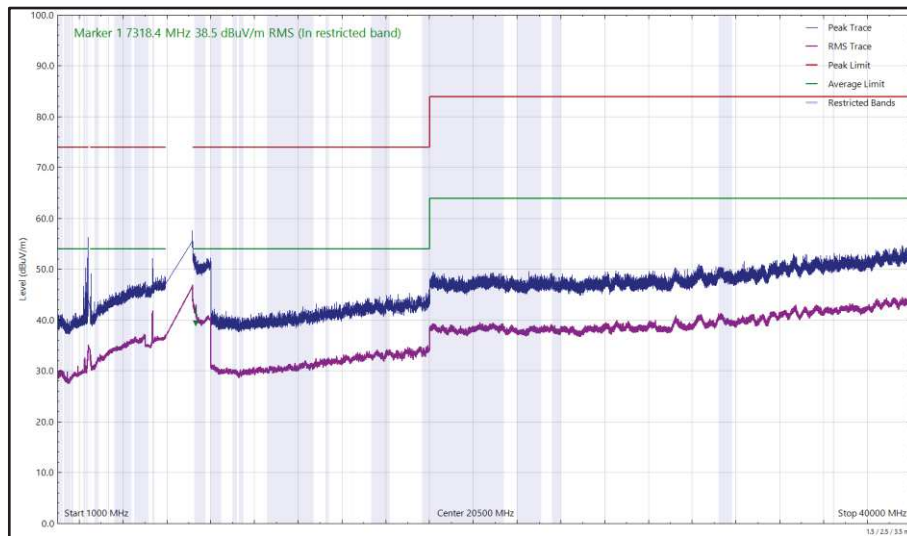

Figure 91 - 2440 MHz (CH18), Thread, ePA, Core 1 and U-NII-8 - 7115 MHz (CH233), HE20, SU, CDD, Core 0 + Core 1, 1 GHz to 40 GHz, Horizontal

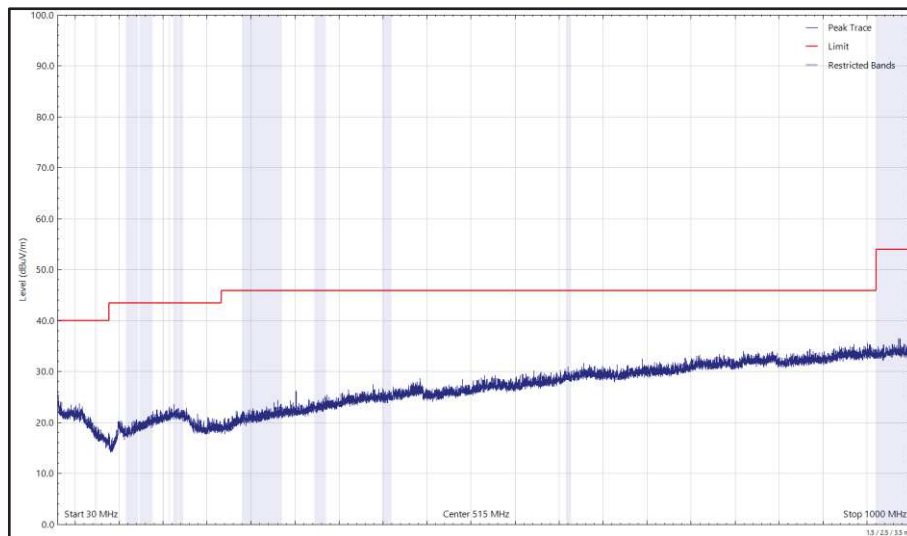

Figure 92 - 2440 MHz (CH18), Thread, ePA, Core 1 and U-NII-8 - 7115 MHz (CH233), HE20, SU, CDD, Core 0 + Core 1, 30 MHz to 1 GHz, Vertical (Peak)

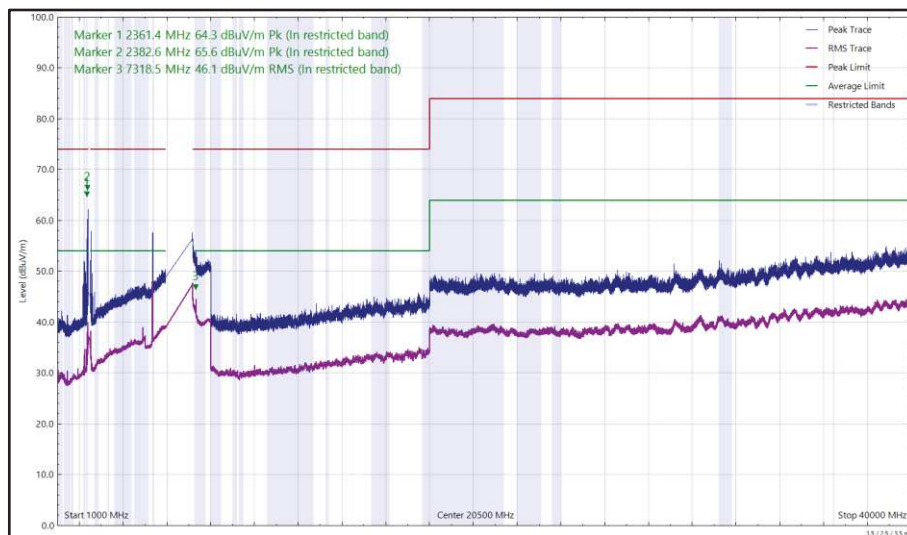

Figure 93 - 2440 MHz (CH18), Thread, ePA, Core 1 and U-NII-8 - 7115 MHz (CH233), HE20, SU, CDD, Core 0 + Core 1, 1 GHz to 40 GHz, Vertical



Frequency (MHz)	Level (dBuV/m)	Limit (dBuV/m)	Margin (dB)	Detector	Angle (°)	Height (cm)	Polarisation
4879.060	39.72	54.00	-14.28	RMS	350	312	Vertical
7303.640	39.12	54.00	-14.88	RMS	0	311	Horizontal
7318.427	45.57	54.00	-8.43	RMS	59	265	Vertical
7321.276	55.68	74.00	-18.32	Peak	59	265	Vertical

Table 32 - 2440 MHz (CH18), Thread, ePA, Core 2 and U-NII-8 - 7115 MHz (CH233), HE20, SU, CDD, Core 0 + Core 1, 30 MHz to 40 GHz

No other emissions found within 10 dB of the limit.

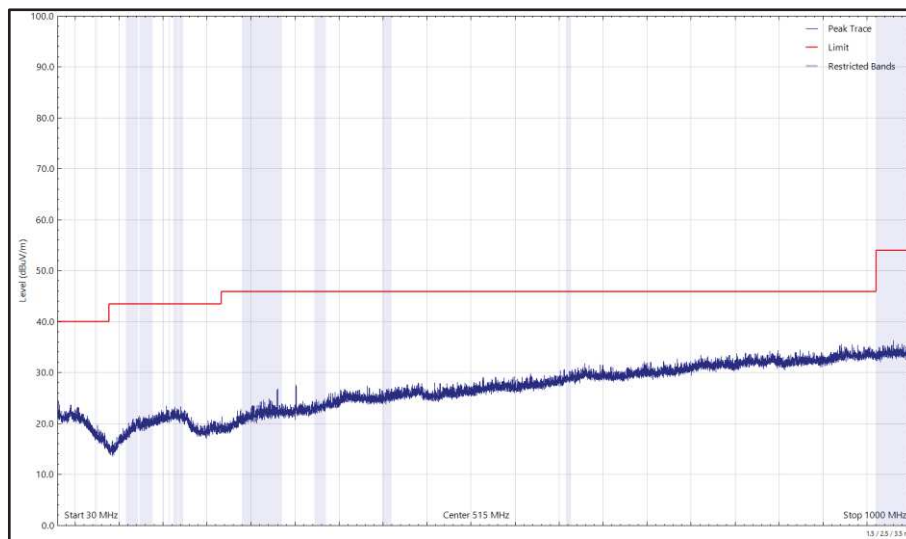

Figure 94 - 2440 MHz (CH18), Thread, ePA, Core 2 and U-NII-8 - 7115 MHz (CH233), HE20, SU, CDD, Core 0 + Core 1, 30 MHz to 1 GHz, Horizontal (Peak)

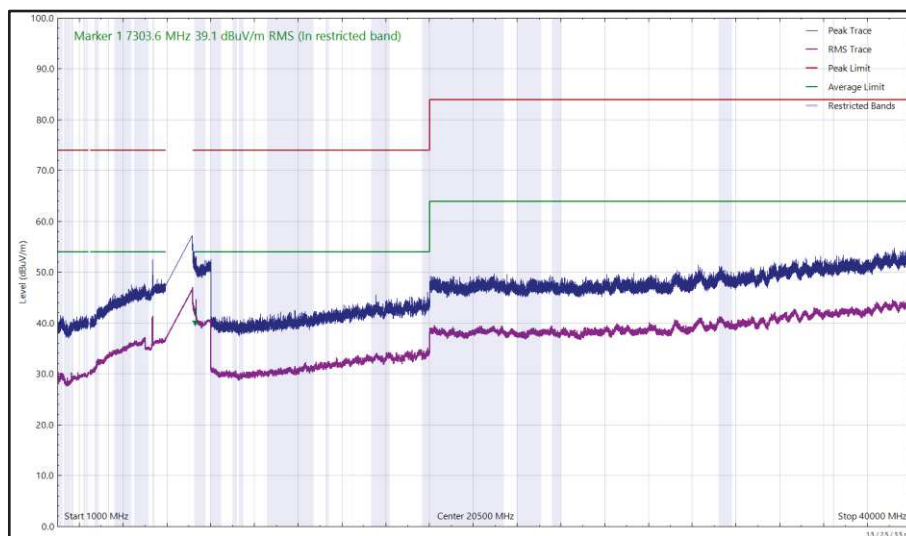

Figure 95 - 2440 MHz (CH18), Thread, ePA, Core 2 and U-NII-8 - 7115 MHz (CH233), HE20, SU, CDD, Core 0 + Core 1, 1 GHz to 40 GHz, Horizontal

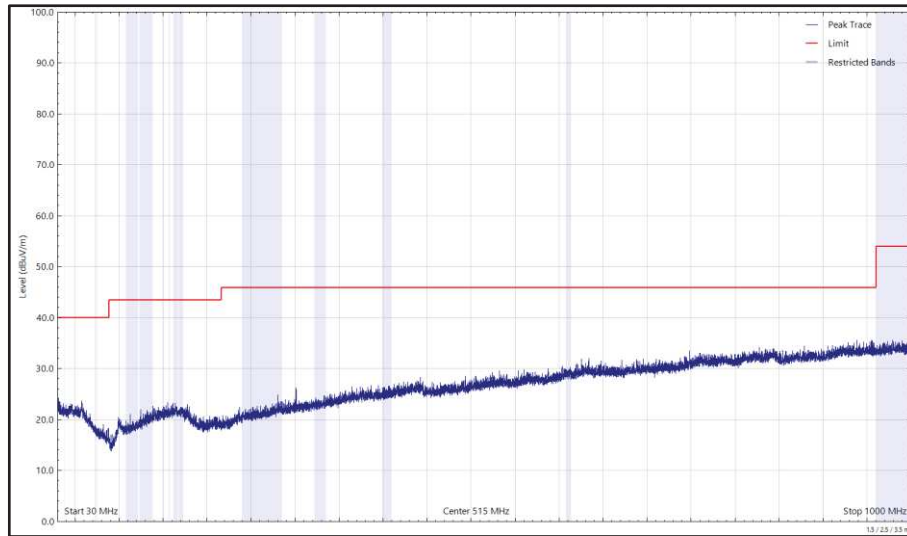

Figure 96 - 2440 MHz (CH18), Thread, ePA, Core 2 and U-NII-8 - 7115 MHz (CH233), HE20, SU, CDD, Core 0 + Core 1, 30 MHz to 1 GHz, Vertical (Peak)

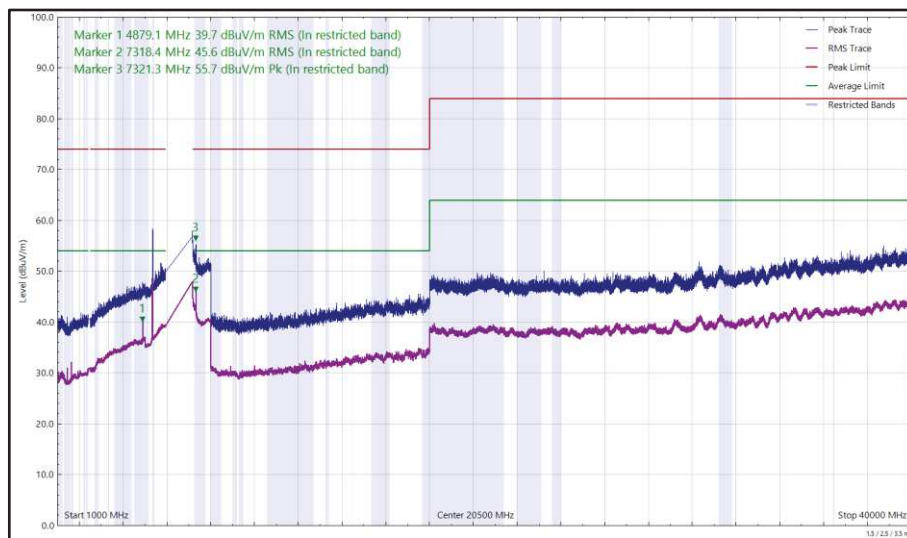

Figure 97 - 2440 MHz (CH18), Thread, ePA, Core 2 and U-NII-8 - 7115 MHz (CH233), HE20, SU, CDD, Core 0 + Core 1, 1 GHz to 40 GHz, Vertical



FCC 47 CFR Part 15, ISED RSS-247, ISED RSS-248 and ISED RSS-GEN

The least stringent limit from the applicable rule parts was used to determine compliance for Radiated Emissions testing of multiple transmission sources.

The least stringent applicable limit was:

Clause	Limit
Part 15 247 (d) / RSS-247 Clause 5.5	-20 dBc
Part 15.407 (b) / RSS-248 Clause 4.6.2	Peak: -7 dBm/MHz e.i.r.p, Average: -27 dBm/MHz e.i.r.p
Part 15.209 / RSS-GEN Clause 8.9	Peak: 74 dB μ V/m at 3m, Average 54 dB μ V/m at 3m (Restricted bands > 1 GHz)

Table 33



2.1.8 Test Location and Test Equipment Used

This test was carried out in RF Chamber 16.

Instrument	Manufacturer	Type No.	TE No.	Calibration Period (months)	Calibration Expiry Date
Emissions Software	TUV SUD	EmX V3.1.10	5125	-	Software
Test Receiver	Rohde & Schwarz	ESW44	5914	12	24-Feb-2024
Cable (K Type 2m)	Junkosha	MWX241-02000KMSKMS/B	5937	12	14-May-2023
DRG Horn Antenna (7.5-18GHz)	Schwarzbeck	HWRD750	5939	12	29-May-2023
TRILOG Super Broadband Test Antenna	Schwarzbeck	VULB 9168	5944	24	03-Feb-2024
1500W (300V 12A) AC Power Supply	iTech	IT7324	5957	-	O/P Mon
3m Semi-Anechoic Chamber	Schaffner	RF Chamber 16	5972	36	24-May-2025
Mast & Turntable Controller	Maturo Gmbh	FCU3.0	5973	-	TU
Tilt Antenna Mast	Maturo Gmbh	BAM4.5-P	5974	-	TU
Turntable	Maturo Gmbh	TT1.5SI	5975	-	TU
Cable (SMA to SMA 1m)	Junkosha	MWX221-01000AMSAMS/A	6018	12	06-Jun-2023
Horn Antenna (1-10 GHz)	Schwarzbeck	BBHA9120B	6142	12	26-Jun-2023
Digital Multimeter	Fluke	115	6145	12	17-Jun-2023
Humidity & Temperature meter	R.S Components	1364	6148	12	17-Jun-2023
Double Ridge Active Horn Antenna (18-40 GHz)	Com-Power	AHA-840	6187	24	02-Jun-2024
SAC Switch Unit	TUV SUD	TUV_SSU_001	6190	12	16-Dec-2023
8 GHz Highpass Filter	Wainwright	WHKX 7150 8000 18000 50SS	6195	12	15-Jul-2023
Pre Amp 8 - 18 GHz	Wright Technologies	APS06 0061	6198	12	19-Jul-2023
Attenuator 4dB	Pasternack	PE7074-4	6203	24	16-Jul-2024
Cable (SMA to SMA 20cm)	TUV SUD	MH-FH 8-18	6214	12	25-Jul-2023
Cable (SMA to SMA 8m)	Junkosha	MWX221-08000AMSAMS/B	6318	12	04-Feb-2024

Table 34

TU - Traceability Unscheduled
 O/P Mon - Output Monitored using calibrated equipment



3 Measurement Uncertainty

For a 95% confidence level, the measurement uncertainties for defined systems are:

Test Name	Measurement Uncertainty
Radiated Spurious Emissions (Simultaneous Transmission)	30 MHz to 1 GHz: ± 5.2 dB 1 GHz to 40 GHz: ± 6.3 dB

Table 35

Measurement Uncertainty Decision Rule – Accuracy Method

Determination of conformity with the specification limits is based on the decision rule according to IEC Guide 115:2021, Clause 4.4.3 (Procedure 2). The measurement results are directly compared with the test limit to determine conformance with the requirements of the standard.

Risk: The uncertainty of measurement about the measured result is negligible with regard to the final pass/fail decision. The measurement result can be directly compared with the test limit to determine conformance with the requirement (compare IEC Guide 115). The level of risk to falsely accept and falsely reject items is further described in ILAC-G8.