

2.5.5 Test Setup Diagram

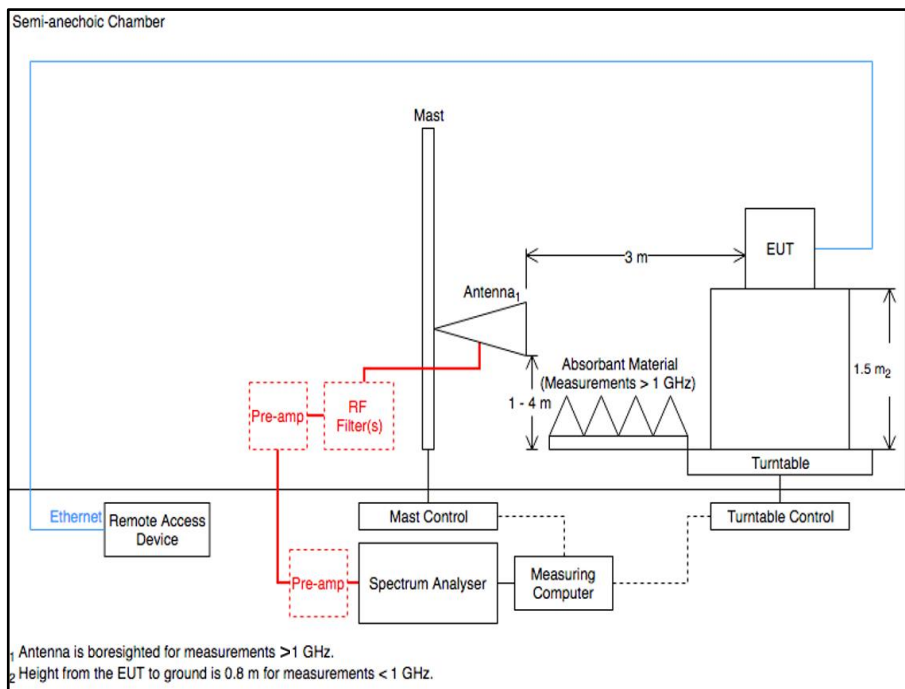

Figure 112 - Radiated Emissions Test Setup Diagram

2.5.6 Environmental Conditions

Ambient Temperature	21.5 - 22.2 °C
>	
Relative Humidity	40.5 - 43.0 %



2.5.7 Test Results

6 GHz WLAN

Frequency (MHz)	Level (dBuV/m)	Limit (dBuV/m)	Margin (dB)	Detector	Angle (°)	Height (cm)	Polarisation
*							

Table 347 - U-NII-5 - 5955 MHz (CH1), HE20, SU, CDD, Core 0 + Core 1, 1 GHz to 40 GHz

*No emissions found within 10 dB of the limit.

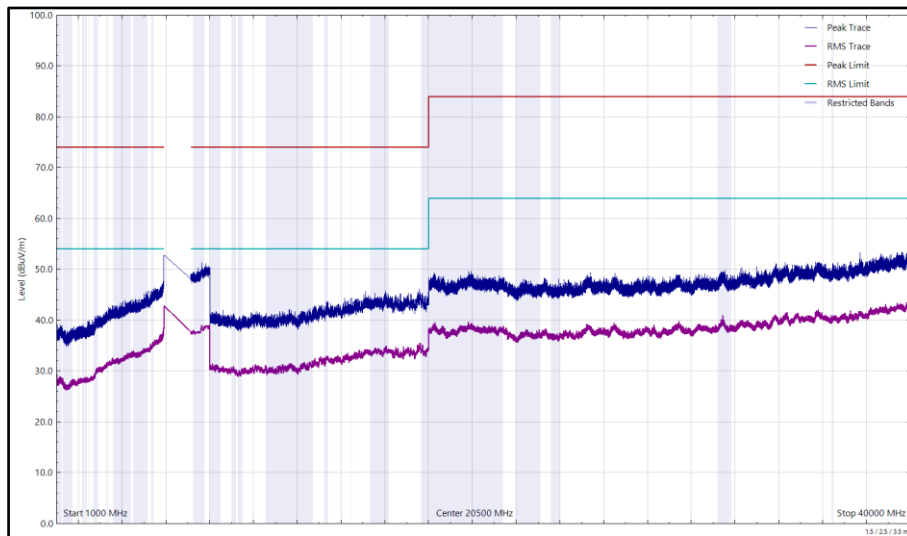

Figure 113 - U-NII-5 - 5955 MHz (CH1), HE20, SU, CDD, Core 0 + Core 1, 1 GHz to 40 GHz, Horizontal

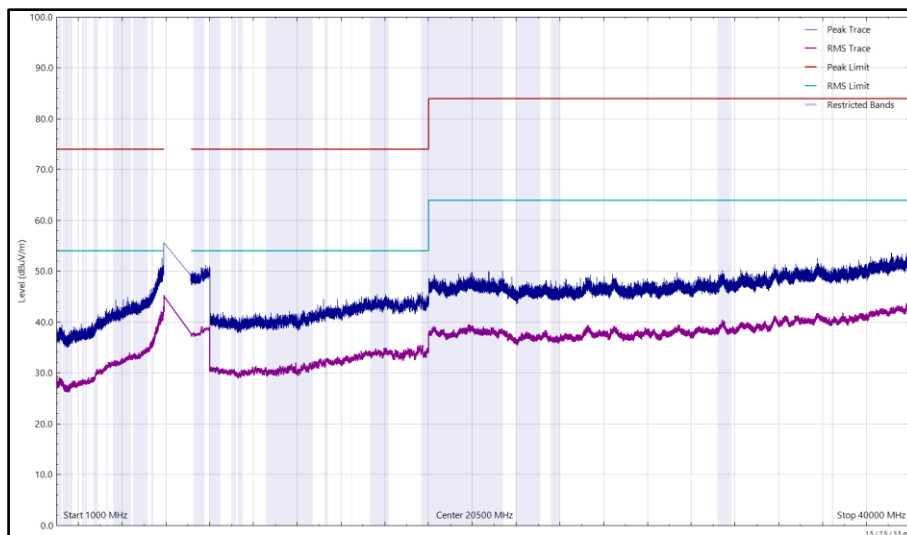

Figure 114 - U-NII-5 - 5955 MHz (CH1), HE20, SU, CDD, Core 0 + Core 1, 1 GHz to 40 GHz, Vertical



Frequency (MHz)	Level (dBuV/m)	Limit (dBuV/m)	Margin (dB)	Detector	Angle (°)	Height (cm)	Polarisation
*							

Table 348 - U-NII-5 - 6175 MHz (CH45), HE20, SU, CDD, Core 0 + Core 1, 30 MHz to 40 GHz

*No emissions found within 10 dB of the limit.

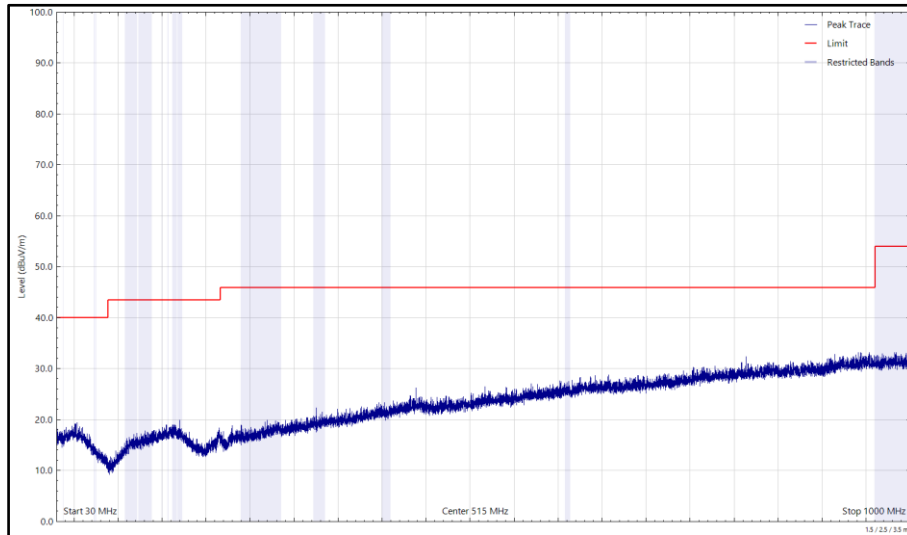

Figure 115 - U-NII-5 - 6175 MHz (CH45), HE20, SU, CDD, Core 0 + Core 1, 30 MHz to 1 GHz, Horizontal (Peak)

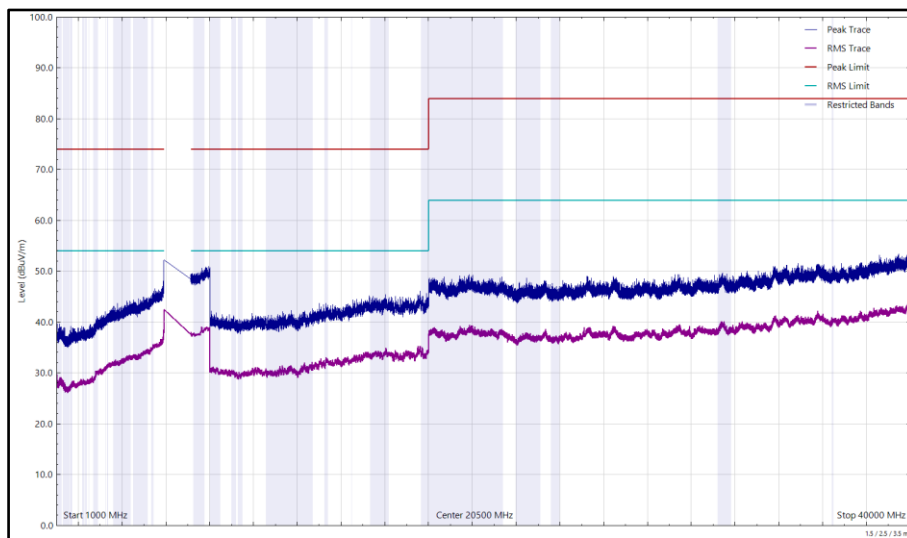

Figure 116 - U-NII-5 - 6175 MHz (CH45), HE20, SU, CDD, Core 0 + Core 1, 1 GHz to 40 GHz, Horizontal

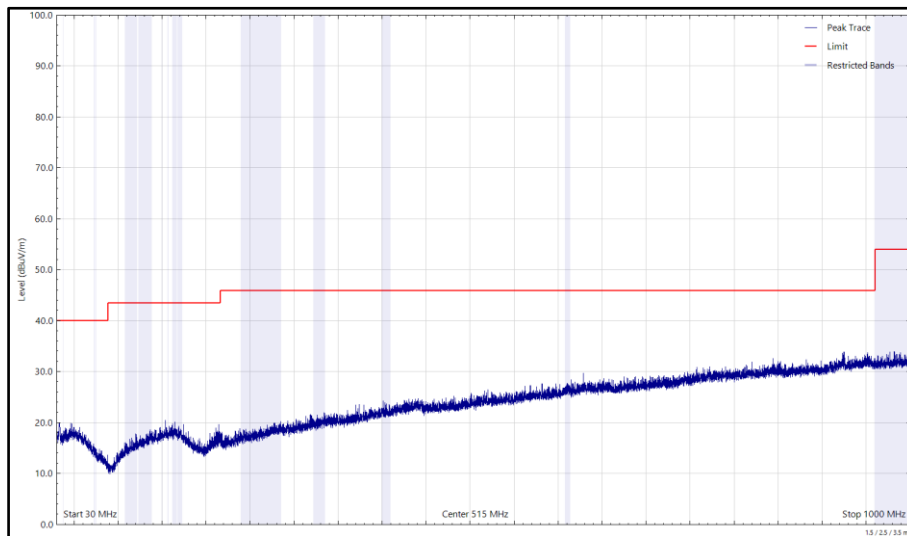

Figure 117 - U-NII-5 - 6175 MHz (CH45), HE20, SU, CDD, Core 0 + Core 1, 30 MHz to 1 GHz, Vertical (Peak)

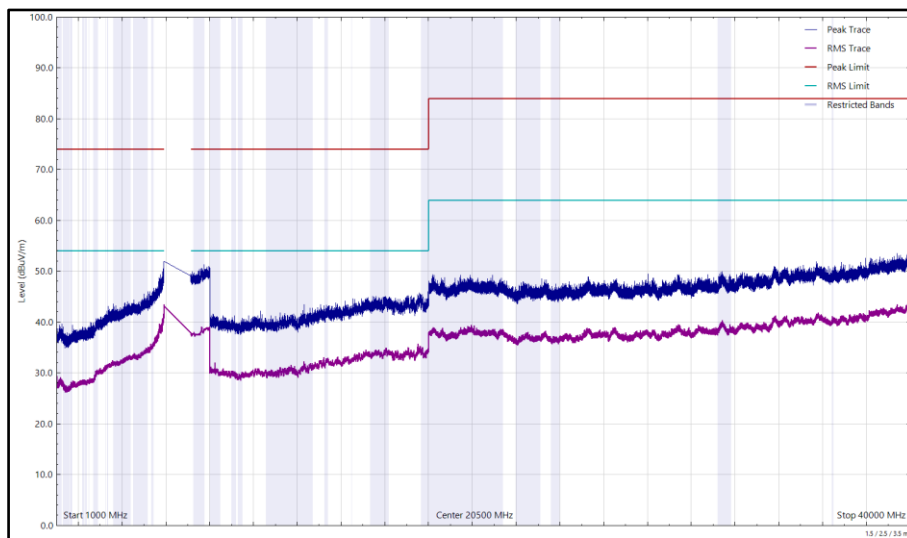

Figure 118 - U-NII-5 - 6175 MHz (CH45), HE20, SU, CDD, Core 0 + Core 1, 1 GHz to 40 GHz, Vertical



Frequency (MHz)	Level (dBuV/m)	Limit (dBuV/m)	Margin (dB)	Detector	Angle (°)	Height (cm)	Polarisation
*							

Table 349 - U-NII-5 - 6415 MHz (CH93), HE20, SU, CDD, Core 0 + Core 1, 1 GHz to 40 GHz

*No emissions found within 10 dB of the limit.

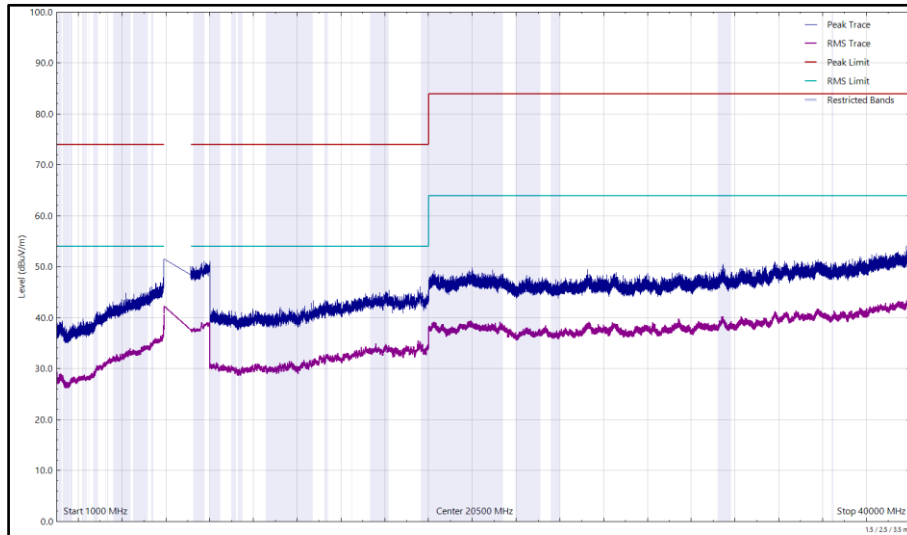

Figure 119 - U-NII-5 - 6415 MHz (CH93), HE20, SU, CDD, Core 0 + Core 1, 1 GHz to 40 GHz, Horizontal

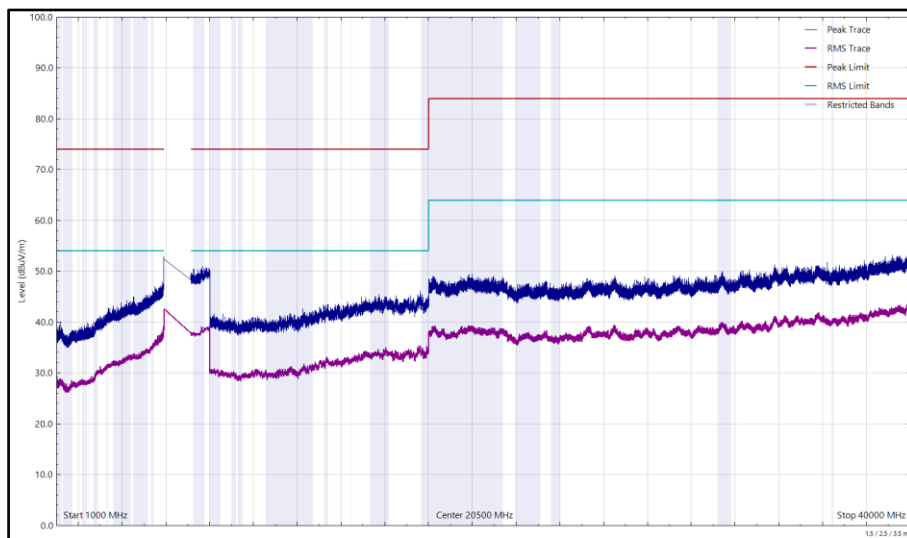

Figure 120 - U-NII-5 - 6415 MHz (CH93), HE20, SU, CDD, Core 0 + Core 1, 1 GHz to 40 GHz, Vertical



Frequency (MHz)	Level (dBuV/m)	Limit (dBuV/m)	Margin (dB)	Detector	Angle (°)	Height (cm)	Polarisation
*							

Table 350 - U-NII-6 - 6435 MHz (CH97), HE20, SU, CDD, Core 0 + Core 1, 1 GHz to 40 GHz

*No emissions found within 10 dB of the limit.

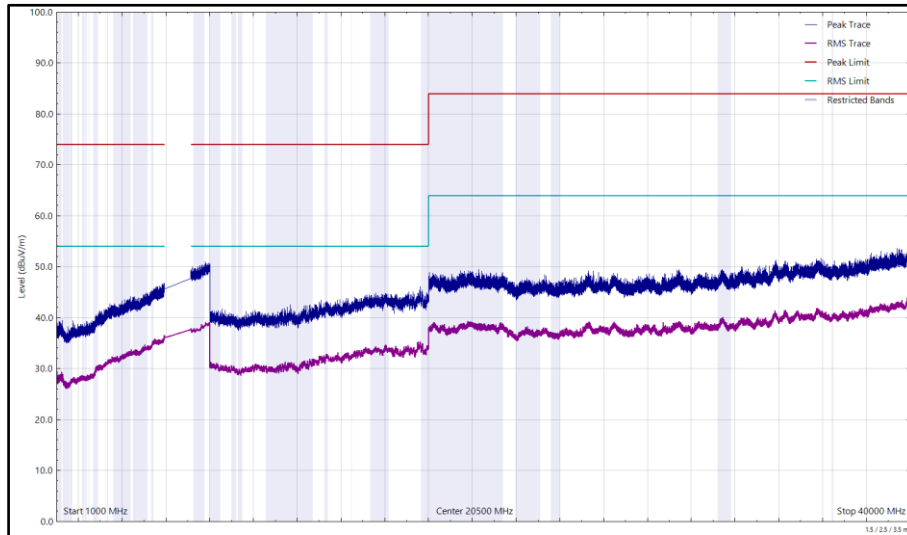

Figure 121 - U-NII-6 - 6435 MHz (CH97), HE20, SU, CDD, Core 0 + Core 1, 1 GHz to 40 GHz, Horizontal

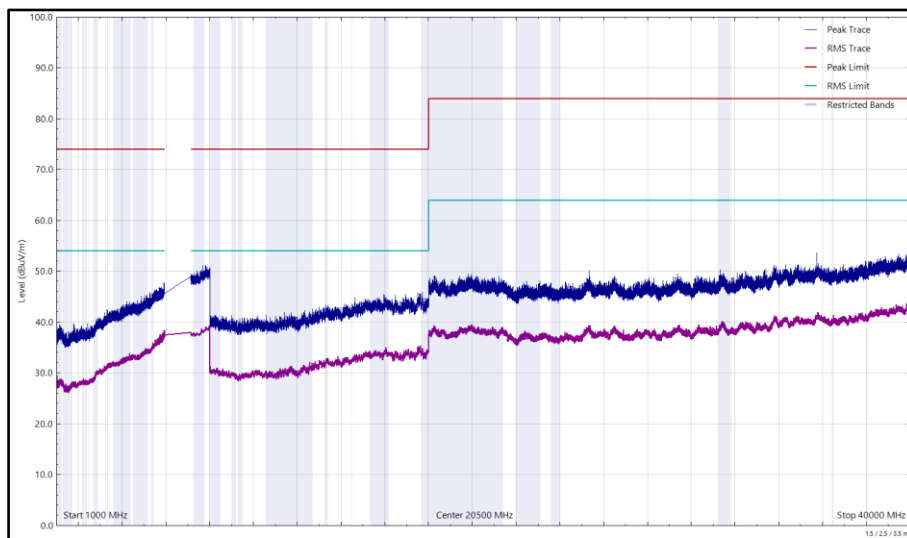

Figure 122 - U-NII-6 - 6435 MHz (CH97), HE20, SU, CDD, Core 0 + Core 1, 1 GHz to 40 GHz, Vertical



Frequency (MHz)	Level (dBuV/m)	Limit (dBuV/m)	Margin (dB)	Detector	Angle (°)	Height (cm)	Polarisation
*							

Table 351 - U-NII-6 - 6475 MHz (CH105), HE20, SU, CDD, Core 0 + Core 1, 30 MHz to 40 GHz

*No emissions found within 10 dB of the limit.

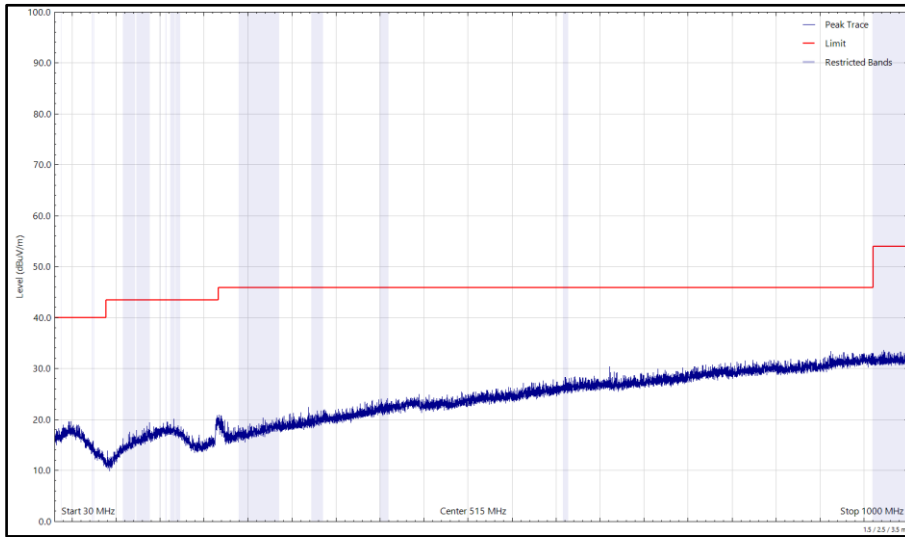

Figure 123 - U-NII-6 - 6475 MHz (CH105), HE20, SU, CDD, Core 0 + Core 1, 30 MHz to 1 GHz, Horizontal (Peak)

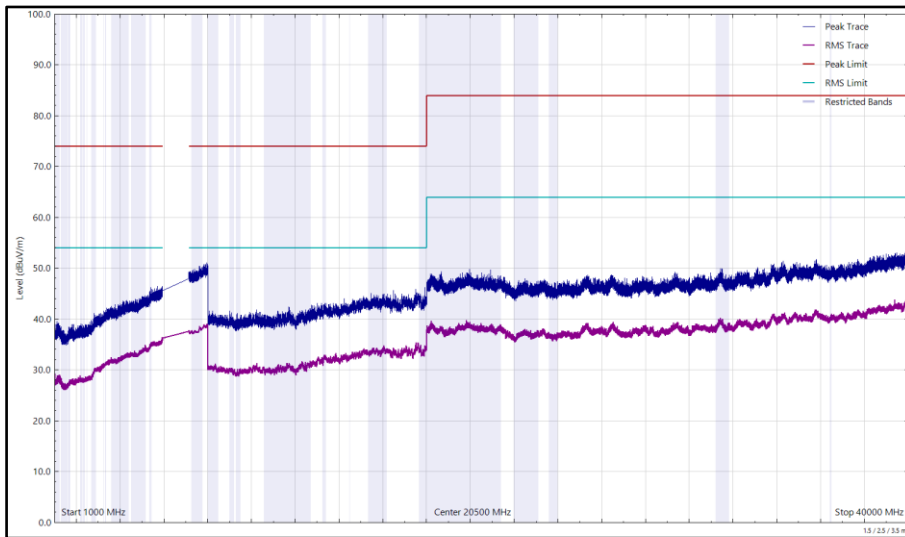

Figure 124 - U-NII-6 - 6475 MHz (CH105), HE20, SU, CDD, Core 0 + Core 1, 1 GHz to 40 GHz, Horizontal

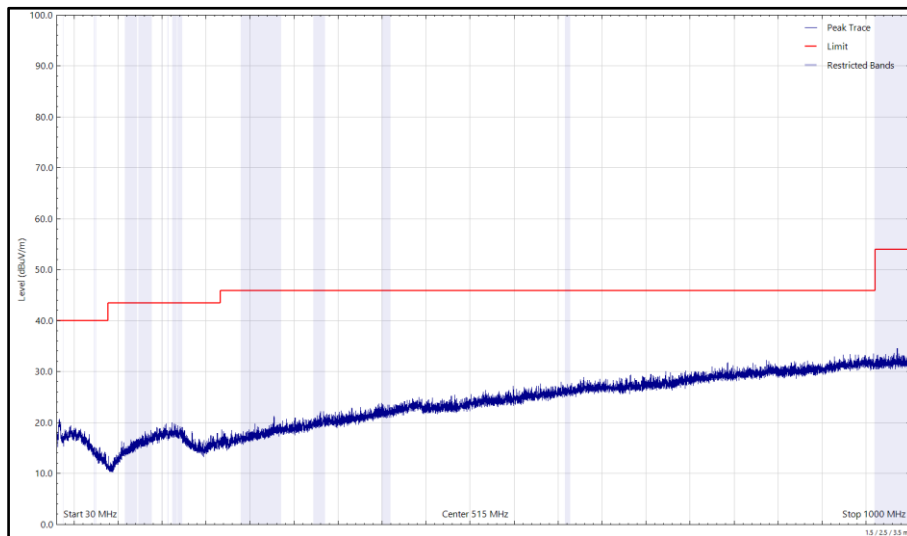

Figure 125 - U-NII-6 - 6475 MHz (CH105), HE20, SU, CDD, Core 0 + Core 1, 30 MHz to 1 GHz, Vertical (Peak)

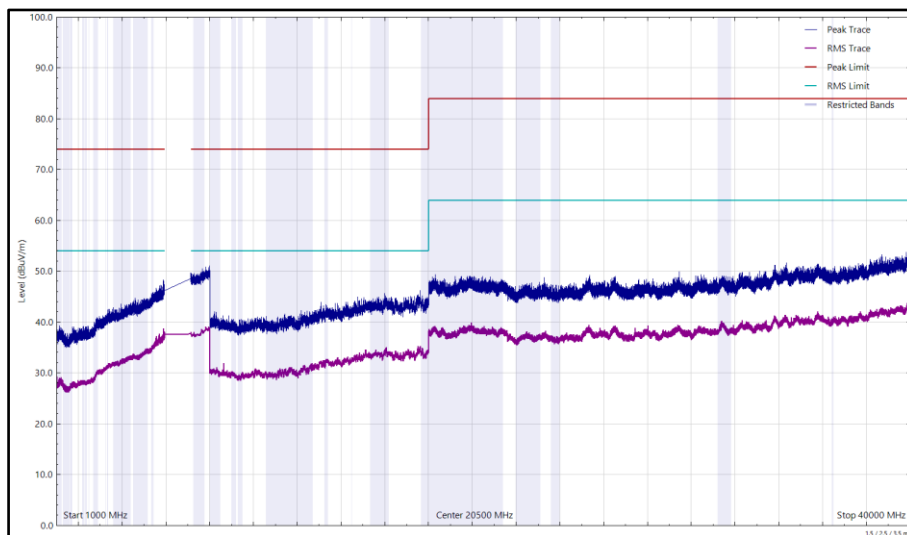

Figure 126 - U-NII-6 - 6475 MHz (CH105), HE20, SU, CDD, Core 0 + Core 1, 1 GHz to 40 GHz, Vertical



Frequency (MHz)	Level (dBuV/m)	Limit (dBuV/m)	Margin (dB)	Detector	Angle (°)	Height (cm)	Polarisation
*							

Table 352 - U-NII-6 - 6515 MHz (CH113), HE20, SU, CDD, Core 0 + Core 1, 1 GHz to 40 GHz

*No emissions found within 10 dB of the limit.

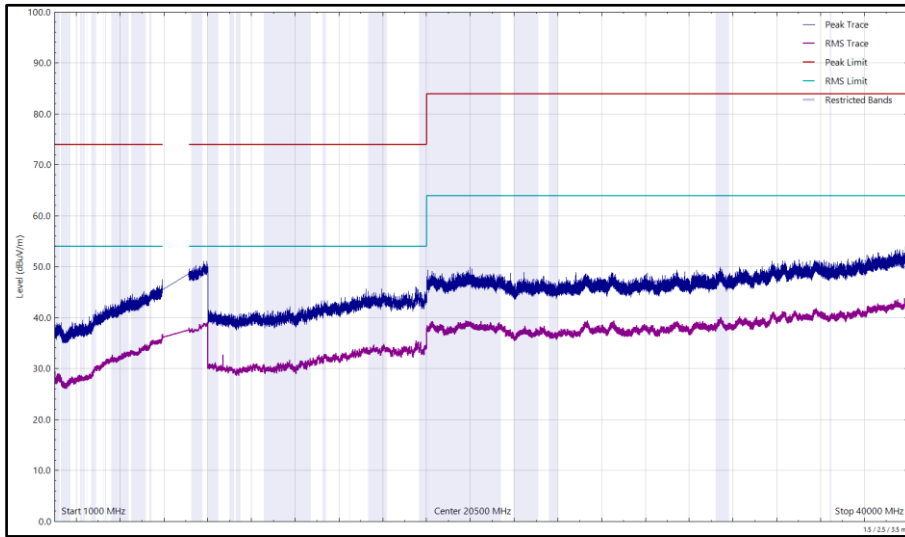

Figure 127 - U-NII-6 - 6515 MHz (CH113), HE20, SU, CDD, Core 0 + Core 1, 1 GHz to 40 GHz, Horizontal

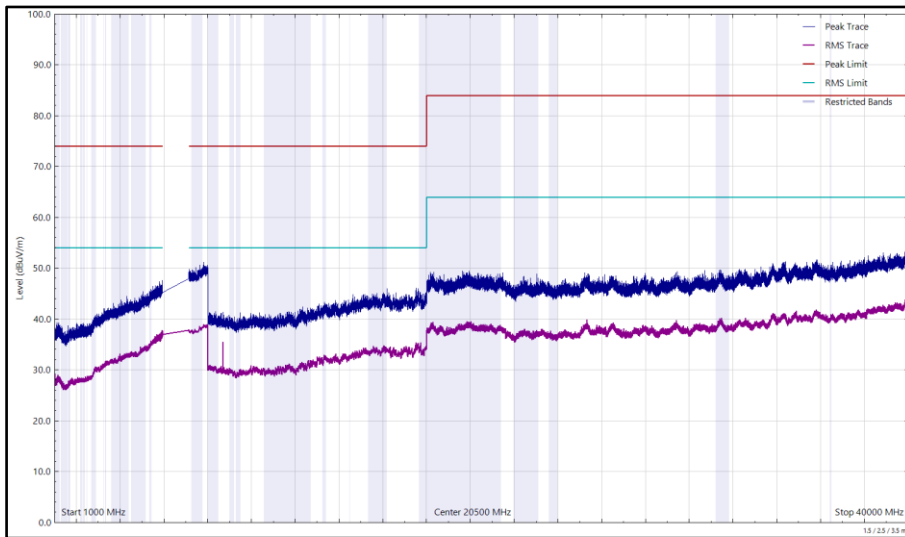

Figure 128 - U-NII-6 - 6515 MHz (CH113), HE20, SU, CDD, Core 0 + Core 1, 1 GHz to 40 GHz, Vertical



Frequency (MHz)	Level (dBuV/m)	Limit (dBuV/m)	Margin (dB)	Detector	Angle (°)	Height (cm)	Polarisation
*							

Table 353 - U-NII-7 - 6535 MHz (CH117), HE20, SU, CDD, Core 0 + Core 1, 1 GHz to 40 GHz

*No emissions found within 10 dB of the limit.

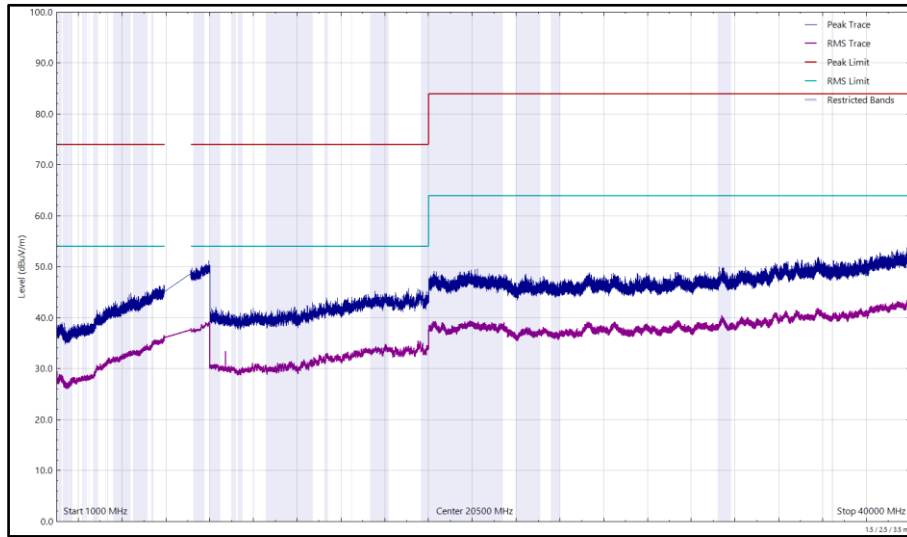

Figure 129 - U-NII-7 - 6535 MHz (CH117), HE20, SU, CDD, Core 0 + Core 1, 1 GHz to 40 GHz, Horizontal

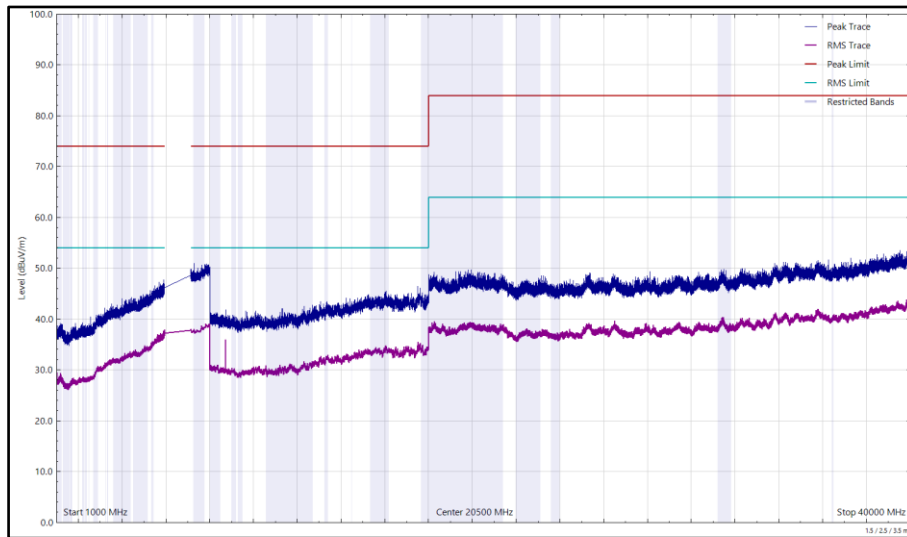

Figure 130 - U-NII-7 - 6535 MHz (CH117), HE20, SU, CDD, Core 0 + Core 1, 1 GHz to 40 GHz, Vertical



Frequency (MHz)	Level (dBuV/m)	Limit (dBuV/m)	Margin (dB)	Detector	Angle (°)	Height (cm)	Polarisation
20086.364	39.22	64.00	-14.78	RMS	268	100	Vertical

Table 354 - U-NII-7 - 6695 MHz (CH149), HE20, SU, CDD, Core 0 + Core 1, 30 MHz to 40 GHz

No other emissions found within 10 dB of the limit.

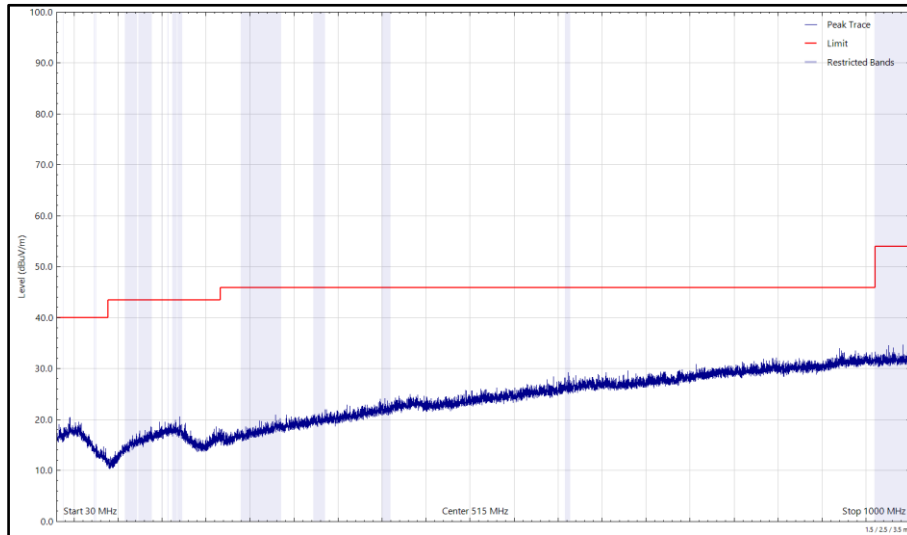

Figure 131 - U-NII-7 - 6695 MHz (CH149), HE20, SU, CDD, Core 0 + Core 1, 30 MHz to 1 GHz, Horizontal (Peak)

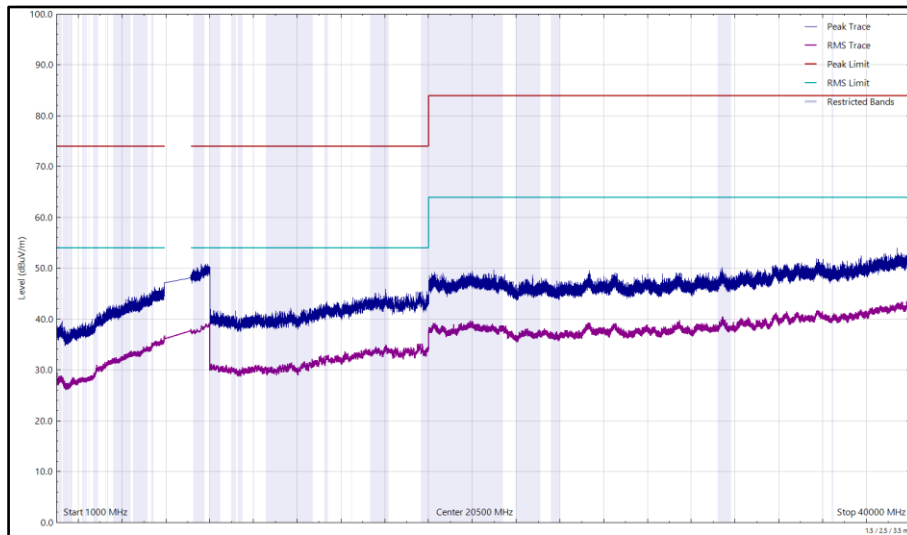

Figure 132 - U-NII-7 - 6695 MHz (CH149), HE20, SU, CDD, Core 0 + Core 1, 1 GHz to 40 GHz, Horizontal

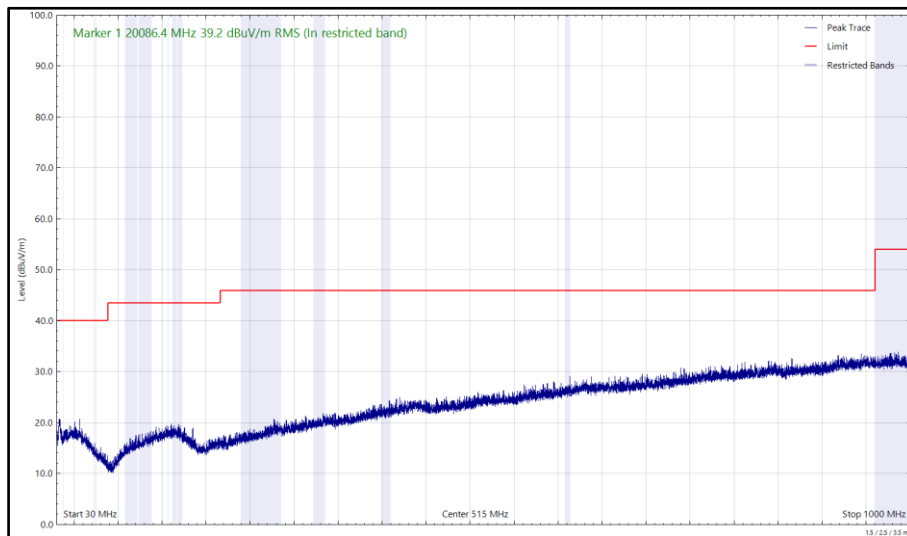

Figure 133 - U-NII-7 - 6695 MHz (CH149), HE20, SU, CDD, Core 0 + Core 1, 30 MHz to 1 GHz, Vertical (Peak)

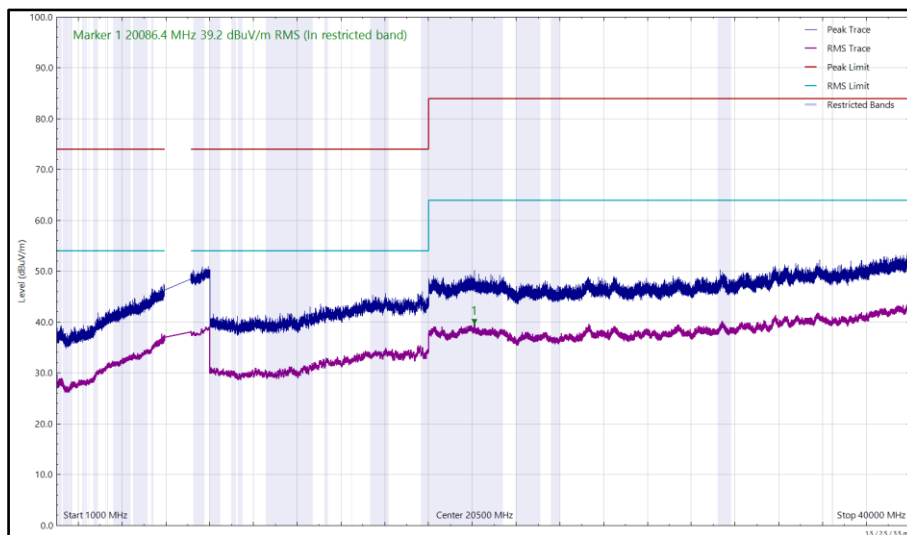

Figure 134 - U-NII-7 - 6695 MHz (CH149), HE20, SU, CDD, Core 0 + Core 1, 1 GHz to 40 GHz, Vertical



Frequency (MHz)	Level (dBuV/m)	Limit (dBuV/m)	Margin (dB)	Detector	Angle (°)	Height (cm)	Polarisation
20565.400	43.78	64.00	-10.22	RMS	273	100	Vertical

Table 355 - U-NII-7 - 6855 MHz (CH181), HE20, SU, CDD, Core 0 + Core 1, 1 GHz to 40 GHz

No other emissions found within 10 dB of the limit.

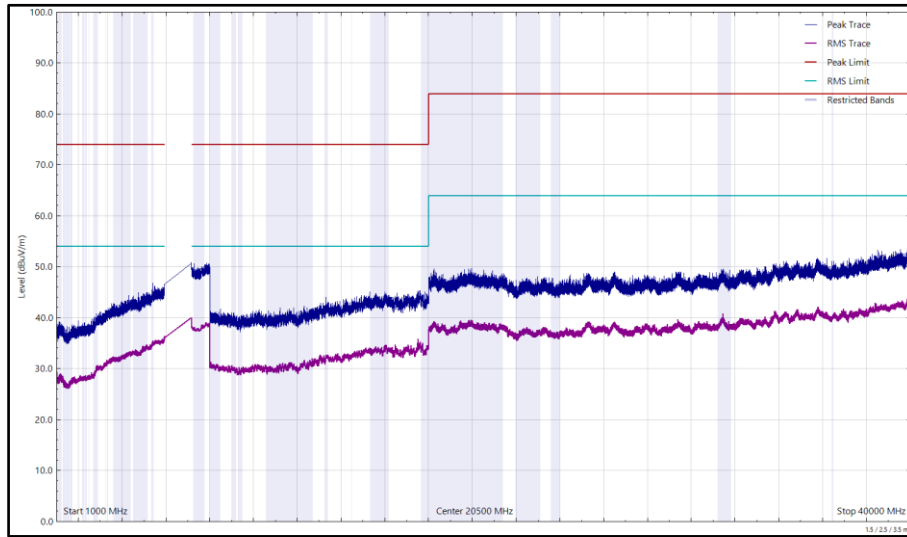

Figure 135 - U-NII-7 - 6855 MHz (CH181), HE20, SU, CDD, Core 0 + Core 1, 1 GHz to 40 GHz, Horizontal

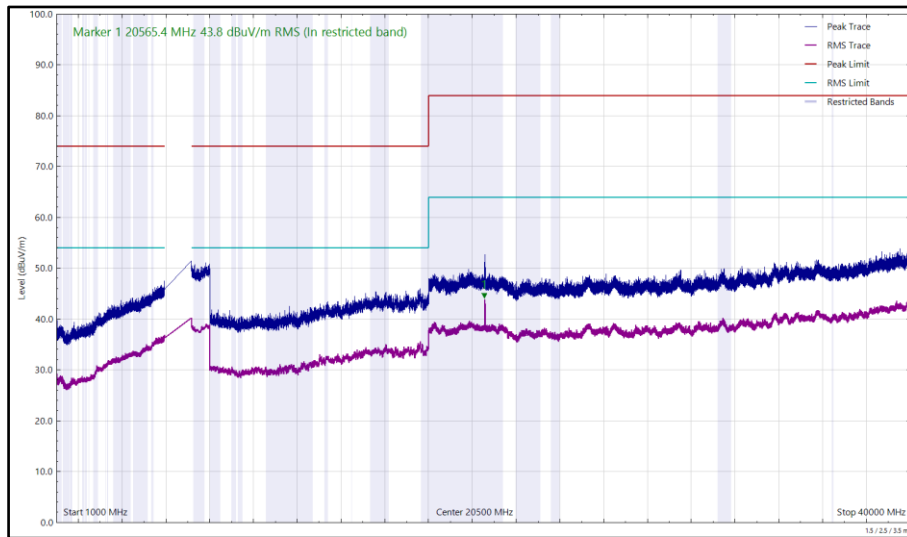

Figure 136 - U-NII-7 - 6855 MHz (CH181), HE20, SU, CDD, Core 0 + Core 1, 1 GHz to 40 GHz, Vertical



Frequency (MHz)	Level (dBuV/m)	Limit (dBuV/m)	Margin (dB)	Detector	Angle (°)	Height (cm)	Polarisation
20683.891	42.63	64.00	-11.37	RMS	284	100	Vertical

Table 356 - U-NII-8 - 6895 MHz (CH189), HE20, SU, CDD, Core 0 + Core 1, 1 GHz to 40 GHz

No other emissions found within 10 dB of the limit.

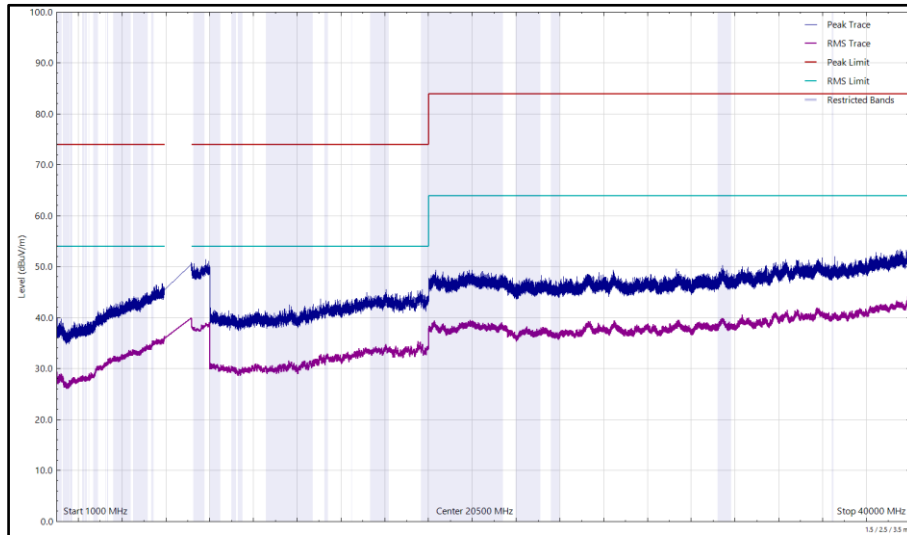

Figure 137 - U-NII-8 - 6895 MHz (CH189), HE20, SU, CDD, Core 0 + Core 1, 1 GHz to 40 GHz, Horizontal

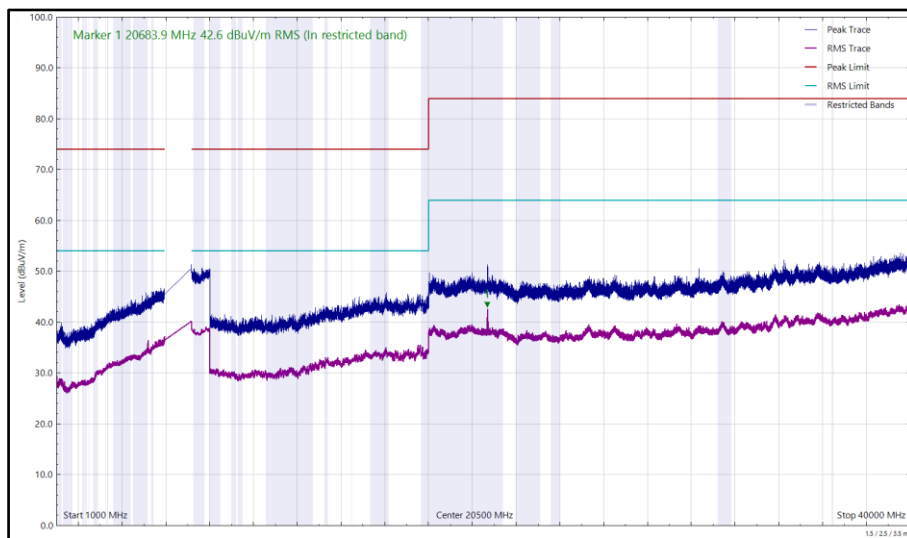

Figure 138 - U-NII-8 - 6895 MHz (CH189), HE20, SU, CDD, Core 0 + Core 1, 1 GHz to 40 GHz, Vertical



Frequency (MHz)	Level (dBuV/m)	Limit (dBuV/m)	Margin (dB)	Detector	Angle (°)	Height (cm)	Polarisation
20984.140	43.72	64.00	-10.28	RMS	266	100	Vertical

Table 357 - U-NII-8 - 6995 MHz (CH209), HE20, SU, CDD, Core 0 + Core 1, 30 MHz to 40 GHz

No other emissions found within 10 dB of the limit.

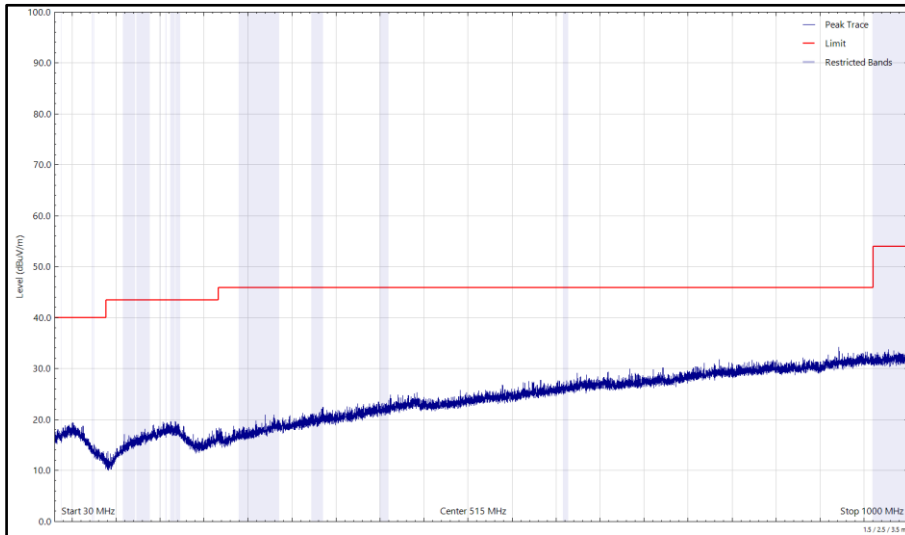

Figure 139 - U-NII-8 - 6995 MHz (CH209), HE20, SU, CDD, Core 0 + Core 1, 30 MHz to 1 GHz, Horizontal (Peak)

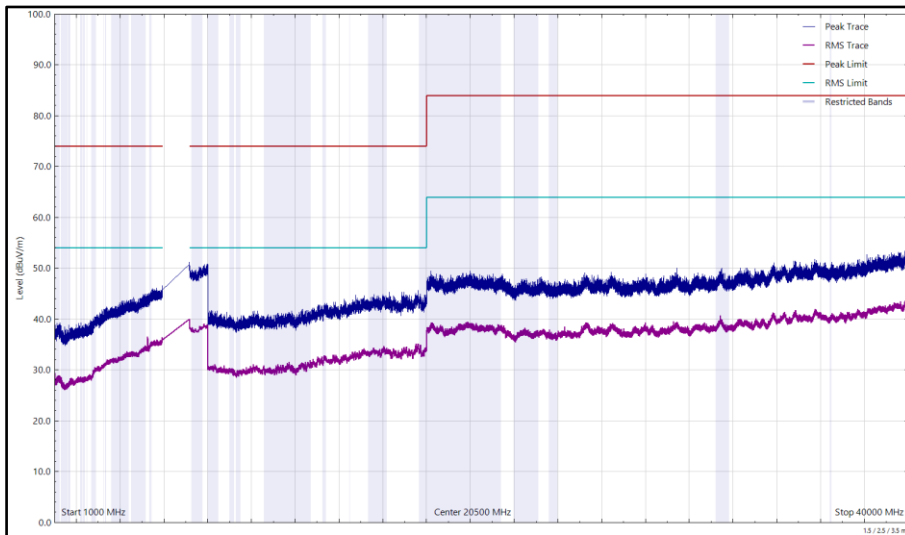

Figure 140 - U-NII-8 - 6995 MHz (CH209), HE20, SU, CDD, Core 0 + Core 1, 1 GHz to 40 GHz, Horizontal

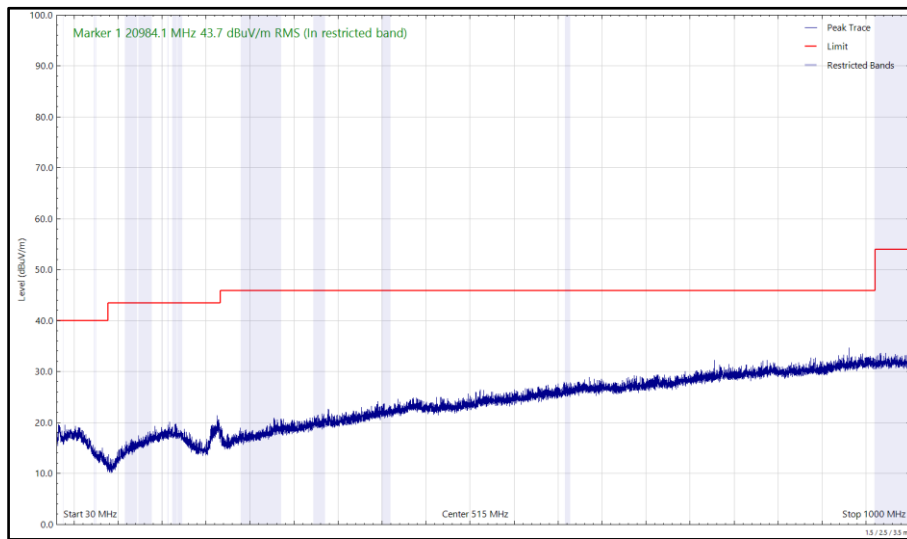

Figure 141 - U-NII-8 - 6995 MHz (CH209), HE20, SU, CDD, Core 0 + Core 1, 30 MHz to 1 GHz, Vertical (Peak)

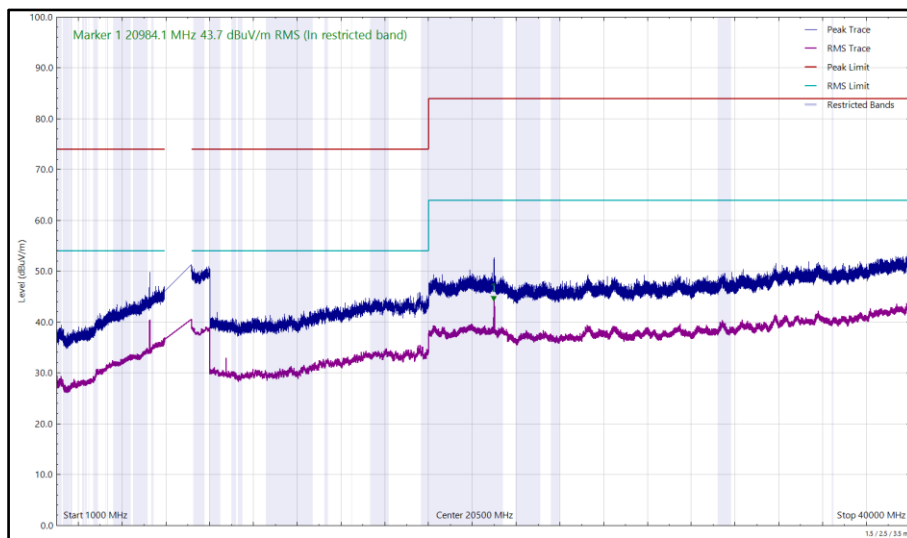

Figure 142 - U-NII-8 - 6995 MHz (CH209), HE20, SU, CDD, Core 0 + Core 1, 1 GHz to 40 GHz, Vertical



Frequency (MHz)	Level (dBuV/m)	Limit (dBuV/m)	Margin (dB)	Detector	Angle (°)	Height (cm)	Polarisation
21344.710	40.17	64.00	-13.83	RMS	270	100	Vertical

Table 358 - U-NII-8 - 7115 MHz (CH233), HE20, SU, CDD, Core 0 + Core 1, 1 GHz to 40 GHz

No other emissions found within 10 dB of the limit.

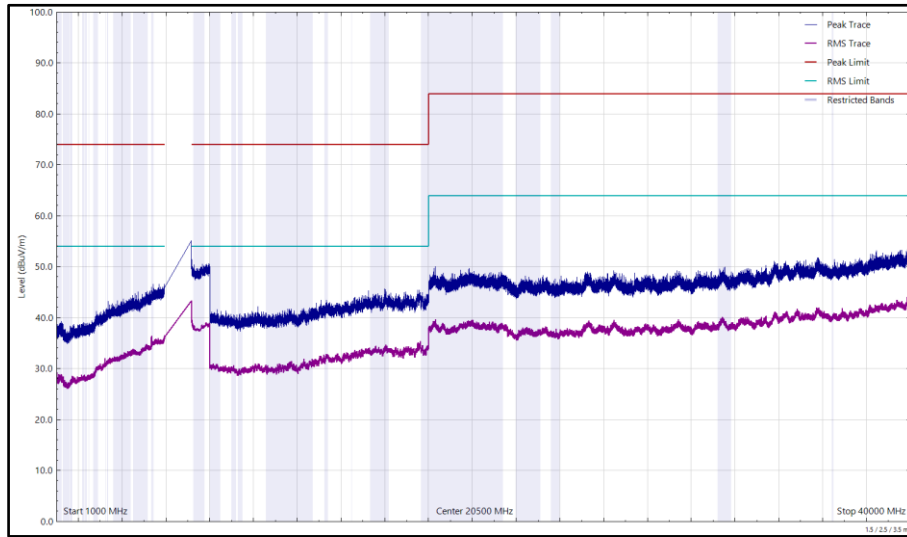

Figure 143 - U-NII-8 - 7115 MHz (CH233), HE20, SU, CDD, Core 0 + Core 1, 1 GHz to 40 GHz, Horizontal

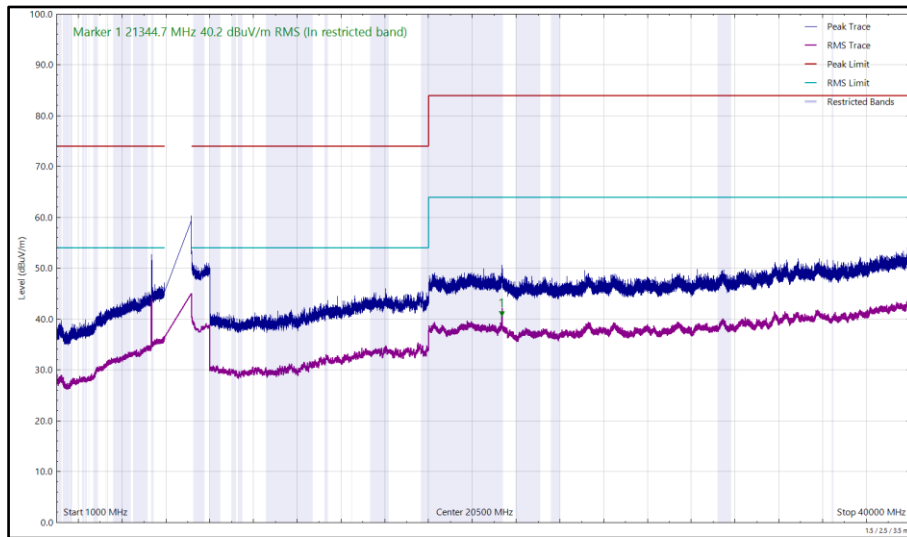

Figure 144 - U-NII-8 - 7115 MHz (CH233), HE20, SU, CDD, Core 0 + Core 1, 1 GHz to 40 GHz, Vertical



FCC 47 CFR Part 15, Limit Clause 15.407(b)(5) and 15.209

Emissions not falling within the restricted bands listed in 15.205:

For transmitters operating within the 5.925–7.125 GHz band: Any emissions outside of the 5.925–7.125 GHz band must not exceed an e.i.r.p. of -27 dBm/MHz.

Unwanted emissions below 1 GHz must comply with the general field strength limits set forth in 15.209.

Emissions within the restricted bands listed in FCC 47 CFR Part 15.205:

Frequency (MHz)	Field Strength ($\mu\text{V}/\text{m}$) at 3m	Field Strength Limit ($\text{dB}\mu\text{V}/\text{m}$) at 3m
30 to 88	100	40.00
88 to 216	150	43.52
216 to 960	200	46.02
Above 960	500	53.98

Table 359 - Radiated Emissions Limit Table (FCC)

ISED RSS-248, Limit Clause 4.7.2(a) and ISED RSS-GEN, Limit Clause 8.9

Emissions not falling within the restricted bands listed in ISED RSS-GEN, Clause 8.10:

Any emissions outside of the 5925-7125 MHz band shall not exceed -27 dBm/MHz e.i.r.p.

Any emissions below 1000 MHz shall meet the general field strength limits specified in RSS-Gen

Emissions falling within the restricted bands listed in ISED RSS-GEN, Clause 8.10:

Frequency (MHz)	Field Strength ($\mu\text{V}/\text{m}$) at 3m	Field Strength Limit ($\text{dB}\mu\text{V}/\text{m}$) at 3m
30 to 88	100	40.00
88 to 216	150	43.52
216 to 960	200	46.02
Above 960	500	53.98

Table 360 - Radiated Emissions Limit Table (ISED)



2.5.8 Test Location and Test Equipment Used

This test was carried out in RF Chamber 15.

Instrument	Manufacturer	Type No.	TE No.	Calibration Period (months)	Calibration Expiry Date
Emissions Software	TUV SUD	EmX V3.1.10	5125	-	Software
EMI Test Receiver	Rohde & Schwarz	ESW44	5911	12	24-Apr-2023
Cable (K Type 2m)	Junkosha	MWX241-02000KMSKMS/B	5937	12	14-May-2023
DRG Horn Antenna (7.5-18GHz)	Schwarzbeck	HWRD750	5939	12	29-May-2023
TRILOG Super Broadband Test Antenna	Schwarzbeck	VULB 9168	5944	24	03-Feb-2024
1500W (300V 12A) AC Power Supply	iTech	IT7324	5956	-	O/P Mon
5m Semi-Anechoic Chamber (Dual-Axis)	Albatross Projects	RF Chamber 15	5963	36	28-Apr-2025
Compact Antenna Mast	Maturo Gmbh	CAM4.0-P	5964	-	TU
Mast & Turntable Controller	Maturo Gmbh	FCU3.0	5966	-	TU
Tilt Antenna Mast	Maturo Gmbh	BAM4.5-P	5967	-	TU
Turntable	Maturo Gmbh	TT1.5SI	5968	-	TU
Cable (SMA to SMA 1m)	Junkosha	MWX221-01000AMSAMS/A	5996	12	06-Jun-2023
Cable (N to N 1m)	Junkosha	MWX221-01000NMSNMS/B	5999	12	05-Jun-2023
Cable (N to N 7m)	Junkosha	MWX221-07000NMSNMS/B	6005	12	05-Jun-2023
Cable (N to N 8m)	Junkosha	MWX221-08000NMSNMS/A	6006	12	05-Jun-2023
Cable (SMA to SMA 1m)	Junkosha	MWX221-01000AMSAMS/A	6007	12	06-Jun-2023
Cable (SMA to SMA 6.5m)	Junkosha	MWX221-06500AMSAMS/B	6014	12	07-Jun-2023
Horn Antenna (1-10 GHz)	Schwarzbeck	BBHA9120B	6140	12	21-Jun-2023
Digital Multimeter	Fluke	115	6147	12	16-Jun-2023
Humidity & Temperature meter	R.S Components	1364	6150	12	17-Jun-2023
Double Ridge Active Horn Antenna (18-40 GHz)	Com-Power	AHA-840	6187	24	02-Jun-2024
SAC Switch Unit	TUV SUD	TUV_SSU_001	6191	12	12-Dec-2023
8 GHz Highpass Filter	Wainwright	WHKX 7150 8000 18000 50SS	6195	12	15-Jul-2023
Pre Amp 8 - 18 GHz	Wright Technologies	APS06 0061	6198	12	19-Jul-2023
Attenuator 4dB	Pasternack	PE7074-4	6203	24	16-Jul-2024
Cable (SMA to SMA 20cm)	TUV SUD	MH-FH 8-18	6214	12	25-Jul-2023

Table 361

TU - Traceability Unscheduled
 O/P Mon - Output Monitored using calibrated equipment



2.6 Unwanted Emissions within the 5925-7125 MHz band

2.6.1 Specification Reference

FCC 47 CFR Part 15E, Clause 15.407 (b)
ISED RSS-248, Clause 4.7
ISED RSS-GEN, Clause 6.13

2.6.2 Equipment Under Test and Modification State

A2901, S/N: PXC62W93WY - Modification State 0
A2901, S/N: XJCFQ12HP6 - Modification State 0

2.6.3 Date of Test

01-April-2023 to 07-April-2023

2.6.4 Test Method

This test was performed in accordance with KDB 987594 D02, clause J.

2.6.5 Environmental Conditions

Ambient Temperature	21.2 - 22.3 °C
Relative Humidity	35.9 - 41.1 %



2.6.6 Test Results

6 GHz WLAN

SISO

Protocol	Unwanted Emissions Within the RLAN Band	
	Margin (dB)	Frequency (MHz)
802.11a	9.38	7174.700
802.11ax HE20 SU	6.96	7065.200
802.11ax HE40 SU	11.48	6557.600
802.11ax HE80 SU	11.14	6509.320
802.11ax HE160 SU	9.85	6586.000

Table 362 - Unwanted Emissions Within the RLAN Band Summary Results

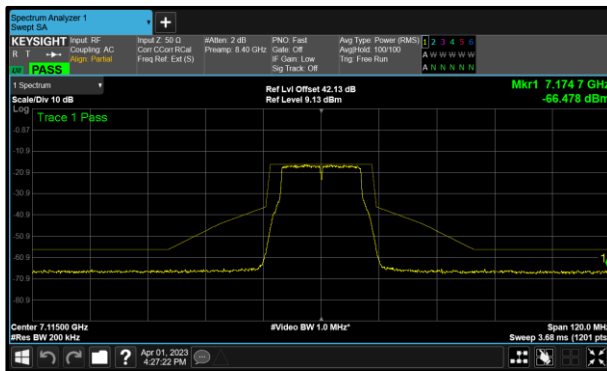

Figure 145 - A (Core 0) 802.11a 7115 MHz (CH233)

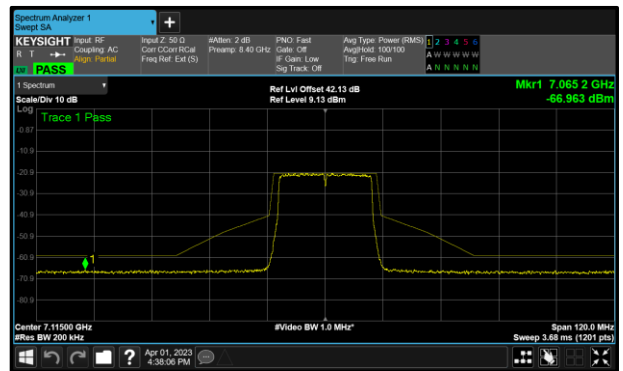

Figure 146 - A (Core 0) 802.11ax HE20 SU 7115 MHz (CH233)

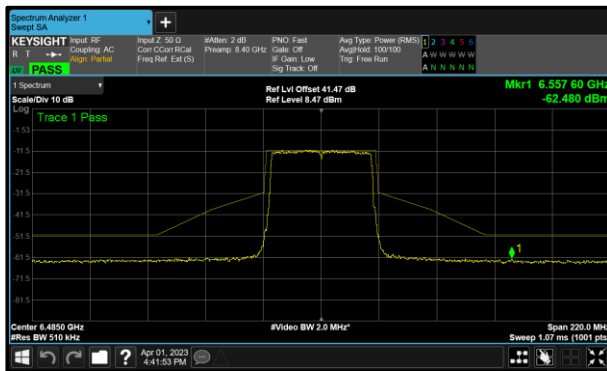

Figure 147 - A (Core 0) 802.11ax HE40 SU 6485 MHz (CH107)

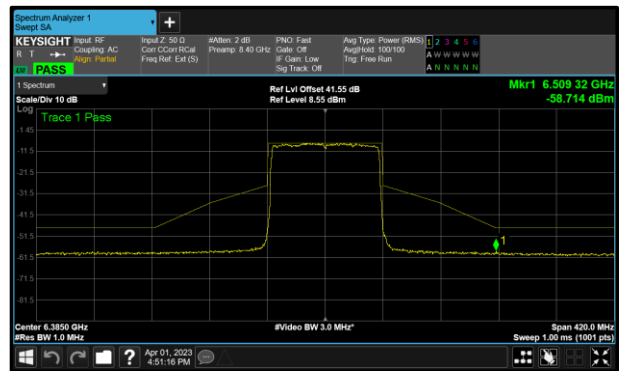

Figure 148 - A (Core 0) 802.11ax HE80 SU 6385 MHz (CH87)

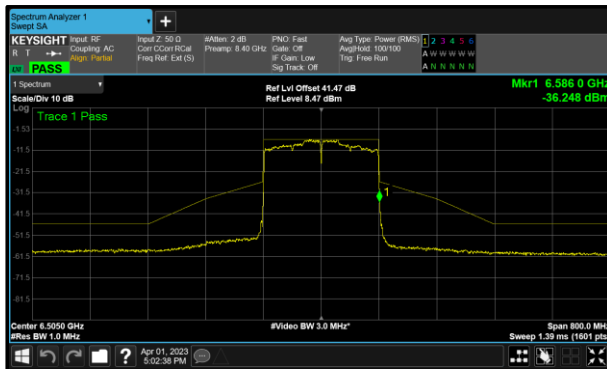

Figure 149 - A (Core 0) 802.11ax HE160
SU 6505 MHz (CH11)



Test Configuration			
Frequency Range:	5925 MHz – 7125 MHz	Band:	U-NII-5 to U-NII-8
Limit Clause(s):	15.407(b)	Test Method(s):	KDB 987594 clause j

DUT Configuration			
Mode:	802.11a	Duty Cycle (%):	-
Data Rate:	12 Mbps	DCCF (dB):	-
Antenna Configuration:	SISO	Peak Antenna Gain (dBi):	-
Active Port(s):	A (Core 0)	Active Chain Id(s):	0

Test Frequency (MHz)	Unwanted Emissions Within the RLAN Band Margin (dB)			
	A	B	C	D
5955	14.22	-	-	-
6175	13.77	-	-	-
6415	12.94	-	-	-
6435	12.60	-	-	-
6475	12.17	-	-	-
6515	12.37	-	-	-
6535	13.05	-	-	-
6695	13.17	-	-	-
6855	12.94	-	-	-
6875	12.43	-	-	-
6895	12.47	-	-	-
6995	13.14	-	-	-
7115	9.38	-	-	-

Table 363 - Unwanted Emissions Within the Band Results



Test Configuration			
Frequency Range:	5925 MHz – 7125 MHz	Band:	U-NII-5 to U-NII-8
Limit Clause(s):	15.407(b)	Test Method(s):	KDB 987594 clause j

DUT Configuration			
Mode:	802.11ax HE20 SU	Duty Cycle (%):	-
Modulation Coding Scheme:	MCS2x1	DCCF (dB):	-
Antenna Configuration:	SISO	Peak Antenna Gain (dBi):	-
Active Port(s):	A (Core 0)	Active Chain Id(s):	0

Test Frequency (MHz)	Unwanted Emissions Within the RLAN Band Margin (dB)			
	A	B	C	D
5955	14.47	-	-	-
6175	14.30	-	-	-
6415	12.98	-	-	-
6435	12.26	-	-	-
6475	12.19	-	-	-
6515	12.26	-	-	-
6535	13.07	-	-	-
6695	12.18	-	-	-
6855	12.73	-	-	-
6875	12.49	-	-	-
6895	13.02	-	-	-
6995	12.79	-	-	-
7115	6.96	-	-	-

Table 364 - Unwanted Emissions Within the Band Results



Test Configuration			
Frequency Range:	5925 MHz – 7125 MHz	Band:	U-NII-5 to U-NII-8
Limit Clause(s):	15.407(b)	Test Method(s):	KDB 987594 clause j

DUT Configuration			
Mode:	802.11ax HE40 SU	Duty Cycle (%):	-
Modulation Coding Scheme:	MCS2x1	DCCF (dB):	-
Antenna Configuration:	SISO	Peak Antenna Gain (dBi):	-
Active Port(s):	A (Core 0)	Active Chain Id(s):	0

Test Frequency (MHz)	Unwanted Emissions Within the RLAN Band Margin (dB)			
	A	B	C	D
5965	12.30	-	-	-
6165	11.76	-	-	-
6405	12.02	-	-	-
6445	11.64	-	-	-
6485	11.48	-	-	-
6525	11.72	-	-	-
6565	12.30	-	-	-
6685	11.89	-	-	-
6845	12.23	-	-	-
6885	11.73	-	-	-
6925	12.12	-	-	-
7005	12.88	-	-	-
7085	11.77	-	-	-

Table 365 - Unwanted Emissions Within the Band Results



Test Configuration			
Frequency Range:	5925 MHz – 7125 MHz	Band:	U-NII-5 to U-NII-8
Limit Clause(s):	15.407(b)	Test Method(s):	KDB 987594 clause j

DUT Configuration			
Mode:	802.11ax HE80 SU	Duty Cycle (%):	-
Modulation Coding Scheme:	MCS2x1	DCCF (dB):	-
Antenna Configuration:	SISO	Peak Antenna Gain (dBi):	-
Active Port(s):	A (Core 0)	Active Chain Id(s):	0

Test Frequency (MHz)	Unwanted Emissions Within the RLAN Band Margin (dB)			
	A	B	C	D
5985	12.42	-	-	-
6145	12.85	-	-	-
6385	11.14	-	-	-
6465	11.65	-	-	-
6545	11.34	-	-	-
6625	11.48	-	-	-
6705	11.75	-	-	-
6785	11.33	-	-	-
6865	11.41	-	-	-
6945	11.97	-	-	-
7025	12.04	-	-	-

Table 366 - Unwanted Emissions Within the Band Results



Test Configuration			
Frequency Range:	5925 MHz – 7125 MHz	Band:	U-NII-5 to U-NII-8
Limit Clause(s):	15.407(b)	Test Method(s):	KDB 987594 clause j

DUT Configuration			
Mode:	802.11ax HE160 SU	Duty Cycle (%):	-
Modulation Coding Scheme:	MCS2x1	DCCF (dB):	-
Antenna Configuration:	SISO	Peak Antenna Gain (dBi):	-
Active Port(s):	A (Core 0)	Active Chain Id(s):	0

Test Frequency (MHz)	Unwanted Emissions Within the RLAN Band Margin (dB)			
	A	B	C	D
6025	11.43	-	-	-
6185	12.07	-	-	-
6345	11.87	-	-	-
6505	9.85	-	-	-
6665	11.65	-	-	-
6825	10.85	-	-	-
6985	12.87	-	-	-

Table 367 - Unwanted Emissions Within the Band Results



Protocol	Unwanted Emissions Within the RLAN Band	
	Margin (dB)	Frequency (MHz)
802.11ax HE20 RU106	10.98	6946.300
802.11ax HE20 RU26	11.81	6476.000
802.11ax HE20 RU52	11.72	6469.200

Table 368 - Unwanted Emissions Within the RLAN Band Summary Results

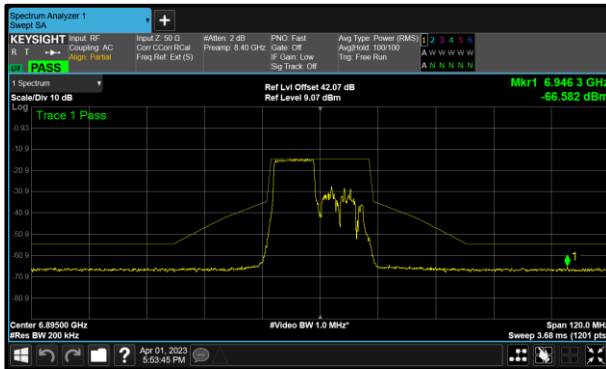

Figure 150 - A (Core 0) 802.11ax HE20 RU106 6895 MHz (CH189)

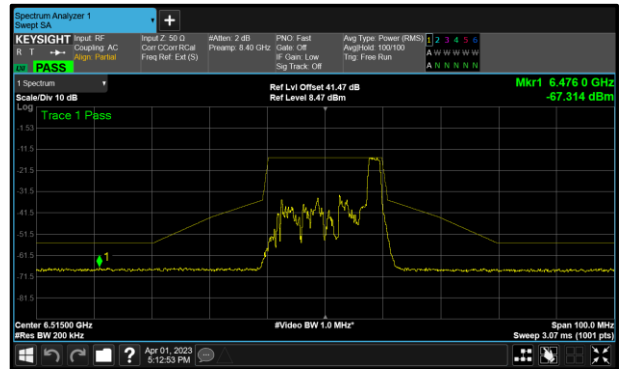

Figure 151 - A (Core 0) 802.11ax HE20 RU26 6515 MHz (CH113)

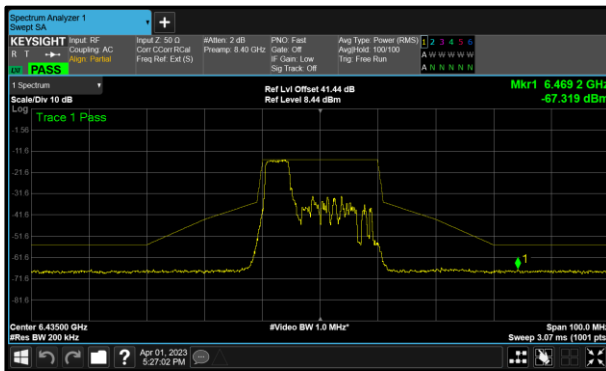

Figure 152 - A (Core 0) 802.11ax HE20 RU52 6435 MHz (CH97)



Test Configuration			
Frequency Range:	5925 MHz – 7125 MHz	Band:	U-NII-5 to U-NII-8
Limit Clause(s):	15.407(b)	Test Method(s):	KDB 987594 clause j

DUT Configuration			
Mode:	802.11ax HE20 RU26	Duty Cycle (%):	-
Modulation Coding Scheme:	MCS2x1	DCCF (dB):	-
Antenna Configuration:	SISO	Peak Antenna Gain (dBi):	-
Active Port(s):	A (Core 0)	Active Chain Id(s):	0

Test Frequency (MHz)	Unwanted Emissions Within the RLAN Band Margin (dB)			
	A	B	C	D
5955 (RU26.0)	15.27	-	-	-
6175 (RU26.0)	14.02	-	-	-
6415 (RU26.8)	12.45	-	-	-
6435 (RU26.0)	12.15	-	-	-
6475 (RU26.0)	11.95	-	-	-
6515 (RU26.8)	11.81	-	-	-
6535 (RU26.0)	13.48	-	-	-
6695 (RU26.0)	12.81	-	-	-
6855 (RU26.8)	12.83	-	-	-
6875 (RU26.3)	12.79	-	-	-
6875 (RU26.5)	12.11	-	-	-
6895 (RU26.0)	12.69	-	-	-
6995 (RU26.0)	12.55	-	-	-
7095 (RU26.8)	12.87	-	-	-

Table 369 - Unwanted Emissions Within the Band Results



Test Configuration			
Frequency Range:	5925 MHz – 7125 MHz	Band:	U-NII-5 to U-NII-8
Limit Clause(s):	15.407(b)	Test Method(s):	KDB 987594 clause j

DUT Configuration			
Mode:	802.11ax HE20 RU52	Duty Cycle (%):	-
Modulation Coding Scheme:	MCS2x1	DCCF (dB):	-
Antenna Configuration:	SISO	Peak Antenna Gain (dBi):	-
Active Port(s):	A (Core 0)	Active Chain Id(s):	0

Test Frequency (MHz)	Unwanted Emissions Within the RLAN Band Margin (dB)			
	A	B	C	D
5955 (RU52.37)	15.04	-	-	-
6175 (RU52.37)	14.59	-	-	-
6415 (RU52.40)	12.89	-	-	-
6435 (RU52.37)	11.72	-	-	-
6475 (RU52.37)	12.19	-	-	-
6515 (RU52.40)	12.40	-	-	-
6535 (RU52.37)	13.20	-	-	-
6695 (RU52.37)	13.32	-	-	-
6855 (RU52.40)	12.64	-	-	-
6875 (RU52.38)	12.87	-	-	-
6875 (RU52.39)	12.55	-	-	-
6895 (RU52.37)	13.17	-	-	-
6995 (RU52.37)	12.85	-	-	-
7095 (RU52.40)	12.96	-	-	-

Table 370 - Unwanted Emissions Within the Band Results



Test Configuration			
Frequency Range:	5925 MHz – 7125 MHz	Band:	U-NII-5 to U-NII-8
Limit Clause(s):	15.407(b)	Test Method(s):	KDB 987594 clause j

DUT Configuration			
Mode:	802.11ax HE20 RU106	Duty Cycle (%):	-
Modulation Coding Scheme:	MCS2x1	DCCF (dB):	-
Antenna Configuration:	SISO	Peak Antenna Gain (dBi):	-
Active Port(s):	A (Core 0)	Active Chain Id(s):	0

Test Frequency (MHz)	Unwanted Emissions Within the RLAN Band Margin (dB)			
	A	B	C	D
5955 (RU106.53)	14.91	-	-	-
6175 (RU106.53)	14.79	-	-	-
6415 (RU106.54)	12.92	-	-	-
6435 (RU106.53)	12.51	-	-	-
6475 (RU106.53)	12.54	-	-	-
6515 (RU106.54)	12.43	-	-	-
6535 (RU106.53)	13.08	-	-	-
6695 (RU106.53)	12.84	-	-	-
6855 (RU106.54)	12.48	-	-	-
6875 (RU106.53)	12.53	-	-	-
6875 (RU106.54)	11.90	-	-	-
6895 (RU106.53)	10.98	-	-	-
6995 (RU106.53)	12.37	-	-	-
7095 (RU106.54)	13.02	-	-	-

Table 371 - Unwanted Emissions Within the Band Results



MIMO CDD

Protocol	Unwanted Emissions Within the RLAN Band	
	Margin (dB)	Frequency (MHz)
802.11ax HE20 SU	6.80	7078.400
802.11ax HE40 SU	5.57	6919.640
802.11ax HE80 SU	6.74	6739.800
802.11ax HE160 SU	8.01	6690.500

Table 372 - Unwanted Emissions Within the RLAN Band Summary Results

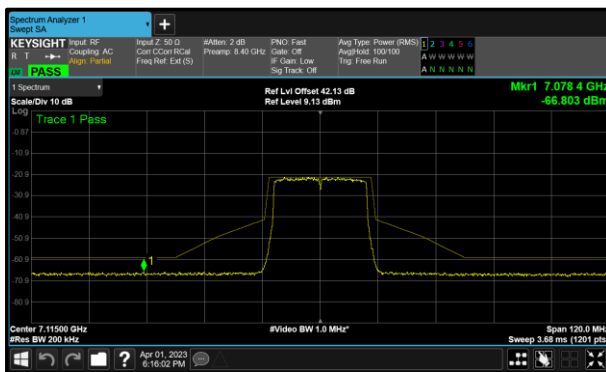

Figure 153 - A (Core 0) 802.11ax HE20 SU 7115 MHz (CH233)

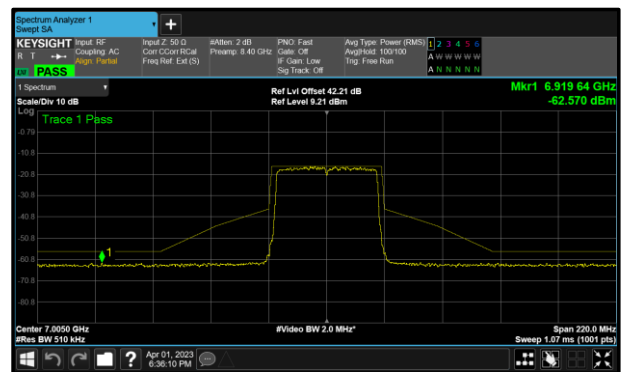

Figure 154 - A (Core 0) 802.11ax HE40 SU 7005 MHz (CH211)

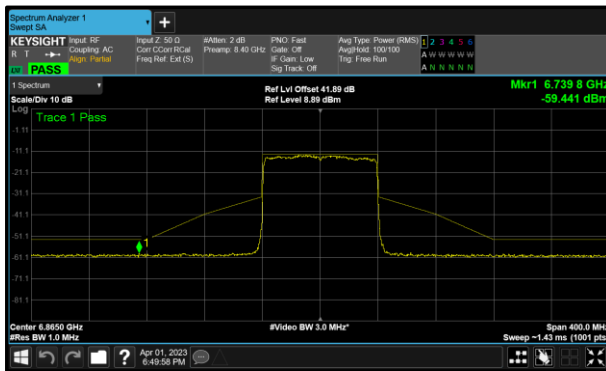

Figure 155 - A (Core 0) 802.11ax HE80 SU 6865 MHz (CH183)

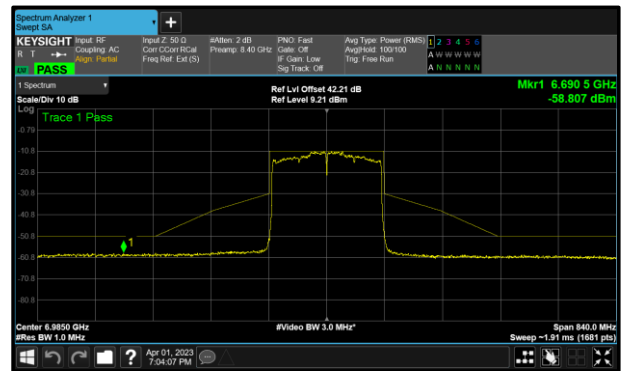

Figure 156 - A (Core 0) 802.11ax HE160 SU 6985 MHz (CH207)



Test Configuration			
Frequency Range:	5925 MHz – 7125 MHz	Band:	U-NII-5 to U-NII-8
Limit Clause(s):	15.407(b)	Test Method(s):	KDB 987594 clause j

DUT Configuration			
Mode:	802.11ax HE20 SU	Duty Cycle (%):	-
Modulation Coding Scheme:	MCS2x1	DCCF (dB):	-
Antenna Configuration:	MIMO CDD	Peak Antenna Gain (dBi):	-
Active Port(s):	A+B (Core 0 + Core 1)	Active Chain Id(s):	0+1

Test Frequency (MHz)	Unwanted Emissions Within the RLAN Band Margin (dB)			
	A	B	C	D
5955	9.11	10.90	-	-
6175	8.84	10.56	-	-
6415	8.58	8.79	-	-
6435	7.44	7.70	-	-
6475	7.47	7.59	-	-
6515	7.50	8.03	-	-
6535	7.46	8.09	-	-
6695	7.12	7.97	-	-
6855	7.69	8.02	-	-
6875	7.10	7.83	-	-
6895	7.90	8.76	-	-
6995	7.90	8.19	-	-
7115	6.80	7.10	-	-

Table 373 - Unwanted Emissions Within the Band Results



Test Configuration			
Frequency Range:	5925 MHz – 7125 MHz	Band:	U-NII-5 to U-NII-8
Limit Clause(s):	15.407(b)	Test Method(s):	KDB 987594 clause j

DUT Configuration			
Mode:	802.11ax HE40 SU	Duty Cycle (%):	-
Modulation Coding Scheme:	MCS2x1	DCCF (dB):	-
Antenna Configuration:	MIMO CDD	Peak Antenna Gain (dBi):	-
Active Port(s):	A+B (Core 0 + Core 1)	Active Chain Id(s):	0+1

Test Frequency (MHz)	Unwanted Emissions Within the RLAN Band Margin (dB)			
	A	B	C	D
5965	9.88	10.35	-	-
6165	8.98	10.15	-	-
6405	6.30	7.08	-	-
6445	6.52	7.26	-	-
6485	6.14	6.90	-	-
6525	6.42	7.34	-	-
6565	5.68	6.57	-	-
6685	5.83	6.34	-	-
6845	5.58	6.35	-	-
6885	6.13	6.57	-	-
6925	7.76	8.41	-	-
7005	5.57	6.50	-	-
7085	5.83	6.47	-	-

Table 374 - Unwanted Emissions Within the Band Results



Test Configuration			
Frequency Range:	5925 MHz – 7125 MHz	Band:	U-NII-5 to U-NII-8
Limit Clause(s):	15.407(b)	Test Method(s):	KDB 987594 clause j

DUT Configuration			
Mode:	802.11ax HE80 SU	Duty Cycle (%):	-
Modulation Coding Scheme:	MCS2x1	DCCF (dB):	-
Antenna Configuration:	MIMO CDD	Peak Antenna Gain (dBi):	-
Active Port(s):	A+B (Core 0 + Core 1)	Active Chain Id(s):	0+1

Test Frequency (MHz)	Unwanted Emissions Within the RLAN Band Margin (dB)			
	A	B	C	D
5985	8.41	9.10	-	-
6145	9.07	9.81	-	-
6385	7.45	8.11	-	-
6465	7.44	7.79	-	-
6545	7.74	7.30	-	-
6625	7.08	7.40	-	-
6705	7.48	8.32	-	-
6785	6.96	7.84	-	-
6865	6.74	7.96	-	-
6945	6.79	7.96	-	-
7025	7.73	8.25	-	-

Table 375 - Unwanted Emissions Within the Band Results



Test Configuration			
Frequency Range:	5925 MHz – 7125 MHz	Band:	U-NII-5 to U-NII-8
Limit Clause(s):	15.407(b)	Test Method(s):	KDB 987594 clause j

DUT Configuration			
Mode:	802.11ax HE160 SU	Duty Cycle (%):	-
Modulation Coding Scheme:	MCS2x1	DCCF (dB):	-
Antenna Configuration:	MIMO CDD	Peak Antenna Gain (dBi):	-
Active Port(s):	A+B (Core 0 + Core 1)	Active Chain Id(s):	0+1

Test Frequency (MHz)	Unwanted Emissions Within the RLAN Band Margin (dB)			
	A	B	C	D
6025	9.91	9.73	-	-
6185	9.71	9.99	-	-
6345	8.03	9.41	-	-
6505	8.60	8.87	-	-
6665	8.84	9.81	-	-
6825	8.12	8.87	-	-
6985	8.01	9.45	-	-

Table 376 - Unwanted Emissions Within the Band Results



Protocol	Unwanted Emissions Within the RLAN Band	
	Margin (dB)	Frequency (MHz)
802.11ax HE20 RU106	7.28	6919.000
802.11ax HE20 RU26	8.69	6303.000
802.11ax HE20 RU52	7.24	6833.100

Table 377 - Unwanted Emissions Within the RLAN Band Summary Results

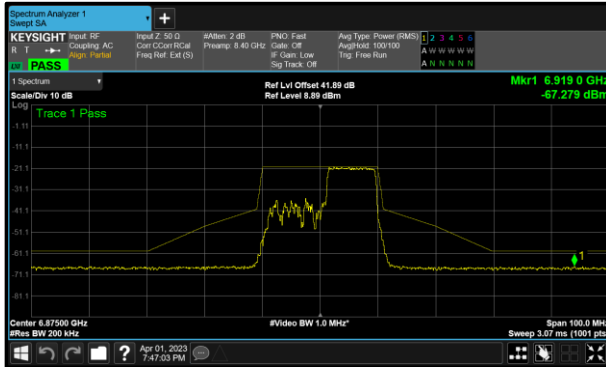

Figure 157 - A (Core 0) 802.11ax HE20 RU106 6875 MHz (CH185)

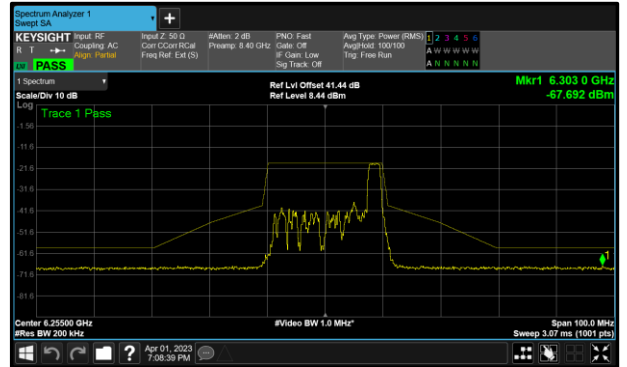

Figure 158 - A (Core 0) 802.11ax HE20 RU26 6255 MHz (CH61)

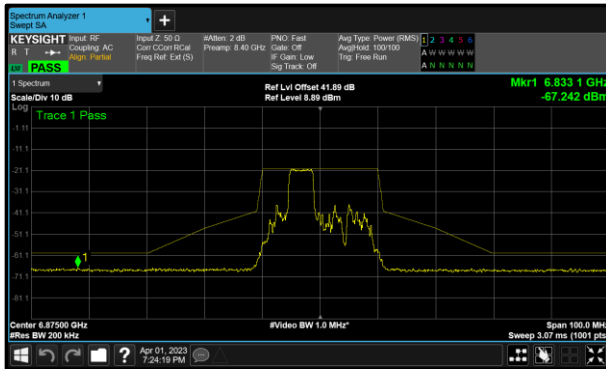

Figure 159 - A (Core 0) 802.11ax HE20 RU52 6875 MHz (CH185)



Test Configuration			
Frequency Range:	5925 MHz – 7125 MHz	Band:	U-NII-5 to U-NII-8
Limit Clause(s):	15.407(b)	Test Method(s):	KDB 987594 clause j

DUT Configuration			
Mode:	802.11ax HE20 RU26	Duty Cycle (%):	-
Modulation Coding Scheme:	MCS2x1	DCCF (dB):	-
Antenna Configuration:	MIMO CDD	Peak Antenna Gain (dBi):	-
Active Port(s):	A+B (Core 0 + Core 1)	Active Chain Id(s):	0+1

Test Frequency (MHz)	Unwanted Emissions Within the RLAN Band Margin (dB)			
	A	B	C	D
5955 (RU26.0)	8.87	10.76	-	-
6095 (RU26.0)	8.73	10.42	-	-
6255 (RU26.8)	8.69	9.95	-	-

Table 378 - Unwanted Emissions Within the Band Results



Test Configuration			
Frequency Range:	5925 MHz – 7125 MHz	Band:	U-NII-5 to U-NII-8
Limit Clause(s):	15.407(b)	Test Method(s):	KDB 987594 clause j

DUT Configuration			
Mode:	802.11ax HE20 RU52	Duty Cycle (%):	-
Modulation Coding Scheme:	MCS2x1	DCCF (dB):	-
Antenna Configuration:	MIMO CDD	Peak Antenna Gain (dBi):	-
Active Port(s):	A+B (Core 0 + Core 1)	Active Chain Id(s):	0+1

Test Frequency (MHz)	Unwanted Emissions Within the RLAN Band Margin (dB)			
	A	B	C	D
5955 (RU52.37)	9.36	11.20	-	-
6175 (RU52.37)	8.86	10.29	-	-
6415 (RU52.40)	8.14	8.66	-	-
6435 (RU52.37)	7.53	7.98	-	-
6475 (RU52.37)	7.71	8.03	-	-
6515 (RU52.40)	7.36	7.46	-	-
6535 (RU52.37)	7.72	7.59	-	-
6695 (RU52.37)	7.70	7.79	-	-
6855 (RU52.40)	7.27	7.64	-	-
6875 (RU52.38)	7.24	7.59	-	-
6875 (RU52.39)	7.37	7.53	-	-
6895 (RU52.37)	7.35	8.65	-	-
6995 (RU52.37)	7.71	8.56	-	-
7095 (RU52.40)	8.02	7.62	-	-

Table 379 - Unwanted Emissions Within the Band Results



Test Configuration			
Frequency Range:	5925 MHz – 7125 MHz	Band:	U-NII-5 to U-NII-8
Limit Clause(s):	15.407(b)	Test Method(s):	KDB 987594 clause j

DUT Configuration			
Mode:	802.11ax HE20 RU106	Duty Cycle (%):	-
Modulation Coding Scheme:	MCS2x1	DCCF (dB):	-
Antenna Configuration:	MIMO CDD	Peak Antenna Gain (dBi):	-
Active Port(s):	A+B (Core 0 + Core 1)	Active Chain Id(s):	0+1

Test Frequency (MHz)	Unwanted Emissions Within the RLAN Band Margin (dB)			
	A	B	C	D
5955 (RU106.53)	8.55	10.90	-	-
6175 (RU106.53)	9.03	10.11	-	-
6415 (RU106.54)	8.56	8.95	-	-
6435 (RU106.53)	7.32	7.89	-	-
6475 (RU106.53)	7.39	7.90	-	-
6515 (RU106.54)	7.97	7.82	-	-
6535 (RU106.53)	7.61	7.92	-	-
6695 (RU106.53)	7.75	7.98	-	-
6855 (RU106.54)	7.30	7.74	-	-
6875 (RU106.53)	7.39	7.69	-	-
6875 (RU106.54)	7.28	7.70	-	-
6895 (RU106.53)	7.51	8.71	-	-
6995 (RU106.53)	7.88	8.17	-	-
7095 (RU106.54)	7.80	7.89	-	-

Table 380 - Unwanted Emissions Within the Band Results



MIMO SDM

Protocol	Unwanted Emissions Within the RLAN Band	
	Margin (dB)	Frequency (MHz)
802.11ax HE20 SU	7.05	7075.500
802.11ax HE40 SU	9.31	6972.200
802.11ax HE80 SU	9.34	6777.840
802.11ax HE160 SU	8.97	6906.000

Table 381 - Unwanted Emissions Within the RLAN Band Summary Results

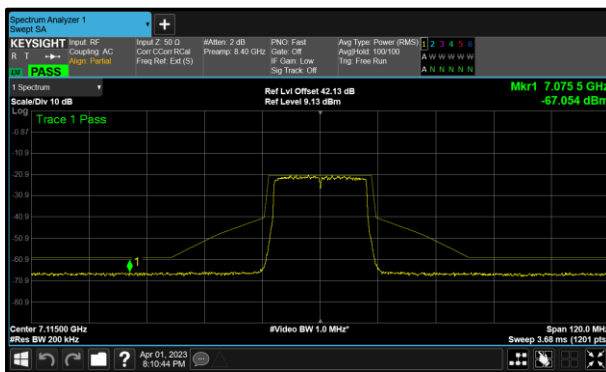

Figure 160 - A (Core 0) 802.11ax HE20 SU 7115 MHz (CH233)

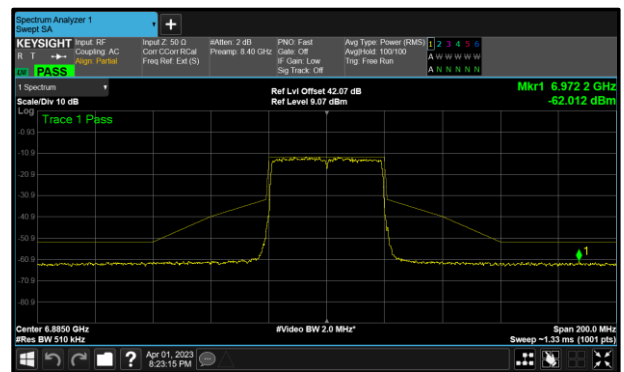

Figure 161 - A (Core 0) 802.11ax HE40 SU 6885 MHz (CH187)

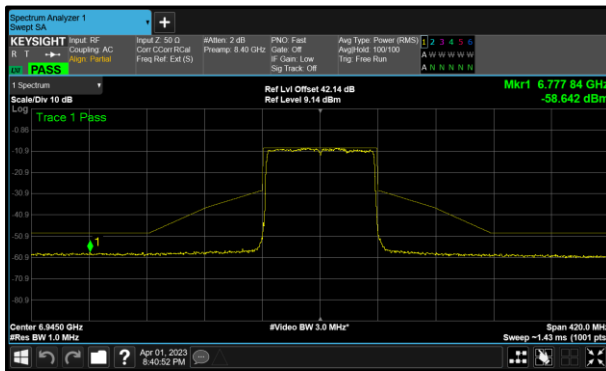

Figure 162 - A (Core 0) 802.11ax HE80 SU 6945 MHz (CH199)

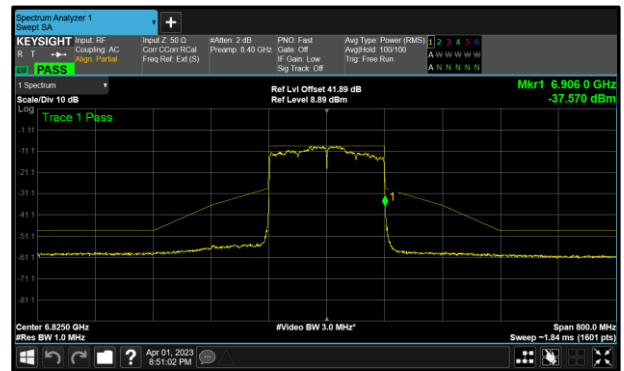

Figure 163 - A (Core 0) 802.11ax HE160 SU 6825 MHz (CH175)



Test Configuration			
Frequency Range:	5925 MHz – 7125 MHz	Band:	U-NII-5 to U-NII-8
Limit Clause(s):	15.407(b)	Test Method(s):	KDB 987594 clause j

DUT Configuration			
Mode:	802.11ax HE20 SU	Duty Cycle (%):	-
Modulation Coding Scheme:	MCS2x2	DCCF (dB):	-
Antenna Configuration:	MIMO SDM	Peak Antenna Gain (dBi):	-
Active Port(s):	A+B (Core 0 + Core 1)	Active Chain Id(s):	0+1

Test Frequency (MHz)	Unwanted Emissions Within the RLAN Band Margin (dB)			
	A	B	C	D
5955	12.95	13.13	-	-
6175	12.44	13.49	-	-
6415	10.21	10.70	-	-
6435	9.59	10.20	-	-
6475	9.23	9.59	-	-
6515	9.75	10.18	-	-
6535	9.72	9.90	-	-
6695	9.37	8.95	-	-
6855	9.48	9.72	-	-
6875	8.90	9.50	-	-
6895	10.72	11.45	-	-
6995	10.74	11.32	-	-
7115	7.05	7.66	-	-

Table 382 - Unwanted Emissions Within the Band Results



Test Configuration			
Frequency Range:	5925 MHz – 7125 MHz	Band:	U-NII-5 to U-NII-8
Limit Clause(s):	15.407(b)	Test Method(s):	KDB 987594 clause j

DUT Configuration			
Mode:	802.11ax HE40 SU	Duty Cycle (%):	-
Modulation Coding Scheme:	MCS2x2	DCCF (dB):	-
Antenna Configuration:	MIMO SDM	Peak Antenna Gain (dBi):	-
Active Port(s):	A+B (Core 0 + Core 1)	Active Chain Id(s):	0+1

Test Frequency (MHz)	Unwanted Emissions Within the RLAN Band Margin (dB)			
	A	B	C	D
5965	11.82	12.64	-	-
6165	10.94	12.35	-	-
6405	10.89	10.88	-	-
6445	10.29	10.54	-	-
6485	10.02	10.53	-	-
6525	10.35	10.06	-	-
6565	9.90	10.08	-	-
6685	9.81	10.39	-	-
6845	9.73	10.41	-	-
6885	9.31	9.76	-	-
6925	9.87	10.85	-	-
7005	10.03	10.51	-	-
7085	10.74	11.13	-	-

Table 383 - Unwanted Emissions Within the Band Results



Test Configuration			
Frequency Range:	5925 MHz – 7125 MHz	Band:	U-NII-5 to U-NII-8
Limit Clause(s):	15.407(b)	Test Method(s):	KDB 987594 clause j

DUT Configuration			
Mode:	802.11ax HE80 SU	Duty Cycle (%):	-
Modulation Coding Scheme:	MCS2x2	DCCF (dB):	-
Antenna Configuration:	MIMO SDM	Peak Antenna Gain (dBi):	-
Active Port(s):	A+B (Core 0 + Core 1)	Active Chain Id(s):	0+1

Test Frequency (MHz)	Unwanted Emissions Within the RLAN Band Margin (dB)			
	A	B	C	D
5985	10.80	11.24	-	-
6145	10.89	11.87	-	-
6385	9.88	10.05	-	-
6465	9.94	10.20	-	-
6545	10.06	9.63	-	-
6625	9.90	10.05	-	-
6705	9.92	9.82	-	-
6785	9.61	10.53	-	-
6865	9.46	10.18	-	-
6945	9.34	10.36	-	-
7025	9.67	10.52	-	-

Table 384 - Unwanted Emissions Within the Band Results



Test Configuration			
Frequency Range:	5925 MHz – 7125 MHz	Band:	U-NII-5 to U-NII-8
Limit Clause(s):	15.407(b)	Test Method(s):	KDB 987594 clause j

DUT Configuration			
Mode:	802.11ax HE160 SU	Duty Cycle (%):	-
Modulation Coding Scheme:	MCS2x2	DCCF (dB):	-
Antenna Configuration:	MIMO SDM	Peak Antenna Gain (dBi):	-
Active Port(s):	A+B (Core 0 + Core 1)	Active Chain Id(s):	0+1

Test Frequency (MHz)	Unwanted Emissions Within the RLAN Band Margin (dB)			
	A	B	C	D
6025	11.53	11.78	-	-
6185	11.29	10.68	-	-
6345	10.02	11.45	-	-
6505	10.09	11.22	-	-
6665	10.95	11.12	-	-
6825	8.97	10.09	-	-
6985	10.13	11.44	-	-

Table 385 - Unwanted Emissions Within the Band Results



MIMO SDM

Protocol	Unwanted Emissions Within the RLAN Band	
	Margin (dB)	Frequency (MHz)
802.11ax HE20 RU106	9.54	6828.300
802.11ax HE20 RU26	9.77	6841.300
802.11ax HE20 RU52	9.58	6838.800

Table 386 - Unwanted Emissions Within the RLAN Band Summary Results

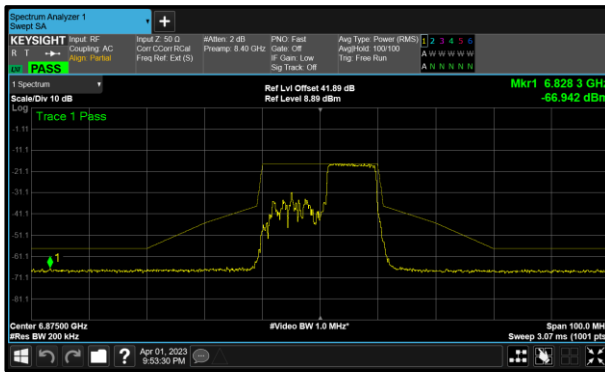

Figure 164 - A (Core 0) 802.11ax HE20 RU106 6875 MHz (CH185)

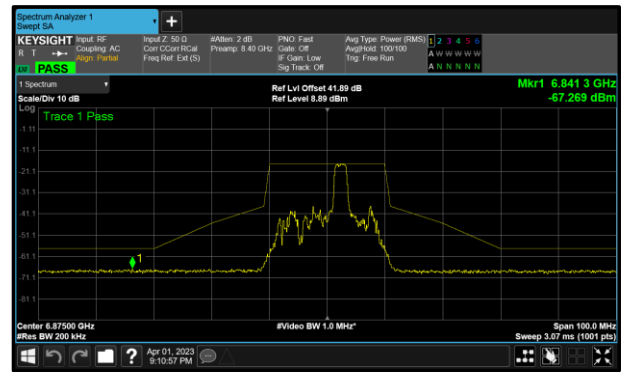

Figure 165 - A (Core 0) 802.11ax HE20 RU26 6875 MHz (CH185)

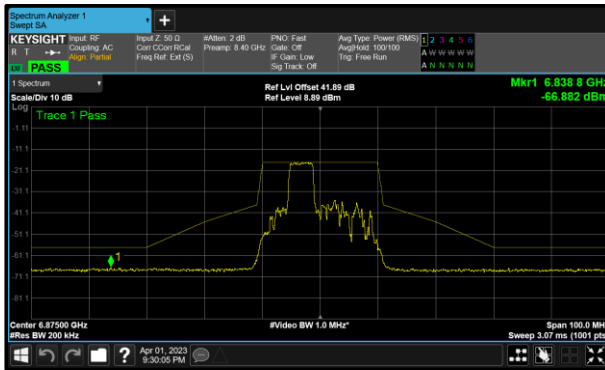

Figure 166 - A (Core 0) 802.11ax HE20 RU52 6875 MHz (CH185)



Test Configuration			
Frequency Range:	5925 MHz – 7125 MHz	Band:	U-NII-5 to U-NII-8
Limit Clause(s):	15.407(b)	Test Method(s):	KDB 987594 clause j

DUT Configuration			
Mode:	802.11ax HE20 RU26	Duty Cycle (%):	-
Modulation Coding Scheme:	MCS2x2	DCCF (dB):	-
Antenna Configuration:	MIMO SDM	Peak Antenna Gain (dBi):	-
Active Port(s):	A+B (Core 0 + Core 1)	Active Chain Id(s):	0+1

Test Frequency (MHz)	Unwanted Emissions Within the RLAN Band Margin (dB)			
	A	B	C	D
5955 (RU26.0)	11.84	14.01	-	-
6175 (RU26.0)	11.29	12.66	-	-
6415 (RU26.8)	10.42	10.74	-	-
6435 (RU26.0)	10.25	10.69	-	-
6475 (RU26.0)	9.87	10.85	-	-
6515 (RU26.8)	10.34	10.07	-	-
6535 (RU26.0)	10.22	10.26	-	-
6695 (RU26.0)	10.42	10.44	-	-
6855 (RU26.8)	10.59	10.63	-	-
6875 (RU26.3)	9.83	10.43	-	-
6875 (RU26.5)	9.77	10.17	-	-
6895 (RU26.0)	10.59	11.28	-	-
6995 (RU26.0)	10.44	11.44	-	-
7095 (RU26.8)	11.59	10.26	-	-

Table 387 - Unwanted Emissions Within the Band Results



Test Configuration			
Frequency Range:	5925 MHz – 7125 MHz	Band:	U-NII-5 to U-NII-8
Limit Clause(s):	15.407(b)	Test Method(s):	KDB 987594 clause j

DUT Configuration			
Mode:	802.11ax HE20 RU52	Duty Cycle (%):	-
Modulation Coding Scheme:	MCS2x2	DCCF (dB):	-
Antenna Configuration:	MIMO SDM	Peak Antenna Gain (dBi):	-
Active Port(s):	A+B (Core 0 + Core 1)	Active Chain Id(s):	0+1

Test Frequency (MHz)	Unwanted Emissions Within the RLAN Band Margin (dB)			
	A	B	C	D
5955 (RU52.37)	12.14	13.76	-	-
6175 (RU52.37)	11.10	12.61	-	-
6415 (RU52.40)	10.34	11.31	-	-
6435 (RU52.37)	10.23	10.98	-	-
6475 (RU52.37)	10.49	9.99	-	-
6515 (RU52.40)	10.08	10.67	-	-
6535 (RU52.37)	10.25	10.46	-	-
6695 (RU52.37)	10.80	10.13	-	-
6855 (RU52.40)	10.71	10.96	-	-
6875 (RU52.38)	9.58	10.37	-	-
6875 (RU52.39)	9.95	10.69	-	-
6895 (RU52.37)	10.17	11.20	-	-
6995 (RU52.37)	10.70	11.33	-	-
7095 (RU52.40)	10.76	10.50	-	-

Table 388 - Unwanted Emissions Within the Band Results



Test Configuration			
Frequency Range:	5925 MHz – 7125 MHz	Band:	U-NII-5 to U-NII-8
Limit Clause(s):	15.407(b)	Test Method(s):	KDB 987594 clause j

DUT Configuration			
Mode:	802.11ax HE20 RU106	Duty Cycle (%):	-
Modulation Coding Scheme:	MCS2x2	DCCF (dB):	-
Antenna Configuration:	MIMO SDM	Peak Antenna Gain (dBi):	-
Active Port(s):	A+B (Core 0 + Core 1)	Active Chain Id(s):	0+1

Test Frequency (MHz)	Unwanted Emissions Within the RLAN Band Margin (dB)			
	A	B	C	D
5955 (RU106.53)	11.80	13.68	-	-
6175 (RU106.53)	11.50	12.87	-	-
6415 (RU106.54)	10.64	11.33	-	-
6435 (RU106.53)	9.87	10.90	-	-
6475 (RU106.53)	10.68	10.99	-	-
6515 (RU106.54)	10.41	10.79	-	-
6535 (RU106.53)	10.76	10.60	-	-
6695 (RU106.53)	10.81	10.35	-	-
6855 (RU106.54)	10.11	11.04	-	-
6875 (RU106.53)	9.74	10.78	-	-
6875 (RU106.54)	9.54	10.64	-	-
6895 (RU106.53)	10.14	11.33	-	-
6995 (RU106.53)	10.78	11.71	-	-
7095 (RU106.54)	10.83	10.74	-	-

Table 389 - Unwanted Emissions Within the Band Results



TxBF

TxBF Protocol	Unwanted Emissions Within the RLAN Band	
	Margin (dB)	Frequency (MHz)
802.11ax HE20 SU	2.65	5910
802.11ax HE40 SU	1.72	6506
802.11ax HE80 SU	3.80	6831

Table 390 - Unwanted Emissions Within the RLAN Band Summary Results - MIMO TxBF

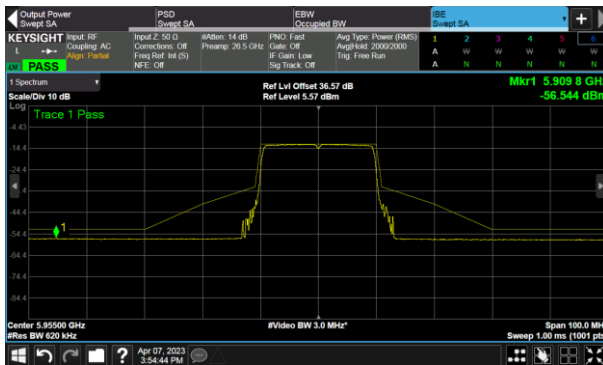

Figure 167 - A (Core 0) 802.11ax HE20 SU - 5910 MHz (CH1)



Figure 168 - A (Core 0) 802.11ax HE40 SU - 6506 MHz (CH107)



Figure 169 - B (Core 1) 802.11ax HE80 SU - 6831 MHz (CH215)



Test Configuration			
Frequency Range:	5.925-6.425 GHz	Band:	U-NII-5
Limit Clause(s):	15.407(b)	Test Method(s):	KDB 987594 clause j

DUT Configuration			
Mode:	802.11ax HE20 SU	Duty Cycle (%):	-
Modulation Coding Scheme:	MCS2x1	DCCF (dB):	-
Antenna Configuration:	TxBF	Peak Antenna Gain (dBi):	-
Active Port(s):	A+B (Core 0 + Core 1)	Active Chain Id(s):	0+1

Test Frequency (MHz)	Unwanted Emissions Within the RLAN Band Margin (dB)			
	A	B	C	D
5955	4.11	4.44	-	-
6115	2.65	3.27	-	-
6255	4.98	5.36	-	-

Table 391 - Unwanted Emissions Within the Band Results



Test Configuration			
Frequency Range:	5.925-7.125 GHz	Band:	U-NII-5, U-NII-6, U-NII-7, U-NII-8
Limit Clause(s):	15.407(b)	Test Method(s):	KDB 987594 clause j

DUT Configuration			
Mode:	802.11ax HE40 SU	Duty Cycle (%):	-
Modulation Coding Scheme:	MCS2x1	DCCF (dB):	-
Antenna Configuration:	TxBF	Peak Antenna Gain (dBi):	-
Active Port(s):	A+B (Core 0 + Core 1)	Active Chain Id(s):	0+1

Test Frequency (MHz)	Unwanted Emissions Within the RLAN Band Margin (dB)			
	A	B	C	D
5965	5.28	5.45	-	-
6125	5.10	5.82	-	-
6405	1.79	1.92	-	-
6445	2.99	2.88	-	-
6485	1.72	2.28	-	-
6525	4.53	4.49	-	-
6565	4.00	4.00	-	-
6685	3.55	3.87	-	-
6845	4.82	4.39	-	-
6885	4.14	3.09	-	-
6925	4.61	1.92	-	-
7005	3.10	2.09	-	-
7085	3.22	2.09	-	-

Table 392 - Unwanted Emissions Within the Band Results



Test Configuration			
Frequency Range:	5.925-7.125 GHz	Band:	U-NII-5, U-NII-6, U-NII-7, U-NII-8
Limit Clause(s):	15.407(b)	Test Method(s):	KDB 987594 clause j

DUT Configuration			
Mode:	802.11ax HE80 SU	Duty Cycle (%):	-
Modulation Coding Scheme:	MCS2x1	DCCF (dB):	-
Antenna Configuration:	TxBF	Peak Antenna Gain (dBi):	-
Active Port(s):	A+B (Core 0 + Core 1)	Active Chain Id(s):	0+1

Test Frequency (MHz)	Unwanted Emissions Within the RLAN Band Margin (dB)			
	A	B	C	D
5985	4.61	4.67	-	-
6145	6.11	6.62	-	-
6385	3.82	4.32	-	-
6465	4.16	4.54	-	-
6545	4.14	4.23	-	-
6625	3.84	3.86	-	-
6705	4.14	4.13	-	-
6785	4.12	4.52	-	-
6865	3.86	4.45	-	-
6945	4.66	4.47	-	-
7025	3.85	3.80	-	-

Table 393 - Unwanted Emissions Within the Band Results



FCC 47 CFR Part 15, Limit Clause 15.407(b)(6)

For transmitters operating within the 5.925–7.125 GHz bands:

Power spectral density must be suppressed by 20 dB at 1 MHz outside of channel edge, by 28 dB at one channel bandwidth from the channel center, and by 40 dB at one- and one-half times the channel bandwidth away from channel center. At frequencies between one megahertz outside an unlicensed device's channel edge and one channel bandwidth from the center of the channel, the limits must be linearly interpolated between 20 dB and 28 dB suppression, and at frequencies between one and one- and one-half times an unlicensed device's channel bandwidth, the limits must be linearly interpolated between 28 dB and 40 dB suppression. Emissions removed from the channel center by more than one- and one-half times the channel bandwidth must be suppressed by at least 40 dB.

ISED RSS-248, Limit Clause 4.7.2(b)

e.i.r.p. spectral density of unwanted emissions falling into the 5925-7125 MHz band shall be attenuated (in dB) below the reference power spectral density by:

- i. 20 dB at 1 MHz away from the channel edge; and
- ii. a linearly interpolated value between 20 dB and 28 dB at frequencies between 1 MHz outside of channel edge and one (1) channel bandwidth from the operating channel centre, respectively; and
- iii. 28 dB at one (1) channel bandwidth away from the operating channel centre; and
- iv. a linearly interpolated value between 28 dB and 40 dB at frequencies between one (1) channel bandwidth from the channel centre and one- and one-half (1.5) times the channel bandwidth away from the operating channel centre, respectively; and
- v. 40 dB at one- and one-half (1.5) times the channel bandwidth away from the channel centre; and
- vi. a minimum of 40 dB at frequencies that are further away than one and one-half (1.5) times the channel bandwidth from the channel centre;



2.6.7 Test Location and Test Equipment Used

This test was carried out in RF Laboratory 14.

Instrument	Manufacturer	Type No.	TE No.	Calibration Period (months)	Calibration Expiry Date
Hygrometer	Rotronic	I-1000	3068	12	21-Sep-2023
1800-6000 MHz Power Splitter	Mini-Circuits	ZN2PD-63-S+	4055	-	O/P Mon
Multi-GNSS Simulator (GPS)	Spirent	GSS6700	4596	12	22-Aug-2023
Power splitter - 2 port	Mini-Circuits	ZN2PD-63-S+	4743	12	30-Nov-2023
EXA	Keysight Technologies	N9010B	4968	24	19-Jan-2024
Network Analyser	Keysight Technologies	E5063A	5018	12	29-Sep-2023
Cable (18 GHz)	Rosenberger	LU7-071-1000	5096	12	23-Oct-2023
Cable (18 GHz)	Rosenberger	LU7-071-1000	5100	12	23-Oct-2023
Electronic Calibration Module	Keysight Technologies	85093C	5188	12	09-Sep-2023
AC Programmable Power Supply	iTech	IT7324	5227	-	O/P Mon
Attenuator 5W 30dB DC-18GHz	Aaren	AT40A-4041-D18-30	5504	12	21-Apr-2023
Directional Coupler 2-8GHz	RF-Lambda	RFDC2G8G10	5765	-	O/P Mon
Directional Coupler 2-8GHz	RF-Lambda	RFDC2G8G10	5766	-	O/P Mon
1500VA AC Power Supply	iTech	IT7324	5907	-	O/P Mon
MXA Signal Analyser	Keysight Technologies	N9020B	5919	24	13-Mar-2024
Signal Conditioning Unit	TUV SUD	SPECTRUM_SCU001	5932	12	10-May-2023
Digital Multimeter	Fluke	115	6145	12	17-Jun-2023
Signal Conditioning Unit	TUV SUD	SPECTRUM_SCU005	6350	-	O/P Mon

Table 394

O/P Mon - Output Monitored using calibrated equipment



2.7 Contention Based Protocol

2.7.1 Specification Reference

FCC 47 CFR Part 15E, Clause 15.407 (d)(6)
ISED RSS-248, Clause 4.8

2.7.2 Equipment Under Test and Modification State

A2901, S/N: HPXKWF6DJV - Modification State 0

2.7.3 Date of Test

12-April-2023

2.7.4 Test Method

This test was performed in accordance with KDB 987594 D02, clause I.

The AWGN signal level was initially set at a level much less than the required threshold level ($\ll -62$ dBm) it was verified at this point that transmissions from the device under test (DUT) were present. The signal level was gradually increased until it was observed that the DUT continuously ceased transmissions with the AWGN signal present, i.e., no partial transmissions other than short control signalling transmissions.

The AWGN Signal level recorded is the level in to the DUT's receiver, corrected for all cable losses. The minimum antenna gain value was then used to correct the level as described in KDB 987594 D04.

Timing plots showing verification that transmissions from the DUT responded to the interferer have been included in the test results below.

2.7.5 Test Setup Diagram

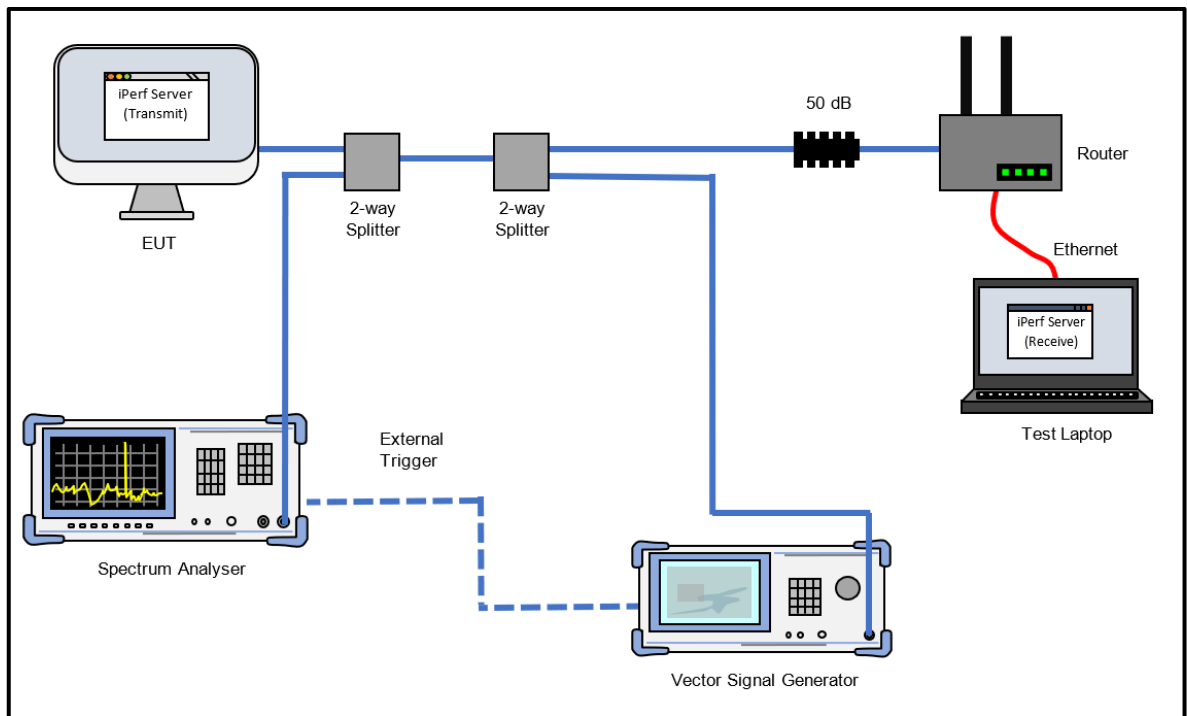

Figure 170 - Test Equipment Setup Diagram

2.7.6 Environmental Conditions

Ambient Temperature	25.3 °C
Relative Humidity	35.1 %



2.7.7 Test Results

6 GHz WLAN

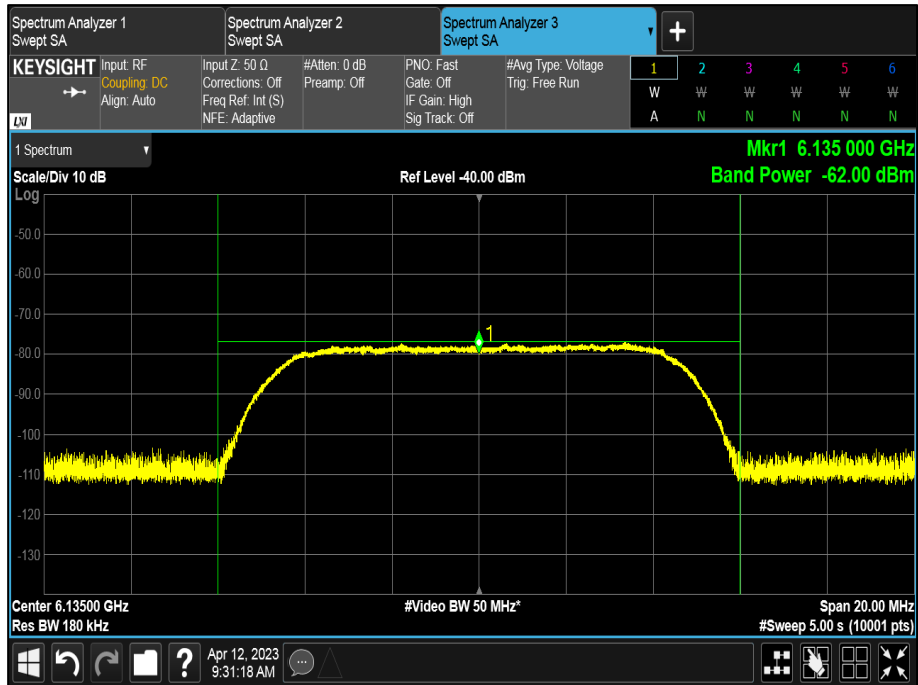

Figure 171 - Example of AWGN Signal



Parameter	Results		
U-NII Band	5	5	5
Channel Number	37	37	37
Bandwidth (MHz)	20	20	20
DUT Centre Frequency (MHz)	6135	6135	6135
AWGN Centre Frequency (MHz)	6135	6135	6135
AWGN Signal Power (dBm)	-67.98	-66.69	-66.03
Antenna Gain (dBi)	0.46	0.46	0.46
Adjusted Power (dBm)	-68.44	-67.15	-66.49
Detection Limit (dBm)	-62.0	-62.0	-62.0
EUT Tx Status (OFF/Minimal/ON)	ON	Minimal	OFF

Table 395 - U-NII-5, Minimum Bandwidth

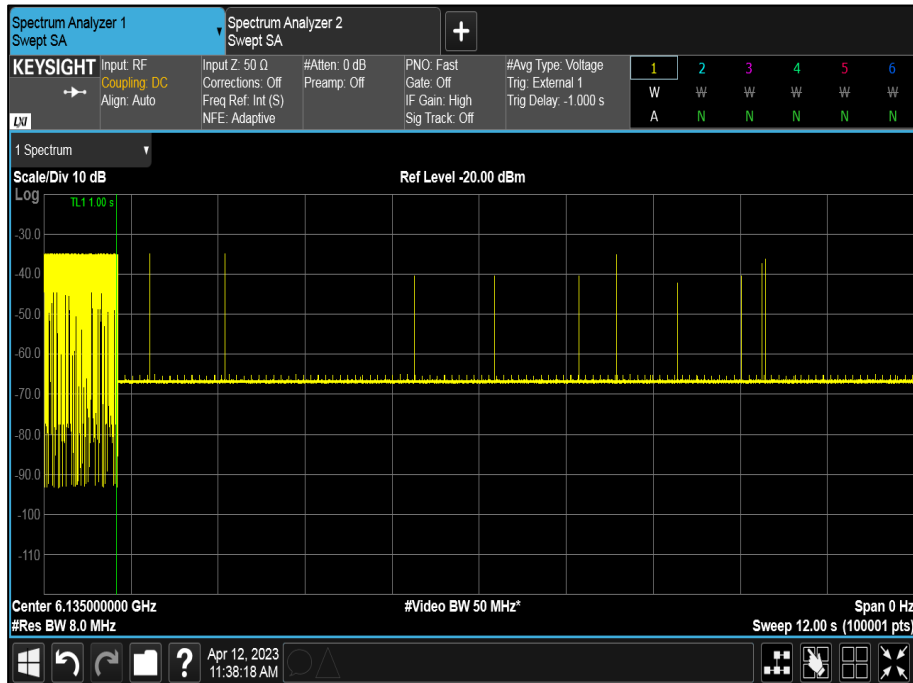

Figure 172 - U-NII-5, Minimum Bandwidth



Parameter	Results		
U-NII Band	5	5	5
Channel Number	47	47	47
Bandwidth (MHz)	160	160	160
DUT Centre Frequency (MHz)	6185	6185	6185
AWGN Centre Frequency (MHz)	6110	6110	6110
AWGN Signal Power (dBm)	-63.06	-62.36	-62.07
Antenna Gain (dBi)	0.46	0.46	0.46
Adjusted Power (dBm)	-63.52	-62.82	-62.53
Detection Limit (dBm)	-62.0	-62.0	-62.0
EUT Tx Status (OFF/Minimal/ON)	ON	Minimal	OFF

Table 396 - U-NII-5, Maximum Bandwidth (AWGN Low)

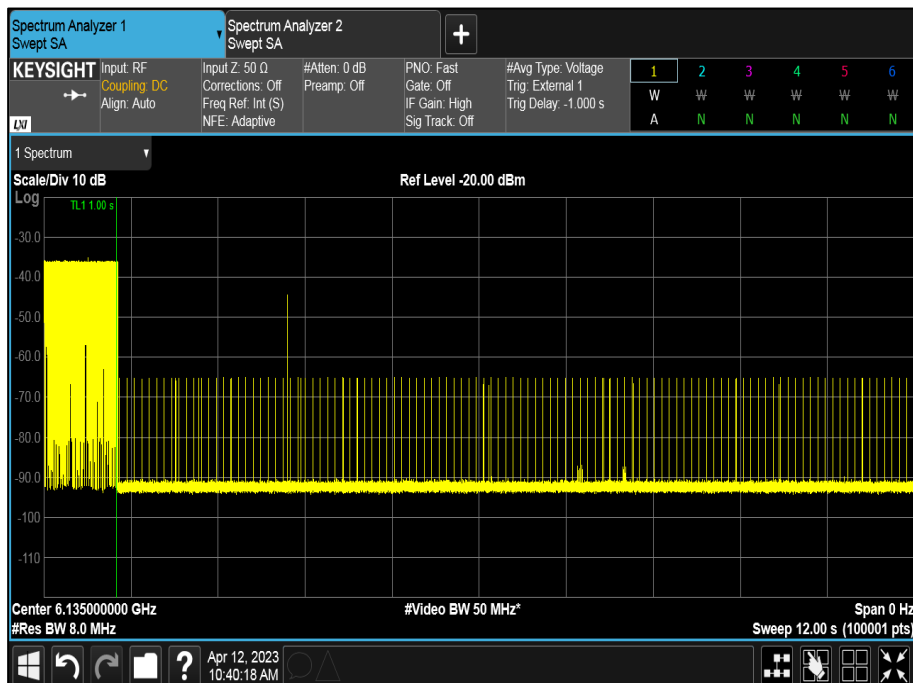

Figure 173 - U-NII-5, Minimum Bandwidth (AWGN Low)



Parameter	Results		
U-NII Band	5	5	5
Channel Number	47	47	47
Bandwidth (MHz)	160	160	160
DUT Centre Frequency (MHz)	6185	6185	6185
AWGN Centre Frequency (MHz)	6185	6185	6185
AWGN Signal Power (dBm)	-66.70	-65.90	-65.61
Antenna Gain (dBi)	0.46	0.46	0.46
Adjusted Power (dBm)	-67.16	-66.36	-66.07
Detection Limit (dBm)	-62.0	-62.0	-62.0
EUT Tx Status (OFF/Minimal/ON)	ON	Minimal	OFF

Table 397 - U-NII-5, Maximum Bandwidth (AWGN Mid)

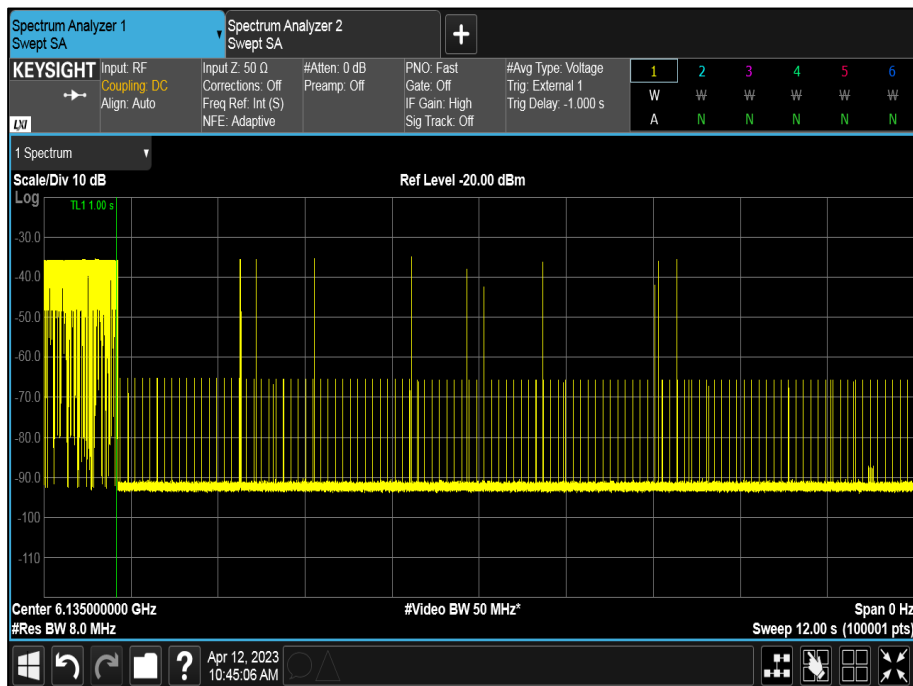

Figure 174 - U-NII-5, Minimum Bandwidth (AWGN Mid)



Parameter	Results		
U-NII Band	6	6	6
Channel Number	111	111	111
Bandwidth (MHz)	160	160	160
DUT Centre Frequency (MHz)	6505	6505	6505
AWGN Centre Frequency (MHz)	6430	6430	6430
AWGN Signal Power (dBm)	-64.53	-64.15	-63.26
Antenna Gain (dBi)	0.92	0.92	0.92
Adjusted Power (dBm)	-65.45	-65.07	-64.18
Detection Limit (dBm)	-62.0	-62.0	-62.0
EUT Tx Status (OFF/Minimal/ON)	ON	Minimal	OFF

Table 398 - U-NII-5, Maximum Bandwidth (AWGN High)

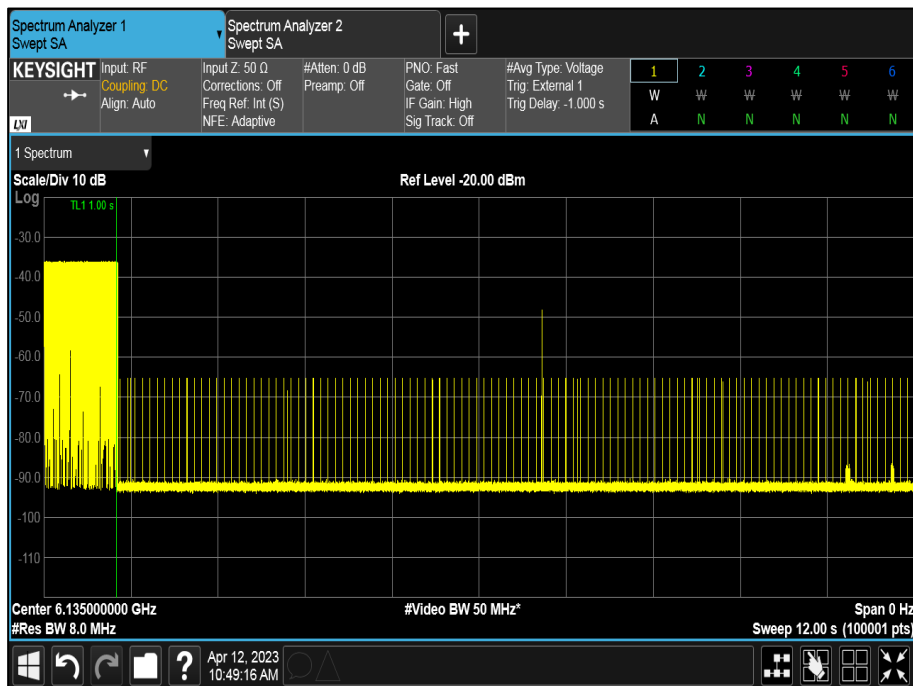

Figure 175 - U-NII-5, Minimum Bandwidth (AWGN High)



Parameter	Results		
U-NII Band	6	6	6
Channel Number	101	101	101
Bandwidth (MHz)	20	20	20
DUT Centre Frequency (MHz)	6455	6455	6455
AWGN Centre Frequency (MHz)	6455	6455	6455
AWGN Signal Power (dBm)	-67.08	-66.10	-65.11
Antenna Gain (dBi)	0.92	0.92	0.92
Adjusted Power (dBm)	-68.00	-67.02	-66.03
Detection Limit (dBm)	-62.0	-62.0	-62.0
EUT Tx Status (OFF/Minimal/ON)	ON	Minimal	OFF

Table 399 - U-NII-6, Minimum Bandwidth

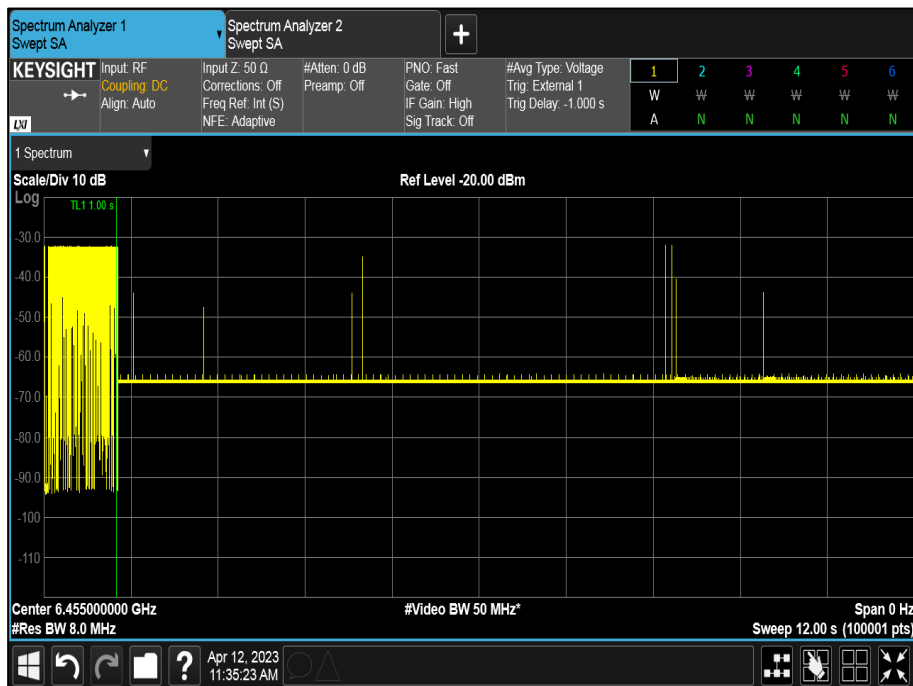

Figure 176 - U-NII-6, Minimum Bandwidth



Parameter	Results		
U-NII Band	6	6	6
Channel Number	111	111	111
Bandwidth (MHz)	160	160	160
DUT Centre Frequency (MHz)	6505	6505	6505
AWGN Centre Frequency (MHz)	6430	6430	6430
AWGN Signal Power (dBm)	-64.53	-64.15	-63.26
Antenna Gain (dBi)	0.92	0.92	0.92
Adjusted Power (dBm)	-65.45	-65.07	-64.18
Detection Limit (dBm)	-62.0	-62.0	-62.0
EUT Tx Status (OFF/Minimal/ON)	ON	Minimal	OFF

Table 400 - U-NII-6, Maximum Bandwidth (AWGN Low)



Figure 177 - U-NII-6, Minimum Bandwidth (AWGN Low)



Parameter	Results		
U-NII Band	6	6	6
Channel Number	111	111	111
Bandwidth (MHz)	160	160	160
DUT Centre Frequency (MHz)	6505	6505	6505
AWGN Centre Frequency (MHz)	6505	6505	6505
AWGN Signal Power (dBm)	-64.82	-64.35	-63.86
Antenna Gain (dBi)	0.92	0.92	0.92
Adjusted Power (dBm)	-65.74	-65.27	-64.78
Detection Limit (dBm)	-62.0	-62.0	-62.0
EUT Tx Status (OFF/Minimal/ON)	ON	Minimal	OFF

Table 401 - U-NII-6, Maximum Bandwidth (AWGN Mid)

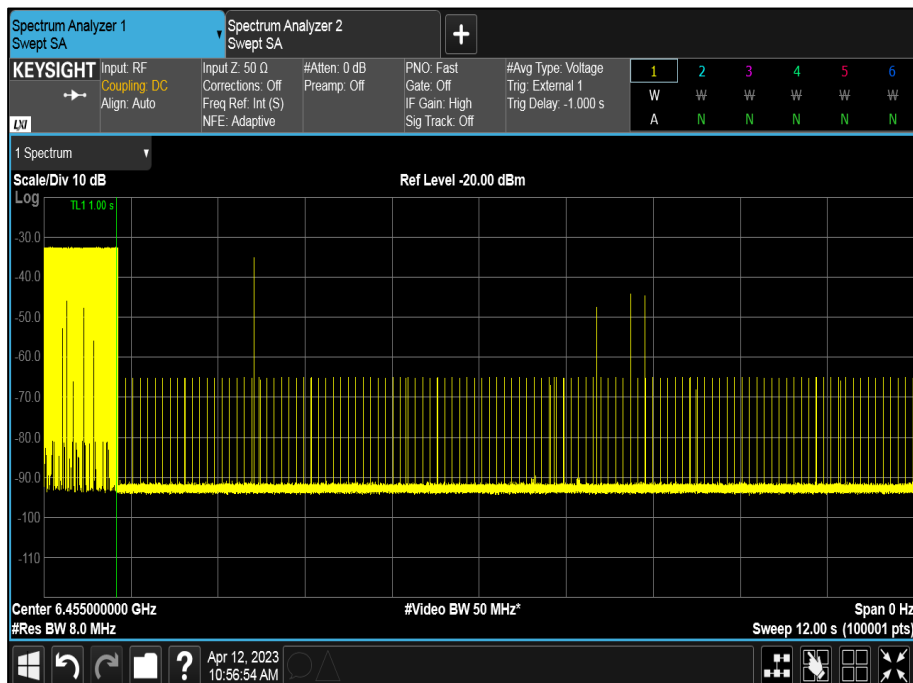

Figure 178 - U-NII-6, Minimum Bandwidth (AWGN Mid)



Parameter	Results		
U-NII Band	6	6	6
Channel Number	111	111	111
Bandwidth (MHz)	160	160	160
DUT Centre Frequency (MHz)	6505	6505	6505
AWGN Centre Frequency (MHz)	6580	6580	6580
AWGN Signal Power (dBm)	-63.65	-63.46	-61.37
Antenna Gain (dBi)	0.92	0.92	0.92
Adjusted Power (dBm)	-64.57	-64.38	-62.29
Detection Limit (dBm)	-62.0	-62.0	-62.0
EUT Tx Status (OFF/Minimal/ON)	ON	Minimal	OFF

Table 402 - U-NII-6, Maximum Bandwidth (AWGN High)

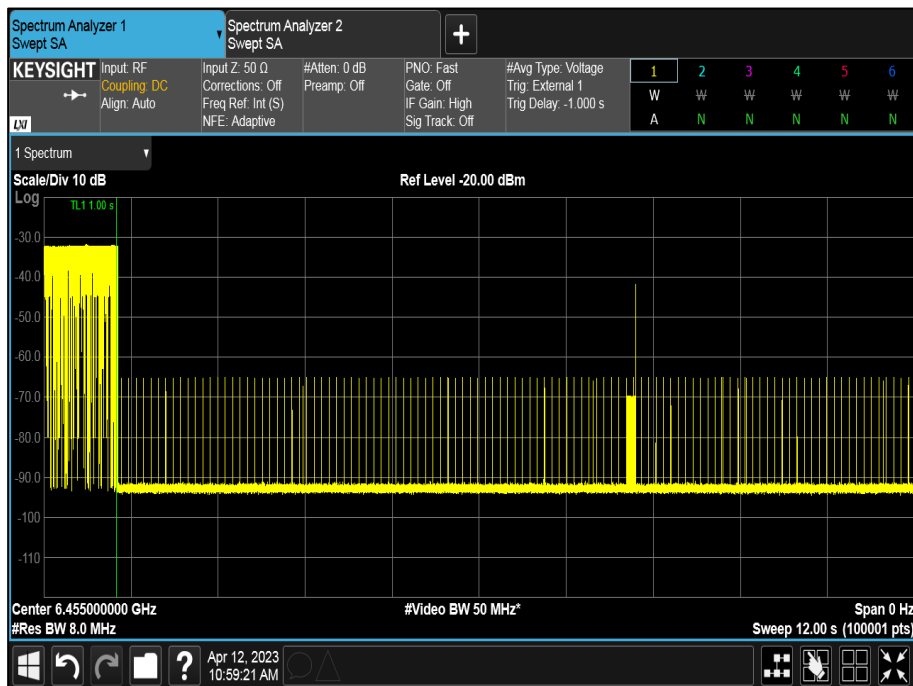

Figure 179 - U-NII-6, Minimum Bandwidth (AWGN High)



Parameter	Results		
U-NII Band	7	7	7
Channel Number	133	133	133
Bandwidth (MHz)	20	20	20
DUT Centre Frequency (MHz)	6615	6615	6615
AWGN Centre Frequency (MHz)	6615	6615	6615
AWGN Signal Power (dBm)	-67.18	-66.00	-64.91
Antenna Gain (dBi)	2.25	2.25	2.25
Adjusted Power (dBm)	-69.43	-68.25	-67.16
Detection Limit (dBm)	-62.0	-62.0	-62.0
EUT Tx Status (OFF/Minimal/ON)	ON	Minimal	OFF

Table 403 - U-NII-7, Minimum Bandwidth

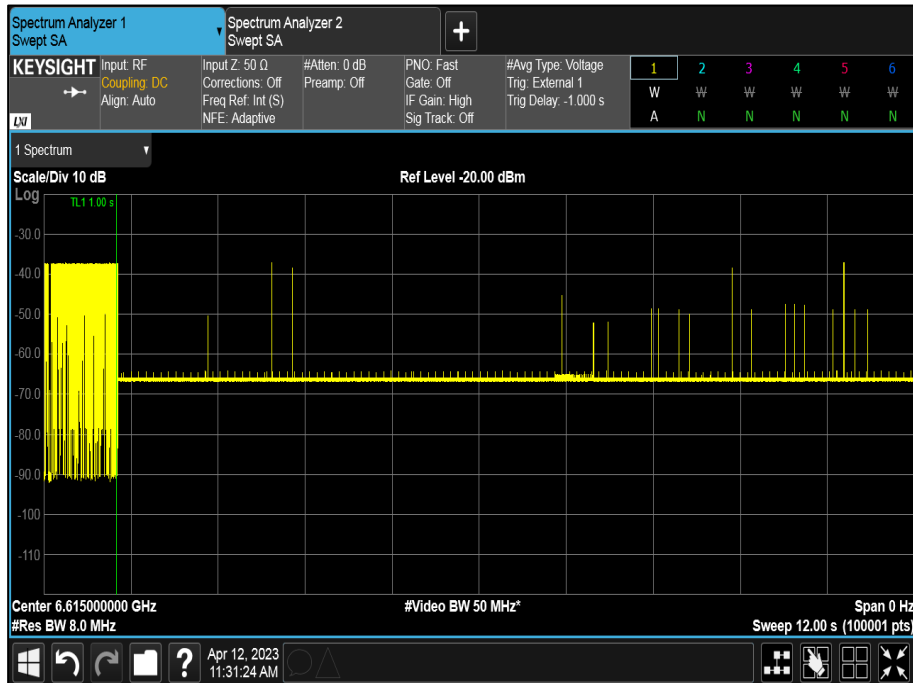

Figure 180 - U-NII-7, Minimum Bandwidth



Parameter	Results		
U-NII Band	7	7	7
Channel Number	143	143	143
Bandwidth (MHz)	160	160	160
DUT Centre Frequency (MHz)	6665	6665	6665
AWGN Centre Frequency (MHz)	6590	6590	6590
AWGN Signal Power (dBm)	-62.46	-62.36	-61.16
Antenna Gain (dBi)	2.25	2.25	2.25
Adjusted Power (dBm)	-64.71	-64.61	-63.41
Detection Limit (dBm)	-62.0	-62.0	-62.0
EUT Tx Status (OFF/Minimal/ON)	ON	Minimal	OFF

Table 404 - U-NII-7, Maximum Bandwidth (AWGN Low)

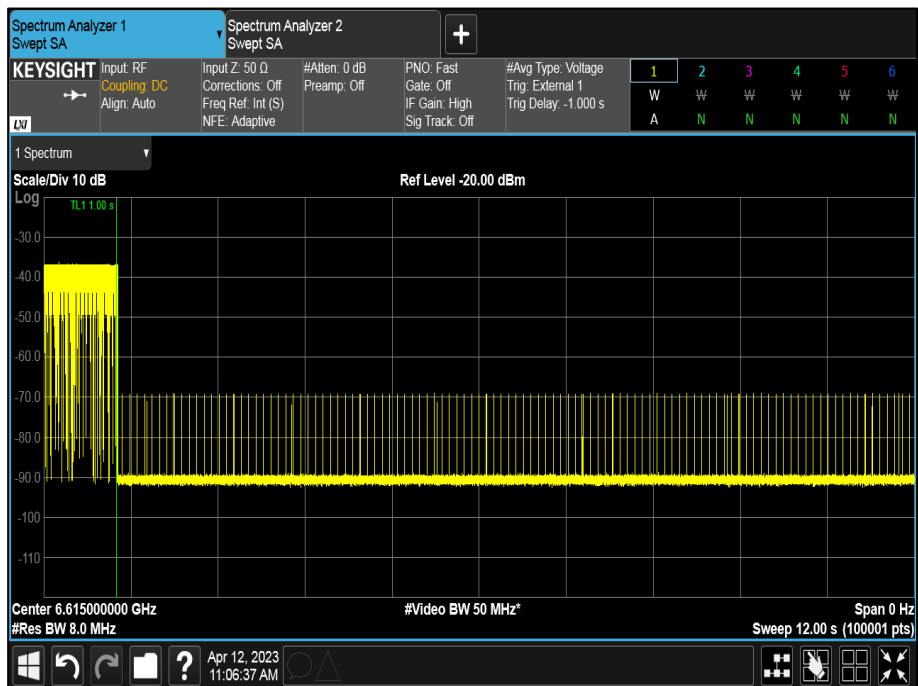

Figure 181 - U-NII-7, Minimum Bandwidth (AWGN Low)



Parameter	Results		
U-NII Band	7	7	7
Channel Number	143	143	143
Bandwidth (MHz)	160	160	160
DUT Centre Frequency (MHz)	6665	6665	6665
AWGN Centre Frequency (MHz)	6665	6665	6665
AWGN Signal Power (dBm)	-65.02	-64.04	-63.56
Antenna Gain (dBi)	2.25	2.25	2.25
Adjusted Power (dBm)	-67.27	-66.29	-65.81
Detection Limit (dBm)	-62.0	-62.0	-62.0
EUT Tx Status (OFF/Minimal/ON)	ON	Minimal	OFF

Table 405 - U-NII-7, Maximum Bandwidth (AWGN Mid)

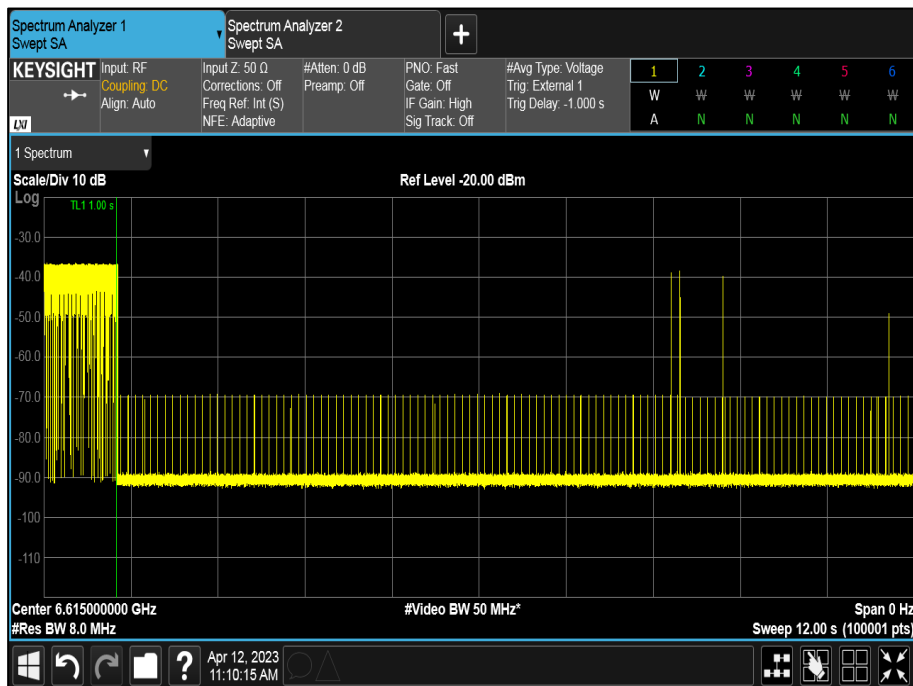

Figure 182 - U-NII-7, Minimum Bandwidth (AWGN Mid)



Parameter	Results		
U-NII Band	7	7	7
Channel Number	143	143	143
Bandwidth (MHz)	160	160	160
DUT Centre Frequency (MHz)	6665	6665	6665
AWGN Centre Frequency (MHz)	6740	6740	6740
AWGN Signal Power (dBm)	-61.96	-61.26	-60.98
Antenna Gain (dBi)	2.25	2.25	2.25
Adjusted Power (dBm)	-64.21	-63.51	-63.23
Detection Limit (dBm)	-62.0	-62.0	-62.0
EUT Tx Status (OFF/Minimal/ON)	ON	Minimal	OFF

Table 406 - U-NII-7, Maximum Bandwidth (AWGN High)

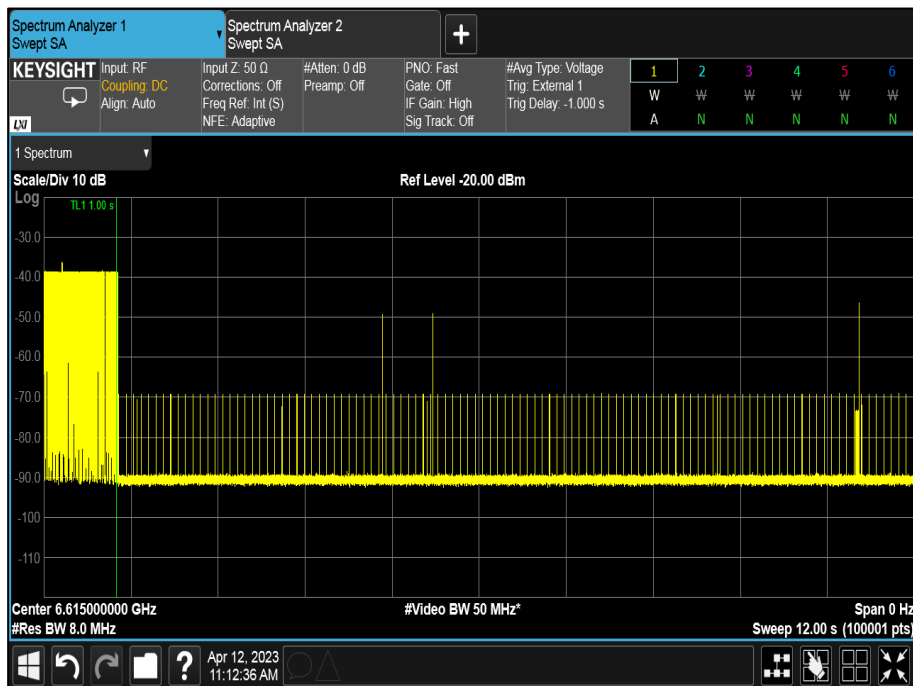

Figure 183 - U-NII-7, Minimum Bandwidth (AWGN High)



Parameter	Results		
U-NII Band	8	8	8
Channel Number	197	197	197
Bandwidth (MHz)	20	20	20
DUT Centre Frequency (MHz)	6935	6935	6935
AWGN Centre Frequency (MHz)	6935	6935	6935
AWGN Signal Power (dBm)	-71.08	-70.57	-69.38
Antenna Gain (dBi)	1.24	1.24	1.24
Adjusted Power (dBm)	-72.32	-71.81	-70.62
Detection Limit (dBm)	-62.0	-62.0	-62.0
EUT Tx Status (OFF/Minimal/ON)	ON	Minimal	OFF

Table 407 - U-NII-8, Minimum Bandwidth

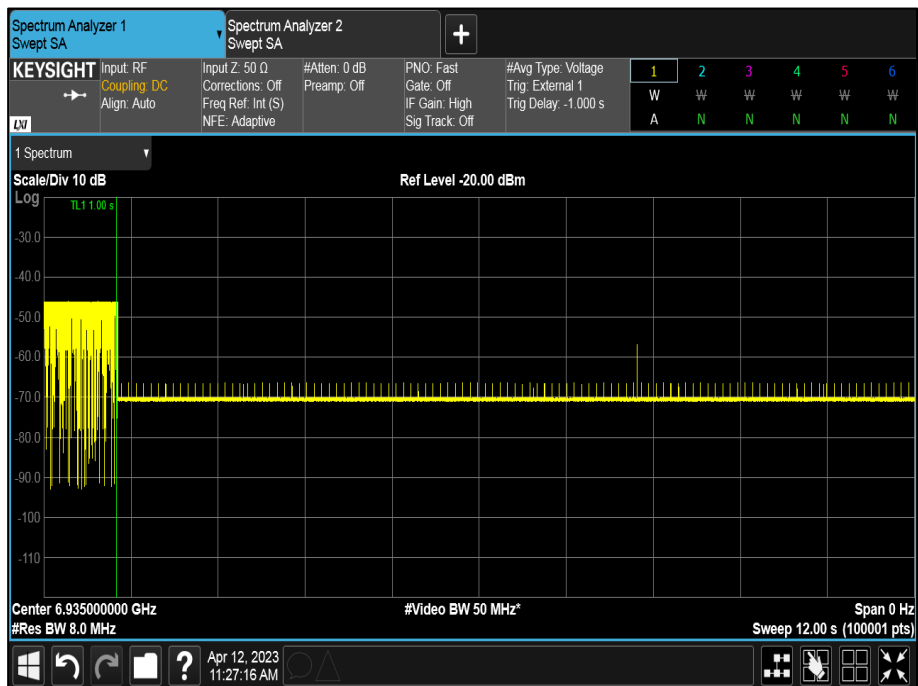

Figure 184 - U-NII-8, Minimum Bandwidth



Parameter	Results		
U-NII Band	7	7	7
Channel Number	143	143	143
Bandwidth (MHz)	160	160	160
DUT Centre Frequency (MHz)	6665	6665	6665
AWGN Centre Frequency (MHz)	6590	6590	6590
AWGN Signal Power (dBm)	-62.46	-62.36	-61.16
Antenna Gain (dBi)	2.25	2.25	2.25
Adjusted Power (dBm)	-64.71	-64.61	-63.41
Detection Limit (dBm)	-62.0	-62.0	-62.0
EUT Tx Status (OFF/Minimal/ON)	ON	Minimal	OFF

Table 408 - U-NII-8, Maximum Bandwidth (AWGN Low)

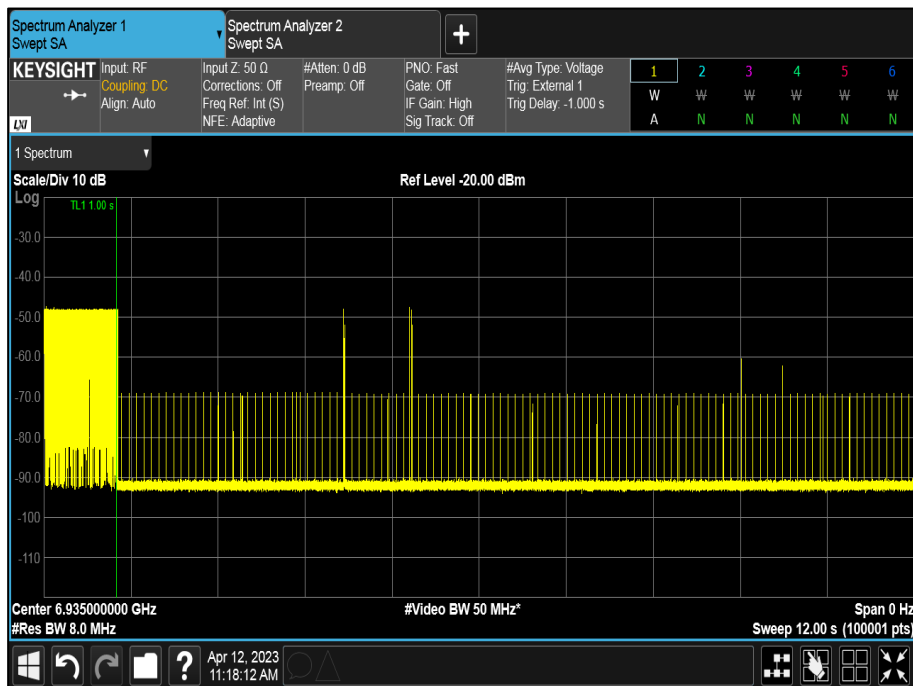

Figure 185 - U-NII-8, Minimum Bandwidth (AWGN Low)



Parameter	Results		
U-NII Band	8	8	8
Channel Number	207	207	207
Bandwidth (MHz)	160	160	160
DUT Centre Frequency (MHz)	6985	6985	6985
AWGN Centre Frequency (MHz)	6985	6985	6985
AWGN Signal Power (dBm)	-67.48	-66.80	-66.11
Antenna Gain (dBi)	1.24	1.24	1.24
Adjusted Power (dBm)	-68.72	-68.04	-67.35
Detection Limit (dBm)	-62.0	-62.0	-62.0
EUT Tx Status (OFF/Minimal/ON)	ON	Minimal	OFF

Table 409 - U-NII-8, Maximum Bandwidth (AWGN Mid)

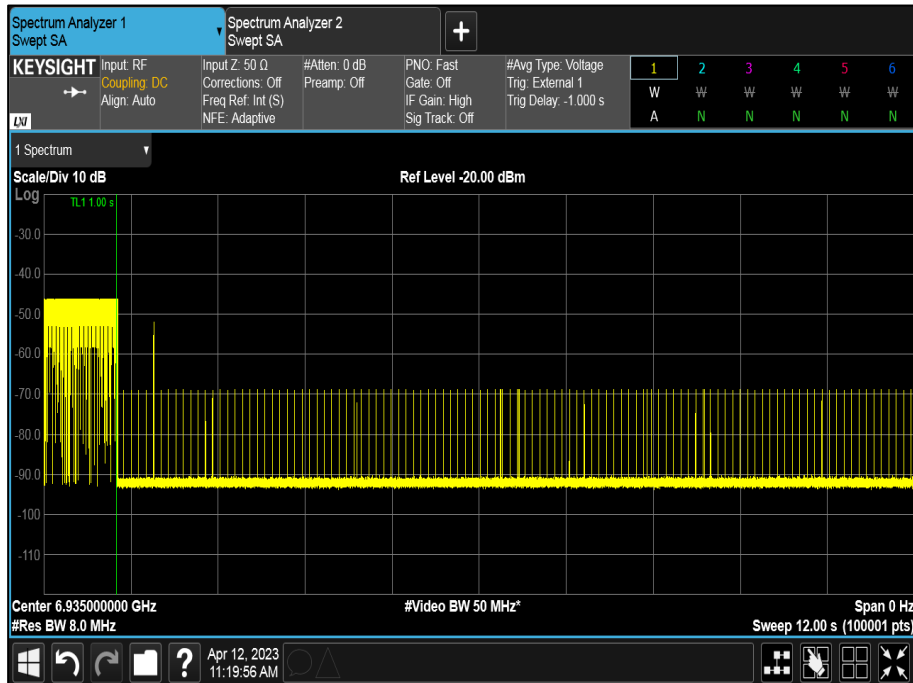

Figure 186 - U-NII-8, Minimum Bandwidth (AWGN Mid)



Parameter	Results		
U-NII Band	8	8	8
Channel Number	207	207	207
Bandwidth (MHz)	160	160	160
DUT Centre Frequency (MHz)	6985	6985	6985
AWGN Centre Frequency (MHz)	7060	7060	7060
AWGN Signal Power (dBm)	-64.93	-62.76	-62.07
Antenna Gain (dBi)	1.24	1.24	1.24
Adjusted Power (dBm)	-66.17	-64.00	-63.31
Detection Limit (dBm)	-62.0	-62.0	-62.0
EUT Tx Status (OFF/Minimal/ON)	ON	Minimal	OFF

Table 410 - U-NII-8, Maximum Bandwidth (AWGN High)

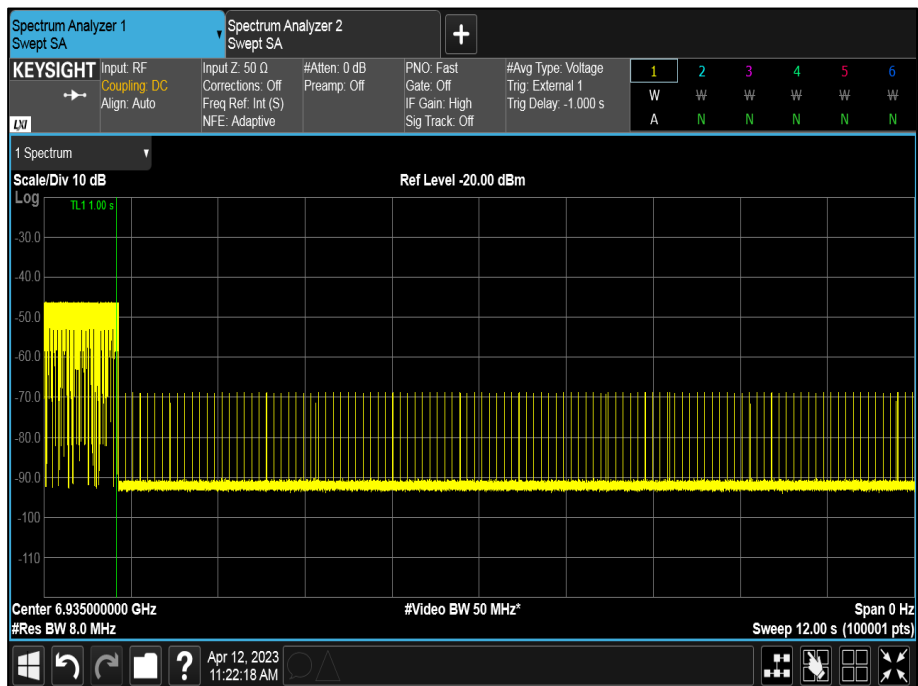

Figure 187 - U-NII-8, Minimum Bandwidth (AWGN High)



FCC 47 CFR Part 15.407 (d)(6)

Indoor access points, subordinate devices and client devices operating in the 5.925–7.125 GHz band must employ a contention-based protocol.

KDB 987594, Limit Clause I

Indoor access points, subordinate devices and client devices operating in the 5.925-7.125 GHz band (herein referred to as unlicensed devices) are required to use technologies that include a contention-based protocol to avoid co-channel interference with incumbent devices sharing the band. To ensure incumbent co-channel operations are detected in a technology-agnostic manner, unlicensed devices are required to detect co-channel radio frequency energy (energy detect) and avoid simultaneous transmission.

Unlicensed low-power indoor devices must detect co-channel radio frequency power that is at least -62 dBm or lower. Upon detection of energy in the band, unlicensed low power indoor devices must vacate the channel (in which incumbent signal is transmitted) and stay off the incumbent channel as long as detected radio frequency power is equal to or greater than the threshold (-62 dBm). The -62 dBm (or lower) threshold is referenced to a 0 dBi antenna gain.

To ensure incumbent operations are reliably detected in the band, low power indoor devices must detect RF energy throughout their intended operating channel. For example, an 802.11 device that plans to transmit a 40 MHz- wide signal (on a primary 20 MHz channel and a secondary 20 MHz channel) must detect energy throughout the entire 40 MHz channel. Additionally, low-power indoor devices must detect co-channel energy with 90% or greater certainty.

ISED RSS-248, Limit Clause 4.8.2

The RLAN devices shall utilize a contention-based protocol to detect the presence of any emissions on the channel that the RLAN device intends to occupy. The RLAN device must detect within its entire occupied bandwidth a radio frequency power of -62 dBm or lower. The minimum detection threshold power is the received power averaged over a 1microsecond reference to a 0 dBi antenna.

If an emission is detected, the RLAN device shall vacate the occupied channel and shall not transmit on this channel until the detected radio frequency power is equal to or greater than the -62 dBm threshold.



2.7.8 Test Location and Test Equipment Used

This test was carried out in RF Chamber 18.

Instrument	Manufacturer	Type No.	TE No.	Calibration Period (months)	Calibration Expiry Date
EXA	Keysight Technologies	N9010B	4969	24	07-Feb-2024
Cable (18 GHz)	Rosenberger	LU7-071-1000	5103	12	18-Dec-2023
Cable (18 GHz)	Rosenberger	LU7-071-2000	5106	12	18-Dec-2023
2.92mm 1m cable	Junkosha	MWX211/B	5415	12	24-Jul-2023
3.5 mm 1m Cable	Junkosha	MWX221-01000DMS	5416	12	06-Mar-2024
Attenuator 5W 20dB DC-18GHz	Aaren	AT40A-4041-D18-20	5498	12	16-May-2023
2-Way Power Divider (2-8 GHz)	Aaren	AT30A-TE0208-2-AF	5687	12	23-Feb-2024
Vector Signal Generator	Rohde & Schwarz	SMM100A	5915	36	01-Mar-2026
WiFi 6E Tri-Band Gaming Router	Asus	GT-AXE110000	5926	-	TU
Humidity & Temperature meter	R.S Components	1364	6148	12	17-Jun-2023
Test Coupling Network	TUV SUD	TUV_RxTest_001	6387	-	O/P Mon

Table 411

TU - Traceability Unscheduled

O/P Mon - Output Monitored using calibrated equipment



3 Measurement Uncertainty

For a 95% confidence level, the measurement uncertainties for defined systems are:

Test Name	Measurement Uncertainty
Emission Bandwidth	± 678.51 kHz
Maximum Conducted Output Power	± 1.38 dB
Maximum Conducted Power Spectral Density	± 1.49 dB
Authorised Band Edges	± 6.3 dB
Spurious Radiated Emissions	30 MHz to 1 GHz: ± 5.2 dB 1 GHz to 40 GHz: ± 6.3 dB
Unwanted Emissions within the 5925-7125 MHz band	± 3.45 dB
Contention Based Protocol	Time: 0.30% Interferer BW: 267.98 kHz Interferer Level: 0.80 dB

Table 412

Measurement Uncertainty Decision Rule – Accuracy Method

Determination of conformity with the specification limits is based on the decision rule according to IEC Guide 115:2021, Clause 4.4.3 (Procedure 2). The measurement results are directly compared with the test limit to determine conformance with the requirements of the standard.

Risk: The uncertainty of measurement about the measured result is negligible with regard to the final pass/fail decision. The measurement result can be directly compared with the test limit to determine conformance with the requirement (compare IEC Guide 115). The level of risk to falsely accept and falsely reject items is further described in ILAC-G8.