

TEST REPORT

Test Report No. : UL-RPT-RP14614912JD02E

Customer : Apple Inc.
Model No. / HVIN : A2901
PMN : Mac Studio
FCC ID : BCGA2901
ISED Certification No. : IC: 579C-A2901
Technology : *Bluetooth* – Low Energy
Test Standard(s) : FCC Parts 15.209(a) & 15.247
Innovation, Science and Economic Development Canada
RSS-247 Issue 2 February 2017
RSS-Gen Issue 5 February 2021
Test Laboratory : UL International (UK) Ltd, Basingstoke, Hampshire, RG24 8AH,
United Kingdom

1. This test report shall not be reproduced except in full, without the written approval of UL International (UK) Ltd.
2. The results in this report apply only to the sample(s) tested.
3. The sample tested is in compliance with the above standard(s).
4. The test results in this report are traceable to the national or international standards.
5. Version 1.0.

Date of Issue: 04 May 2023

Checked by:



Sarah Williams
RF Operations Leader, Radio Laboratory

Sarah Williams Digitally signed
by Sarah Williams
Date: 2023.05.04
11:54:13 +01'00'

Company Signatory:



Ben Mercer
Lead Project Engineer, Radio Laboratory

Ben Mercer Digitally signed
by Ben Mercer
Date: 2023.05.04
11:55:23 +01'00'



The *Bluetooth*® word mark and logos are owned by the *Bluetooth* SIG, Inc. and any use of such marks by UL International (UK) Ltd is under licence. Other trademarks and trade names are those of their respective owners.

UL International (UK) LTD

Unit 1-3 Horizon, Kingsland Business Park, Wade Road, Basingstoke, Hampshire, RG24 8AH, UK
Telephone: +44 (0)1256 312000

Customer Information

Company Name:	Apple Inc.
Address:	One Apple Park Way Cupertino, California 95014 U.S.A.
Contact Name:	Stuart Thomas

Report Revision History

Version Number	Issue Date	Revision Details	Revised By
1.0	04/05/2023	Initial Version	Sarah Williams

Table of Contents

Customer Information.....	2
Report Revision History	2
Table of Contents.....	3
1 Attestation of Test Results.....	4
1.1 Description of EUT	4
1.2 General Information	4
1.3 Summary of Test Results	4
1.4 Deviations from the Test Specification	4
2 Summary of Testing.....	5
2.1 Facilities and Accreditation	5
2.2 Methods and Procedures	5
2.3 Calibration and Uncertainty	6
2.4 Test and Measurement Equipment	7
3 Equipment Under Test (EUT)	9
3.1 Identification of Equipment Under Test (EUT)	9
3.2 Modifications Incorporated in the EUT	9
3.3 Additional Information Related to Testing	10
3.4 Description of Available Antennas	10
3.5 Description of Test Setup	11
4 Antenna Port Test Results	17
4.1 Transmitter 99% Occupied Bandwidth	17
4.2 Transmitter Minimum 6 dB Bandwidth	26
4.3 Transmitter Maximum Peak Output Power	35
4.4 Transmitter Power Spectral Density	50
5 Radiated Test Results.....	59
5.1 Transmitter Radiated Emissions <1 GHz	59
5.2 Transmitter Radiated Emissions >1 GHz	61
5.3 Transmitter Band Edge Radiated Emissions	63

1 Attestation of Test Results

1.1 Description of EUT

The equipment under test was an Apple desktop computer with Bluetooth®, Bluetooth® Low Energy, Thread and IEEE 802.11 a/b/g/n/ac/ax Wi-Fi capabilities in the 2.4 GHz, 5 GHz and 6 GHz bands.

1.2 General Information

Specification Reference:	47CFR15.247
Specification Title:	Code of Federal Regulations Volume 47 (Telecommunications): Part 15 Subpart C (Intentional Radiators) – Section 15.247
Specification Reference:	47CFR15.209
Specification Title:	Code of Federal Regulations Volume 47 (Telecommunications): Part 15 Subpart C (Intentional Radiators) – Section 15.209
Specification Reference:	RSS-Gen Issue 5 February 2021
Specification Title:	General Requirements for Compliance of Radio Apparatus
Specification Reference:	RSS-247 Issue 2 February 2017
Specification Title:	Digital Transmission Systems (DTSs), Frequency Hopping Systems (FHSs) and Licence-Exempt Local Area Network (LE-LAN) Devices
Site Registration:	FCC: 685609, ISEDC: 20903
FCC Lab. Designation No.:	UK2011
ISEDC CABID:	UK0001
Location of Testing:	Unit 3 Horizon, Wade Road, Kingsland Business Park, Basingstoke, Hampshire, G24 8AH, United Kingdom
Test Dates:	21 February 2023 to 27 April 2023

1.3 Summary of Test Results

FCC Reference (47CFR)	ISED Canada Reference	Measurement	Result
N/A	RSS-Gen 6.7	Transmitter 99% Occupied Bandwidth	Complied
Part 15.247(a)(2)	RSS-Gen 6.7 / RSS-247 5.2(a)	Transmitter Minimum 6 dB Bandwidth	Complied
Part 15.247(b)(3)	RSS-Gen 6.12 / RSS-247 5.4(d)	Transmitter Maximum Peak Output Power	Complied
Part 15.247(e)	RSS-247 5.2(b)	Transmitter Power Spectral Density	Complied
Part 15.247(d) & 15.209(a)	RSS-Gen 6.13 / RSS-247 5.5	Transmitter Radiated Emissions	Complied
Part 15.247(d) & 15.209(a)	RSS-Gen 6.13 / RSS-247 5.5	Transmitter Band Edge Radiated Emissions	Complied

1.4 Deviations from the Test Specification

For the measurements contained within this test report, there were no deviations from, additions to, or exclusions from the test specification identified above.

2 Summary of Testing

2.1 Facilities and Accreditation

The test site and measurement facilities used to collect data are located at Unit 3 Horizon, Wade Road, Kingsland Business Park, Basingstoke, Hampshire, RG24 8AH, United Kingdom. The following table identifies which facilities were utilised for radiated emission measurements documented in this report. Specific facilities are also identified in the test results sections.

Site 1	X
Site 2	-
Site 17	X

UL International (UK) Ltd is accredited by the United Kingdom Accreditation Service (UKAS). UKAS is one of the signatories to the International Laboratory Accreditation Co-operation (ILAC) Arrangement for the mutual recognition of test reports. The tests reported herein have been performed in accordance with its terms of accreditation.

2.2 Methods and Procedures

Reference:	ANSI C63.10-2013
Title:	American National Standard of Procedures for Compliance Testing of Unlicensed Wireless Devices
Reference:	KDB 558074 D01 15.247 Meas Guidance v05r02, April 2, 2019
Title:	Guidance for Compliance Measurements on Digital Transmission System, Frequency Hopping Spread Spectrum System, and Hybrid System Devices Operating Under Section 15.247 of the FCC Rules
Reference:	KDB 662911 D01 Multiple Transmitter Output v02r01 October 31, 2013
Title:	Emissions Testing of Transmitters with Multiple Outputs in the Same Band

2.3 Calibration and Uncertainty

Measuring Instrument Calibration

In accordance with UKAS requirements all the measurement equipment is on a calibration schedule. All equipment was within the calibration period on the date of testing.

Measurement Uncertainty & Decision Rule

Overview

No measurement or test can ever be perfect and the imperfections give rise to error of measurement in the results. Consequently the result of a measurement is only an approximation to the value of the measurand (the specific quantity subject to measurement) and is only complete when accompanied by a statement of the uncertainty of the approximation.

The expression of uncertainty of a measurement result allows realistic comparison of results with reference values and limits given in specifications and standards.

Decision Rule

The decision rule applied is based upon the accuracy method criteria. The measurement uncertainty is met and the result is considered in conformance with the requirement criteria if the observed value is within the prescribed limit.

Measurement Uncertainty

The reported expanded uncertainties below are based on a standard uncertainty multiplied by an appropriate coverage factor such that a confidence level of approximately 95% is maintained. For the purposes of this document “approximately” is interpreted as meaning “effectively” or “for most practical purposes”.

Measurement Type	Range	Confidence Level (%)	Calculated Uncertainty
99% Occupied Bandwidth	2.4 GHz to 2.4835 GHz	95%	±3.92 %
Minimum 6 dB Bandwidth	2.4 GHz to 2.4835 GHz	95%	±4.59 %
Spectral Power Density	2.4 GHz to 2.4835 GHz	95%	±1.13 dB
Conducted Maximum Peak Output Power	2.4 GHz to 2.4835 GHz	95%	±1.13 dB
Radiated Spurious Emissions	9 kHz to 30 MHz	95%	±5.32 dB
Radiated Spurious Emissions	30 MHz to 1 GHz	95%	±3.30 dB
Radiated Spurious Emissions	1 GHz to 25 GHz	95%	±3.16 dB

The methods used to calculate the above uncertainties are in line with those recommended within the various measurement specifications. Where measurement specifications do not include guidelines for the evaluation of measurement uncertainty the published guidance of the appropriate accreditation body is followed.

2.4 Test and Measurement Equipment

Test Equipment Used for Transmitter Conducted Tests

Asset No.	Instrument	Manufacturer	Type No.	Serial No.	Date Calibration Due	Cal. Interval (Months)
M2072	Thermohygrometer	Testo	608-H1	45257961	08 Dec 2023	12
A2507	Attenuator	AtlanTecRF	AN18-10	821846#2	Calibrated before use	-
M225862	Signal Analyser	Rohde & Schwarz	FSV3030	102010	21 Oct 2023	12
A214336	Attenuator	Atlantic Microwave	ATT06KXP-483082-S4S5	#1	Calibrated before use	-
A214343	Attenuator	Atlantic Microwave	ATT06KXP-483082-S4S5	#8	Calibrated before use	-
A214338	Attenuator	Atlantic Microwave	ATT06KXP-483082-S4S5	#3	Calibrated before use	-
A222203	Switch Box	UL	UK version #10010	#2	Calibrated before use	-
G0607	Signal Generator	Rohde & Schwarz	SMU200A	100943	01 Jan 2025	36

Test and Measurement Equipment (continued)**Test Equipment Used for Transmitter Radiated Emissions Tests**

Asset No.	Instrument	Manufacturer	Type No.	Serial No.	Date Calibration Due	Cal. Interval (Months)
M2003	Thermohygrometer	Testo	608-H1	45046641	09 Dec 2023	12
K0017	3m RSE Chamber	Rainford EMC	N/A	N/A	08 Nov 2023	12
M1995	Test Receiver	Rohde & Schwarz	ESU40	100428	02 Nov 2023	12
A2863	Pre-Amplifier	Agilent	8449B	3008A02100	07 Nov 2023	12
A3265	Pre-Amplifier	Schwarzbeck	BBV 9721	9721-069	31 Oct 2023	12
A223628	Pre-Amplifier	Atlantic Microwave	A-LNAKX-380116-S5S5	210837001	03 Nov 2023	12
A2889	Antenna	Schwarzbeck	BBHA 9120 B	00653	02 Nov 2023	12
A2890	Antenna	Schwarzbeck	HWRD 750	014	02 Nov 2023	12
A2892	Antenna	Schwarzbeck	BBHA 9170	9170-727	31 Oct 2023	12
A2916	Attenuator	AtlanTecRF	AN18W5-10	832827#2	25 Jan 2024	12
A2914	High Pass Filter	AtlanTecRF	AFH-03000	2155	25 Jan 2024	12
A2947	High Pass Filter	AtlanTecRF	AFH-07000	1601900001	25 Jan 2024	12
M2040	Thermohygrometer	Testo	608-H1	45124934	09 Dec 2023	12
K0001	3m RSE Chamber	Rainford EMC	N/A	N/A	05 Sep 2023	12
M1874	Test Receiver	Rohde & Schwarz	ESU26	100553	19 May 2023	12
A3165	Magnetic Loop Antenna	ETS-Lindgren	6502	00224383	05 May 2023	12
A3154	Pre-Amplifier	Com-Power	PAM-103	18020012	18 Aug 2023	12
A3085	Low Pass Filter	AtlanTecRF	AFL-02000	18051600014	26 Jan 2024	12
A3113	Attenuator	AtlanTecRF	AN18-06	219706#3	03 May 2023	12
A3161	Antenna	Teseq	CBL6111D	50859	03 May 2023	12

Test Equipment Used for Transmitter Band Edge Radiated Emissions Tests

Asset No.	Instrument	Manufacturer	Type No.	Serial No.	Date Calibration Due	Cal. Interval (Months)
M2003	Thermohygrometer	Testo	608-H1	45046641	09 Dec 2023	12
K0017	3m RSE Chamber	Rainford EMC	N/A	N/A	08 Nov 2023	12
M1995	Test Receiver	Rohde & Schwarz	ESU40	100428	02 Nov 2023	12
A2863	Pre-Amplifier	Agilent	8449B	3008A02100	07 Nov 2023	12
A2889	Antenna	Schwarzbeck	BBHA 9120 B	00653	02 Nov 2023	12
A2916	Attenuator	AtlanTecRF	AN18W5-10	832827#2	25 Jan 2024	12

3 Equipment Under Test (EUT)

3.1 Identification of Equipment Under Test (EUT)

Brand Name:	Apple
Model Name or Number / HVIN:	A2901
PMN:	Mac Studio
Test Sample Serial Number:	RKQ16RPGYY (<i>Conducted sample</i>)
Hardware Version:	REV 1.0
Software Version:	22E61680r
FCC ID:	BCGA2901
ISED Canada Certification Number:	IC: 579C-A2901
Date of Receipt:	03 April 2023

Brand Name:	Apple
Model Name or Number / HVIN:	A2901
PMN:	Mac Studio
Test Sample Serial Number:	WGCDCC9QNK (<i>Radiated sample</i>)
Hardware Version:	REV 1.0
Software Version:	22E61680r
FCC ID:	BCGA2901
ISED Canada Certification Number:	IC: 579C-A2901
Date of Receipt:	10 February 2023

3.2 Modifications Incorporated in the EUT

No modifications were applied to the EUT during testing.

3.3 Additional Information Related to Testing

Technology Tested:	Bluetooth Low Energy (Digital Transmission System)		
Type of Unit:	Transceiver		
Channel Spacing:	2 MHz		
Modulation:	GFSK		
Data Rate: LE1M	1 Mbps		
Data Rate: LE2M	2 Mbps		
Power Supply Requirement(s):	Nominal	12 VDC via 120 VAC 60 Hz	
Maximum Conducted Output Power:	9.4 dBm		
Transmit Frequency Range:	2400 MHz to 2483.5 MHz		
Transmit Channels Tested:	Channel ID	Channel Number	Channel Frequency (MHz)
	Bottom	37	2402
	Middle	17	2440
	Top	39	2480

3.4 Description of Available Antennas

The radio utilizes three integrated antennas, with the following maximum gains:

Antenna Port	Frequency Range (MHz)	Antenna Gain (dBi)
Core 0	2400 to 2480	3.1
Core 1	2400 to 2480	0.9
Dedicated Core	2400 to 2480	0.7

The EUT also supports TxBF with unequal gains and equal transmit powers. Calculations for directional gain were in accordance with KDB 662911 D01 v02r01 Section F)2)d)(i). Directional gain of Core 0 & Core 1 was calculated as:

$$N_{ANT} = 2, G_{Core0} = 3.1 \text{ dBi}, G_{Core1} = 0.9 \text{ dBi}$$

$$\begin{aligned} \text{Directional Gain} &= 10 \log \left[\frac{\left(10^{\frac{G_1}{20}} + 10^{\frac{G_2}{20}} + \dots + 10^{\frac{G_N}{20}} \right)^2}{N_{ANT}} \right] = 10 \log \left[\frac{\left(10^{\frac{G_1}{20}} + 10^{\frac{G_2}{20}} \right)^2}{2} \right] \\ &= 10 \log \left[\frac{\left(10^{\frac{3.1}{20}} + 10^{\frac{0.9}{20}} \right)^2}{2} \right] = 5.1 \text{ dBi} \end{aligned}$$

3.5 Description of Test Setup

Support Equipment

The following support equipment was used to exercise the EUT during testing:

Description:	Test Laptop
Brand Name:	Apple
Model Name or Number:	MacBook Pro
Serial Number:	C02YK003L59F

Description:	USB Diagnostic Cable
Brand Name:	Apple
Model Name or Number:	Chimp
Serial Number:	428A84

Description:	USB-C Dock Termination Hub
Brand Name:	Lenovo
Model Name or Number:	40A9
Serial Number:	ZAF0LGYW

Description:	HDMI Termination Hub
Brand Name:	Lemorele
Model Name or Number:	#TC19
Serial Number:	Not marked or stated

Description:	USB-A Cables. Quantity 6. Length 3 m.
Brand Name:	Not marked or stated
Model Name or Number:	Not marked or stated
Serial Number:	Not marked or stated

Description:	USB-C Cables. Quantity 2. Length 3 m.
Brand Name:	Not marked or stated
Model Name or Number:	Not marked or stated
Serial Number:	Not marked or stated

Description:	USB A to C Converter. Quantity 3.
Brand Name:	Amazon Basics
Model Name or Number:	Not marked or stated
Serial Number:	Not marked or stated

Support Equipment (continued)

Description:	USB A to C Converter
Brand Name:	UGREEN
Model Name or Number:	Not marked or stated
Serial Number:	Not marked or stated

Description:	USB Termination Hub
Brand Name:	Hama
Model Name or Number:	Not marked or stated
Serial Number:	Not marked or stated

Description:	HDMI Cable. Length 3 m.
Brand Name:	Not marked or stated
Model Name or Number:	Not marked or stated
Serial Number:	Not marked or stated

Description:	Ethernet Cable. Length 3 m.
Brand Name:	Not marked or stated
Model Name or Number:	Not marked or stated
Serial Number:	Not marked or stated

Description:	Personal Hands Free (PHF)
Brand Name:	Not marked or stated
Model Name or Number:	Not marked or stated
Serial Number:	Not marked or stated

Description:	MicroSD Card & SC Card Adaptor.
Brand Name:	Not marked or stated
Model Name or Number:	Not marked or stated
Serial Number:	Not marked or stated

Description:	Test Laptop
Brand Name:	Apple
Model Name or Number:	MacBook Pro
Serial Number:	C02C8009P22C

Support Equipment (continued)

Description:	USB Diagnostic Cable
Brand Name:	Apple
Model Name or Number:	Chimp
Serial Number:	304708

Operating Modes

The EUT was tested in the following operating mode(s):

- Transmitting at maximum power in *Bluetooth* LE mode with modulation, maximum possible data length available and Pseudorandom Bit Sequence 9.
- Transmitting at maximum power in *Bluetooth* LE2M mode with modulation, maximum possible data length available and Pseudorandom Bit Sequence 9.

Configuration and Peripherals

The EUT was tested in the following configuration(s):

- Controlled in test mode using a set of commands entered into a terminal application on the test laptop supplied by the customer. The commands were used to enable a continuous transmission and to select the test channels as required. The customer supplied a document containing the setup instructions.
- The EUT has a dedicated core (core 2), which operates in SISO mode only, in addition to two cores which operate in both SISO and TxBF modes. Core 0 & Core 1 are identical but have unequal gains therefore conducted tests have been performed on the Core with the highest antenna gain. Modes tested were.
 - LE1M / SISO / Core 0
 - LE2M / SISO / Core 0
 - LE1M / SISO / Core 2
 - LE2M / SISO / Core 2
 - LE1M / Beamforming / Core 0 + Core 1
 - LE2M / Beamforming / Core 0 + Core 1
- The customer supplied U.FL RF cables with the EUT in order to perform conducted measurements. This measured additional path loss was included in any path loss calculations.
- The EUT was powered from a 120 VAC 60 Hz single phase mains supply.
- Transmitter radiated spurious emissions tests were performed with the EUT transmitting in LE2M Beamforming Core 0 + Core 1 mode, as this mode was found to transmit the highest power.
- Radiated spurious emissions were performed with the EUT in the position that produced worst case with respect to emissions. All ports were terminated into suitable terminations and placed under the turntable.

Test Setup Diagrams

Conducted Tests:

Test Setup for Transmitter Conducted Tests

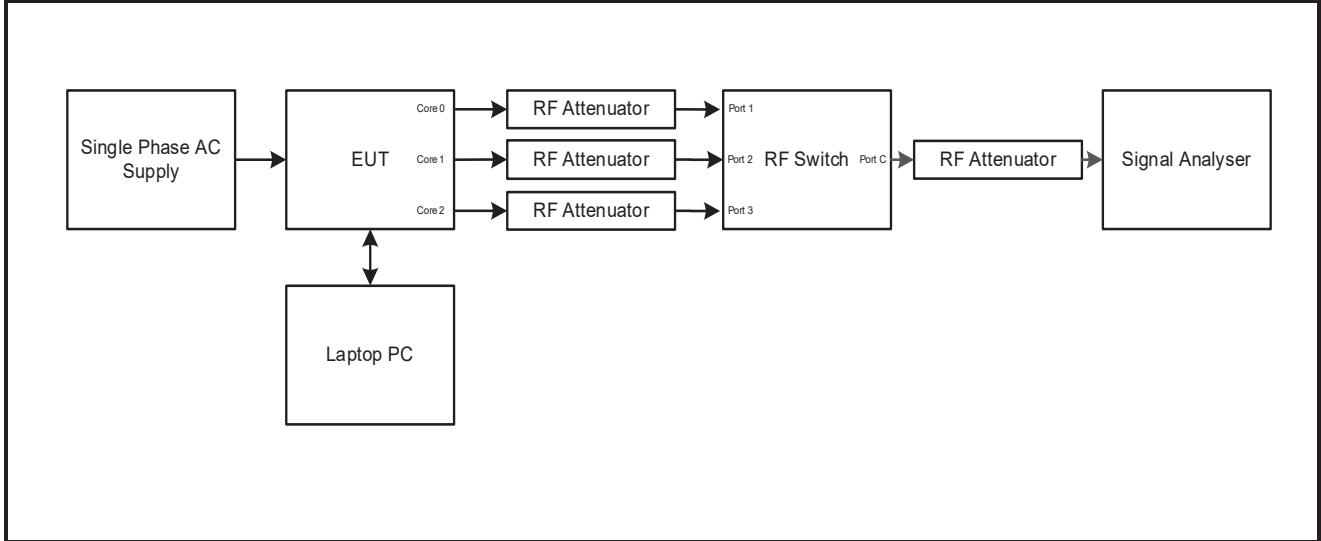

Test Setup Diagrams (continued)

Radiated Tests:

Test Setup for Transmitter Radiated Emissions

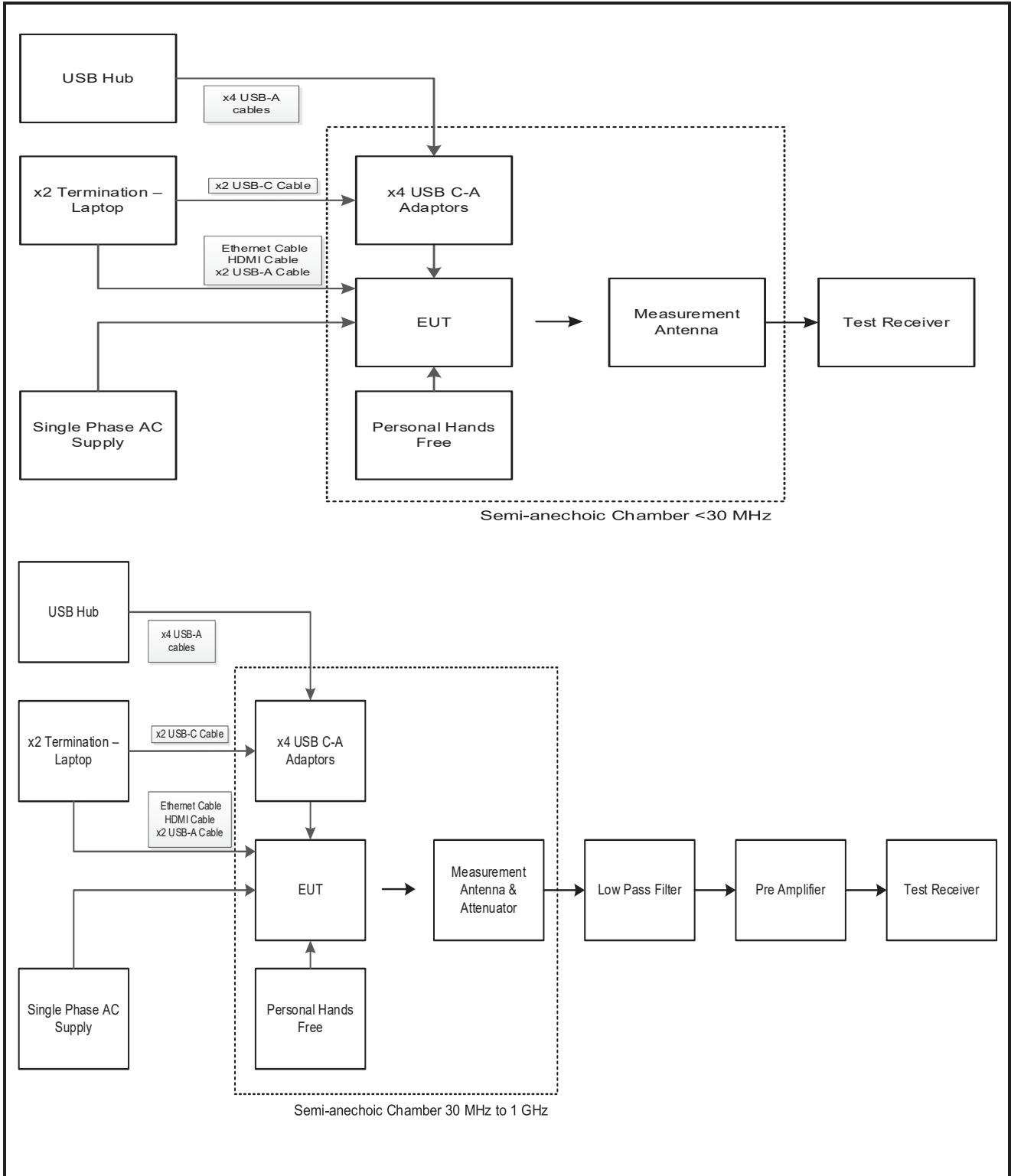

Test Setup Diagrams (continued)

Test Setup for Transmitter Radiated Emissions (continued)

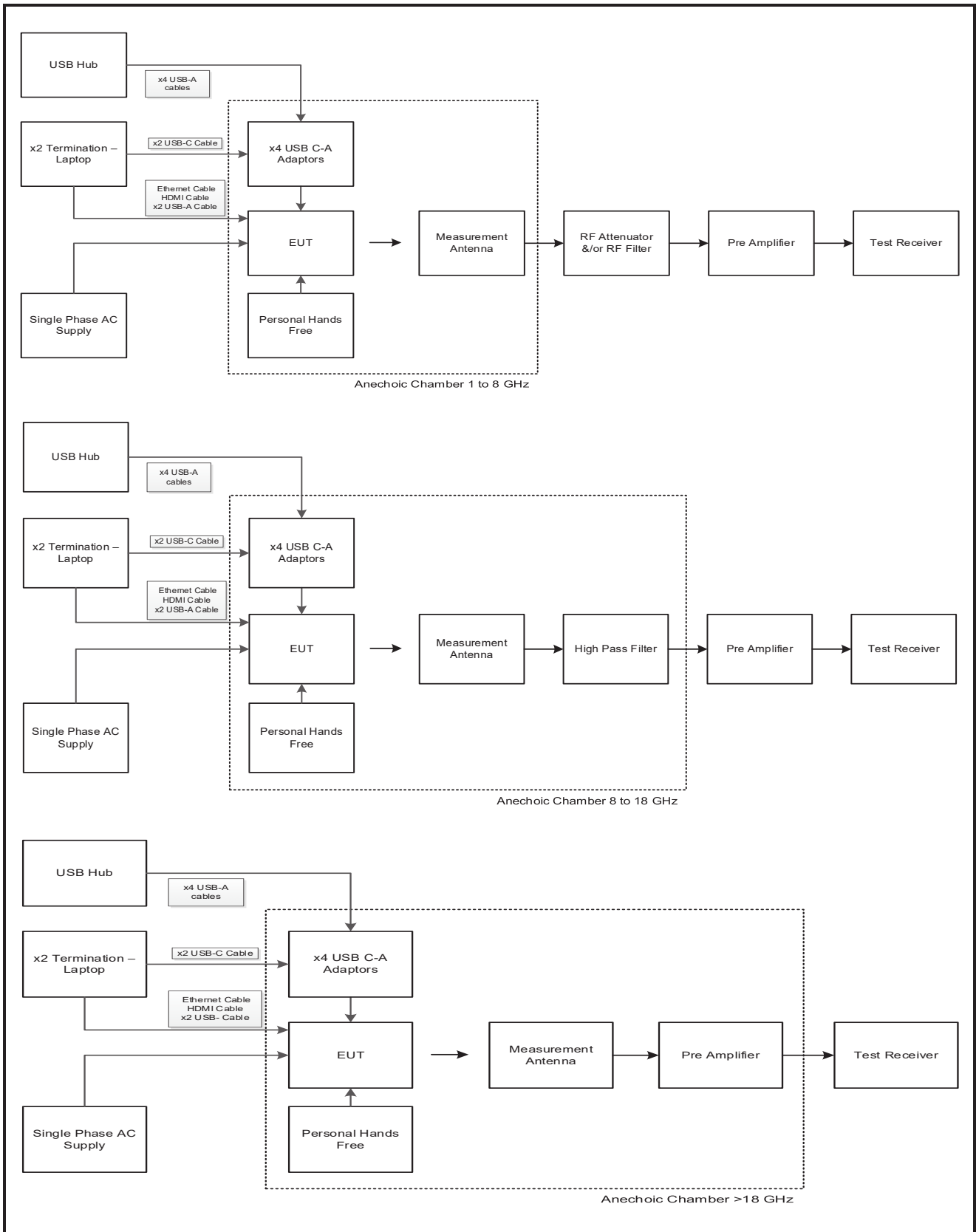

4 Antenna Port Test Results

4.1 Transmitter 99% Occupied Bandwidth

Test Summary:

Test Engineers:	Miriam Thompson & Matthew Botfield	Test Date:	20 April 2023
Test Sample Serial Number:	RKQ16RPGYY		

FCC Reference:	N/A
ISED Canada Reference:	RSS-Gen 6.7
Test Method Used:	RSS-Gen 6.7 and Notes below

Environmental Conditions:

Temperature (°C):	21
Relative Humidity (%):	41

Note(s):

1. The 99% emission bandwidth was measured using the signal analyser occupied bandwidth function. The resolution bandwidth was set in the range of 1% to 5% of the occupied bandwidth and the video bandwidth set to 3 times the resolution bandwidth. The span was set to capture all products of the modulation process including emission skirts.
2. The signal analyser resolution bandwidth was set to 30 kHz and video bandwidth 100 kHz. A peak detector was used, sweep time was set to auto and the trace mode was Max Hold. The span was set to 5 MHz. The signal analyser function set the measurements to be made at 99% of the emission bandwidth. The results are given in the tables below.
3. The signal analyser was connected to the RF port on the EUT using suitable attenuation and RF cable.

Transmitter 99% Occupied Bandwidth (continued)

Results: LE1M / SISO / Core 0

Channel	99% Occupied Bandwidth (kHz)
Bottom	1039.305
Middle	1041.318
Top	1040.748



Bottom Channel



Middle Channel



Top Channel

Transmitter 99% Occupied Bandwidth (continued)

Results: LE2M / SISO / Core 0

Channel	99% Occupied Bandwidth (kHz)
Bottom	2087.443
Middle	2087.125
Top	2087.236



Bottom Channel



Middle Channel



Top Channel

Transmitter 99% Occupied Bandwidth (continued)

Results: LE1M / SISO / Core 2

Channel	99% Occupied Bandwidth (kHz)
Bottom	1038.656
Middle	1039.974
Top	1039.633

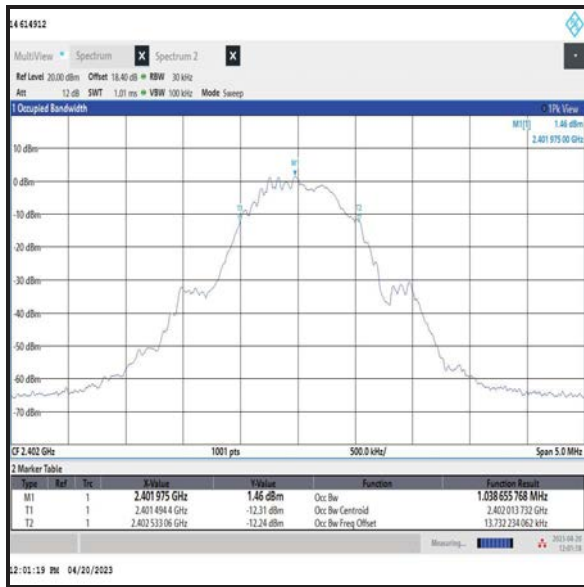

Bottom Channel

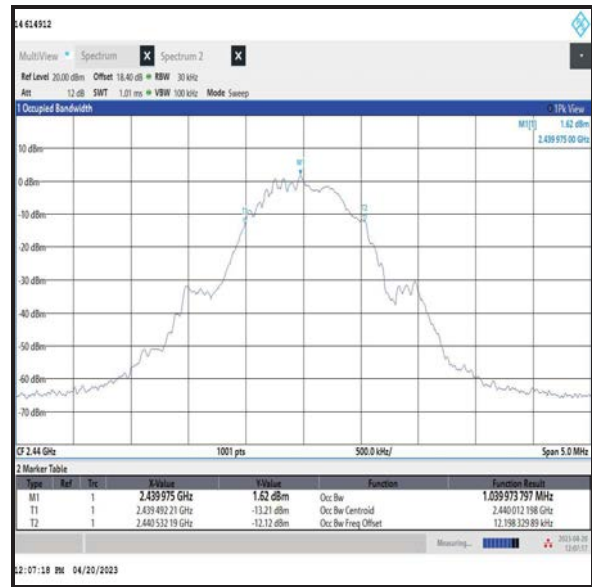

Middle Channel

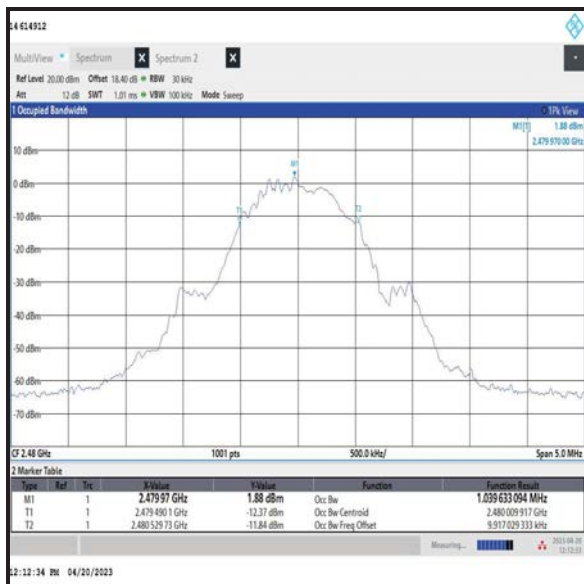

Top Channel

Transmitter 99% Occupied Bandwidth (continued)

Results: LE2M / SISO / Core 2

Channel	99% Occupied Bandwidth (kHz)
Bottom	2087.147
Middle	2085.254
Top	2085.425



Bottom Channel



Middle Channel



Top Channel

Transmitter 99% Occupied Bandwidth (continued)

Results: LE1M / Beamforming / Core 0

Channel	99% Occupied Bandwidth (kHz)
Bottom	1039.471
Middle	1039.587
Top	1039.241



Bottom Channel



Middle Channel

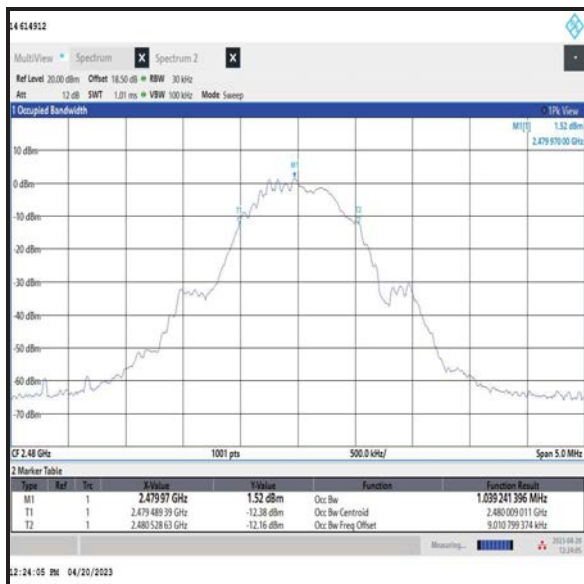

Top Channel

Transmitter 99% Occupied Bandwidth (continued)

Results: LE1M / Beamforming / Core 1

Channel	99% Occupied Bandwidth (kHz)
Bottom	1039.546
Middle	1039.569
Top	1038.430

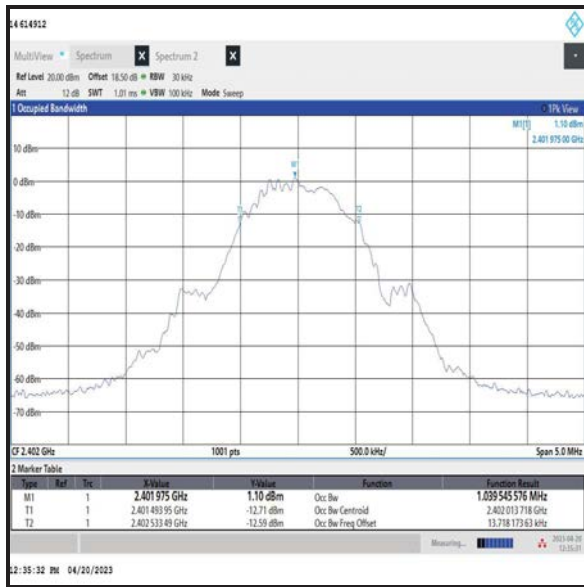

Bottom Channel



Middle Channel

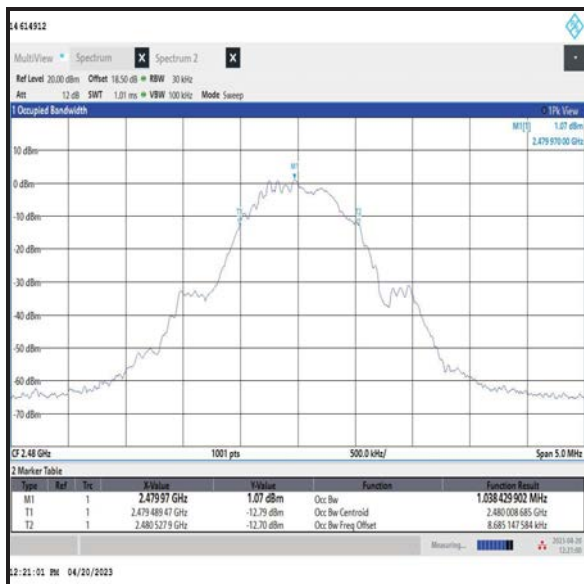

Top Channel

Transmitter 99% Occupied Bandwidth (continued)

Results: LE2M / Beamforming / Core 0

Channel	99% Occupied Bandwidth (kHz)
Bottom	2088.202
Middle	2086.775
Top	2087.175



Bottom Channel



Middle Channel



Top Channel

Transmitter 99% Occupied Bandwidth (continued)

Results: LE2M / Beamforming / Core 1

Channel	99% Occupied Bandwidth (kHz)
Bottom	2087.657
Middle	2086.780
Top	2086.518



Bottom Channel



Middle Channel



Top Channel

4.2 Transmitter Minimum 6 dB Bandwidth

Test Summary:

Test Engineers:	Miriam Thompson & Matthew Botfield	Test Dates:	20 April 2023 & 27 April 2023
Test Sample Serial Number:	RKQ16RPGYY		

FCC Reference:	Part 15.247(a)(2)
ISED Canada Reference:	RSS-Gen 6.7 / RSS-247 5.2(a)
Test Method Used:	FCC KDB 558074 Section 8.2 referencing ANSI C63.10 Section 11.8.1

Environmental Conditions:

Temperature (°C):	21
Relative Humidity (%):	40 to 41

Note(s):

- 6 dB DTS bandwidth tests were performed using a signal analyser in accordance with ANSI C63.10 Section 11.8.1 Option 1 measurement procedure. The signal analyser resolution bandwidth was set to 100 kHz and video bandwidth 300 kHz. A peak detector was used, sweep time was set to auto and the trace mode was Max Hold. The DTS bandwidth was measured at 6 dB down from the peak of the signal.
- The signal analyser was connected to the RF port on the EUT using suitable attenuation and RF cable.

Transmitter Minimum 6 dB Bandwidth (continued)

Results: LE1M / SISO / Core 0

Channel	6 dB Bandwidth (kHz)	Limit (kHz)	Margin (kHz)	Result
Bottom	719.300	≥500	219.300	Complied
Middle	723.300	≥500	223.300	Complied
Top	723.300	≥500	223.300	Complied

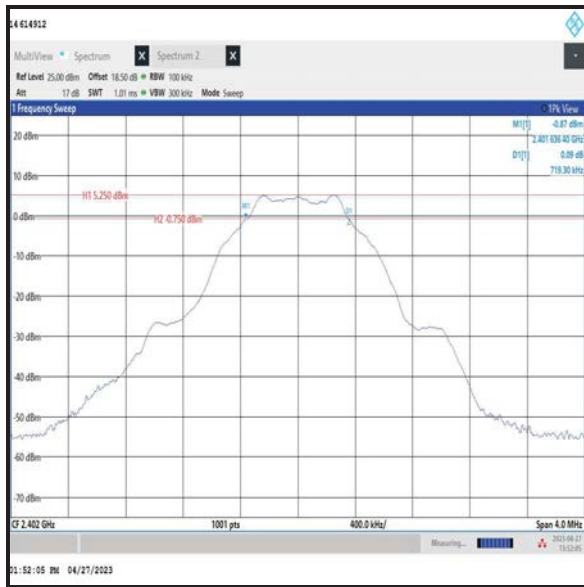

Bottom Channel

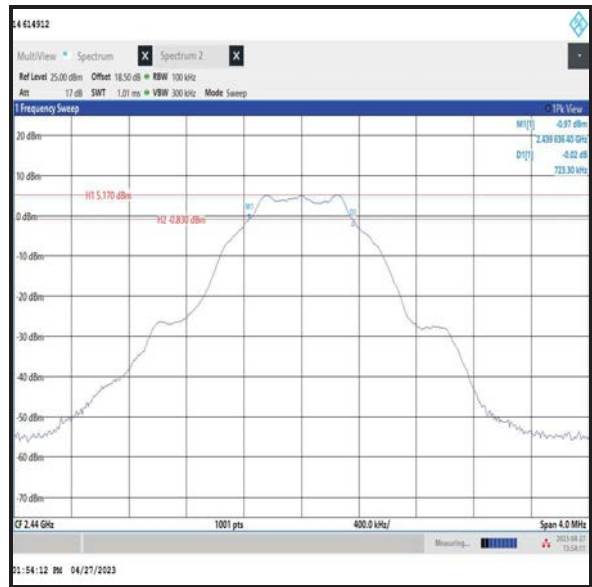

Middle Channel

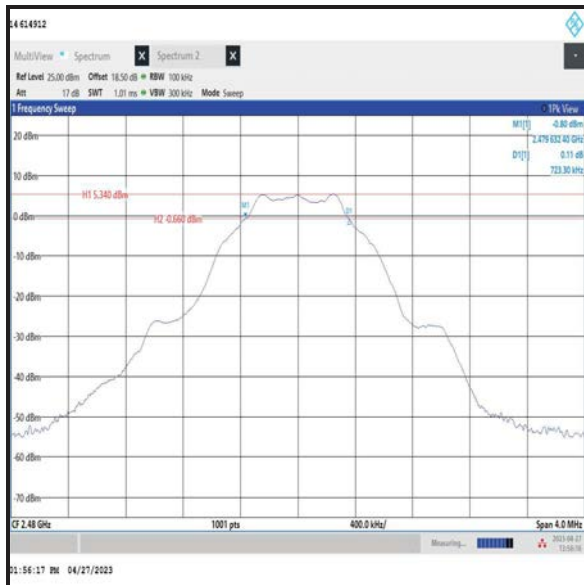

Top Channel

Transmitter Minimum 6 dB Bandwidth (continued)

Results: LE2M / SISO / Core 0

Channel	6 dB Bandwidth (kHz)	Limit (kHz)	Margin (kHz)	Result
Bottom	1278.700	≥500	778.700	Complied
Middle	1263.700	≥500	Complied	
Top	1268.700	≥500	768.700	Complied

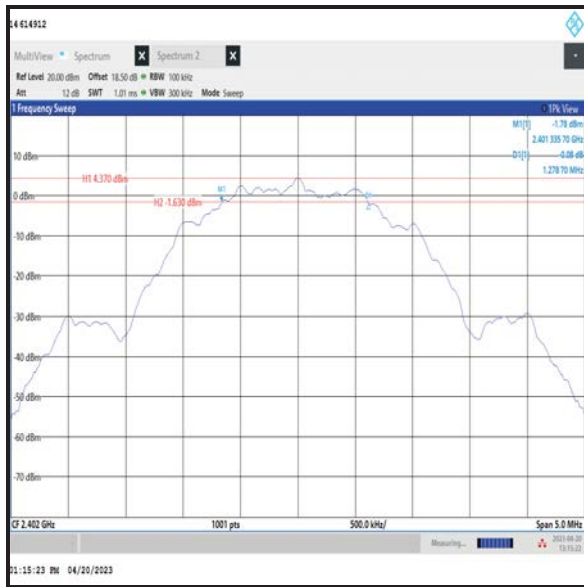

Bottom Channel

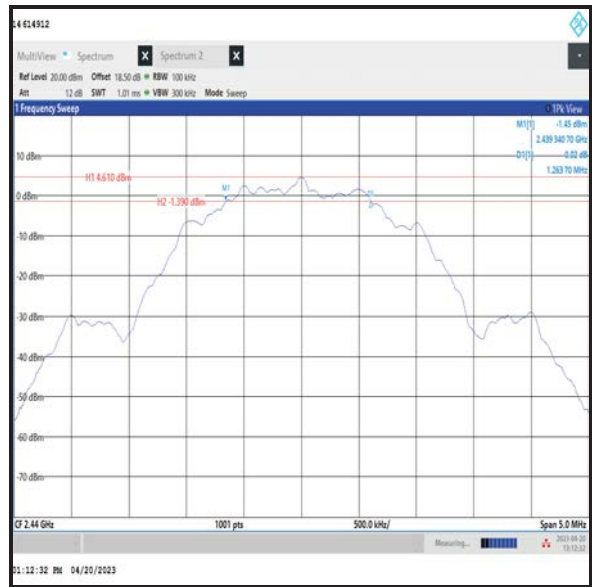

Middle Channel

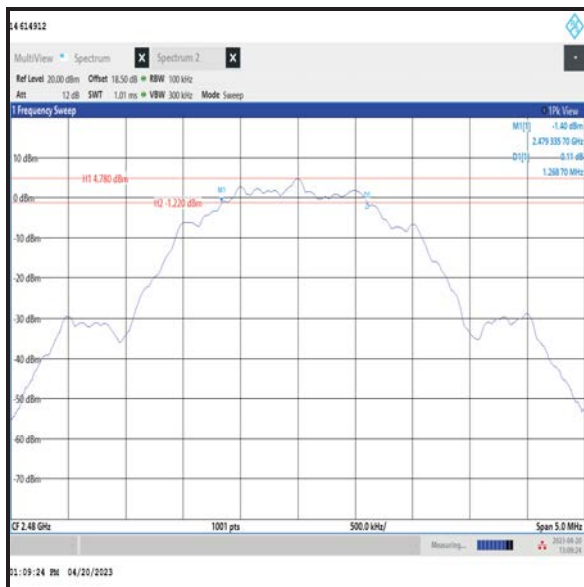

Top Channel

Transmitter Minimum 6 dB Bandwidth (continued)

Results: LE1M / SISO / Core 2

Channel	6 dB Bandwidth (kHz)	Limit (kHz)	Margin (kHz)	Result
Bottom	719.300	≥500	219.300	Complied
Middle	691.300	≥500	Complied	
Top	675.300	≥500	175.300	Complied



Bottom Channel



Middle Channel

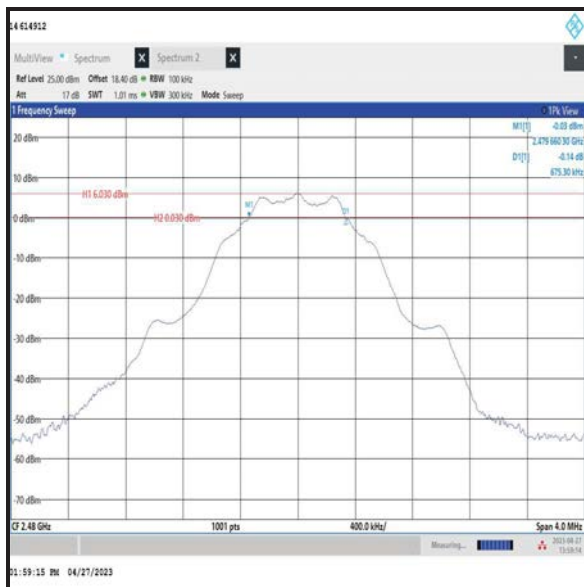

Top Channel

Transmitter Minimum 6 dB Bandwidth (continued)

Results: LE2M / SISO / Core 2

Channel	6 dB Bandwidth (kHz)	Limit (kHz)	Margin (kHz)	Result
Bottom	1278.700	≥500	778.700	Complied
Middle	1183.800	≥500	Complied	
Top	1188.800	≥500	688.800	Complied

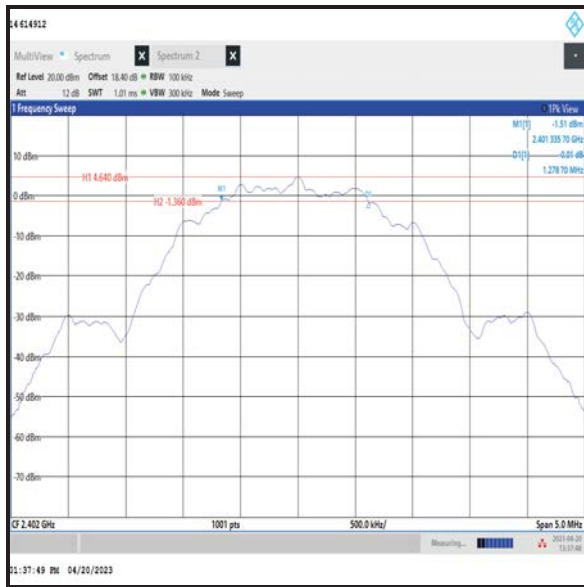

Bottom Channel

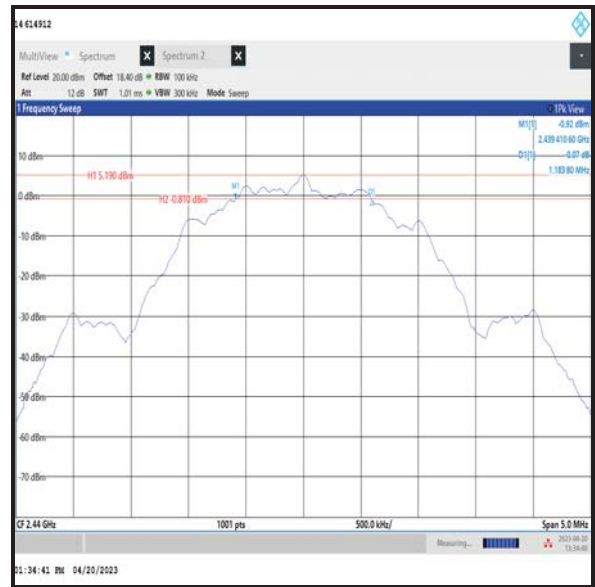

Middle Channel



Top Channel

Transmitter Minimum 6 dB Bandwidth (continued)

Results: LE1M / Beamforming / Core 0

Channel	6 dB Bandwidth (kHz)	Limit (kHz)	Margin (kHz)	Result
Bottom	719.300	≥500	219.300	Complied
Middle	723.300	≥500	223.300	Complied
Top	719.300	≥500	219.300	Complied

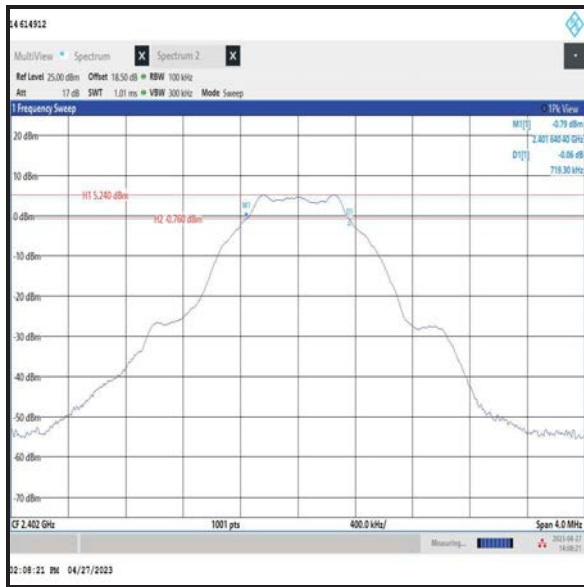

Bottom Channel

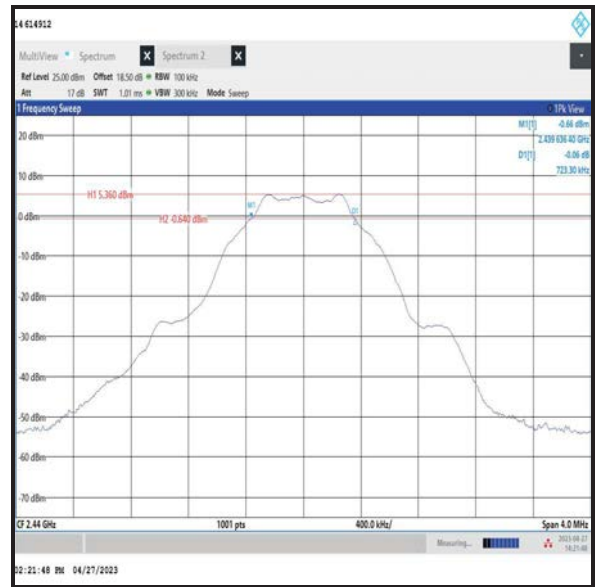

Middle Channel



Top Channel

Transmitter Minimum 6 dB Bandwidth (continued)

Results: LE1M / Beamforming / Core 1

Channel	6 dB Bandwidth (kHz)	Limit (kHz)	Margin (kHz)	Result
Bottom	723.300	≥500	223.300	Complied
Middle	723.300	≥500	223.300	Complied
Top	719.300	≥500	219.300	Complied



Bottom Channel

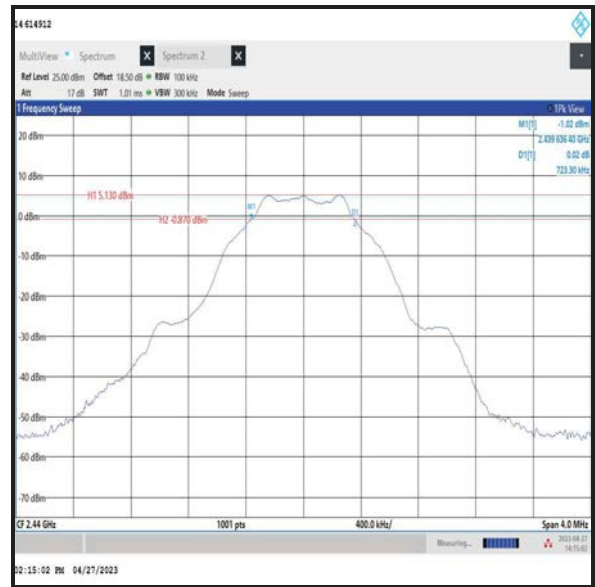

Middle Channel



Top Channel

Transmitter Minimum 6 dB Bandwidth (continued)

Results: LE2M / Beamforming / Core 0

Channel	6 dB Bandwidth (kHz)	Limit (kHz)	Margin (kHz)	Result
Bottom	1288.700	≥500	788.700	Complied
Middle	1263.700	≥500	763.700	Complied
Top	1268.700	≥500	768.700	Complied

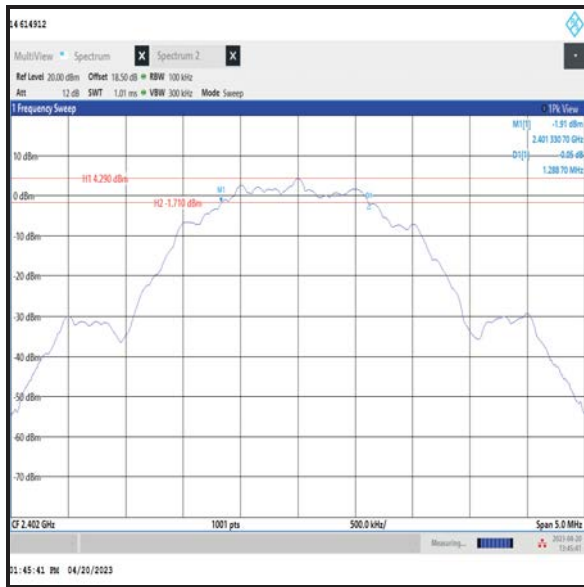

Bottom Channel

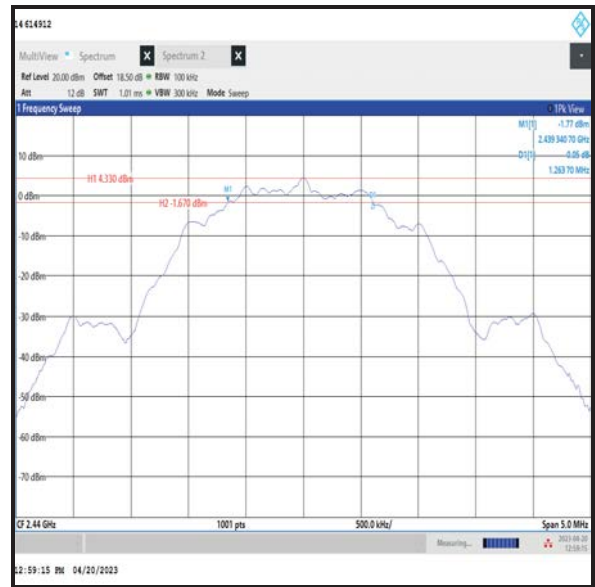

Middle Channel



Top Channel

Transmitter Minimum 6 dB Bandwidth (continued)

Results: LE2M / Beamforming / Core 1

Channel	6 dB Bandwidth (kHz)	Limit (kHz)	Margin (kHz)	Result
Bottom	1277.700	≥500	777.700	Complied
Middle	1273.700	≥500	773.700	Complied
Top	1288.700	≥500	788.700	Complied

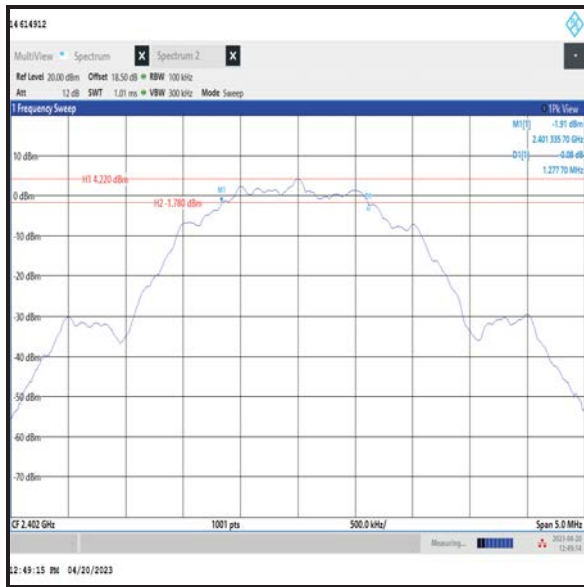

Bottom Channel

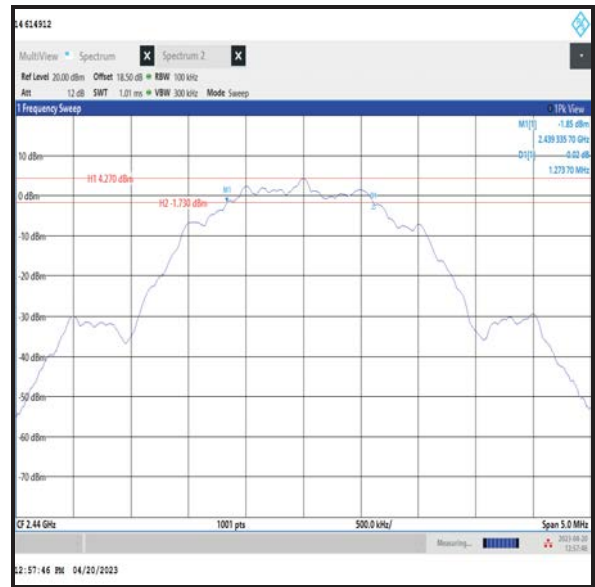

Middle Channel

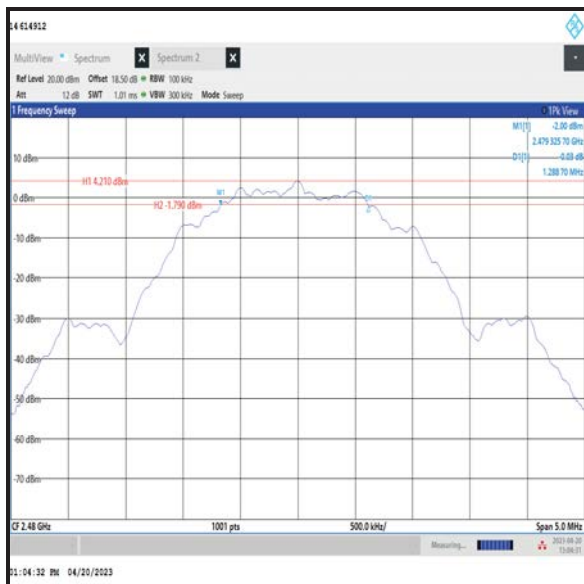

Top Channel

4.3 Transmitter Maximum Peak Output Power

Test Summary:

Test Engineers:	Miriam Thompson & Matthew Botfield	Test Date:	20 April 2023
Test Sample Serial Number:	RKQ16RPGYY		

FCC Reference:	Part 15.247(b)(3)
ISED Canada Reference:	RSS-Gen 6.12 / RSS-247 5.4(d)
Test Method Used:	FCC KDB 558074 Section 8.3.1.1 referencing ANSI C63.10 Section 11.9.1.1 and Notes below

Environmental Conditions:

Temperature (°C):	21
Relative Humidity (%):	41

Note(s):

1. Conducted power tests were performed using a signal analyser in accordance with ANSI C63.10 Section 11.9.1.1 with the RBW \geq DTS bandwidth procedure.
2. For LE1M, the signal analyser resolution bandwidth was set to 1 MHz and video bandwidth of 3 MHz. A peak detector was used, sweep time was set to auto and trace mode was Max Hold. The span was set to equal to or greater than three times the RBW. A marker was placed at the peak of the signal and the results recorded in the tables below.
3. For LE2M, the signal analyser resolution bandwidth was set to 2 MHz and video bandwidth of 10 MHz. A peak detector was used, sweep time was set to auto and trace mode was Max Hold. The span was set to equal to or greater than three times the RBW. A marker was placed at the peak of the signal and the results recorded in the tables below.
4. For beamforming modes, conducted power was measured on Core 0 & Core 1 and then combined using the measure-and-sum technique stated in FCC KDB 662911 D01 Section E)1). For EIRP, the directional antenna gain was added to the conducted output power.
5. The signal analyser was connected to the RF port on the EUT using suitable attenuation and RF cable. An RF level offset was entered on the signal analyser to compensate for the loss of the attenuator and RF cable.

Transmitter Maximum Peak Output Power (continued)**Results: LE1M / SISO / Core 0**

Channel	Conducted Peak Power (dBm)	Conducted Peak Power Limit (dBm)	Margin (dB)	Result
Bottom	6.0	30.0	24.0	Complied
Middle	6.2	30.0	23.8	Complied
Top	6.3	30.0	23.7	Complied

Channel	Conducted Peak Power (dBm)	Declared Antenna Gain (dBi)	EIRP (dBm)	EIRP Limit (dBm)	Margin (dB)	Result
Bottom	6.0	3.1	9.1	36.0	26.9	Complied
Middle	6.2	3.1	9.3	36.0	26.7	Complied
Top	6.3	3.1	9.4	36.0	26.6	Complied

Transmitter Maximum Peak Output Power (continued)

Results: LE1M / SISO / Core 0

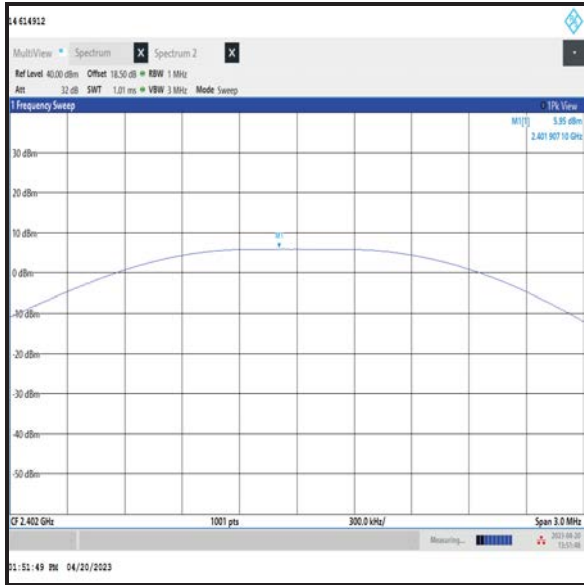

Bottom Channel

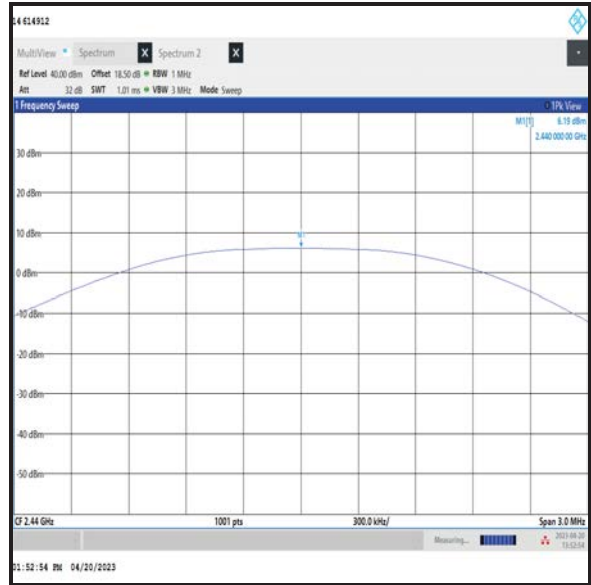

Middle Channel

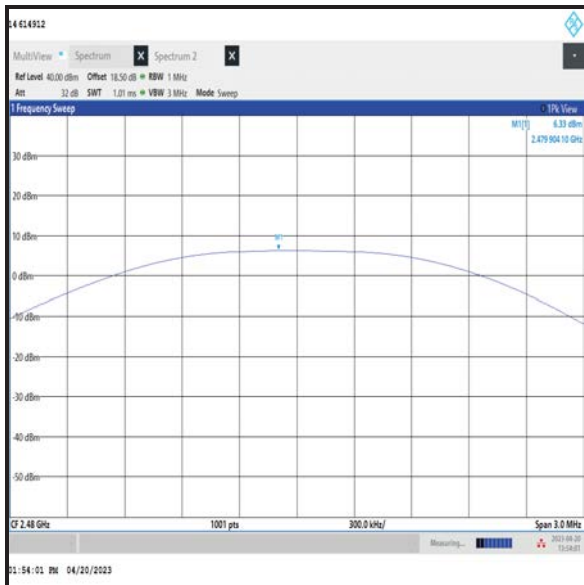

Top Channel

Transmitter Maximum Peak Output Power (continued)**Results: LE2M / SISO / Core 0**

Channel	Conducted Peak Power (dBm)	Conducted Peak Power Limit (dBm)	Margin (dB)	Result
Bottom	6.2	30.0	23.8	Complied
Middle	6.4	30.0	23.6	Complied
Top	6.6	30.0	23.4	Complied

Channel	Conducted Peak Power (dBm)	Declared Antenna Gain (dBi)	EIRP (dBm)	EIRP Limit (dBm)	Margin (dB)	Result
Bottom	6.2	3.1	9.3	36.0	26.7	Complied
Middle	6.4	3.1	9.5	36.0	26.5	Complied
Top	6.6	3.1	9.7	36.0	26.3	Complied

Transmitter Maximum Peak Output Power (continued)

Results: LE2M / SISO / Core 0

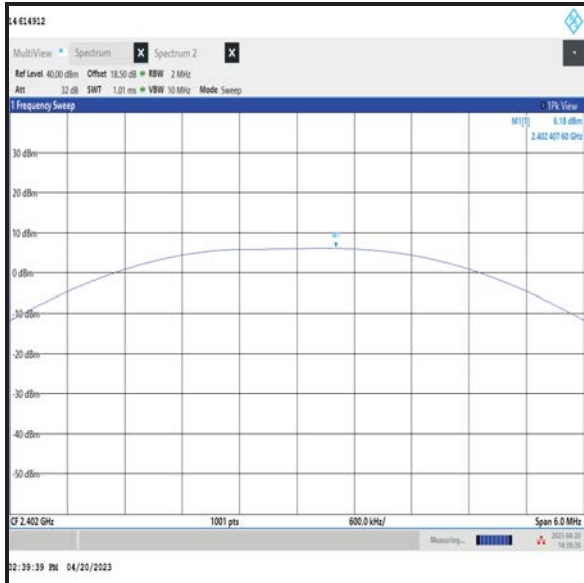

Bottom Channel



Middle Channel

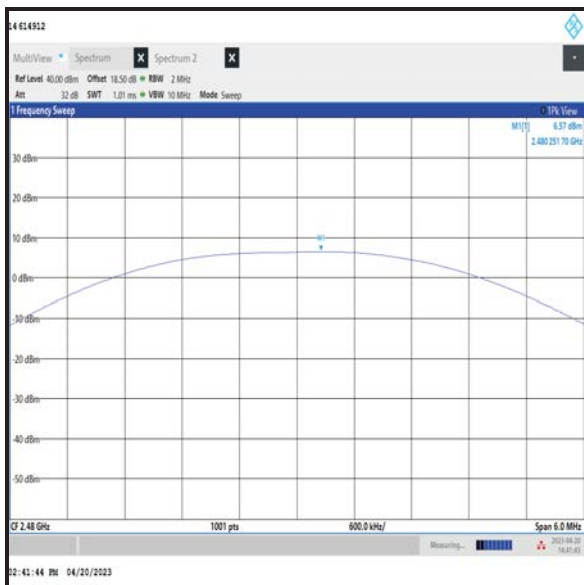

Top Channel

Transmitter Maximum Peak Output Power (continued)**Results: LE1M / SISO / Core 2**

Channel	Conducted Peak Power (dBm)	Conducted Peak Power Limit (dBm)	Margin (dB)	Result
Bottom	6.2	30.0	23.8	Complied
Middle	6.7	30.0	23.3	Complied
Top	7.0	30.0	23.0	Complied

Channel	Conducted Peak Power (dBm)	Declared Antenna Gain (dBi)	EIRP (dBm)	EIRP Limit (dBm)	Margin (dB)	Result
Bottom	6.2	0.7	6.9	36.0	29.1	Complied
Middle	6.7	0.7	7.4	36.0	28.6	Complied
Top	7.0	0.7	7.7	36.0	28.3	Complied

Transmitter Maximum Peak Output Power (continued)

Results: LE1M / SISO / Core 2

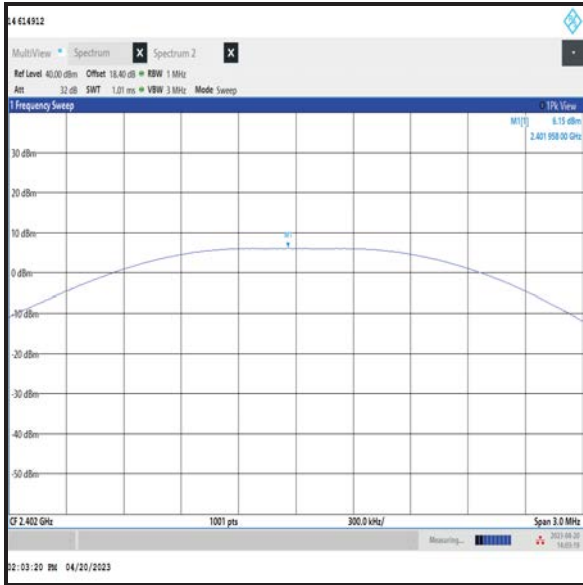

Bottom Channel

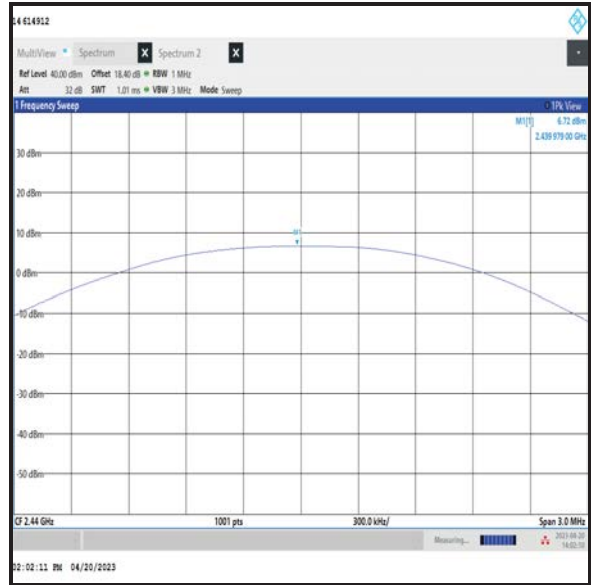

Middle Channel

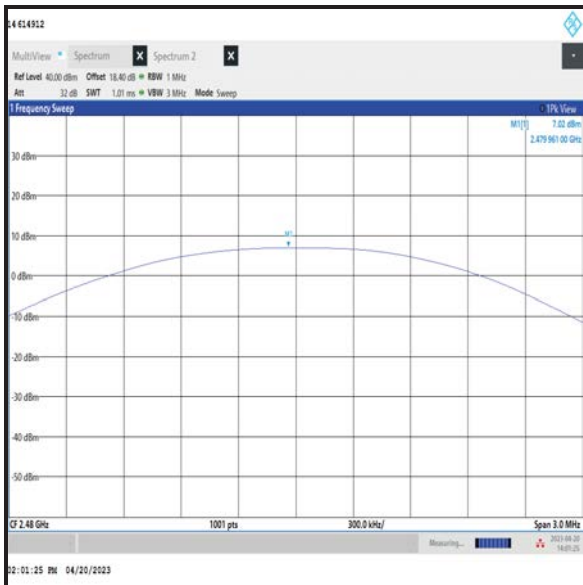

Top Channel

Transmitter Maximum Peak Output Power (continued)**Results: LE2M / SISO / Core 2**

Channel	Conducted Peak Power (dBm)	Conducted Peak Power Limit (dBm)	Margin (dB)	Result
Bottom	6.5	30.0	23.5	Complied
Middle	7.1	30.0	22.9	Complied
Top	7.3	30.0	22.7	Complied

Channel	Conducted Peak Power (dBm)	Declared Antenna Gain (dBi)	EIRP (dBm)	EIRP Limit (dBm)	Margin (dB)	Result
Bottom	6.5	0.7	7.2	36.0	28.8	Complied
Middle	7.1	0.7	7.8	36.0	28.2	Complied
Top	7.3	0.7	8.0	36.0	28.0	Complied

Transmitter Maximum Peak Output Power (continued)

Results: LE2M / SISO / Core 2



Bottom Channel

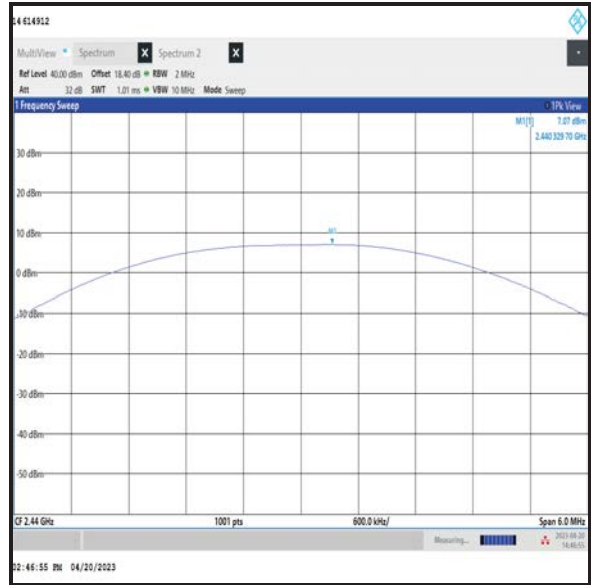

Middle Channel

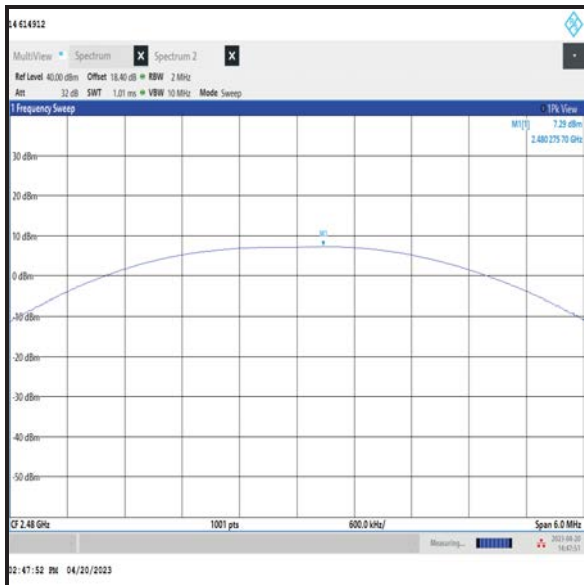

Top Channel

Transmitter Maximum Peak Output Power (continued)**Results: LE1M / Beamforming**

Channel	Conducted Peak Power Core 0 (dBm)	Conducted Peak Power Core 1 (dBm)	Combined Conducted Peak Power (dBm)	Conducted Peak Power Limit (dBm)	Margin (dB)	Result
Bottom	5.9	5.7	8.8	30.0	21.2	Complied
Middle	6.1	5.9	9.0	30.0	21.0	Complied
Top	6.2	5.8	9.0	30.0	21.0	Complied

Channel	Conducted Peak Power (dBm)	Declared Antenna Gain (dBi)	EIRP (dBm)	EIRP Limit (dBm)	Margin (dB)	Result
Bottom	8.8	5.1	13.9	36.0	22.1	Complied
Middle	9.0	5.1	14.1	36.0	21.9	Complied
Top	9.0	5.1	14.1	36.0	21.9	Complied

Transmitter Maximum Peak Output Power (continued)

Results: LE1M / Beamforming / Core 0



Bottom Channel

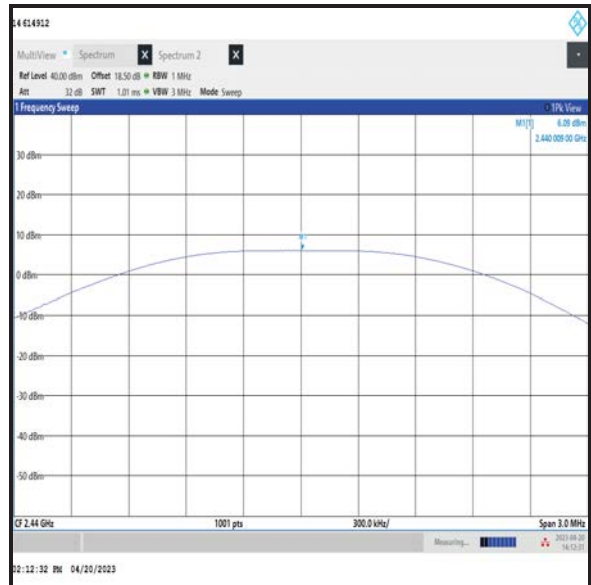

Middle Channel

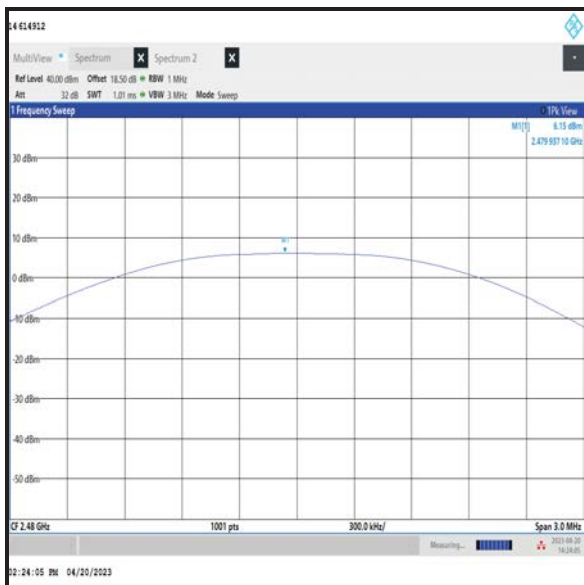

Top Channel

Transmitter Maximum Peak Output Power (continued)

Results: LE1M / Beamforming / Core 1

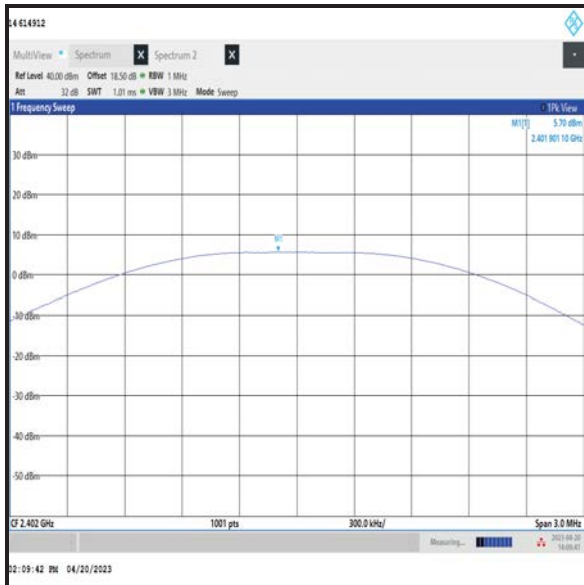

Bottom Channel

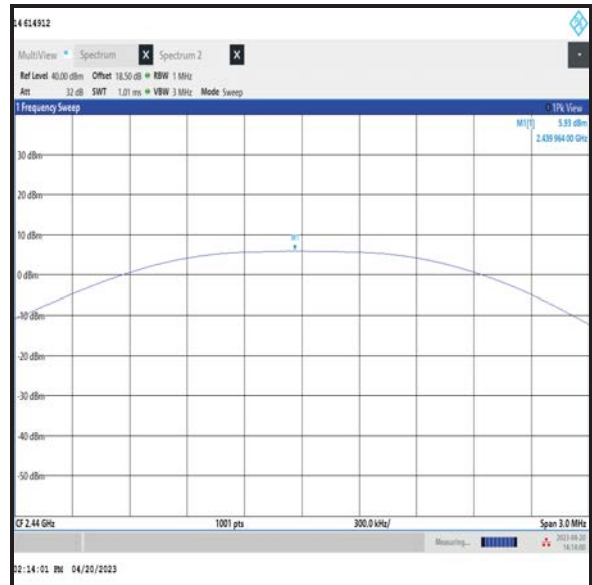

Middle Channel

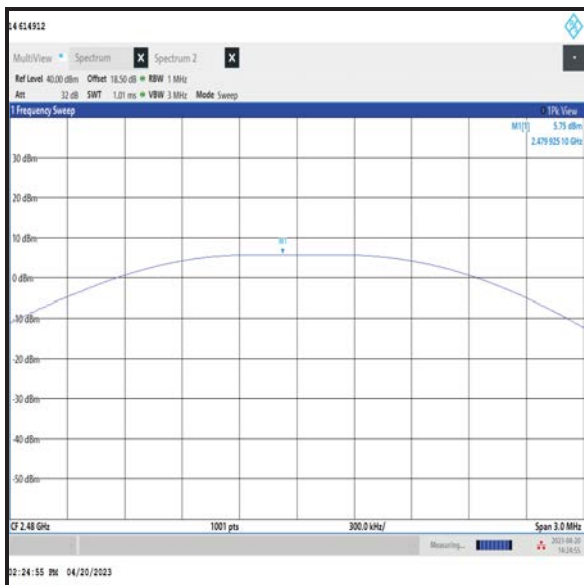

Top Channel

Transmitter Maximum Peak Output Power (continued)**Results: LE2M / Beamforming**

Channel	Conducted Peak Power Core 0 (dBm)	Conducted Peak Power Core 1 (dBm)	Combined Conducted Peak Power (dBm)	Conducted Peak Power Limit (dBm)	Margin (dB)	Result
Bottom	6.2	6.2	9.2	30.0	20.8	Complied
Middle	6.5	6.3	9.4	30.0	20.6	Complied
Top	6.6	6.1	9.4	30.0	20.6	Complied

Channel	Conducted Peak Power (dBm)	Declared Antenna Gain (dBi)	EIRP (dBm)	EIRP Limit (dBm)	Margin (dB)	Result
Bottom	9.2	5.1	14.3	36.0	21.7	Complied
Middle	9.4	5.1	14.5	36.0	21.5	Complied
Top	9.4	5.1	14.5	36.0	21.5	Complied

Transmitter Maximum Peak Output Power (continued)

Results: LE2M / Beamforming / Core 0



Bottom Channel



Middle Channel

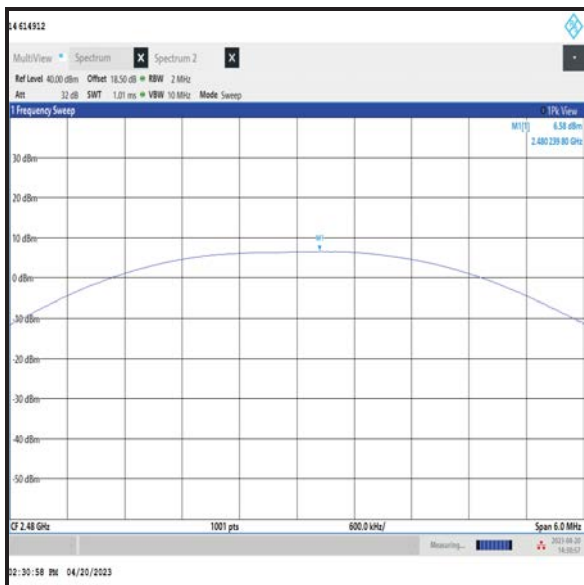

Top Channel

Transmitter Maximum Peak Output Power (continued)

Results: LE2M / Beamforming / Core 1



Bottom Channel

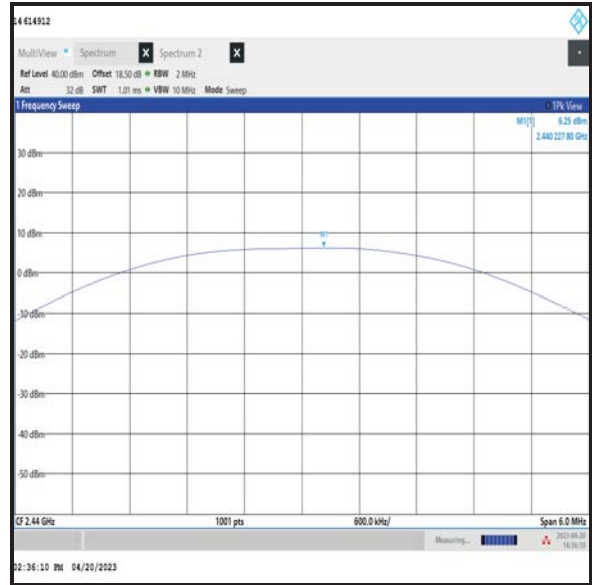

Middle Channel



Top Channel

4.4 Transmitter Power Spectral Density

Test Summary:

Test Engineers:	Miriam Thompson & Matthew Botfield	Test Dates:	20 April 2023 to 27 April 2023
Test Sample Serial Number:	RKQ16RPGYY		

FCC Reference:	Part 15.247(e)
ISED Canada Reference:	RSS-247 5.2(b)
Test Method Used:	FCC KDB 558074 Section 8.4 referencing ANSI C63.10 Section 11.10.2

Environmental Conditions:

Temperature (°C):	21 to 22
Relative Humidity (%):	40 to 41

Note(s):

1. Transmitter Power Spectral Density tests were performed using a signal analyser in accordance with ANSI C63.10 Section 11.10.2.
2. The signal analyser resolution bandwidth was set to 3 kHz and video bandwidth 10 kHz. A Peak detector was used, sweep time was set to auto and the trace mode was Max Hold. The span was set to 1.5 times the measured DTS bandwidth. A marker was placed at the peak of the signal and the results recorded in the table below.
3. The signal analyser was connected to the RF port on the EUT using suitable attenuation and RF cable. An RF level offset was entered on the signal analyser to compensate for the loss of the attenuator and RF cable.

Transmitter Power Spectral Density (continued)

Results: LE1M / SISO / Core 0

Channel	PSD (dBm / 3 kHz)	Limit (dBm / 3 kHz)	Margin (dB)	Result
Bottom	-9.6	8.0	17.6	Complied
Middle	-9.6	8.0	17.6	Complied
Top	-9.5	8.0	17.5	Complied

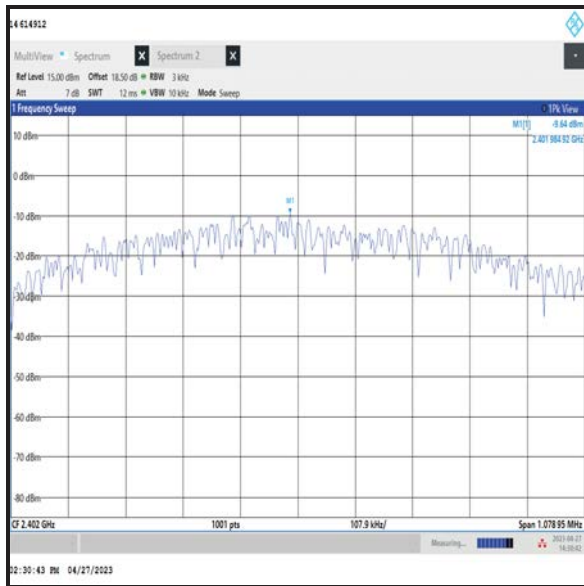

Bottom Channel

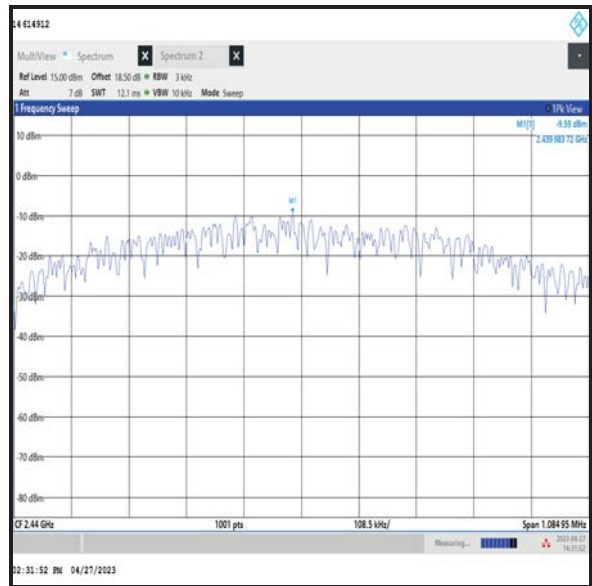

Middle Channel

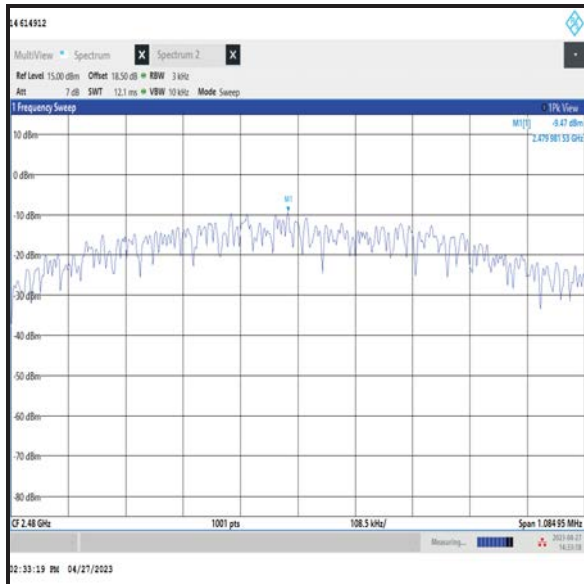

Top Channel

Transmitter Power Spectral Density (continued)

Results: LE2M / SISO / Core 0

Channel	PSD (dBm / 3 kHz)	Limit (dBm / 3 kHz)	Margin (dB)	Result
Bottom	-12.3	8.0	20.3	Complied
Middle	-12.4	8.0	20.4	Complied
Top	-12.1	8.0	20.1	Complied

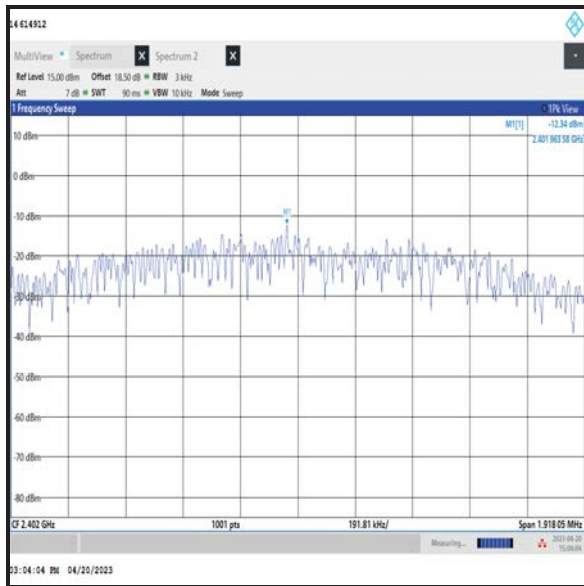

Bottom Channel

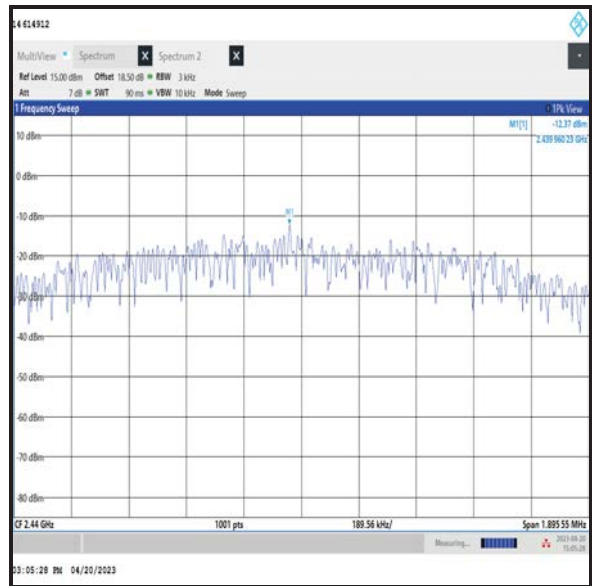

Middle Channel

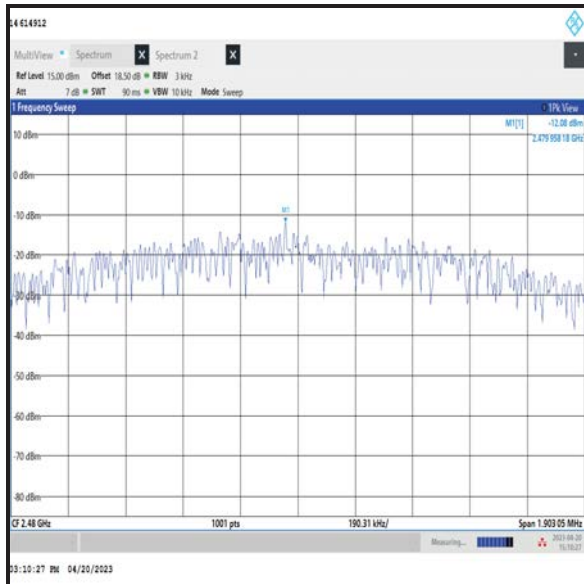

Top Channel

Transmitter Power Spectral Density (continued)

Results: LE1M / SISO / Core 2

Channel	PSD (dBm / 3 kHz)	Limit (dBm / 3 kHz)	Margin (dB)	Result
Bottom	-9.2	8.0	17.2	Complied
Middle	-9.4	8.0	17.4	Complied
Top	-9.2	8.0	17.2	Complied

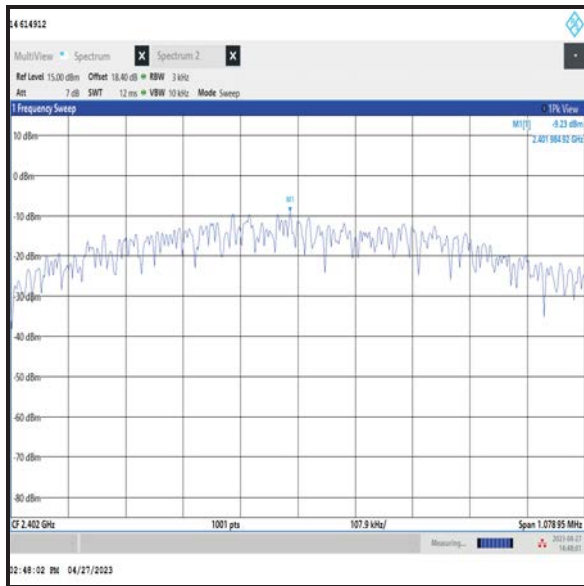

Bottom Channel

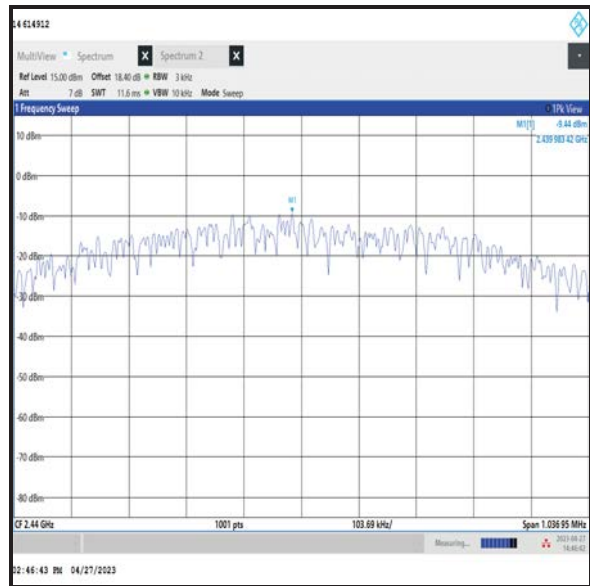

Middle Channel

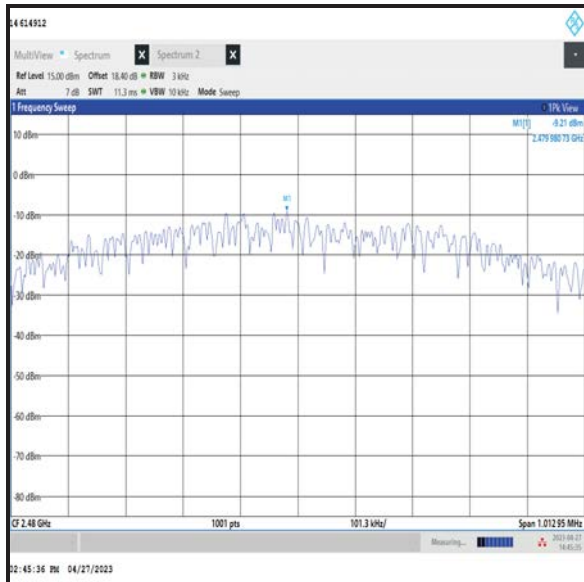

Top Channel

Transmitter Power Spectral Density (continued)

Results: LE2M / SISO / Core 2

Channel	PSD (dBm / 3 kHz)	Limit (dBm / 3 kHz)	Margin (dB)	Result
Bottom	-11.8	8.0	19.8	Complied
Middle	-11.6	8.0	19.6	Complied
Top	-11.6	8.0	19.6	Complied

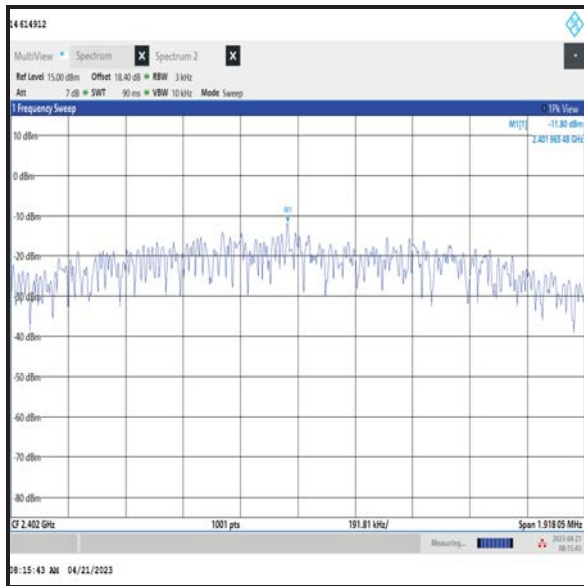

Bottom Channel

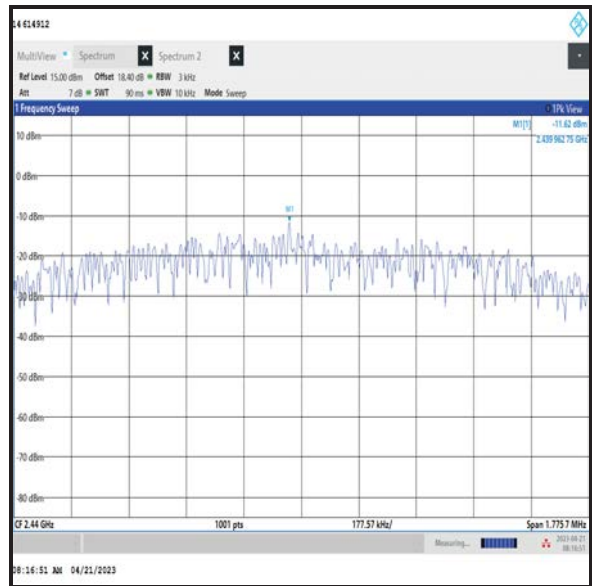

Middle Channel

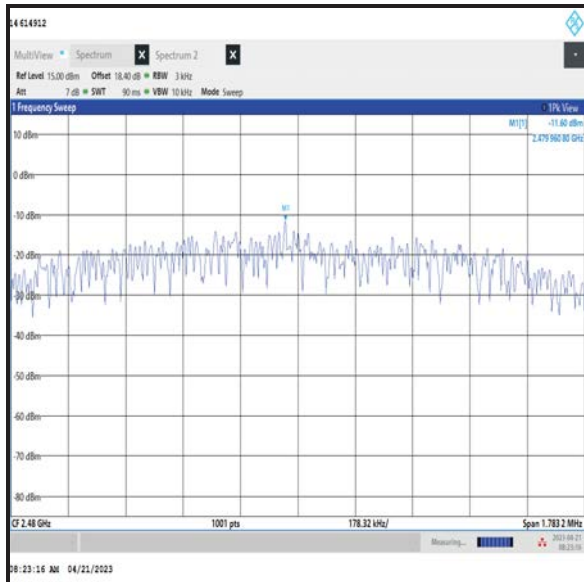

Top Channel

Transmitter Power Spectral Density (continued)

Results: LE1M / Beamforming

Channel	PSD Core 0 (dBm / 3 kHz)	PSD Core 1 (dBm / 3 kHz)	Combined PSD (dBm / 3 kHz)	Limit (dBm / 3 kHz)	Margin (dB)	Result
Bottom	-9.6	-9.8	-6.7	8.0	14.7	Complied
Middle	-9.5	-9.7	-6.6	8.0	14.6	Complied
Top	-9.5	-9.7	-6.6	8.0	14.6	Complied

Results: LE1M / Beamforming / Core 0

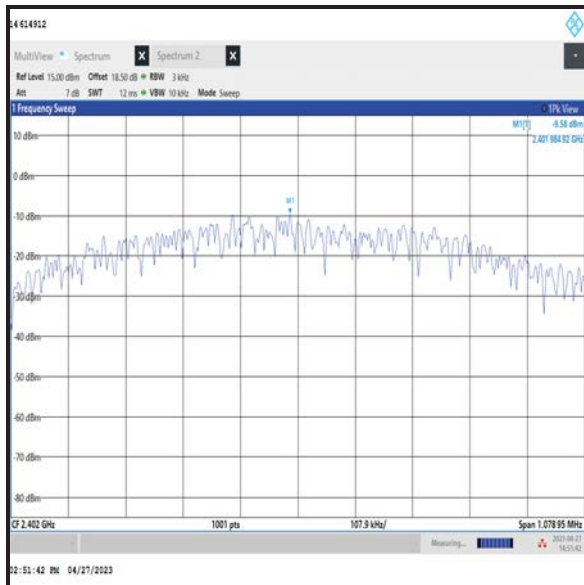

Bottom Channel

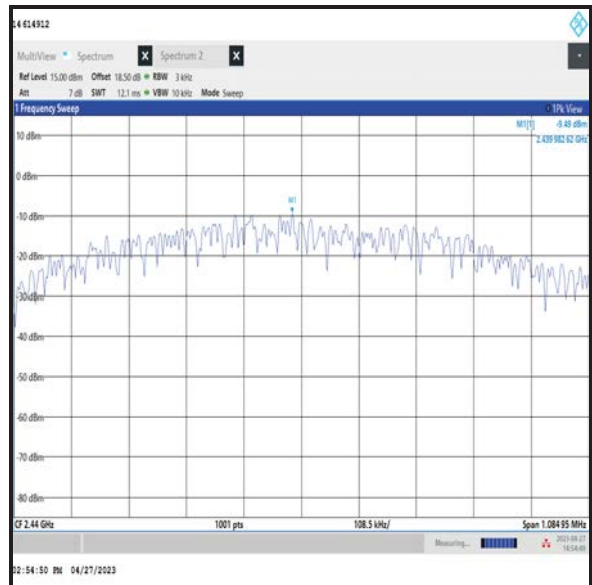

Middle Channel

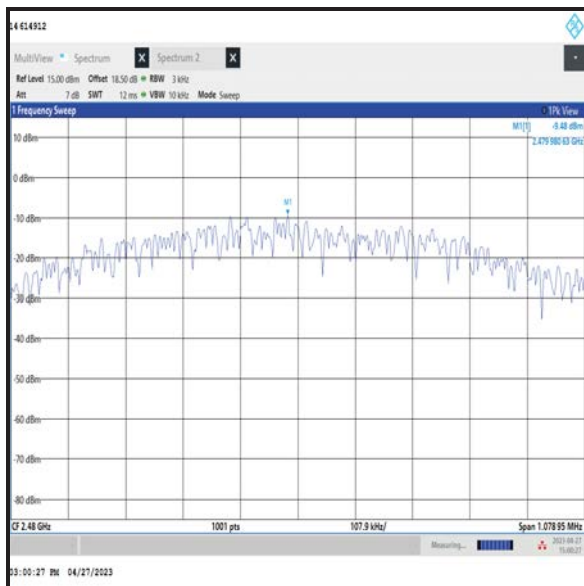

Top Channel

Transmitter Power Spectral Density (continued)

Results: LE1M / Beamforming / Core 1

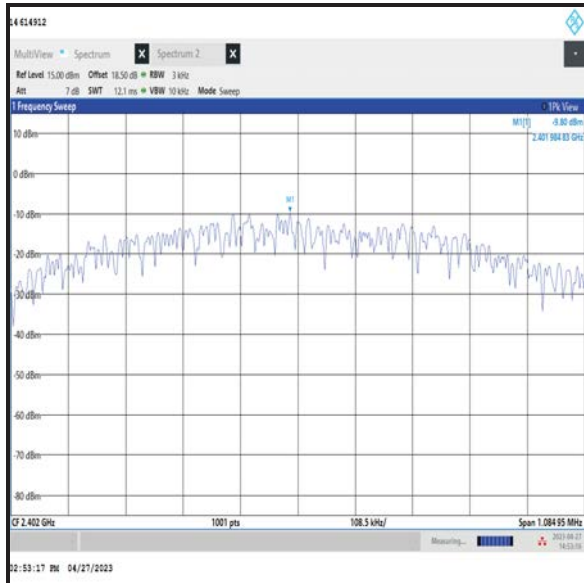

Bottom Channel

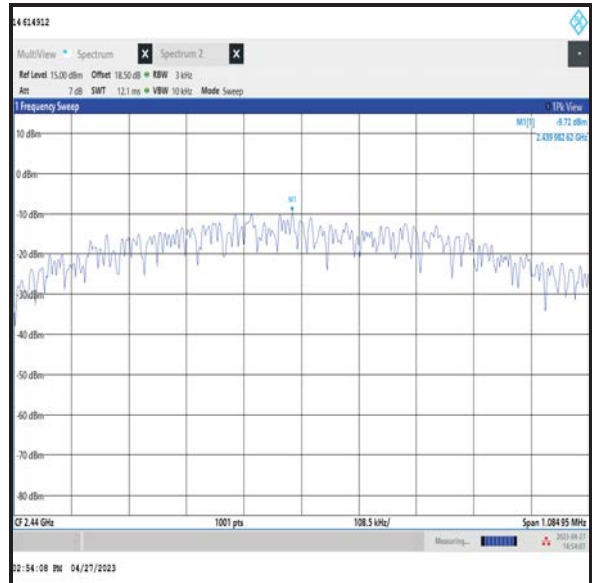

Middle Channel

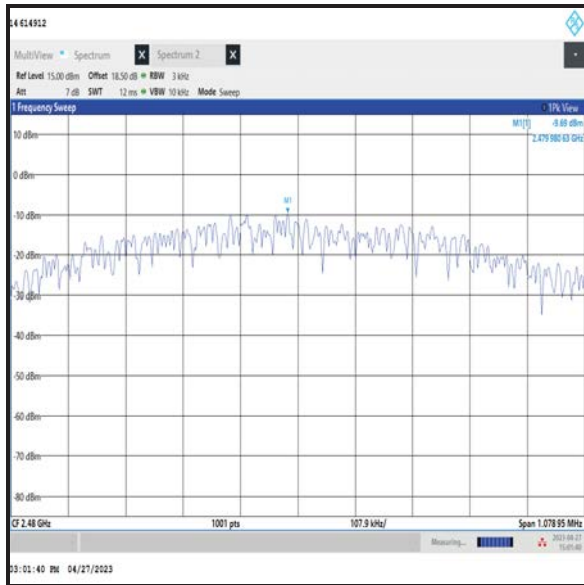

Top Channel

Transmitter Power Spectral Density (continued)

Results: LE2M / Beamforming

Channel	PSD Core 0 (dBm / 3 kHz)	PSD Core 1 (dBm / 3 kHz)	Combined PSD (dBm / 3 kHz)	Limit (dBm / 3 kHz)	Margin (dB)	Result
Bottom	-12.0	-12.3	-9.1	8.0	17.1	Complied
Middle	-11.9	-12.2	-9.0	8.0	17.0	Complied
Top	-11.8	-12.1	-8.9	8.0	16.9	Complied

Results: LE2M / Beamforming / Core 0

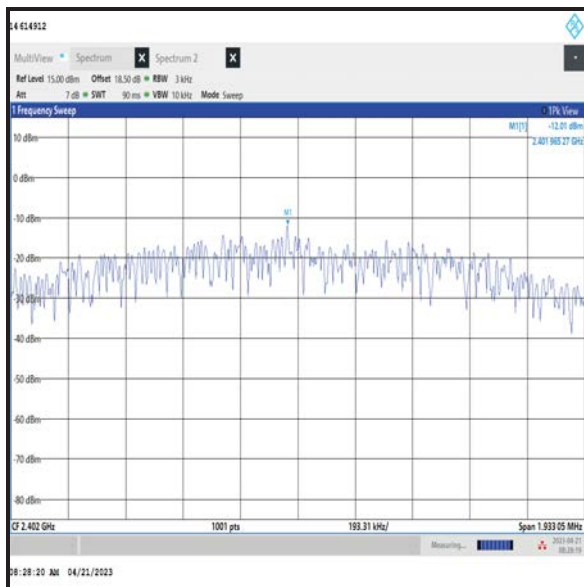

Bottom Channel

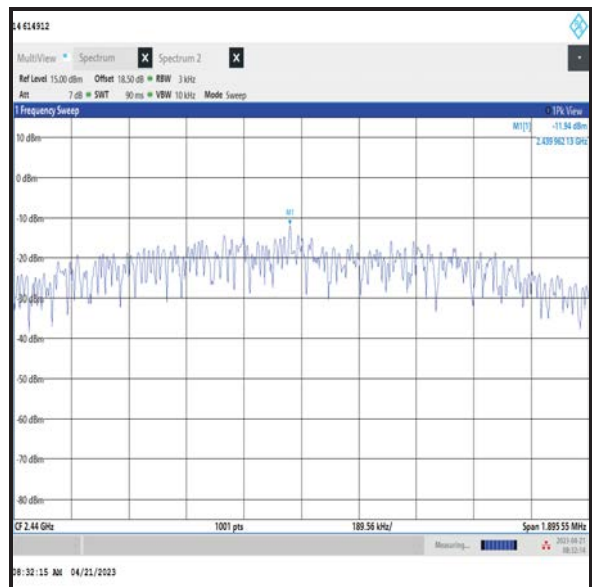

Middle Channel

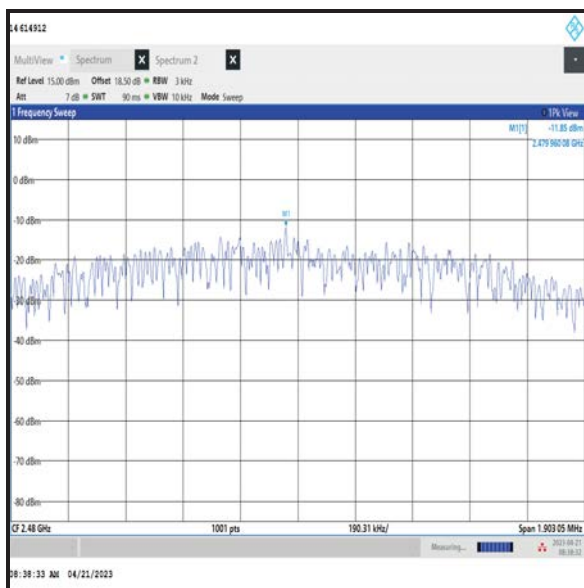

Top Channel

Transmitter Power Spectral Density (continued)

Results: LE2M / Beamforming / Core 1

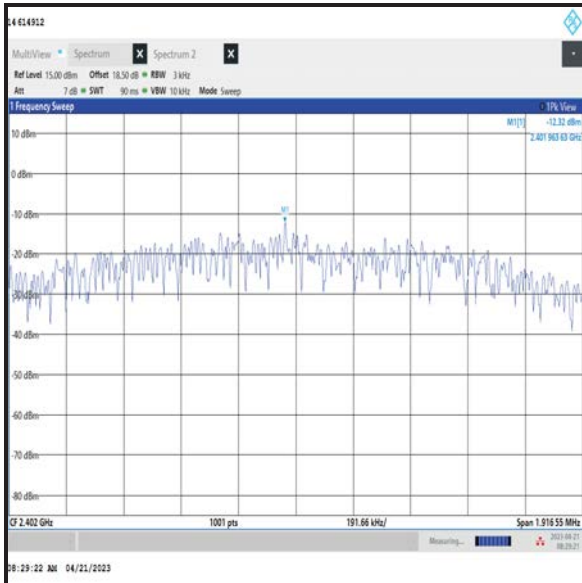

Bottom Channel

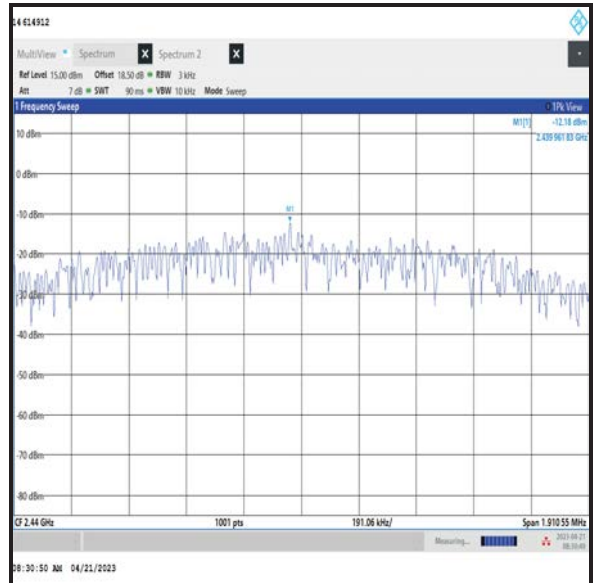

Middle Channel

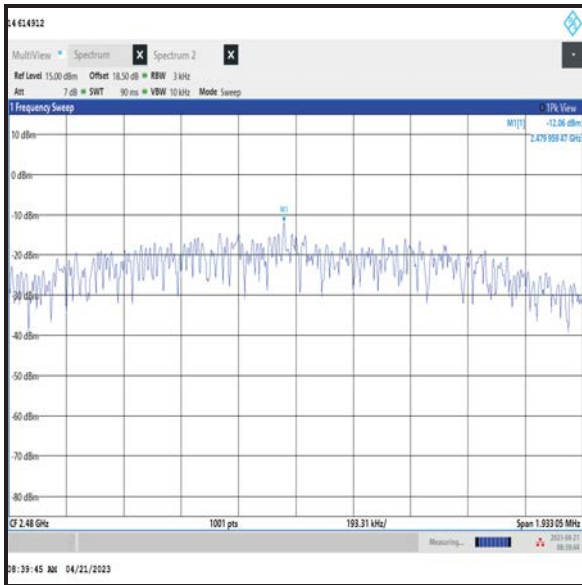

Top Channel

5 Radiated Test Results

5.1 Transmitter Radiated Emissions <1 GHz

Test Summary:

Test Engineer:	Andrew Harding	Test Date:	09 March 2023
Test Sample Serial Number:	WGCDCC9QNK		

FCC Reference:	Parts 15.247(d) & 15.209(a)
ISED Canada Reference:	RSS-Gen 6.13 & 8.9 / RSS-247 5.5
Test Method Used:	ANSI C63.10 Sections 6.3, 6.4 and 6.5
Frequency Range	9 kHz to 1000 MHz

Environmental Conditions:

Temperature (°C):	19
Relative Humidity (%):	35 to 37

Note(s):

1. The final measured value, for the given emission, in the table below incorporates the calibrated antenna factor and cable loss.
2. The preliminary scans showed similar emission levels below 1 GHz, for each channel of operation. Therefore final radiated emissions measurements were performed with the EUT set to the middle channel only.
3. All emissions shown on the pre-scans were investigated and found to be ambient, or > 20 dB below the appropriate limit or below the noise floor of the measurement system. Therefore the highest peak noise floor reading of the measuring receiver was recorded in the table below.
4. Measurements below 30 MHz were performed in a semi-anechoic chamber (Asset Number K0001) at 3 metres. The EUT was placed at a height of 80 cm above the reference ground plane in the centre of the chamber turntable. The limit was extrapolated to 3 metres in accordance with ANSI C63.10 clause 6.4.3 using the method described in clause 6.4.4.2. ANSI C63.10 clause 5.2 states an alternative test site that can demonstrate equivalence to an open area test site may be used for measurements below 30 MHz. Therefore, measurements were performed in a semi-anechoic chamber. The correlation data between semi-anechoic chamber and an open field test site is available upon request.
5. Measurements between 30 MHz to 1 GHz were performed in a semi-anechoic chamber (Asset Number K0001) at a distance of 3 metres. The EUT was placed at a height of 80 cm above the reference ground plane in the centre of the chamber turntable. Maximum emission levels were determined by height searching the measurement antenna over the range 1 metre to 4 metres.
6. Pre-scans were performed and markers placed on the highest measured levels. The test receiver was configured as follows: For 9 kHz to 150 kHz, the resolution bandwidth was set to 300 Hz and video bandwidth 1 kHz. A peak detector was used and trace mode was Max Hold. For 150 kHz to 30 MHz, the resolution bandwidth was set to 10 kHz and video bandwidth 30 kHz, trace mode was Max Hold. For 30 MHz to 1 GHz, the resolution bandwidth was set to 120 kHz and video bandwidth 500 kHz. A peak detector was used, sweep time was set to auto and trace mode was Max Hold.

Transmitter Radiated Emissions (continued)

Results: Peak / Middle Channel / LE2M / Beamforming / Core 0 + Core 1

Frequency (MHz)	Antenna Polarity	Level (dB μ V/m)	Limit (dB μ V/m)	Margin (dB)	Result
956.040	Vertical	37.6	46.0	8.4	Complied

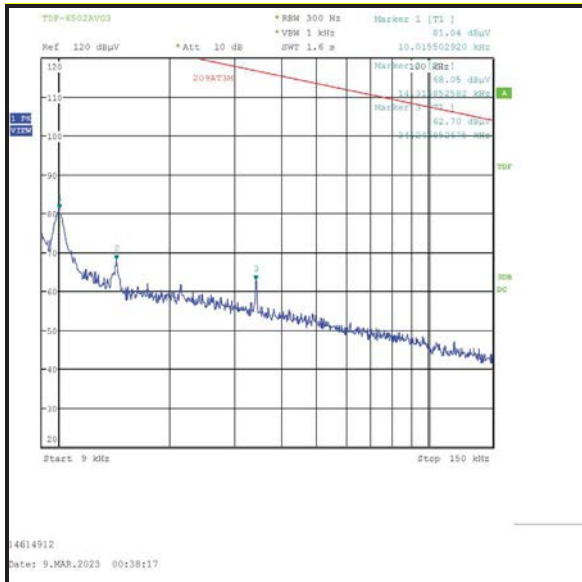

5.2 Transmitter Radiated Emissions >1 GHz

Test Summary:

Test Engineer:	Andrew Harding	Test Dates:	03 March 2023 to 10 March 2023
Test Sample Serial Number:	WGCDCC9QNK		

FCC Reference:	Parts 15.247(d) & 15.209(a)
ISED Canada Reference:	RSS-Gen 6.13 & 8.9 / RSS-247 5.5
Test Method Used:	FCC KDB 558074 Sections 8.1 c)3), 8.5 & 8.6 referencing ANSI C63.10 Sections 6.3, 6.6, 11.11 & 11.12
Frequency Range	1 GHz to 25 GHz

Environmental Conditions:

Temperature (°C):	20 to 22
Relative Humidity (%):	32 to 40

Note(s):

1. The final measured value, for the given emission, in the table below incorporates the calibrated antenna factor and cable loss.
2. No spurious emissions were detected above the noise floor of the measuring receiver therefore the highest peak and average noise floor readings of the measuring receiver were recorded as shown in the tables below.
3. The emission shown on the 1 GHz to 3 GHz plot at approximately 2440 MHz is the EUT fundamental.
4. Pre-scans above 1 GHz were performed in a fully anechoic chamber (Asset Number K0017) at a distance of 3 metres. The EUT was placed at a height of 1.5 metres above the test chamber floor in the centre of the chamber turntable. All measurement antennas were placed at a fixed height of 1.5 metres above the test chamber floor, in line with the EUT.
5. Pre-scans were performed and a marker placed on the highest measured level of the appropriate plot. The test receiver resolution bandwidth was set to 1 MHz and video bandwidth 3 MHz. The sweep time was set to auto. Peak and average measurements were performed with their own appropriate detectors during the pre-scan measurements.

Results: Peak / Middle Channel / LE2M / Beamforming / Core 0 + Core 1

Frequency (MHz)	Antenna Polarity	Level (dB μ V/m)	Limit (dB μ V/m)	Margin (dB)	Result
2942.500	Vertical	54.7	74.0	19.3	Complied

Results: Average/ Middle Channel / LE2M / Beamforming / Core 0 + Core 1

Frequency (MHz)	Antenna Polarity	Level (dB μ V/m)	Limit (dB μ V/m)	Margin (dB)	Result
2867.000	Vertical	48.4	54.0	5.6	Complied

Transmitter Radiated Emissions (continued)

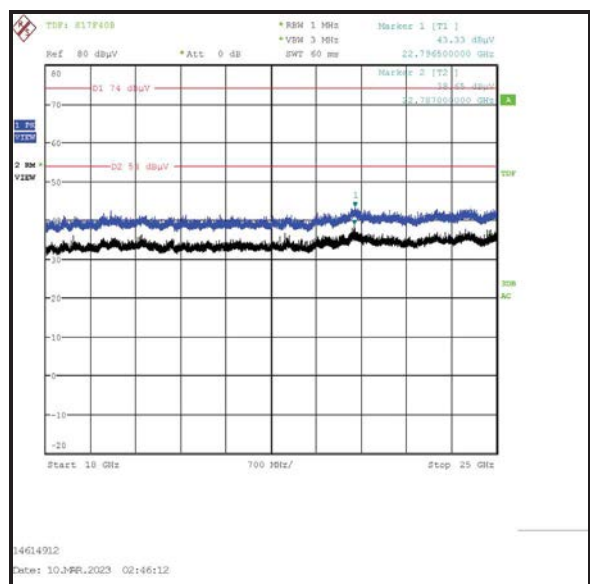
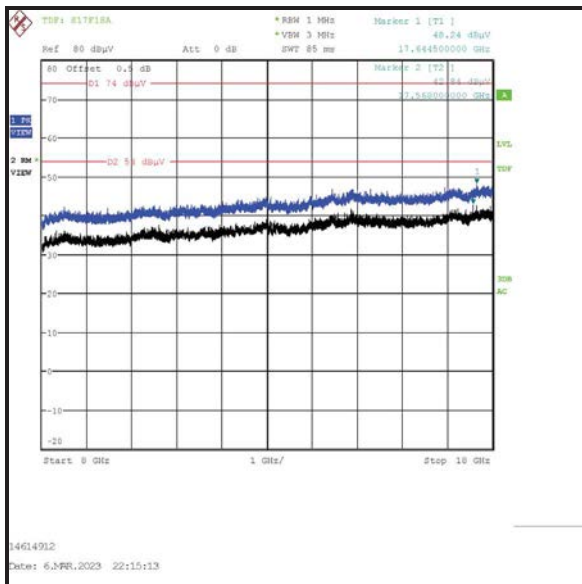
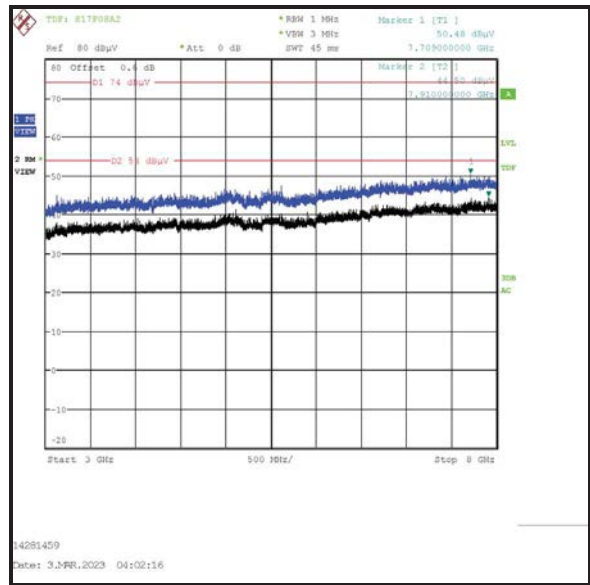
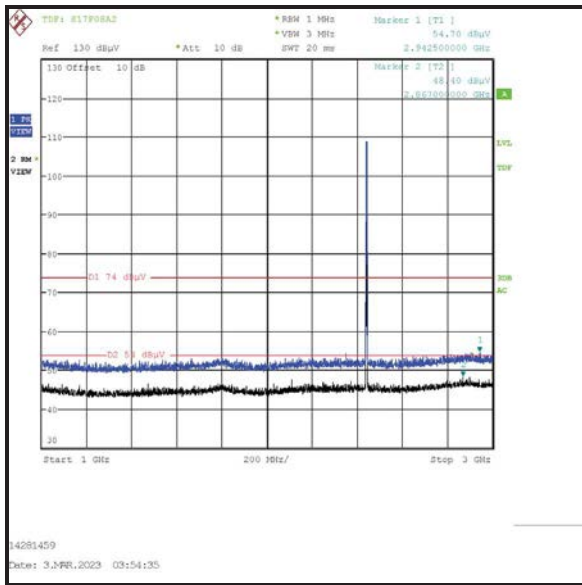

5.3 Transmitter Band Edge Radiated Emissions

Test Summary:

Test Engineers:	John Ferdinand & Andrew Harding	Test Dates:	21 February 2023 to 23 February 2023
Test Sample Serial Number:	WGCDCC9QNK		

FCC Reference:	Parts 15.247(d) & 15.209(a)
ISED Canada Reference:	RSS-Gen 6.13 / RSS-247 5.5
Test Method Used:	KDB 558074 Section 8.7 referencing ANSI C63.10 Sections 11.11, 11.12 & 11.13

Environmental Conditions:

Temperature (°C):	21 to 22
Relative Humidity (%):	37 to 41

Note(s):

1. The final measured value, for the given emission, in the table below incorporates the calibrated antenna factor and cable loss.
2. As the lower band edge is adjacent to a non-restricted band, only peak measurements are required. In accordance with ANSI C63.10 Section 11.11.1, the test method in Section 11.11.3 was followed: the test receiver resolution bandwidth was set to 100 kHz and video bandwidth 300 kHz. A peak detector was used, sweep time was set to auto and trace mode was Max Hold. The test receiver was left to sweep for a sufficient length of time in order to maximise the carrier level and out-of-band emissions. A marker and corresponding reference level line were placed on the peak of the carrier. As the maximum peak conducted output power was measured using a peak detector in accordance with ANSI C63.10 Section 11.9.1.1 an out-of-band limit line was placed 20 dB (ANSI C63.10 Section 11.11.1(a)) below the peak level. A marker was placed on the band edge spot frequencies. Marker frequency and levels were recorded.
3. As the upper band edge is adjacent to a restricted band, both peak and average measurements were recorded by placing a marker at the edge of the band. For peak measurements the test receiver resolution bandwidth was set to 1 MHz and the video bandwidth 3 MHz. A peak detector was used, sweep time was set to auto and trace mode was Max Hold. For average measurements the test receiver resolution bandwidth was set to 1 MHz and the video bandwidth 3 MHz. An RMS detector was used, sweep time was set to auto and trace mode was trace averaging over 300 sweeps. A marker was placed on the band edge spot frequencies and a second marker placed on the highest emission level in the adjacent restricted band of operation (where a higher level emission was present). Marker frequencies and levels were recorded.
4. There is a restricted band 10 MHz below the lower band edge. The test receiver was set up as follows: the RBW set to 1 MHz, the VBW set to 3 MHz, with the sweep time set to auto couple. Peak and average measurements were performed with peak and RMS detectors respectively. Markers were placed on the highest point on each trace.
5. * -20 dBc limit.

Transmitter Band Edge Radiated Emissions (continued)**Results: LE1M / SISO / Core 0**

Frequency (MHz)	Antenna Polarity	Peak Level (dB μ V/m)	Limit (dB μ V/m)	Margin (dB)	Result
2400.0	Vertical	44.6	86.8*	42.2	Complied
2483.5	Vertical	50.7	74.0	23.3	Complied
2486.144	Vertical	52.1	74.0	21.9	Complied

Frequency (MHz)	Antenna Polarity	Average Level (dB μ V/m)	Limit (dB μ V/m)	Margin (dB)	Result
2483.5	Vertical	40.3	54.0	13.7	Complied
2483.580	Vertical	40.4	54.0	13.6	Complied

Results: 2310 MHz to 2390 MHz Restricted Band / Peak

Frequency (MHz)	Antenna Polarity	Level (dB μ V/m)	Limit (dB μ V/m)	Margin (dB)	Result
2326.667	Vertical	53.9	74.0	20.1	Complied

Results: 2310 MHz to 2390 MHz Restricted Band / Average

Frequency (MHz)	Antenna Polarity	Level (dB μ V/m)	Limit (dB μ V/m)	Margin (dB)	Result
2385.641	Vertical	41.9	54.0	12.1	Complied

Transmitter Band Edge Radiated Emissions (continued)

Results: LE1M / SISO / Core 0



Lower Band Edge

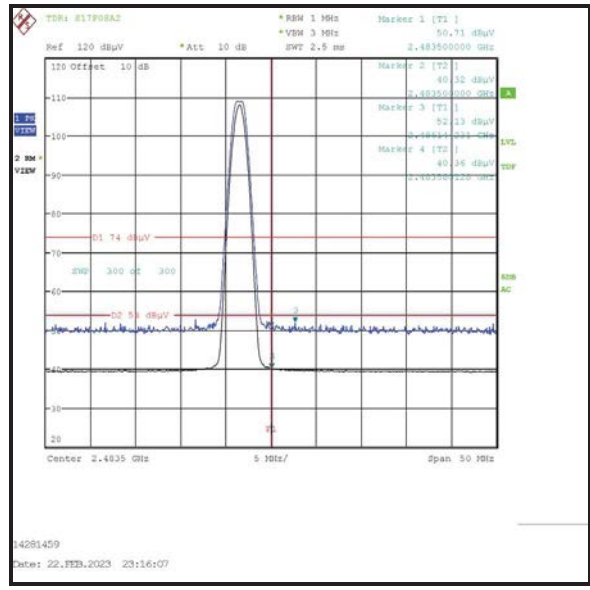

Upper Band Edge

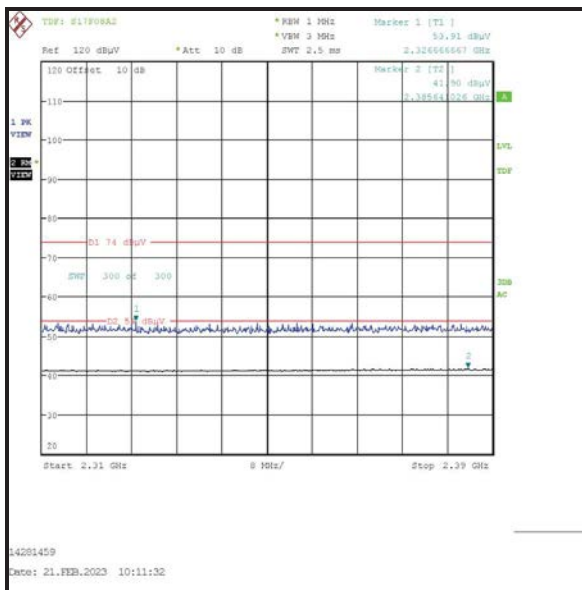

2310 MHz to 2390 MHz Restricted Band

Transmitter Band Edge Radiated Emissions (continued)**Results: LE2M / SISO / Core 0**

Frequency (MHz)	Antenna Polarity	Peak Level (dB μ V/m)	Limit (dB μ V/m)	Margin (dB)	Result
2400.0	Vertical	71.8	85.0*	13.2	Complied
2483.5	Vertical	54.7	74.0	19.3	Complied

Frequency (MHz)	Antenna Polarity	Average Level (dB μ V/m)	Limit (dB μ V/m)	Margin (dB)	Result
2483.5	Vertical	44.8	54.0	9.2	Complied

Results: 2310 MHz to 2390 MHz Restricted Band / Peak

Frequency (MHz)	Antenna Polarity	Level (dB μ V/m)	Limit (dB μ V/m)	Margin (dB)	Result
2380.128	Vertical	54.5	74.0	19.5	Complied

Results: 2310 MHz to 2390 MHz Restricted Band / Average

Frequency (MHz)	Antenna Polarity	Level (dB μ V/m)	Limit (dB μ V/m)	Margin (dB)	Result
2388.974	Vertical	41.8	54.0	12.2	Complied

Transmitter Band Edge Radiated Emissions (continued)

Results: LE2M / SISO / Core 0

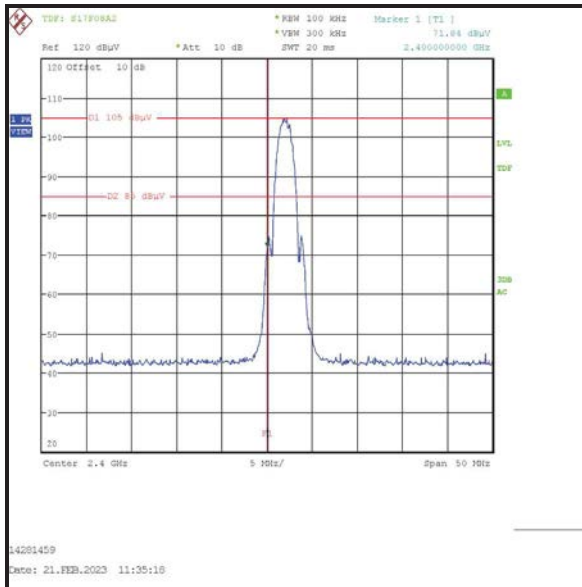

Lower Band Edge

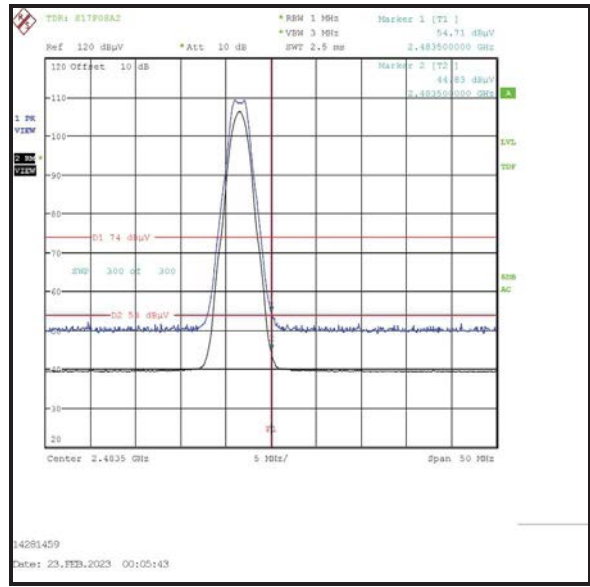

Upper Band Edge

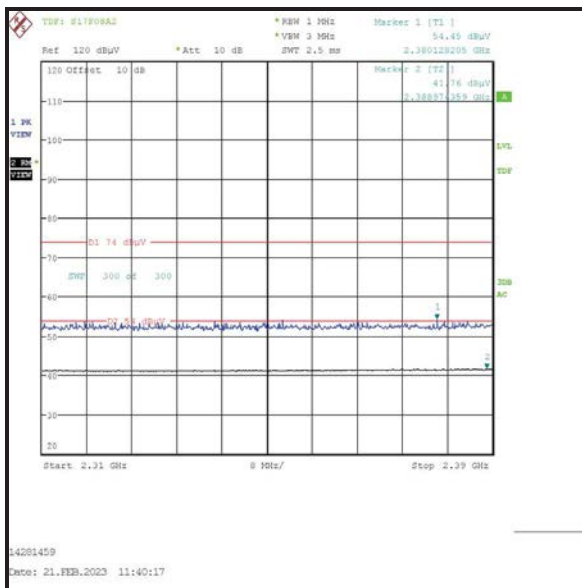

2310 MHz to 2390 MHz Restricted Band

Transmitter Band Edge Radiated Emissions (continued)**Results: LE1M / SISO / Core 1**

Frequency (MHz)	Antenna Polarity	Peak Level (dB μ V/m)	Limit (dB μ V/m)	Margin (dB)	Result
2400.0	Vertical	44.2	87.2*	43.0	Complied
2483.5	Vertical	50.0	74.0	24.0	Complied
2483.660	Vertical	51.8	74.0	22.2	Complied

Frequency (MHz)	Antenna Polarity	Average Level (dB μ V/m)	Limit (dB μ V/m)	Margin (dB)	Result
2483.5	Vertical	40.1	54.0	13.9	Complied
2483.740	Vertical	40.2	54.0	13.8	Complied

Results: 2310 MHz to 2390 MHz Restricted Band / Peak

Frequency (MHz)	Antenna Polarity	Level (dB μ V/m)	Limit (dB μ V/m)	Margin (dB)	Result
2363.205	Vertical	54.1	74.0	19.9	Complied

Results: 2310 MHz to 2390 MHz Restricted Band / Average

Frequency (MHz)	Antenna Polarity	Level (dB μ V/m)	Limit (dB μ V/m)	Margin (dB)	Result
2388.590	Vertical	41.8	54.0	12.2	Complied

Transmitter Band Edge Radiated Emissions (continued)

Results: LE1M / SISO / Core 1

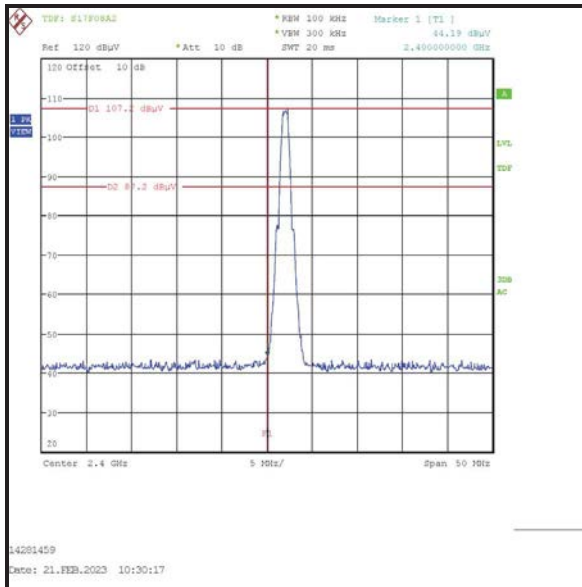

Lower Band Edge

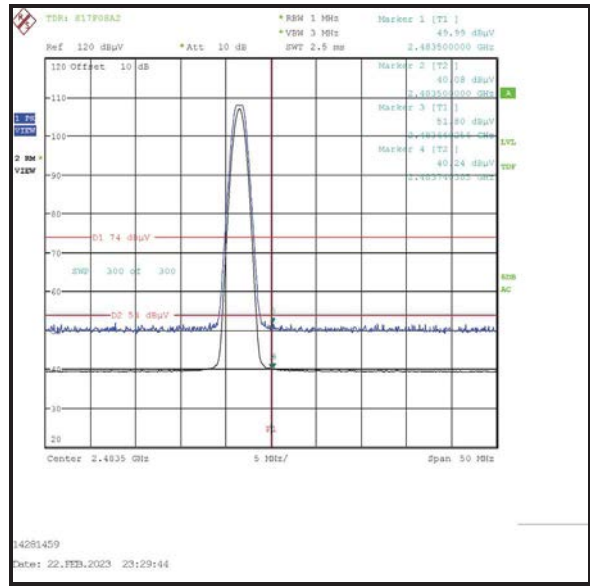

Upper Band Edge

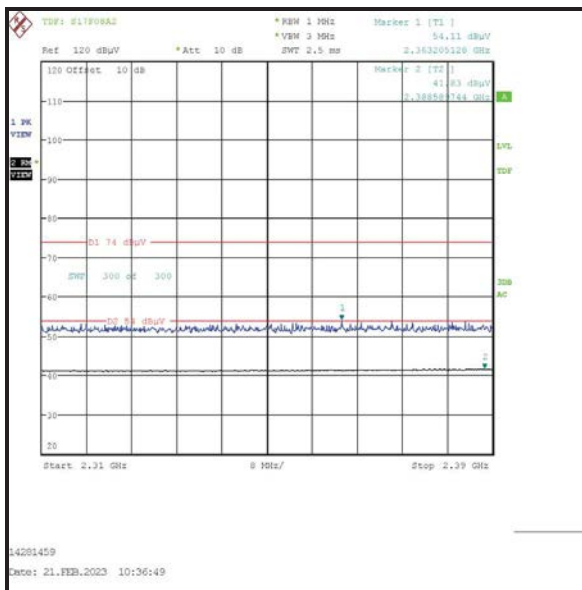

2310 MHz to 2390 MHz Restricted Band

Transmitter Band Edge Radiated Emissions (continued)**Results: LE2M / SISO / Core 1**

Frequency (MHz)	Antenna Polarity	Peak Level (dB μ V/m)	Limit (dB μ V/m)	Margin (dB)	Result
2400.0	Vertical	74.4	85.3*	10.9	Complied
2483.5	Vertical	56.3	74.0	17.7	Complied

Frequency (MHz)	Antenna Polarity	Average Level (dB μ V/m)	Limit (dB μ V/m)	Margin (dB)	Result
2483.5	Vertical	46.5	54.0	7.5	Complied

Results: 2310 MHz to 2390 MHz Restricted Band / Peak

Frequency (MHz)	Antenna Polarity	Level (dB μ V/m)	Limit (dB μ V/m)	Margin (dB)	Result
2350.000	Vertical	54.5	74.0	19.5	Complied

Results: 2310 MHz to 2390 MHz Restricted Band / Average

Frequency (MHz)	Antenna Polarity	Level (dB μ V/m)	Limit (dB μ V/m)	Margin (dB)	Result
2389.872	Vertical	41.8	54.0	12.2	Complied

Transmitter Band Edge Radiated Emissions (continued)

Results: LE2M / SISO / Core 1

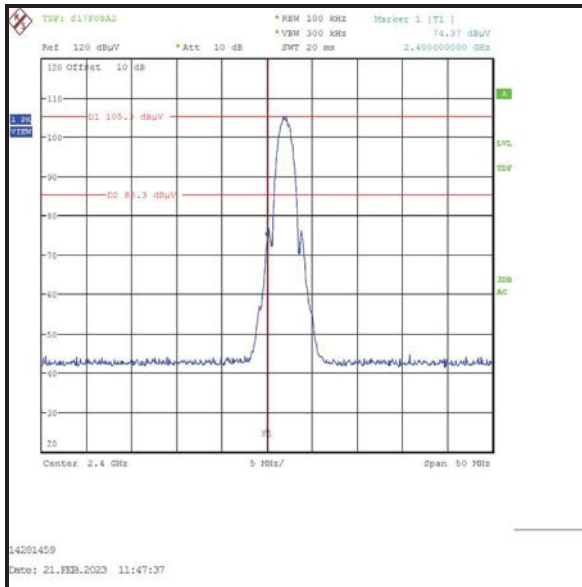

Lower Band Edge

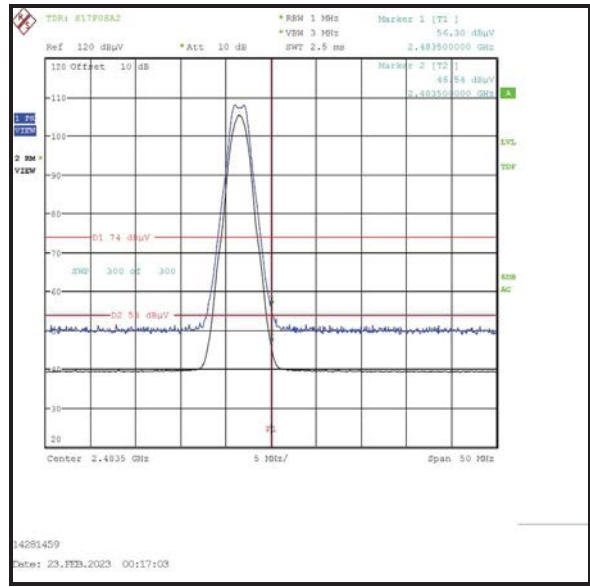

Upper Band Edge

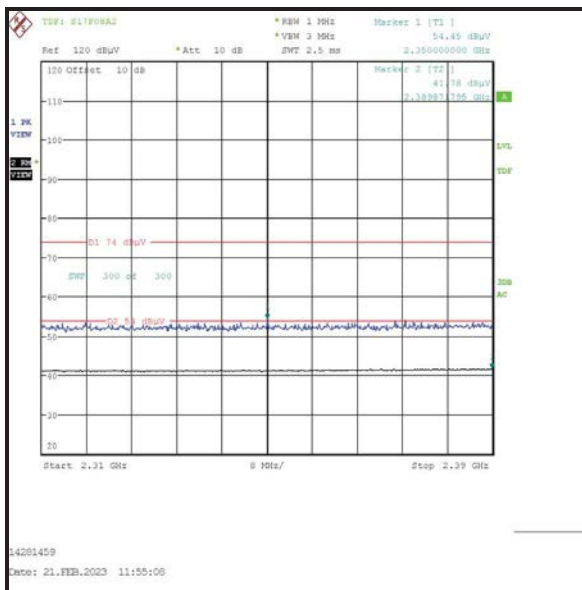

2310 MHz to 2390 MHz Restricted Band

Transmitter Band Edge Radiated Emissions (continued)**Results: LE1M / SISO / Core 2**

Frequency (MHz)	Antenna Polarity	Peak Level (dB μ V/m)	Limit (dB μ V/m)	Margin (dB)	Result
2399.920	Vertical	44.4	86.3*	41.9	Complied
2400.0	Vertical	43.0	86.3*	43.3	Complied
2483.5	Vertical	51.1	74.0	22.9	Complied
2486.785	Vertical	51.9	74.0	22.1	Complied

Frequency (MHz)	Antenna Polarity	Average Level (dB μ V/m)	Limit (dB μ V/m)	Margin (dB)	Result
2483.5	Vertical	40.2	54.0	13.8	Complied
2483.740	Vertical	40.3	54.0	13.7	Complied

Results: 2310 MHz to 2390 MHz Restricted Band / Peak

Frequency (MHz)	Antenna Polarity	Level (dB μ V/m)	Limit (dB μ V/m)	Margin (dB)	Result
2324.615	Vertical	54.4	74.0	19.6	Complied

Results: 2310 MHz to 2390 MHz Restricted Band / Average

Frequency (MHz)	Antenna Polarity	Level (dB μ V/m)	Limit (dB μ V/m)	Margin (dB)	Result
2385.000	Vertical	41.7	54.0	12.3	Complied

Transmitter Band Edge Radiated Emissions (continued)

Results: LE1M / SISO / Core 2

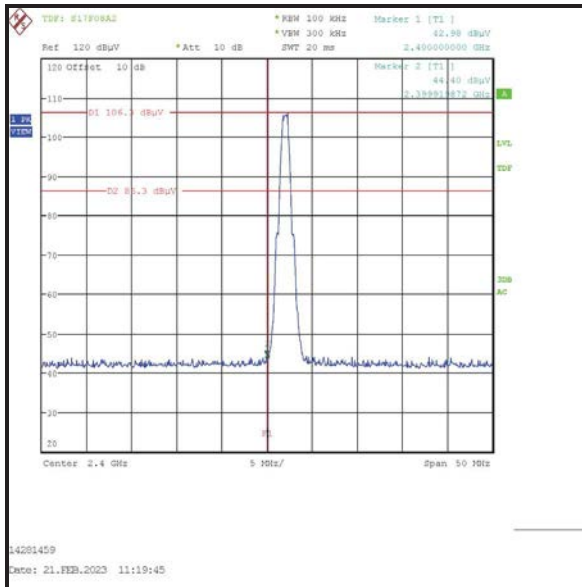

Lower Band Edge

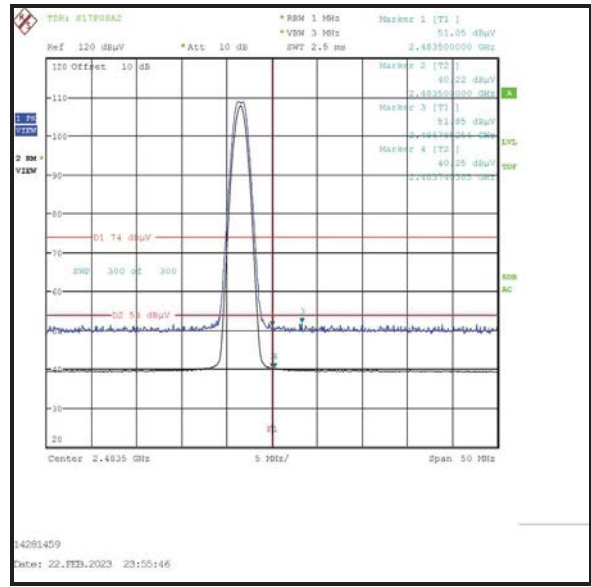

Upper Band Edge

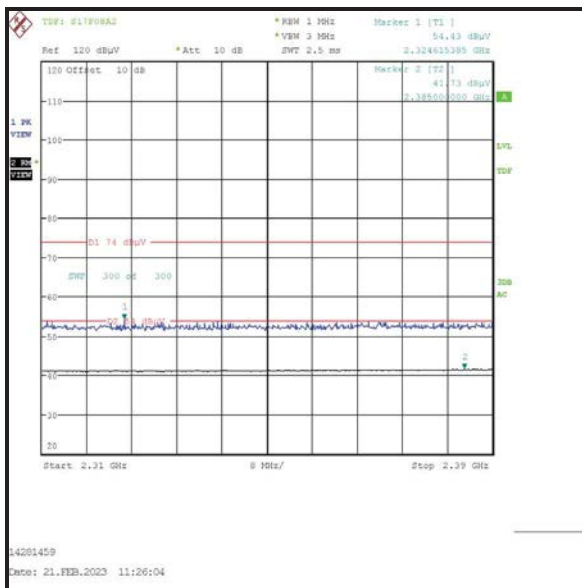

2310 MHz to 2390 MHz Restricted Band

Transmitter Band Edge Radiated Emissions (continued)**Results: LE2M / SISO / Core 2**

Frequency (MHz)	Antenna Polarity	Peak Level (dB μ V/m)	Limit (dB μ V/m)	Margin (dB)	Result
2400.0	Vertical	72.0	84.4*	12.4	Complied
2483.5	Vertical	55.8	74.0	18.2	Complied

Frequency (MHz)	Antenna Polarity	Average Level (dB μ V/m)	Limit (dB μ V/m)	Margin (dB)	Result
2483.5	Vertical	45.8	54.0	8.2	Complied

Results: 2310 MHz to 2390 MHz Restricted Band / Peak

Frequency (MHz)	Antenna Polarity	Level (dB μ V/m)	Limit (dB μ V/m)	Margin (dB)	Result
2354.231	Vertical	54.0	74.0	20.0	Complied

Results: 2310 MHz to 2390 MHz Restricted Band / Average

Frequency (MHz)	Antenna Polarity	Level (dB μ V/m)	Limit (dB μ V/m)	Margin (dB)	Result
2389.231	Vertical	41.7	54.0	12.3	Complied

Transmitter Band Edge Radiated Emissions (continued)

Results: LE2M / SISO / Core 2

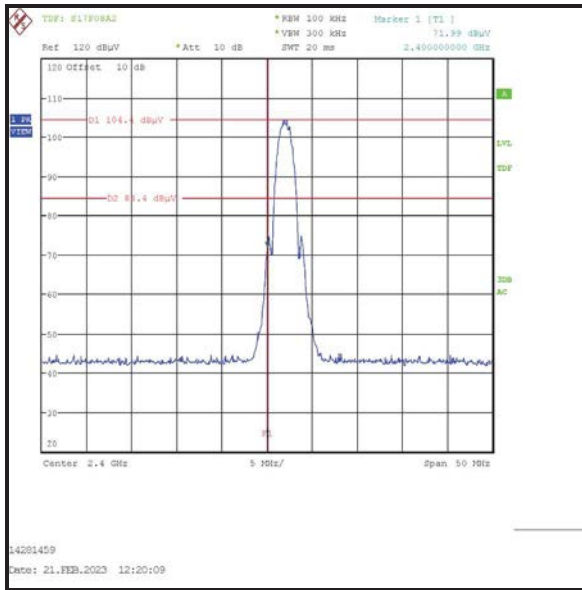

Lower Band Edge

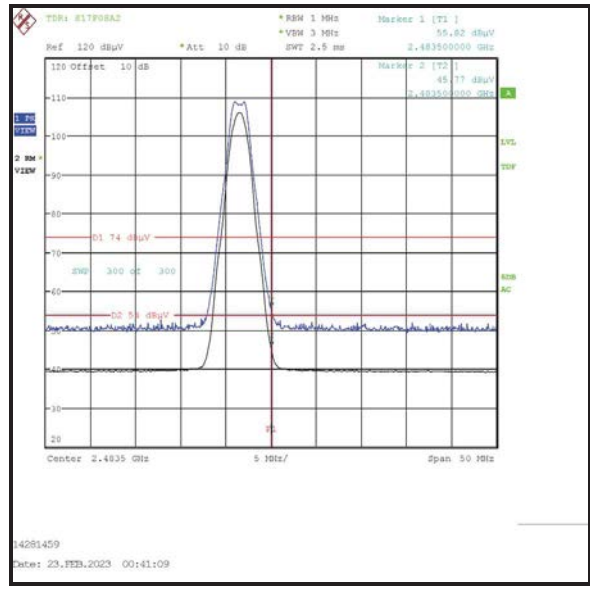

Upper Band Edge

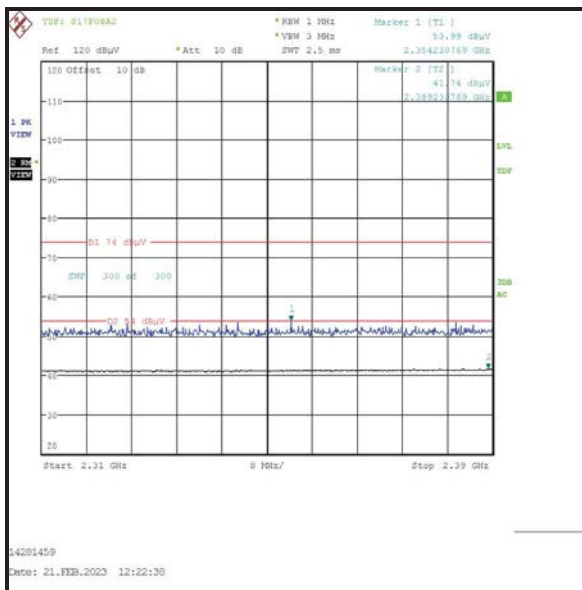

2310 MHz to 2390 MHz Restricted Band

Transmitter Band Edge Radiated Emissions (continued)**Results: LE1M / Beamforming / Core 0 + Core 1**

Frequency (MHz)	Antenna Polarity	Peak Level (dB μ V/m)	Limit (dB μ V/m)	Margin (dB)	Result
2400.0	Vertical	44.0	87.8*	43.8	Complied
2483.5	Vertical	51.4	74.0	22.6	Complied
2485.583	Vertical	52.5	74.0	21.5	Complied

Frequency (MHz)	Antenna Polarity	Average Level (dB μ V/m)	Limit (dB μ V/m)	Margin (dB)	Result
2483.5	Vertical	40.6	54.0	13.4	Complied

Results: 2310 MHz to 2390 MHz Restricted Band / Peak / LE1M

Frequency (MHz)	Antenna Polarity	Level (dB μ V/m)	Limit (dB μ V/m)	Margin (dB)	Result
2337.179	Vertical	54.4	74.0	19.6	Complied

Results: 2310 MHz to 2390 MHz Restricted Band / Average / LE1M

Frequency (MHz)	Antenna Polarity	Level (dB μ V/m)	Limit (dB μ V/m)	Margin (dB)	Result
2388.333	Vertical	41.8	54.0	12.2	Complied

Transmitter Band Edge Radiated Emissions (continued)

Results: LE1M / Beamforming / Core 0 + Core 1

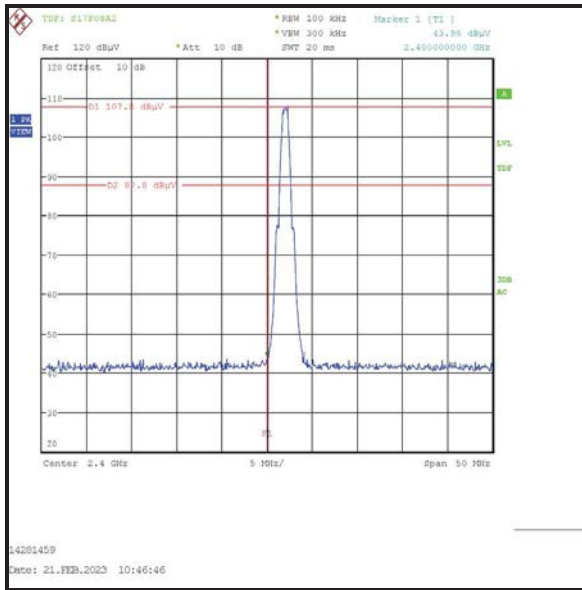

Lower Band Edge

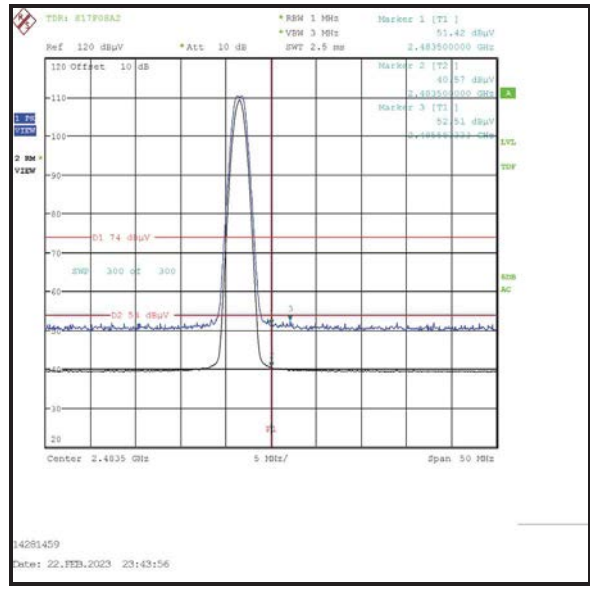

Upper Band Edge

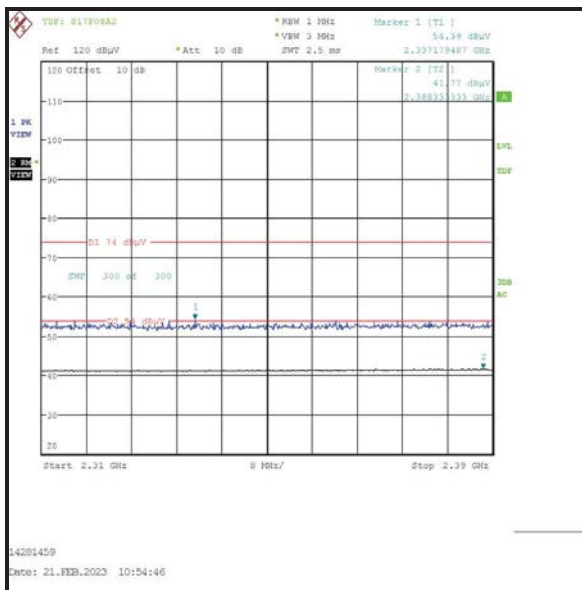

2310 MHz to 2390 MHz Restricted Band

Transmitter Band Edge Radiated Emissions (continued)**Results: LE2M / Beamforming / Core 0 + Core 1**

Frequency (MHz)	Antenna Polarity	Peak Level (dB μ V/m)	Limit (dB μ V/m)	Margin (dB)	Result
2400.0	Vertical	74.2	86.1*	11.9	Complied
2483.5	Vertical	56.6	74.0	17.4	Complied

Frequency (MHz)	Antenna Polarity	Average Level (dB μ V/m)	Limit (dB μ V/m)	Margin (dB)	Result
2483.5	Vertical	45.4	54.0	8.6	Complied

Results: 2310 MHz to 2390 MHz Restricted Band / Peak

Frequency (MHz)	Antenna Polarity	Level (dB μ V/m)	Limit (dB μ V/m)	Margin (dB)	Result
2371.410	Vertical	53.8	74.0	20.2	Complied

Results: 2310 MHz to 2390 MHz Restricted Band / Average

Frequency (MHz)	Antenna Polarity	Level (dB μ V/m)	Limit (dB μ V/m)	Margin (dB)	Result
2389.487	Vertical	41.8	54.0	12.2	Complied

Transmitter Band Edge Radiated Emissions (continued)

Results: LE2M / Beamforming / Core 0 + Core 1

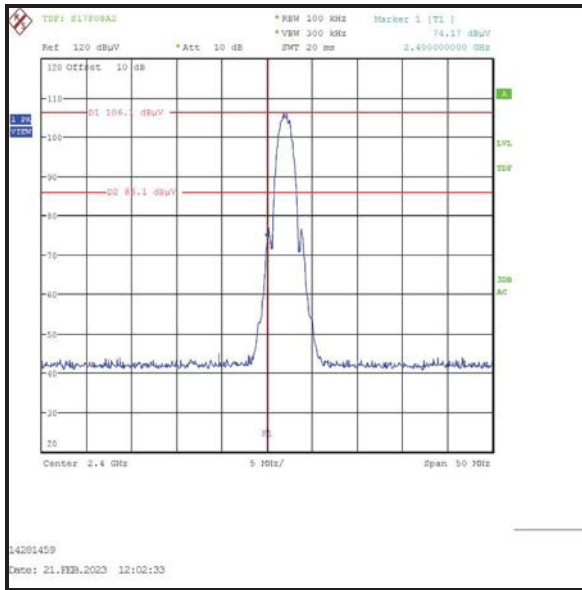

Lower Band Edge

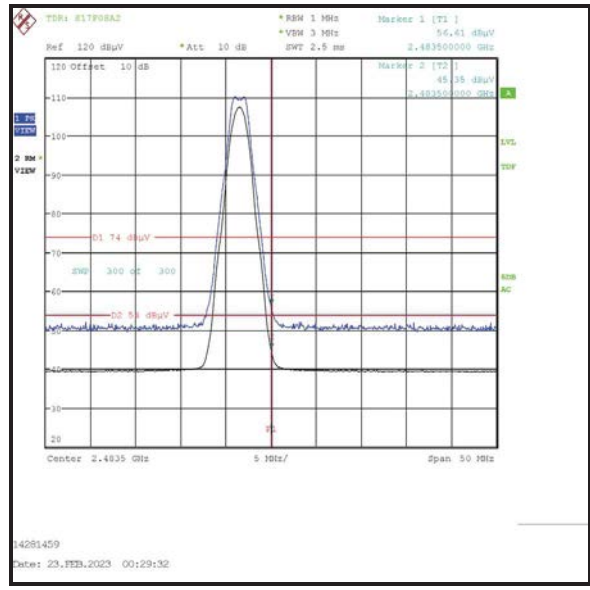

Upper Band Edge

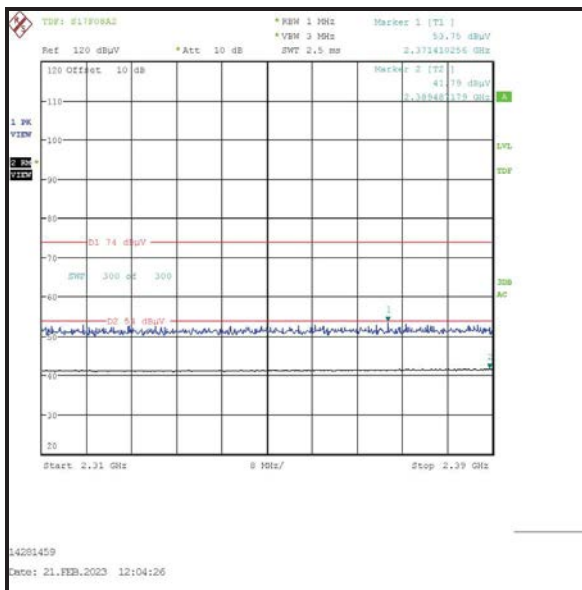

2310 MHz to 2390 MHz Restricted Band

--- END OF REPORT ---