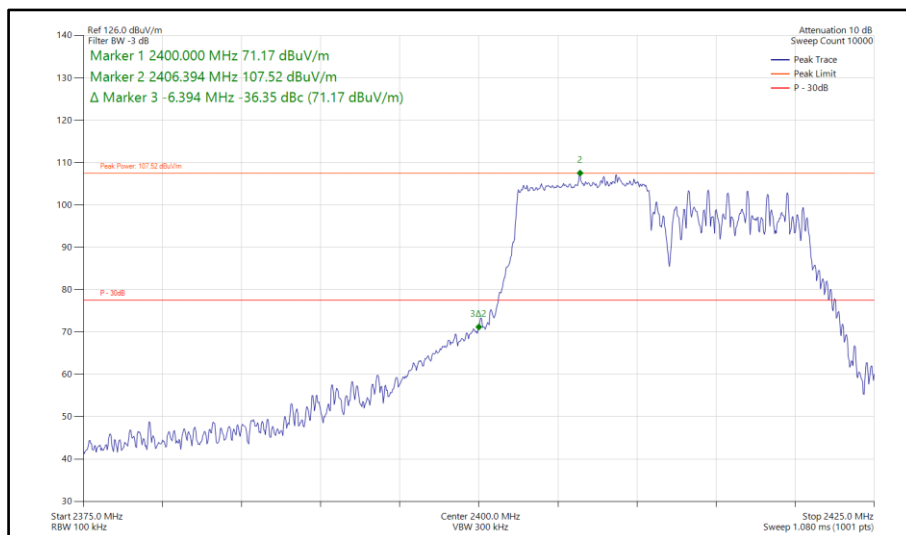

**Figure 80 - 802.11ax, HE20, SU, SISO, Core 0 - 2412 MHz,
Band Edge Frequency 2400 MHz**



**Figure 81 - 802.11ax, HE20, RU 106-53, SISO, Core 0 - 2412 MHz,
Band Edge Frequency 2400 MHz**



20 MHz Bandwidth - Core 1 (SISO)

Mode	Data Rate/ MCS	Resource Size	Resource Index	TX Frequency (MHz)	Band Edge Frequency (MHz)	Level (dBc)
802.11b	1 Mbps	-	-	2412	2400	-48.66
802.11g	24 Mbps	-	-	2412	2400	-34.50
802.11n HT20	MCS4	-	-	2412	2400	-34.77
802.11ax HE20	MCS9x1	SU	-	2412	2400	-34.92
802.11ax HE20	MCS9x1	106	53	2412	2400	-35.96

Table 55 - SISO Authorised Band Edge Results

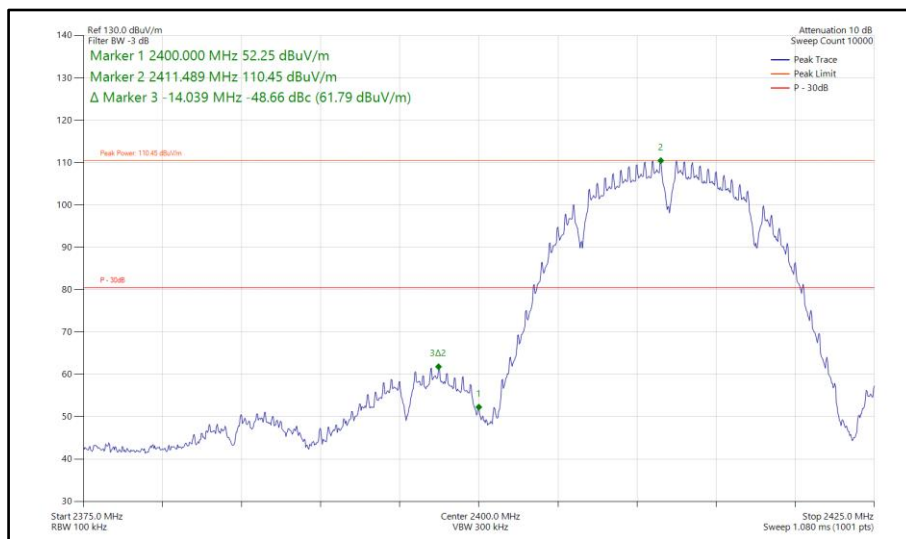

**Figure 82 - 802.11b, SISO, Core 1 - 2412 MHz,
 Band Edge Frequency 2400 MHz**

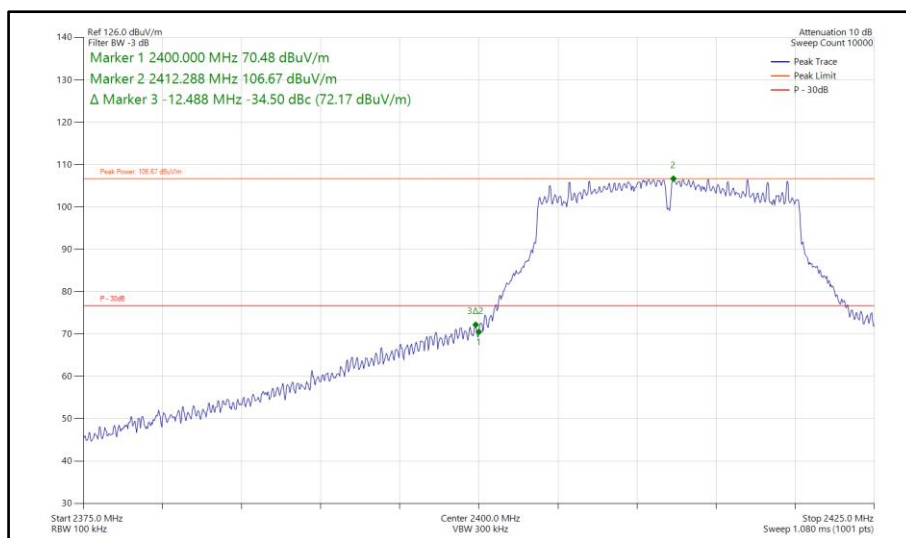

**Figure 83 - 802.11g, SISO, Core 1 - 2412 MHz,
 Band Edge Frequency 2400 MHz**

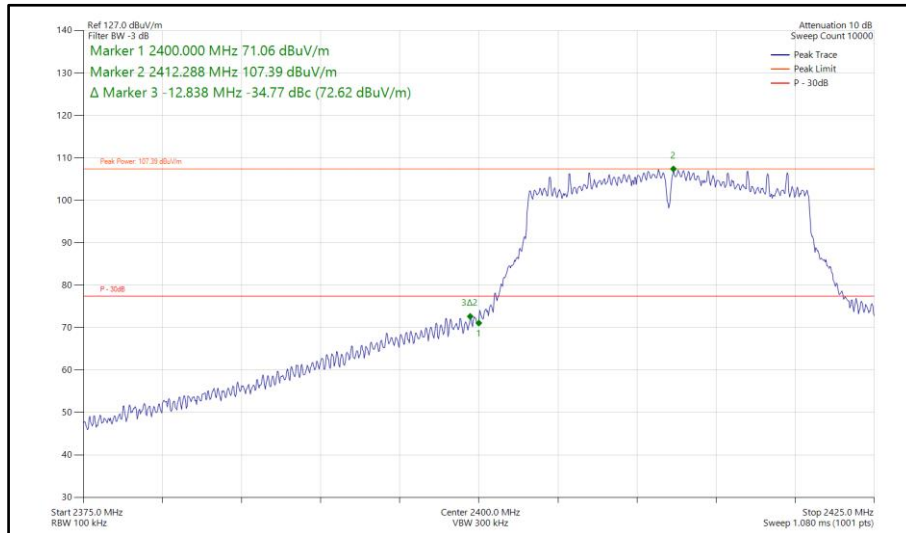

**Figure 84 - 802.11n, HT20, SISO, Core 1 - 2412 MHz,
Band Edge Frequency 2400 MHz**

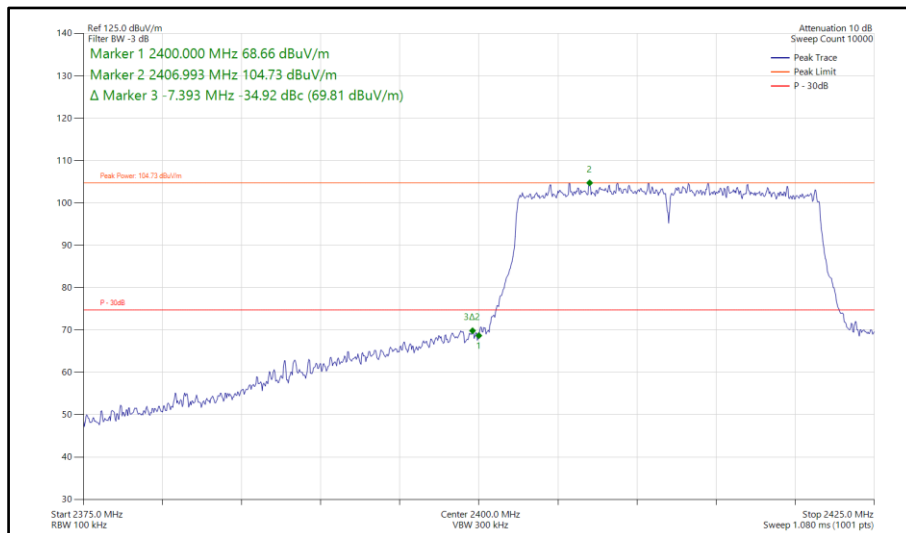

**Figure 85 - 802.11ax, HE20, SU, SISO, Core 1 - 2412 MHz,
Band Edge Frequency 2400 MHz**

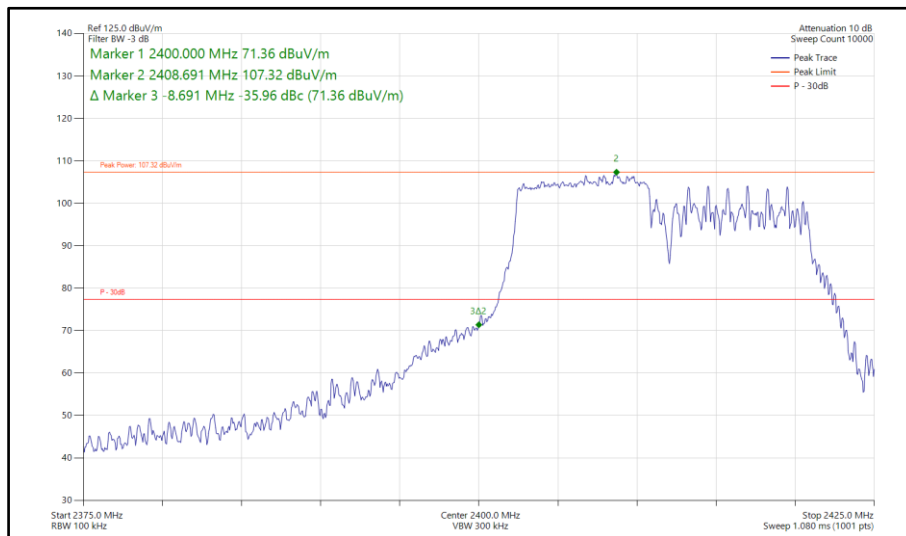

**Figure 86 - 802.11ax, HE20, RU 106-53, SISO, Core 1 - 2412 MHz,
Band Edge Frequency 2400 MHz**



20 MHz Bandwidth - Core 0-1 (CDD)

Mode	Data Rate/ MCS	Resource Size	Resource Index	TX Frequency (MHz)	Band Edge Frequency (MHz)	Level (dBc)
802.11n HT20	MCS4	-	-	2412	2400	-34.79
802.11ax HE20	MCS4x1	SU	-	2412	2400	-34.56
802.11ax HE20	MCS9x1	106	53	2412	2400	-36.36

Table 56 - CDD Authorised Band Edge Results

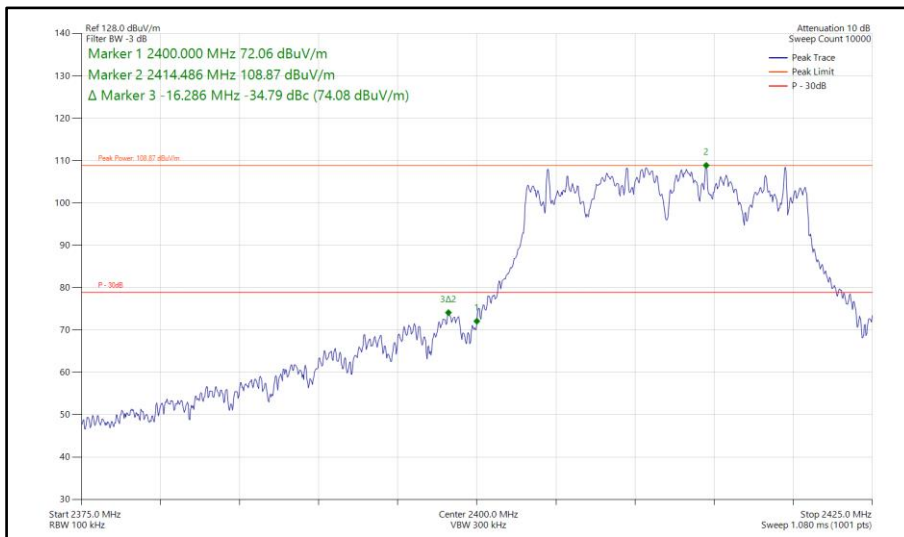

Figure 87 - 802.11n, HT20, CDD, Core 0-1 - 2412 MHz, Band Edge Frequency 2400 MHz

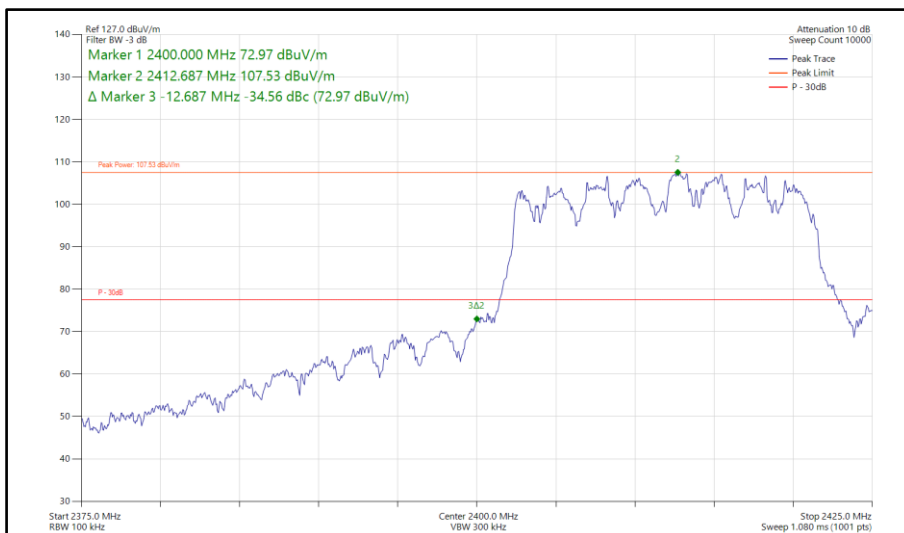
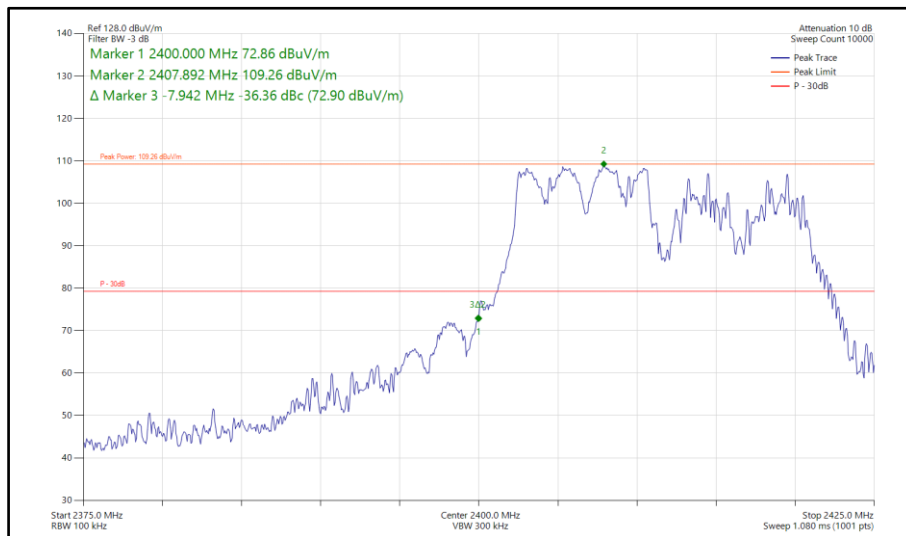

Figure 88 - 802.11ax, HE20, SU, CDD, Core 0-1 - 2412 MHz, Band Edge Frequency 2400 MHz



**Figure 89 - 802.11ax, HE20, RU 106-53, CDD, Core 0-1 - 2412 MHz,
Band Edge Frequency 2400 MHz**

FCC 47 CFR Part 15, Limit Clause 15.247 (d)

20 dB below the fundamental measured in a 100 kHz bandwidth using a peak detector. If the transmitter complies with the conducted power limits, based on the use of RMS averaging over a time interval, the attenuation required shall be 30 dB below the fundamental instead of 20 dB.

ISED RSS-247, Limit Clause 5.5

In any 100 kHz bandwidth outside the frequency band in which the spread spectrum or digitally modulated device is operating, the RF power that is produced shall be at least 20 dB below that in the 100 kHz bandwidth within the band that contains the highest level of the desired power, based on either an RF conducted or a radiated measurement, provided that the transmitter demonstrates compliance with the peak conducted power limits. If the transmitter complies with the conducted power limits based on the use of root-mean-square averaging over a time interval, as permitted under Section 5.4(4), the attenuation required shall be 30 dB instead of 20 dB. Attenuation below the general field strength limits specified in RSS-Gen is not required.



2.4.7 Test Location and Test Equipment Used

This test was carried out in RF Chamber 16.

Instrument	Manufacturer	Type No.	TE No.	Calibration Period (months)	Calibration Expiry Date
Emissions Software	TUV SUD	EmX V3.1.10	5125	-	Software
Cable (18GHz)	Junkosha	MWX221-04000NMSNMS/B	5262	12	04-Aug-2023
Cable (18 GHz)	Junkosha	MWX221-04000NMSNMS/B	5263	12	28-Feb-2023
1500W (300V 12A) AC Power Supply	iTech	IT7324	5957	-	O/P Mon
3m Semi-Anechoic Chamber	Schaffner	RF Chamber 16	5972	36	24-May-2025
Mast & Turntable Controller	Maturo Gmbh	FCU3.0	5973	-	TU
Tilt Antenna Mast	Maturo Gmbh	BAM4.5-P	5974	-	TU
Cable (SMA to SMA 1m)	Junkosha	MWX221-01000AMSAMS/A	6018	12	06-Jun-2023
Horn Antenna (1-10 GHz)	Schwarzbeck	BBHA9120B	6142	12	26-Jun-2023
Digital Multimeter	Fluke	115	6146	12	16-Jun-2023
Humidity & Temperature meter	R.S Components	1364	6148	12	17-Jun-2023
SAC Switch Unit	TUV SUD	TUV_SSU_001	6190	12	16-Dec-2023
EMI Test Receiver	Rohde & Schwarz	ESW44	6294	12	03-Nov-2023

Table 57

TU - Traceability Unscheduled
 O/P Mon - Output Monitored using calibrated equipment



2.5 Spurious Radiated Emissions

2.5.1 Specification Reference

FCC 47 CFR Part 15C, Clause 15.209 and 15.247 (d)
ISED RSS-247, Clause 3.3 and 5.5
ISED RSS-GEN, Clause 6.13 and 8.9

2.5.2 Equipment Under Test and Modification State

A2901, S/N: QXM2RLKFW6 - Modification State 0

2.5.3 Date of Test

26-March-2023 to 04-April-2023

2.5.4 Test Method

This test was performed in accordance with ANSI C63.10, clause 6.3, 6.5 and 6.6.

For frequencies > 1 GHz, plots for average measurements were taken in accordance with ANSI C63.10, clause 11.12.2.5.2.

Ports on the EUT were terminated with loads as described in ANSI C63.4 clause 6.2.4. For EUT's with multiple connectors of the same type, additional interconnecting cables were connected, and pre-scans performed to determine whether the level of the emissions were increased by >2 dB.

In the 30 MHz to 1 GHz range pre-scans were only performed on the mid channel (2437 MHz) only.

The plots shown are the characterisation of the EUT. The limits on the plots represent the most stringent case for restricted bands, (74/54 dBuV/m) when compared to 20 dBc outside restricted bands. The limits shown have been used as a threshold to determine where further measurements are necessary. Where results are within 10 dB of the limits shown on the plots, further investigation was carried out and reported in results tables.

The following conversion can be applied to convert from dB μ V/m to μ V/m:
 $10^{(\text{Field Strength in dB}\mu\text{V/m}/20)}$.

To determine the emission characteristic of the EUT above 18 GHz, the test antenna was swept over all faces of the EUT whilst observing a spectral display. The frequency of any emissions of interest was noted for formal measurement at the correct measurement distance of 1m. This procedure was repeated for all relevant transmit operating channels.

Above 18 GHz, the measurement distance was reduced to 1 m. The limit line was increased by $20 \cdot \text{LOG}(3/1) = 9.54$ dB.

At a measurement distance of 1 meter the limit line was increased by $20 \cdot \text{LOG}(3/1) = 9.54$ dB.

Where formal measurements have been necessary, the results have been presented in the emissions table.

2.5.5 Example Test Setup Diagram

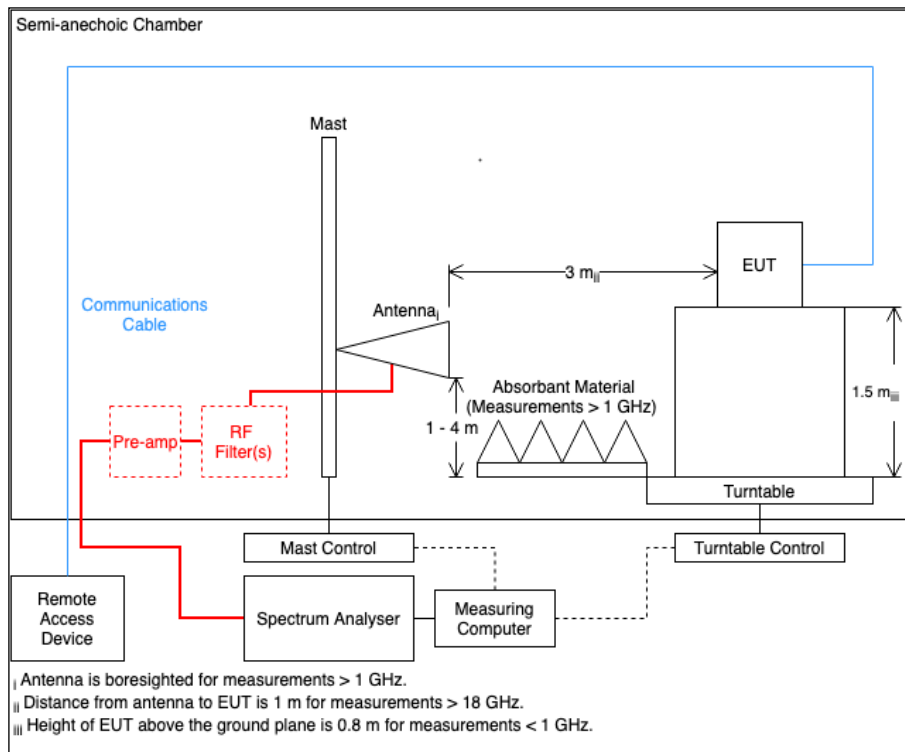

Figure 90

2.5.6 Environmental Conditions

Ambient Temperature	21.5 - 24.5 °C
Relative Humidity	38.7 - 45.1 %



2.5.7 Test Results

2.4 GHz WLAN

Frequency (MHz)	Level (dBuV/m)	Limit (dBuV/m)	Margin (dB)	Detector	Angle (°)	Height (cm)	Polarisation
*							

Table 58 - 2412 MHz (CH1), 802.11b, Core 0, 1 GHz to 26 GHz

*No emissions found within 10 dB of the limit.

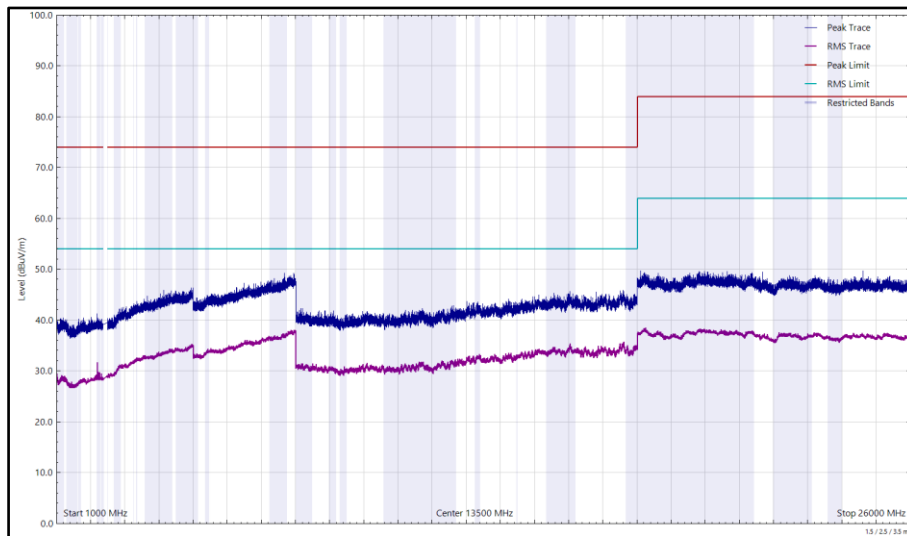

Figure 91 - 2412 MHz (CH1), 802.11b, Core 0, 1 GHz to 26 GHz, Horizontal

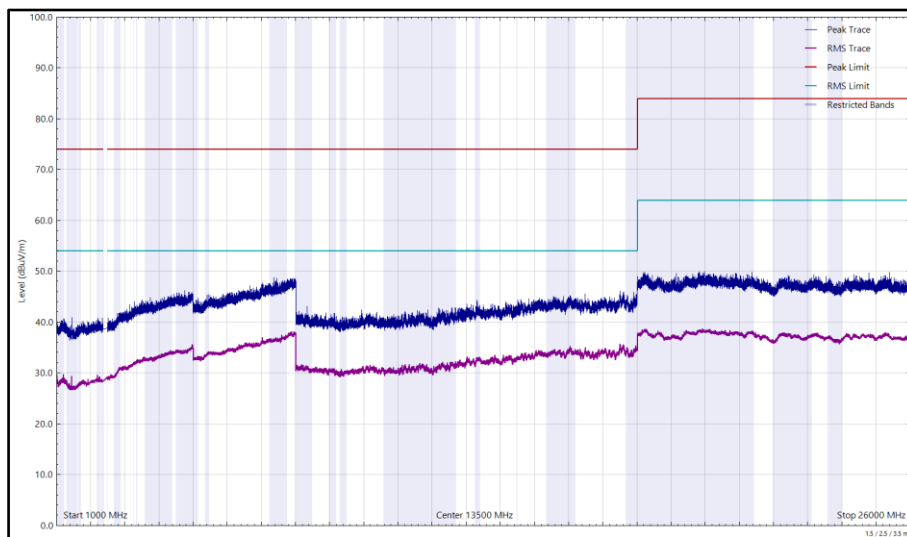

Figure 92 - 2412 MHz (CH1), 802.11b, Core 0, 1 GHz to 26 GHz, Vertical



Frequency (MHz)	Level (dBuV/m)	Limit (dBuV/m)	Margin (dB)	Detector	Angle (°)	Height (cm)	Polarisation
*							

Table 59 - 2442 MHz (CH7), 802.11b, Core 0, 30 MHz to 26 GHz

*No emissions found within 10 dB of the limit.

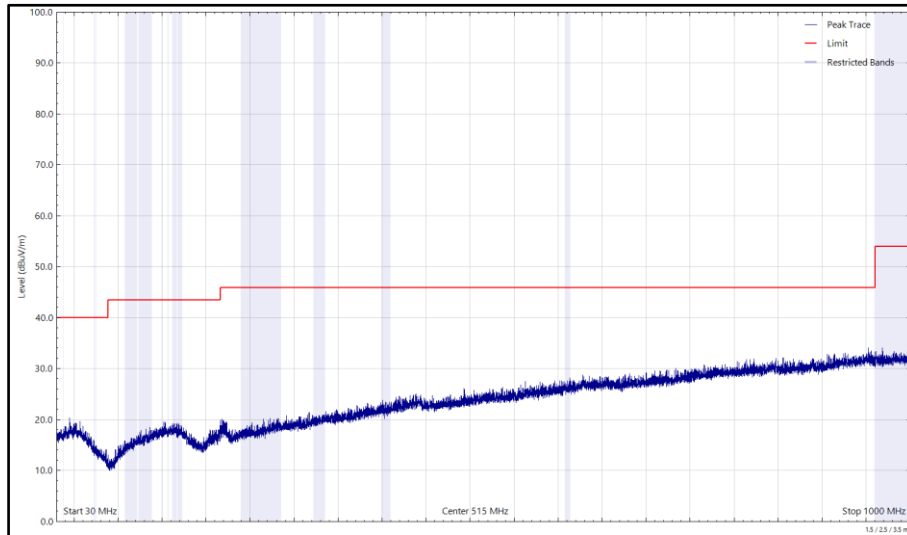

Figure 93 - 2442 MHz (CH7), 802.11b, Core 0, 30 MHz to 1 GHz, Horizontal (Peak)

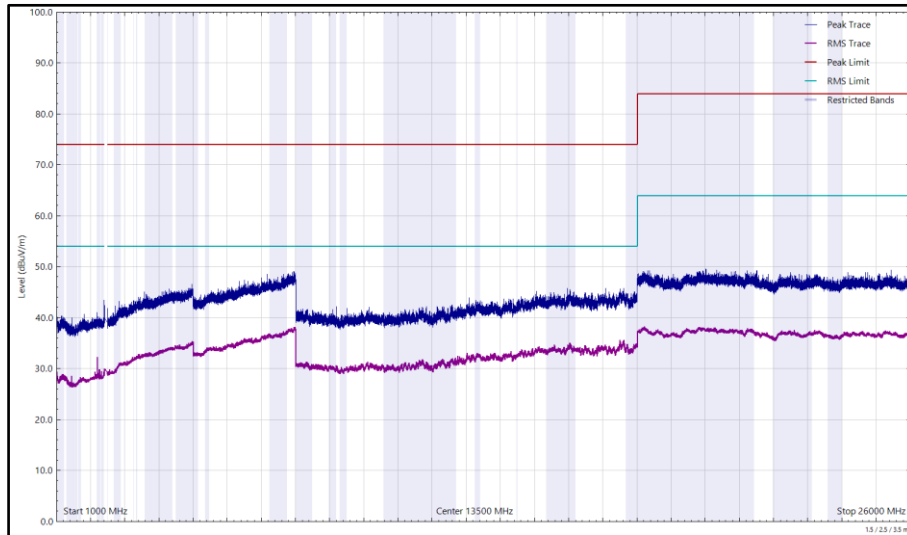

Figure 94 - 2442 MHz (CH7), 802.11b, Core 0, 1 GHz to 26 GHz, Horizontal

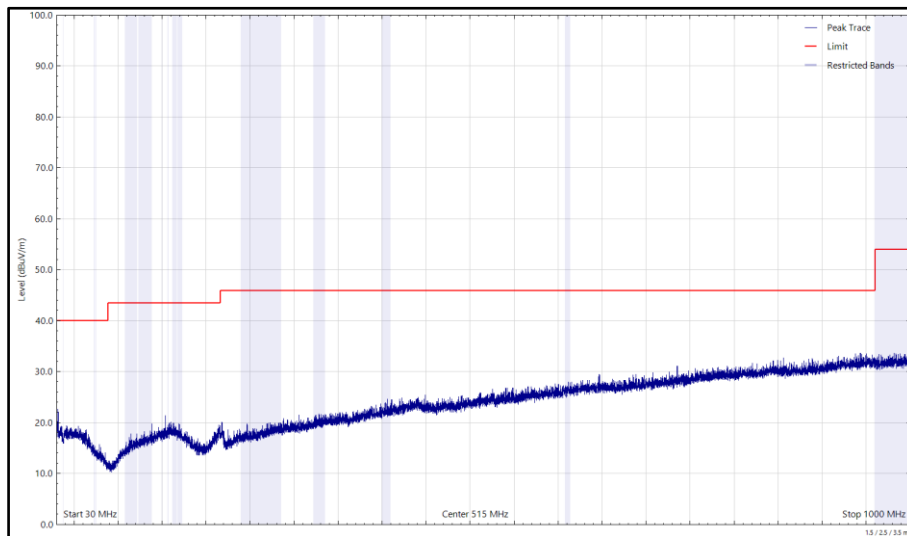

Figure 95 - 2442 MHz (CH7), 802.11b, Core 0, 30 MHz to 1 GHz, Vertical (Peak)

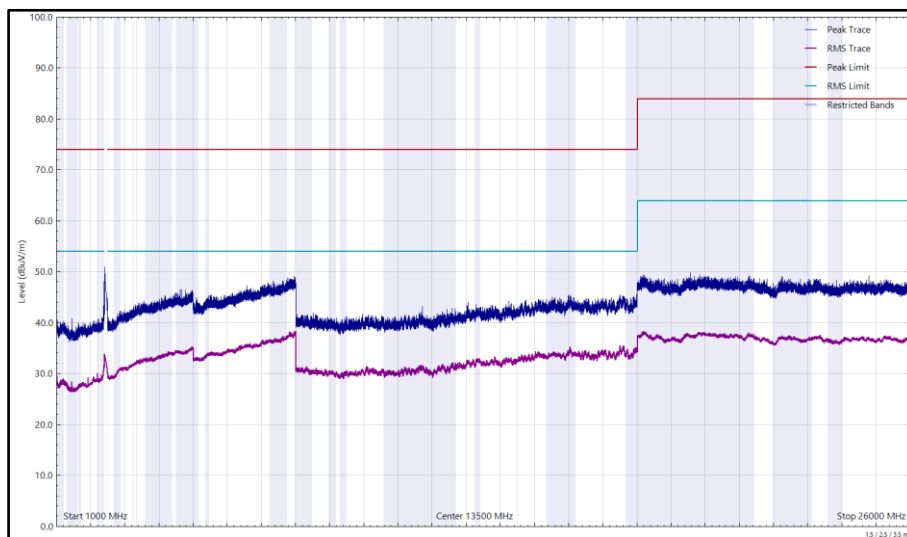

Figure 96 - 2442 MHz (CH7), 802.11b, Core 0, 1 GHz to 26 GHz, Vertical



Frequency (MHz)	Level (dBuV/m)	Limit (dBuV/m)	Margin (dB)	Detector	Angle (°)	Height (cm)	Polarisation
*							

Table 60 - 2472 MHz (CH13), 802.11b, Core 0, 1 GHz to 26 GHz

*No emissions found within 10 dB of the limit.

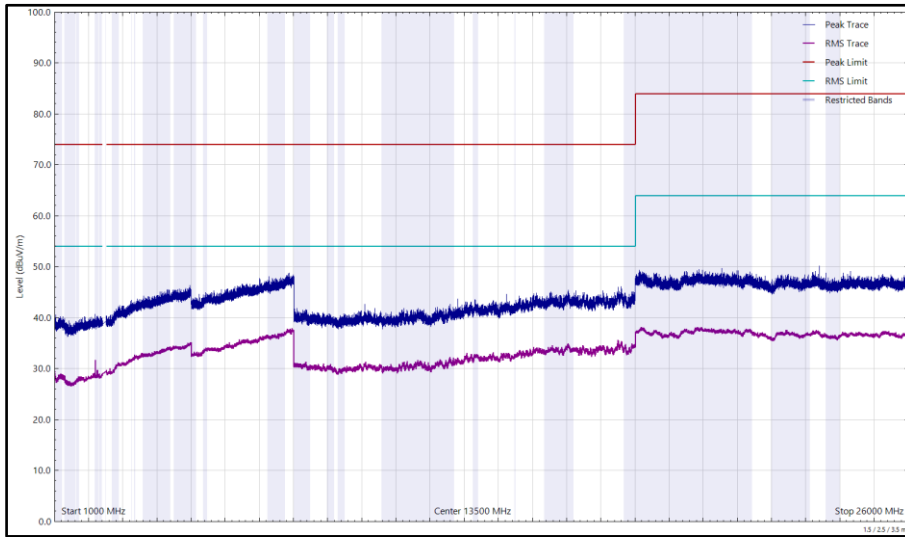

Figure 97 - 2472 MHz (CH13), 802.11b, Core 0, 1 GHz to 26 GHz, Horizontal

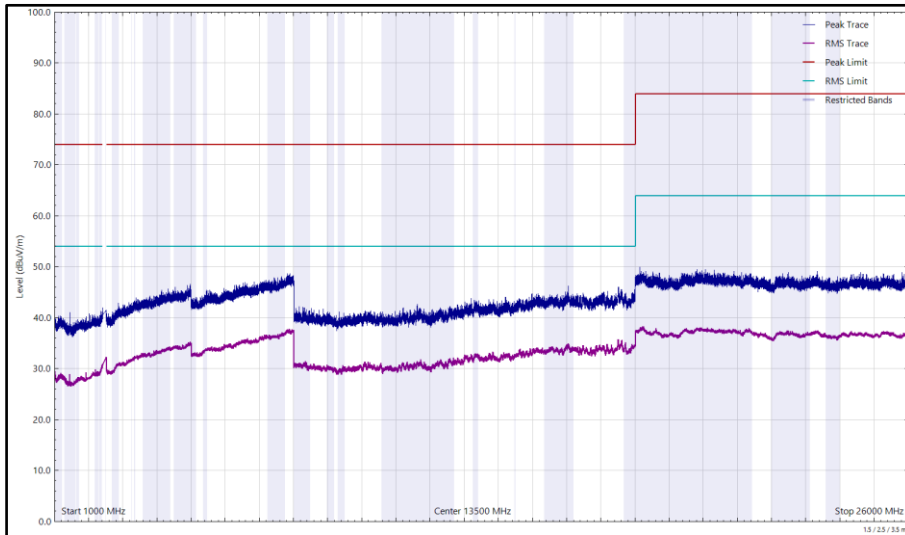

Figure 98 - 2472 MHz (CH13), 802.11b, Core 0, 1 GHz to 26 GHz, Vertical



Frequency (MHz)	Level (dBuV/m)	Limit (dBuV/m)	Margin (dB)	Detector	Angle (°)	Height (cm)	Polarisation
*							

Table 61 - 2412 MHz (CH1), 802.11b, Core 1, 1 GHz to 26 GHz

*No emissions found within 10 dB of the limit.

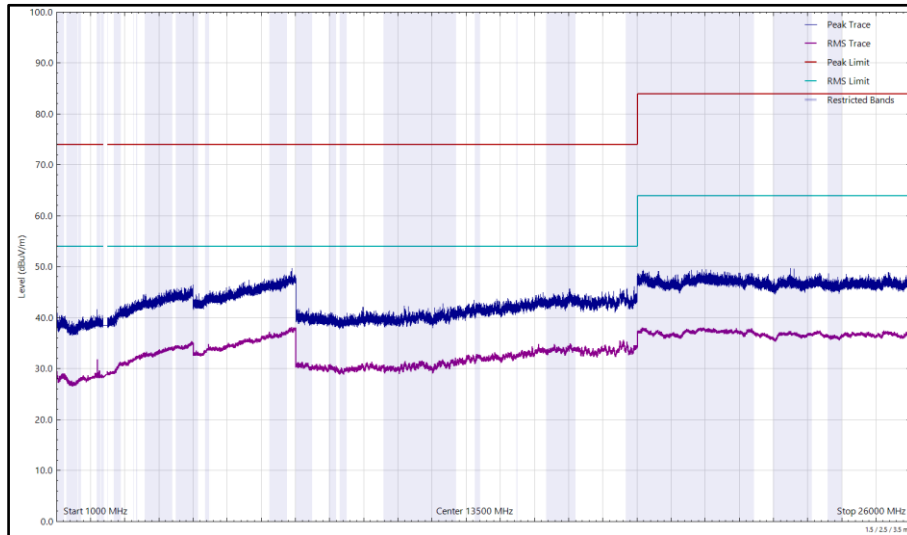

Figure 99 - 2412 MHz (CH1), 802.11b, Core 1, 1 GHz to 26 GHz, Horizontal

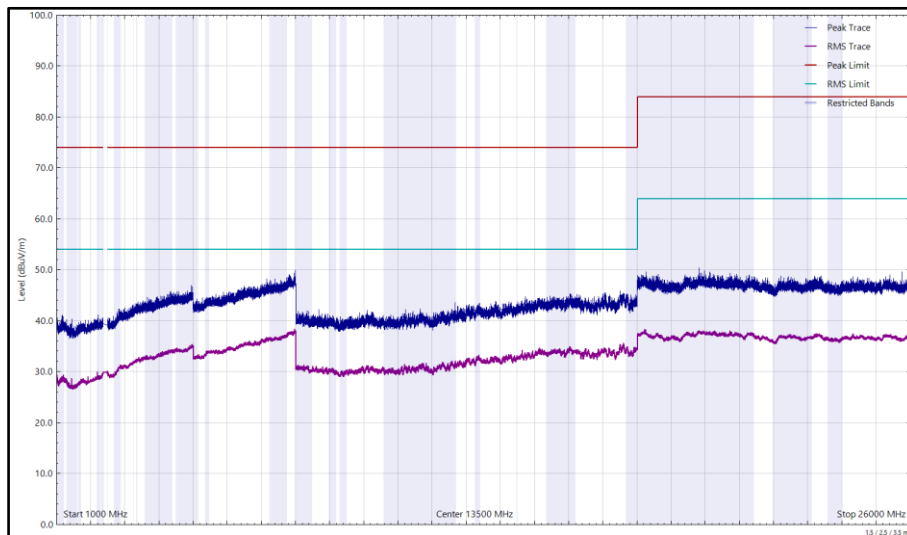

Figure 100 - 2412 MHz (CH1), 802.11b, Core 1, 1 GHz to 26 GHz, Vertical



Frequency (MHz)	Level (dBuV/m)	Limit (dBuV/m)	Margin (dB)	Detector	Angle (°)	Height (cm)	Polarisation
*							

Table 62 - 2442 MHz (CH7), 802.11b, Core 1, 30 MHz to 26 GHz

*No emissions found within 10 dB of the limit.

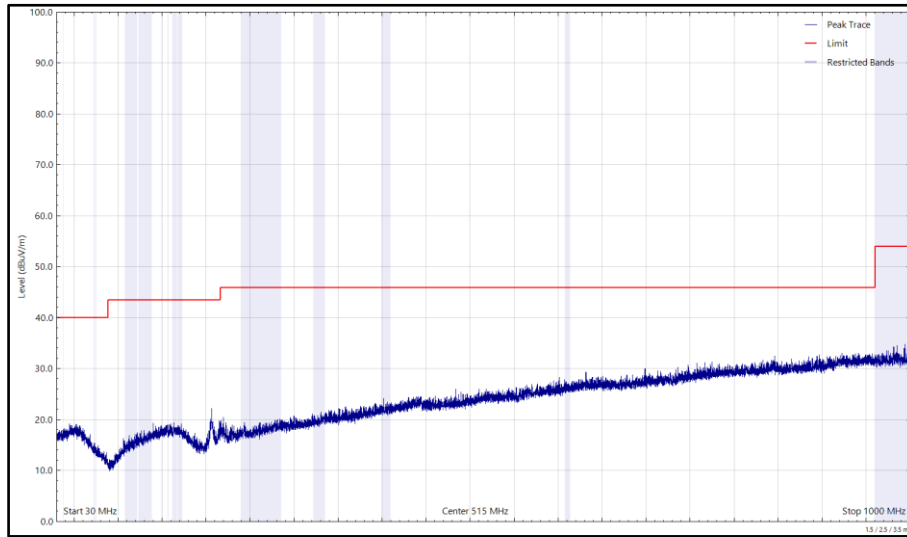

Figure 101 - 2442 MHz (CH7), 802.11b, Core 1, 30 MHz to 1 GHz, Horizontal (Peak)

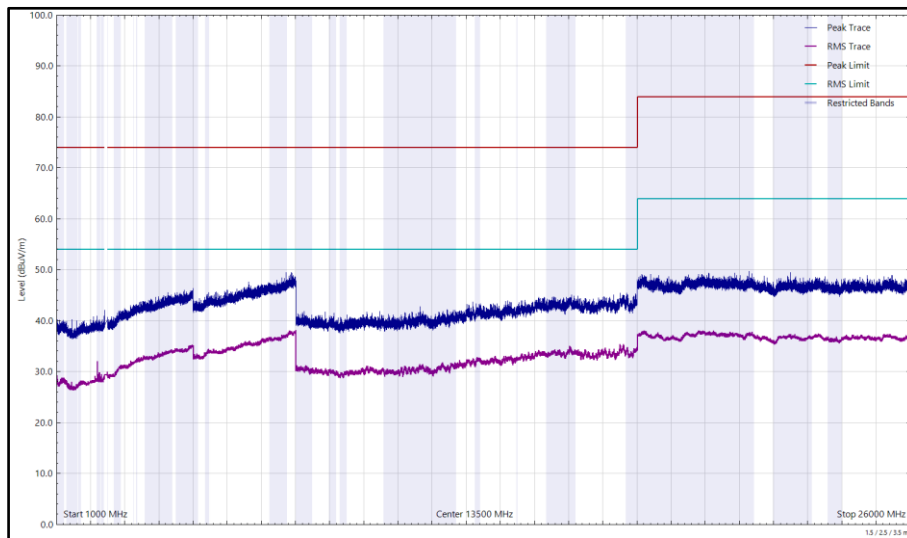

Figure 102 - 2442 MHz (CH7), 802.11b, Core 1, 1 GHz to 26 GHz, Horizontal

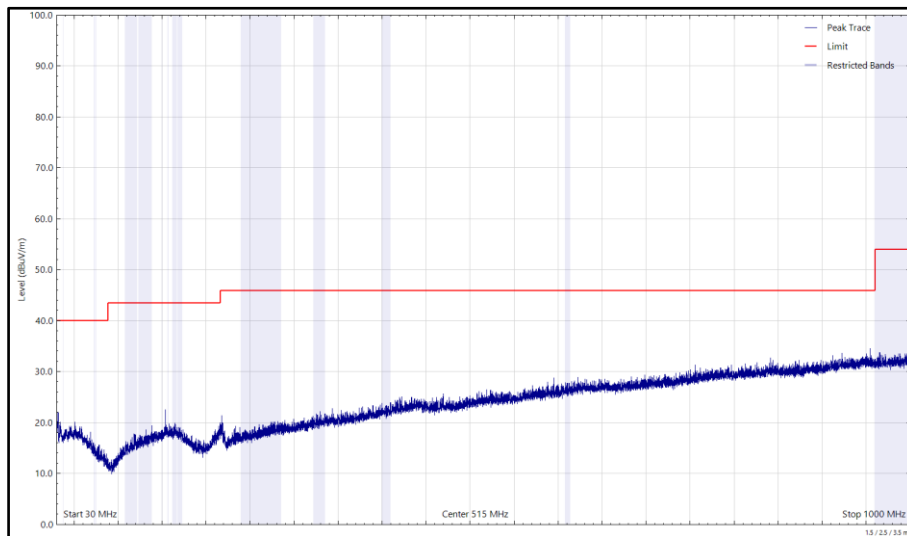

Figure 103 - 2442 MHz (CH7), 802.11b, Core 1, 30 MHz to 1 GHz, Vertical (Peak)

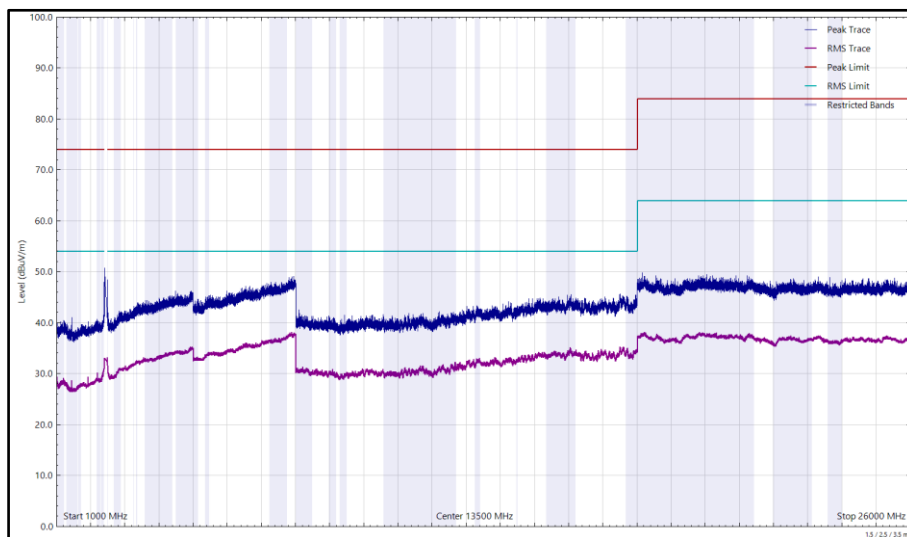

Figure 104 - 2442 MHz (CH7), 802.11b, Core 1, 1 GHz to 26 GHz, Vertical



Frequency (MHz)	Level (dBuV/m)	Limit (dBuV/m)	Margin (dB)	Detector	Angle (°)	Height (cm)	Polarisation
*							

Table 63 - 2472 MHz (CH13), 802.11b, Core 1, 1 GHz to 26 GHz

*No emissions found within 10 dB of the limit.

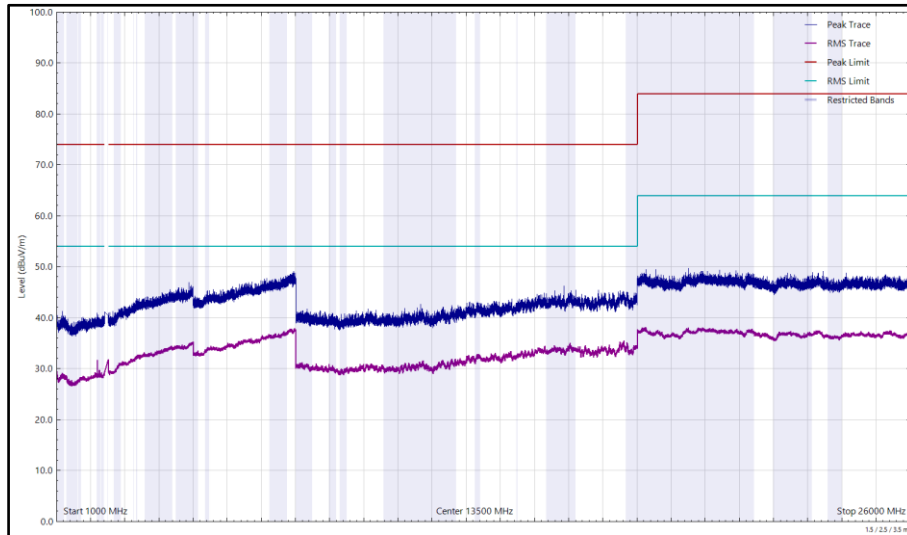

Figure 105 - 2472 MHz (CH13), 802.11b, Core 1, 1 GHz to 26 GHz, Horizontal

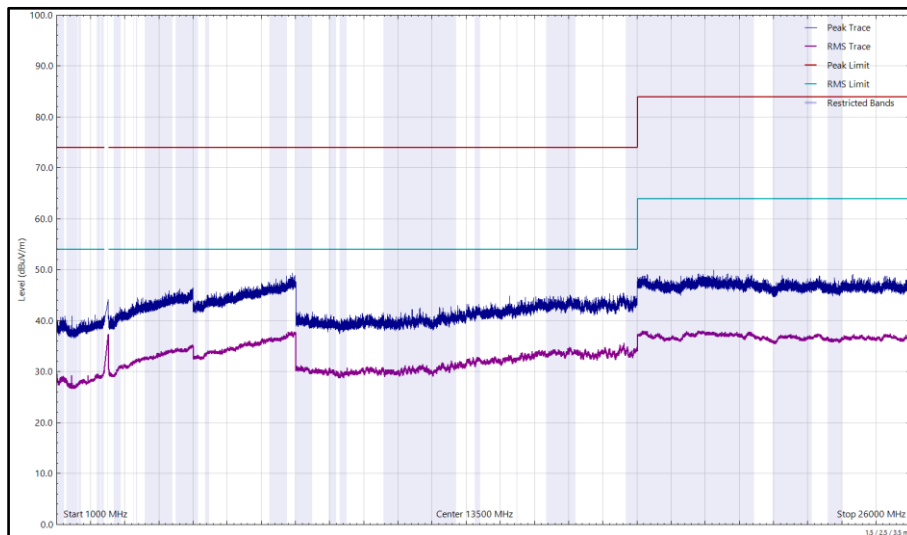

Figure 106 - 2472 MHz (CH13), 802.11b, Core 1, 1 GHz to 26 GHz, Vertical



Frequency (MHz)	Level (dBuV/m)	Limit (dBuV/m)	Margin (dB)	Detector	Angle (°)	Height (cm)	Polarisation
*							

Table 64 - 2412 MHz (CH1), 802.11g, Core 0, 1 GHz to 26 GHz

*No emissions found within 10 dB of the limit.

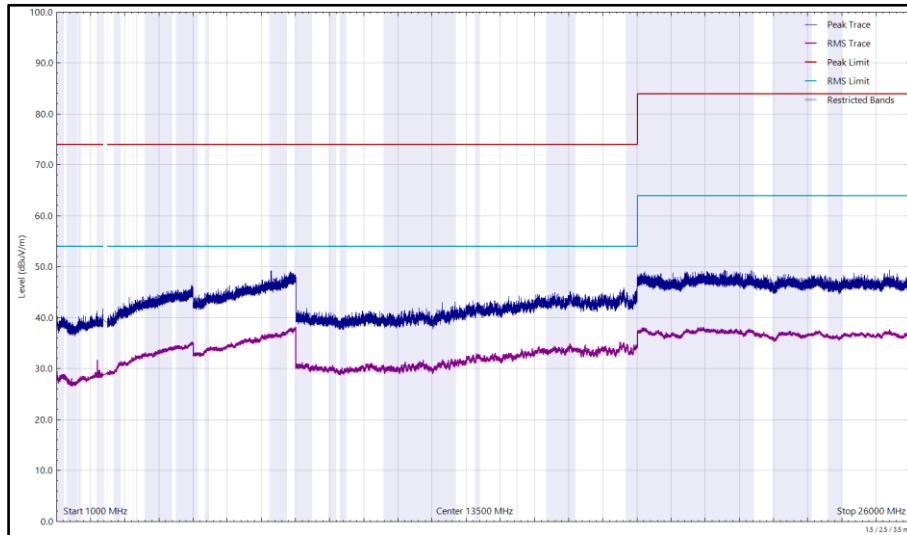

Figure 107 - 2412 MHz (CH1), 802.11g, Core 0, 1 GHz to 26 GHz, Horizontal

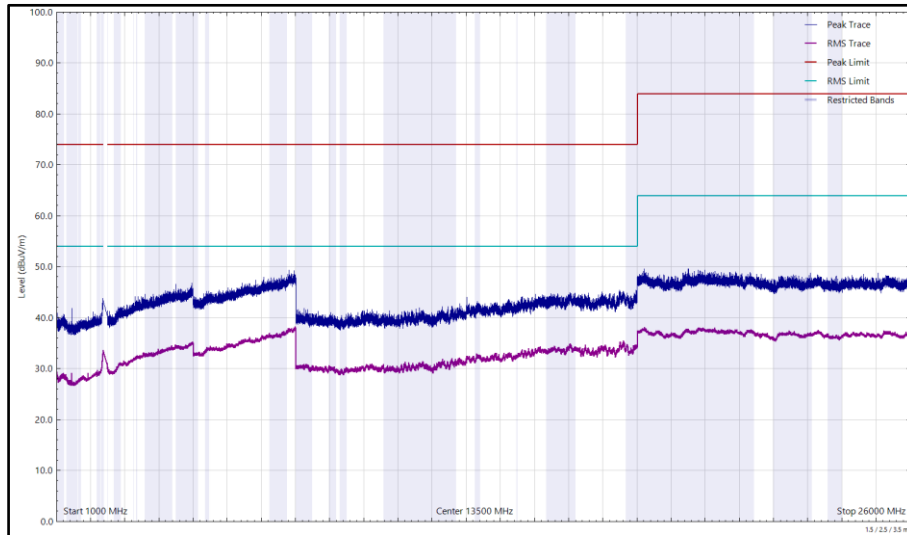

Figure 108 - 2412 MHz (CH1), 802.11g, Core 0, 1 GHz to 26 GHz, Vertical



Frequency (MHz)	Level (dBuV/m)	Limit (dBuV/m)	Margin (dB)	Detector	Angle (°)	Height (cm)	Polarisation
*							

Table 65 - 2442 MHz (CH7), 802.11g, Core 0, 30 MHz to 26 GHz

*No emissions found within 10 dB of the limit.

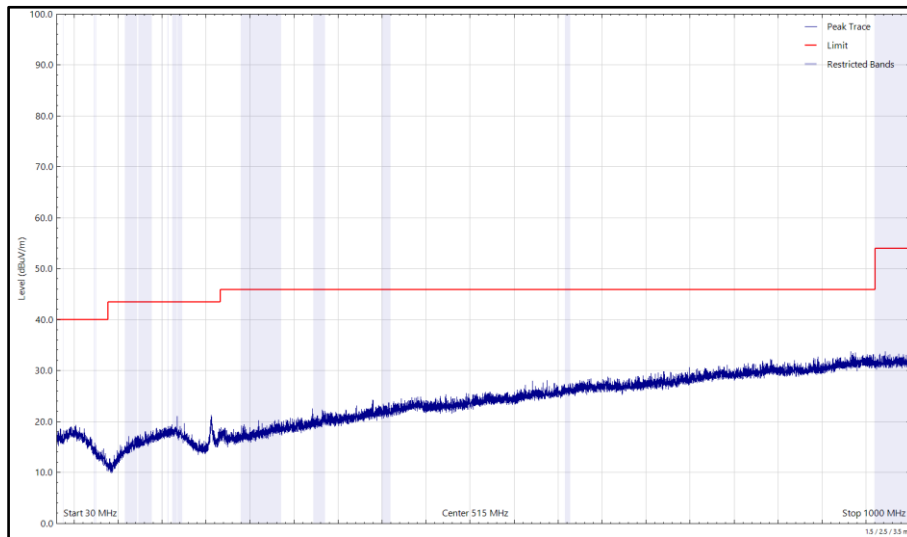

Figure 109 - 2442 MHz (CH7), 802.11g, Core 0, 30 MHz to 1 GHz, Horizontal (Peak)

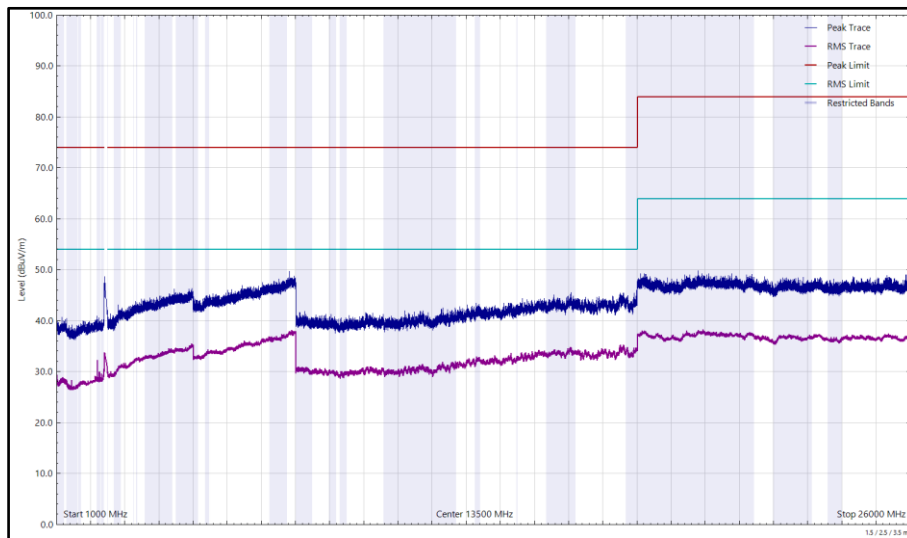

Figure 110 - 2442 MHz (CH7), 802.11g, Core 0, 1 GHz to 26 GHz, Horizontal

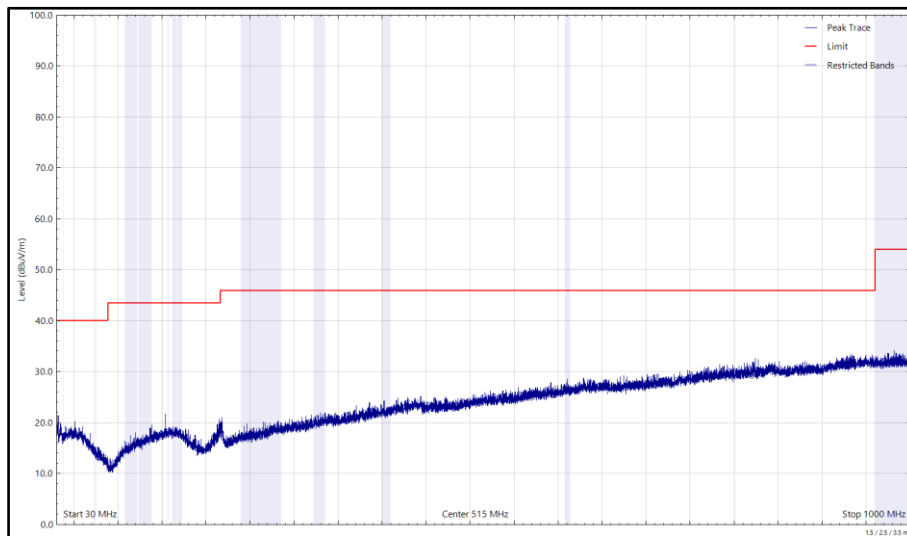

Figure 111 - 2442 MHz (CH7), 802.11g, Core 0, 30 MHz to 1 GHz, Vertical (Peak)

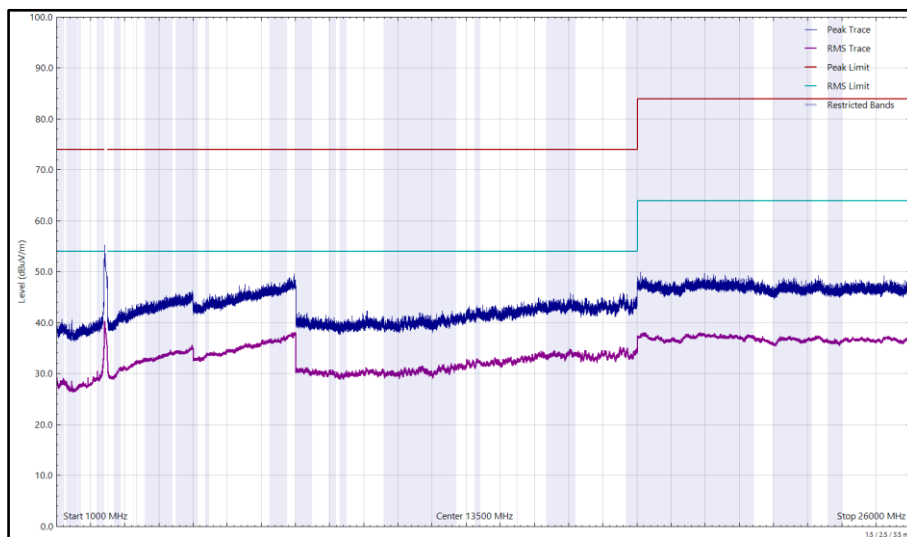

Figure 112 - 2442 MHz (CH7), 802.11g, Core 0, 1 GHz to 26 GHz, Vertical



Frequency (MHz)	Level (dBuV/m)	Limit (dBuV/m)	Margin (dB)	Detector	Angle (°)	Height (cm)	Polarisation
*							

Table 66 - 2472 MHz (CH13), 802.11g, Core 0, 1 GHz to 26 GHz

*No emissions found within 10 dB of the limit.

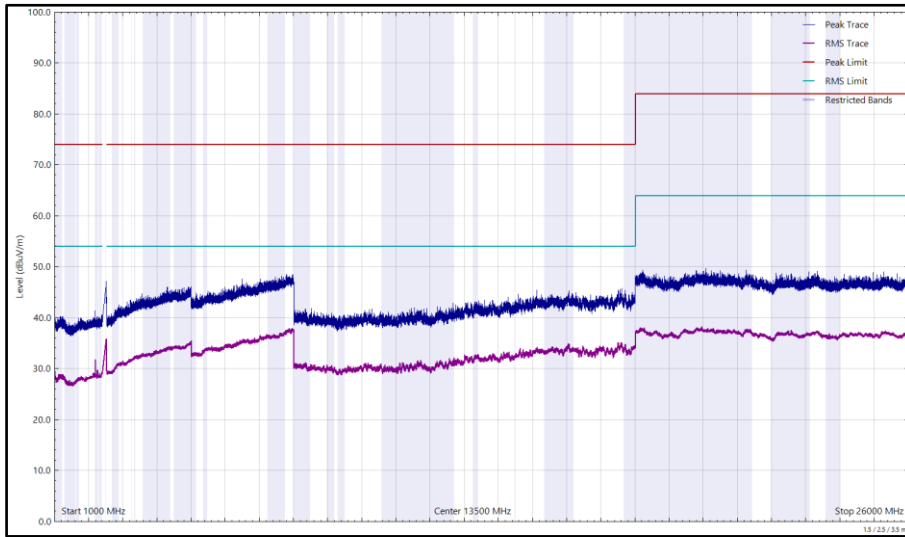

Figure 113 - 2472 MHz (CH13), 802.11g, Core 0, 1 GHz to 26 GHz, Horizontal

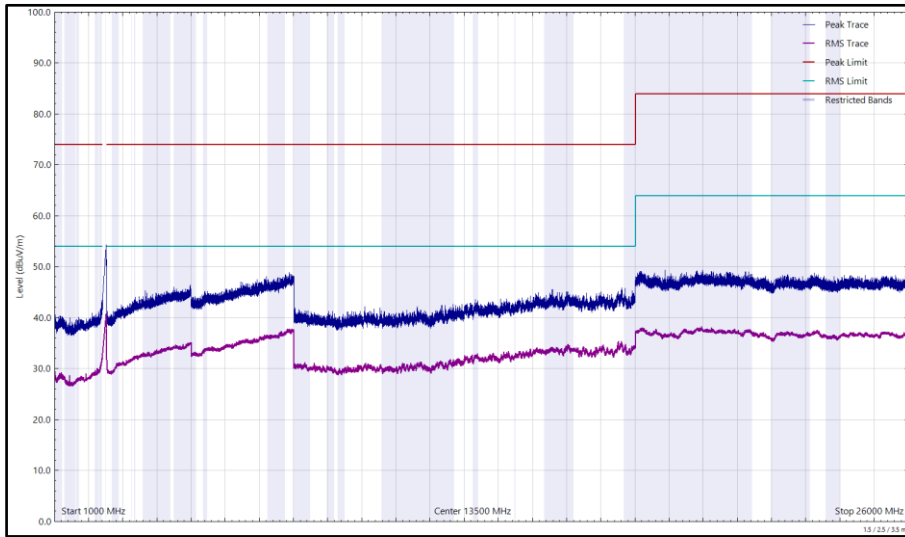

Figure 114 - 2472 MHz (CH13), 802.11g, Core 0, 1 GHz to 26 GHz, Vertical



Frequency (MHz)	Level (dBuV/m)	Limit (dBuV/m)	Margin (dB)	Detector	Angle (°)	Height (cm)	Polarisation
*							

Table 67 - 2412 MHz (CH1), 802.11g, Core 1, 1 GHz to 26 GHz

*No emissions found within 10 dB of the limit.

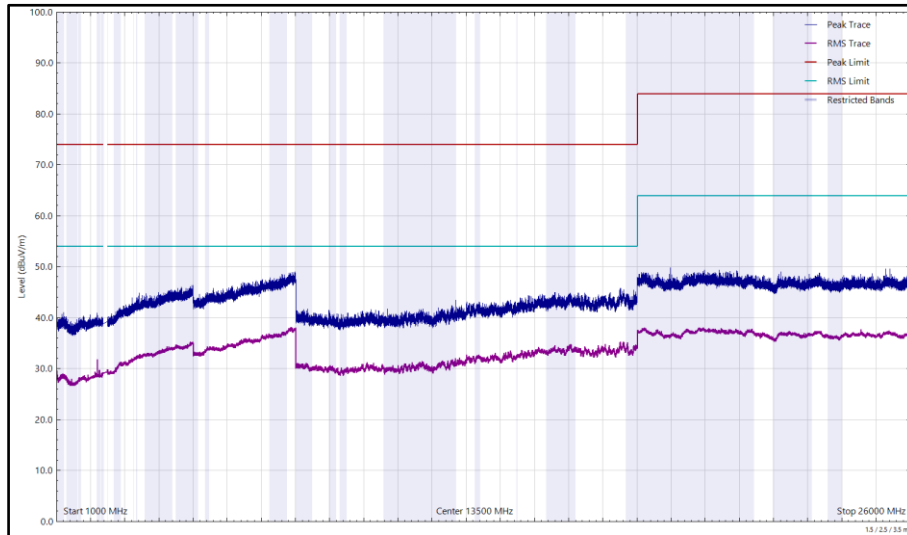

Figure 115 - 2412 MHz (CH1), 802.11g, Core 1, 1 GHz to 26 GHz, Horizontal

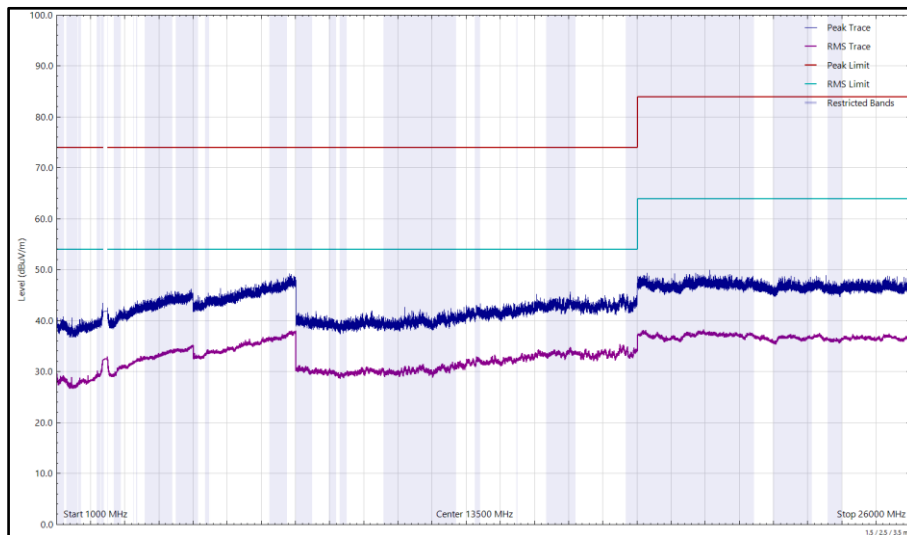

Figure 116 - 2412 MHz (CH1), 802.11g, Core 1, 1 GHz to 26 GHz, Vertical



Frequency (MHz)	Level (dBuV/m)	Limit (dBuV/m)	Margin (dB)	Detector	Angle (°)	Height (cm)	Polarisation
*							

Table 68 - 2442 MHz (CH7), 802.11g, Core 1, 30 MHz to 26 GHz

*No emissions found within 10 dB of the limit.

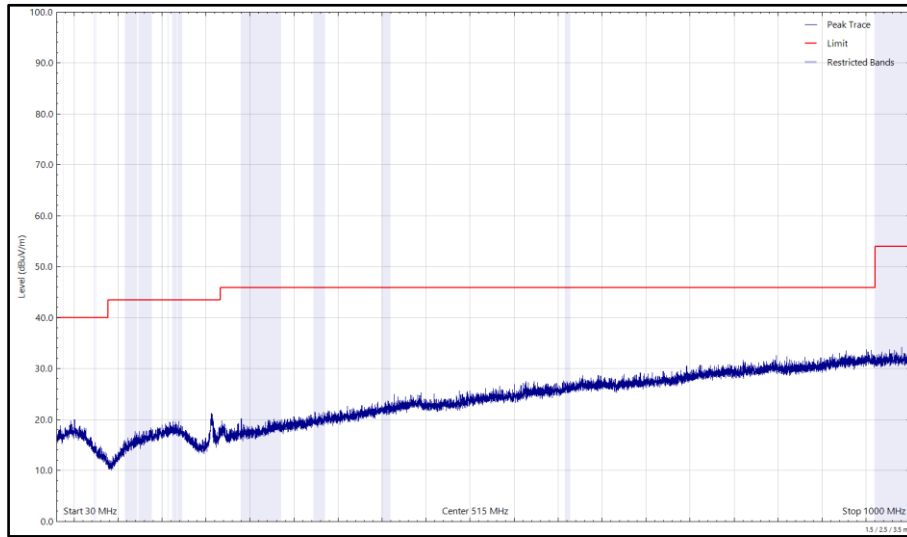

Figure 117 - 2442 MHz (CH7), 802.11g, Core 1, 30 MHz to 1 GHz, Horizontal (Peak)

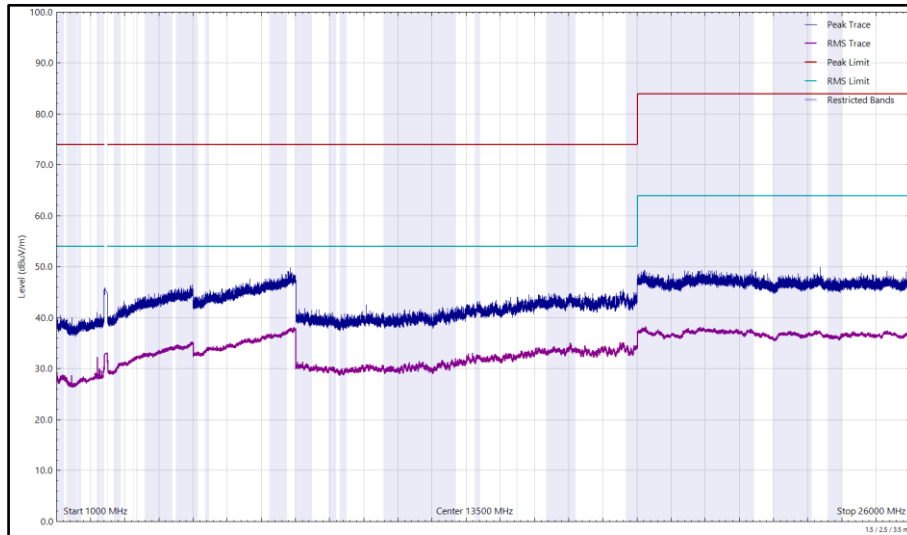

Figure 118 - 2442 MHz (CH7), 802.11g, Core 1, 1 GHz to 26 GHz, Horizontal

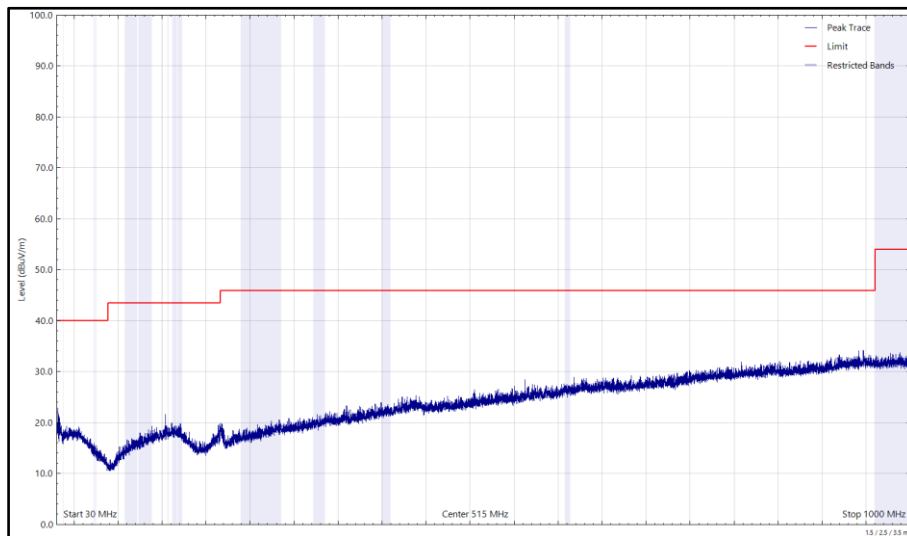

Figure 119 - 2442 MHz (CH7), 802.11g, Core 1, 30 MHz to 1 GHz, Vertical (Peak)

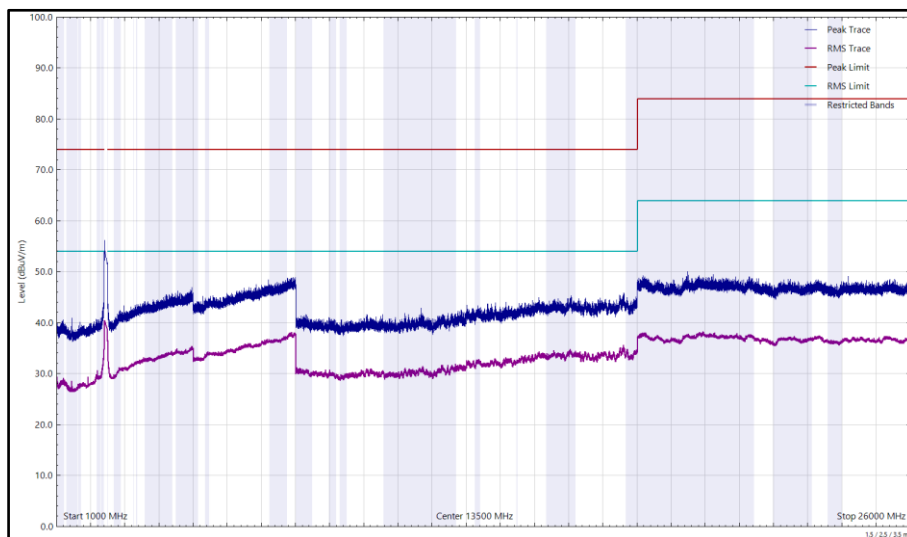

Figure 120 - 2442 MHz (CH7), 802.11g, Core 1, 1 GHz to 26 GHz, Vertical



Frequency (MHz)	Level (dBuV/m)	Limit (dBuV/m)	Margin (dB)	Detector	Angle (°)	Height (cm)	Polarisation
*							

Table 69 - 2472 MHz (CH13), 802.11g, Core 1, 1 GHz to 26 GHz

*No emissions found within 10 dB of the limit.

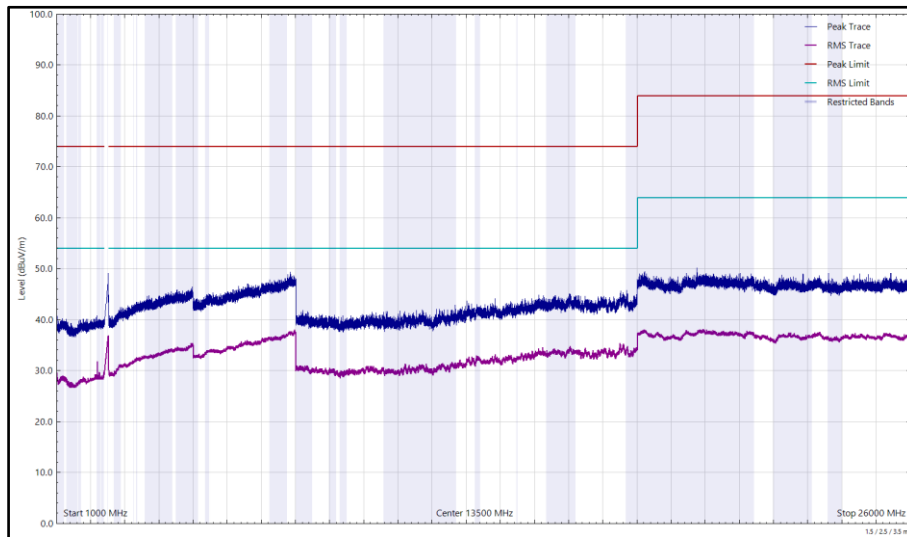

Figure 121 - 2472 MHz (CH13), 802.11g, Core 1, 1 GHz to 26 GHz, Horizontal

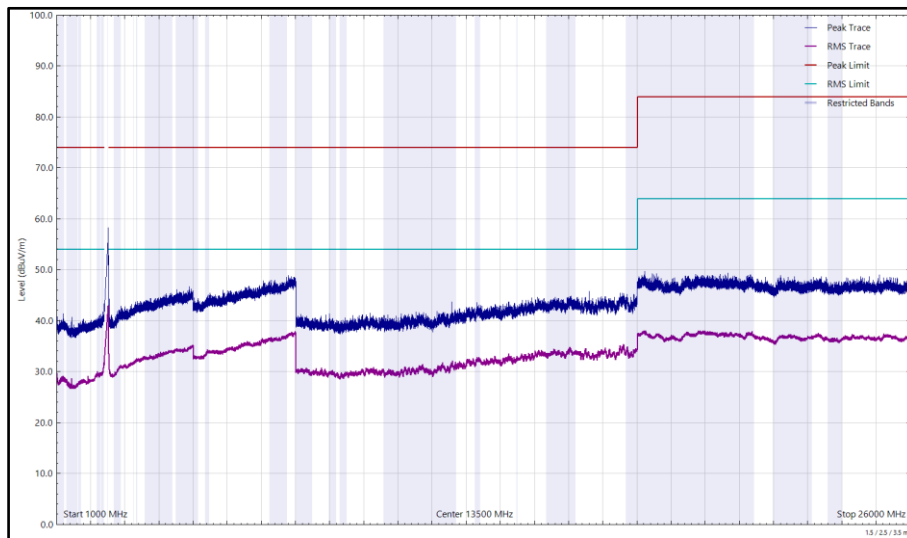

Figure 122 - 2472 MHz (CH13), 802.11g, Core 1, 1 GHz to 26 GHz, Vertical



Frequency (MHz)	Level (dBuV/m)	Limit (dBuV/m)	Margin (dB)	Detector	Angle (°)	Height (cm)	Polarisation
*							

Table 70 - 2412 MHz (CH1), HT20, CDD, Core 0 + Core 1, 1 GHz to 26 GHz

*No emissions found within 10 dB of the limit.

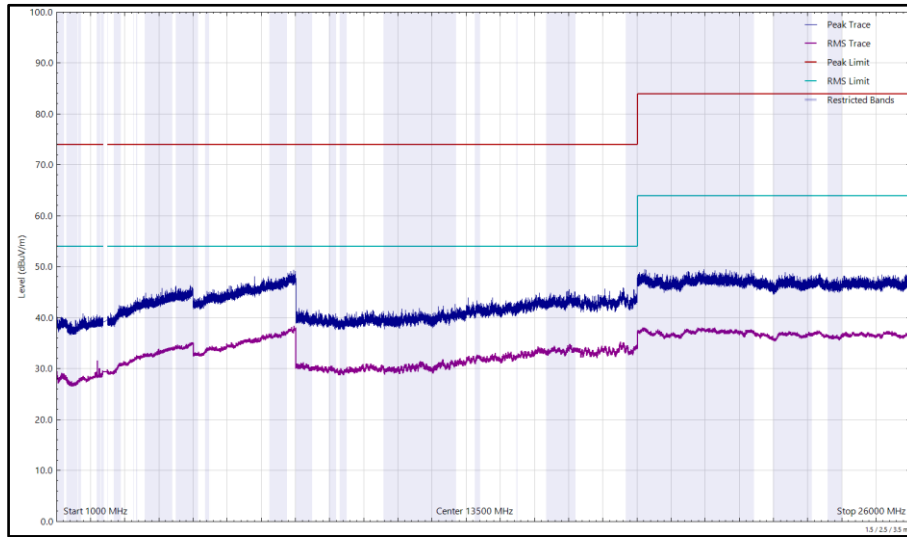

Figure 123 - 2412 MHz (CH1), HT20, CDD, Core 0 + Core 1, 1 GHz to 26 GHz, Horizontal

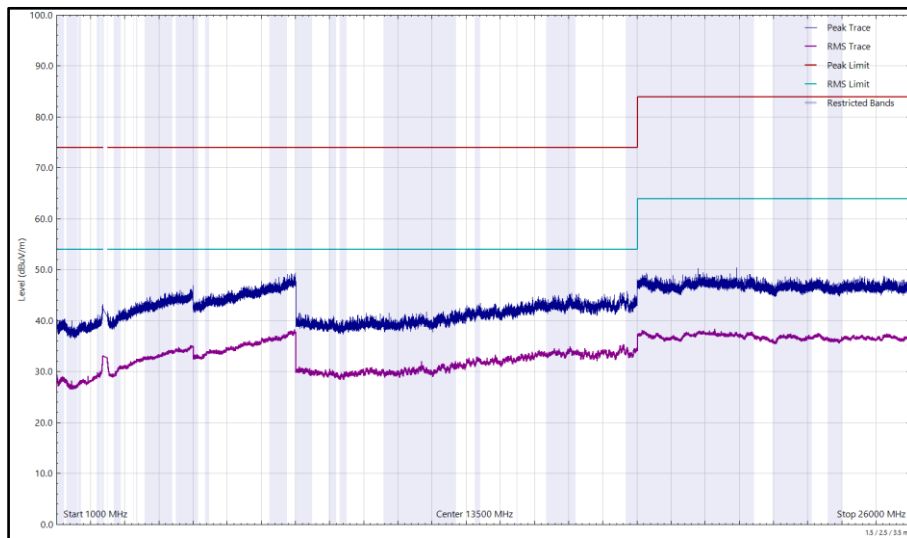

Figure 124 - 2412 MHz (CH1), HT20, CDD, Core 0 + Core 1, 1 GHz to 26 GHz, Vertical



Frequency (MHz)	Level (dBuV/m)	Limit (dBuV/m)	Margin (dB)	Detector	Angle (°)	Height (cm)	Polarisation
*							

Table 71 - 2442 MHz (CH7), HT20, CDD, Core 0 + Core 1, 30 MHz to 26 GHz

*No emissions found within 10 dB of the limit.

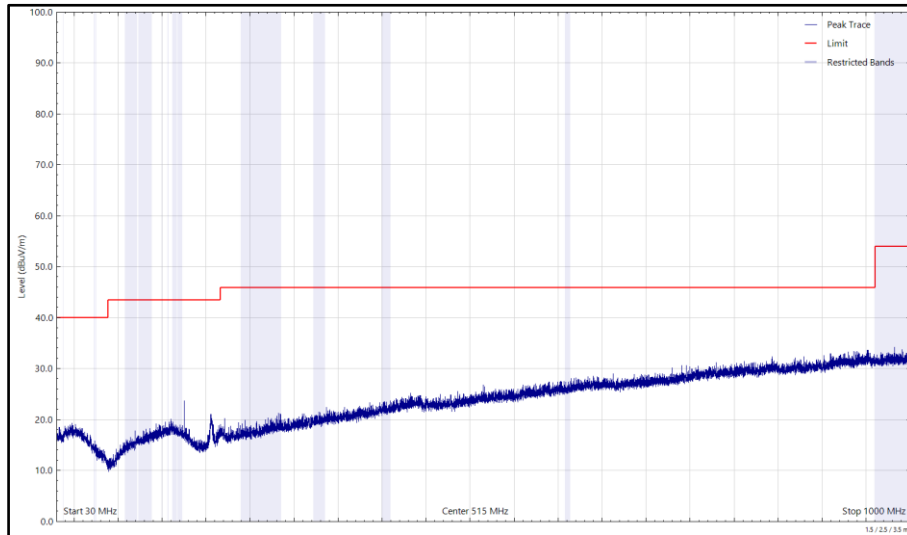

Figure 125 - 2442 MHz (CH7), HT20, CDD, Core 0 + Core 1, 30 MHz to 1 GHz, Horizontal (Peak)

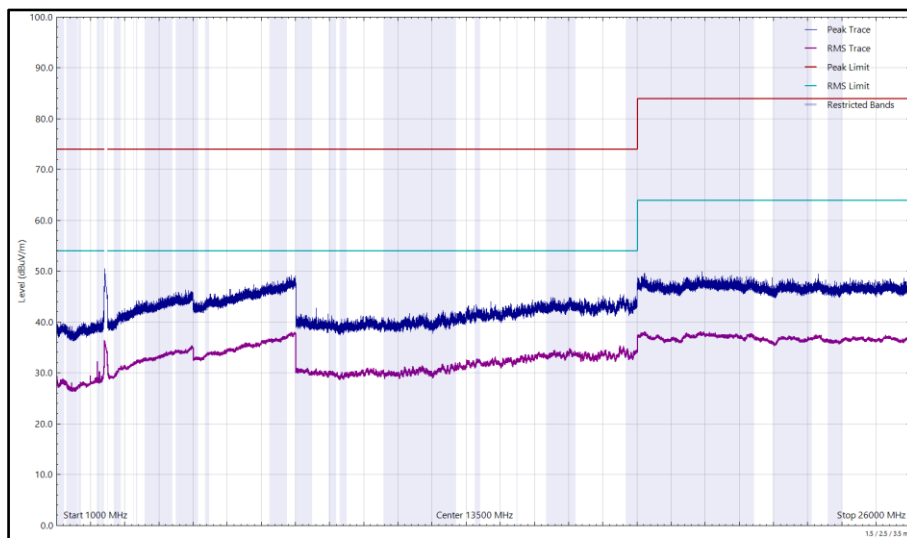

Figure 126 - 2442 MHz (CH7), HT20, CDD, Core 0 + Core 1, 1 GHz to 26 GHz, Horizontal

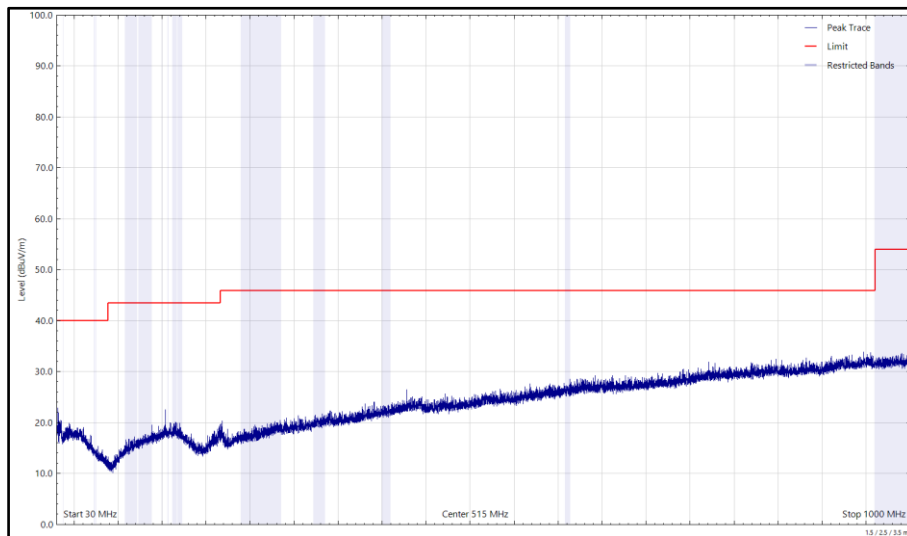

Figure 127 - 2442 MHz (CH7), HT20, CDD, Core 0 + Core 1, 30 MHz to 1 GHz, Vertical (Peak)

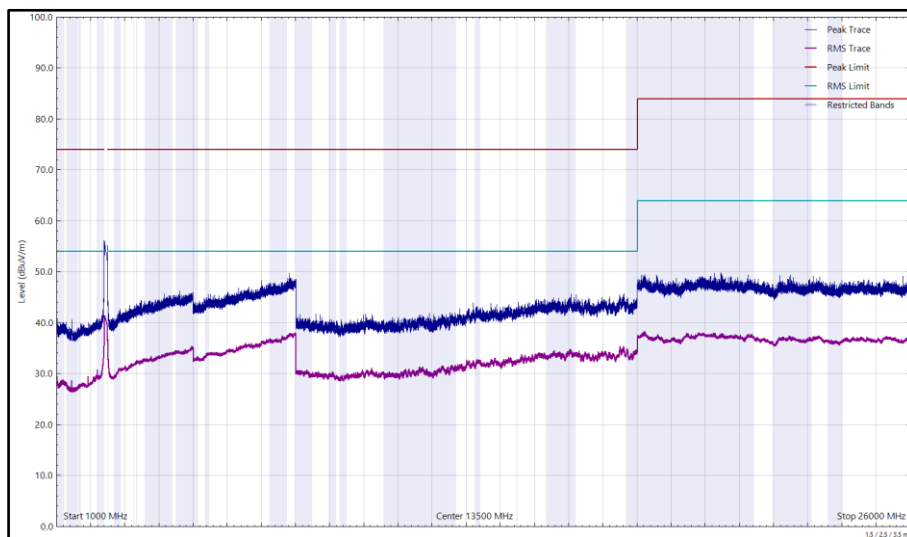

Figure 128 - 2442 MHz (CH7), HT20, CDD, Core 0 + Core 1, 1 GHz to 26 GHz, Vertical



Frequency (MHz)	Level (dBuV/m)	Limit (dBuV/m)	Margin (dB)	Detector	Angle (°)	Height (cm)	Polarisation
*							

Table 72 - 2472 MHz (CH13), HT20, CDD, Core 0 + Core 1, 1 GHz to 26 GHz

*No emissions found within 10 dB of the limit.

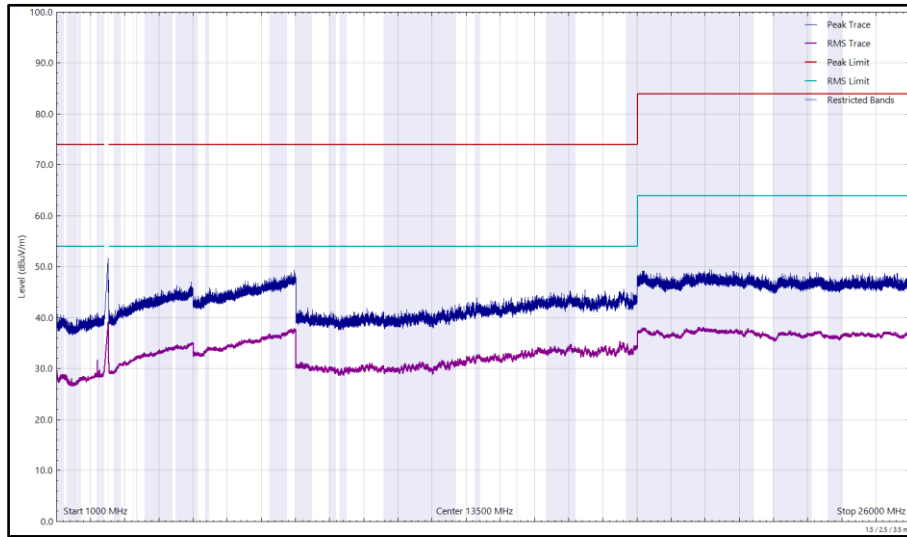

Figure 129 - 2472 MHz (CH13), HT20, CDD, Core 0 + Core 1, 1 GHz to 26 GHz, Horizontal

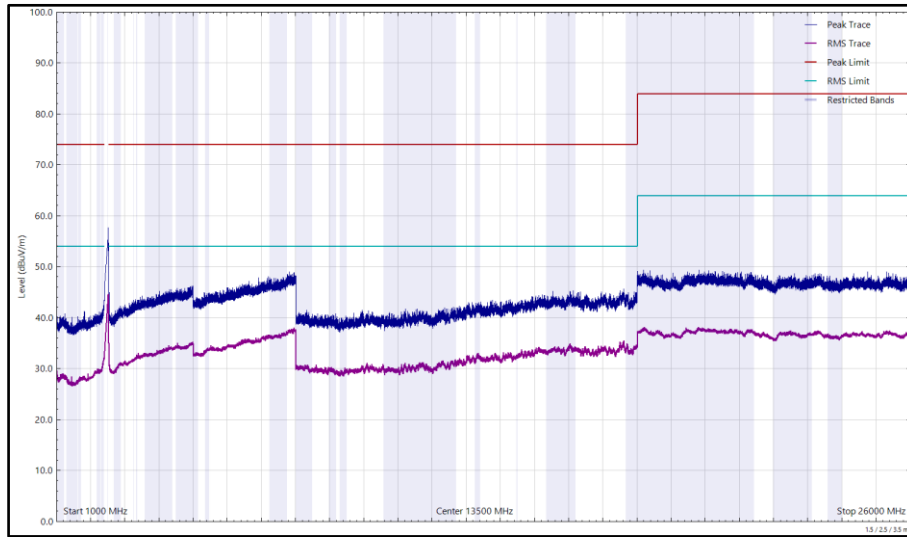

Figure 130 - 2472 MHz (CH13), HT20, CDD, Core 0 + Core 1, 1 GHz to 26 GHz, Vertical



Frequency (MHz)	Level (dBuV/m)	Limit (dBuV/m)	Margin (dB)	Detector	Angle (°)	Height (cm)	Polarisation
*							

Table 73 - 2412 MHz (CH1), HE20, RU26-0, CDD, Core 0 + Core 1, 1 GHz to 26 GHz

*No emissions found within 10 dB of the limit.

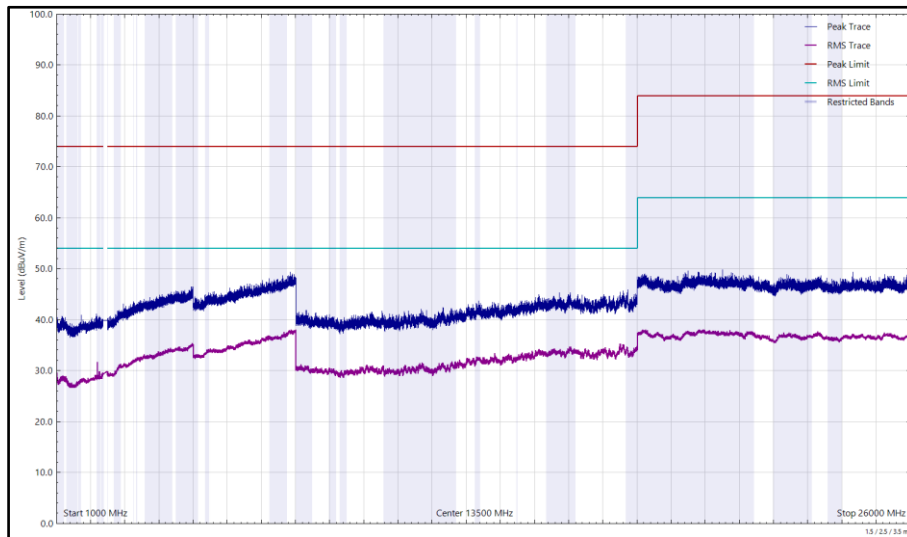

Figure 131 - 2412 MHz (CH1), HE20, RU26-0, CDD, Core 0 + Core 1, 1 GHz to 26 GHz, Horizontal

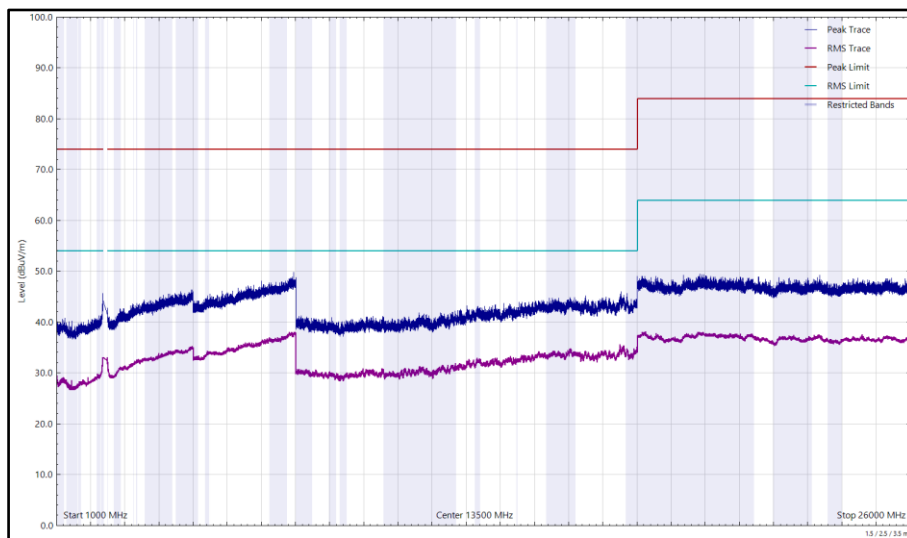

Figure 132 - 2412 MHz (CH1), HE20, RU26-0, CDD, Core 0 + Core 1, 1 GHz to 26 GHz, Vertical



Frequency (MHz)	Level (dBuV/m)	Limit (dBuV/m)	Margin (dB)	Detector	Angle (°)	Height (cm)	Polarisation
*							

Table 74 - 2442 MHz (CH7), HE20, RU26-0, CDD, Core 0 + Core 1, 30 MHz to 26 GHz

*No emissions found within 10 dB of the limit.

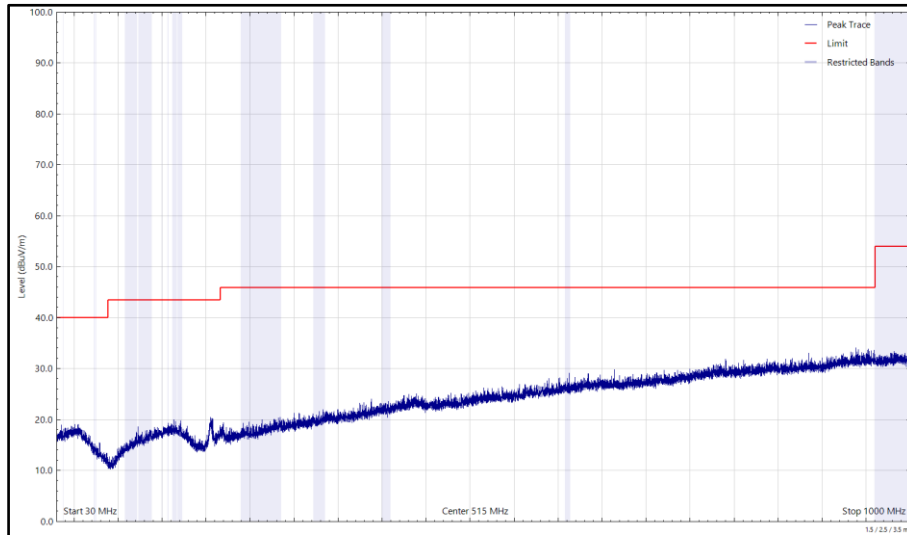

Figure 133 - 2442 MHz (CH7), HE20, RU26-0, CDD, Core 0 + Core 1, 30 MHz to 1 GHz, Horizontal (Peak)

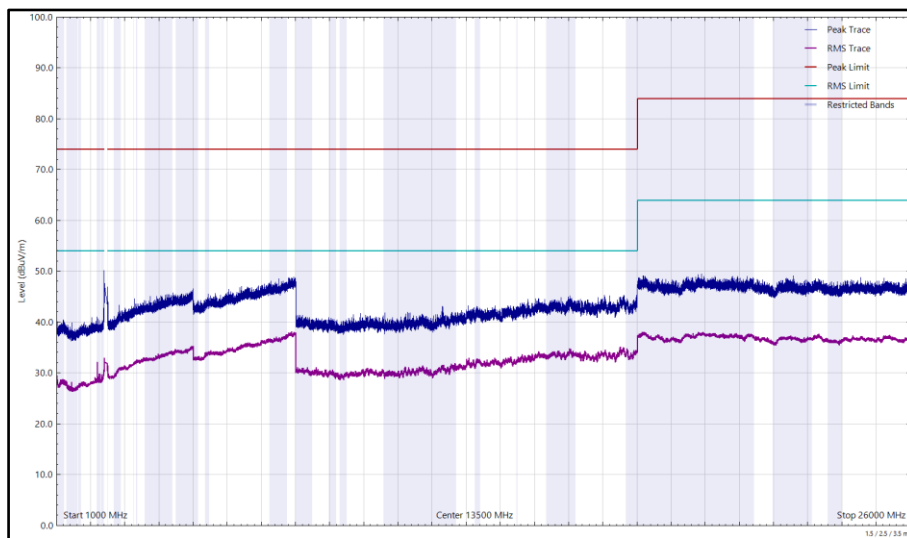

Figure 134 - 2442 MHz (CH7), HE20, RU26-0, CDD, Core 0 + Core 1, 1 GHz to 26 GHz, Horizontal

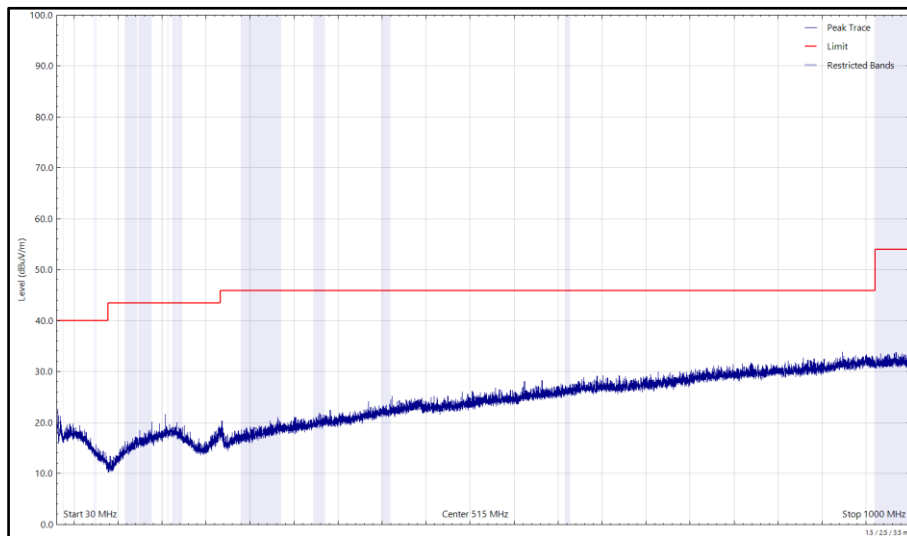

Figure 135 - 2442 MHz (CH7), HE20, RU26-0, CDD, Core 0 + Core 1, 30 MHz to 1 GHz, Vertical (Peak)

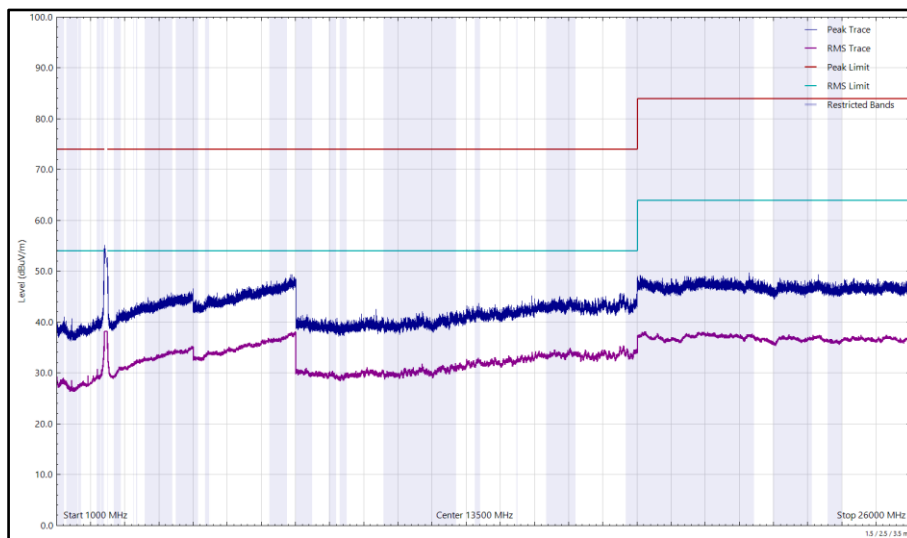

Figure 136 - 2442 MHz (CH7), HE20, RU26-0, CDD, Core 0 + Core 1, 1 GHz to 26 GHz, Vertical



Frequency (MHz)	Level (dBuV/m)	Limit (dBuV/m)	Margin (dB)	Detector	Angle (°)	Height (cm)	Polarisation
*							

Table 75 - 2472 MHz (CH13), HE20, RU26-0, CDD, Core 0 + Core 1, 1 GHz to 26 GHz

*No emissions found within 10 dB of the limit.

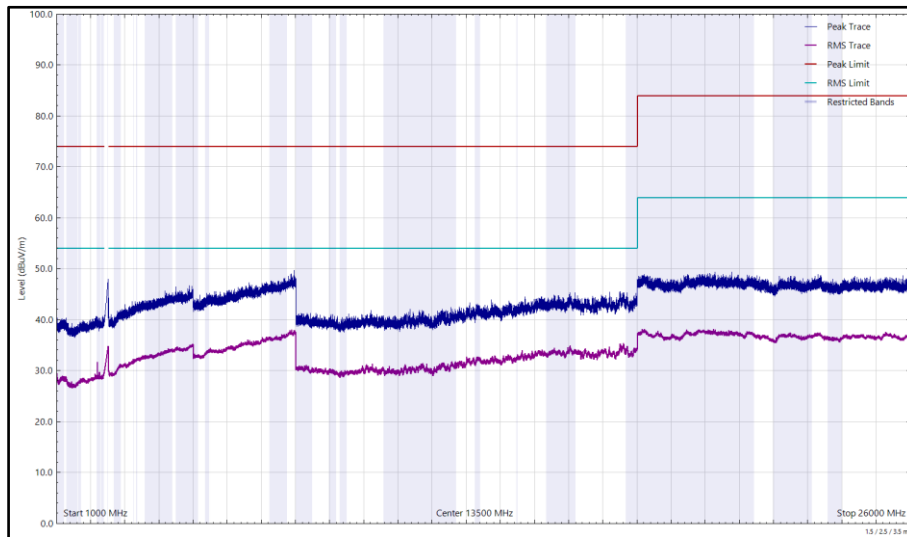

Figure 137 - 2472 MHz (CH13), HE20, RU26-0, CDD, Core 0 + Core 1, 1 GHz to 26 GHz, Horizontal

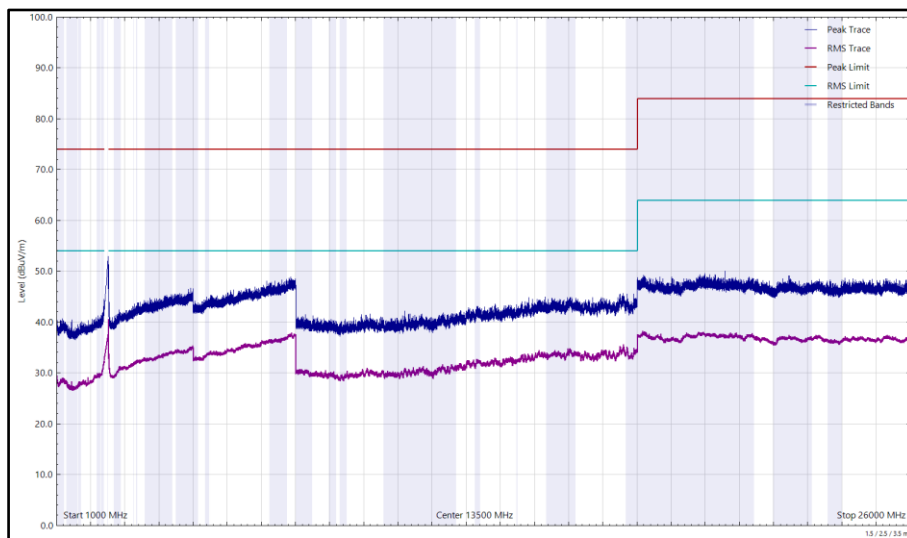

Figure 138 - 2472 MHz (CH13), HE20, RU26-0, CDD, Core 0 + Core 1, 1 GHz to 26 GHz, Vertical



FCC 47 CFR Part 15, Limit Clause 15.247 (d)

In any 100 kHz bandwidth outside the frequency band in which the spread spectrum or digitally modulated intentional radiator is operating, the radio frequency power that is produced by the intentional radiator shall be at least 20 dB below that in the 100 kHz bandwidth within the band that contains the highest level of the desired power, based on either an RF conducted or a radiated measurement, provided the transmitter demonstrates compliance with the peak conducted power limits. If the transmitter complies with the conducted power limits based on the use of RMS averaging over a time interval, as permitted under paragraph (b)(3) of this section, the attenuation required under this paragraph shall be 30 dB instead of 20 dB.

Attenuation below the general limits specified in § 15.209(a) is not required. In addition, radiated emissions which fall in the restricted bands, as defined in § 15.205(a), must also comply with the radiated emission limits specified in 15.209(a)

ISED RSS-247, Limit Clause 5.5

In any 100 kHz bandwidth outside the frequency band in which the spread spectrum or digitally modulated device is operating, the RF power that is produced shall be at least 20 dB below that in the 100 kHz bandwidth within the band that contains the highest level of the desired power, based on either an RF conducted or a radiated measurement, provided that the transmitter demonstrates compliance with the peak conducted power limits. If the transmitter complies with the conducted power limits based on the use of root-mean-square averaging over a time interval, as permitted under Section 5.4(4), the attenuation required shall be 30 dB instead of 20 dB. Attenuation below the general field strength limits specified in RSS-Gen is not required.

In addition, radiated emissions which fall in the restricted bands, as defined in RSS-GEN, clause 8.10, must also comply with the radiated emission limits specified in RSS-GEN clause 8.9.



2.5.8 Test Location and Test Equipment Used

This test was carried out in RF Chamber 15.

Instrument	Manufacturer	Type No.	TE No.	Calibration Period (months)	Calibration Expiry Date
Emissions Software	TUV SUD	EmX V3.1.10	5125	-	Software
EMI Test Receiver	Rohde & Schwarz	ESW44	5911	12	24-Apr-2023
Cable (K Type 2m)	Junkosha	MWX241-02000KMSKMS/B	5937	12	14-May-2023
DRG Horn Antenna (7.5-18GHz)	Schwarzbeck	HWRD750	5939	12	29-May-2023
TRILOG Super Broadband Test Antenna	Schwarzbeck	VULB 9168	5944	24	03-Feb-2024
1500W (300V 12A) AC Power Supply	iTech	IT7324	5956	-	O/P Mon
5m Semi-Anechoic Chamber (Dual-Axis)	Albatross Projects	RF Chamber 15	5963	36	28-Apr-2025
Compact Antenna Mast	Maturo Gmbh	CAM4.0-P	5964	-	TU
Mast & Turntable Controller	Maturo Gmbh	FCU3.0	5966	-	TU
Tilt Antenna Mast	Maturo Gmbh	BAM4.5-P	5967	-	TU
Turntable	Maturo Gmbh	TT1.5SI	5968	-	TU
Cable (SMA to SMA 1m)	Junkosha	MWX221-01000AMSAMS/A	5996	12	06-Jun-2023
Cable (N to N 1m)	Junkosha	MWX221-01000NMSNMS/B	5999	12	05-Jun-2023
Cable (N to N 7m)	Junkosha	MWX221-07000NMSNMS/B	6005	12	05-Jun-2023
Cable (N to N 8m)	Junkosha	MWX221-08000NMSNMS/A	6006	12	05-Jun-2023
Cable (SMA to SMA 1m)	Junkosha	MWX221-01000AMSAMS/A	6007	12	06-Jun-2023
Cable (SMA to SMA 6.5m)	Junkosha	MWX221-06500AMSAMS/B	6014	12	07-Jun-2023
Horn Antenna (1-10 GHz)	Schwarzbeck	BBHA9120B	6140	12	21-Jun-2023
Digital Multimeter	Fluke	115	6147	12	16-Jun-2023
Humidity & Temperature meter	R.S Components	1364	6150	12	17-Jun-2023
Double Ridge Active Horn Antenna (18-40 GHz)	Com-Power	AHA-840	6187	24	02-Jun-2024
SAC Switch Unit	TUV SUD	TUV_SSU_001	6191	12	12-Dec-2023
8 GHz Highpass Filter	Wainwright	WHKX 7150 8000 18000 50SS	6195	12	15-Jul-2023
Pre Amp 8 - 18 GHz	Wright Technologies	APS06 0061	6198	12	19-Jul-2023
Attenuator 4dB	Pasternack	PE7074-4	6203	24	16-Jul-2024
Cable (SMA to SMA 20cm)	TUV SUD	MH-FH 8-18	6214	12	25-Jul-2023

Table 76

TU - Traceability Unscheduled
 O/P Mon - Output Monitored using calibrated equipment



2.6 Power Spectral Density

2.6.1 Specification Reference

FCC 47 CFR Part 15C, Clause 15.247 (e)
ISED RSS-247, Clause 5.2
ISED RSS-GEN, Clause 6.12

2.6.2 Equipment Under Test and Modification State

A2901, S/N: PXC62W93WY - Modification State 0

2.6.3 Date of Test

01-April-2023

2.6.4 Test Method

This test was performed in accordance with ANSI C63.10, clause 11.10.5.

Where the EUT duty cycle was < 98 % and repeatable within 2 %, the spectrum analyser was set to trace (power) averaging and a duty cycle correction was added as calculated in the result tables below (Method AVGPSD-2).

MIMO output port summing was performed in accordance with KDB 662911 D01 E)2)b).

2.6.5 Environmental Conditions

Ambient Temperature	22.3 °C
Relative Humidity	41.1 %



2.6.6 Test Results

2.4 GHz WLAN

Test Configuration			
Frequency Range:	2400-2483.5 MHz	Band:	2.4 GHz
Limit Clause(s):	15.247 (e) RSS-247 5.2 b)	Test Method(s):	C63.10 11.10.5
Additional Reference(s):	-		
Note(s):	DCCF was added to the spectrum analyser reference level offset.		

DUT Configuration			
Mode:	802.11b	Duty Cycle (%):	99.4
Data Rate:	1 Mbps	DCCF (dB):	-
Antenna Configuration:	SISO	Peak Antenna Gain (dBi):	-
Active Port(s):	A (Core 0)	Active Chain(s):	0

Test Frequency (MHz)	RBW (kHz)	PSD (dBm/RBW)					Limit (dBm/3 kHz)	Margin (dB)
		A	B	C	D	Σ		
2412	100.0	2.13	-	-	-	-	8.00	-5.87
2442	100.0	2.04	-	-	-	-	8.00	-5.96
2472	100.0	-0.02	-	-	-	-	8.00	-8.02

Table 77 - Maximum Power Spectral Density Results

Test Configuration			
Frequency Range:	2400-2483.5 MHz	Band:	2.4 GHz
Limit Clause(s):	15.247 (e) RSS-247 5.2 b)	Test Method(s):	C63.10 11.10.5
Additional Reference(s):	-		
Note(s):	DCCF was added to the spectrum analyser reference level offset.		

DUT Configuration			
Mode:	802.11g	Duty Cycle (%):	97.6
Data Rate:	12 Mbps	DCCF (dB):	0.11
Antenna Configuration:	SISO	Peak Antenna Gain (dBi):	-
Active Port(s):	A (Core 0)	Active Chain(s):	0

Test Frequency (MHz)	RBW (kHz)	PSD (dBm/RBW)					Limit (dBm/3 kHz)	Margin (dB)
		A	B	C	D	Σ		
2412	100.0	3.41	-	-	-	-	8.00	-4.59
2442	100.0	4.41	-	-	-	-	8.00	-3.59
2472	100.0	-9.32	-	-	-	-	8.00	-17.32

Table 78 - Maximum Power Spectral Density Results



Test Configuration			
Frequency Range:	2400-2483.5 MHz	Band:	2.4 GHz
Limit Clause(s):	15.247 (e) RSS-247 5.2 b)	Test Method(s):	C63.10 11.10.5
Additional Reference(s):	-		
Note(s):	DCCF was added to the spectrum analyser reference level offset.		

DUT Configuration			
Mode:	802.11n HT20	Duty Cycle (%):	96.5
Modulation Coding Scheme:	MCS2	DCCF (dB):	0.16
Antenna Configuration:	SISO	Peak Antenna Gain (dBi):	-
Active Port(s):	A (Core 0)	Active Chain(s):	0

Test Frequency (MHz)	RBW (kHz)	PSD (dBm/RBW)					Limit (dBm/3 kHz)	Margin (dB)
		A	B	C	D	Σ		
2412	100.0	1.45	-	-	-	-	8.00	-6.55
2442	100.0	4.37	-	-	-	-	8.00	-3.63
2472	100.0	-9.75	-	-	-	-	8.00	-17.75

Table 79 - Maximum Power Spectral Density Results

Test Configuration			
Frequency Range:	2400-2483.5 MHz	Band:	2.4 GHz
Limit Clause(s):	15.247 (e) RSS-247 5.2 b)	Test Method(s):	C63.10 11.10.5
Additional Reference(s):	-		
Note(s):	DCCF was added to the spectrum analyser reference level offset.		

DUT Configuration			
Mode:	802.11ax HE20 SU	Duty Cycle (%):	95.8
Modulation Coding Scheme:	MCS2x1	DCCF (dB):	0.19
Antenna Configuration:	SISO	Peak Antenna Gain (dBi):	-
Active Port(s):	A (Core 0)	Active Chain(s):	0

Test Frequency (MHz)	RBW (kHz)	PSD (dBm/RBW)					Limit (dBm/3 kHz)	Margin (dB)
		A	B	C	D	Σ		
2412	100.0	-1.01	-	-	-	-	8.00	-9.01
2442	100.0	2.60	-	-	-	-	8.00	-5.40
2472	100.0	-12.06	-	-	-	-	8.00	-20.06

Table 80 - Maximum Power Spectral Density Results



Test Configuration			
Frequency Range:	2400-2483.5 MHz	Band:	2.4 GHz
Limit Clause(s):	15.247 (e) RSS-247 5.2 b)	Test Method(s):	C63.10 11.10.5
Additional Reference(s):	-		
Note(s):	DCCF was added to the spectrum analyser reference level offset.		

DUT Configuration			
Mode:	802.11ax HE20 RU26	Duty Cycle (%):	96.5
Modulation Coding Scheme:	MCS2x1	DCCF (dB):	0.16
Antenna Configuration:	SISO	Peak Antenna Gain (dBi):	-
Active Port(s):	A (Core 0)	Active Chain(s):	0

Test Frequency (MHz)	RBW (kHz)	PSD (dBm/RBW)					Limit (dBm/3 kHz)	Margin (dB)
		A	B	C	D	Σ		
2412	100.0	2.28	-	-	-	-	8.00	-5.73
2442	100.0	1.98	-	-	-	-	8.00	-6.02
2472	100.0	-11.43	-	-	-	-	8.00	-19.43

Table 81 - Maximum Power Spectral Density Results

Test Configuration			
Frequency Range:	2400-2483.5 MHz	Band:	2.4 GHz
Limit Clause(s):	15.247 (e) RSS-247 5.2 b)	Test Method(s):	C63.10 11.10.5
Additional Reference(s):	-		
Note(s):	DCCF was added to the spectrum analyser reference level offset.		

DUT Configuration			
Mode:	802.11ax HE20 RU52	Duty Cycle (%):	96.4
Modulation Coding Scheme:	MCS2x1	DCCF (dB):	0.16
Antenna Configuration:	SISO	Peak Antenna Gain (dBi):	-
Active Port(s):	A (Core 0)	Active Chain(s):	0

Test Frequency (MHz)	RBW (kHz)	PSD (dBm/RBW)					Limit (dBm/3 kHz)	Margin (dB)
		A	B	C	D	Σ		
2412	100.0	2.35	-	-	-	-	8.00	-5.66
2442	100.0	2.04	-	-	-	-	8.00	-5.96
2472	100.0	-11.35	-	-	-	-	8.00	-19.35

Table 82 - Maximum Power Spectral Density Results



Test Configuration			
Frequency Range:	2400-2483.5 MHz	Band:	2.4 GHz
Limit Clause(s):	15.247 (e) RSS-247 5.2 b)	Test Method(s):	C63.10 11.10.5
Additional Reference(s):	-		
Note(s):	DCCF was added to the spectrum analyser reference level offset.		

DUT Configuration			
Mode:	802.11ax HE20 RU106	Duty Cycle (%):	97.8
Modulation Coding Scheme:	MCS2x1	DCCF (dB):	0.10
Antenna Configuration:	SISO	Peak Antenna Gain (dBi):	-
Active Port(s):	A (Core 0)	Active Chain(s):	0

Test Frequency (MHz)	RBW (kHz)	PSD (dBm/RBW)					Limit (dBm/3 kHz)	Margin (dB)
		A	B	C	D	Σ		
2412	100.0	1.31	-	-	-	-	8.00	-6.69
2442	100.0	2.17	-	-	-	-	8.00	-5.83
2472	100.0	-13.42	-	-	-	-	8.00	-21.42

Table 83 - Maximum Power Spectral Density Results

Test Configuration			
Frequency Range:	2400-2483.5 MHz	Band:	2.4 GHz
Limit Clause(s):	15.247 (e) RSS-247 5.2 b)	Test Method(s):	C63.10 11.10.5
Additional Reference(s):	662911 D01 v02r01 E)2)b)		
Note(s):	DCCF was added to the spectrum analyser reference level offset.		

DUT Configuration			
Mode:	802.11n HT20	Duty Cycle (%):	96.5
Modulation Coding Scheme:	MCS2	DCCF (dB):	0.16
Antenna Configuration:	MIMO CDD	Peak Antenna Gain (dBi):	-
Active Port(s):	A+B (Core 0 + Core 1)	Active Chain(s):	0+1

Test Frequency (MHz)	RBW (kHz)	PSD (dBm/RBW)					Limit (dBm/3 kHz)	Margin (dB)
		A	B	C	D	Σ		
2412	100.0	-0.43	0.21	-	-	2.91	8.00	-5.09
2442	51.0	1.48	1.55	-	-	4.52	8.00	-3.48
2472	100.0	-10.77	-10.80	-	-	-7.77	8.00	-15.77

Table 84 - Maximum Power Spectral Density Results



Test Configuration			
Frequency Range:	2400-2483.5 MHz	Band:	2.4 GHz
Limit Clause(s):	15.247 (e) RSS-247 5.2 b)	Test Method(s):	C63.10 11.10.5
Additional Reference(s):	662911 D01 v02r01 E)2)b)		
Note(s):	DCCF was added to the spectrum analyser reference level offset.		

DUT Configuration			
Mode:	802.11ax HE20 SU	Duty Cycle (%):	95.7
Modulation Coding Scheme:	MCS2x1	DCCF (dB):	0.19
Antenna Configuration:	MIMO CDD	Peak Antenna Gain (dBi):	-
Active Port(s):	A+B (Core 0 + Core 1)	Active Chain(s):	0+1

Test Frequency (MHz)	RBW (kHz)	PSD (dBm/RBW)					Limit (dBm/3 kHz)	Margin (dB)
		A	B	C	D	Σ		
2412	100.0	-1.97	-1.85	-	-	1.10	8.00	-6.90
2442	51.0	-0.42	-0.59	-	-	2.51	8.00	-5.49
2472	100.0	-13.49	-13.09	-	-	-10.28	8.00	-18.28

Table 85 - Maximum Power Spectral Density Results

aTest Configuration			
Frequency Range:	2400-2483.5 MHz	Band:	2.4 GHz
Limit Clause(s):	15.247 (e) RSS-247 5.2 b)	Test Method(s):	C63.10 11.10.5
Additional Reference(s):	662911 D01 v02r01 E)2)b)		
Note(s):	DCCF was added to the spectrum analyser reference level offset.		

DUT Configuration			
Mode:	802.11ax HE20 RU26	Duty Cycle (%):	96.5
Modulation Coding Scheme:	MCS2x1	DCCF (dB):	0.15
Antenna Configuration:	MIMO CDD	Peak Antenna Gain (dBi):	-
Active Port(s):	A+B (Core 0 + Core 1)	Active Chain(s):	0+1

Test Frequency (MHz)	RBW (kHz)	PSD (dBm/RBW)					Limit (dBm/3 kHz)	Margin (dB)
		A	B	C	D	Σ		
2412	100.0	1.93	2.15	-	-	5.05	8.00	-2.95
2442	100.0	1.62	2.08	-	-	4.86	8.00	-3.14
2472	100.0	-12.72	-12.86	-	-	-9.78	8.00	-17.78

Table 86 - Maximum Power Spectral Density Results



Test Configuration			
Frequency Range:	2400-2483.5 MHz	Band:	2.4 GHz
Limit Clause(s):	15.247 (e) RSS-247 5.2 b)	Test Method(s):	C63.10 11.10.5
Additional Reference(s):	662911 D01 v02r01 E)2)b)		
Note(s):	DCCF was added to the spectrum analyser reference level offset.		

DUT Configuration			
Mode:	802.11ax HE20 RU52	Duty Cycle (%):	96.4
Modulation Coding Scheme:	MCS2x1	DCCF (dB):	0.16
Antenna Configuration:	MIMO CDD	Peak Antenna Gain (dBi):	-
Active Port(s):	A+B (Core 0 + Core 1)	Active Chain(s):	0+1

Test Frequency (MHz)	RBW (kHz)	PSD (dBm/RBW)					Limit (dBm/3 kHz)	Margin (dB)
		A	B	C	D	Σ		
2412	100.0	-1.10	-0.49	-	-	2.23	8.00	-5.77
2442	100.0	1.84	2.38	-	-	5.13	8.00	-2.87
2472	100.0	-13.40	-12.90	-	-	-10.13	8.00	-18.13

Table 87 - Maximum Power Spectral Density Results

Test Configuration			
Frequency Range:	2400-2483.5 MHz	Band:	2.4 GHz
Limit Clause(s):	15.247 (e) RSS-247 5.2 b)	Test Method(s):	C63.10 11.10.5
Additional Reference(s):	662911 D01 v02r01 E)2)b)		
Note(s):	DCCF was added to the spectrum analyser reference level offset.		

DUT Configuration			
Mode:	802.11ax HE20 RU106	Duty Cycle (%):	97.8
Modulation Coding Scheme:	MCS2x1	DCCF (dB):	0.10
Antenna Configuration:	MIMO CDD	Peak Antenna Gain (dBi):	-
Active Port(s):	A+B (Core 0 + Core 1)	Active Chain(s):	0+1

Test Frequency (MHz)	RBW (kHz)	PSD (dBm/RBW)					Limit (dBm/3 kHz)	Margin (dB)
		A	B	C	D	Σ		
2412	100.0	-1.15	-1.06	-	-	1.91	8.00	-6.09
2442	100.0	1.83	1.86	-	-	4.85	8.00	-3.15
2472	100.0	-15.00	-14.79	-	-	-11.88	8.00	-19.88

Table 88 - Maximum Power Spectral Density Results



FCC 47 CFR Part 15, Limit Clause 15.247 (e)

The power spectral density conducted from the intentional radiator to the antenna shall not be greater than 8 dBm in any 3 kHz band during any time interval of continuous transmission.

ISED RSS-247, Limit Clause 5.2(b)

The transmitter power spectral density conducted from the transmitter to the antenna shall not be greater than 8 dBm in any 3 kHz band during any time interval of continuous transmission.

2.6.7 Test Location and Test Equipment Used

This test was carried out in RF Laboratory 14.

Instrument	Manufacturer	Type No.	TE No.	Calibration Period (months)	Calibration Expiry Date
Hygrometer	Rotronic	I-1000	3068	12	21-Sep-2023
Multi-GNSS Simulator (GPS)	Spirent	GSS6700	4596	12	22-Aug-2023
1500VA AC Power Supply	iTech	IT7324	5907	-	O/P Mon
MXA Signal Analyser	Keysight Technologies	N9020B	5919	24	13-Mar-2024
Signal Conditioning Unit	TUV SUD	SPECTRUM_SCU001	5932	12	10-May-2023
Digital Multimeter	Fluke	115	6145	12	17-Jun-2023

Table 89

O/P Mon - Output Monitored using calibrated equipment



3 Measurement Uncertainty

For a 95% confidence level, the measurement uncertainties for defined systems are:

Test Name	Measurement Uncertainty
Restricted Band Edges	30 MHz to 1 GHz: ± 5.2 dB 1 GHz to 40 GHz: ± 6.3 dB
Emission Bandwidth	± 545.655 kHz
Maximum Conducted Output Power	± 1.38 dB
Authorised Band Edges	30 MHz to 1 GHz: ± 5.2 dB 1 GHz to 40 GHz: ± 6.3 dB
Spurious Radiated Emissions	30 MHz to 1 GHz: ± 5.2 dB 1 GHz to 40 GHz: ± 6.3 dB
Power Spectral Density	± 1.49 dB

Table 90

Measurement Uncertainty Decision Rule – Accuracy Method

Determination of conformity with the specification limits is based on the decision rule according to IEC Guide 115:2021, Clause 4.4.3 (Procedure 2). The measurement results are directly compared with the test limit to determine conformance with the requirements of the standard.

Risk: The uncertainty of measurement about the measured result is negligible with regard to the final pass/fail decision. The measurement result can be directly compared with the test limit to determine conformance with the requirement (compare IEC Guide 115). The level of risk to falsely accept and falsely reject items is further described in ILAC-G8.