



PART 2 RF EXPOSURE EVALUATION REPORT

Applicant Name:
 Apple, Inc.
 One Apple Park Way
 Cupertino, CA, 95014

Date of Testing:
 1/11/2024 – 2/15/2024
Test Site/Location:
 Element, Morgan Hill, CA, USA
Document Serial No.:
 1C2311270066-03.BCG

FCC ID: BCGA2899

APPLICANT: APPLE INC.

DUT Type: Tablet Device
Application Type: Certification
FCC Rule Part(s): CFR §2.1093
Model: A2899
Additional Model: A2900
Device Serial Numbers: Pre-Production Samples [15W61, CN6HQ, JH1FC, 95C9F, V9YYD]

I attest to the accuracy of data. All measurements reported herein were performed by me or were made under my supervision and are correct to the best of my knowledge and belief. I assume full responsibility for the completeness of these measurements and vouch for the qualifications of all persons taking them. Test results reported herein relate only to the item(s) tested.



RJ Ortanez
 Executive Vice President

Prepared by: 008198

Reviewed by: 005856



FCC ID: BCGA2899	PART 2 RF EXPOSURE EVALUATION REPORT	Approved by: Technical Manager
Document S/N: 1C2311270066-03.BCG	DUT Type: Tablet Device	Page 1 of 66

T A B L E O F C O N T E N T S

1 DEVICE UNDER TEST 3

2 RF EXPOSURE LIMITS 6

3 TIME VARYING TRANSMISSION TEST CASES 8

4 FCC MEASUREMENT PROCEDURES (FREQ < 6 GHZ)..... 10

5 MEASUREMENT TEST SETUP (FREQ < 6 GHZ)..... 24

6 TEST CONFIGURATIONS (FREQ < 6 GHZ)..... 28

7 CONDUCTED TX CASES (FREQ < 6 GHZ)..... 32

8 SYSTEM VERIFICATION (FREQ < 6 GHZ)..... 53

9 SAR TEST RESULTS (FREQ < 6 GHZ) 55

10 EQUIPMENT LIST 62

11 MEASUREMENT UNCERTAINTIES 63

12 CONCLUSION 64

13 REFERENCES..... 65

APPENDIX A: VERIFICATION PLOTS

APPENDIX B: SAR TISSUE SPECIFICATIONS

APPENDIX C: SAR SYSTEM VALIDATION

APPENDIX D: TEST SETUP PHOTOGRAPHS

APPENDIX E: TEST SEQUENCES

APPENDIX F: TEST PROCEDURES FOR SUB6 NR + NR RADIO

APPENDIX G: CALIBRATION CERTIFICATES

FCC ID: BCGA2899	PART 2 RF EXPOSURE EVALUATION REPORT	Approved by: Technical Manager
Document S/N: 1C2311270066-03.BCG	DUT Type: Tablet Device	Page 2 of 66

1 DEVICE UNDER TEST

1.1 Device Overview

Band & Mode	Operating Modes	Tx Frequency
UMTS 850	Data	826.40 - 846.60 MHz
UMTS 1750	Data	1712.4 - 1752.6 MHz
UMTS 1900	Data	1852.4 - 1907.6 MHz
LTE Band 71	Data	665.5 - 695.5 MHz
LTE Band 12	Data	699.7 - 715.3 MHz
LTE Band 17	Data	706.5 - 713.5 MHz
LTE Band 13	Data	779.5 - 784.5 MHz
LTE Band 14	Data	790.5 - 795.5 MHz
LTE Band 26 (Cell)	Data	814.7 - 848.3 MHz
LTE Band 5 (Cell)	Data	824.7 - 848.3 MHz
LTE Band 66 (AWS)	Data	1710.7 - 1779.3 MHz
LTE Band 4 (AWS)	Data	1710.7 - 1754.3 MHz
LTE Band 25 (PCS)	Data	1850.7 - 1914.3 MHz
LTE Band 2 (PCS)	Data	1850.7 - 1909.3 MHz
LTE Band 30	Data	2307.5 - 2312.5 MHz
LTE Band 7	Data	2502.5 - 2567.5 MHz
LTE Band 41	Data	2498.5 - 2687.5 MHz
LTE Band 48	Data	3552.5 - 3697.5 MHz
NR Band n71	Data	665.5 - 695.5 MHz
NR Band n12	Data	701.5 - 713.5 MHz
NR Band n14	Data	790.5 - 795.5 MHz
NR Band n26 (Cell)	Data	816.5 - 846.5 MHz
NR Band n5 (Cell)	Data	826.5 - 846.5 MHz
NR Band n70	Data	1697.5 - 1707.5 MHz
NR Band n66 (AWS)	Data	1712.5 - 1777.5 MHz
NR Band n25 (PCS)	Data	1852.5 - 1912.5 MHz
NR Band n2 (PCS)	Data	1852.5 - 1907.5 MHz
NR Band n30	Data	2307.5 - 2312.5 MHz
NR Band n7	Data	2502.5 - 2567.5 MHz
NR Band n41	Data	2506.02 - 2679.99 MHz
NR Band n48	Data	3550 - 3700 MHz
NR Band n77 DoD	Data	3460.02 - 3540 MHz
NR Band n77	Data	3710.01 - 3969.99 MHz
2.4 GHz WIFI	Voice/Data	2412 - 2472 MHz
5 GHz WIFI	Voice/Data	U-NII-1: 5180 - 5240 MHz U-NII-2A: 5260 - 5320 MHz U-NII-2C: 5500 - 5720 MHz U-NII-3: 5745 - 5825 MHz
6 GHz WIFI	Voice/Data	U-NII-5: 5935 - 6415 MHz U-NII-6: 6435 - 6515 MHz U-NII-7: 6535 - 6875 MHz U-NII-8: 6895 - 7115 MHz
2.4 GHz Bluetooth	Data	2402 - 2480 MHz
802.15.4	Data	2405 - 2475 MHz
NB U-NII 1	Data	5162 - 5245 MHz
NB U-NII 3	Data	5733 - 5844 MHz
wPT	N/A	13.56 MHz

FCC ID: BCGA2899	PART 2 RF EXPOSURE EVALUATION REPORT	Approved by: Technical Manager
Document S/N: 1C2311270066-03.BCG	DUT Type: Tablet Device	Page 3 of 66

1.2 Time-Averaging Algorithm for RF Exposure Compliance

This device is enabled with Qualcomm® Smart Transmit feature. This feature performs time averaging algorithm in real time to control and manage transmitting power and ensure the time-averaged RF exposure is in compliance with FCC requirements all the time. DUT contains embedded file system (EFS) version 19 configured for the second generation (GEN2) for Sub6.

The Smart Transmit algorithm maintains the time-averaged transmit power, in turn, time-averaged RF exposure of SAR_design_target or PD_design_target, below the predefined time-averaged power limit (i.e., P_{limit} for sub-6 radio, and input.power.limit for 5G mmW NR), for each characterized technology and band.

Smart Transmit allows the device to transmit at higher power instantaneously, as high as P_{max}, when needed, but enforces power limiting to maintain time-averaged transmit power to P_{limit} for frequencies < 6 GHz and input.power.limit for frequencies > 6 GHz.

Note that the device Smart Tx uncertainty for sub-6GHz WWAN is 1.0 dB for this DUT.

The reserve margin for WWAN radios can be configured for each sub6 antenna group, and each exposure category as shown below:

For a given exposure category (head vs. non-head) and antenna group, OEM can configure:

- TOTAL_MIN_RES_RATIO
This entry corresponds to the minimum reserve margin for WWAN radio or WLAN radio when operating in standalone mode per antenna group. Here, TOTAL_MIN_RES_RATIO is 0.5.
- WWAN_PRI_SPLIT_RATIO, WWAN_SEC_SPLIT_RATIO
In multi-Tx scenarios in the same antenna group, minimum reserve for each active radio (i.e., WWAN primary radio, WWAN secondary radio) is a product of the corresponding fraction out of sum of active radio split ratios and TOTAL_MIN_RES_RATIO.

In case of WWAN primary and WWAN secondary simultaneous transmission in the same antenna group, the minimum reserve for each radio, respectively, are:

- $TOTAL_MIN_RES_RATIO * \{WWAN_PRI_SPLIT_RATIO / (WWAN_PRI_SPLIT_RATIO + WWAN_SEC_SPLIT_RATIO)\}$
- $TOTAL_MIN_RES_RATIO * \{WWAN_SEC_SPLIT_RATIO / (WWAN_PRI_SPLIT_RATIO + WWAN_SEC_SPLIT_RATIO)\}$

Here, WWAN_PRI_SPLIT_RATIO is 0.6 and WWAN_SEC_SPLIT_RATIO is 0.4.

This purpose of the Part 2 report is to demonstrate the DUT complies with FCC RF exposure requirement under Tx varying transmission scenarios, thereby validity of Qualcomm® Smart Transmit feature implementation in this device. It serves to compliment the Part 0 and Part 1 Test Reports to justify compliance per FCC.

Note: WLAN and BT time-averaging is disabled per the manufacturer.

FCC ID: BCGA2899	PART 2 RF EXPOSURE EVALUATION REPORT	Approved by: Technical Manager
Document S/N: 1C2311270066-03.BCG	DUT Type: Tablet Device	Page 4 of 66

1.3 Bibliography

Report Type	Report Serial Number
Part 0 SAR Test Report	1C2311270066-01.BCG
Part 1 SAR Test Report	1C2311270066-02.BCG
RF Exposure Compliance Summary	1C2311270066-04.BCG

FCC ID: BCGA2899	PART 2 RF EXPOSURE EVALUATION REPORT	Approved by: Technical Manager
Document S/N: 1C2311270066-03.BCG	DUT Type: Tablet Device	Page 5 of 66

2 RF EXPOSURE LIMITS

2.1 Uncontrolled Environment

UNCONTROLLED ENVIRONMENTS are defined as locations where there is the exposure of individuals who have no knowledge or control of their exposure. The general population/uncontrolled exposure limits are applicable to situations in which the general public may be exposed or in which persons who are exposed as a consequence of their employment may not be made fully aware of the potential for exposure or cannot exercise control over their exposure. Members of the general public would come under this category when exposure is not employment-related; for example, in the case of a wireless transmitter that exposes persons in its vicinity.

2.2 Controlled Environment

CONTROLLED ENVIRONMENTS are defined as locations where there is exposure that may be incurred by persons who are aware of the potential for exposure, (i.e. as a result of employment or occupation). In general, occupational/controlled exposure limits are applicable to situations in which persons are exposed as a consequence of their employment, who have been made fully aware of the potential for exposure and can exercise control over their exposure. This exposure category is also applicable when the exposure is of a transient nature due to incidental passage through a location where the exposure levels may be higher than the general population/uncontrolled limits, but the exposed person is fully aware of the potential for exposure and can exercise control over his or her exposure by leaving the area or by some other appropriate means.

2.3 RF Exposure Limits for Frequencies Below 6 GHz

Table 2-1
SAR Human Exposure Specified in ANSI/IEEE C95.1-1992 and Health Canada Safety Code 6

HUMAN EXPOSURE LIMITS		
	UNCONTROLLED ENVIRONMENT <i>General Population</i> (W/kg) or (mW/g)	CONTROLLED ENVIRONMENT <i>Occupational</i> (W/kg) or (mW/g)
Peak Spatial Average SAR Head	1.6	8.0
Whole Body SAR	0.08	0.4
Peak Spatial Average SAR Hands, Feet, Ankle, Wrists, etc.	4.0	20

1. The Spatial Peak value of the SAR averaged over any 1 gram of tissue (defined as a tissue volume in the shape of a cube) and over the appropriate averaging time.
2. The Spatial Average value of the SAR averaged over the whole body.
3. The Spatial Peak value of the SAR averaged over any 10 grams of tissue (defined as a tissue volume in the shape of a cube) and over the appropriate averaging time.

FCC ID: BCGA2899	PART 2 RF EXPOSURE EVALUATION REPORT	Approved by: Technical Manager
Document S/N: 1C2311270066-03.BCG	DUT Type: Tablet Device	Page 6 of 66

2.4 Time Averaging Windows for FCC Compliance

Per October 2018 TCB Workshop Notes, the below time-averaging windows can be used for assessing time-averaged exposures for devices that are capable of actively monitoring and adjusting power output over time to comply with exposure limits.

Interim Guidance	Frequency (GHz)	Maximum Averaging Time (sec)
SAR	< 3	100
	3 – 6	60
MPE	6 - 10	30
	10 - 16	14
	16 – 24	8
	24 – 42	4
	42 – 95	2

FCC ID: BCGA2899	PART 2 RF EXPOSURE EVALUATION REPORT	Approved by: Technical Manager
Document S/N: 1C2311270066-03.BCG	DUT Type: Tablet Device	Page 7 of 66

3 TIME VARYING TRANSMISSION TEST CASES

To validate the time averaging feature and demonstrate the compliance in Tx varying transmission conditions, the following transmission scenarios are covered in the Part 2 test:

1. During a time-varying Tx power transmission: To prove that the Smart Transmit feature accounts for Tx power variations in time accurately.
2. During a call disconnect and re-establish scenario: To prove that the Smart Transmit feature accounts for history of past Tx power transmissions accurately.
3. During a technology/band handover: To prove that the Smart Transmit feature functions correctly during transitions in technology/band.
4. During a DSI (Device State Index) change: To prove that the Smart Transmit feature functions correctly during transition from one device state (DSI) to another.
5. During an antenna (or beam) switch: To prove that the Smart Transmit feature functions correctly during transitions in antenna (such as AsDiv scenario) or beams (different antenna array configurations) or beams (different antenna array configurations).
6. During time window switch: To prove that the Smart Transmit feature correctly handles the transition from one time window to another specified by FCC, and maintains the normalized time-averaged RF exposure to be less than normalized FCC limit of 1.0 at all times.
7. SAR exposure switching between two active radios (radio1 and radio2): To prove that the Smart Transmit feature functions correctly and ensures total RF exposure compliance when exposure varies among SAR_radio1 only, SAR_radio1 + SAR_radio2, and SAR_radio2 only scenarios.
8. During a change between exposure category scenario: To prove that the Time-Averaged Specific Absorption Rate (TAS) feature functions correctly during transitions between head and non-head exposure conditions.

As described in Part 0 report, the RF exposure is proportional to the Tx power for a SAR- and PD-characterized wireless device. Thus, feature validation in Part 2 can be effectively performed through conducted (for $f < 6\text{GHz}$) and radiated (for $f \geq 6\text{GHz}$) power measurement. Therefore, the compliance demonstration under dynamic transmission conditions and feature validation are done in conducted/radiated power measurement setup for transmission scenarios 1 through 8.

To add confidence in the feature validation, the time-averaged SAR are also performed but only performed for transmission scenario 1 to avoid the complexity in SAR measurement (such as, for scenario 3 requiring change in SAR probe calibration file to accommodate different bands and/or tissue simulating liquid).

The strategy for testing in Tx varying transmission condition is outlined as follows:

- Demonstrate the total RF exposure averaged over FCC defined time windows does not exceed FCC's SAR limits, through time-averaged power measurements
 - Measure conducted Tx power (for $f < 6\text{GHz}$) versus time.
 - Convert it into RF exposure and divide by respective FCC limits to get normalized exposure versus time.
 - Perform running time-averaging over FCC defined time windows.
 - Demonstrate that the total normalized time-averaged RF exposure is less than 1 for all transmission scenarios (i.e., transmission scenarios 1, 2, 3, 4, 5, 6, 7, and 8) at all times.

Mathematical expression:

FCC ID: BCGA2899	PART 2 RF EXPOSURE EVALUATION REPORT	Approved by: Technical Manager
Document S/N: 1C2311270066-03.BCG	DUT Type: Tablet Device	Page 8 of 66

For < 6 GHz transmission only:

$$1g_or_10gSAR(t) = \frac{conducted_Tx_power(t)}{conducted_Tx_power_P_{limit}} * 1g_or_10gSAR_P_{limit} \quad (1a)$$

$$\frac{\frac{1}{T_{SAR}} \int_{t-T_{SAR}}^t 1g_or_10gSAR(t) dt}{FCC\ SAR\ limit} \leq 1 \quad (1b)$$

where, *conducted_Tx_power(t)*, *conducted_Tx_power_P_{limit}*, and *1g_or_10gSAR_P_{limit}* correspond to the measured instantaneous conducted Tx power, measured conducted Tx power at *P_{limit}*, and measured 1gSAR or 10gSAR values at *P_{limit}* corresponding to sub-6 transmission. *P_{limit}* is the parameter pre-defined in Part 0 and loaded via Embedded File System (EFS) onto the EUT. *T_{SAR}* is the FCC defined time window for sub-6 radio.

- Demonstrate the total RF exposure averaged over FCC defined time windows does not exceed FCC’s SAR limits, through time-averaged SAR. Note as mentioned earlier, this measurement is performed for transmission scenario 1 only.
 - For sub-6 transmission only, measure instantaneous SAR versus time; for LTE+sub6 NR transmission, request low power (or all-down bits) on LTE so that measured SAR predominantly corresponds to sub6 NR.
 - Convert it into RF exposure and divide by respective FCC limits to obtain normalized exposure versus time.
 - Perform time averaging over FCC defined time window.
 - Demonstrate that the total normalized time-averaged RF exposure is less than 1 for transmission scenario 1 at all times.

Mathematical expression:

- For sub-6 transmission only:

$$1g_or_10gSAR(t) = \frac{pointSAR(t)}{pointSAR_P_{limit}} * 1g_or_10gSAR(t)_P_{limit} \quad (2a)$$

$$\frac{\frac{1}{T_{SAR}} \int_{t-T_{SAR}}^t 1g_or_10gSAR(t) dt}{FCC\ SAR\ limit} \leq 1 \quad (2b)$$

where, *conducted_Tx_power(t)*, *conducted_Tx_power_P_{limit}*, and *1g_or_10gSAR_P_{limit}* correspond to the measured instantaneous conducted Tx power, measured conducted Tx power at *P_{limit}*, and measured 1gSAR or 10gSAR values at *P_{limit}* corresponding to sub-6 transmission

FCC ID: BCGA2899	PART 2 RF EXPOSURE EVALUATION REPORT	Approved by: Technical Manager
Document S/N: 1C2311270066-03.BCG	DUT Type: Tablet Device	Page 9 of 66

4 FCC MEASUREMENT PROCEDURES (FREQ < 6 GHZ)

This chapter provides the test plan and test procedure for validating Qualcomm Smart Transmit feature for sub-6 transmission. The 100 seconds time window for operating $f < 3\text{GHz}$ is used as an example to detail the test procedures in this chapter. The same test plan and test procedures described in this chapter apply to 60 seconds time window for operating $f \geq 3\text{GHz}$.

4.1 Test sequence determination for validation

Following the FCC recommendation, two test sequences having time-variation in Tx power are predefined for sub-6 ($f < 6\text{GHz}$) validation:

- Test sequence 1: request DUT's Tx power to be at maximum power, measured P_{max}^\dagger , for 80s, then requesting for half of the maximum power, i.e., measured $P_{max}/2$, for the rest of the time.
- Test sequence 2: request DUT's Tx power to vary with time. This sequence is generated relative to measured P_{max} , measured P_{limit} and calculated $P_{reserve}$ (= measured P_{limit} in dBm - $total_min_reserve$ in dB) of DUT based on measured P_{limit} .

The details for generating these two test sequences is described and listed in Appendix E.

NOTE: For test sequence generation, "measured P_{limit} " and "measured P_{max} " are used instead of the " P_{limit} " specified in EFS entry and " P_{max} " specified for the device, because the Smart Transmit feature operates against the actual power level of the " P_{limit} " that was calibrated for the DUT. The "measured P_{limit} " accurately reflects what the feature is referencing to, therefore, it should be used during feature validation testing. The RF tune up and device-to-device variation are already considered in Part 0 report prior to determining P_{limit} .

4.2 Test configuration selection criteria for validating Smart Transmit feature

For validating the Smart Transmit feature, this section provides the general guidance to select test cases.

4.2.1 Test configuration selection for time-varying Tx power transmission

The Smart Transmit time averaging feature operation is independent of bands, modes, and channels for a given technology. Hence, validation of Smart Transmit in one band/mode/channel per technology is sufficient. Two bands per technology are proposed and selected for this testing to provide high confidence in this validation.

Note this test is designed for single radio transmission scenario. If UE supports sub6 NR in both non-standalone (NSA) and standalone (SA) modes, then validation in time-varying Tx power transmission scenario described in this section needs to be performed in SA mode. Otherwise, it needs to be performed in NSA mode with LTE anchor set to low power. The choice between SA and NSA mode needs to also take into account the selection criteria described below. In general, one mode out of the two modes (NSA or SA) is sufficient for this test.

The criteria for the selection are based on the P_{limit} values determined in Part 0 report. Select two bands* in each supported technology that correspond to least** and highest*** P_{limit} values that are less than P_{max} for validating Smart Transmit. Note:

1. P_{max} refers to maximum Tx power configured for this device in this technology/band (not rated P_{max}). This P_{max} definition applies throughout this Part 2 report.
2. If $P_{limit} > P_{max}$, the validation test with time-varying test sequences is not needed as no power enforcement will be required in this condition.

FCC ID: BCGA2899	PART 2 RF EXPOSURE EVALUATION REPORT	Approved by: Technical Manager
Document S/N: 1C2311270066-03.BCG	DUT Type: Tablet Device	Page 10 of 66

* If one P_{limit} level applies to all the bands within a technology, then only one band needs to be tested. In this case, within the bands having the same P_{limit} , the radio configuration (e.g., # of RBs, channel#) and device position that correspond to the highest *measured* 1gSAR at P_{limit} shown in Part 1 report is selected.

** In case of multiple bands having the same least P_{limit} within the technology, then select the band having the highest *measured* 1gSAR at P_{limit} .

*** The band having a higher P_{limit} needs to be properly selected so that the power limiting enforced by Smart Transmit can be validated using the pre-defined test sequences. If the highest P_{limit} in a technology is too high where the power limiting enforcement is not needed when testing with the pre-defined test sequences, then the next highest level is checked. This process is continued within the technology until the second band for validation testing is determined.

4.2.2 Test configuration selection for change in call

The criteria to select a test configuration for call-drop measurement is:

- Select technology/band with least P_{limit} among all supported technologies/bands, and select the radio configuration (e.g., # of RBs, channel#) in this technology/band that corresponds to the highest *measured* 1gSAR at P_{limit} listed in Part 1 report.
- In case of multiple bands having same least P_{limit} , then select the band having the highest *measured* 1gSAR at P_{limit} in Part 1 report.

This test is performed with the DUT's Tx power requested to be at maximum power, the above band selection will result in Tx power enforcement (i.e., DUT forced to have Tx power at $P_{reserve}$) for longest duration in one FCC defined time window. The call change (call drop/reestablish) is performed during the Tx power enforcement duration (i.e., during the time when DUT is forced to have Tx power at $P_{reserve}$). One test is sufficient as the feature operation is independent of technology and band.

4.2.3 Test configuration selection for change in technology/band

The selection criteria for this measurement is, for a given antenna, to have DUT switch from a technology/band with lowest P_{limit} within the technology group (in case of multiple bands having the same P_{limit} , then select the band with highest *measured* 1gSAR at P_{limit}) to a technology/band with highest P_{limit} within the technology group, in case of multiple bands having the same P_{limit} , then select the band with lowest *measured* 1gSAR at P_{limit} in Part 1 report, or vice versa.

This test is performed with the DUT's Tx power requested to be at maximum power, the technology/band switch is performed during Tx power enforcement duration (i.e., during the time when DUT is forced to have Tx power at $P_{reserve}$).

4.2.4 Test configuration selection for change in antenna

The criteria to select a test configuration for antenna switch measurement is:

- Whenever possible and supported by the DUT, first select antenna switch configuration within the same technology/band (i.e., same technology and band combination).
- Then, select any technology/band that supports multiple Tx antennas, and has the highest difference in P_{limit} among all supported antennas.
- In case of multiple bands having same difference in P_{limit} among supported antennas, then select the band having the highest *measured* 1gSAR at P_{limit} in Part 1 report.

FCC ID: BCGA2899	PART 2 RF EXPOSURE EVALUATION REPORT	Approved by: Technical Manager
Document S/N: 1C2311270066-03.BCG	DUT Type: Tablet Device	Page 11 of 66

This test is performed with the DUT's Tx power requested to be at maximum power in selected technology/band, and antenna change is conducted during Tx power enforcement duration (i.e., during the time when DUT is forced to have Tx power at $P_{reserve}$).

4.2.5 Test configuration selection for change in DSI

The criteria to select a test configuration for DSI change test is

- Select a technology/band having the $P_{limit} < P_{max}$ within any technology and DSI group, and for the same technology/band having a different P_{limit} in any other DSI group. Note that the selected DSI transition need to be supported by the device.

NOTE: The antennas corresponding to the selected DSIs should be in the same antenna group if EUT is configured with GEN2_SUB6 or GEN2_SUB6_MMW, and selected DSIs should be under the same exposure category (i.e., both selected DSIs are either under head exposure category or under non-head exposure category) if EUT is enabled with Smart Transmit version 18 or higher.

This test is performed with the DUT's Tx power requested to be at maximum power in selected technology/band, and DSI change is conducted during Tx power enforcement duration (i.e., during the time when DUT is forced to have Tx power at $P_{reserve}$).

4.2.6 Test configuration selection for change in time window

FCC specifies different time window for time averaging based on operation frequency. The criteria to select a test configuration for validating Smart Transmit feature and demonstrating the compliance during the change in time window is

- Select any technology/band that has operation frequency classified in one time window defined by FCC (such as 100-seconds time window), and its corresponding P_{limit} is less than P_{max} if possible.
- Select the 2nd technology/band that has operation frequency classified in a different time window defined by FCC (such as 60-seconds time window), and its corresponding P_{limit} is less than P_{max} if possible.
- Note it is preferred both P_{limit} values of two selected technology/band less than corresponding P_{max} , but if not possible, at least one of technologies/bands has its P_{limit} less than P_{max} .

This test is performed with the EUT's Tx power requested to be at maximum power in selected technology/band. Test for one pair of time windows selected is sufficient as the feature operation is the same.

4.2.7 Test configuration selection for SAR exposure switching

If supported, the test configuration for SAR exposure switching should cover

1. SAR exposure switch when two active radios are in the same time window
2. SAR exposure switch when two active radios are in different time windows. One test with two active radios in any two different time windows is sufficient as Smart Transmit operation is the same for RF exposure switch in any combination of two different time windows. For device supporting LTE + mmW NR, this test is covered in SAR vs PD exposure switch validation.

The Smart Transmit time averaging operation is independent of the source of SAR exposure (for example, LTE vs. Sub6 NR) and ensures total time-averaged RF exposure compliance. Hence, validation of Smart Transmit in any one simultaneous SAR transmission scenario (i.e., one combination for LTE + Sub6 NR transmission) is sufficient, where the SAR exposure varies among SAR_{radio1} only, $SAR_{radio1} + SAR_{radio2}$, and SAR_{radio2} only scenarios.

The criteria to select a test configuration for validating Smart Transmit feature during SAR exposure switching scenarios is

FCC ID: BCGA2899	PART 2 RF EXPOSURE EVALUATION REPORT	Approved by: Technical Manager
Document S/N: 1C2311270066-03.BCG	DUT Type: Tablet Device	Page 12 of 66

- Select any two < 6GHz technologies/bands that the EUT supports simultaneous transmission (for example, LTE+Sub6 NR).
- Among all supported simultaneous transmission configurations, the selection order is
 1. select one configuration where both P_{limit} of radio1 and radio2 is less than their corresponding P_{max} , preferably, with different P_{limits} . If this configuration is not available, then,
 2. select one configuration that has P_{limit} less than its P_{max} for at least one radio. If this can not be found, then,
 3. select one configuration that has P_{limit} of radio1 and radio2 greater than P_{max} but with least $(P_{limit} - P_{max})$ delta.

Test for one simultaneous transmission scenario is sufficient as the feature operation is the same.

4.2.8 Test configuration selection for exposure category switch

The criteria to select a test configuration for exposure category switch measurement is:

1. If the device's intended exposure mode is configured for time averaged exposure mode operation, then:
 - If $P_{limit} < P_{max}$ for at least one radio out of all supported technology/band/antenna/DSI, then:
 - (a) Out of all head exposure DSIs, select a technology/band/antenna/DSI having the least $P_{limit} (< P_{max})$, furthermore, having the largest difference between P_{max} and $P_{limit} (P_{limit} < P_{max})$ should be considered in the selection. Then, select a second DSI in the non- head exposure category DSI that has the least P_{limit} among all the non-head DSIs for the same technology/band/antenna. This technology/band/antenna and selected DSIs are used for head to non-head to head exposure switch test. If the $P_{limit} > P_{max}$ for all supported technology/band/antenna/DSI in head exposure category, then this test is not required.
 - (b) Similarly, out of all non-head exposure DSIs, select a technology/band/antenna/DSI having the least $P_{limit} (< P_{max})$, furthermore, having the largest difference between P_{max} and $P_{limit} (P_{limit} < P_{max})$ should be considered in the selection. Then, select a second DSI in the head exposure category DSI that has the least P_{limit} among all the head DSIs for the same technology/band/antenna. This technology/band/antenna and selected DSIs are used for non-head to head to non-head exposure switch test. If the $P_{limit} > P_{max}$ for all supported technology/band/antenna/DSI in non-head exposure category, then this test is not required.
 - If $P_{limit} > P_{max}$ for all supported technology/band/antenna/DSIs for both head and non-head DSI categories, then:
 - c) select a supported sub6 simultaneous transmission scenario (like LTE + FR1 NSA, or LTE interband ULCA, or FR1 interband NR-DC, etc.) in head DSI that has $P_{limit} < P_{max} + 10 \cdot \log(N)$ for all radios of selected technology(s)/band(s)/antenna(s), where N is the number of active radios in selected sub6 simultaneous transmission scenario.

Note that the antennas determined for the selected radios of simultaneous transmission scenario should be in the same antenna group if EUT is configured with GEN2_SUB6 or GEN2_SUB6_MMW (see Appendix N and O for Smart Transmit sub6 antenna group and mmW module group information). Then, select a second DSI in the non-head exposure category that

FCC ID: BCGA2899	PART 2 RF EXPOSURE EVALUATION REPORT	Approved by: Technical Manager
Document S/N: 1C2311270066-03.BCG	DUT Type: Tablet Device	Page 13 of 66

has the lowest P_{limit} among all the non-head DSIs for all the radios of the selected technology(s)/band(s)/antenna(s) simultaneous transmission scenario. This selected technology(s)/band(s)/antenna(s) and selected DSIs are used for head to non-head to head exposure switch test. If the head DSI has $P_{limit} > P_{max} + 10 \cdot \log(N)$ for all radios supported in sub6 simultaneous transmission scenarios, then this test is not required.

- d) select a supported sub6 simultaneous transmission scenario (like LTE + FR1 NSA, or LTE interband ULCA, or FR1 interband NR-DC, etc.) in non-head DSI that has $P_{limit} < P_{max} + 10 \cdot \log(N)$ for all radios of the selected technology(s)/band(s)/antenna(s), where N is the number of active radios in selected sub6 simultaneous transmission scenario. Note that the antennas determined for the selected radios of simultaneous transmission scenario should be in the same antenna group if EUT is configured with GEN2_SUB6 or GEN2_SUB6_MMW (see Appendix N and O for Smart Transmit sub6 antenna group and mmW module group information). Then, select a second DSI in the head exposure category that has the lowest P_{limit} among all the head DSIs for all the radios of the selected technology(s)/band(s)/antenna(s) simultaneous transmission scenario. This selected technology(s)/band(s)/antenna(s) and selected DSIs are used for non-head to head to non-head exposure switch test. If the non-head DSI has $P_{limit} > P_{max} + 10 \cdot \log(N)$ for all radios supported in sub6 simultaneous transmission scenarios, then this test is not required.
- Use the highest measured 1g_or_10g SAR at P_{limit} ($P_{limit} < P_{max}$) shown in Part 1 report for the selected tech/band/antenna/DSI out of all radio configurations and device positions in Equation (1a), (2a), (3a) and (4a) to calculate time-varying SAR. However, in the case of $P_{limit} > P_{max}$, the SAR measured in Part 1 report for the corresponding radio configuration selected and tested in Part 2 should be applied in Equation (1a), (2a), (3a) and (4a).
2. If the device's intended exposure mode is configured for peak exposure mode operation, then:
- a) Select a supported sub6 simultaneous transmission scenario (like LTE + FR1 NSA, or LTE interband ULCA, or FR1 interband NR-DC, etc.) in head DSI that has $P_{limit} < P_{max} + 10 \cdot \log(N)$ for all radios of selected technology(s)/band(s)/antenna(s), where N is the number of active radios in selected sub6 simultaneous transmission scenario. Note that the antennas determined for the selected radios of simultaneous transmission scenario should be in the same antenna group if EUT is configured with GEN2_SUB6 or GEN2_SUB6_MMW (see Appendix N and O for Smart Transmit sub6 antenna group and mmW module group information). Then, select a second DSI in the non-head exposure category that has the lowest P_{limit} among all the non-head DSIs for all the radios of the selected technology(s)/band(s)/antenna(s) simultaneous transmission scenario. This selected technology(s)/band(s)/antenna(s) and selected DSIs are used for head to non-head to head exposure switch test. If the head DSI has $P_{limit} > P_{max} + 10 \cdot \log(N)$ for all radios supported in sub6 simultaneous transmission scenarios, then this test is not required.
 - b) Select a supported sub6 simultaneous transmission scenario (like LTE + FR1 NSA, or LTE interband ULCA, or FR1 interband NR-DC, etc.) in non-head DSI that has $P_{limit} < P_{max} + 10 \cdot \log(N)$ for all radios of the selected technology(s)/band(s)/antenna(s), where N is the number of active radios in selected sub6 simultaneous transmission scenario. Note that the antennas determined for the selected radios of simultaneous transmission scenario should be in the same antenna group if EUT is configured with GEN2_SUB6 or GEN2_SUB6_MMW (see Appendix N and O for Smart Transmit sub6 antenna group and mmW module group information). Then, select a second DSI in the head exposure category that has the lowest P_{limit} among all the head DSIs for all the radios of the selected technology(s)/band(s)/antenna(s) simultaneous transmission scenario. This selected technology(s)/band(s)/antenna(s) and selected DSIs are used for non-head to head to non-head exposure switch test. If the non-head

FCC ID: BCGA2899	PART 2 RF EXPOSURE EVALUATION REPORT	Approved by: Technical Manager
Document S/N: 1C2311270066-03.BCG	DUT Type: Tablet Device	Page 14 of 66

DSI has $P_{limit} > P_{max} + 10 \cdot \log(N)$ for all radios supported in sub6 simultaneous transmission scenarios, then this test is not required.

- Use the highest measured 1g_or_10g SAR at P_{limit} ($P_{limit} < P_{max}$) shown in Part 1 report for the selected tech/band/antenna/DSI out of all radio configurations and device positions in Equation (1a), (2a), (3a) and (4a) to calculate time-varying SAR. However, in the case of $P_{limit} > P_{max}$, the SAR measured in Part 1 report for the corresponding radio configuration selected and tested in Part 2 should be applied in Equation (1a), (2a), (3a) and (4a).

4.3 Test procedures for conducted power measurements

This section provides general conducted power measurement procedures to perform compliance test under dynamic transmission scenarios described in Section 3. In practice, an adjustment can be made in these procedures. The justification/clarification may be provided.

4.3.1 Time-varying Tx power transmission scenario

This test is performed with the two pre-defined test sequences described in Section 4.1 for all the technologies and bands selected in Section 4.2.1. The purpose of the test is to demonstrate the effectiveness of power limiting enforcement and that the time-averaged SAR (corresponding time-averaged Tx power) does not exceed the FCC limit at all times (see Eq. (1a) and (1b)).

Test procedure

1. Measure P_{max} , measure P_{limit} and calculate $P_{reserve}$ (measured P_{limit} in dBm – $total_min_reserve$ in dB) and follow Section 4.1 to generate the test sequences for all the technologies and bands selected in Section 4.2.1. Both test sequence 1 and test sequence 2 are created based on measured P_{max} and measured P_{limit} of the DUT. Test condition to measure P_{max} and P_{limit} is:
 - a. Measure P_{max} with Smart Transmit disabled and callbox set to request maximum power.
 - b. Measure P_{limit} with Smart Transmit peak exposure mode enabled, and callbox set to request maximum power.
2. Set DUT to the intended Smart Transmit exposure mode, establish radio link in desired radio configuration, with callbox requesting the DUT's Tx power to be at pre-defined test sequence 1, measure and record Tx power versus time, and then convert the conducted Tx power into 1gSAR or 10gSAR value (see Eq. (1a)) using measured P_{limit} from above Step 1. Perform running time average to determine time-averaged power and 1gSAR or 10gSAR versus time as illustrated in Figure 4-1 where using 100-seconds time window as an example.

Note: In Eq.(1a), instantaneous Tx power is converted into instantaneous 1gSAR or 10gSAR value by applying the measured worst-case 1gSAR or 10gSAR value at P_{limit} for the corresponding technology/band/antenna/DSI reported in Part 1 report.

Note: For an easier computation of the running time average, 0 dBm can be added at the beginning of the test sequences the length of the responding time window, for example, add 0dBm for 100-seconds so the running time average can be directly performed starting with the first 100-seconds data using excel spreadsheet. This technique applies to all tests performed in this Part 2 report for easier time-averaged computation using excel spreadsheet.

FCC ID: BCGA2899	PART 2 RF EXPOSURE EVALUATION REPORT	Approved by: Technical Manager
Document S/N: 1C2311270066-03.BCG	DUT Type: Tablet Device	Page 15 of 66

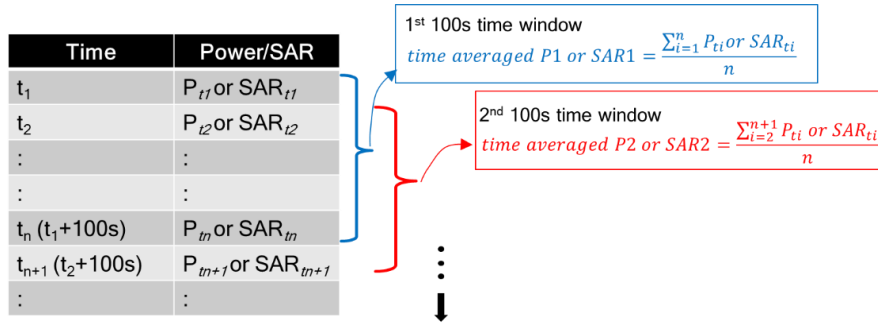

Figure 4-1
Running Average Illustration

3. Make one plot containing:
 - a. Instantaneous Tx power versus time measured in Step 2,
 - b. Requested Tx power used in Step 2 (test sequence 1),
 - c. Computed time-averaged power versus time determined in Step 2,
 - d. Time-averaged power limit (corresponding to FCC SAR limit of 1.6 W/kg for 1gSAR or 4.0W/kg for 10gSAR) given by

$$Time\ averaged\ power\ limit = meas.P_{limit} + 10 \times \log\left(\frac{FCC\ SAR\ limit}{meas.SAR_Plimit}\right) \quad (3a)$$

where $meas.P_{limit}$ and $meas.SAR_Plimit$ correspond to measured power at P_{limit} and measured SAR at P_{limit} .

4. Make another plot containing:
 - a. Computed time-averaged 1gSAR or 10gSAR versus time determined in Step 2
 - b. FCC $1gSAR_{limit}$ of 1.6W/kg or FCC $10gSAR_{limit}$ of 4.0W/kg.
5. Repeat Steps 2 ~ 4 for pre-defined test sequence 2 and replace the requested Tx power (test sequence 1) in Step 2 with test sequence 2.
6. Repeat Steps 2 ~ 5 for all the selected technologies and bands.
7. The validation criteria are, at all times, the time-averaged power versus time shown in Step 3 plot shall not exceed the time-averaged power limit (defined in Eq. (3a)), in turn, the time-averaged 1gSAR or 10gSAR versus time shown in Step 4 plot shall not exceed the FCC limit of 1.6 W/kg for 1gSAR or 4.0 W/kg for 10gSAR (i.e., Eq. (1b)).

4.3.2 Change in call scenario

This test is to demonstrate that Smart Transmit feature accurately accounts for the past Tx powers during time-averaging when a new call is established.

The call disconnect and re-establishment needs to be performed during power limit enforcement, i.e., when the DUT's Tx power is at $P_{reserve}$ level, to demonstrate the continuity of RF exposure management and limiting in call change scenario. In other words, the RF exposure averaged over any FCC defined time window (including the time windows containing the call change) doesn't exceed FCC limit of 1.6 W/kg for 1gSAR or 4.0 W/kg for 10gSAR.

FCC ID: BCGA2899	PART 2 RF EXPOSURE EVALUATION REPORT	Approved by: Technical Manager
Document S/N: 1C2311270066-03.BCG	DUT Type: Tablet Device	Page 16 of 66

Test procedure

1. Measure P_{limit} for the technology/band selected in Section 4.2.2. Measure P_{limit} with Smart Transmit peak exposure mode enabled, and callbox set to request maximum power.
2. Set DUT to the intended Smart Transmit exposure mode.
3. Establish radio link with callbox in the selected technology/band.
4. Request DUT's Tx power at 0 dBm for at least one time window specified for the selected technology/band, followed by requesting DUT's Tx power to be at maximum power for about ~60 seconds, and then drop the call for ~10 seconds. Afterwards, re-establish another call in the same radio configuration (i.e., same technology/band/channel) and continue callbox requesting DUT's Tx power to be at maximum power for the remaining time of at least another full duration of the specified time window. Measure and record Tx power versus time. Once the measurement is done, extract instantaneous Tx power versus time, convert the measured conducted Tx power into 1gSAR or 10gSAR value using Eq. (1a), and then perform the running time average to determine time-averaged power and 1gSAR or 10gSAR versus time.

NOTE: In Eq.(1a), instantaneous Tx power is converted into instantaneous 1gSAR or 10gSAR value by applying the measured worst-case 1gSAR or 10gSAR value at P_{limit} for the corresponding technology/band/antenna/DSI reported in Part 1 report.

5. Make one plot containing: (a) instantaneous Tx power versus time, (b) requested power, (c) computed time-averaged power, (d) time-averaged power limit calculated using Eq.(3a).
6. Make another plot containing: (a) computed time-averaged 1gSAR or 10gSAR versus time, and (b) FCC limit of 1.6 W/kg for 1gSAR or 4.0 W/kg for 10gSAR.

The validation criteria are, at all times, the time-averaged power versus time shall not exceed the time-averaged power limit (defined in Eq.(3a)), in turn, the time-averaged 1gSAR or 10gSAR versus time shall not exceed the FCC limit of 1.6 W/kg for 1gSAR or 4.0 W/kg for 10gSAR (i.e., Eq. (1b)).

4.3.3 Change in technology and band

This test is to demonstrate the correct power control by Smart Transmit during technology switches and/or band handovers.

Similar to the change in call test in Section 4.3.2, to validate the continuity of RF exposure limiting during the transition, the technology and band handover needs to be performed when DUT's Tx power is at $P_{reserve}$ level (i.e., during Tx power enforcement) to make sure that the DUT's Tx power from previous $P_{reserve}$ level to the new $P_{reserve}$ level (corresponding to new technology/band). Since the P_{limit} could vary with technology and band, Eq. (1a) can be written as follows to convert the instantaneous Tx power in 1gSAR or 10gSAR exposure for the two given radios, respectively:

$$1g_or_10gSAR_1(t) = \frac{conducted_Tx_power_1(t)}{conducted_Tx_power_P_{limit_1}} * 1g_or_10gSAR_P_{limit_1} \quad (4a)$$

$$1g_or_10gSAR_2(t) = \frac{conducted_Tx_power_2(t)}{conducted_Tx_power_P_{limit_2}} * 1g_or_10gSAR_P_{limit_2} \quad (4b)$$

$$\frac{1}{T_{SAR}} \left[\int_{t-T_{SAR}}^{t_1} \frac{1g_or_10gSAR_1(t)}{FCC\ SAR\ limit} dt + \int_{t-T_{SAR}}^t \frac{1g_or_10gSAR_2(t)}{FCC\ SAR\ limit} dt \right] \leq 1 \quad (4c)$$

where, $conducted_Tx_power_1(t)$, $conducted_Tx_power_P_{limit_1}$, and $1g_or_10gSAR_P_{limit_1}$ correspond to the measured instantaneous conducted Tx power, measured conducted Tx power at P_{limit} , and measured 1gSAR or 10gSAR value at P_{limit} of technology1/band1; $conducted_Tx_power_2(t)$,

FCC ID: BCGA2899	PART 2 RF EXPOSURE EVALUATION REPORT	Approved by: Technical Manager
Document S/N: 1C2311270066-03.BCG	DUT Type: Tablet Device	Page 17 of 66

$conducted_Tx_power_P_{limit_2}(t)$, and $1g_or_10gSAR_P_{limit_2}$ correspond to the measured instantaneous conducted Tx power, measured conducted Tx power at P_{limit} , and measured 1gSAR or 10gSAR value at P_{limit} of technology2/band2. Transition from technology1/band1 to the technology2/band2 happens at time-instant ' t_1 '.

Test procedure

1. Measure P_{limit} for both the technologies and bands selected in Section 4.2.3. Measure P_{limit} with Smart Transmit peak exposure mode enabled, and callbox set to request maximum power.
2. Set DUT to the intended Smart Transmit exposure mode. Establish radio link with callbox in first technology/band selected. Establish radio link with callbox in first technology/band selected.
3. Request DUT's Tx power at 0 dBm for at least one time window specified for the selected technology/band, followed by requesting DUT's Tx power to be at maximum power for about ~60 seconds, and then switch to second technology/band selected. Continue with callbox requesting DUT's Tx power to be at maximum power for the remaining time of at least another full duration of the specified time window. Measure and record Tx power versus time for the full duration of the test.
4. Once the measurement is done, extract instantaneous Tx power versus time, and convert the conducted Tx power into 1gSAR or 10gSAR value using Eq. (4a) and (4b) and corresponding measured P_{limit} values from Step 1 of this section. Perform the running time average to determine time-averaged power and 1gSAR or 10gSAR versus time.

NOTE: In Eq.(4a) & (4b), instantaneous Tx power is converted into instantaneous 1gSAR or 10gSAR value by applying the measured worst-case 1gSAR or 10gSAR value at P_{limit} for the corresponding technology/band/antenna/DSI reported in Part 1 report.

5. Make one plot containing: (a) instantaneous Tx power versus time, (b) requested power, (c) computed time-averaged power, (d) time-averaged power limit calculated using Eq.(3a).
6. Make another plot containing: (a) computed time-averaged 1gSAR or 10gSAR versus time, and (b) FCC limit of 1.6 W/kg for 1gSAR or 4.0 W/kg for 10gSAR.

The validation criteria are, at all times, the time-averaged 1gSAR or 10gSAR versus time shall not exceed the FCC limit of 1.6 W/kg for 1gSAR or 4.0 W/kg for 10gSAR (i.e., Eq. (4c)).

4.3.4 Change in antenna

This test is to demonstrate the correct power control by Smart Transmit during antenna switches from one antenna to another. The test procedure is identical to Section 4.3.3, by replacing technology/band switch operation with antenna switch. The validation criteria are, at all times, the time-averaged 1gSAR or 10gSAR versus time shall not exceed FCC limit of 1.6 W/kg for 1gSAR or 4.0 W/kg for 10gSAR.

NOTE: If the DUT does not support antenna switch within the same technology/band, but has multiple antennas to support different frequency bands, then the antenna switch test is included as part of change in technology and band (Section 4.3.3) test.

4.3.5 Change in DSI

This test is to demonstrate the correct power control by Smart Transmit during DSI switches from one DSI to another. The test procedure is identical to Section 4.3.3, by replacing technology/band switch operation with DSI switch. The validation criteria are, at all times, the time-averaged 1gSAR or 10gSAR versus time shall not exceed FCC limit of 1.6 W/kg for 1gSAR or 4.0 W/kg for 10gSAR.

FCC ID: BCGA2899	PART 2 RF EXPOSURE EVALUATION REPORT	Approved by: Technical Manager
Document S/N: 1C2311270066-03.BCG	DUT Type: Tablet Device	Page 18 of 66

4.3.6 Change in time window

This test is to demonstrate the correct power control by Smart Transmit during the change in averaging time window when a specific band handover occurs. FCC specifies time-averaging windows of 100s for Tx frequency < 3GHz, and 60s for Tx frequency between 3GHz and 6GHz.

To validate the continuity of RF exposure limiting during the transition, the band handover test needs to be performed when EUT handovers from operation band less than 3GHz to greater than 3GHz and vice versa. The equations (3a) and (3b) in Section 2 can be written as follows for transmission scenario having change in time window,

$$1gSAR_1(t) = \frac{\text{conducted_Tx_power_1}(t)}{\text{conducted_Tx_power_P_limit_1}} * 1g_or\ 10g_SAR_P_limit_1 \quad (5a)$$

$$1gSAR_2(t) = \frac{\text{conducted_Tx_power_2}(t)}{\text{conducted_Tx_power_P_limit_2}} * 1g_or\ 10g_SAR_P_limit_2 \quad (5b)$$

$$\frac{1}{T1_{SAR}} \left[\int_{t-T1_{SAR}}^{t_1} \frac{1g_or\ 10g_SAR_1(t)}{FCC\ SAR\ limit} dt \right] + \frac{1}{T2_{SAR}} \left[\int_{t-T2_{SAR}}^t \frac{1g_or\ 10g_SAR_2(t)}{FCC\ SAR\ limit} dt \right] \leq 1 \quad (5c)$$

where, *conducted_Tx_power_1(t)*, *conducted_Tx_power_P_limit_1(t)*, and *1g_ or 10g_SAR_P_limit_1* correspond to the instantaneous Tx power, conducted Tx power at *P_limit_1*, and compliance *1g_ or 10g_SAR* values at *P_limit_1* of band1 with time-averaging window '*T1_SAR*'; *conducted_Tx_power_2(t)*, *conducted_Tx_power_P_limit_2(t)*, and *1g_ or 10g_SAR_P_limit_2* correspond to the instantaneous Tx power, conducted Tx power at *P_limit_2*, and compliance *1g_ or 10g_SAR* values at *P_limit_2* of band2 with time-averaging window '*T2_SAR*'. One of the two bands is less than 3GHz, another is greater than 3GHz. Transition from first band with time-averaging window '*T1_SAR*' to the second band with time-averaging window '*T2_SAR*' happens at time-instant '*t_1*'.

Test procedure

1. Measure *P_limit* for both the technologies and bands selected in Section 4.2.6. Measure *P_limit* with Smart Transmit peak exposure mode enabled, and callbox set to request maximum power.
2. Set DUT to the intended Smart Transmit exposure mode.

Transition from 100s time window to 60s time window, and vice versa

3. Establish radio link with callbox in the technology/band having 100s time window selected in Section 4.2.6.
4. Request EUT's Tx power to be at 0 dBm for at least 100 seconds, followed by requesting EUT's Tx power to be at maximum power for about ~140 seconds, and then switch to second technology/band (having 60s time window) selected in Section 4.2.6. Continue with callbox requesting EUT's Tx power to be at maximum power for about ~60s in this second technology/band, and then switch back to the first technology/band. Continue with callbox requesting EUT's Tx power to be at maximum power for at least another 100s. Measure and record Tx power versus time for the entire duration of the test.
5. Once the measurement is done, extract instantaneous Tx power versus time, and convert the conducted Tx power into 1gSAR or 10gSAR value (see Eq. (5a) and (5b)) using corresponding technology/band Step 1 result, and then perform 100s running average to determine time-averaged 1gSAR or 10gSAR versus time. Note that in Eq.(5a) & (5b), instantaneous Tx power is converted into instantaneous 1gSAR or 10gSAR value by applying the worst-case 1gSAR or 10gSAR value tested in Part 1 for the selected technologies/bands at *P_limit*.
6. Make one plot containing: (a) instantaneous Tx power versus time measured in Step 4.

FCC ID: BCGA2899	PART 2 RF EXPOSURE EVALUATION REPORT	Approved by: Technical Manager
Document S/N: 1C2311270066-03.BCG	DUT Type: Tablet Device	Page 19 of 66

7. Make another plot containing: (a) instantaneous 1gSAR versus time determined in Step 5, (b) computed time-averaged 1gSAR versus time determined in Step 5, and (c) corresponding regulatory $1gSAR_{limit}$ of 1.6W/kg or $10gSAR_{limit}$ of 4.0W/kg.

Transition from 60s time window to 100s time window, and vice versa

8. Establish radio link with callbox in the technology/band having 60s time window selected in Section 4.2.6.
9. Request EUT's Tx power to be at 0 dBm for at least 60 seconds, followed by requesting EUT's Tx power to be at maximum power for about ~80 seconds, and then switch to second technology/band (having 100s time window) selected in Section 4.2.6. Continue with callbox requesting EUT's Tx power to be at maximum power for about ~100s in this second technology/band, and then switch back to the first technology/band. Continue with callbox requesting EUT's Tx power to be at maximum power for the remaining time for a total test time of 500 seconds. Measure and record Tx power versus time for the entire duration of the test.
10. Repeat above Step 5~7 to generate the plots

The validation criteria is, at all times, the time-averaged 1gSAR or 10gSAR versus time shall not exceed the regulatory $1gSAR_{limit}$ of 1.6W/kg or $10gSAR_{limit}$ of 4.0W/kg.

4.3.7 SAR exposure switching

This test is to demonstrate that Smart Transmit feature is accurately accounts for switching in exposures among SAR from radio1 only, SAR from both radio1 and radio2, and SAR from radio2 only scenarios, and ensures total time-averaged RF exposure complies with the FCC limit. Here, radio1 represents primary radio (for example, LTE anchor in a NR non-standalone mode call) and radio2 represents secondary radio (for example, sub6 NR or mmW NR). The detailed test procedure for SAR exposure switching in the case of LTE+Sub6 NR non-standalone mode transmission scenario is provided in APPENDIX F.

Test procedure:

1. Measure conducted Tx power corresponding to P_{limit} for radio1 and radio2 in selected band. Test condition to measure conducted P_{limit} is:
 - Establish device in call with the callbox for radio1 technology/band. Measure conducted Tx power corresponding to radio1 P_{limit} with Smart Transmit peak exposure mode enabled, and callbox set to request maximum power.
 - Repeat above step to measure conducted Tx power corresponding to radio2 P_{limit} . If radio2 is dependent on radio1 (for example, non-standalone mode of Sub6 NR requiring radio1 LTE as anchor), then establish radio1 + radio2 call with callbox, and request all down bits for radio1 LTE. In this scenario, with callbox requesting maximum power from radio2 Sub6 NR, measured conducted Tx power corresponds to radio2 P_{limit} (as radio1 LTE is at all-down bits)
2. Set DUT to the intended Smart Transmit exposure mode, with EUT setup for radio1 + radio2 call. In this description, it is assumed that radio2 has lower priority than radio1. Establish device in radio1+radio2 call, and request all-down bits or low power on radio1, with callbox requesting EUT's Tx power to be at maximum power in radio2 for at least one time window. After one time window, set callbox to request EUT's Tx power to be at maximum power on radio1, i.e., all-up bits. Continue radio1+radio2 call with both radios at maximum power for at least one time window, and drop (or request all-down bits on) radio2. Continue radio1 at maximum power for at least one time window. Record the conducted Tx power for both radio1 and radio2 for the entire duration of this test.

FCC ID: BCGA2899	PART 2 RF EXPOSURE EVALUATION REPORT	Approved by: Technical Manager
Document S/N: 1C2311270066-03.BCG	DUT Type: Tablet Device	Page 20 of 66

3. Once the measurement is done, extract instantaneous Tx power versus time for both radio1 and radio2 links. Convert the conducted Tx power for both these radios into 1gSAR or 10gSAR value (see Eq. (4a) and (4b)) using corresponding technology/band P_{limit} measured in Step 1, and then perform the running time average to determine time-averaged 1gSAR or 10gSAR versus time.
4. Make one plot containing: (a) instantaneous Tx power versus time measured in Step 2.
5. Make another plot containing: (a) instantaneous 1gSAR versus time determined in Step 3, (b) computed time-averaged 1gSAR versus time determined in Step 3, and (c) corresponding regulatory $1gSAR_{limit}$ of 1.6W/kg or $10gSAR_{limit}$ of 4.0W/kg.

The validation criteria is, at all times, the time-averaged 1gSAR or 10gSAR versus time shall not exceed the regulatory $1gSAR_{limit}$ of 1.6W/kg or $10gSAR_{limit}$ of 4.0W/kg.

NOTE: If $multi_Tx_factor$ is set to > 1.0 with EFS version 19 (or higher), then in single Tx transmission scenarios, Smart Transmit ensures time-averaged RF exposure is $\leq (SAR_design_target * 10^{(+sub6\ device\ uncertainty/10)}) < regulatory\ RF\ exposure\ limit$ for sub6 radio managed by Smart Transmit. In simultaneous Tx transmission scenarios, Smart Transmit ensures time-averaged RF exposure is $\leq (SAR_design_target * multi_Tx_factor * 10^{(+sub6\ device\ uncertainty/10)}) < regulatory\ RF\ exposure\ limit$ for sub6 radios managed by Smart Transmit. These simultaneous transmission scenarios are listed below:

- 2-or-more radio scenarios within WWAN like EN-DC, LTE ULCA, etc.
- 2-or-more-radio across technologies such as WWAN+WLAN, WWAN+BT, WLAN+BT and WWAN+WLAN+BT transmission scenarios (if WLAN/BT radios are also managed by Smart Transmit).

4.3.8 Exposure category switch

This test is performed with the EUT being requested to transmit at maximum power in selected technology/band/antenna/DSI. The change in exposure category is preferably performed during Tx power enforcement (i.e., EUT forced to transmit at a sustainable level). One test is sufficient as this feature operation is independent of technology, band, and antenna. Test procedure are:

In case of head to non-head to head exposure switch test, 'first DSI' in below test procedure refers to head DSI and 'second DSI' refers to non-head DSI. Similarly, in case of non-head to head to non-head exposure switch test, 'first DSI' in below test procedure refers to non-head DSI and 'second DSI' refers to head DSI.

1. Measure P_{limit} for all the technology(s)/band(s)/antenna(s)/DSI(s) selected following the above selection criteria. Measure P_{limit} with Smart Transmit Peak exposure mode enabled and callbox set to request maximum power.
2. Set EUT to intended Smart Transmit exposure mode.
3. Establish radio link with first DSI and with callbox in the selected technology(s)/band(s)/antenna(s).
4. Request EUT to transmit at 0 dBm for at least 100 seconds, followed by requesting EUT to transmit at maximum Tx power for the active radio(s) for half of the regulatory time window, and then switch to the second DSI for ~10s, and switch back to the first DSI for at least one time window. Throughout this test, when switching between DSIs (i.e., switching between exposure categories), continue with callbox requesting EUT to transmit at maximum Tx power for the active radio(s). Measure and record Tx power versus time for the entire duration of the test.

FCC ID: BCGA2899	PART 2 RF EXPOSURE EVALUATION REPORT	Approved by: Technical Manager
Document S/N: 1C2311270066-03.BCG	DUT Type: Tablet Device	Page 21 of 66

5. Once the measurement is done, extract instantaneous Tx power versus time, and convert the conducted Tx power into 1g_or_10gSAR value (see Eq. (5a) and (5b)) using the corresponding P_{limit} measured in Step 1 and 1g_or_10gSAR value measured in 80-W2112-4 Part 1 report, and then perform 100s running average to determine time-averaged 1g_or_10gSAR versus time as illustrated in Figure 5-1. Note that in Eq.(5a) & (5b), instantaneous Tx power is converted into instantaneous 1g_or_10gSAR value by applying the worst-case 1gSAR value for the selected technologies/bands at P_{limit} as reported in 80- W2112-4 Part 1 report.
6. Make one plot containing: (a) computed time-averaged normalized 1g_or_10gSAR of the selected technology(s)/band(s)/antenna(s) versus time determined in Step 5 for exposure under first DSI , (b) total time-averaged normalized exposure for exposure under first DSI if simultaneous transmission scenario was tested, and (c) normalized regulatory limit of 1.0.
7. Make another plot containing: (a) computed time-averaged 1g_or_10gSAR of the selected technology(s)/band(s)/antenna(s) versus time determined in Step 5 for exposure under second DSI, (b) total time-averaged normalized exposure for exposure under second DSI if simultaneous transmission scenario was tested, and (c) normalized regulatory limit of 1.0.

The validation criteria is, at all times, the time-averaged normalized exposure versus time shall not exceed the normalized limit of 1.0 for both first & second DSIs (i.e., both head exposure category and non-head exposure category).

4.4 Test procedure for time-varying SAR measurements

This section provides general time-varying SAR measurement procedures to perform compliance test under dynamic transmission scenarios described in Section 3. In practice, an adjustment can be made in these procedures. The justification/clarification may be provided.

To perform the validation through SAR measurement for transmission scenario 1 described in Section 3, the “path loss” between callbox antenna and DUT needs to be calibrated to ensure that the DUT Tx power reacts to the requested power from callbox in a radiated call. It should be noted that when signaling in closed loop mode, protocol-level power control is in play, resulting in DUT not solely following callbox TPC (Tx power control) commands. In other words, DUT response has many dependencies (RSSI, quality of signal, path loss variation, fading, etc..) other than just TPC commands. These dependencies have less impact in conducted setup (as it is a controlled environment and the path loss can be very well calibrated) but have significant impact on radiated testing in an uncontrolled environment, such as SAR test setup. Therefore, the deviation in DUT Tx power from callbox requested power is expected, however the time-averaged SAR should not exceed FCC SAR requirement at all times as Smart Transmit controls Tx power at DUT.

The following steps are for time averaging feature validation through SAR measurement:

1. “Path Loss” calibration: Place the DUT against the phantom in the worst-case position determined based on Section 4.2.1. For each band selected, prior to SAR measurement, perform “path loss” calibration between callbox antenna and DUT. Since the SAR test environment is not controlled and well calibrated for OTA (Over the Air) test, extreme care needs to be taken to avoid the influence from reflections. The test setup is described in Section 6.2.
2. Time averaging feature validation:
 - i For a given radio configuration (technology/band) selected in Section 4.2.1, enable Smart Transmit peak exposure mode, with callbox to request maximum power, perform area scan, conduct pointSAR measurement at peak location of the area scan. This point SAR value, $pointSAR_{P_{limit}}$, corresponds to point SAR at the measured P_{limit} (i.e., measured P_{limit} from the DUT in Step 1 of Section 4.3.1).

FCC ID: BCGA2899	PART 2 RF EXPOSURE EVALUATION REPORT	Approved by: Technical Manager
Document S/N: 1C2311270066-03.BCG	DUT Type: Tablet Device	Page 22 of 66

- ii Set DUT to the intended Smart Transmit exposure mode. Note, if *Total_min_reserve* cannot be set wirelessly, care must be taken to re-position the DUT in the exact same position relative to the SAM phantom as in above Step 2.i. Establish radio link in desired radio configuration, with callbox requesting the DUT's Tx power at power levels described by test sequence 1 generated in Step 1 of Section 4.3.1, conduct point SAR measurement versus time at peak location of the area scan determined in Step 2.i of this section. Once the measurement is done, extract instantaneous point SAR vs time data, *pointSAR(t)*, and convert it into instantaneous 1gSAR or 10gSAR vs. time using Eq. (2a), re-written below:

$$1g_or_10gSAR(t) = \frac{pointSAR(t)}{pointSAR_P_{limit}} * 1g_or_10gSAR_P_{limit}$$

where, *pointSAR_P_{limit}* is the value determined in Step 2.i, and *pointSAR(t)* is the instantaneous point SAR measured in Step 2.ii, *1g_or_10gSAR_P_{limit}* is the measured 1gSAR or 10gSAR value listed in Part 1 report.

- iii Perform 100s running average to determine time-averaged 1gSAR or 10gSAR versus time.
- iv Make one plot containing: (a) time-averaged 1gSAR or 10gSAR versus time determined in Step 2.iii of this section, (b) FCC limit of 1.6 W/kg for 1gSAR or 4.0 W/kg for 10gSAR.
- v Repeat 2.ii ~ 2.iv for test sequence 2 generated in Step 1 of Section 4.3.1.
- vi Repeat 2.i ~ 2.v for all the technologies and bands selected in Section 4.2.1.

The time-averaging validation criteria for SAR measurement is that, at all times, the time-averaged 1gSAR or 10gSAR versus time shall not exceed FCC limit of 1.6 W/kg for 1gSAR or 4.0 W/kg for 10gSAR (i.e., Eq. (2b)).

FCC ID: BCGA2899	PART 2 RF EXPOSURE EVALUATION REPORT	Approved by: Technical Manager
Document S/N: 1C2311270066-03.BCG	DUT Type: Tablet Device	Page 23 of 66

5 MEASUREMENT TEST SETUP (FREQ < 6 GHZ)

5.1 Conducted Measurement Test setup

Legacy Test Setup

The Rohde & Schwarz CMW500 callbox was used in this test. The test setup schematic is shown in Figure 5-1a (Appendix D – Test Setup Photo 1) for measurements with a single antenna of DUT, in Figure 5-1d (Appendix D – Test Setup Photo 5) for measurements involving Inter-band ULCA, and in Figure 5-1b (Appendix D – Test Setup Photo 3) for measurements involving antenna switch. For single antenna measurement, one port (RF1 COM) of the callbox is connected to the RF port of the DUT using a directional coupler. For technology/antenna switching measurements, one port (RF1 COM) of the callbox used for signaling two different technologies is connected to a combiner, which is in turn connected to a directional coupler. The other end of the directional coupler is connected to a splitter to connect to two RF ports of the DUT corresponding to the two antennas of interest. For Inter-band ULCA measurements, two ports, (RF1 COM & RF3 COM) of the callbox used for signaling the PCC band and SCC band respectively are each connected to the PCC and SCC RF ports of the DUT using two directional couplers, shown in Figure 5-1d (Appendix D – Test Setup Photo 5). In the setups, power meter is used to tap the directional coupler for measuring the conducted output power of the DUT.

All the path losses from RF port of DUT to the callbox RF COM port and to the power meter are calibrated and automatically entered as offsets in the callbox and the power meter via test scripts on the PC used to control callbox and power meter.

Sub6 NR test setup:

The Keysight UXM callbox was used in this test. The test setup schematic is the same as the Legacy Test Setup shown in Figure 5-1a (Appendix D – Test Setup Photo 2). One port of the callbox is connected to the RF port of the DUT using a directional coupler. In the setup, the power meter is used to tap the directional coupler for measuring the conducted output power of the DUT.

All the path losses from RF port of DUT to the callbox RF COM port and to the power meter are calibrated and automatically entered as offsets in the callbox and the power meter via test scripts on the PC used to control callbox and power meter.

LTE+Sub6 NR test setup:

LTE conducted port and Sub6 NR conducted port are different on this EUT, therefore, the LTE and Sub6 NR signals for power meter measurement are performed on separate paths as shown below in Figure 5-1c (Appendix D – Test Setup Photo 4).

All the path losses from RF port of DUT to the callbox RF COM port and to the power meter are calibrated and automatically entered as offsets in the callbox and the power meter via test scripts on the PC used to control callbox and power meter.

FCC ID: BCGA2899	PART 2 RF EXPOSURE EVALUATION REPORT	Approved by: Technical Manager
Document S/N: 1C2311270066-03.BCG	DUT Type: Tablet Device	Page 24 of 66

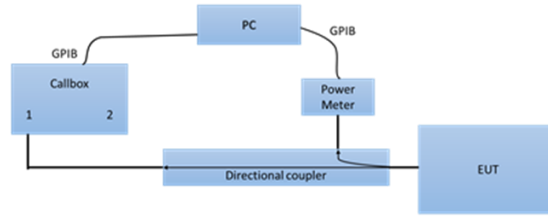

(a) Appendix D – Test Setup Photo 1 and 2

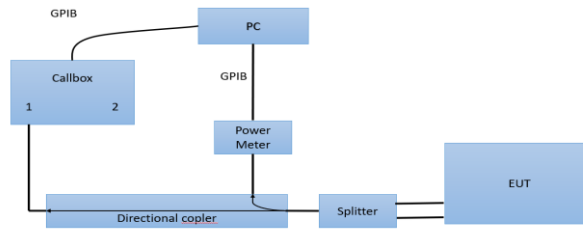

(b) Appendix D – Test Setup Photo 3

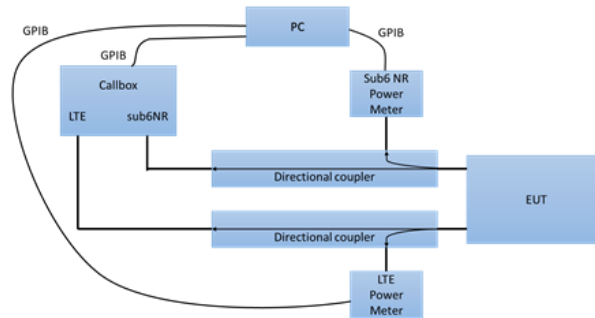

(c) Appendix D – Test Setup Photo 4

FCC ID: BCGA2899	PART 2 RF EXPOSURE EVALUATION REPORT	Approved by: Technical Manager
Document S/N: 1C2311270066-03.BCG	DUT Type: Tablet Device	Page 25 of 66

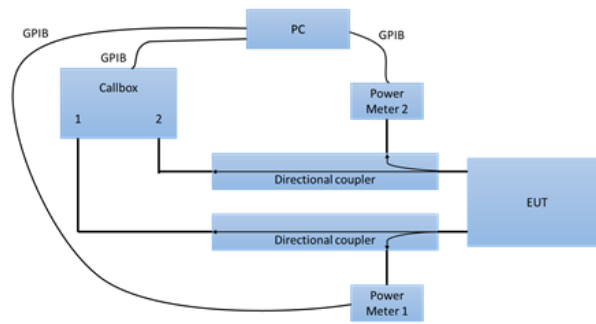

(d)Appendix D – Test Setup Photo 5

**Figure 5-1
Conducted power measurement setup**

Both the callbox and power meter are connected to the PC using GPIB cables. Two test scripts are custom made for automation, and the test duration set in the test scripts is 500 seconds.

For time-varying Tx power measurement, the PC runs the 1st test script to send GPIB commands to control the callbox’s requested power versus time, while at the same time to record the conducted power measured at DUT RF port using the power meter. The commands sent to the callbox to request power are:

- 0dBm for 100 seconds
- test sequence 1 or test sequence 2 (defined in Section 4.1 and generated in Section 4.2.1), for 360 seconds.
- stay at the last power level of test sequence 1 or test sequence 2 for the remaining time.

Power meter readings are periodically recorded every 100ms. A running average of this measured Tx power over 100 seconds is performed in the post-data processing to determine the 100s-time averaged power.

For call drop, technology/band/antenna switch, and DSI switch tests, after the call is established, the callbox is set to request the DUT’s Tx power at 0dBm for 100 seconds while simultaneously starting the 2nd test script runs at the same time to start recording the Tx power measured at DUT RF port using the power meter. After the initial 100 seconds since starting the Tx power recording, the callbox is set to request maximum power from the DUT for the rest of the test. Note that the call drop/re-establish, or technology/band/antenna switch or DSI switch is manually performed when the Tx power of DUT is at $P_{reserve}$ level. See Section 4.3 for detailed test procedure of call drop test, technology/band/antenna switch test and DSI switch test.

5.2 SAR Measurement setup

The measurement setup is similar to normal SAR measurements as described in the Part 1 Test Report. The difference in SAR measurement setup for time averaging feature validation is that the callbox is signaling in close loop power control mode (instead of requesting maximum power in open loop control mode) and callbox is connected to the PC using GPIB so that the test script executed on PC can send GPIB commands to control the callbox’s requested power over time

FCC ID: BCGA2899	PART 2 RF EXPOSURE EVALUATION REPORT	Approved by: Technical Manager
Document S/N: 1C2311270066-03.BCG	DUT Type: Tablet Device	Page 26 of 66

(test sequence). The same test script used in conducted setup for time-varying Tx power measurements is also used in this section for running the test sequences during SAR measurements, and the recorded values from the disconnected power meter by the test script were discarded.

As mentioned in Section 4.4, for DUT to follow TPC command sent from the callbox wirelessly, the “path loss” between callbox antenna and the DUT needs to be very well calibrated. Since the SAR chamber is in uncontrolled environment, precautions must be taken to minimize the environmental influences on “path loss”. Similarly, in the case of time-varying SAR measurements in Sub6 NR (with LTE as anchor), “path loss” between callbox antenna and the EUT needs to be carefully calibrated for both LTE link as well as for Sub6 NR link.

The DUT is placed in worst-case position according to Table 6-2.

FCC ID: BCGA2899	PART 2 RF EXPOSURE EVALUATION REPORT	Approved by: Technical Manager
Document S/N: 1C2311270066-03.BCG	DUT Type: Tablet Device	Page 27 of 66

6 TEST CONFIGURATIONS (FREQ < 6 GHZ)

6.1 WWAN (sub-6) transmission

The P_{limit} values, corresponding to 0.8 W/kg (1gSAR) of SAR_{design_target} , for technologies and bands supported by DUT are derived in Part 0 report and summarized in Table 6-1. Note all P_{limit} power levels entered in Table 6-1 correspond to average power levels after accounting for duty cycle in the case of TDD modulation schemes.

Table 6-1
 P_{limit} for supported technologies and bands (P_{limit} in EFS file)

Exposure Scenario:	Ant 1a	Ant 1a Maximum Tune up Output Power*	Ant 1b	Ant 1b Maximum Tune up Output Power*	Ant 2	Ant 2 Maximum Tune up Output Power*	Ant 3a	Ant 3a Maximum Tune up Output Power*	Ant 3b	Ant 3b Maximum Tune up Output Power*	Ant 4	Ant 4 Maximum Tune up Output Power*	
	Averaging Volume:		1g		1g		1g		1g		1g		1g
	Spacing:		0 mm		0 mm		0 mm		0 mm		0 mm		0 mm
DSI:	1		1		1		1		1		1		
Technology/Band	Plimit corresponding to 0.8 W/kg	Pmax	Plimit corresponding to 0.8 W/kg	Pmax	Plimit corresponding to 0.8 W/kg	Pmax	Plimit corresponding to 0.8 W/kg	Pmax	Plimit corresponding to 0.8 W/kg	Pmax	Plimit corresponding to 0.8 W/kg	Pmax	
UMTS 850	N/A	N/A	N/A	N/A	18.80	24.00	N/A	N/A	N/A	N/A	19.00	25.00	
UMTS 1750	N/A	N/A	12.00	22.00	14.50	23.00	N/A	N/A	12.50	24.00	14.60	25.00	
UMTS 1900	N/A	N/A	10.90	22.00	14.60	23.00	N/A	N/A	12.00	24.00	13.70	25.00	
LTE Band 71	N/A	N/A	N/A	N/A	20.20	24.00	N/A	N/A	N/A	N/A	20.00	25.00	
LTE Band 12	N/A	N/A	N/A	N/A	19.30	24.00	N/A	N/A	N/A	N/A	19.10	25.00	
LTE Band 17	N/A	N/A	N/A	N/A	19.30	24.00	N/A	N/A	N/A	N/A	19.10	25.00	
LTE Band 13	N/A	N/A	N/A	N/A	19.20	24.00	N/A	N/A	N/A	N/A	20.80	25.00	
LTE Band 14	N/A	N/A	N/A	N/A	19.20	24.00	N/A	N/A	N/A	N/A	20.80	25.00	
LTE Band 26	N/A	N/A	N/A	N/A	18.80	24.00	N/A	N/A	N/A	N/A	19.00	25.00	
LTE Band 5	N/A	N/A	N/A	N/A	18.80	24.00	N/A	N/A	N/A	N/A	19.00	25.00	
LTE Band 5 ULCA	N/A	N/A	N/A	N/A	18.80	24.00	N/A	N/A	N/A	N/A	19.00	25.00	
LTE Band 4	N/A	N/A	12.00	25.00	14.50	24.50	N/A	N/A	12.50	24.50	14.60	25.00	
LTE Band 66	N/A	N/A	12.00	25.00	14.50	24.80	N/A	N/A	12.50	24.80	14.60	25.00	
LTE Band 2	N/A	N/A	10.90	22.00	14.60	23.00	N/A	N/A	12.00	24.00	13.70	25.00	
LTE Band 25	N/A	N/A	10.90	22.00	14.60	23.00	N/A	N/A	12.00	24.00	13.70	25.00	
LTE Band 30	N/A	N/A	12.30	21.50	13.00	20.05	N/A	N/A	12.10	21.80	14.50	25.00	
LTE Band 7	N/A	N/A	11.40	21.50	11.30	22.00	N/A	N/A	11.10	24.00	10.80	25.00	
LTE Band 7 ULCA	N/A	N/A	11.40	21.50	11.30	22.00	N/A	N/A	11.10	24.00	10.80	25.00	
LTE Band 38	N/A	N/A	13.50	25.00	13.90	25.00	N/A	N/A	14.00	25.00	12.60	25.00	
LTE Band 38 ULCA	N/A	N/A	13.50	25.00	13.90	25.00	N/A	N/A	14.00	25.00	12.60	25.00	
LTE Band 41 (PC3)	N/A	N/A	11.5	23.0	11.9	23.0	N/A	N/A	12.0	23.0	10.6	23.0	
LTE Band 41 (PC3) ULCA	N/A	N/A	11.5	23.0	11.9	23.0	N/A	N/A	12.0	23.0	8.6	23.0	
LTE Band 41 (PC2)	N/A	N/A	11.5	23.4	11.9	22.4	N/A	N/A	12.0	23.9	10.6	24.4	
LTE Band 41 (PC2) ULCA	N/A	N/A	11.5	23.4	11.9	22.4	N/A	N/A	12.0	23.9	10.6	24.4	
LTE Band 48	9.7	18.4	N/A	N/A	9.9	15.7	9.7	16.6	N/A	N/A	9.9	16.9	
LTE Band 48 ULCA	9.7	18.4	N/A	N/A	9.9	15.7	9.7	16.6	N/A	N/A	9.9	16.9	
NR Band n71	N/A	N/A	N/A	N/A	20.20	24.00	N/A	N/A	N/A	N/A	20.00	25.00	
NR Band n12	N/A	N/A	N/A	N/A	19.30	24.00	N/A	N/A	N/A	N/A	19.10	25.00	
NR Band n14	N/A	N/A	N/A	N/A	19.20	24.00	N/A	N/A	N/A	N/A	20.80	25.00	
NR Band n26	N/A	N/A	N/A	N/A	18.80	24.00	N/A	N/A	N/A	N/A	19.00	25.00	
NR Band n5	N/A	N/A	N/A	N/A	18.80	24.00	N/A	N/A	N/A	N/A	19.00	25.00	
NR Band n70	N/A	N/A	12.00	25.00	14.50	24.50	N/A	N/A	12.50	24.50	14.60	25.00	
NR Band n66	N/A	N/A	12.00	25.00	14.50	24.80	N/A	N/A	12.50	24.80	14.60	25.00	
NR Band n2	N/A	N/A	10.90	22.00	14.60	23.00	N/A	N/A	12.00	24.00	13.70	25.00	
NR Band n25	N/A	N/A	10.90	22.00	14.60	23.00	N/A	N/A	12.00	24.00	13.70	25.00	
NR Band n30	N/A	N/A	12.30	21.50	13.00	20.05	N/A	N/A	12.10	21.80	14.50	25.00	
NR Band n7	N/A	N/A	11.40	21.50	11.30	22.00	N/A	N/A	11.10	24.00	10.80	25.00	
NR Band n41 (PC3)	N/A	N/A	12.00	25.00	12.00	25.00	N/A	N/A	11.80	25.00	10.50	25.00	
NR Band n41 (PC2)	N/A	N/A	12.00	28.00	12.00	27.50	N/A	N/A	11.80	26.00	10.50	27.00	
NR Band n77 (PC3)	9.20	22.30	N/A	N/A	8.30	22.30	8.40	24.70	N/A	N/A	9.60	24.70	
NR Band n77 (PC2)	9.20	22.50	N/A	N/A	8.30	22.50	8.40	26.50	N/A	N/A	9.60	26.00	
NR Band n48	9.70	20.40	N/A	N/A	9.90	17.70	10.00	18.60	N/A	N/A	10.00	18.90	

* Maximum tune up target power, P_{max} , is configured in NV settings in DUT to limit maximum transmitting power. This power is converted into peak power in NV settings for TDD schemes. The DUT maximum allowed output power is equal to $P_{max} + 0.7$ dB conducted power tolerance for frequencies under 3GHz and $P_{max} + 1$ dB conducted power tolerance for frequencies > 3GHz.

Note all Plimit EFS and maximum tune up output power Pmax levels entered in above Table correspond to average power levels after accounting for duty cycle in the case of TDD modulation schemes (for e.g., LTE TDD).

FCC ID: BCGA2899	PART 2 RF EXPOSURE EVALUATION REPORT	Approved by: Technical Manager
Document S/N: 1C2311270066-03.BCG	DUT Type: Tablet Device	Page 28 of 66

Based on selection criteria described in Section 4.2.1, the selected technologies/bands for testing time-varying test sequences are highlighted in yellow in Table 6-1. Per the manufacturer, the *Total_min_res_ratio* (dB) is set to 0.5dB in EFS and is used in Part 2 test.

The radio configurations used in Part 2 test for selected technologies, bands, DSIs and antennas are listed in Table 6-2. The corresponding worst-case radio configuration 1gSAR values for selected technology/band/DSI are extracted from Part 1 report and are listed in the last column of Table 6-2.

Based on equations (1a) and (2a), it is clear that Part 2 testing outcome is normalized quantity, which implies that it can be applied to any radio configuration within a selected technology/band/DSI. Thus, as long as applying the worst-case SAR obtained from the worst radio configuration in Part 1 testing to calculate time-varying SAR exposure in equations (1a) and (2a), the accuracy in compliance demonstration remains the same. Therefore, there may be some differences between the radio configuration selected for Part 2 testing and the radio configuration associated with worst-case SAR obtained in the Part 1 evaluation.

The measured P_{limit} for all the selected radio configurations are listed in below Table 6-2. P_{max} was also measured for radio configurations selected for testing time-varying Tx power transmission scenarios in order to generate test sequences following the test procedures in Section 4.1.

Table 6-2
Radio configurations selected for Part 2 test

Test Case #	Test Scenario	Tech	Band	Antenna	DSI	Channel	Frequency [MHz]	Test Configurations	SAR Exposure Scenario	Part 1 Worst Case Measured SAR at Plimit (W/kg)	EFS Plimit [dBm]	Tune-up Pmax [dBm]	Measured Plimit [dBm]	Measured Pmax [dBm]
1	Test Sequence 1	WCDMA	5	4	1	4183	836.5	RMC	Body	0.758	19.0	25.0	18.51	24.63
	-							Left edge, 0mm						
2	Test Sequence 1	WCDMA	2	1B	1	9400	1880	RMC	Body	0.838	10.9	22.0	10.97	22.08
	-							Back side, 0mm						
3	Test Sequence 1	LTE	14	4	1	23330	793	QPSK	Body	0.740	20.8	25.0	20.27	24.60
	1/25/10 MHz BW							Back side, 0mm						
4	Test Sequence 1	LTE	48 PC3	1A	1	56207	3646.7	QPSK	Body	0.775	9.7	19.4	10.20	19.48
	1/1/20 MHz BW							Back side, 0mm						
5	Test Sequence 1	NR	n71	2	1	136100	680.5	DFT-S-OFDM, QPSK	Body	0.769	20.2	24.0	19.82	23.78
	1/137/100 MHz BW							Back side, 0mm						
6	Test Sequence 1	NR	n77 PC3 / SA	2	1	650000	3750	DFT-S-OFDM, QPSK	Body	0.813	8.3	20.3	8.30	17.98
	1/137/100 MHz BW							Right edge, 0mm						
7	Call Drop	NR	n77 PC3 / SA	2	1	650000	3750	DFT-S-OFDM, QPSK	Body	0.813	8.3	20.3	8.30	17.98
	1/137/100 MHz BW							Right edge, 0mm						
8	Change in Technology/Band	LTE	14	4	1	23330	793	QPSK	Body	0.740	20.8	25.0	20.27	24.60
		WCDMA	2	1B	1	9400	1880	RMC	Back side, 0mm					
9	Change in Antenna	LTE	25	4	1	26365	1882.5	QPSK	Body	0.701	13.7	25.0	13.86	25.34
				1B	1	26365	1882.5	QPSK	Back side, 0mm					
10	Change in Time Window	LTE	5	2	1	20525	836.5	QPSK	Body	0.921	18.8	24.0	18.32	23.62
				48 PC3	2	1	56207	3646.7	QPSK					
11	SAR Exposure Switching (EN-DC) Same Time Window	LTE	66	4	1	132322	1745	QPSK	Body	0.703	14.6	25.0	14.81	25.23
		Sub6 NR	n41 PC3 / NSA	2	1	518598	2593	DFT-S-OFDM, QPSK	Back side, 0mm					
12	SAR Exposure Switching (EN-DC) Different Time Window	LTE	66	4	1	132322	1745	QPSK	Body	0.703	14.6	25.0	14.81	25.23
		Sub6 NR	n77 PC3 / NSA	2	1	650000	3750	DFT-S-OFDM, QPSK	Right edge, 0mm					
13	SAR Exposure Switching (Interband ULCA)	LTE	5 / PCC	4	1	20525	1882.5	QPSK	Body	0.897	19.0	25.0	18.71	24.81
			2 / SCC	1B	1	18900	1880	QPSK	Back side, 0mm					

Note: The device conducted power tolerance of P_{max} is +0.7/-1.0 dB for freq < 3GHz and +/- 1.0 dB for freq > 3GHz as provided by manufacturer.

FCC ID: BCGA2899	PART 2 RF EXPOSURE EVALUATION REPORT	Approved by: Technical Manager
Document S/N: 1C2311270066-03.BCG	DUT Type: Tablet Device	Page 29 of 66

Note: The maximum power of n77 is limited during time-averaged SAR testing.

Note: NR TDD is tested on an active call with a 63.3% duty cycle.

Note: Multi-Tx factor is set to 1.0 per the manufacturer.

Note: WLAN and BT Smart Tx time-averaging is disabled per the manufacturer.

Based on the selection criteria described in Section 4.2, the radio configurations for the Tx varying transmission test cases listed in Section 3 are:

1. Technologies and bands for time-varying Tx power transmission: The test case 1–6 listed in Table 6-2 are selected to test with the test sequences defined in Section 4.1 in both time-varying conducted power measurement and time-varying SAR measurement.
2. Technology and band for change in call test: NR n77 antenna 2, having the lowest P_{limit} among all technologies and bands (test case 7 in Table 6-2), is selected for performing the call drop test in conducted power setup.
3. Technologies and bands for change in technology test: Following the guidelines in Section 4.2.3, test case 8 in Table 6-2 is selected for handover test from a technology/band within one technology group (LTE Band 14 antenna 4), to a technology/band in the same DSI within another technology group (WCDMA Band 2 antenna 1B) in conducted power setup.
4. Technologies and bands for change in antenna: Based on selection criteria in Section 4.2.4, for a given technology and band, test case 9 in Table 6-2 is selected for antenna switch test by establishing a call in LTE Band 25 in antenna 4, and then handing over to antenna 1B in conducted power setup.
5. Technologies and bands for change in time-window: Based on selection criteria in Section 4.2.6, test case 10 in Table 6-2 is selected for time window switch between 60s window (LTE Band 48, Antenna 4) and 100s window (LTE Band 5, Antenna 2) in conducted power setup.
6. Technologies and bands for switch in SAR exposure: Based on selection criteria in Section 4.2.7 Scenario 1, test cases 11, 12, and 13 in Table 6-2 are selected for SAR exposure switching test in one of the supported simultaneous WWAN transmission scenario, i.e., LTE + Sub6 NR active in the same 100s time window, LTE + Sub6 NR active in different time windows, and LTE interband ULCA, in conducted power setup.

Note: This device does not support multiple DSI states corresponding to portable use conditions, therefore, no change in DSI and exposure category switch testing were performed.

FCC ID: BCGA2899	PART 2 RF EXPOSURE EVALUATION REPORT	Approved by: Technical Manager
Document S/N: 1C2311270066-03.BCG	DUT Type: Tablet Device	Page 30 of 66

6.2 EFS v19 Verification

Per Qualcomm's 80-w2112-5 document, embedded file system (EFS) version 19 products are required to be verified for Smart Tx generation for relevant MCC settings. It was confirmed that this DUT contains embedded file system (EFS) version 19 configured for Smart Tx second generation (GEN2) for Sub6 with MCC settings for the US market.

EFS v19 Generation	MCC
GEN2_Sub6	310

FCC ID: BCGA2899	PART 2 RF EXPOSURE EVALUATION REPORT	Approved by: Technical Manager
Document S/N: 1C2311270066-03.BCG	DUT Type: Tablet Device	Page 31 of 66

7 CONDUCTED TX CASES (FREQ < 6 GHZ)

7.1 Time-varying Tx Power Case

The measurement setup is shown in Figure 5-1. The purpose of the time-varying Tx power measurement is to demonstrate the effectiveness of power limiting enforcement and that the time-averaged Tx power when represented in time-averaged 1gSAR values does not exceed FCC limit as shown in Eq. (1a) and (1b), rewritten below:

$$1g_SAR(t) = \frac{conducted_Tx_power(t)}{conducted_Tx_power_P_{limit}} * 1g_SAR_P_{limit} \quad (1a)$$

$$\frac{\frac{1}{T_{SAR}} \int_{t-T_{SAR}}^t 1gSAR(t) dt}{FCC\ SAR\ limit} \leq 1 \quad (1b)$$

where, $conducted_Tx_power(t)$, $conducted_Tx_power_P_{limit}$, and $1g_SAR_P_{limit}$ correspond to the measured instantaneous conducted Tx power, measured conducted Tx power at P_{limit} , and measured 1gSAR values at P_{limit} reported in Part 1 test (listed in Table 6-2 of this report as well).

Following the test procedure in Section 4.3, the conducted Tx power measurement for all selected configurations are reported in this section. In all the conducted Tx power plots, the green curve represents time-averaged power and red line represents the conducted power limit that corresponds to FCC limit of 1.6 W/kg for 1gSAR.

Similarly, in all the 1gSAR plots (when converted using Eq. (1a)), the green curve represents the 100s/60s-time averaged 1gSAR value calculated based on instantaneous 1gSAR; and the red line limit represents the FCC limit of 1.6 W/kg for 1gSAR.

Time-varying Tx power measurements were conducted on test cases #1 ~ #6 in Table 6-2, by generating test sequence 1 and test sequence 2 given in APPENDIX E: using measured P_{limit} and measured P_{max} (last two columns of Table 6-2) for each of these test cases. Measurement results for test cases #1 ~ #6 are given in Sections 7.1.1-7.1.6.

FCC ID: BCGA2899	PART 2 RF EXPOSURE EVALUATION REPORT	Approved by: Technical Manager
Document S/N: 1C2311270066-03.BCG	DUT Type: Tablet Device	Page 32 of 66

7.1.1 WCDMA Band 5, Antenna 4

Test result for test sequence 1:

Time-averaged conducted Tx power is converted/calculated into time-averaged 1gSAR using Equation (1a) and plotted below to demonstrate that the time-averaged 1gSAR versus time does not exceed the FCC limit of 1.6 W/kg for 1gSAR:

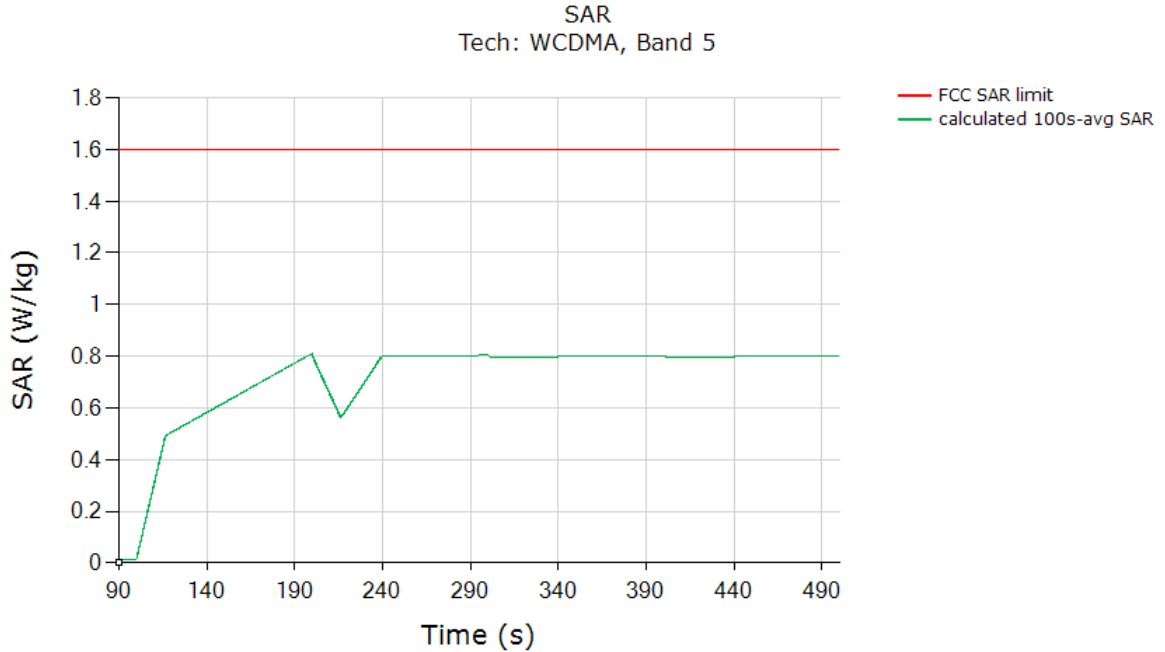

	(W/kg)
FCC 1gSAR limit	1.6
Max 100s-time averaged 1gSAR (green curve)	0.810
Validated: Max time averaged SAR (green curve) is within 1 dB device Smart Tx uncertainty of measured SAR at P_{limit} (Part 1 Worst Case SAR at Plim column in Table 6-2).	

FCC ID: BCGA2899	PART 2 RF EXPOSURE EVALUATION REPORT	Approved by: Technical Manager
Document S/N: 1C2311270066-03.BCG	DUT Type: Tablet Device	Page 33 of 66

Test result for test sequence 2:

Time-averaged conducted Tx power is converted/calculated into time-averaged 1gSAR using Equation (1a) and plotted below to demonstrate that the time-averaged 1gSAR versus time does not exceed the FCC limit of 1.6 W/kg for 1gSAR:

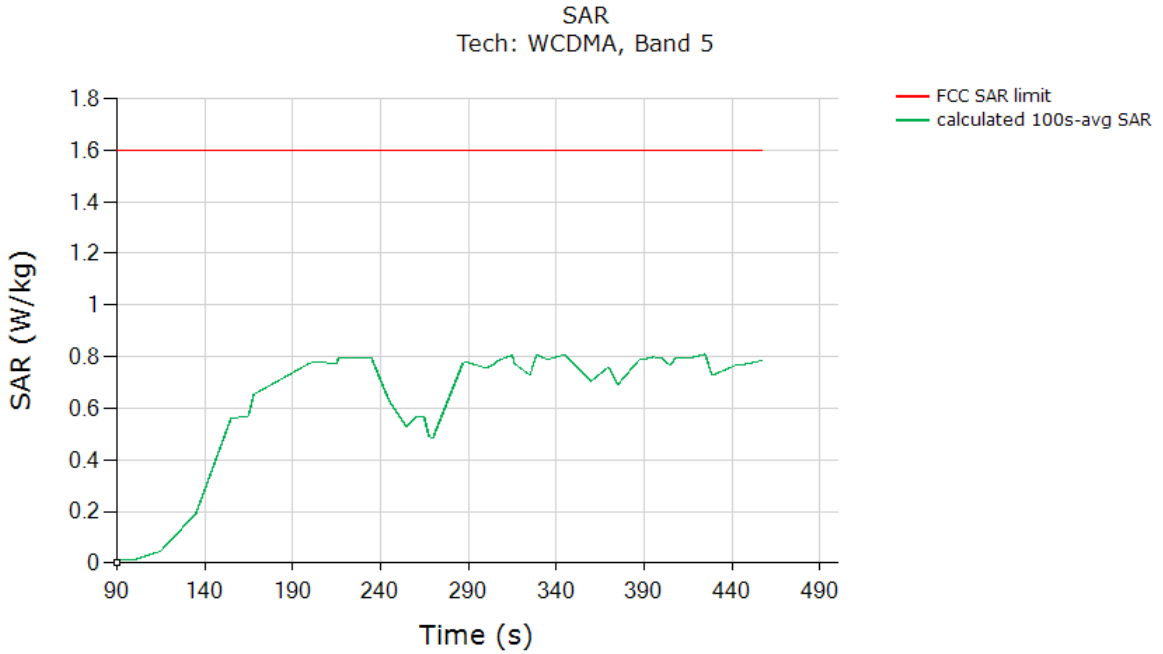

	(W/kg)
FCC 1gSAR limit	1.6
Max 100s-time averaged 1gSAR (green curve)	0.808
Validated: Max time averaged SAR (green curve) is within 1 dB device Smart Tx uncertainty of measured SAR at P_{limit} (Part 1 Worst Case SAR at Plim column in Table 6-2).	

FCC ID: BCGA2899	PART 2 RF EXPOSURE EVALUATION REPORT	Approved by: Technical Manager
Document S/N: 1C2311270066-03.BCG	DUT Type: Tablet Device	Page 34 of 66

7.1.2

WCDMA Band 2, Antenna 1B

Test result for test sequence 1:

Time-averaged conducted Tx power is converted/calculated into time-averaged 1gSAR using Equation (1a) and plotted below to demonstrate that the time-averaged 1gSAR versus time does not exceed the FCC limit of 1.6 W/kg for 1gSAR:

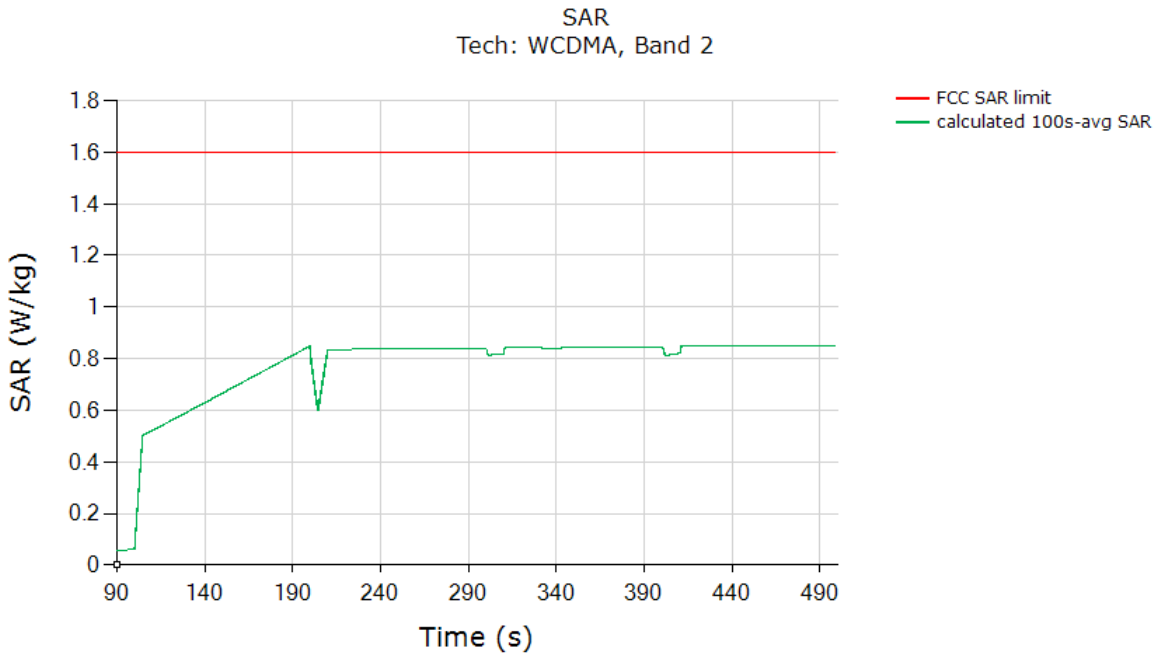

	(W/kg)
FCC 1gSAR limit	1.6
Max 100s-time averaged 1gSAR (green curve)	0.848
Validated: Max time averaged SAR (green curve) is within 1 dB device Smart Tx uncertainty of measured SAR at P_{limit} (Part 1 Worst Case SAR at Plim column in Table 6-2).	

FCC ID: BCGA2899	PART 2 RF EXPOSURE EVALUATION REPORT	Approved by: Technical Manager
Document S/N: 1C2311270066-03.BCG	DUT Type: Tablet Device	Page 35 of 66

Test result for test sequence 2:

Time-averaged conducted Tx power is converted/calculated into time-averaged 1gSAR using Equation (1a) and plotted below to demonstrate that the time-averaged 1gSAR versus time does not exceed the FCC limit of 1.6 W/kg for 1gSAR:

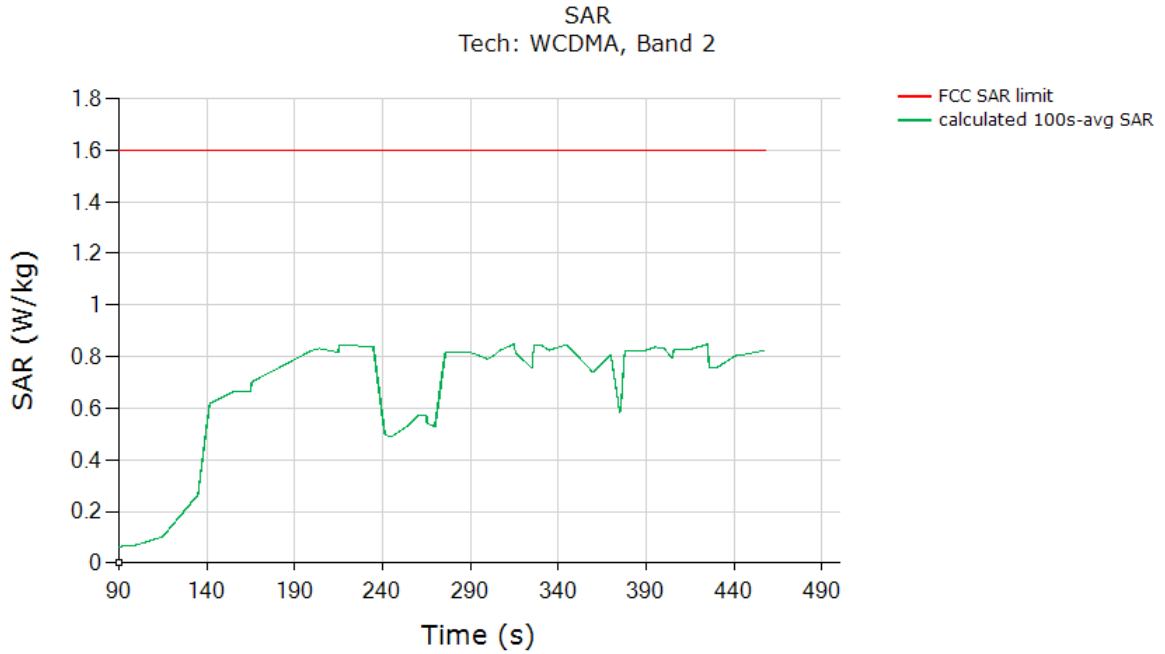

	(W/kg)
FCC 1gSAR limit	1.6
Max 100s-time averaged 1gSAR (green curve)	0.848
Validated: Max time averaged SAR (green curve) is within 1 dB device Smart Tx uncertainty of measured SAR at P_{limit} (Part 1 Worst Case SAR at Plim column in Table 6-2).	

FCC ID: BCGA2899	PART 2 RF EXPOSURE EVALUATION REPORT	Approved by: Technical Manager
Document S/N: 1C2311270066-03.BCG	DUT Type: Tablet Device	Page 36 of 66

7.1.3 LTE Band 14, Antenna 4

Test result for test sequence 1:

Time-averaged conducted Tx power is converted/calculated into time-averaged 1gSAR using Equation (1a) and plotted below to demonstrate that the time-averaged 1gSAR versus time does not exceed the FCC limit of 1.6 W/kg for 1gSAR:

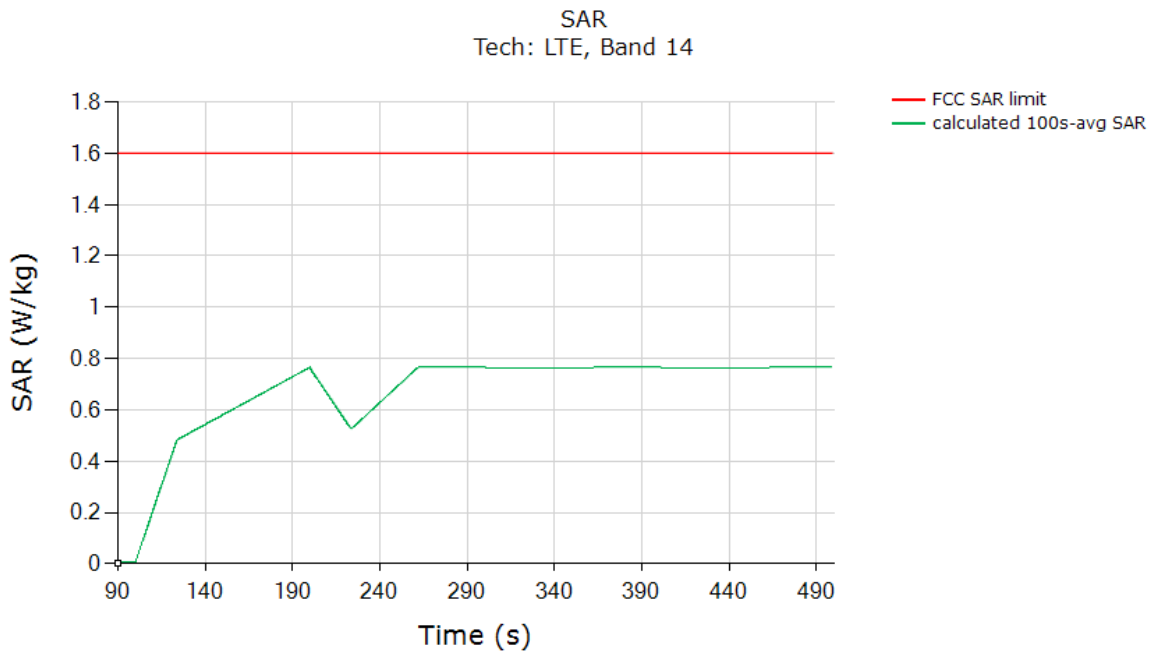

	(W/kg)
FCC 1gSAR limit	1.6
Max 100s-time averaged 1gSAR (green curve)	0.766
Validated: Max time averaged SAR (green curve) is within 1 dB device Smart Tx uncertainty of measured SAR at P_{limit} (Part 1 Worst Case SAR at Plim column in Table 6-2).	

FCC ID: BCGA2899	PART 2 RF EXPOSURE EVALUATION REPORT	Approved by: Technical Manager
Document S/N: 1C2311270066-03.BCG	DUT Type: Tablet Device	Page 37 of 66

Test result for test sequence 2:

Time-averaged conducted Tx power is converted/calculated into time-averaged 1gSAR using Equation (1a) and plotted below to demonstrate that the time-averaged 1gSAR versus time does not exceed the FCC limit of 1.6 W/kg for 1gSAR:

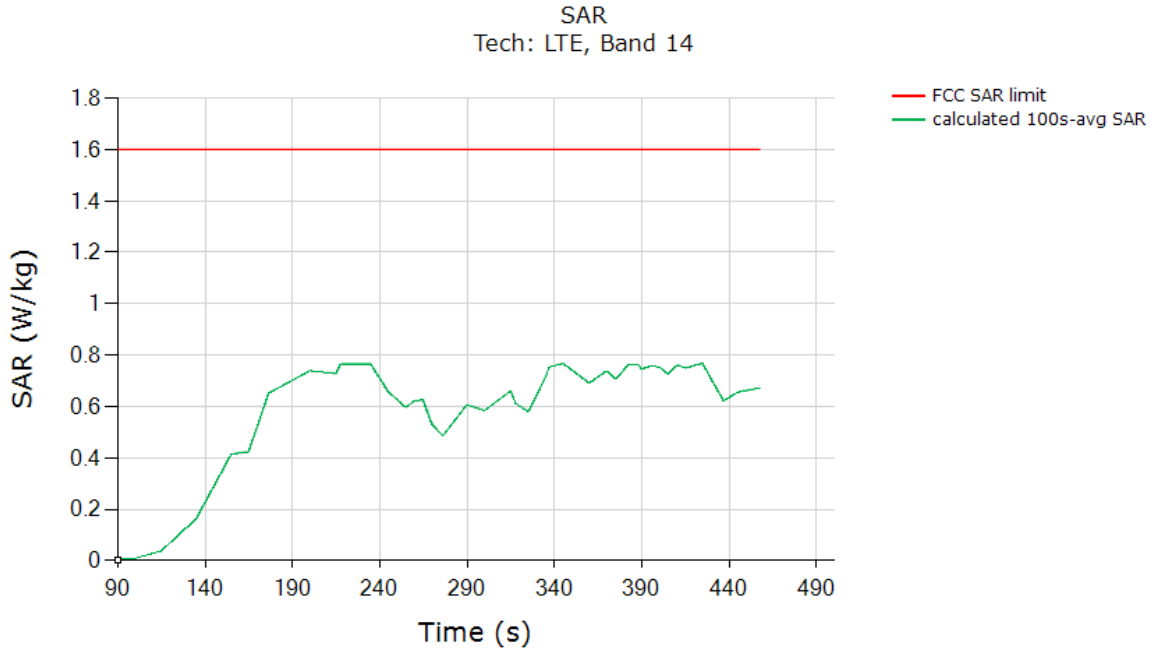

	(W/kg)
FCC 1gSAR limit	1.6
Max 100s-time averaged 1gSAR (green curve)	0.767
Validated: Max time averaged SAR (green curve) is within 1 dB device Smart Tx uncertainty of measured SAR at P_{limit} (I Part 1 Worst Case SAR at Plim column in Table 6-2).	

FCC ID: BCGA2899	PART 2 RF EXPOSURE EVALUATION REPORT	Approved by: Technical Manager
Document S/N: 1C2311270066-03.BCG	DUT Type: Tablet Device	Page 38 of 66

7.1.4 LTE Band 48, Antenna 1A

Test result for test sequence 1:

Time-averaged conducted Tx power is converted/calculated into time-averaged 1gSAR using Equation (1a) and plotted below to demonstrate that the time-averaged 1gSAR versus time does not exceed the FCC limit of 1.6 W/kg for 1gSAR:

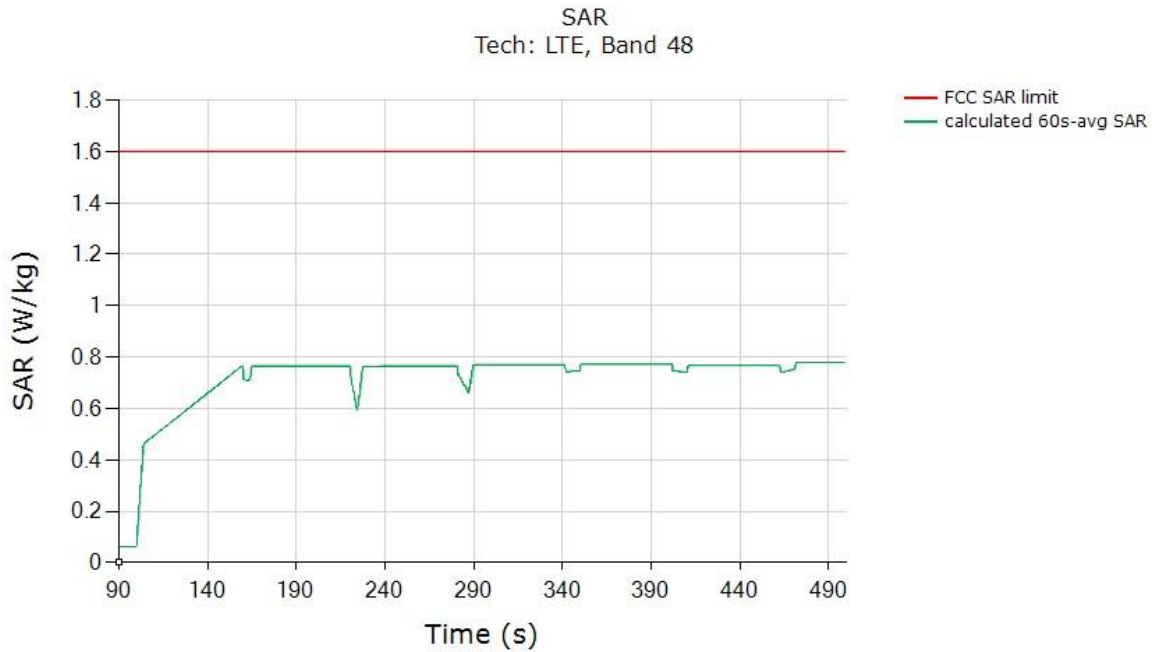

	(W/kg)
FCC 1gSAR limit	1.6
Max 60s-time averaged 1gSAR (green curve)	0.779
Validated: Max time averaged SAR (green curve) is within 1 dB device Smart Tx uncertainty of measured SAR at P_{limit} (Part 1 Worst Case SAR at Plim column in Table 6-2).	

FCC ID: BCGA2899	PART 2 RF EXPOSURE EVALUATION REPORT	Approved by: Technical Manager
Document S/N: 1C2311270066-03.BCG	DUT Type: Tablet Device	Page 39 of 66

Test result for test sequence 2:

Time-averaged conducted Tx power is converted/calculated into time-averaged 1gSAR using Equation (1a) and plotted below to demonstrate that the time-averaged 1gSAR versus time does not exceed the FCC limit of 1.6 W/kg for 1gSAR:

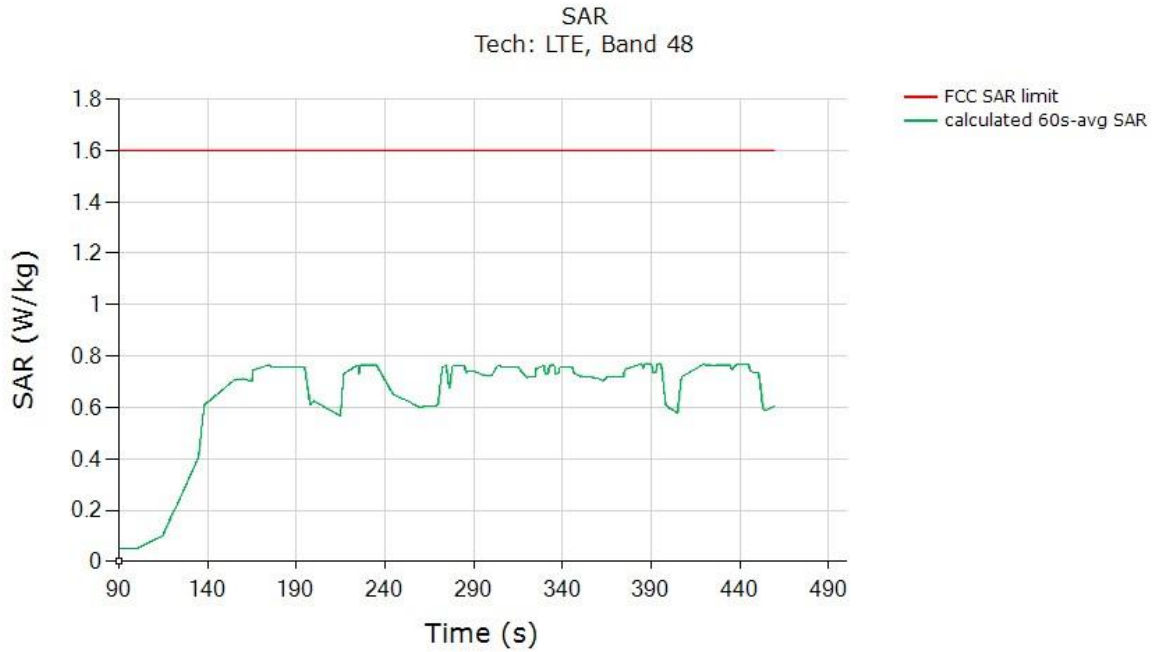

	(W/kg)
FCC 1gSAR limit	1.6
Max 60s-time averaged 1gSAR (green curve)	0.769
<p>Validated: Max time averaged SAR (green curve) is within 1 dB device Smart Tx uncertainty of measured SAR at P_{limit} (Part 1 Worst Case SAR at Plim column in Table 6-2).</p>	

FCC ID: BCGA2899	PART 2 RF EXPOSURE EVALUATION REPORT	Approved by: Technical Manager
Document S/N: 1C2311270066-03.BCG	DUT Type: Tablet Device	Page 40 of 66

7.1.5 NR n71, Antenna 2

Test result for test sequence 1:

Time-averaged conducted Tx power is converted/calculated into time-averaged 1gSAR using Equation (1a) and plotted below to demonstrate that the time-averaged 1gSAR versus time does not exceed the FCC limit of 1.6 W/kg for 1gSAR:

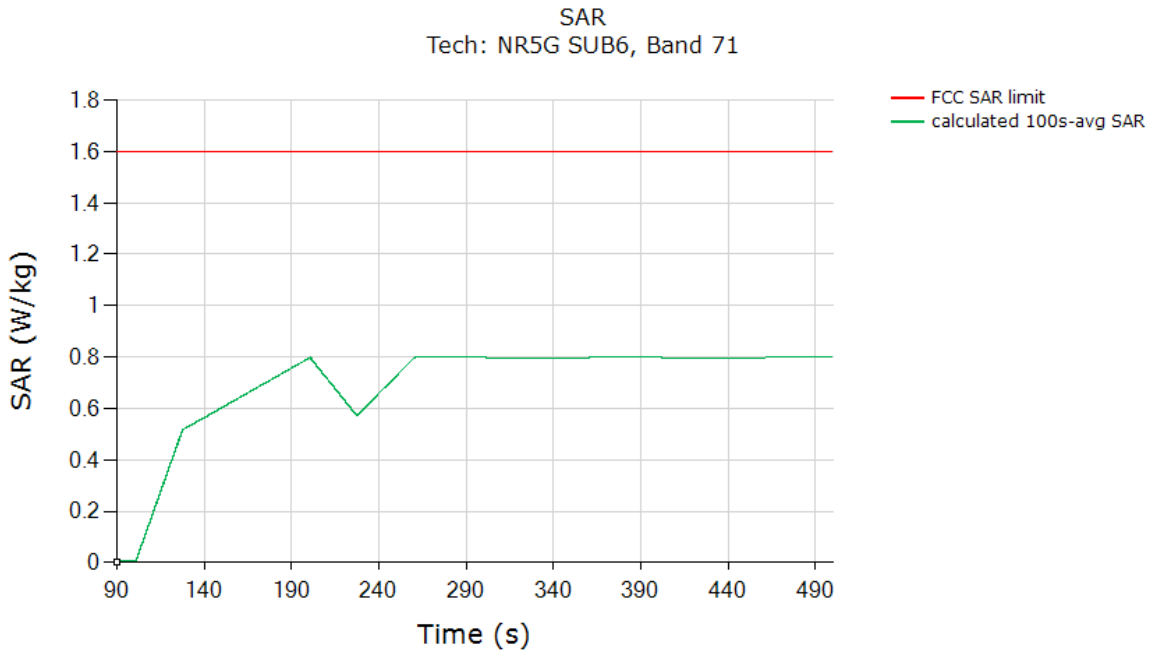

	(W/kg)
FCC 1gSAR limit	1.6
Max 100s-time averaged 1gSAR (green curve)	0.799
Validated: Max time averaged SAR (green curve) is within 1 dB device Smart Tx uncertainty of measured SAR at P_{limit} (Part 1 Worst Case SAR at Plim column in Table 6-2).	

FCC ID: BCGA2899	PART 2 RF EXPOSURE EVALUATION REPORT	Approved by: Technical Manager
Document S/N: 1C2311270066-03.BCG	DUT Type: Tablet Device	Page 41 of 66

Test result for test sequence 2:

Time-averaged conducted Tx power is converted/calculated into time-averaged 1gSAR using Equation (1a) and plotted below to demonstrate that the time-averaged 1gSAR versus time does not exceed the FCC limit of 1.6 W/kg for 1gSAR:

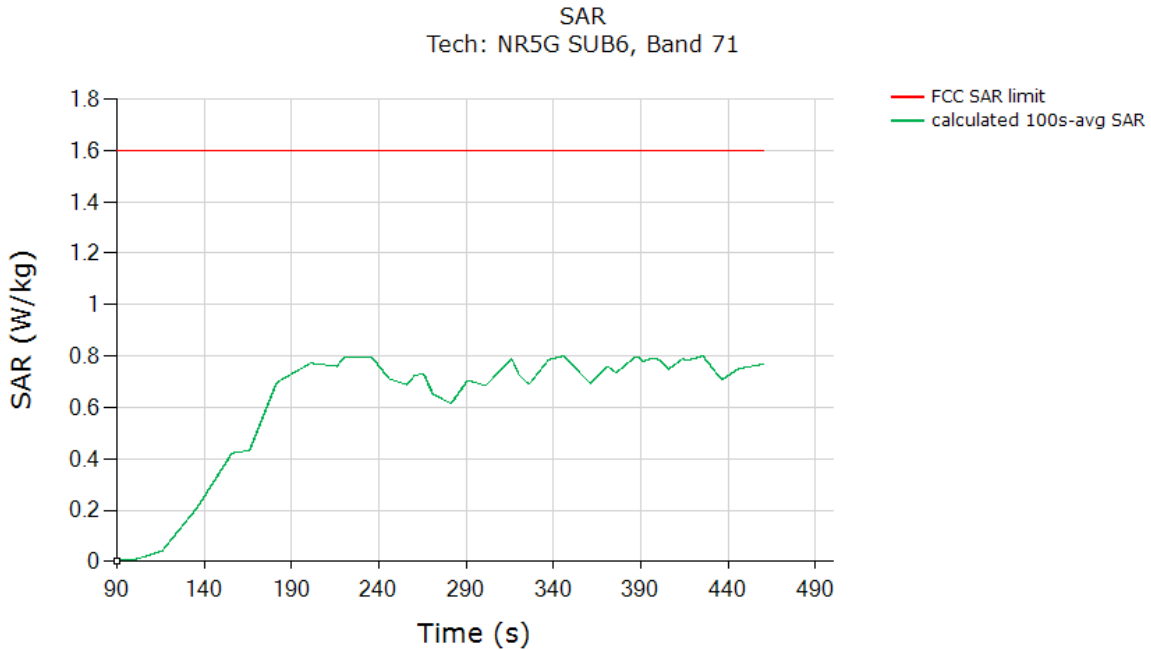

	(W/kg)
FCC 1gSAR limit	1.6
Max 100s-time averaged 1gSAR (green curve)	0.800
Validated: Max time averaged SAR (green curve) is within 1 dB device Smart Tx uncertainty of measured SAR at P_{limit} (Part 1 Worst Case SAR at Plim column in Table 6-2).	

FCC ID: BCGA2899	PART 2 RF EXPOSURE EVALUATION REPORT	Approved by: Technical Manager
Document S/N: 1C2311270066-03.BCG	DUT Type: Tablet Device	Page 42 of 66

7.1.6 NR n77 SA, Antenna 2

Test result for test sequence 1:

Time-averaged conducted Tx power is converted/calculated into time-averaged 1gSAR using Equation (1a) and plotted below to demonstrate that the time-averaged 1gSAR versus time does not exceed the FCC limit of 1.6 W/kg for 1gSAR:

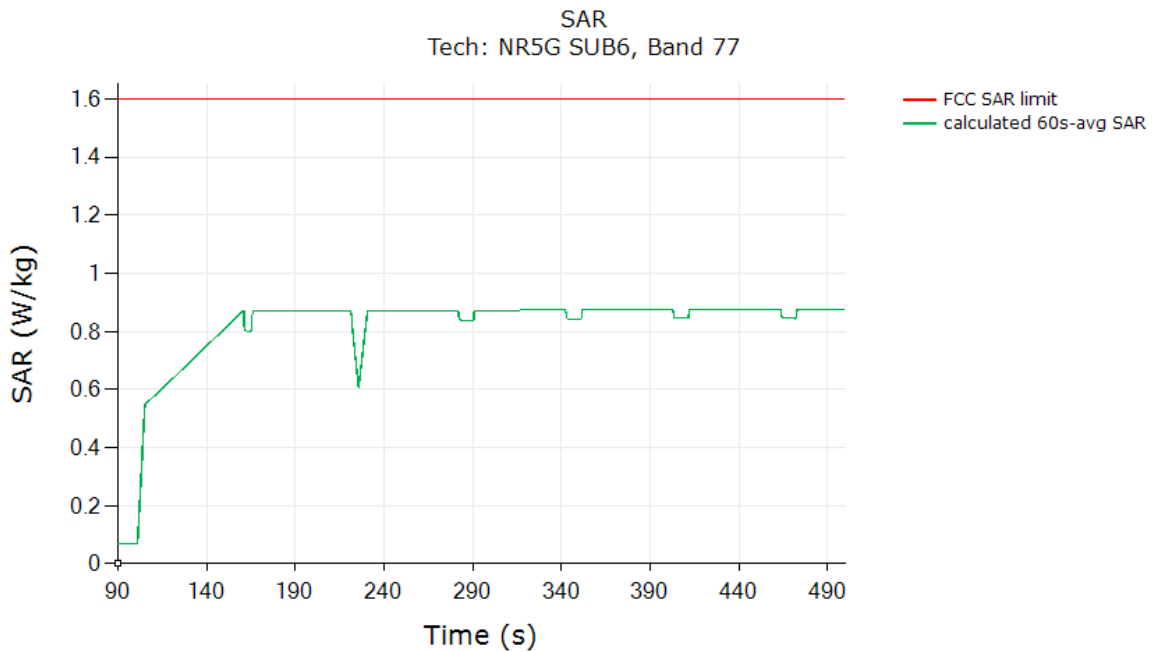

	(W/kg)
FCC 1gSAR limit	1.6
Max 60s-time averaged 1gSAR (green curve)	0.877
Validated: Max time averaged SAR (green curve) is within 1 dB device Smart Tx uncertainty of measured SAR at P_{limit} (Part 1 Worst Case SAR at Plim column in Table 6-2).	

FCC ID: BCGA2899	PART 2 RF EXPOSURE EVALUATION REPORT	Approved by: Technical Manager
Document S/N: 1C2311270066-03.BCG	DUT Type: Tablet Device	Page 43 of 66

Test result for test sequence 2:

Time-averaged conducted Tx power is converted/calculated into time-averaged 1gSAR using Equation (1a) and plotted below to demonstrate that the time-averaged 1gSAR versus time does not exceed the FCC limit of 1.6 W/kg for 1gSAR:

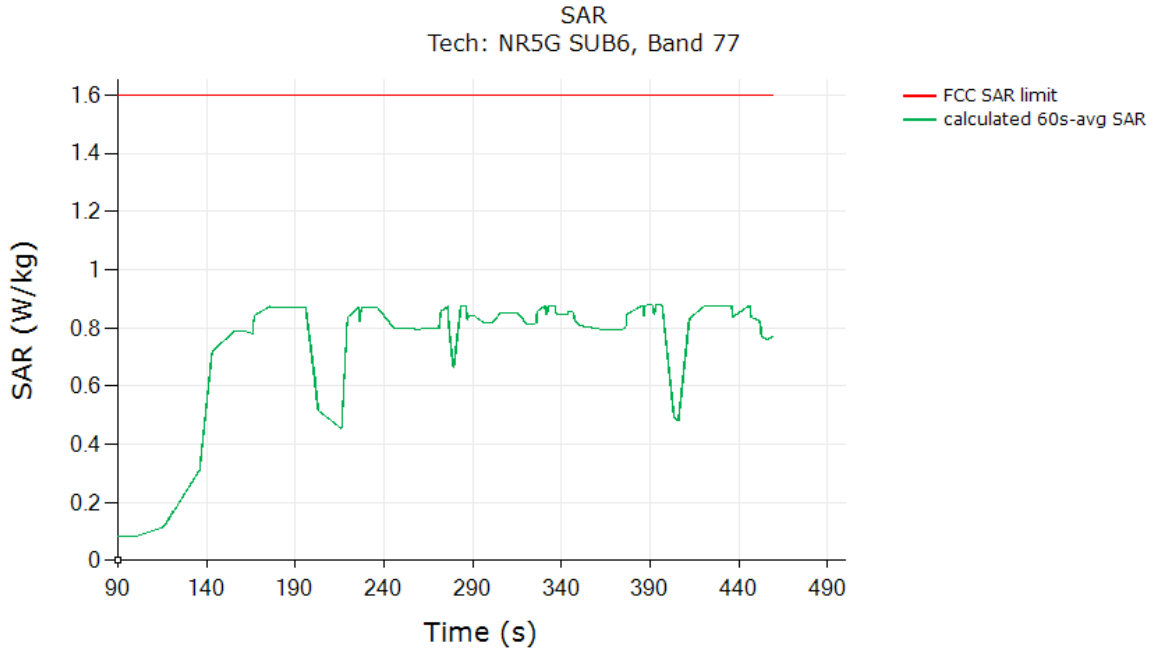

	(W/kg)
FCC 1gSAR limit	1.6
Max 60s-time averaged 1gSAR (green curve)	0.877
Validated: Max time averaged SAR (green curve) is within 1 dB device Smart Tx uncertainty of measured SAR at P_{limit} (Part 1 Worst Case SAR at Plim column in Table 6-2).	

FCC ID: BCGA2899	PART 2 RF EXPOSURE EVALUATION REPORT	Approved by: Technical Manager
Document S/N: 1C2311270066-03.BCG	DUT Type: Tablet Device	Page 44 of 66

7.2 Call Drop Test Case

This test was measured NR n77, Antenna 2 and with callbox requesting maximum power. The call drop was manually performed when the DUT is transmitting at $P_{reserve}$ level as shown in the plot below. The measurement setup is shown in Figure 5-1. The detailed test procedure is described in Section 4.3.2.

Call drop test result:

Time-averaged conducted Tx power is converted/calculated into time-averaged 1gSAR using Equation (1a) and plotted below to demonstrate that the time-averaged 1gSAR versus time does not exceed the FCC limit of 1.6 W/kg for 1gSAR:

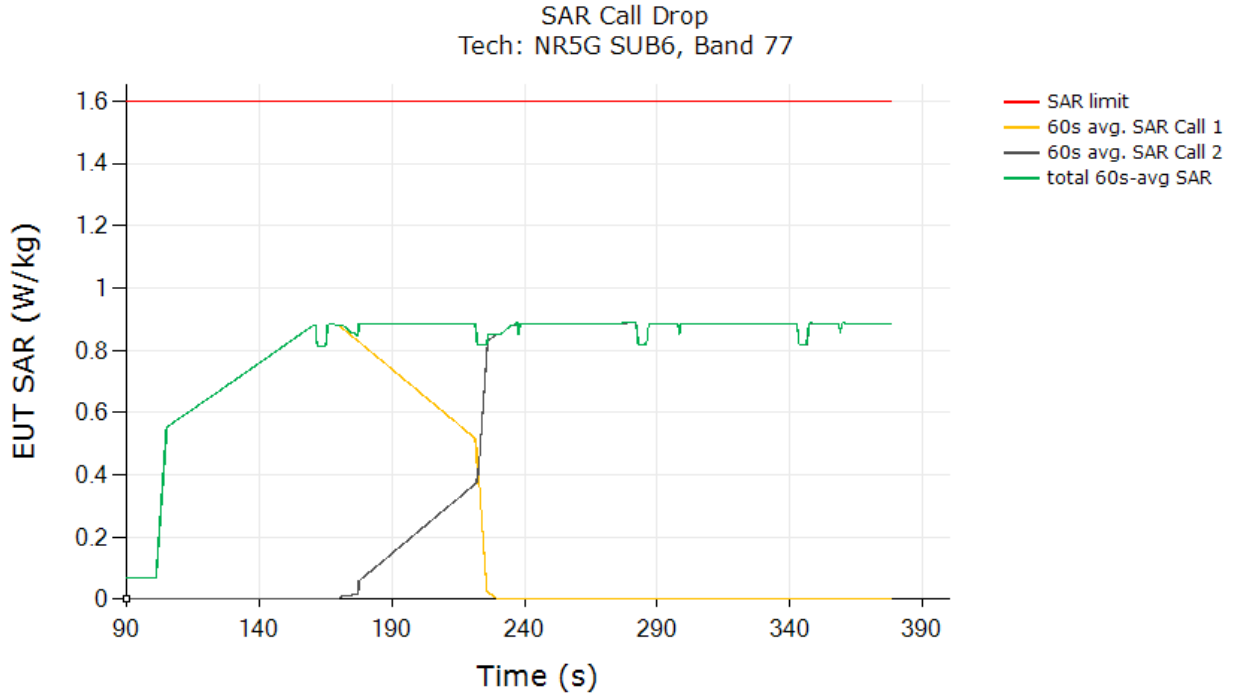

	(W/kg)
FCC 1gSAR limit	1.6
Max 60s-time averaged 1gSAR (green curve)	0.889
Validated	

The test result validated the continuity of power limiting in call change scenario.

FCC ID: BCGA2899	PART 2 RF EXPOSURE EVALUATION REPORT	Approved by: Technical Manager
Document S/N: 1C2311270066-03.BCG	DUT Type: Tablet Device	Page 45 of 66

7.3 Change in Technology/Band Test Case

This test was conducted with the callbox requesting maximum power, and with a technology switch from LTE Band 14, Antenna 4 to WCDMA Band 2, Antenna 1B. Following procedure detailed in Section 4.3.3, and using the measurement setup shown in Figure 5-1, the technology/band switch was performed when the DUT is transmitting at $P_{reserve}$ level as shown in the plot below.

Test result for change in technology/band:

Time-averaged conducted Tx power measurement results were converted into time-averaged normalized SAR values using Equation (4a), (4b) and (4c), and plotted below to demonstrate that the time-averaged normalized SAR versus time does not exceed the normalized FCC limit of 1.0:

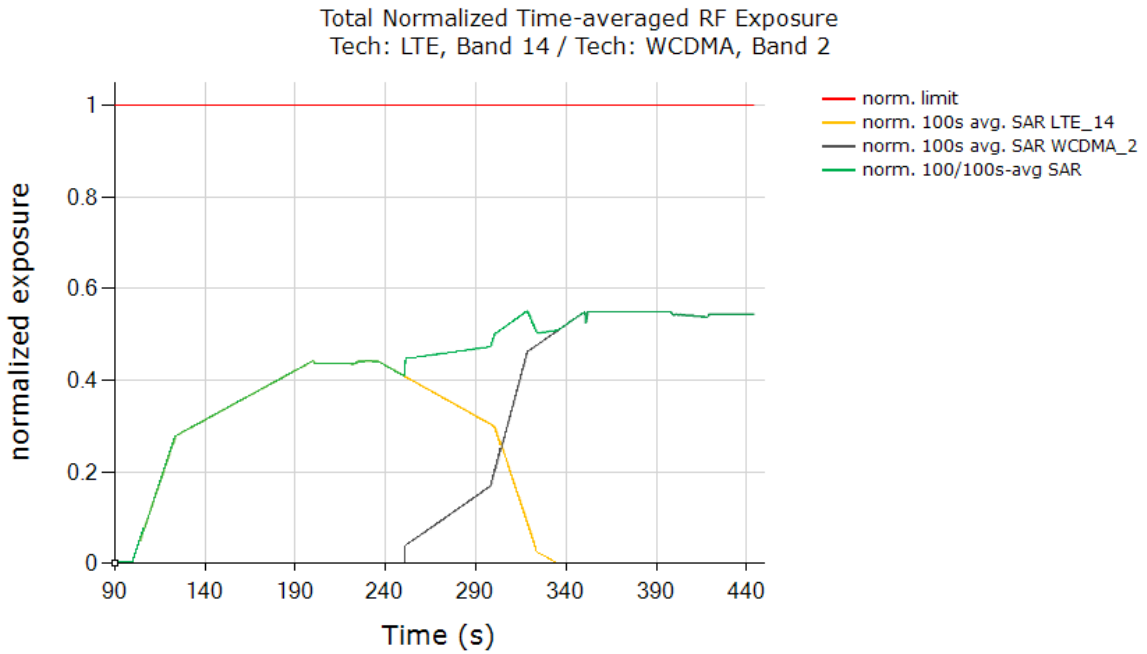

	(W/kg)
FCC normalized SAR limit	1.0
Max 100s-time averaged normalized SAR (green curve)	0.551
Validated	

The test result validated the continuity of power limiting in technology/band switch scenario.

FCC ID: BCGA2899	PART 2 RF EXPOSURE EVALUATION REPORT	Approved by: Technical Manager
Document S/N: 1C2311270066-03.BCG	DUT Type: Tablet Device	Page 46 of 66

7.4 Change in Antenna Test Case

This test was conducted with callbox requesting maximum power, and with a technology switch from LTE Band 25, Antenna 4 to LTE Band 25, Antenna 1B. Following procedure detailed in Section 4.3.4, and using the measurement setup shown in Figure 5-1, the antenna switch was performed when the DUT is transmitting at $P_{reserve}$ level as shown in the plot below.

Test result for change in antenna:

Time-averaged conducted Tx power measurement results were converted into time-averaged normalized SAR values using Equation (4a), (4b) and (4c), and plotted below to demonstrate that the time-averaged normalized SAR versus time does not exceed the normalized FCC limit of 1.0:

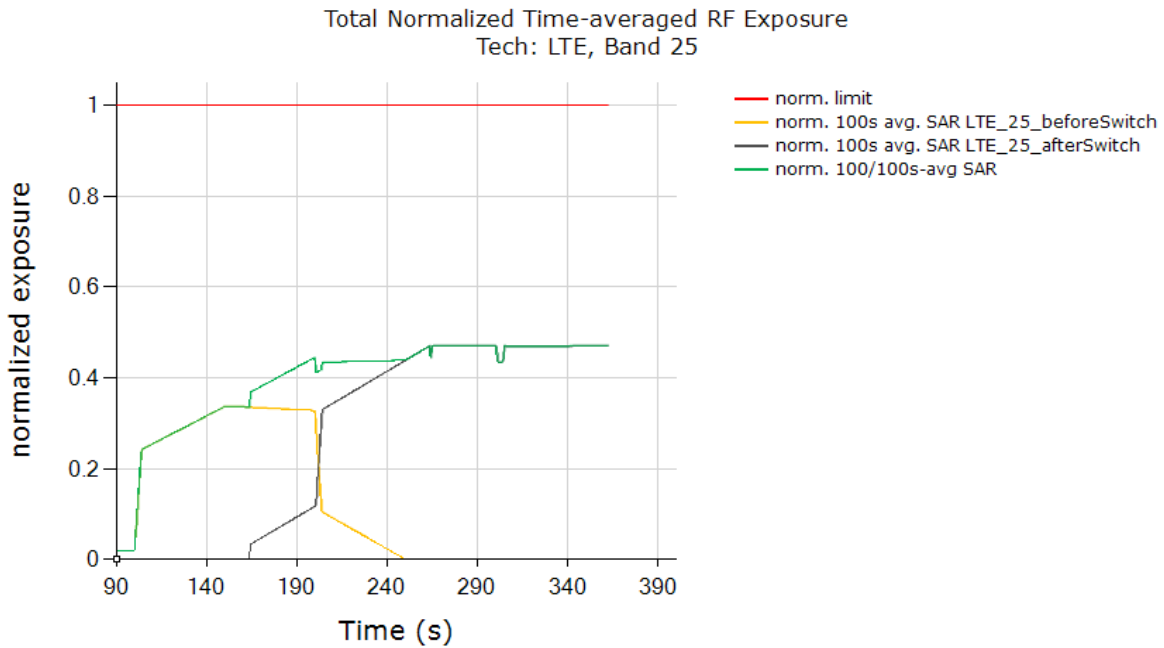

	(W/kg)
FCC normalized SAR limit	1.0
Max 100s-time averaged normalized SAR (green curve)	0.471
Validated	

The test result validated the continuity of power limiting in antenna switch scenario.

FCC ID: BCGA2899	PART 2 RF EXPOSURE EVALUATION REPORT	Approved by: Technical Manager
Document S/N: 1C2311270066-03.BCG	DUT Type: Tablet Device	Page 47 of 66

7.5 Change in Time window

This test was conducted with a callbox requesting maximum power, and with time-window switch between LTE Band 5, Antenna 2 (100s window) and LTE Band 48, Antenna 2 (60s window). Following procedure detailed in Section 4.3.6, and using the measurement setup shown in Figure 5-1(b), the time-window switch via tech/band/antenna switch was performed when the EUT is transmitting at $P_{reserve}$ level.

7.5.1 Test case 1: transition from LTE Band 5 to LTE Band 48 (i.e., 100s to 60s), then back to LTE Band 5

Test result for change in time-window (from 100s to 60s to 100s):

All the conducted Tx power measurement results were converted into time-averaged normalized SAR values using Equation (5a), (5b) and (5c), and plotted below to demonstrate that the time-averaged normalized SAR versus time does not exceed the FCC limit of 1 unit. Equation (5a) is used to convert the Tx power of device to obtain 100s-averaged normalized SAR in LTE Band 5 as shown in black curve. Similarly, equation (5b) is used to obtain 60s-averaged normalized SAR in LTE Band 48 as shown in orange curve. Equation (5c) is used to obtain total time-averaged normalized SAR as shown in green curve (i.e., sum of black and orange curves).

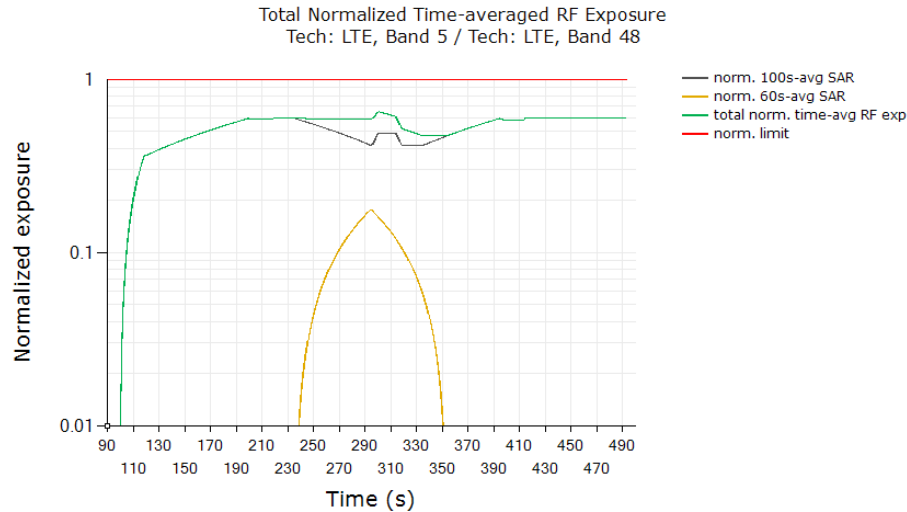

	(W/kg)
FCC normalized total exposure limit	1.0
Max time averaged normalized SAR (green curve)	0.651
Validated	

Plot Notes: Maximum power is requested by callbox for the entire duration of the test, with tech/band switches from 100s-to-60s window at ~235s time stamp, and from 60s-to-100s window at ~295s time stamp. Smart Transmit controls the Tx power during these time-window switches to ensure total time-averaged RF exposure, i.e., sum of black and orange curves given by equation (5c), is always compliant. In time-window switch test, at all times the total time-averaged normalized RF exposure (green curve) should not exceed normalized $SAR_{design_target} + 1\text{dB}$ device Smart Tx uncertainty. In this test, with a maximum normalized SAR of 0.651 being $\leq 0.63 (= 0.8/1.6 + 1\text{dB device Smart Tx uncertainty})$, the above test result validated the continuity of power limiting in time-window switch scenario.

FCC ID: BCGA2899	PART 2 RF EXPOSURE EVALUATION REPORT	Approved by: Technical Manager
Document S/N: 1C2311270066-03.BCG	DUT Type: Tablet Device	Page 48 of 66

7.5.2 Test case 2: transition from LTE Band 48 to LTE Band 5 (i.e., 60s to 100s), then back to LTE Band 48

Test result for change in time-window (from 60s to 100s to 60s):

All the conducted Tx power measurement results were converted into time-averaged normalized SAR values using Equation (5a), (5b) and (5c), and plotted below to demonstrate that the time-averaged normalized SAR versus time does not exceed the FCC limit of 1 unit. Equation (5a) is used to convert the Tx power of device to obtain 60s-averaged normalized SAR in LTE Band 48 as shown in black curve. Similarly, equation (5b) is used to obtain 100s-averaged normalized SAR in LTE Band 5 as shown in orange curve. Equation (5c) is used to obtain total time-averaged normalized SAR as shown in green curve (i.e., sum of black and orange curves).

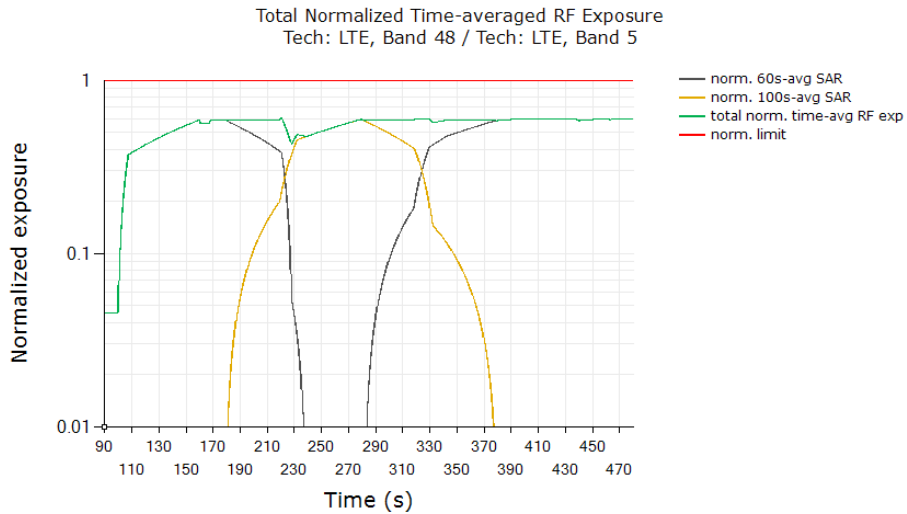

	(W/kg)
FCC normalized total exposure limit	1.0
Max time averaged normalized SAR (green curve)	0.609
Validated	

Plot Notes: Maximum power is requested by callbox for the entire duration of the test, with tech/band switches from 60s-to-100s window at ~180s time stamp, and from 100s-to-60s window at ~282s time stamp. Smart Transmit controls the Tx power during these time-window switches to ensure total time-averaged RF exposure, i.e., sum of black and orange curves given by equation (5c), is always compliant. In time-window switch test, at all times the total time-averaged normalized RF exposure (green curve) should not exceed normalized $SAR_{design_target} + 1dB$ device Smart Tx uncertainty. In this test, with a maximum normalized SAR of 0.609 being $\leq 0.63 (= 0.8/1.6 + 1dB$ device Smart Tx uncertainty), the above test result validated the continuity of power limiting in time-window switch scenario.

FCC ID: BCGA2899	PART 2 RF EXPOSURE EVALUATION REPORT	Approved by: Technical Manager
Document S/N: 1C2311270066-03.BCG	DUT Type: Tablet Device	Page 49 of 66

7.6 Switch in SAR exposure test results (ENDC; Same Time Window)

This test was conducted with callbox requesting maximum power, and with the EUT in LTE Band 66 + Sub6 NR Band n41 call. Following procedure detailed in Section 4.3.7 and Appendix F.2, and using the measurement setup shown in Figure 5-1(c) since LTE and Sub6 NR are on different antenna ports, the SAR exposure switch measurement is performed with the EUT in various SAR exposure scenarios, i.e., in SAR_{Sub6NR} only scenario (t = 0s ~ 120s), SAR_{Sub6NR} + SAR_{LTE} scenario (t = 120s ~ 240s) and SAR_{LTE} only scenario (t > 240s).

Plot Notes: All the conducted Tx power measurement results were converted into time-averaged normalized SAR values using Equation (5a), (5b) and (5c), and plotted below to demonstrate that the time-averaged normalized SAR versus time does not exceed the FCC limit of 1 unit. Equation (5a) is used to convert the LTE Tx power of device to obtain 100s-averaged normalized SAR in LTE Band 66 as shown in black curve. Similarly, equation (5b) is used to obtain 100s-averaged normalized SAR in Sub6 NR n41 as shown in orange curve. Equation (5c) is used to obtain total time-averaged normalized SAR as shown in green curve (i.e., sum of black and orange curves).

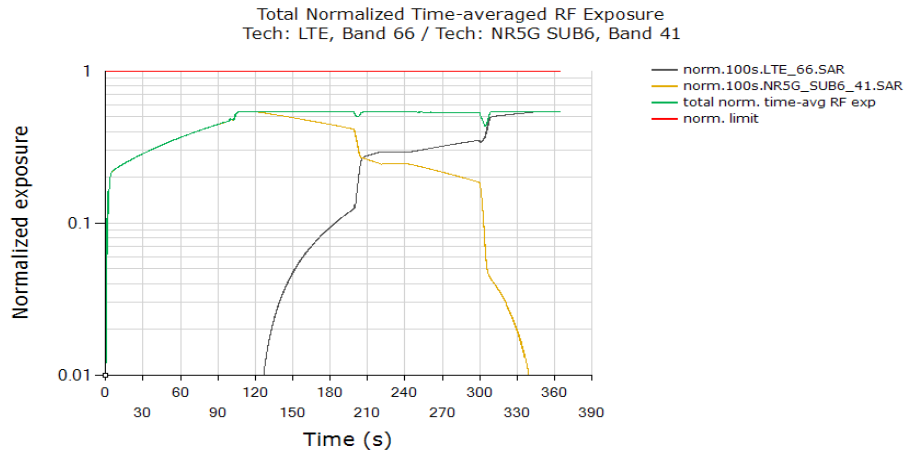

	(W/kg)
FCC normalized total exposure limit	1.0
Max time averaged normalized SAR (green curve)	0.545
Validated	

Plot Notes: Device starts predominantly in Sub6 NR SAR exposure scenario between 0s and 120s, and in LTE SAR + Sub6 NR SAR exposure scenario between 120s and 240s, and in predominantly in LTE SAR exposure scenario after t=240s. Here, Smart Transmit allocates a maximum of 100% of exposure margin (based on 3dB reserve margin setting) for Sub6 NR. This corresponds to a normalized 1gSAR exposure value = $100\% * 0.805\text{W/kg measured SAR at Sub6 NR } P_{limit} / 1.6\text{W/kg limit} = 0.503 \pm 1\text{dB device related Smart Tx uncertainty}$ (see orange curve between 120s). For predominantly LTE SAR exposure scenario, maximum normalized 1gSAR exposure should correspond to 100% exposure margin = $0.703 \text{ W/kg measured SAR at LTE } P_{limit} / 1.6\text{W/kg limit} = 0.439 \pm 1\text{dB device related Smart Tx uncertainty}$ (see black curve after t = 240s). Additionally, in SAR exposure switch test, at all times the total time-averaged normalized RF exposure (green curve) should not exceed normalized SAR_{design_target} + 1dB device Smart Tx uncertainty. In this test, with a maximum normalized SAR of 0.545 being $\leq 0.63 (= 0.8/1.6 + 1\text{dB device Smart Tx uncertainty})$, the above test result validated the continuity of power limiting in SAR exposure switch scenario.

FCC ID: BCGA2899	PART 2 RF EXPOSURE EVALUATION REPORT	Approved by: Technical Manager
Document S/N: 1C2311270066-03.BCG	DUT Type: Tablet Device	Page 50 of 66

7.7 Switch in SAR exposure test results (ENDC; Different Time Window)

This test was conducted with callbox requesting maximum power, and with the EUT in LTE Band 66 + Sub6 NR Band n77 call. Following procedure detailed in Section 4.3.7 and Appendix F.2, and using the measurement setup shown in Figure 5-1(c) since LTE and Sub6 NR are on different antenna ports, the SAR exposure switch measurement is performed with the EUT in various SAR exposure scenarios, i.e., in SAR_{sub6NR} only scenario (t = 0s ~ 120s), SAR_{sub6NR} + SAR_{LTE} scenario (t = 120s ~ 240s) and SAR_{LTE} only scenario (t > 240s).

Plot Notes: All the conducted Tx power measurement results were converted into time-averaged normalized SAR values using Equation (5a), (5b) and (5c), and plotted below to demonstrate that the time-averaged normalized SAR versus time does not exceed the FCC limit of 1 unit. Equation (5a) is used to convert the LTE Tx power of device to obtain 100s-averaged normalized SAR in LTE Band 66 as shown in black curve. Similarly, equation (5b) is used to obtain 100s-averaged normalized SAR in Sub6 NR n77 as shown in orange curve. Equation (5c) is used to obtain total time-averaged normalized SAR as shown in green curve (i.e., sum of black and orange curves).

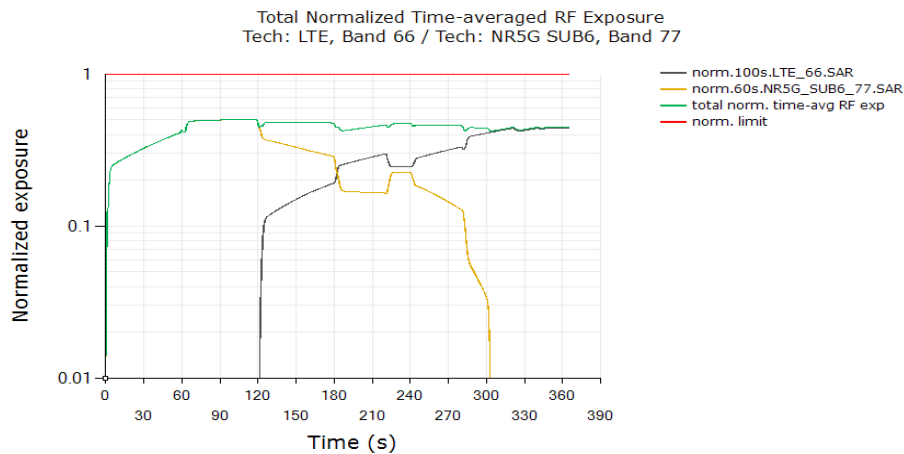

	(W/kg)
FCC normalized total exposure limit	1.0
Max time averaged normalized SAR (green curve)	0.503
Validated	

Plot Notes: Device starts predominantly in Sub6 NR SAR exposure scenario between 0s and 120s, and in LTE SAR + Sub6 NR SAR exposure scenario between 120s and 240s, and in predominantly in LTE SAR exposure scenario after t=240s. Here, Smart Transmit allocates a maximum of 100% of exposure margin (based on 3dB reserve margin setting) for Sub6 NR. This corresponds to a normalized 1gSAR exposure value = $100\% * 0.813 \text{ W/kg measured SAR at Sub6 NR } P_{limit} / 1.6 \text{ W/kg limit} = 0.508 \pm 1 \text{ dB device related Smart Tx uncertainty}$ (see orange curve between 120s). For predominantly LTE SAR exposure scenario, maximum normalized 1gSAR exposure should correspond to 100% exposure margin = $0.703 \text{ W/kg measured SAR at LTE } P_{limit} / 1.6 \text{ W/kg limit} = 0.439 \pm 1 \text{ dB device related Smart Tx uncertainty}$ (see black curve after t = 240s). Additionally, in SAR exposure switch test, at all times the total time-averaged normalized RF exposure (green curve) should not exceed normalized SAR_{design_target} + 1dB device Smart Tx uncertainty. In this test, with a maximum normalized SAR of 0.503 being $\leq 0.63 (= 0.8/1.6 + 1 \text{ dB device Smart Tx uncertainty})$, the above test result validated the continuity of power limiting in SAR exposure switch scenario.

FCC ID: BCGA2899	PART 2 RF EXPOSURE EVALUATION REPORT	Approved by: Technical Manager
Document S/N: 1C2311270066-03.BCG	DUT Type: Tablet Device	Page 51 of 66

7.8 Switch in SAR exposure test results (Interband ULCA)

This test was conducted with callbox requesting maximum power, and with the EUT in LTE Band 5 (PCC), Antenna 4 + LTE Band 2 (SCC), Antenna 1B call. The measurement setup shown in Figure 5-1(d) was used since LTE (PCC) and LTE (SCC) are on different antenna ports. The SAR exposure switch measurement is performed with the EUT in various SAR exposure scenarios, i.e., in SAR_{SCC} only scenario (t =0s ~120s), SAR_{PCC} + SAR_{SCC} scenario (t =120s ~ 240s) and SAR_{PCC} only scenario (t > 240s).

Plot Notes: All the conducted Tx power measurement results were converted into time-averaged normalized SAR values using Equation (5a), (5b) and (5c), and plotted below to demonstrate that the time-averaged normalized SAR versus time does not exceed the FCC limit of 1 unit. Equation (5a) is used to convert the LTE Tx power of device to obtain 100s-averaged normalized SAR in LTE Band 5 (PCC) as shown in black curve. Similarly, equation (5b) is used to obtain 100s-averaged normalized SAR in LTE Band 2 (SCC) as shown in orange curve. Equation (5c) is used to obtain total time-averaged normalized SAR as shown in green curve (i.e., sum of black and orange curves).

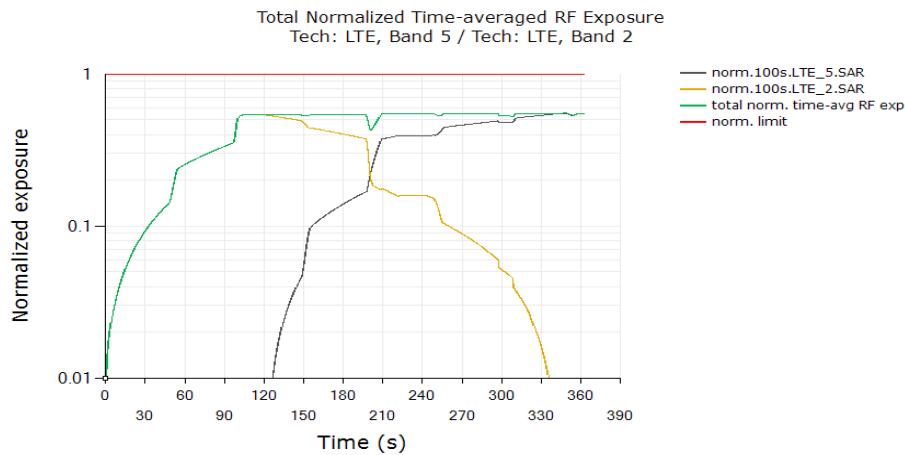

	(W/kg)
FCC normalized total exposure limit	1.0
Max time averaged normalized SAR (green curve)	0.553
Validated	

Plot Notes: Device starts predominantly in LTE Band 2 (SCC) SAR exposure scenario between 0s and 120s, and in LTE Band 5 (PCC) SAR + LTE Band 2 (SCC) SAR exposure scenario between 120s and 240s, and in predominantly in LTE B5 (PCC) SAR exposure scenario after t=240s. In SAR exposure switch test, at all times the total time-averaged normalized RF exposure (green curve) should not exceed normalized SAR_{design target} + 1 dB device Smart Tx uncertainty. In this test, with a maximum normalized SAR of 0.553 being ≤ 0.63 (= 0.8/1.6 + 1 dB device Smart Tx uncertainty), the above test result validated the continuity of power limiting in SAR exposure switch scenario.

FCC ID: BCGA2899	PART 2 RF EXPOSURE EVALUATION REPORT	Approved by: Technical Manager
Document S/N: 1C2311270066-03.BCG	DUT Type: Tablet Device	Page 52 of 66

8 SYSTEM VERIFICATION (FREQ < 6 GHZ)

8.1 Tissue Verification

**Table 8-1
Measured Tissue Properties**

Calibrated for Tests Performed on:	Tissue Type	Tissue Temp During Calibration (°C)	Measured Frequency (MHz)	Measured Conductivity, σ (S/m)	Measured Dielectric Constant, ϵ	TARGET Conductivity, σ (S/m)	TARGET Dielectric Constant, ϵ	% dev σ	% dev ϵ
1/15/2024	750 Head	19.9	680	0.844	41.542	0.888	42.305	-4.95%	-1.80%
			695	0.849	41.495	0.889	42.227	-4.50%	-1.73%
			700	0.851	41.483	0.889	42.201	-4.27%	-1.70%
			710	0.854	41.461	0.890	42.149	-4.04%	-1.63%
			725	0.859	41.426	0.891	42.071	-3.59%	-1.53%
			750	0.867	41.363	0.894	41.942	-3.02%	-1.38%
			770	0.874	41.313	0.895	41.838	-2.35%	-1.25%
			785	0.879	41.272	0.896	41.760	-1.90%	-1.17%
02/14/2024	750 Head	20	800	0.884	41.230	0.897	41.682	-1.45%	-1.08%
			680	0.875	42.310	0.888	42.305	-1.46%	0.01%
			695	0.881	42.274	0.889	42.227	-0.90%	0.11%
			710	0.886	42.235	0.890	42.149	-0.45%	0.20%
			725	0.891	42.185	0.891	42.071	0.00%	0.27%
			750	0.899	42.102	0.894	41.942	0.56%	0.38%
			770	0.906	42.040	0.895	41.838	1.23%	0.48%
			785	0.912	41.996	0.896	41.760	1.79%	0.57%
01/15/2024	835 Head	19.9	800	0.919	41.958	0.897	41.682	2.45%	0.66%
			815	0.890	41.190	0.898	41.594	-0.89%	-0.97%
			820	0.891	41.179	0.899	41.578	-0.89%	-0.96%
			835	0.896	41.144	0.900	41.500	-0.44%	-0.86%
01/17/2024	1900 Head	22.6	850	0.901	41.108	0.916	41.500	-1.64%	-0.94%
			1850	1.384	39.968	1.400	40.000	-1.14%	-0.08%
			1860	1.390	39.953	1.400	40.000	-0.71%	-0.12%
			1880	1.402	39.930	1.400	40.000	0.14%	-0.18%
			1900	1.415	39.908	1.400	40.000	1.07%	-0.23%
			1905	1.418	39.903	1.400	40.000	1.29%	-0.24%
			1910	1.421	39.897	1.400	40.000	1.50%	-0.26%
			1920	1.428	39.885	1.400	40.000	2.00%	-0.29%
01/31/2024	3600 Head	22.3	3350	2.882	36.709	2.759	38.100	4.46%	-3.65%
			3450	2.957	36.579	2.861	37.986	3.36%	-3.70%
			3500	2.994	36.502	2.913	37.929	2.78%	-3.76%
			3550	3.027	36.456	2.964	37.871	2.13%	-3.74%
			3560	3.037	36.425	2.974	37.860	2.12%	-3.79%
			3600	3.064	36.396	3.015	37.814	1.63%	-3.75%
			3650	3.102	36.344	3.066	37.757	1.17%	-3.74%
			3690	3.135	36.274	3.107	37.711	0.90%	-3.81%
			3700	3.143	36.264	3.117	37.700	0.83%	-3.81%
			3750	3.178	36.207	3.169	37.643	0.28%	-3.81%
			3900	3.300	36.029	3.323	37.471	-0.69%	-3.85%
			3930	3.328	35.977	3.353	37.437	-0.75%	-3.90%
			4100	3.469	35.785	3.528	37.243	-1.67%	-3.91%
			4150	3.512	35.746	3.579	37.186	-1.87%	-3.87%
2/4/2024	3600 Head	20	3300	2.809	36.998	2.708	38.157	3.72%	-3.04%
			3350	2.840	36.928	2.759	38.100	2.95%	-3.08%
			3450	2.916	36.789	2.861	37.986	1.90%	-3.15%
			3500	2.957	36.719	2.913	37.929	1.49%	-3.19%
			3550	2.991	36.667	2.964	37.871	0.91%	-3.18%
			3560	3.002	36.642	2.974	37.860	0.94%	-3.22%
			3600	3.032	36.605	3.015	37.814	0.57%	-3.20%
			3650	3.069	36.539	3.066	37.757	0.10%	-3.23%
			3690	3.106	36.467	3.107	37.711	-0.04%	-3.30%
			3700	3.114	36.461	3.117	37.700	-0.10%	-3.29%
			3750	3.152	36.409	3.169	37.643	-0.54%	-3.28%
			3900	3.282	36.212	3.323	37.471	-1.25%	-3.36%
			3930	3.309	36.167	3.353	37.437	-1.32%	-3.39%
			4100	3.452	35.962	3.528	37.243	-2.15%	-3.44%
4150	3.495	35.905	3.579	37.186	-2.36%	-3.44%			

FCC ID: BCGA2899	PART 2 RF EXPOSURE EVALUATION REPORT	Approved by: Technical Manager
Document S/N: 1C2311270066-03.BCG	DUT Type: Tablet Device	Page 53 of 66

The above measured tissue parameters were used in the DASY software. The DASY software was used to perform interpolation to determine the dielectric parameters at the SAR test device frequencies (per KDB Publication 865664 D01v01r04 and IEEE 1528-2013 6.6.1.2). The tissue parameters listed in the SAR test plots may slightly differ from the table above due to significant digit rounding in the software.

Per April 2019 TCB Workshop Notes, single head-tissue simulating liquid specified in IEC 62209-1 is permitted to use for all SAR tests.

8.2 Test System Verification

Prior to SAR assessment, the system is verified to $\pm 10\%$ of the SAR measurement on the reference dipole at the time of calibration by the calibration facility. Full system validation status and result summary can be found in Appendix C.

**Table 8-2
System Verification Results – 1g**

System Verification TARGET & MEASURED													
SAR System #	Tissue Frequency (MHz)	Tissue Type	Date	Amb. Temp (°C)	Liquid Temp (°C)	Input Power (W)	Source SN	Probe SN	DAE	Measured SAR _{1g} (W/kg)	1 W Target SAR _{1g} (W/kg)	1 W Normalized SAR _{1g} (W/kg)	Deviation _{1g} (%)
AM11	750	Head	1/15/2024	22.6	20.7	0.200	1057	7682	1683	1.680	8.510	8.400	-1.29%
AM3	750	Head	2/14/2024	21.5	20.7	0.200	1034	7782	1646	1.640	8.640	8.200	-5.09%
AM11	835	Head	1/15/2024	22.6	20.7	0.200	460	7682	1683	1.840	9.720	9.200	-5.35%
AM11	1900	Head	1/17/2024	22.6	22.7	0.100	5d030	7682	1683	3.770	39.800	37.700	-5.28%
AM3	3500	Head	1/31/2024	22.4	21.9	0.100	1126	7782	1646	7.080	67.000	70.800	5.67%
AM3	3700	Head	1/31/2024	22.4	21.9	0.100	1097	7782	1646	7.130	68.100	71.300	4.70%
AM3	3700	Head	2/4/2024	20.8	20.0	0.100	1097	7782	1646	6.560	68.100	65.600	-3.67%
AM3	3900	Head	2/4/2024	20.8	20.0	0.100	1073	7782	1646	6.920	69.700	69.200	-0.72%

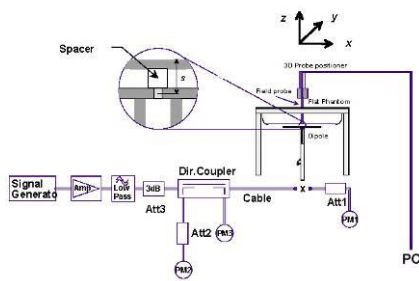

**Figure 8-1
System Verification Setup Diagram**



**Figure 8-2
System Verification Setup Photo**

FCC ID: BCGA2899	PART 2 RF EXPOSURE EVALUATION REPORT	Approved by: Technical Manager
Document S/N: 1C2311270066-03.BCG	DUT Type: Tablet Device	Page 54 of 66

9 SAR TEST RESULTS (FREQ < 6 GHZ)

9.1 Time-varying Tx Power Case

Following Section 4.4 procedure, time-averaged SAR measurements are conducted using a SAR probe at peak location of area scan over 500 seconds. cDASY6 system verification for SAR measurement is provided in Section 7, and the associated SPEAG certificates are attached in Appendix G.

SAR probe integration times depend on the communication signal being tested as defined in the probe calibration parameters.

Since the sampling rate used by cDASY6 for pointSAR measurements is not in user control, the number of points in 100s interval is determined from the scan duration setting in cDASY6 time-average pointSAR measurement by (100s cDASY6_scan_duration * total number of pointSAR values recorded). Running average is performed over these number of points in excel spreadsheet to obtain 100s averaged point SAR.

Following Section 4.4, for each of selected technology/band (listed in Table 6-2):

1. With *Reserve_power_margin* set to 0 dB, area scan is performed at P_{limit} , and time-averaged pointSAR measurements are conducted to determine the pointSAR at P_{limit} at peak location, denoted as $pointSAR_{P_{limit}}$.
2. With *Reserve_power_margin* set to actual (intended) value, two more time-averaged pointSAR measurements are performed at the same peak location for test sequences 1 and 2.

To demonstrate compliance, all the pointSAR measurement results were converted into 1gSAR values by using Equation (2a), rewritten below:

$$1gSAR(t) = \frac{pointSAR(t)}{pointSAR_{P_{limit}}} * 1gSAR_{P_{limit}} \quad (2a)$$

where, $pointSAR(t)$, $pointSAR_{P_{limit}}$, and $1gSAR_{P_{limit}}$ correspond to the measured instantaneous point SAR, measured point SAR at P_{limit} from above step 1 and 2, and measured 1gSAR values at P_{limit} obtained from Part 1 report and listed in Table 6-2 of this report.

FCC ID: BCGA2899	PART 2 RF EXPOSURE EVALUATION REPORT	Approved by: Technical Manager
Document S/N: 1C2311270066-03.BCG	DUT Type: Tablet Device	Page 55 of 66

9.1.1 WCDMA Band 5, Antenna 4

SAR test results for test sequence 1:

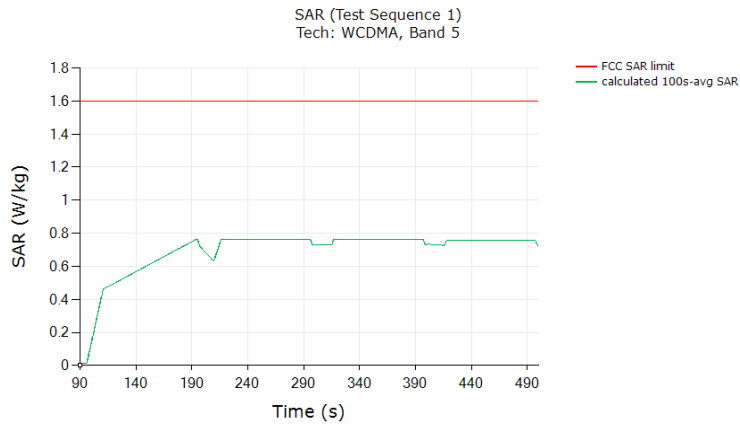

	(W/kg)
FCC 1gSAR limit	1.6
Max 100s-time averaged point 1gSAR (green curve)	0.766
Validated: Max time averaged SAR (green curve) is within 1 dB device Smart Tx uncertainty of measured SAR at P_{limit} (Part 1 Worst Case SAR at Plim column in Table 6-2).	

SAR test results for test sequence 2:

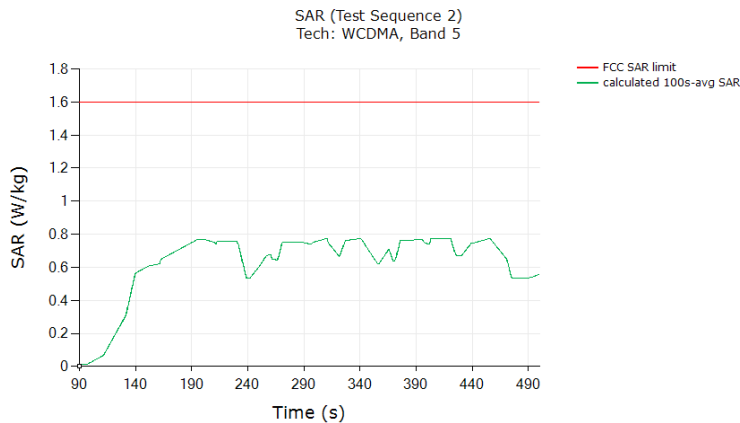

	(W/kg)
FCC 1gSAR limit	1.6
Max 100s-time averaged point 1gSAR (green curve)	0.775
Validated: Max time averaged SAR (green curve) is within 1 dB device Smart Tx uncertainty of measured SAR at P_{limit} (Part 1 Worst Case SAR at Plim column in Table 6-2).	

FCC ID: BCGA2899	PART 2 RF EXPOSURE EVALUATION REPORT	Approved by: Technical Manager
Document S/N: 1C2311270066-03.BCG	DUT Type: Tablet Device	Page 56 of 66

9.1.2 WCDMA Band 2, Antenna 1B

SAR test results for test sequence 1:

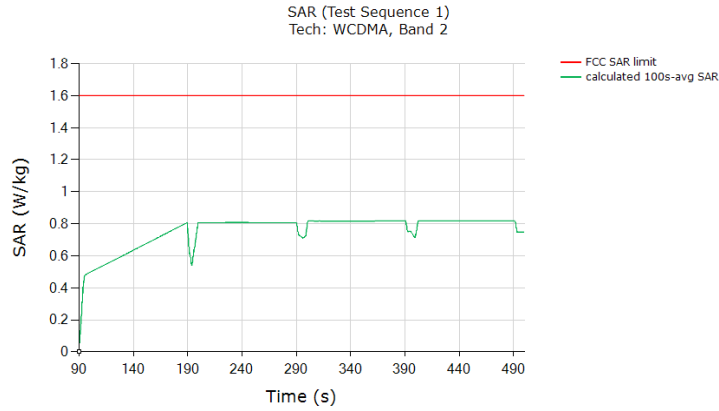

	(W/kg)
FCC 1gSAR limit	1.6
Max 100s-time averaged point 1gSAR (green curve)	0.817
Validated: Max time averaged SAR (green curve) is within 1 dB device Smart Tx uncertainty of measured SAR at P_{limit} (Part 1 Worst Case SAR at Plim column in Table 6-2).	

SAR test results for test sequence 2:

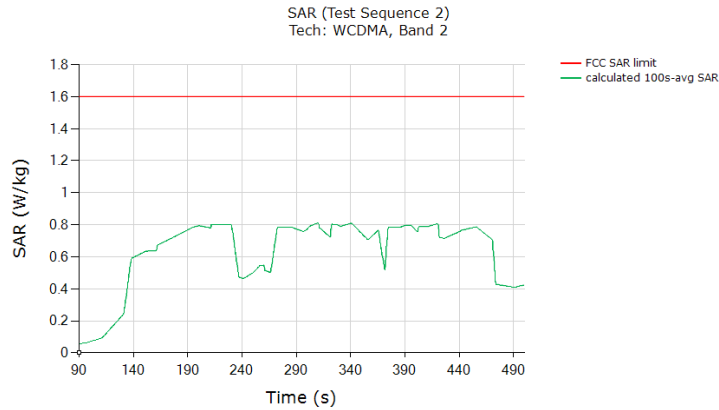

	(W/kg)
FCC 1gSAR limit	1.6
Max 100s-time averaged point 1gSAR (green curve)	0.811
Validated: Max time averaged SAR (green curve) is within 1 dB device Smart Tx uncertainty of measured SAR at P_{limit} (Part 1 Worst Case SAR at Plim column in Table 6-2).	

FCC ID: BCGA2899	PART 2 RF EXPOSURE EVALUATION REPORT	Approved by: Technical Manager
Document S/N: 1C2311270066-03.BCG	DUT Type: Tablet Device	Page 57 of 66

9.1.3 LTE Band 14, Antenna 4

SAR test results for test sequence 1:

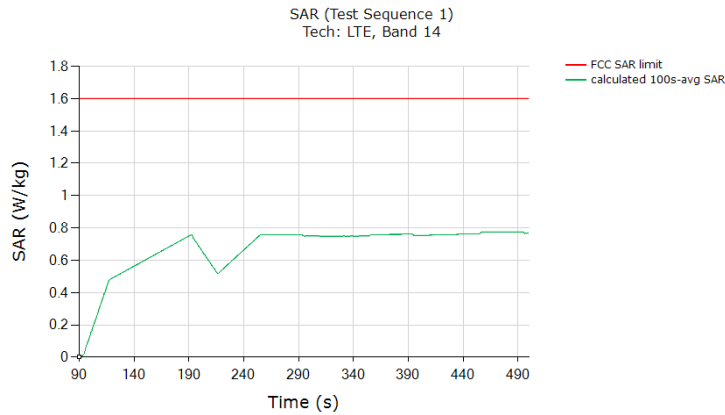

	(W/kg)
FCC 1gSAR limit	1.6
Max 100s-time averaged point 1gSAR (green curve)	0.776
Validated: Max time averaged SAR (green curve) is within 1 dB device Smart Tx uncertainty of measured SAR at P_{limit} (Part 1 Worst Case SAR at Plim column in Table 6-2).	

SAR test results for test sequence 2:

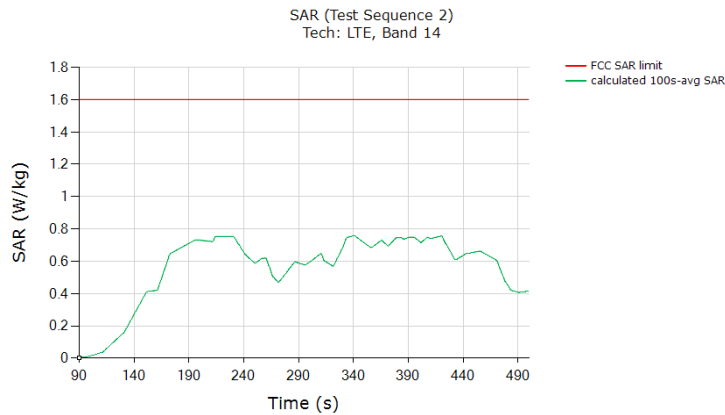

	(W/kg)
FCC 1gSAR limit	1.6
Max 100s-time averaged point 1gSAR (green curve)	0.757
Validated: Max time averaged SAR (green curve) is within 1 dB device Smart Tx uncertainty of measured SAR at P_{limit} (Part 1 Worst Case SAR at Plim column in Table 6-2).	

FCC ID: BCGA2899	PART 2 RF EXPOSURE EVALUATION REPORT	Approved by: Technical Manager
Document S/N: 1C2311270066-03.BCG	DUT Type: Tablet Device	Page 58 of 66

9.1.4 LTE Band 48, Antenna 1A

SAR test results for test sequence 1:

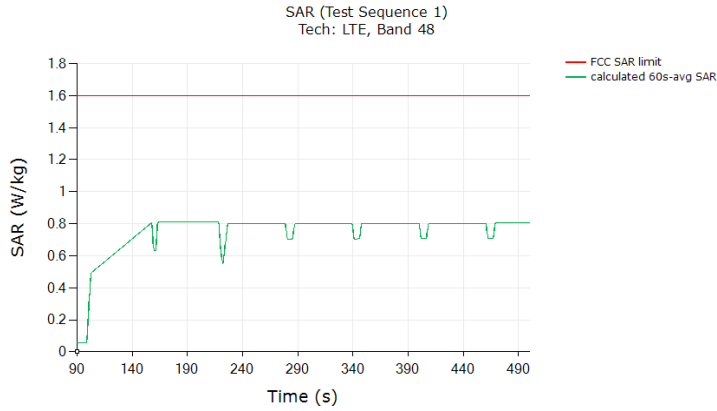

	(W/kg)
FCC 1gSAR limit	1.6
Max 60s-time averaged point 1gSAR (green curve)	0.811
Validated: Max time averaged SAR (green curve) is within 1 dB device Smart Tx uncertainty of measured SAR at P_{limit} (Part 1 Worst Case SAR at Plim column in Table 6-2).	

SAR test results for test sequence 2:

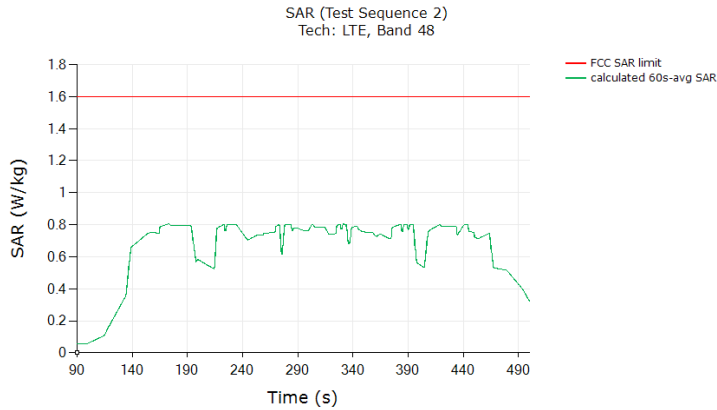

	(W/kg)
FCC 1gSAR limit	1.6
Max 60s-time averaged point 1gSAR (green curve)	0.805
Validated: Max time averaged SAR (green curve) is within 1 dB device Smart Tx uncertainty of measured SAR at P_{limit} (Part 1 Worst Case SAR at Plim column in Table 6-2).	

FCC ID: BCGA2899	PART 2 RF EXPOSURE EVALUATION REPORT	Approved by: Technical Manager
Document S/N: 1C2311270066-03.BCG	DUT Type: Tablet Device	Page 59 of 66

9.1.5 NR n71 SA, Antenna 2

SAR test results for test sequence 1:

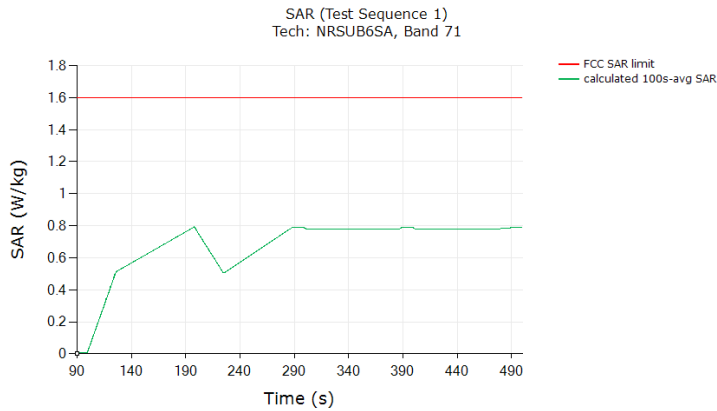

	(W/kg)
FCC 1gSAR limit	1.6
Max 100s-time averaged point 1gSAR (green curve)	0.792
Validated: Max time averaged SAR (green curve) is within 1 dB device Smart Tx uncertainty of measured SAR at P_{limit} (Part 1 Worst Case SAR at Plim column in Table 6-2).	

SAR test results for test sequence 2:

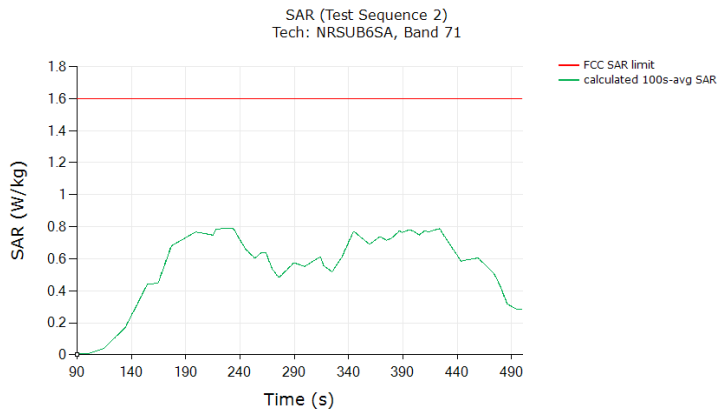

	(W/kg)
FCC 1gSAR limit	1.6
Max 100s-time averaged point 1gSAR (green curve)	0.789
Validated: Max time averaged SAR (green curve) is within 1 dB device Smart Tx uncertainty of measured SAR at P_{limit} (Part 1 Worst Case SAR at Plim column in Table 6-2).	

FCC ID: BCGA2899	PART 2 RF EXPOSURE EVALUATION REPORT	Approved by: Technical Manager
Document S/N: 1C2311270066-03.BCG	DUT Type: Tablet Device	Page 60 of 66

9.1.6 NR n77 SA, Antenna 2

SAR test results for test sequence 1:

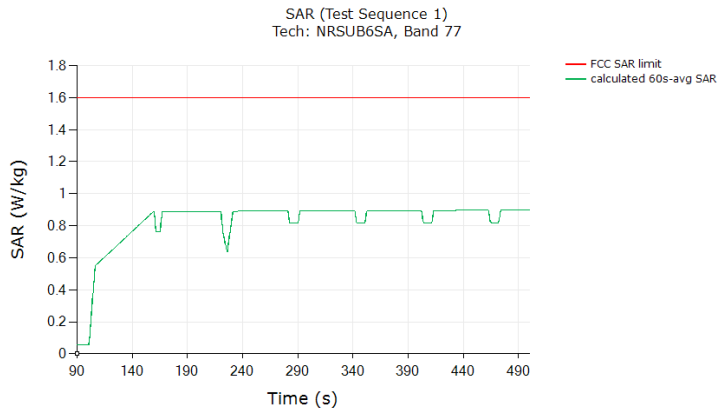

	(W/kg)
FCC 1gSAR limit	1.6
Max 60s-time averaged point 1gSAR (green curve)	0.897
Validated: Max time averaged SAR (green curve) is within 1 dB device Smart Tx uncertainty of measured SAR at P_{limit} (Part 1 Worst Case SAR at Plim column in Table 6-2).	

SAR test results for test sequence 2:

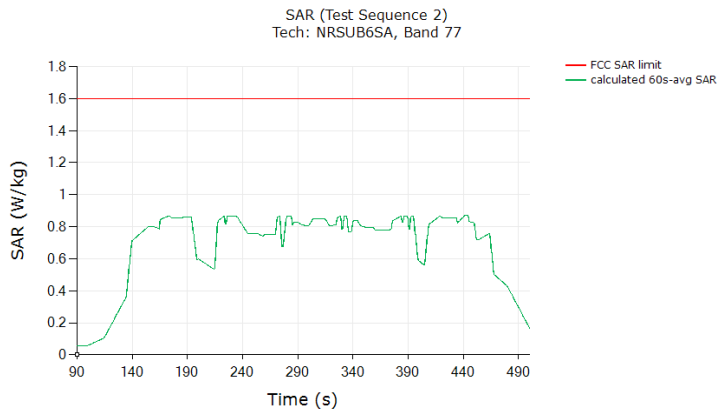

	(W/kg)
FCC 1gSAR limit	1.6
Max 60s-time averaged point 1gSAR (green curve)	0.869
Validated: Max time averaged SAR (green curve) is within 1 dB device Smart Tx uncertainty of measured SAR at P_{limit} (Part 1 Worst Case SAR at Plim column in Table 6-2).	

FCC ID: BCGA2899	PART 2 RF EXPOSURE EVALUATION REPORT	Approved by: Technical Manager
Document S/N: 1C2311270066-03.BCG	DUT Type: Tablet Device	Page 61 of 66

10 EQUIPMENT LIST

Manufacturer	Model	Description	Cal Date	Cal Interval	Cal Due	Serial Number
Agilent	E4438C	ESG Vector Signal Generator	4/1/2023	Annual	4/1/2024	US41460739
Agilent	N5182A	MXG Vector Signal Generator	4/1/2023	Annual	4/1/2024	MY47420837
Agilent	E4404B	Spectrum Analyzer	N/A	N/A	N/A	MY45113242
Amplifier Research	15S1G6	Amplifier	CBT	N/A	CBT	343972
Amplifier Research	15S1G6	Amplifier	CBT	N/A	CBT	433973
Anritsu	MA24106A	USB Power Sensor	12/4/2023	Annual	12/4/2024	1520501
Anritsu	MA24106A	USB Power Sensor	10/31/2023	Annual	10/31/2024	1248508
Anritsu	MA2411B	Pulse Power Sensor	6/15/2023	Annual	6/15/2024	1126066
Anritsu	MA2411B	Pulse Power Sensor	6/15/2023	Annual	6/15/2024	1339007
Anritsu	MS46131A	Modular 1 Point Vector Network Analyzer	6/28/2023	Annual	6/28/2024	2216501
Control Company	4025	Long Stem Thermometer	9/15/2022	Biennial	9/15/2024	221767764
Control Company	4025	Long Stem Thermometer	9/15/2022	Biennial	9/15/2024	221767774
Control Company	4040	Therm./ Clock/ Humidity Monitor	5/11/2022	Biennial	5/11/2024	221514925
Keysight Technologies	E7515B	UXM 5G Wireless Test Platform	4/14/2023	Annual	4/14/2024	MY60192562
MCL	BW-N6W5+	6dB Attenuator	CBT	N/A	CBT	1139
MiniCircuits	ZN2PD2-63-S+	350-6000 MHz Power Splitter	CBT	N/A	CBT	UU1R602047
Mini-Circuits	VL6-6000+	Low Pass Filter DC to 6000 MHz	CBT	N/A	CBT	N/A
Mini-Circuits	NLP-2950+	Low Pass Filter DC to 2700 MHz	CBT	N/A	CBT	N/A
Mini-Circuits	NLP-1200+	Low Pass Filter DC to 1000 MHz	CBT	N/A	CBT	N/A
Mini-Circuits	BW-N20W5	Power Attenuator	CBT	N/A	CBT	1226
Mini-Circuits	ZUDC10-83-S+	Directional Coupler	CBT	N/A	CBT	2050
Narda	4216-10	Directional Coupler, 0.5 to 8.0GHz, 10 dB	CBT	N/A	CBT	02838
Narda	4772-3	Attenuator	CBT	N/A	CBT	9406
Narda	BW-S3W2	Attenuator	CBT	N/A	CBT	120
Rohde & Schwarz	CMW500	Wideband Radio Communication Tester	6/1/2023	Annual	6/1/2024	108843
Rohde & Schwarz	CMW500	Wideband Radio Communication Tester	6/1/2023	Annual	6/1/2024	168543
Rohde & Schwarz	NRP8S	3-Path Dipole Power Sensor	1/16/2024	Annual	1/16/2025	109956
Rohde & Schwarz	NRP8S	3-Path Dipole Power Sensor	1/16/2024	Annual	1/16/2025	109957
Rohde & Schwarz	NRP50S	3-Path Dipole Power Sensor	12/14/2023	Annual	12/14/2024	109052
SPEAG	D750V3	750 MHz SAR Dipole	5/16/2022	Biennial	5/16/2024	1057
SPEAG	D750V3	750 MHz SAR Dipole	5/11/2021	Triennial	5/11/2024	1034
SPEAG	D835V2	835 MHz SAR Dipole	5/16/2022	Biennial	5/16/2024	460
SPEAG	D1750V2	1900 MHz SAR Dipole	5/16/2022	Biennial	5/16/2024	5d030
SPEAG	D3500V2	3500 MHz SAR Dipole	6/9/2021	Triennial	6/9/2024	1126
SPEAG	D3700V2	3700 MHz SAR Dipole	6/9/2021	Triennial	6/9/2024	1097
SPEAG	D3900V2	3900 MHz SAR Dipole	6/10/2021	Triennial	6/10/2024	1073
SPEAG	DAE4	Dasy Data Acquisition Electronics	9/8/2023	Annual	9/8/2024	1646
SPEAG	DAE4	Dasy Data Acquisition Electronics	5/11/2023	Annual	5/11/2024	1683
SPEAG	EX3DV4	SAR Probe	9/12/2023	Annual	9/12/2024	7782
SPEAG	EX3DV4	SAR Probe	5/11/2023	Annual	5/11/2024	7682

Notes:

1. CBT (Calibrated Before Testing). Prior to testing, the measurement paths containing a cable, amplifier, attenuator, coupler, or filter were connected to a calibrated source (i.e. a signal generator) to determine the losses of the measurement path, the power meter offset was then adjusted to compensate for the measurement system losses. This level offset is stored within the power meter before measurements are made. This calibration verification procedure applies to the system verification and output power measurements. The calibrated reading is then taken directly from the power meter after compensation of the losses for all final power measurements.
2. Each equipment item is used solely within its respective calibration period.

FCC ID: BCGA2899	PART 2 RF EXPOSURE EVALUATION REPORT	Approved by: Technical Manager
Document S/N: 1C2311270066-03.BCG	DUT Type: Tablet Device	Page 62 of 66

11 MEASUREMENT UNCERTAINTIES

For SAR Measurements

a	c	d	e= f(d,k)	f	g	h= c x f/e	i= c x g/e	k
Uncertainty Component	Tol. (± %)	Prob. Dist.	Div.	c _i 1gm	c _i 10 gms	1gm u _i (± %)	10gms u _i (± %)	v _i
Measurement System								
Probe Calibration	6.55	N	1	1.0	1.0	6.6	6.6	∞
Axial Isotropy	0.25	N	1	0.7	0.7	0.2	0.2	∞
Hemishperical Isotropy	1.3	N	1	0.7	0.7	0.9	0.9	∞
Boundary Effect	2.0	R	1.73	1.0	1.0	1.2	1.2	∞
Linearity	0.3	N	1	1.0	1.0	0.3	0.3	∞
System Detection Limits	0.25	R	1.73	1.0	1.0	0.1	0.1	∞
Readout Electronics	0.3	N	1	1.0	1.0	0.3	0.3	∞
Response Time	0.8	R	1.73	1.0	1.0	0.5	0.5	∞
Integration Time	2.6	R	1.73	1.0	1.0	1.5	1.5	∞
RF Ambient Conditions - Noise	3.0	R	1.73	1.0	1.0	1.7	1.7	∞
RF Ambient Conditions - Reflections	3.0	R	1.73	1.0	1.0	1.7	1.7	∞
Probe Positioner Mechanical Tolerance	0.4	R	1.73	1.0	1.0	0.2	0.2	∞
Probe Positioning w/ respect to Phantom	6.7	R	1.73	1.0	1.0	3.9	3.9	∞
Extrapolation, Interpolation & Integration algorithms for Max. SAR Evaluation	4.0	R	1.73	1.0	1.0	2.3	2.3	∞
Test Sample Related								
Test Sample Positioning	2.7	N	1	1.0	1.0	2.7	2.7	35
Device Holder Uncertainty	1.67	N	1	1.0	1.0	1.7	1.7	5
Output Power Variation - SAR drift measurement	5.0	R	1.73	1.0	1.0	2.9	2.9	∞
SAR Scaling	0.0	R	1.73	1.0	1.0	0.0	0.0	∞
Phantom & Tissue Parameters								
Phantom Uncertainty (Shape & Thickness tolerances)	7.6	R	1.73	1.0	1.0	4.4	4.4	∞
Liquid Conductivity - measurement uncertainty	4.2	N	1	0.78	0.71	3.3	3.0	10
Liquid Permittivity - measurement uncertainty	4.1	N	1	0.23	0.26	1.0	1.1	10
Liquid Conductivity - Temperature Uncertainty	3.4	R	1.73	0.78	0.71	1.5	1.4	∞
Liquid Permittivity - Temperature Uncertainty	0.6	R	1.73	0.23	0.26	0.1	0.1	∞
Liquid Conductivity - deviation from target values	5.0	R	1.73	0.64	0.43	1.8	1.2	∞
Liquid Permittivity - deviation from target values	5.0	R	1.73	0.60	0.49	1.7	1.4	∞
Combined Standard Uncertainty (k=1)	RSS					11.5	11.3	60
Expanded Uncertainty (95% CONFIDENCE LEVEL)	k=2					23.0	22.6	

FCC ID: BCGA2899	PART 2 RF EXPOSURE EVALUATION REPORT	Approved by: Technical Manager
Document S/N: 1C2311270066-03.BCG	DUT Type: Tablet Device	Page 63 of 66

12 CONCLUSION

12.1 Measurement Conclusion

The SAR evaluation indicates that the DUT complies with the RF radiation exposure limits of the FCC and Innovation, Science, and Economic Development Canada, with respect to all parameters subject to this test. These measurements were taken to simulate the RF effects of RF exposure under worst-case conditions. Precise laboratory measures were taken to assure repeatability of the tests. The results and statements relate only to the item(s) tested.

Please note that the absorption and distribution of electromagnetic energy in the body are very complex phenomena that depend on the mass, shape, and size of the body, the orientation of the body with respect to the field vectors, and the electrical properties of both the body and the environment. Other variables that may play a substantial role in possible biological effects are those that characterize the environment (e.g. ambient temperature, air velocity, relative humidity, and body insulation) and those that characterize the individual (e.g. age, gender, activity level, debilitation, or disease). Because various factors may interact with one another to vary the specific biological outcome of an exposure to electromagnetic fields, any protection guide should consider maximal amplification of biological effects as a result of field-body interactions, environmental conditions, and physiological variables. [3]

FCC ID: BCGA2899	PART 2 RF EXPOSURE EVALUATION REPORT	Approved by: Technical Manager
Document S/N: 1C2311270066-03.BCG	DUT Type: Tablet Device	Page 64 of 66

13 REFERENCES

- [1] Federal Communications Commission, ET Docket 93-62, Guidelines for Evaluating the Environmental Effects of Radiofrequency Radiation, Aug. 1996.
- [2] ANSI/IEEE C95.1-2005, American National Standard safety levels with respect to human exposure to radio frequency electromagnetic fields, 3kHz to 300GHz, New York: IEEE, 2006.
- [3] ANSI/IEEE C95.1-1992, American National Standard safety levels with respect to human exposure to radio frequency electromagnetic fields, 3kHz to 300GHz, New York: IEEE, Sept. 1992.
- [4] ANSI/IEEE C95.3-2002, IEEE Recommended Practice for the Measurement of Potentially Hazardous Electromagnetic Fields - RF and Microwave, New York: IEEE, December 2002.
- [5] IEEE Standards Coordinating Committee 39 –Standards Coordinating Committee 34 – IEEE Std. 1528-2013, IEEE Recommended Practice for Determining the Peak Spatial-Average Specific Absorption Rate (SAR) in the Human Head from Wireless Communications Devices: Measurement Techniques.
- [6] NCRP, National Council on Radiation Protection and Measurements, Biological Effects and Exposure Criteria for RadioFrequency Electromagnetic Fields, NCRP Report No. 86, 1986. Reprinted Feb. 1995.
- [7] T. Schmid, O. Egger, N. Kuster, Automated E-field scanning system for dosimetric assessments, IEEE Transaction on Microwave Theory and Techniques, vol. 44, Jan. 1996, pp. 105-113.
- [8] K. Pokovic, T. Schmid, N. Kuster, Robust setup for precise calibration of E-field probes in tissue simulating liquids at mobile communications frequencies, ICECOM97, Oct. 1997, pp. 1 -124.
- [9] K. Pokovic, T. Schmid, and N. Kuster, E-field Probe with improved isotropy in brain simulating liquids, Proceedings of the ELMAR, Zadar, Croatia, June 23-25, 1996, pp. 172-175.
- [10] Schmid & Partner Engineering AG, Application Note: Data Storage and Evaluation, June 1998, p2.
- [11] V. Hombach, K. Meier, M. Burkhardt, E. Kuhn, N. Kuster, The Dependence of EM Energy Absorption upon Human Modeling at 900 MHz, IEEE Transaction on Microwave Theory and Techniques, vol. 44 no. 10, Oct. 1996, pp. 1865-1873.
- [12] N. Kuster and Q. Balzano, Energy absorption mechanism by biological bodies in the near field of dipole antennas above 300MHz, IEEE Transaction on Vehicular Technology, vol. 41, no. 1, Feb. 1992, pp. 17-23.
- [13] G. Hartsgrove, A. Kraszewski, A. Surowiec, Simulated Biological Materials for Electromagnetic Radiation Absorption Studies, University of Ottawa, Bioelectromagnetics, Canada: 1987, pp. 29-36.
- [14] Q. Balzano, O. Garay, T. Manning Jr., Electromagnetic Energy Exposure of Simulated Users of Portable Cellular Telephones, IEEE Transactions on Vehicular Technology, vol. 44, no.3, Aug. 1995.
- [15] W. Gander, Computermathematick, Birkhaeuser, Basel, 1992.
- [16] W.H. Press, S.A. Teukolsky, W.T. Vetterling, and B.P. Flannery, Numerical Recipes in C, The Art of Scientific Computing, Second edition, Cambridge University Press, 1992.
- [17] N. Kuster, R. Kastle, T. Schmid, Dosimetric evaluation of mobile communications equipment with known precision, IEEE Transaction on Communications, vol. E80-B, no. 5, May 1997, pp. 645-652.

FCC ID: BCGA2899	PART 2 RF EXPOSURE EVALUATION REPORT	Approved by: Technical Manager
Document S/N: 1C2311270066-03.BCG	DUT Type: Tablet Device	Page 65 of 66

- [18] CENELEC CLC/SC111B, European Prestandard (prENV 50166-2), Human Exposure to Electromagnetic Fields High-frequency: 10kHz-300GHz, Jan. 1995.
- [19] Prof. Dr. Niels Kuster, ETH, Eidgenössische Technische Hochschule Zürich, Dosimetric Evaluation of the Cellular Phone.
- [20] IEC 62209-1, Measurement procedure for the assessment of specific absorption rate of human exposure to radio frequency fields from hand-held and body-mounted wireless communication devices - Part 1: Devices used next to the ear (Frequency range of 300 MHz to 6 GHz), July 2016.
- [21] Innovation, Science, Economic Development Canada RSS-102 Radio Frequency Exposure Compliance of Radiocommunication Apparatus (All Frequency Bands) Issue 5, March 2015.
- [22] Health Canada Safety Code 6 Limits of Human Exposure to Radio Frequency Electromagnetic Fields in the Frequency Range from 3 kHz – 300 GHz, 2015
- [23] FCC SAR Test Procedures for 2G-3G Devices, Mobile Hotspot and UMPC Devices KDB Publications 941225, D01-D07
- [24] SAR Measurement Guidance for IEEE 802.11 Transmitters, KDB Publication 248227 D01
- [25] FCC SAR Considerations for Handsets with Multiple Transmitters and Antennas, KDB Publications 648474 D03-D04
- [26] FCC SAR Evaluation Considerations for Laptop, Notebook, Netbook and Tablet Computers, FCC KDB Publication 616217 D04
- [27] FCC SAR Measurement and Reporting Requirements for 100MHz – 6 GHz, KDB Publications 865664 D01-D02
- [28] FCC General RF Exposure Guidance and SAR Procedures for Dongles, KDB Publication 447498, D01-D02
- [29] Anexo à Resolução No. 533, de 10 de Setembro de 2009.
- [30] IEC 62209-2, Human exposure to radio frequency fields from hand-held and body-mounted wireless communication devices - Human models, instrumentation, and procedures - Part 2: Procedure to determine the specific absorption rate (SAR) for wireless communication devices used in close proximity to the human body (frequency range of 30 MHz to 6 GHz), Mar. 2010.

FCC ID: BCGA2899	PART 2 RF EXPOSURE EVALUATION REPORT	Approved by: Technical Manager
Document S/N: 1C2311270066-03.BCG	DUT Type: Tablet Device	Page 66 of 66