

TEST REPORT

Test Report No. : UL-RPT-RP14614878JD02G

Customer : Apple Inc.
Model No. / HVIN : A2874
PMN : iMac
FCC ID : BCGA2874
ISED Certification No. : IC: 579C-A2874
Technology : *Bluetooth* – HDR (High Power Mode)
Test Standard(s) : FCC Parts 15.209(a) & 15.247
Innovation, Science and Economic Development Canada
RSS-247 Issue 2 February 2017
RSS-Gen Issue 5 February 2021
Test Laboratory : UL International (UK) Ltd, Basingstoke, Hampshire, RG24 8AH,
United Kingdom

1. This test report shall not be reproduced except in full, without the written approval of UL International (UK) Ltd.
2. The results in this report apply only to the sample(s) tested.
3. The sample tested is in compliance with the above standard(s).
4. The test results in this report are traceable to the national or international standards.
5. Version 1.0.

Date of Issue: 17 April 2023

Checked by: 
Sarah Williams
RF Operations Leader, Radio Laboratory

Company Signatory: 
Ben Mercer
Lead Project Engineer, Radio Laboratory



The *Bluetooth*® word mark and logos are owned by the *Bluetooth* SIG, Inc. and any use of such marks by UL International (UK) Ltd is under licence. Other trademarks and trade names are those of their respective owners.

UL International (UK) LTD

Unit 1-3 Horizon, Kingsland Business Park, Wade Road, Basingstoke, Hampshire, RG24 8AH, UK
Telephone: +44 (0)1256 312000

Customer Information

Company Name:	Apple Inc.
Address:	One Apple Park Way Cupertino, California 95014 U.S.A.
Contact Name:	Stuart Thomas

Report Revision History

Version Number	Issue Date	Revision Details	Revised By
1.0	17/04/2023	Initial Version	Sarah Williams

Table of Contents

Customer Information.....	2
Report Revision History	2
Table of Contents.....	3
1 Attestation of Test Results.....	4
1.1 Description of EUT	4
1.2 General Information	4
1.3 Summary of Test Results	4
1.4 Deviations from the Test Specification	4
2 Summary of Testing.....	5
2.1 Facilities and Accreditation	5
2.2 Methods and Procedures	5
2.3 Calibration and Uncertainty	6
2.4 Test and Measurement Equipment	7
3 Equipment Under Test (EUT)	9
3.1 Identification of Equipment Under Test (EUT)	9
3.2 Modifications Incorporated in the EUT	9
3.3 Additional Information Related to Testing	10
3.4 Description of Available Antennas	10
3.5 Description of Test Setup	11
4 Antenna Port Test Results	17
4.1 Transmitter 99% Occupied Bandwidth	17
4.2 Transmitter Minimum 6 dB Bandwidth	24
4.3 Transmitter Maximum Peak Output Power	31
4.4 Transmitter Power Spectral Density	42
5 Radiated Test Results.....	49
5.1 Transmitter Radiated Emissions <1 GHz	49
5.2 Transmitter Radiated Emissions >1 GHz	51
5.3 Transmitter Band Edge Radiated Emissions	53

1 Attestation of Test Results

1.1 Description of EUT

The equipment under test was an Apple desktop computer with Bluetooth® Low Energy, Thread and IEEE 802.11 a/b/g/n/ac/ax Wi-Fi capabilities in the 2.4 GHz, 5 GHz and 6 GHz bands.

1.2 General Information

Specification Reference:	47CFR15.247
Specification Title:	Code of Federal Regulations Volume 47 (Telecommunications): Part 15 Subpart C (Intentional Radiators) – Section 15.247
Specification Reference:	47CFR15.209
Specification Title:	Code of Federal Regulations Volume 47 (Telecommunications): Part 15 Subpart C (Intentional Radiators) – Section 15.209
Specification Reference:	RSS-Gen Issue 5 February 2021
Specification Title:	General Requirements for Compliance of Radio Apparatus
Specification Reference:	RSS-247 Issue 2 February 2017
Specification Title:	Digital Transmission Systems (DTSs), Frequency Hopping Systems (FHSs) and Licence-Exempt Local Area Network (LE-LAN) Devices
Site Registration:	FCC: 685609, ISEDC: 20903
FCC Lab. Designation No.:	UK2011
ISEDC CABID:	UK0001
Location of Testing:	Unit 3 Horizon, Wade Road, Kingsland Business Park, Basingstoke, Hampshire, G24 8AH, United Kingdom
Test Dates:	12 January 2023 to 10 March 2023

1.3 Summary of Test Results

FCC Reference (47CFR)	ISED Canada Reference	Measurement	Result
N/A	RSS-Gen 6.7	Transmitter 99% Occupied Bandwidth	Complied
Part 15.247(a)(2)	RSS-Gen 6.7 / RSS-247 5.2(a)	Transmitter Minimum 6 dB Bandwidth	Complied
Part 15.247(b)(3)	RSS-Gen 6.12 / RSS-247 5.4(d)	Transmitter Maximum Peak Output Power	Complied
Part 15.247(e)	RSS-247 5.2(b)	Transmitter Power Spectral Density	Complied
Part 15.247(d) & 15.209(a)	RSS-Gen 6.13 / RSS-247 5.5	Transmitter Radiated Emissions	Complied
Part 15.247(d) & 15.209(a)	RSS-Gen 6.13 / RSS-247 5.5	Transmitter Band Edge Radiated Emissions	Complied

1.4 Deviations from the Test Specification

For the measurements contained within this test report, there were no deviations from, additions to, or exclusions from the test specification identified above.

2 Summary of Testing

2.1 Facilities and Accreditation

The test site and measurement facilities used to collect data are located at Unit 3 Horizon, Wade Road, Kingsland Business Park, Basingstoke, Hampshire, RG24 8AH, United Kingdom. The following table identifies which facilities were utilised for radiated emission measurements documented in this report. Specific facilities are also identified in the test results sections.

Site 1	X
Site 2	-
Site 17	X

UL International (UK) Ltd is accredited by the United Kingdom Accreditation Service (UKAS). UKAS is one of the signatories to the International Laboratory Accreditation Co-operation (ILAC) Arrangement for the mutual recognition of test reports. The tests reported herein have been performed in accordance with its terms of accreditation.

2.2 Methods and Procedures

Reference:	ANSI C63.10-2013
Title:	American National Standard of Procedures for Compliance Testing of Unlicensed Wireless Devices
Reference:	KDB 558074 D01 15.247 Meas Guidance v05r02, April 2, 2019
Title:	Guidance for Compliance Measurements on Digital Transmission System, Frequency Hopping Spread Spectrum System, and Hybrid System Devices Operating Under Section 15.247 of the FCC Rules
Reference:	KDB 662911 D01 Multiple Transmitter Output v02r01 October 31, 2013
Title:	Emissions Testing of Transmitters with Multiple Outputs in the Same Band

2.3 Calibration and Uncertainty

Measuring Instrument Calibration

In accordance with UKAS requirements all the measurement equipment is on a calibration schedule. All equipment was within the calibration period on the date of testing.

Measurement Uncertainty & Decision Rule

Overview

No measurement or test can ever be perfect and the imperfections give rise to error of measurement in the results. Consequently the result of a measurement is only an approximation to the value of the measurand (the specific quantity subject to measurement) and is only complete when accompanied by a statement of the uncertainty of the approximation.

The expression of uncertainty of a measurement result allows realistic comparison of results with reference values and limits given in specifications and standards.

Decision Rule

The decision rule applied is based upon the accuracy method criteria. The measurement uncertainty is met and the result is considered in conformance with the requirement criteria if the observed value is within the prescribed limit.

Measurement Uncertainty

The reported expanded uncertainties below are based on a standard uncertainty multiplied by an appropriate coverage factor such that a confidence level of approximately 95% is maintained. For the purposes of this document “approximately” is interpreted as meaning “effectively” or “for most practical purposes”.

Measurement Type	Range	Confidence Level (%)	Calculated Uncertainty
99% Occupied Bandwidth	2.4 GHz to 2.4835 GHz	95%	±3.92 %
Minimum 6 dB Bandwidth	2.4 GHz to 2.4835 GHz	95%	±4.59 %
Spectral Power Density	2.4 GHz to 2.4835 GHz	95%	±1.13 dB
Conducted Maximum Peak Output Power	2.4 GHz to 2.4835 GHz	95%	±1.13 dB
Radiated Spurious Emissions	9 kHz to 30 MHz	95%	±5.32 dB
Radiated Spurious Emissions	30 MHz to 1 GHz	95%	±3.30 dB
Radiated Spurious Emissions	1 GHz to 25 GHz	95%	±3.16 dB

The methods used to calculate the above uncertainties are in line with those recommended within the various measurement specifications. Where measurement specifications do not include guidelines for the evaluation of measurement uncertainty the published guidance of the appropriate accreditation body is followed.

2.4 Test and Measurement Equipment

Test Equipment Used for Transmitter Conducted Tests

Asset No.	Instrument	Manufacturer	Type No.	Serial No.	Date Calibration Due	Cal. Interval (Months)
M2038	Thermohygrometer	Testo	608-H1	45124919	09 Dec 2023	12
A2507	Attenuator	AtlanTecRF	AN18-10	821846#2	Calibrated before use	-
M225862	Signal Analyser	Rohde & Schwarz	FSV3030	102010	21 Oct 2023	12
A214336	Attenuator	Atlantic Microwave	ATT06KXP-483082-S4S5	#1	Calibrated before use	-
A214341	Attenuator	Atlantic Microwave	ATT06KXP-483082-S4S5	#6	Calibrated before use	-
A214343	Attenuator	Atlantic Microwave	ATT06KXP-483082-S4S5	#8	Calibrated before use	-
A222203	Switch Box	UL	UK version #10010	#2	Calibrated before use	-
G207635	Signal Generator	Rohde & Schwarz	SMCV100B	103200	07 Oct 2025	36

Test and Measurement Equipment (continued)**Test Equipment Used for Transmitter Radiated Emissions Tests**

Asset No.	Instrument	Manufacturer	Type No.	Serial No.	Date Calibration Due	Cal. Interval (Months)
M2003	Thermohygrometer	Testo	608-H1	45046641	09 Dec 2023	12
K0017	3m RSE Chamber	Rainford	N/A	N/A	08 Nov 2023	12
M1995	Test Receiver	Rohde & Schwarz	ESU40	100428	02 Nov 2023	12
A2863	Pre Amplifier	Agilent	8449B	3008A02100	07 Nov 2023	12
A3167	Pre Amplifier	Com-Power	PAM-103	18020010	02 Nov 2023	12
A223628	Pre Amplifier	Atlantic Microwave	A-LNAKX-380116-S5S5	210837001	02 Nov 2023	12
A3265	Pre Amplifier	Schwarzbeck	BBV 9721	9721-069	31 Oct 2023	12
A490	Antenna	Chase	CBL6111A	1590	06 Oct 2023	12
A2889	Antenna	Schwarzbeck	BBHA 9120 B	653	02 Nov 2023	12
A2890	Antenna	Schwarzbeck	HWRD 750	014	02 Nov 2023	12
A2892	Antenna	Schwarzbeck	BBHA 9170	9170-727	31 Oct 2023	12
A2916	Attenuator	AtlanTecRF	AN18W5-10	832827#1	25 Jan 2024	12
A3036	Low Pass Filter	AtlanTecRF	AFL-02000	15062902848	25 Jan 2024	12
A2914	High Pass Filter	AtlanTecRF	AFH-03000	2155	25 Jan 2024	12
A212035	High Pass Filter	Micro-Tronics	HPS20722	001	25 Jan 2024	12
K0001	3m RSE Chamber	Rainford EMC	N/A	N/A	05 Sep 2023	12
M2040	Thermohygrometer	Testo	608-H1	45124934	09 Dec 2023	12
M1874	Test Receiver	Rohde & Schwarz	ESU26	100553	19 May 2023	12
A3165	Magnetic Loop Antenna	ETS-Lindgren	6502	00224383	05 May 2023	12

Test Equipment Used for Transmitter Band Edge Radiated Emissions Tests

Asset No.	Instrument	Manufacturer	Type No.	Serial No.	Date Calibration Due	Cal. Interval (Months)
M2003	Thermohygrometer	Testo	608-H1	45046641	09 Dec 2023	12
K0017	3m RSE Chamber	Rainford	N/A	N/A	08 Nov 2023	12
M1995	Test Receiver	Rohde & Schwarz	ESU40	100428	02 Nov 2023	12
A2863	Pre Amplifier	Agilent	8449B	3008A02100	07 Nov 2023	12
A2916	Attenuator	AtlanTecRF	AN18W5-10	832827#1	25 Jan 2024	12
A2889	Antenna	Schwarzbeck	BBHA 9120 B	BBHA 9120B653	02 Nov 2023	12

3 Equipment Under Test (EUT)

3.1 Identification of Equipment Under Test (EUT)

Brand Name:	Apple
Model Name or Number / HVIN:	A2874
PMN:	iMac
Test Sample Serial Number:	M2662LV76V (<i>Conducted sample</i>)
Hardware Version:	REV 1.0
Software Version:	22E31551a
FCC ID:	BCGA2874
ISED Canada Certification Number:	IC: 579C-A2874
Date of Receipt:	21 February 2023

Brand Name:	Apple
Model Name or Number / HVIN:	A2874
PMN:	iMac
Test Sample Serial Number:	NQHHW969D9 (<i>Radiated sample</i>)
Hardware Version:	REV 1.0
Software Version:	22E31550w
FCC ID:	BCGA2874
ISED Canada Certification Number:	IC: 579C-A2874
Date of Receipt:	10 January 2023

3.2 Modifications Incorporated in the EUT

No modifications were applied to the EUT during testing.

3.3 Additional Information Related to Testing

Technology Tested:	<i>Bluetooth</i> (Digital Transmission System)		
Type of Unit:	Transceiver		
Channel Spacing:	1 MHz		
Mode	High Data Rate		
Modulation:	$\pi/4$ -DQPSK		
Packet Type (Maximum Payload):	4DH5	8DH5	
Data Rate (Mbps):	4	8	
Power Supply Requirement(s):	Nominal	12 VDC via 120 VAC 60 Hz adaptor	
Maximum Conducted Output Power:	19.1 dBm		
Transmit Frequency Range:	2404 MHz to 2476 MHz		
Transmit Channels Tested:	Channel ID	Channel Number	Channel Frequency (MHz)
	Bottom	2	2404
	Middle	39	2441
	Top	74	2476

3.4 Description of Available Antennas

The radio utilizes two integrated antennas, with the following maximum gain:

Antenna Port	Frequency Range (MHz)	Antenna Gain (dBi)
Core 0	2400 to 2480	2.1
Core 1	2400 to 2480	3.6

The EUT also supports TxBF with unequal gains and equal transmit powers. Calculations for directional gain were in accordance with KDB 662911 D01 v02r01 Section F)2)d)(i). Directional gain of Core 0 & Core 1 was calculated as:

$N_{ANT} = 2$, $G_{Core0} = 2.1$ dBi, $G_{Core1} = 3.6$ dBi

$$\begin{aligned} \text{Directional Gain} &= 10 \log \left[\frac{\left(10^{\frac{G_1}{20}} + 10^{\frac{G_2}{20}} + \dots + 10^{\frac{G_N}{20}} \right)^2}{N_{ANT}} \right] = 10 \log \left[\frac{\left(10^{\frac{G_1}{20}} + 10^{\frac{G_2}{20}} \right)^2}{2} \right] \\ &= 10 \log \left[\frac{\left(10^{\frac{2.1}{20}} + 10^{\frac{3.6}{20}} \right)^2}{2} \right] = 5.9 \text{ dBi} \end{aligned}$$

3.5 Description of Test Setup

Support Equipment

The following support equipment was used to exercise the EUT during testing:

Description:	Test Laptop
Brand Name:	Apple
Model Name or Number:	MacBook Pro
Serial Number:	C02YK003L59F

Description:	USB Diagnostic Cable
Brand Name:	Apple
Model Name or Number:	Chimp
Serial Number:	428A84

Description:	USB-A Cable. Quantity 2. Length 3 m.
Brand Name:	Not marked or stated
Model Name or Number:	Not marked or stated
Serial Number:	Not marked or stated

Description:	USB-C to A Adaptor. Quantity 2. Length 10 cm.
Brand Name:	Not marked or stated
Model Name or Number:	Not marked or stated
Serial Number:	Not marked or stated

Description:	4 port USB Termination Hub
Brand Name:	Uni
Model Name or Number:	Not marked or stated
Serial Number:	Not marked or stated

Description:	Personal Hands Free (PHF)
Brand Name:	Not marked or stated
Model Name or Number:	Not marked or stated
Serial Number:	Not marked or stated

Description:	Power Adaptor
Brand Name:	Apple
Model Name or Number:	A2290
Serial Number:	Not marked or stated

Support Equipment (continued)

Description:	Test Laptop
Brand Name:	Apple
Model Name or Number:	MacBook Pro
Serial Number:	C02C8009P22C

Description:	USB Diagnostic Cable
Brand Name:	Apple
Model Name or Number:	Chimp
Serial Number:	304708

Operating Modes

The EUT was tested in the following operating mode(s):

- Continuously transmitting at maximum power on bottom, middle and top channels in HDR (4DH5 or 8DH5 packets) as required.

Configuration and Peripherals

The EUT was tested in the following configuration(s):

- Controlled in test mode using a set of commands entered into a terminal application on the test laptop supplied by the customer. The commands were used to enable a continuous transmission and to select the test channels as required. The customer supplied a document containing the setup instructions.
- The EUT has two cores which operate in both SISO and TxBF modes. Core 0 & Core 1 are identical but have unequal gains therefore conducted tests have been performed on the Core with the highest antenna gain. Modes tested were:
 - 4DH5 / SISO / Core 1
 - 8DH5 / SISO / Core 1
 - 4DH5 / Beamforming / Core 0 + Core 1
 - 8DH5 / Beamforming / Core 0 + Core 1
- The customer supplied U.FL RF cables with the EUT in order to perform conducted measurements. This measured additional path loss was included in any path loss calculations.
- The EUT was powered from a 120 VAC 60 Hz single phase mains supply.
- Transmitter radiated spurious emissions tests were performed with the EUT transmitting in 4DH5 Beamforming Core 0 + Core 1 mode, as this mode was found to transmit the highest power and spectral density.
- Radiated spurious emissions were performed with the EUT in its normal orientation. All ports were terminated into suitable terminations and placed under the turntable.

Test Setup Diagrams

Conducted Tests:

Test Setup for Transmitter Conducted Tests

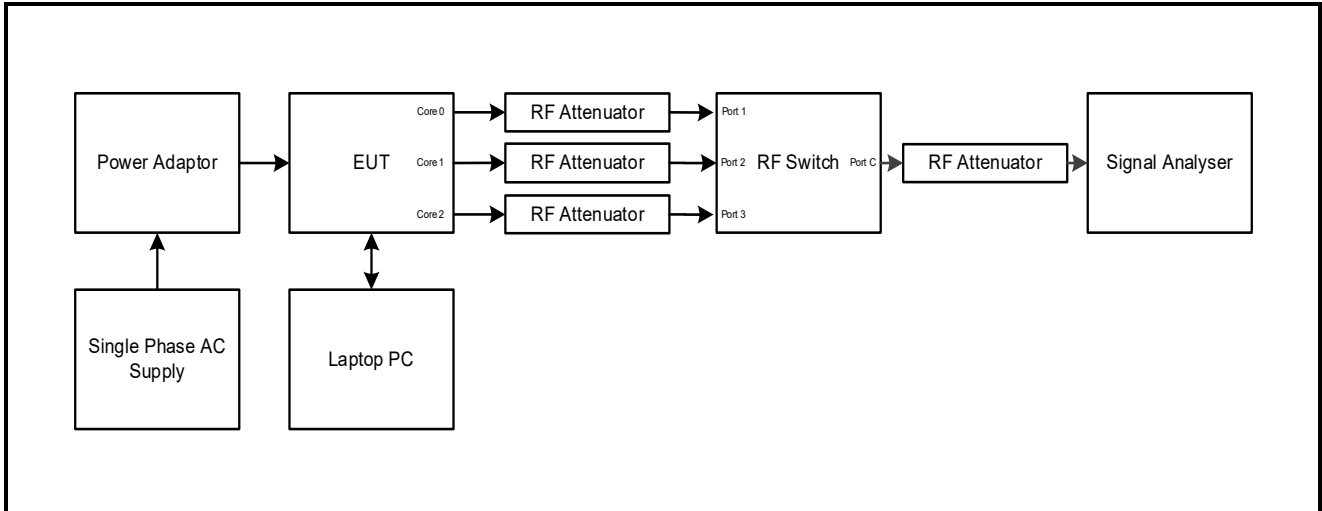

Test Setup Diagrams (continued)

Radiated Tests:

Test Setup for Transmitter Radiated Emissions

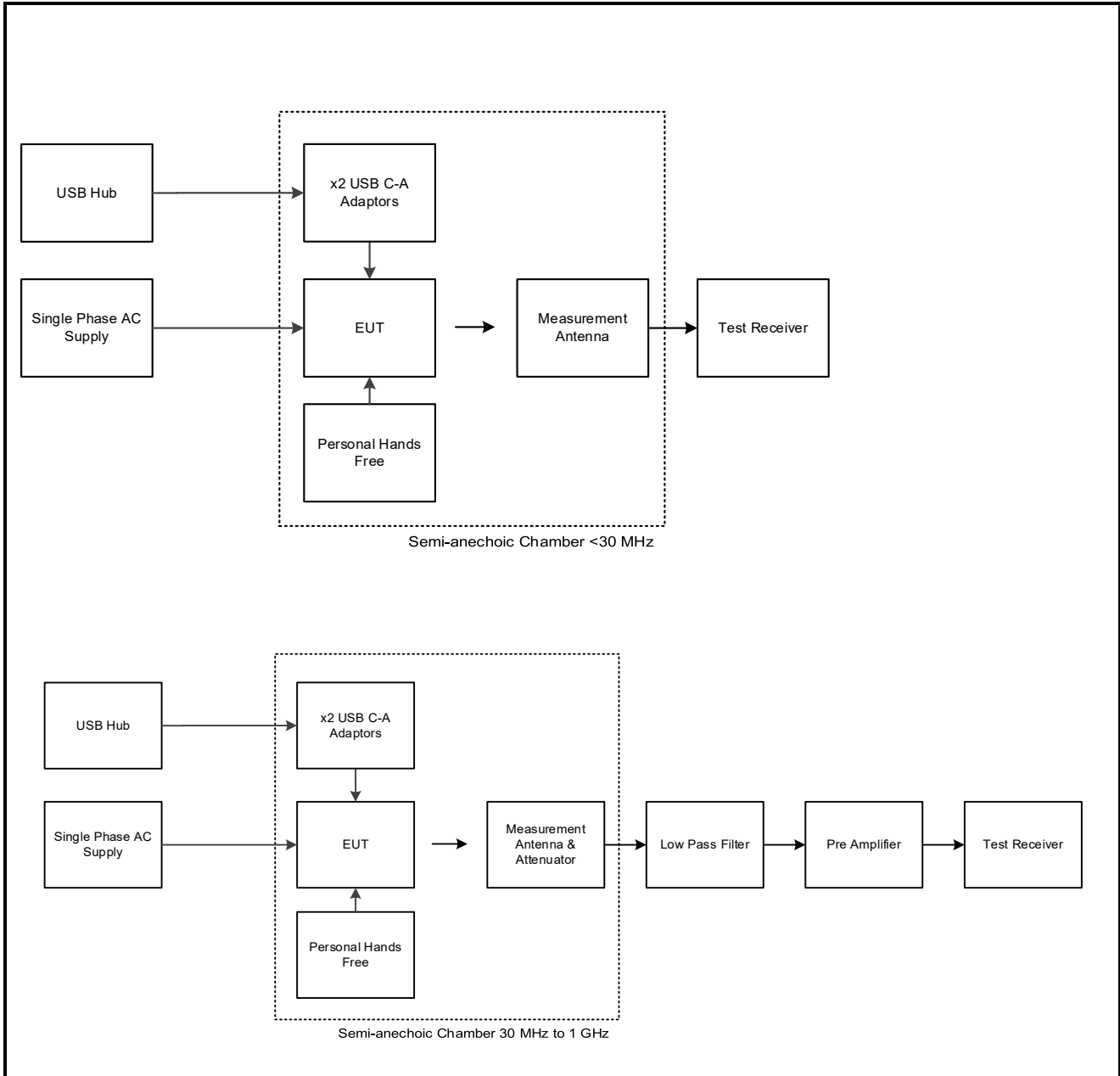

Test Setup Diagrams (continued)

Test Setup for Transmitter Radiated Emissions (continued)

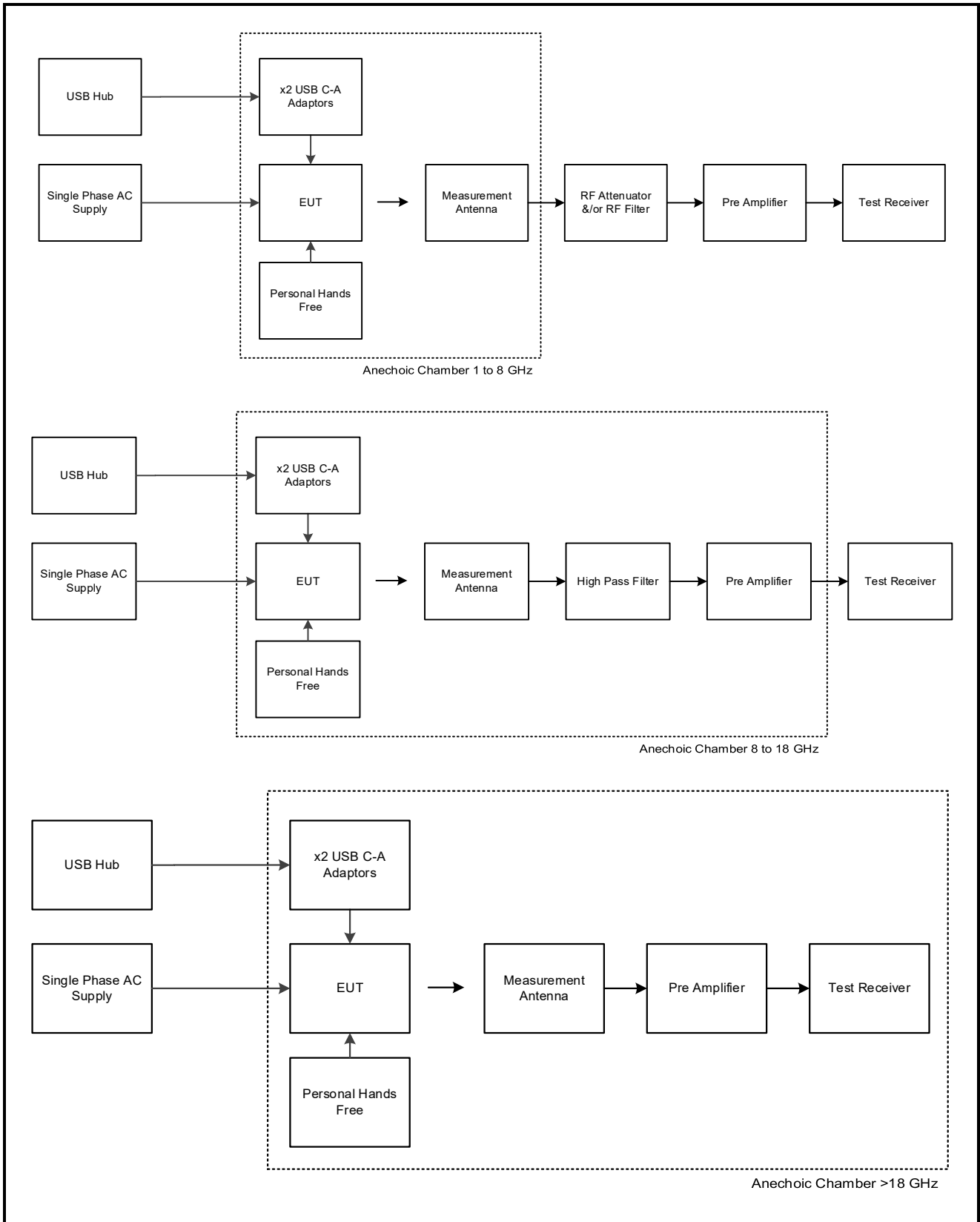

4 Antenna Port Test Results

4.1 Transmitter 99% Occupied Bandwidth

Test Summary:

Test Engineers:	Matthew Botfield & Miriam Thompson	Test Date:	09 March 2023 & 10 March 2023
Test Sample Serial Number:	M2662LV76V		

FCC Reference:	N/A
ISED Canada Reference:	RSS-Gen 6.7
Test Method Used:	RSS-Gen 6.7 and Notes below

Environmental Conditions:

Temperature (°C):	19
Relative Humidity (%):	42 to 48

Note(s):

1. The 99% emission bandwidth was measured using the signal analyser occupied bandwidth function. The resolution bandwidth was set in the range of 1% to 5% of the occupied bandwidth and the video bandwidth set to 3 times the resolution bandwidth. The span was set to capture all products of the modulation process including emission skirts.
2. For 4DH5, the signal analyser resolution bandwidth was set to 50 kHz and video bandwidth 200 kHz. A peak detector was used, sweep time was set to auto and the trace mode was Max Hold. The span was set to 10 MHz. The signal analyser function set the measurements to be made at 99% of the emission bandwidth. The results are given in the tables below.
3. For 8DH5, the signal analyser resolution bandwidth was set to 100 kHz and video bandwidth 300 kHz. A peak detector was used, sweep time was set to auto and the trace mode was Max Hold. The span was set to 20 MHz. The signal analyser function set the measurements to be made at 99% of the emission bandwidth. The results are given in the tables below.
4. The signal analyser was connected to the RF port on the EUT using suitable attenuation and RF cable.

Transmitter 99% Occupied Bandwidth (continued)

Results: 4DH5 / SISO / Core 1

Channel	99% Occupied Bandwidth (kHz)
Bottom	2320.147
Middle	2319.176
Top	2319.583

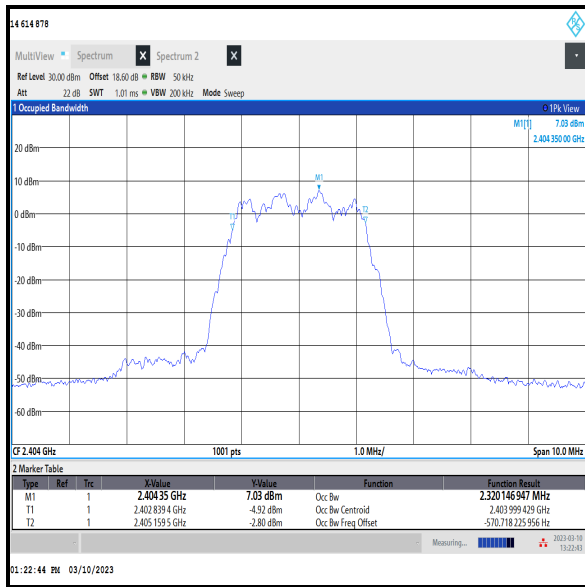

Bottom Channel



Middle Channel

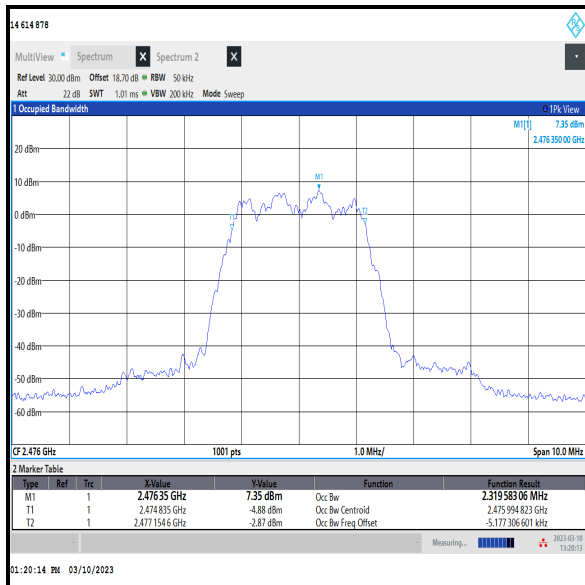

Top Channel

Transmitter 99% Occupied Bandwidth (continued)

Results: 8DH5 / SISO / Core 1

Channel	99% Occupied Bandwidth (kHz)
Bottom	4861.459
Middle	4861.402
Top	4860.080

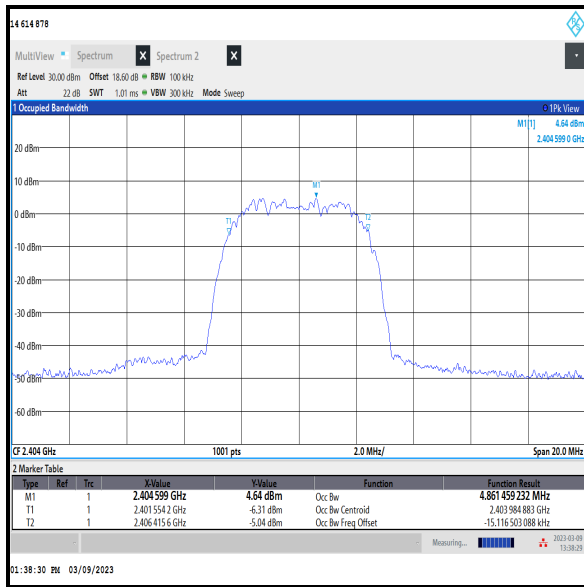

Bottom Channel

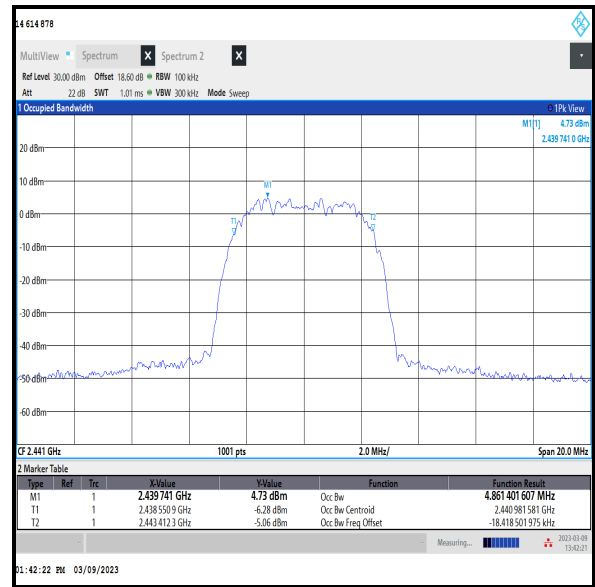

Middle Channel

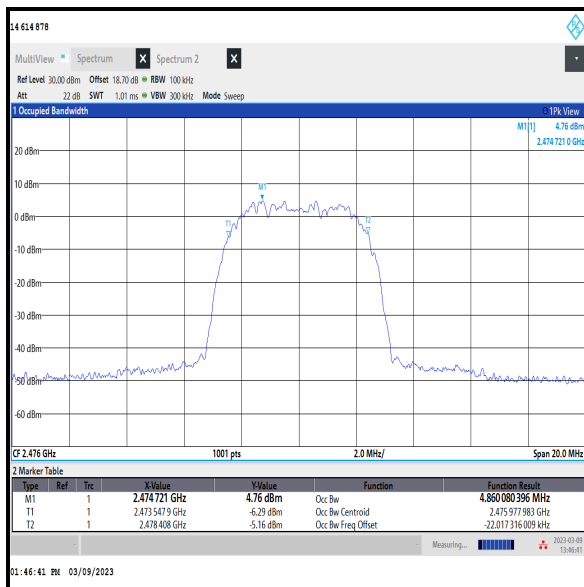

Top Channel

Transmitter 99% Occupied Bandwidth (continued)

Results: 4DH5 / Beamforming / Core 0

Channel	99% Occupied Bandwidth (kHz)
Bottom	2318.636
Middle	2319.152
Top	2319.759



Bottom Channel



Middle Channel

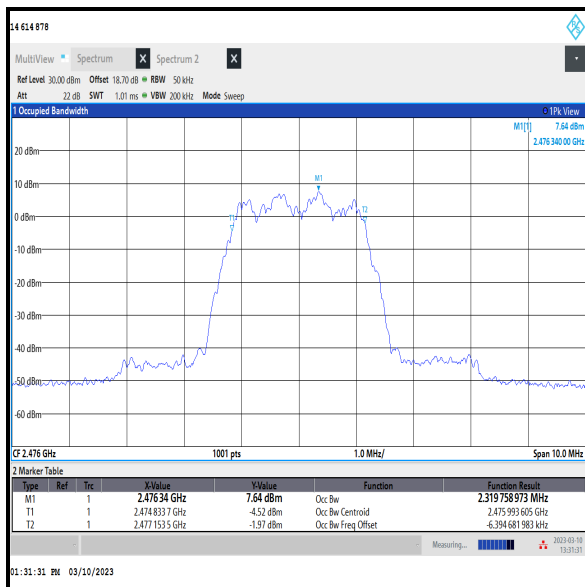

Top Channel

Transmitter 99% Occupied Bandwidth (continued)

Results: 4DH5 / Beamforming / Core 1

Channel	99% Occupied Bandwidth (kHz)
Bottom	2319.620
Middle	2320.373
Top	2319.740

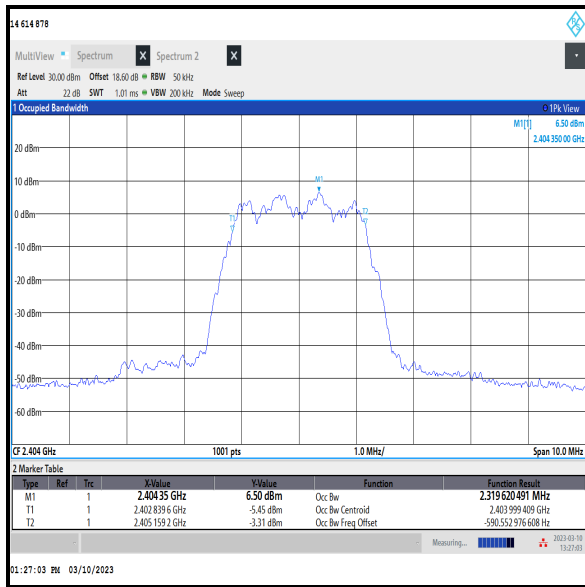

Bottom Channel

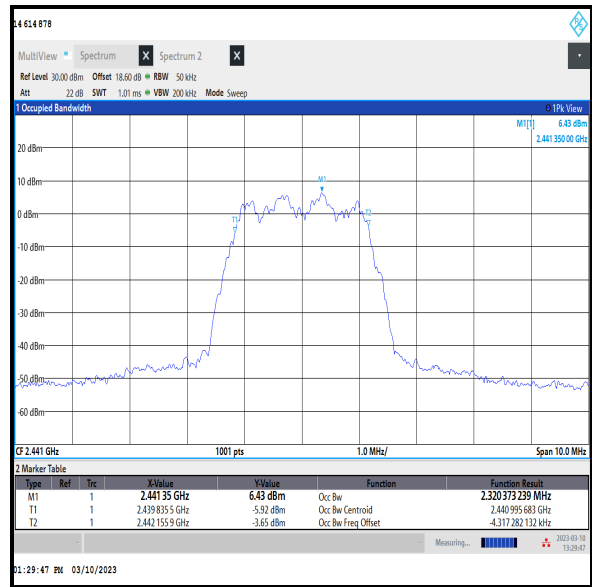

Middle Channel

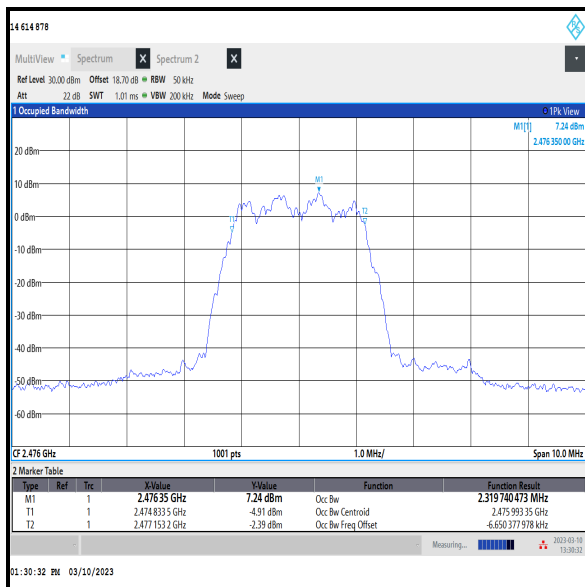

Top Channel

Transmitter 99% Occupied Bandwidth (continued)

Results: 8DH5 / Beamforming / Core 0

Channel	99% Occupied Bandwidth (kHz)
Bottom	4857.465
Middle	4857.801
Top	4859.596



Bottom Channel

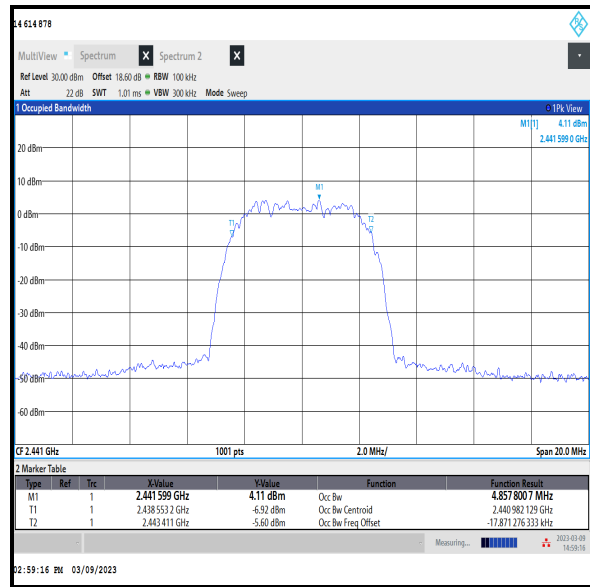

Middle Channel

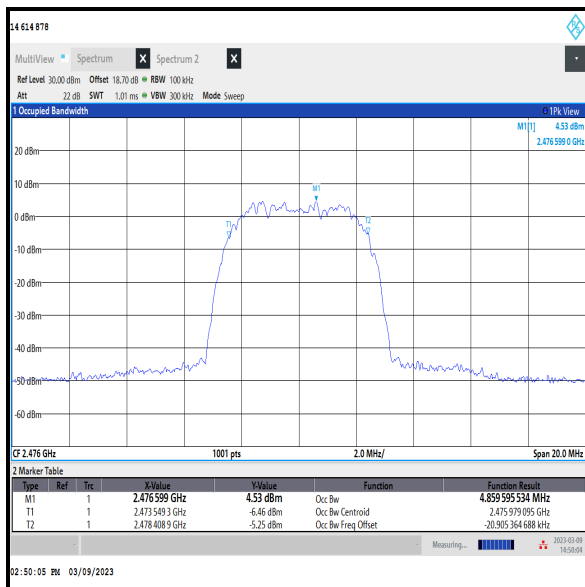

Top Channel

Transmitter 99% Occupied Bandwidth (continued)

Results: 8DH5 / Beamforming / Core 1

Channel	99% Occupied Bandwidth (kHz)
Bottom	4865.538
Middle	4862.417
Top	4862.370

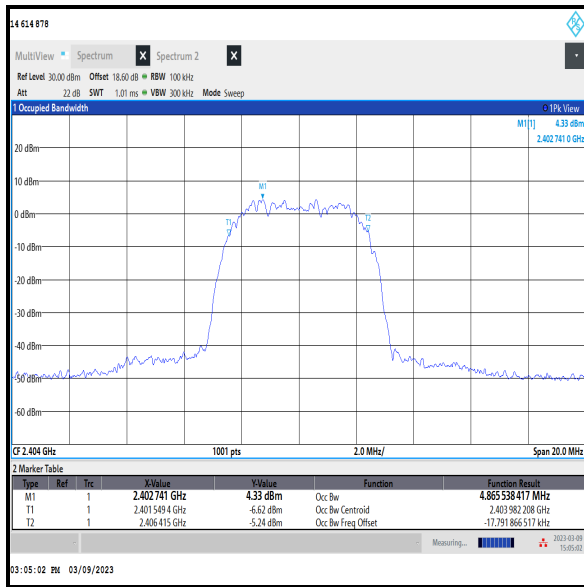

Bottom Channel

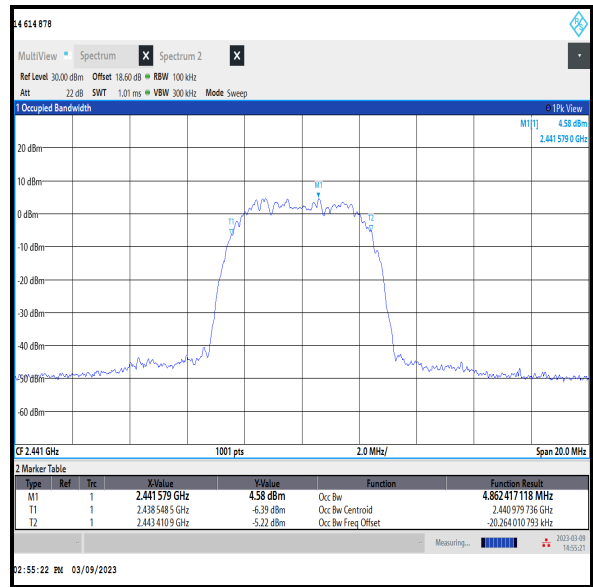

Middle Channel

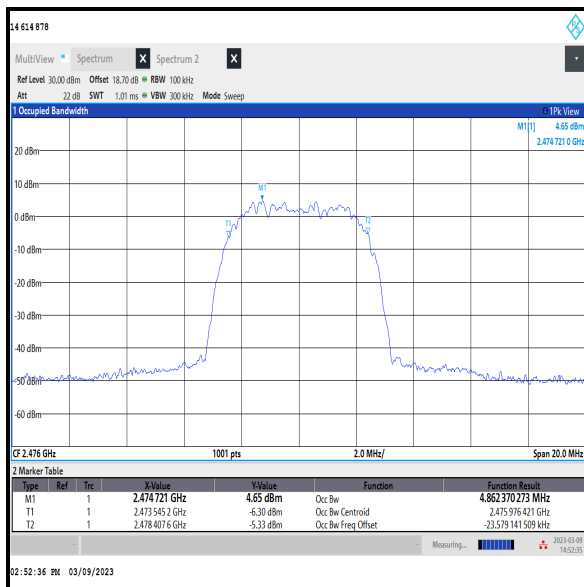

Top Channel

4.2 Transmitter Minimum 6 dB Bandwidth

Test Summary:

Test Engineers:	Matthew Botfield & Miriam Thompson	Test Date:	09 March 2023
Test Sample Serial Number:	M2662LV76V		

FCC Reference:	Part 15.247(a)(2)
ISED Canada Reference:	RSS-Gen 6.7 / RSS-247 5.2(a)
Test Method Used:	FCC KDB 558074 Section 8.2 referencing ANSI C63.10 Section 11.8.1

Environmental Conditions:

Temperature (°C):	19
Relative Humidity (%):	42

Note(s):

- 6 dB DTS bandwidth tests were performed using a signal analyser in accordance with ANSI C63.10 Section 11.8.1 Option 1 measurement procedure. The signal analyser resolution bandwidth was set to 100 kHz and video bandwidth 300 kHz. A peak detector was used, sweep time was set to auto and the trace mode was Max Hold. The DTS bandwidth was measured at 6 dB down from the peak of the signal.
- The signal analyser was connected to the RF port on the EUT using suitable attenuation and RF cable.

Transmitter Minimum 6 dB Bandwidth (continued)

Results: 4DH5 / SISO / Core 1

Channel	6 dB Bandwidth (kHz)	Limit (kHz)	Margin (kHz)	Result
Bottom	2112.900	≥500	1612.900	Complied
Middle	2112.900	≥500	1612.900	Complied
Top	2112.900	≥500	1612.900	Complied

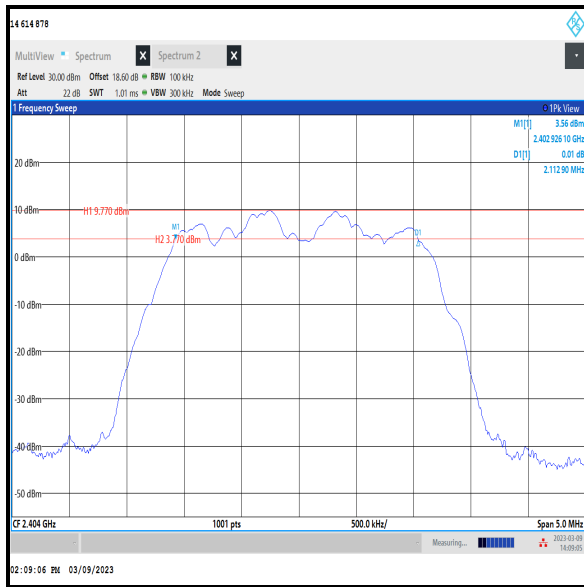

Bottom Channel

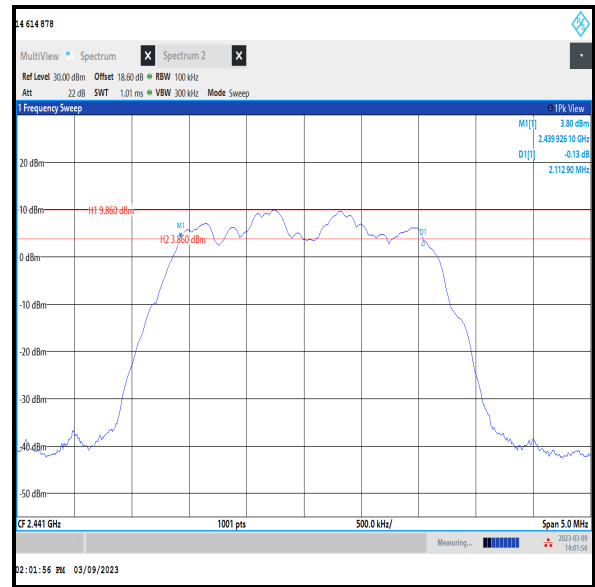

Middle Channel

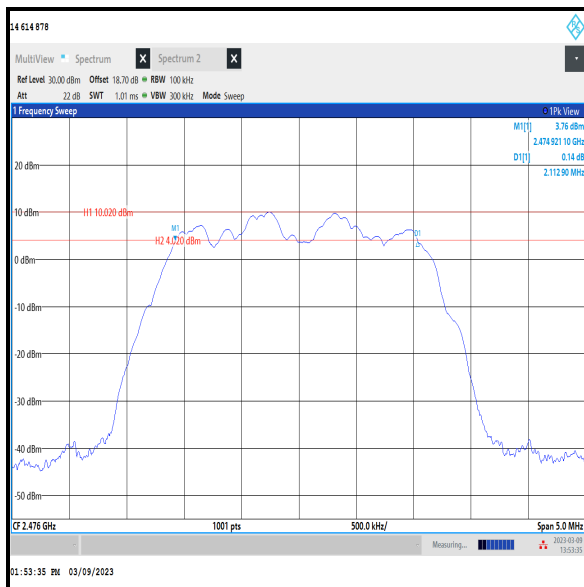

Top Channel

Transmitter Minimum 6 dB Bandwidth (continued)

Results: 8DH5 / SISO / Core 1

Channel	6 dB Bandwidth (kHz)	Limit (kHz)	Margin (kHz)	Result
Bottom	4206.000	≥500	3706.000	Complied
Middle	4206.000	≥500	3706.000	Complied
Top	4206.000	≥500	3706.000	Complied

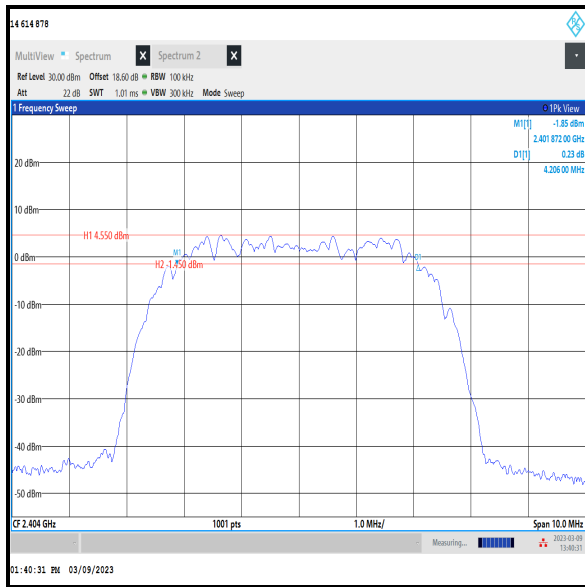

Bottom Channel

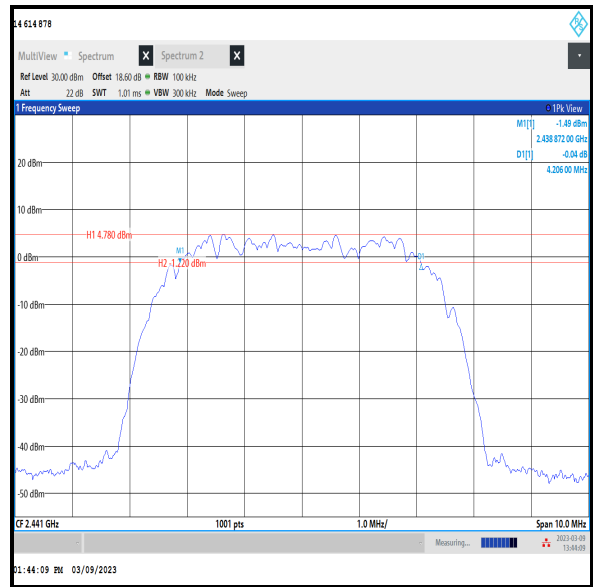

Middle Channel

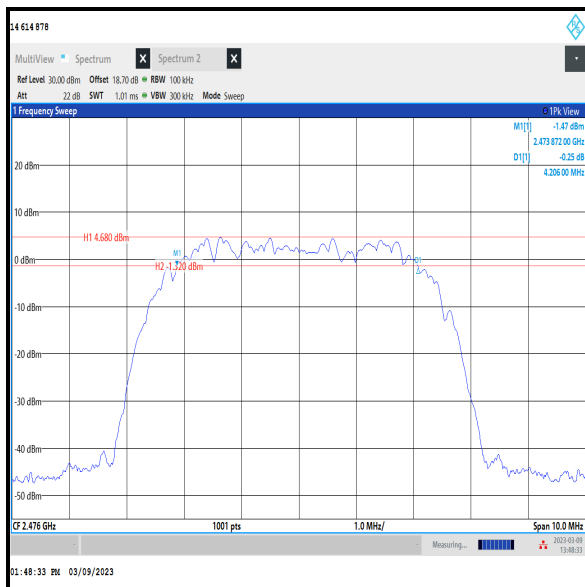

Top Channel

Transmitter Minimum 6 dB Bandwidth (continued)

Results: 4DH5 / Beamforming / Core 0

Channel	6 dB Bandwidth (kHz)	Limit (kHz)	Margin (kHz)	Result
Bottom	2112.900	≥500	1612.900	Complied
Middle	2107.900	≥500	1607.900	Complied
Top	2112.900	≥500	1612.900	Complied

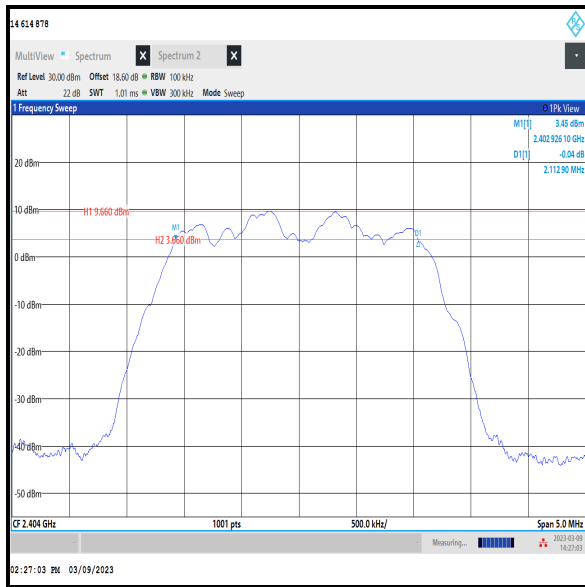

Bottom Channel

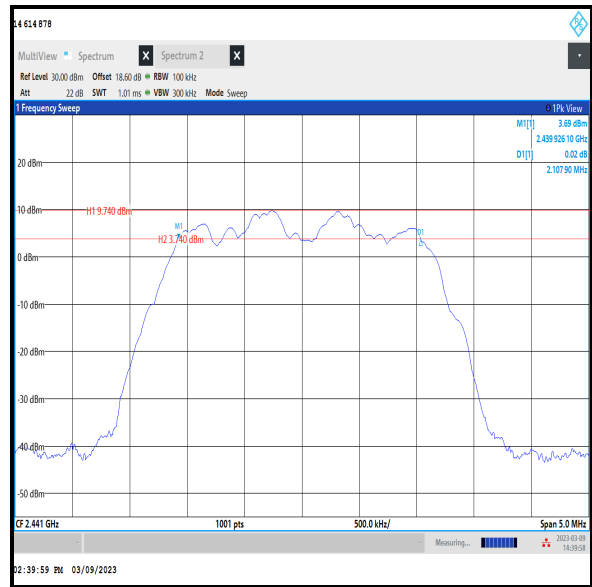

Middle Channel

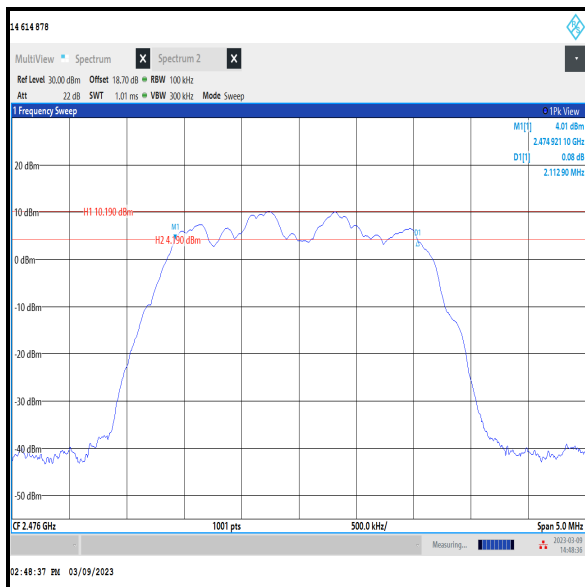

Top Channel

Transmitter Minimum 6 dB Bandwidth (continued)

Results: 4DH5 / Beamforming / Core 1

Channel	6 dB Bandwidth (kHz)	Limit (kHz)	Margin (kHz)	Result
Bottom	2107.900	≥500	1607.900	Complied
Middle	2112.900	≥500	1612.900	Complied
Top	2107.900	≥500	1607.900	Complied

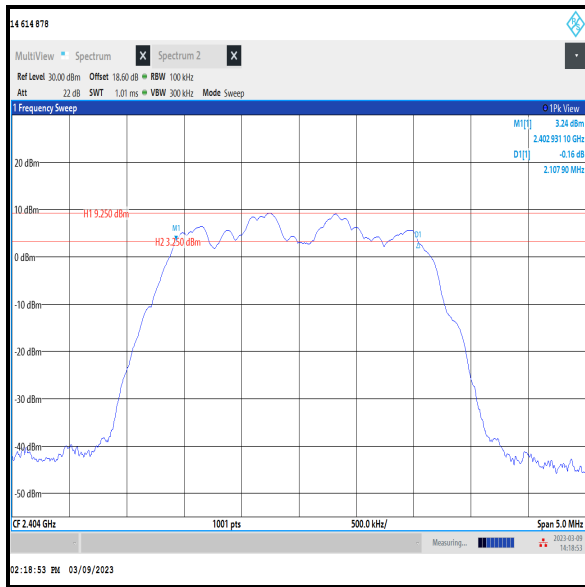

Bottom Channel

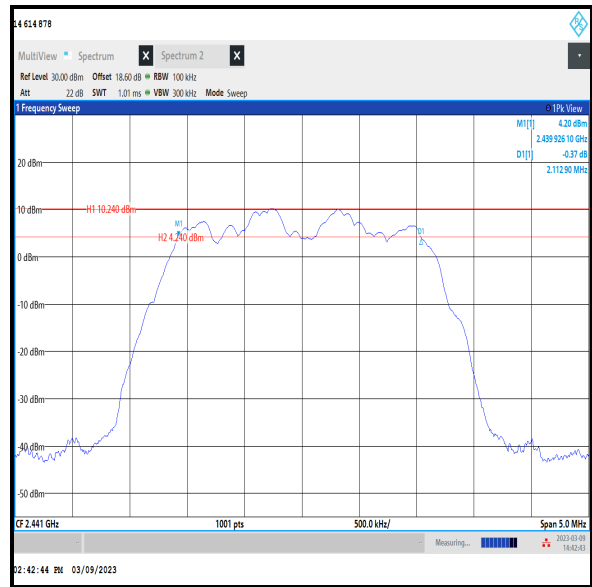

Middle Channel

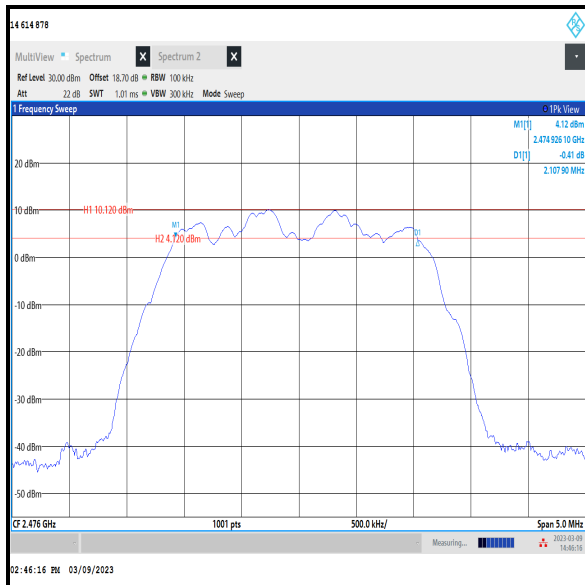

Top Channel

Transmitter Minimum 6 dB Bandwidth (continued)

Results: 8DH5 / Beamforming / Core 0

Channel	6 dB Bandwidth (kHz)	Limit (kHz)	Margin (kHz)	Result
Bottom	4206.000	≥500	3706.000	Complied
Middle	4206.000	≥500	3706.000	Complied
Top	4200.000	≥500	3700.000	Complied

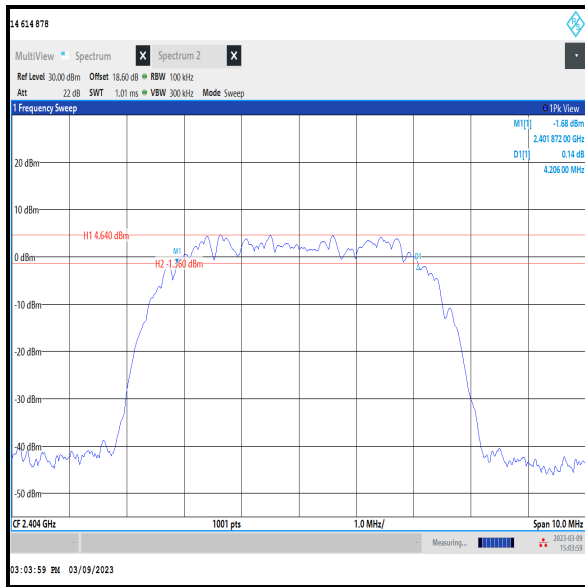

Bottom Channel

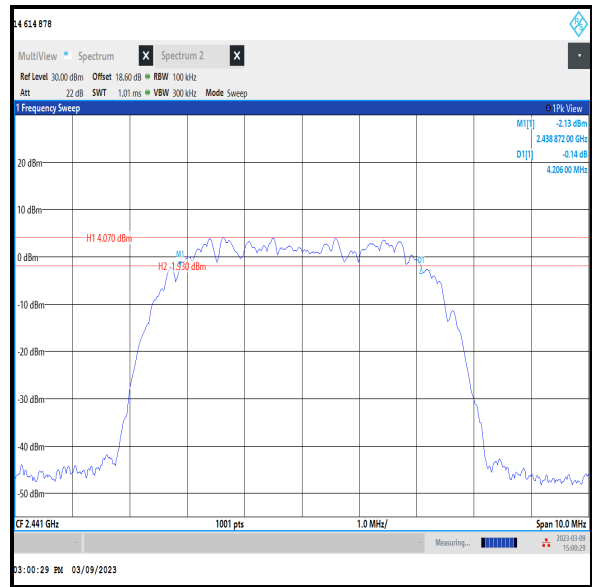

Middle Channel

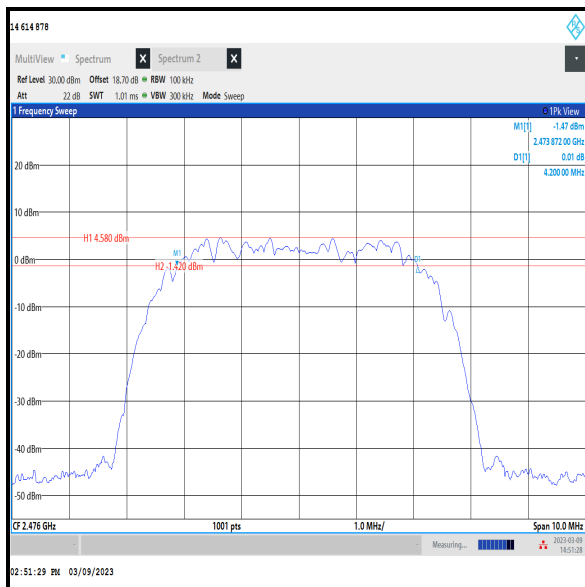

Top Channel

Transmitter Minimum 6 dB Bandwidth (continued)

Results: 8DH5 / Beamforming / Core 1

Channel	6 dB Bandwidth (kHz)	Limit (kHz)	Margin (kHz)	Result
Bottom	4206.000	≥500	3706.000	Complied
Middle	4206.000	≥500	3706.000	Complied
Top	4200.000	≥500	3700.000	Complied

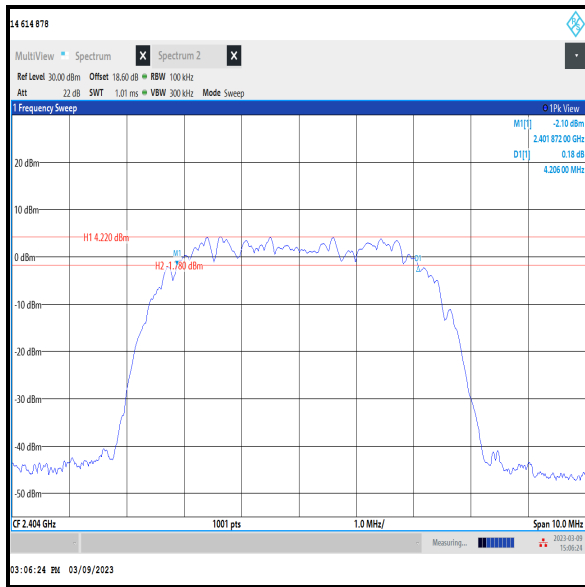

Bottom Channel

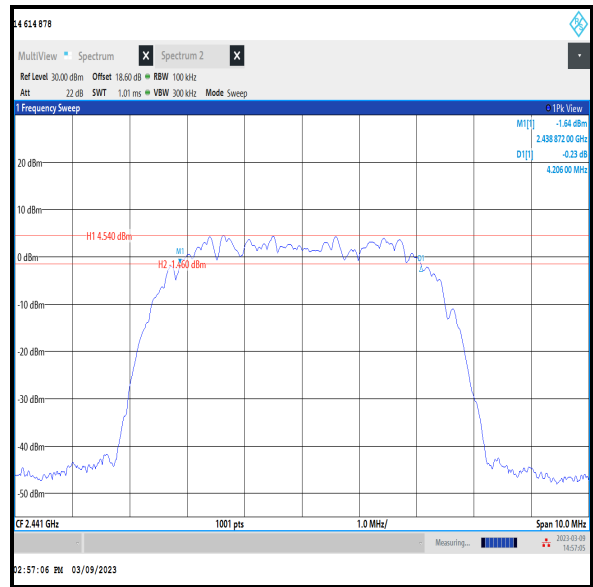

Middle Channel

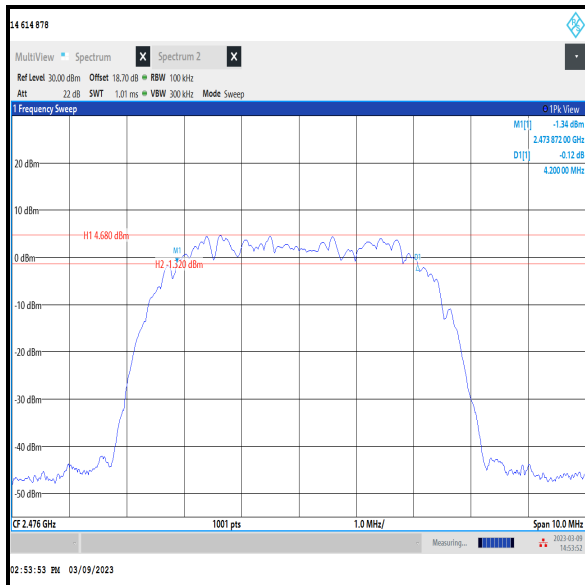

Top Channel

4.3 Transmitter Maximum Peak Output Power

Test Summary:

Test Engineers:	Matthew Botfield & Miriam Thompson	Test Date:	09 March 2023
Test Sample Serial Number:	M2662LV76V		

FCC Reference:	Part 15.247(b)(3)
ISED Canada Reference:	RSS-Gen 6.12 / RSS-247 5.4(d)
Test Method Used:	FCC KDB 558074 Section 8.3.1.1 referencing ANSI C63.10 Section 11.9.1.1 and Notes below

Environmental Conditions:

Temperature (°C):	19
Relative Humidity (%):	42

Note(s):

1. Conducted power tests were performed using a signal analyser in accordance with ANSI C63.10 Section 11.9.1.1 with the RBW \geq DTS bandwidth procedure.
2. For 4DH5, the signal analyser resolution bandwidth was set to 3 MHz and video bandwidth of 10 MHz. A peak detector was used, sweep time was set to auto and trace mode was Max Hold. The span was set to 9 MHz. A marker was placed at the peak of the signal and the results recorded in the tables below.
3. For 8DH5, the signal analyser resolution bandwidth was set to 5 MHz and video bandwidth of 20 MHz. A peak detector was used, sweep time was set to auto and trace mode was Max Hold. The span was set to 15 MHz. A marker was placed at the peak of the signal and the results recorded in the tables below.
4. For beamforming modes, conducted power was measured on Core 0 & Core 1 and then combined using the measure-and-sum technique stated in FCC KDB 662911 D01 Section E)1). For EIRP, the directional antenna gain was added to the conducted output power.
5. The signal analyser was connected to the RF port on the EUT using suitable attenuation and RF cable. An RF level offset was entered on the signal analyser to compensate for the loss of the attenuator and RF cable.

Transmitter Maximum Peak Output Power (continued)**Results: 4DH5 / SISO / Core 1**

Channel	Conducted Peak Power (dBm)	Conducted Peak Power Limit (dBm)	Margin (dB)	Result
Bottom	15.4	30.0	14.6	Complied
Middle	15.5	30.0	14.5	Complied
Top	15.8	30.0	14.2	Complied

Channel	Conducted Peak Power (dBm)	Declared Antenna Gain (dBi)	EIRP (dBm)	EIRP Limit (dBm)	Margin (dB)	Result
Bottom	15.4	3.6	19.0	36.0	17.0	Complied
Middle	15.5	3.6	19.1	36.0	16.9	Complied
Top	15.8	3.6	19.4	36.0	16.6	Complied

Transmitter Maximum Peak Output Power (continued)

Results: 4DH5 / SISO / Core 1

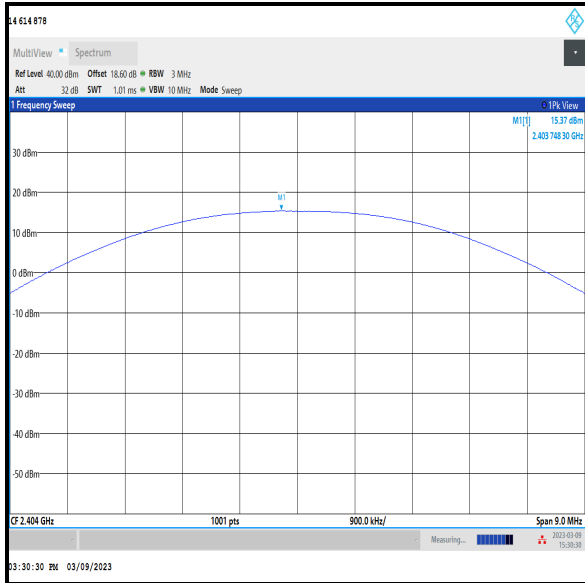

Bottom Channel

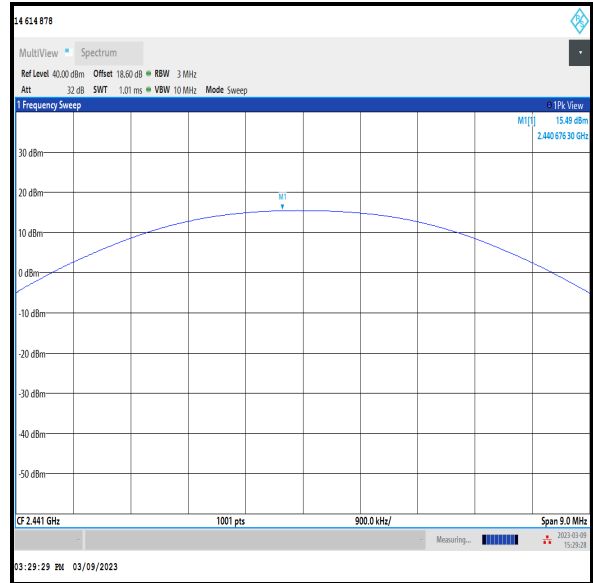

Middle Channel

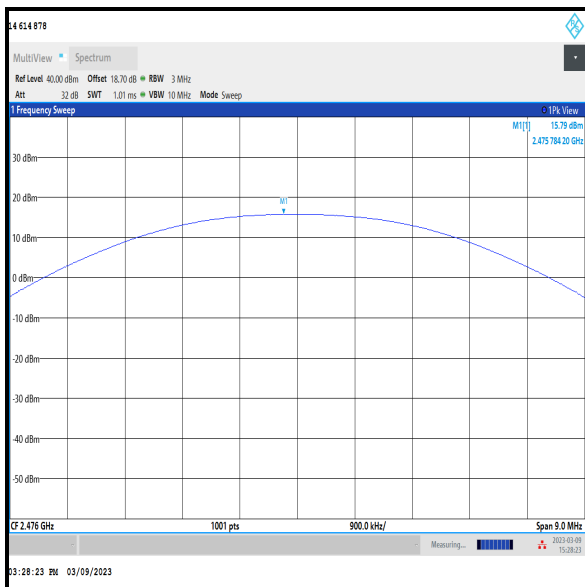

Top Channel

Transmitter Maximum Peak Output Power (continued)**Results: 8DH5 / SISO / Core 1**

Channel	Conducted Peak Power (dBm)	Conducted Peak Power Limit (dBm)	Margin (dB)	Result
Bottom	14.4	30.0	15.6	Complied
Middle	14.6	30.0	15.4	Complied
Top	14.2	30.0	15.8	Complied

Channel	Conducted Peak Power (dBm)	Declared Antenna Gain (dBi)	EIRP (dBm)	EIRP Limit (dBm)	Margin (dB)	Result
Bottom	14.4	3.6	18.0	36.0	18.0	Complied
Middle	14.6	3.6	18.2	36.0	17.8	Complied
Top	14.2	3.6	17.8	36.0	18.2	Complied

Transmitter Maximum Peak Output Power (continued)

Results: 8DH5 / SISO / Core 1

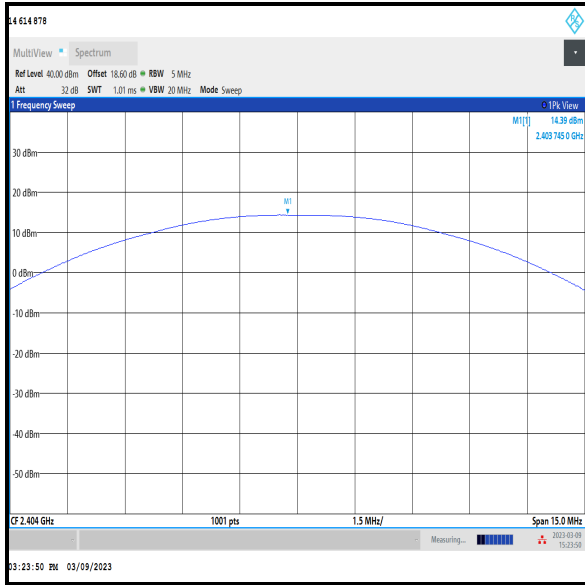

Bottom Channel

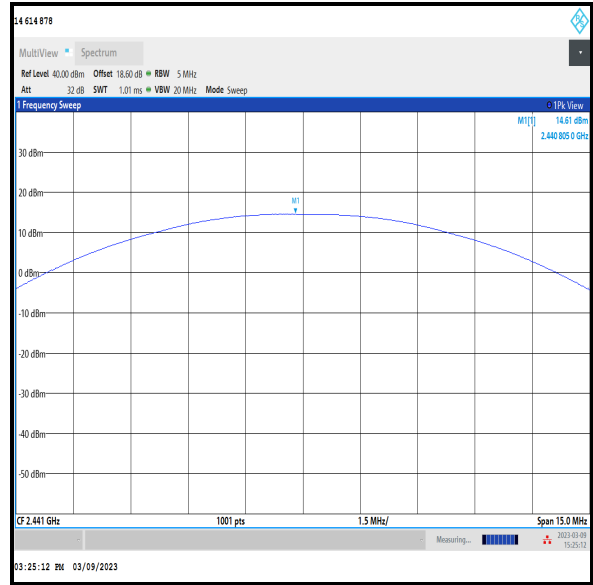

Middle Channel

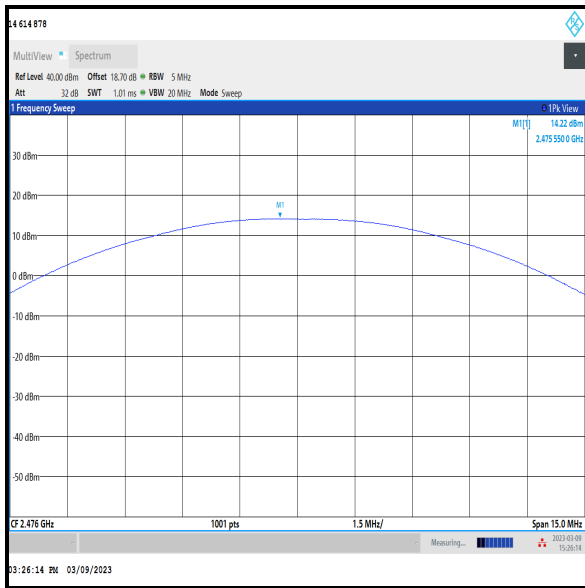

Top Channel

Transmitter Maximum Peak Output Power (continued)**Results: 4DH5 / Beamforming**

Channel	Conducted Peak Power Core 0 (dBm)	Conducted Peak Power Core 1 (dBm)	Combined Conducted Peak Power (dBm)	Conducted Peak Power Limit (dBm)	Margin (dB)	Result
Bottom	15.6	15.2	18.4	30.0	11.6	Complied
Middle	15.6	15.6	18.6	30.0	11.4	Complied
Top	15.9	16.3	19.1	30.0	10.9	Complied

Channel	Conducted Peak Power (dBm)	Declared Antenna Gain (dBi)	EIRP (dBm)	EIRP Limit (dBm)	Margin (dB)	Result
Bottom	18.4	5.9	24.3	36.0	11.7	Complied
Middle	18.6	5.9	24.5	36.0	11.5	Complied
Top	19.1	5.9	25.0	36.0	11.0	Complied

Transmitter Maximum Peak Output Power (continued)

Results: 4DH5 / Beamforming / Core 0

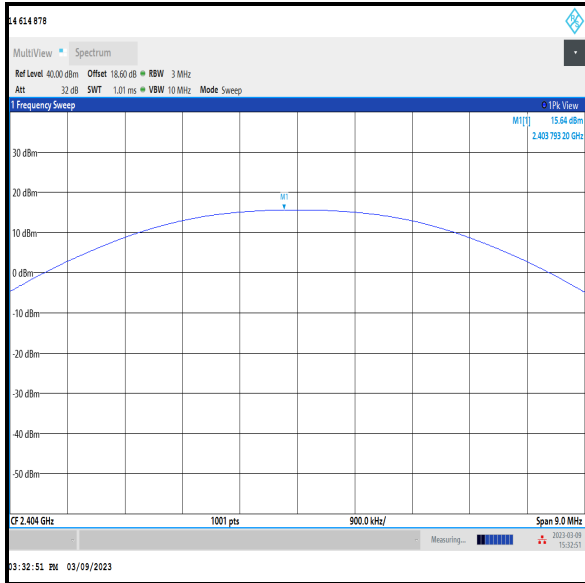

Bottom Channel

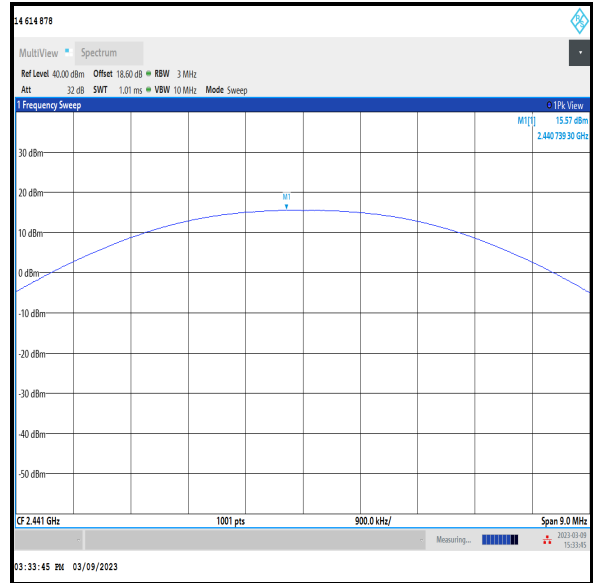

Middle Channel

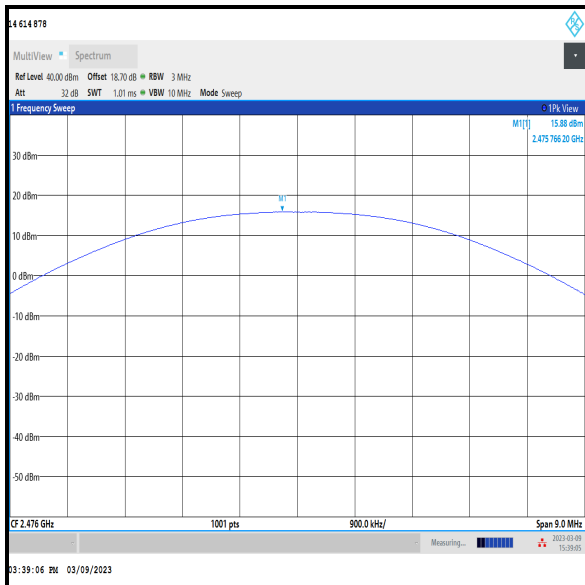

Top Channel

Transmitter Maximum Peak Output Power (continued)

Results: 4DH5 / Beamforming / Core 1

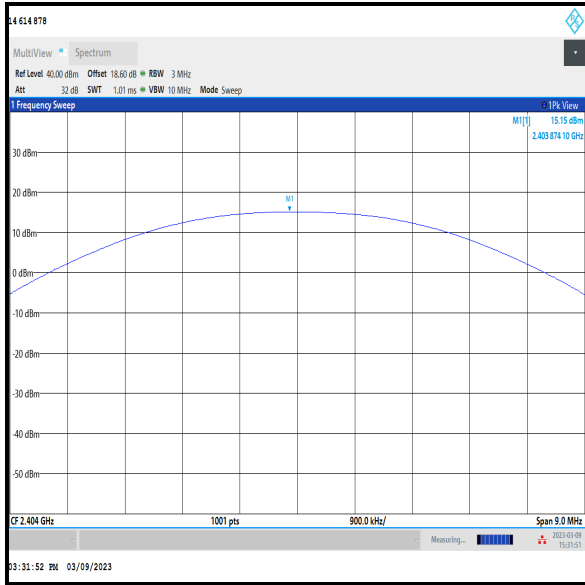

Bottom Channel

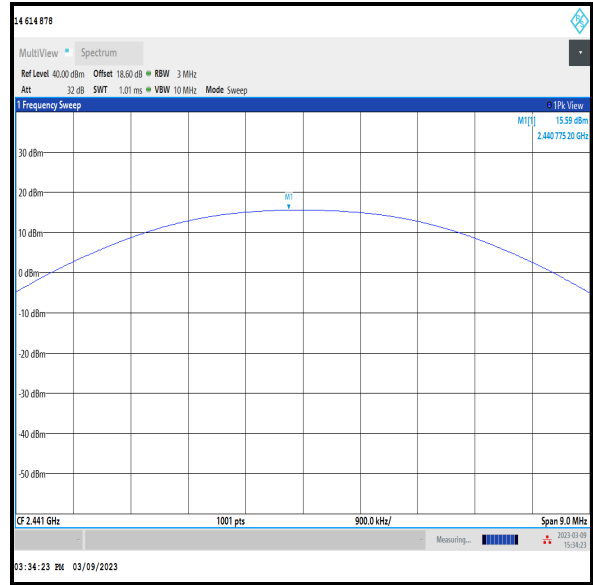

Middle Channel

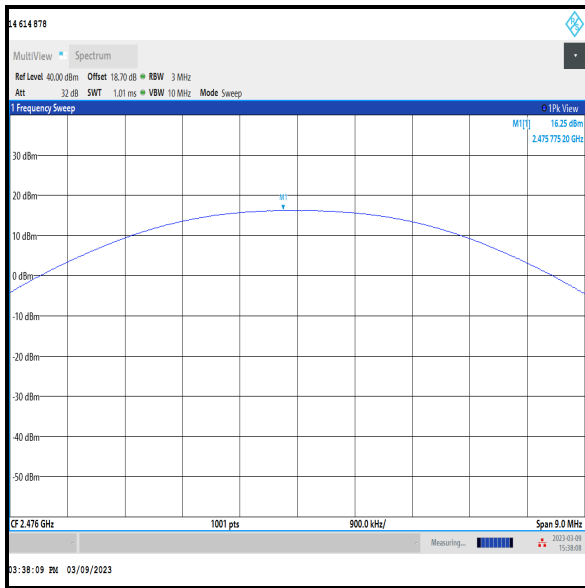

Top Channel

Transmitter Maximum Peak Output Power (continued)**Results: 8DH5 / Beamforming**

Channel	Conducted Peak Power Core 0 (dBm)	Conducted Peak Power Core 1 (dBm)	Combined Conducted Peak Power (dBm)	Conducted Peak Power Limit (dBm)	Margin (dB)	Result
Bottom	14.0	14.0	17.0	30.0	13.0	Complied
Middle	13.9	14.4	17.2	30.0	12.8	Complied
Top	14.4	14.4	17.4	30.0	12.6	Complied

Channel	Conducted Peak Power (dBm)	Declared Antenna Gain (dBi)	EIRP (dBm)	EIRP Limit (dBm)	Margin (dB)	Result
Bottom	17.0	5.9	22.9	36.0	13.1	Complied
Middle	17.2	5.9	23.1	36.0	12.9	Complied
Top	17.4	5.9	23.3	36.0	12.7	Complied

Transmitter Maximum Peak Output Power (continued)

Results: 8DH5 / Beamforming / Core 0

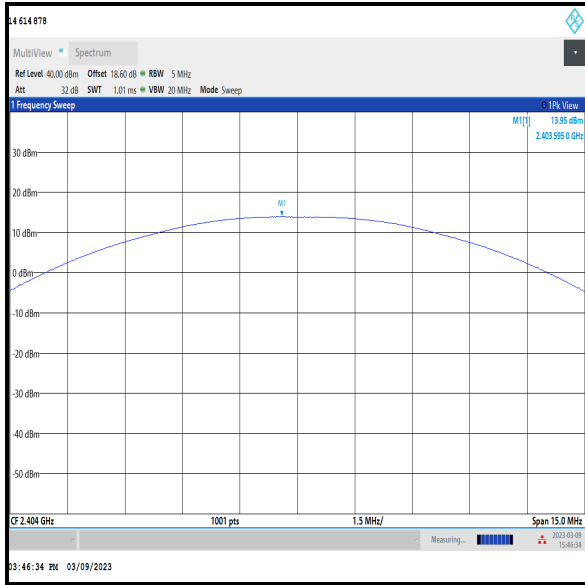

Bottom Channel

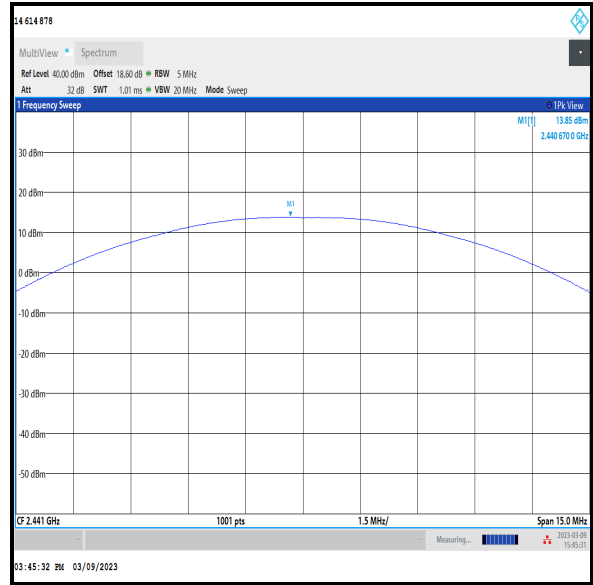

Middle Channel

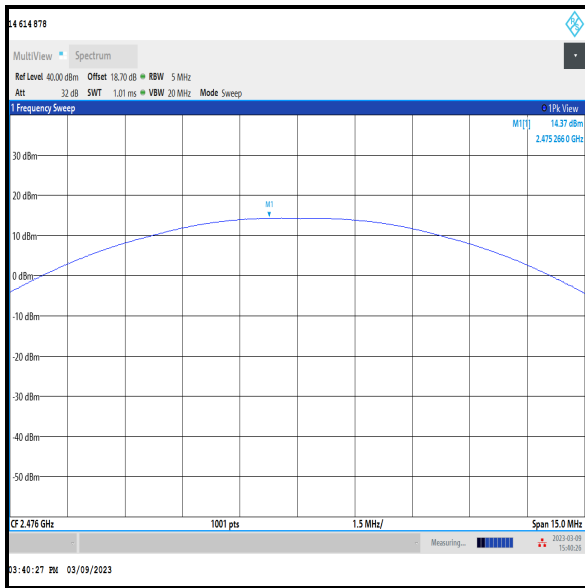

Top Channel

Transmitter Maximum Peak Output Power (continued)

Results: 8DH5 / Beamforming / Core 1

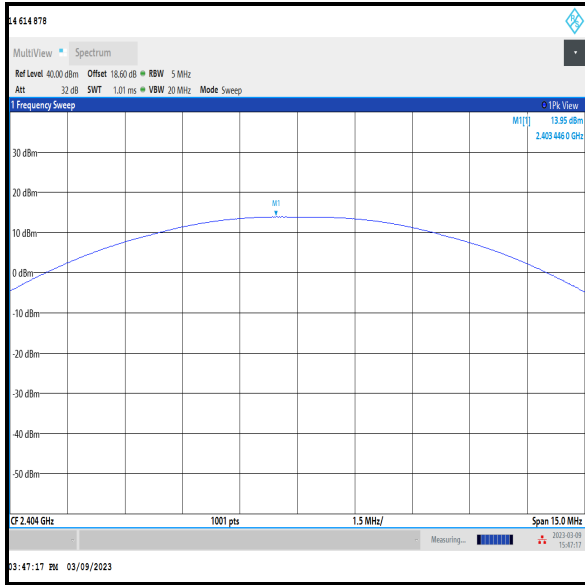

Bottom Channel

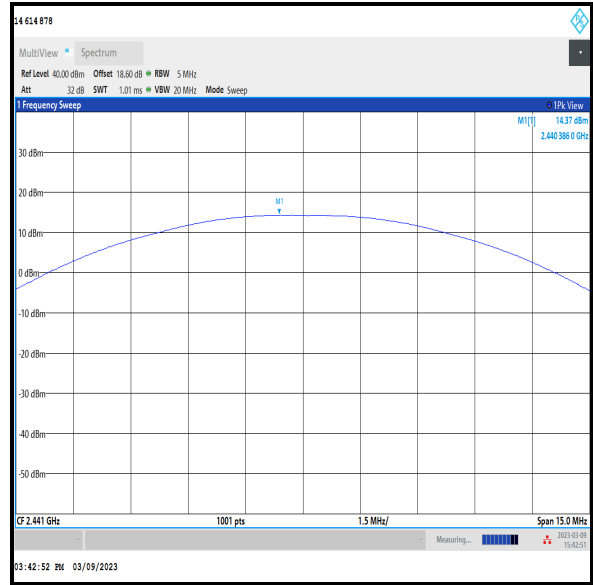

Middle Channel

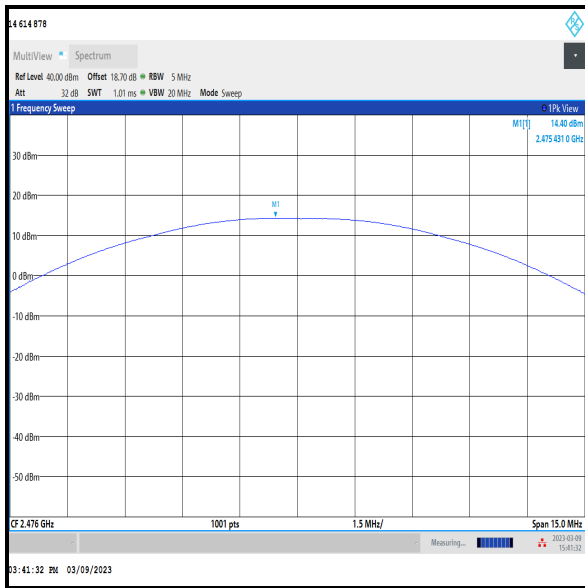

Top Channel

4.4 Transmitter Power Spectral Density

Test Summary:

Test Engineers:	Matthew Botfield & Miriam Thompson	Test Dates:	09 March 2023 & 10 March 2023
Test Sample Serial Number:	M2662LV76V		

FCC Reference:	Part 15.247(e)
ISED Canada Reference:	RSS-247 5.2(b)
Test Method Used:	FCC KDB 558074 Section 8.4 referencing ANSI C63.10 Section 11.10.2

Environmental Conditions:

Temperature (°C):	19
Relative Humidity (%):	42 to 48

Note(s):

1. Transmitter Power Spectral Density tests were performed using a signal analyser in accordance with ANSI C63.10 Section 11.10.2.
2. The signal analyser resolution bandwidth was set to 3 kHz and video bandwidth 10 kHz. A Peak detector was used, sweep time was set to auto and the trace mode was Max Hold. The span was set to 1.5 times the measured DTS bandwidth. A marker was placed at the peak of the signal and the results recorded in the table below.
3. The signal analyser was connected to the RF port on the EUT using suitable attenuation and RF cable. An RF level offset was entered on the signal analyser to compensate for the loss of the attenuator and RF cable.

Transmitter Power Spectral Density (continued)

Results: 4DH5 / SISO / Core 1

Channel	PSD (dBm / 3 kHz)	Limit (dBm / 3 kHz)	Margin (dB)	Result
Bottom	-3.6	8.0	11.6	Complied
Middle	-3.7	8.0	11.7	Complied
Top	-3.4	8.0	11.4	Complied

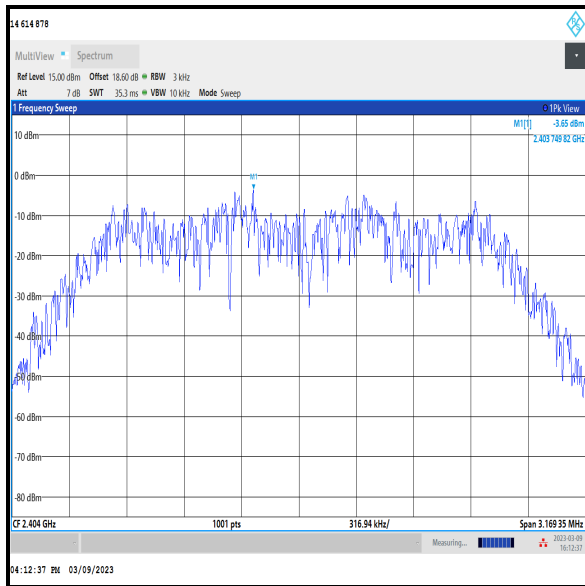

Bottom Channel

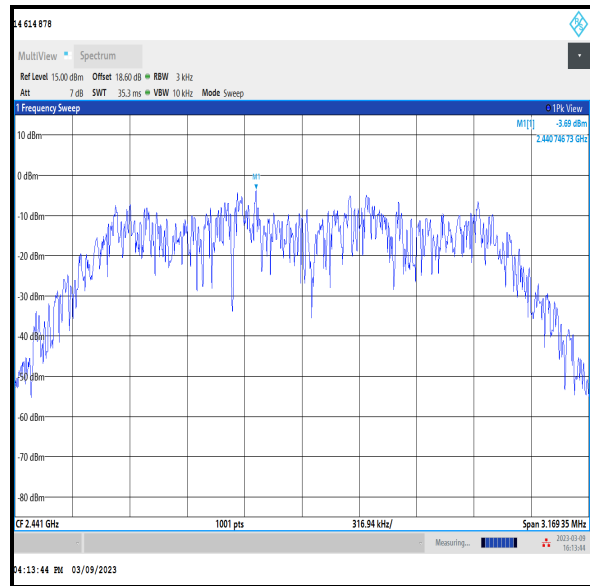

Middle Channel

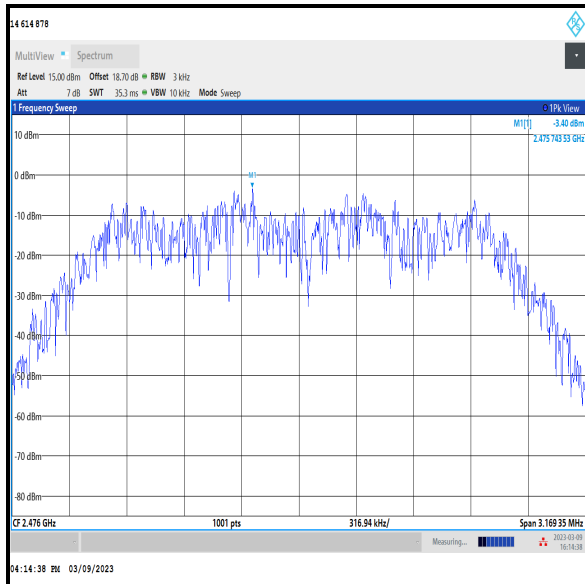

Top Channel

Transmitter Power Spectral Density (continued)

Results: 8DH5 / SISO / Core 1

Channel	PSD (dBm / 3 kHz)	Limit (dBm / 3 kHz)	Margin (dB)	Result
Bottom	-7.5	8.0	15.5	Complied
Middle	-7.6	8.0	15.6	Complied
Top	-8.3	8.0	16.3	Complied

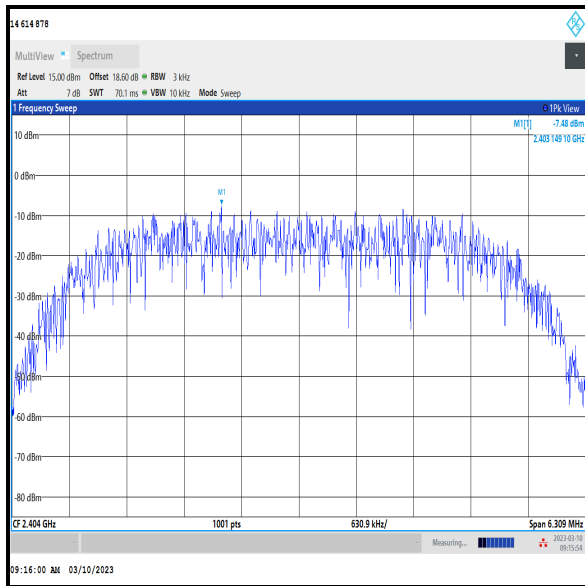

Bottom Channel

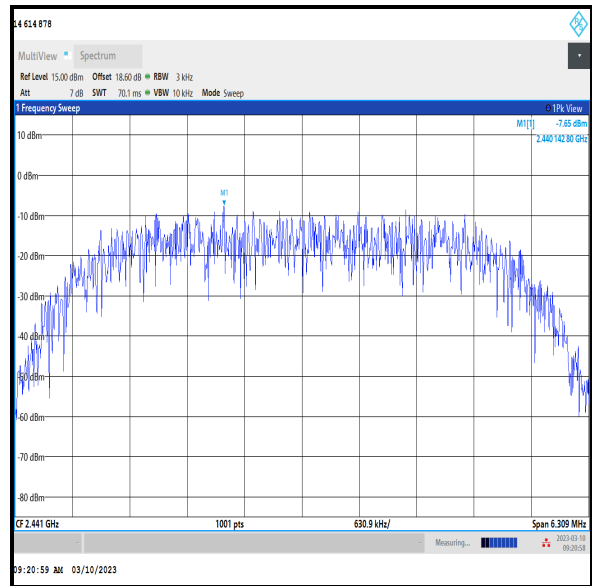

Middle Channel

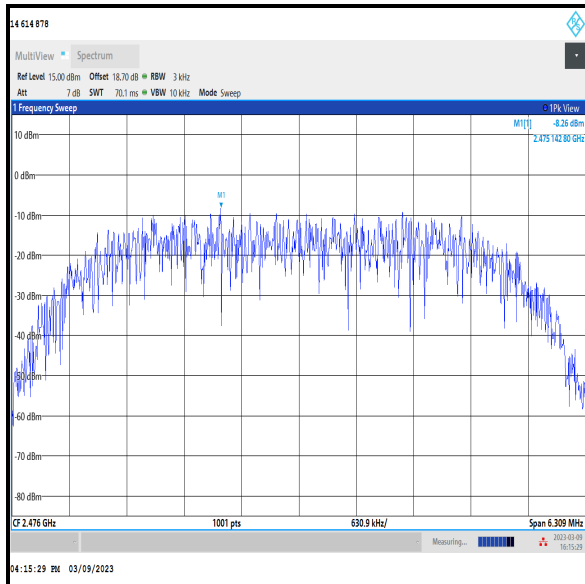

Top Channel

Transmitter Power Spectral Density (continued)

Results: 4DH5 / Beamforming

Channel	PSD Core 0 (dBm / 3 kHz)	PSD Core 1 (dBm / 3 kHz)	Combined PSD (dBm / 3 kHz)	Limit (dBm / 3 kHz)	Margin (dB)	Result
Bottom	-4.1	-3.7	-0.9	8.0	8.9	Complied
Middle	-3.3	-3.0	-0.1	8.0	8.1	Complied
Top	-2.9	-2.9	0.1	8.0	7.9	Complied

Results: Core 0

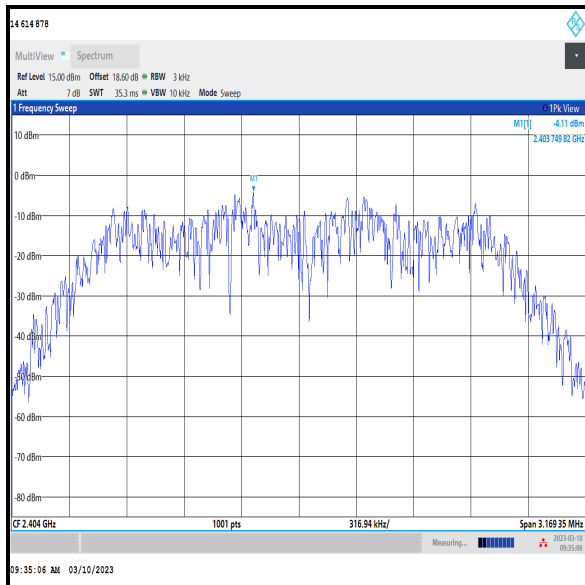

Bottom Channel

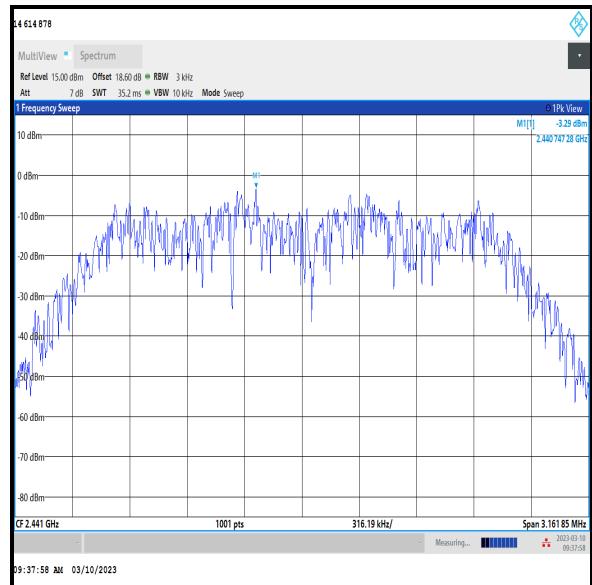

Middle Channel

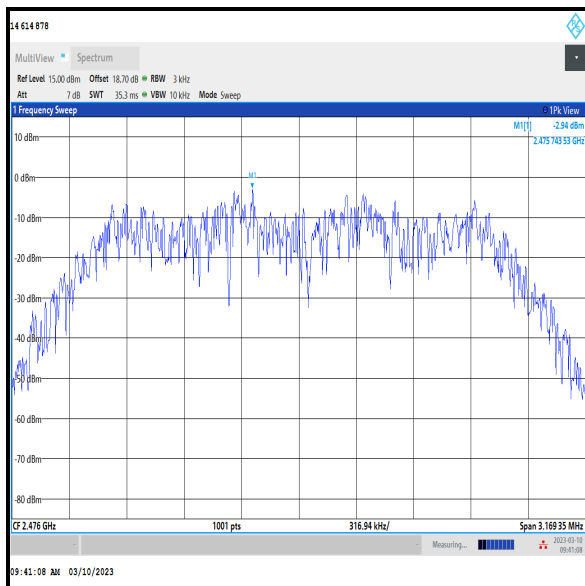

Top Channel

Transmitter Power Spectral Density (continued)

Results: 4DH5 / Beamforming / Core 1

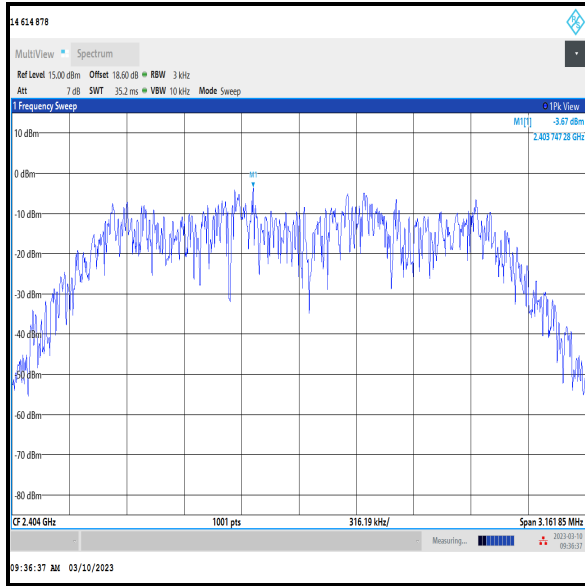

Bottom Channel

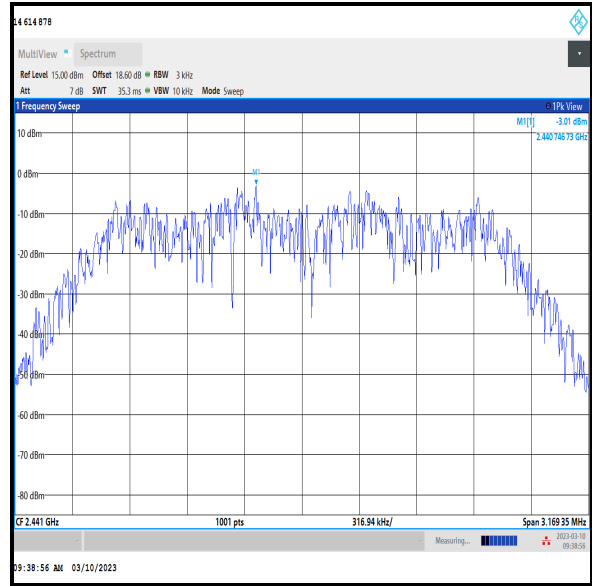

Middle Channel

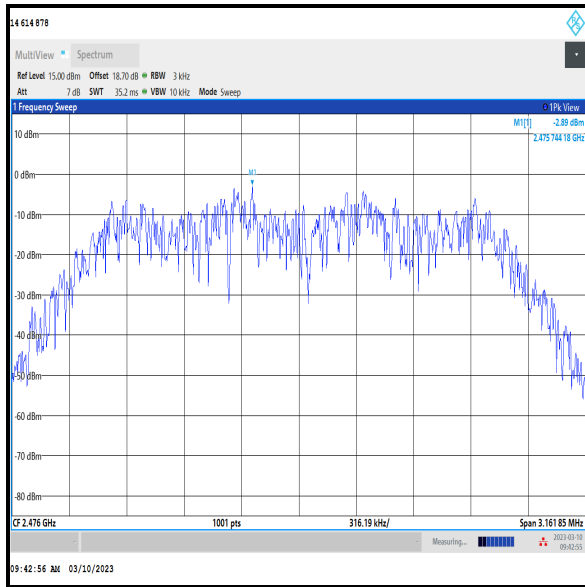

Top Channel

Transmitter Power Spectral Density (continued)

Results: 8DH5 / Beamforming

Channel	PSD Core 0 (dBm / 3 kHz)	PSD Core 1 (dBm / 3 kHz)	Combined PSD (dBm / 3 kHz)	Limit (dBm / 3 kHz)	Margin (dB)	Result
Bottom	-7.8	-8.5	-5.1	8.0	13.1	Complied
Middle	-7.5	-7.9	-4.7	8.0	12.7	Complied
Top	-7.9	-7.8	-4.8	8.0	12.8	Complied

Results: Core 0

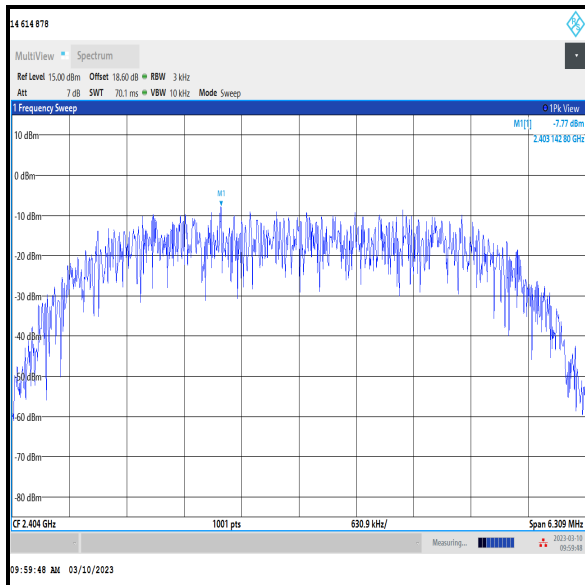

Bottom Channel

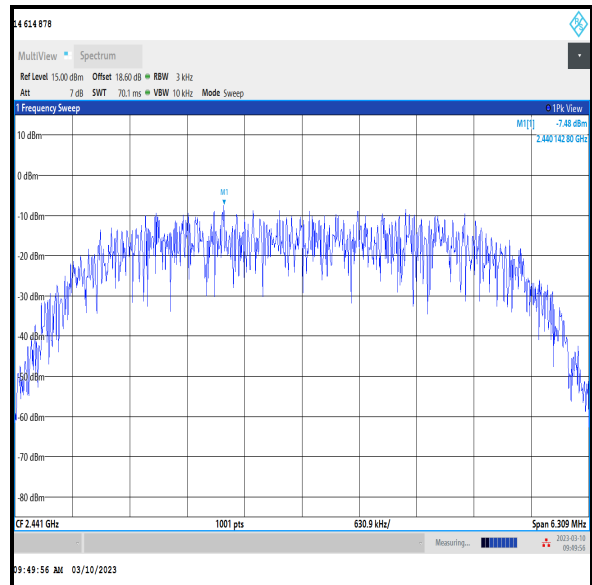

Middle Channel

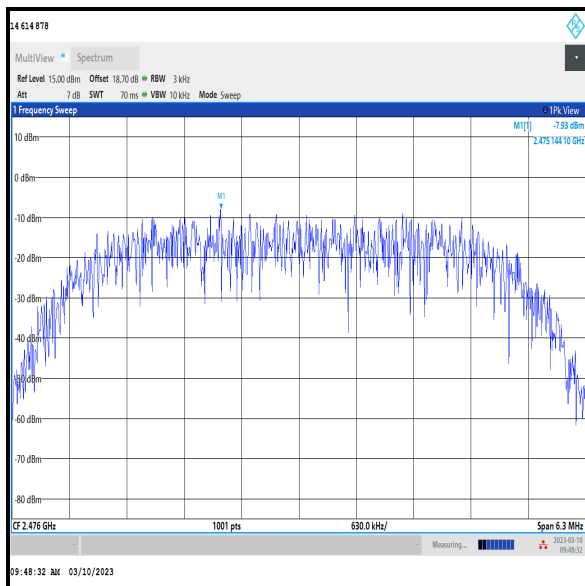

Top Channel

Transmitter Power Spectral Density (continued)

Results: 8DH5 / Beamforming / Core 1

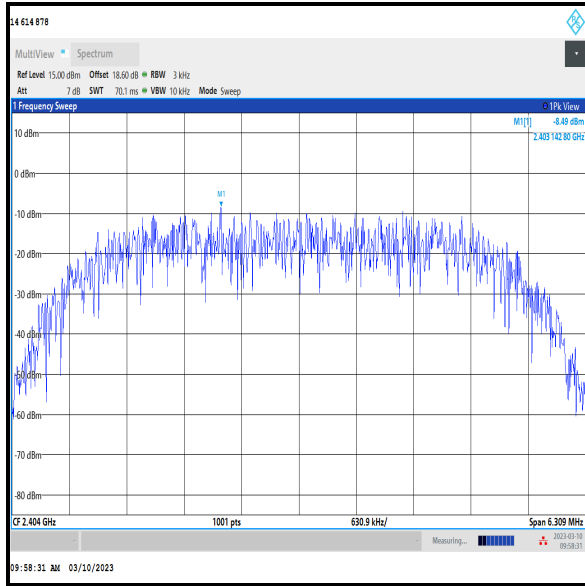

Bottom Channel

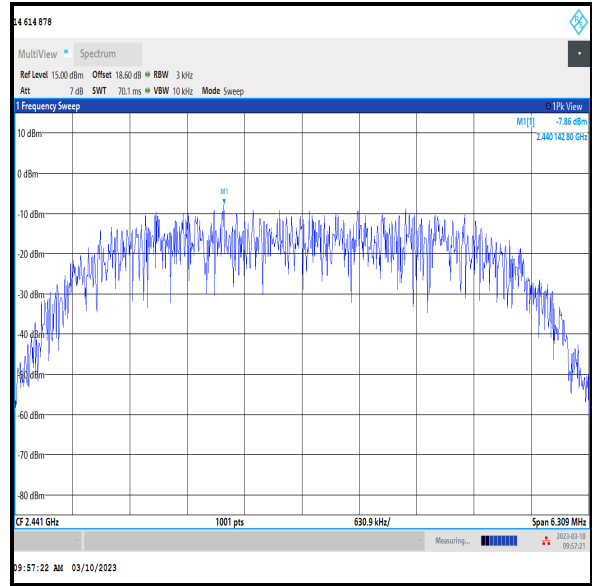

Middle Channel

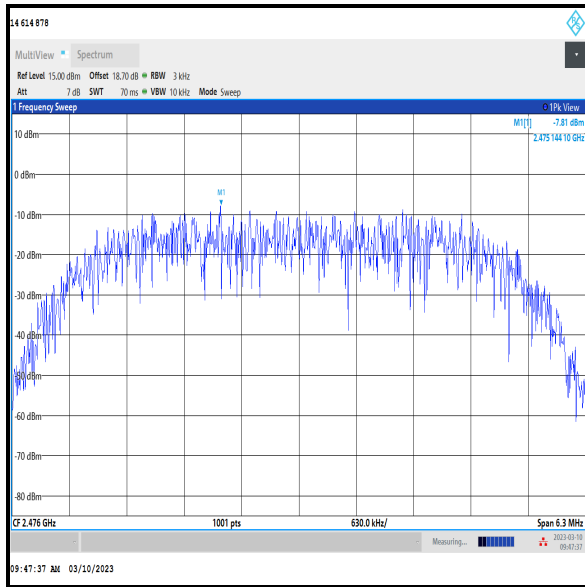

Top Channel

5 Radiated Test Results

5.1 Transmitter Radiated Emissions <1 GHz

Test Summary:

Test Engineers:	John Ferdinand & Andrew Harding	Test Dates:	01 February 2023 & 14 February 2023
Test Sample Serial Number:	NQHHW969D9		

FCC Reference:	Parts 15.247(d) & 15.209(a)
ISED Canada Reference:	RSS-Gen 6.13 & 8.9 / RSS-247 5.5
Test Method Used:	ANSI C63.10 Sections 6.3, 6.4 and 6.5
Frequency Range	9 kHz to 1000 MHz

Environmental Conditions:

Temperature (°C):	19 to 21
Relative Humidity (%):	34 to 38

Note(s):

1. The final measured value, for the given emission, in the table below incorporates the calibrated antenna factor and cable loss.
2. The preliminary scans showed similar emission levels below 1 GHz, for each channel of operation. Therefore final radiated emissions measurements were performed with the EUT set to the middle channel only.
3. All emissions shown on the pre-scans were investigated and found to be ambient, or > 20 dB below the appropriate limit or below the noise floor of the measurement system. Therefore the highest peak noise floor reading of the measuring receiver was recorded in the table below.
4. Measurements below 30 MHz were performed in a semi-anechoic chamber (Asset Number K0001) at 3 metres. The EUT was placed at a height of 80 cm above the reference ground plane in the centre of the chamber turntable. The limit was extrapolated to 3 metres in accordance with ANSI C63.10 clause 6.4.3 using the method described in clause 6.4.4.2. ANSI C63.10 clause 5.2 states an alternative test site that can demonstrate equivalence to an open area test site may be used for measurements below 30 MHz. Therefore, measurements were performed in a semi-anechoic chamber. The correlation data between semi-anechoic chamber and an open field test site is available upon request.
5. Measurements from 30 MHz to 1 GHz were performed in a semi-anechoic chamber (Asset Number K0001) at a distance of 3 metres. The EUT was placed at a height of 80 cm above the reference ground plane in the centre of the chamber turntable. Maximum emission levels were determined by height searching the measurement antenna over the range 1 metre to 4 metres.
6. Pre-scans were performed and markers placed on the highest measured levels. The test receiver was configured as follows: For 9 kHz to 150 kHz, the resolution bandwidth was set to 300 Hz and video bandwidth 1 kHz. A peak detector was used and trace mode was Max Hold. For 150 kHz to 30 MHz, the resolution bandwidth was set to 10 kHz and video bandwidth 30 kHz, trace mode was Max Hold. For 30 MHz to 1 GHz, the resolution bandwidth was set to 120 kHz and video bandwidth 500 kHz. A peak detector was used, sweep time was set to auto and trace mode was Max Hold.

Transmitter Radiated Emissions (continued)

Results: Peak / Middle Channel / 4DH5 / Beamforming / Core 0 + Core 1

Frequency (MHz)	Antenna Polarity	Level (dBμV/m)	Limit (dBμV/m)	Margin (dB)	Result
956.040	Horizontal	31.6	46.0	14.4	Complied

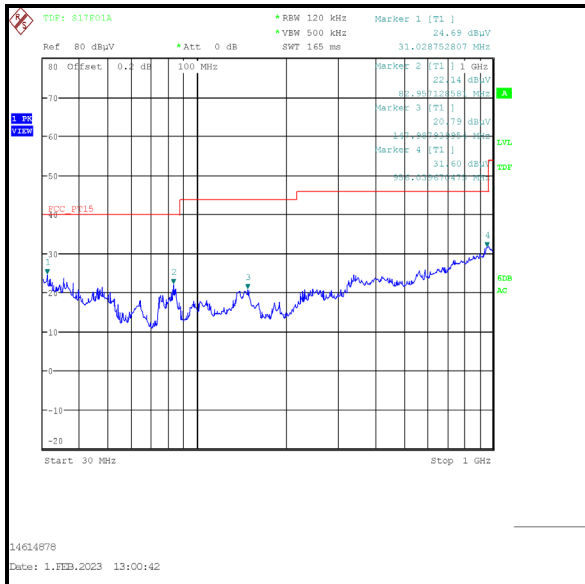
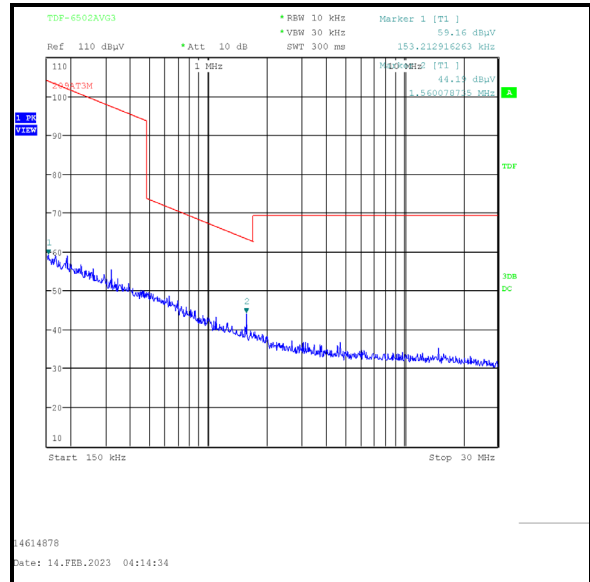
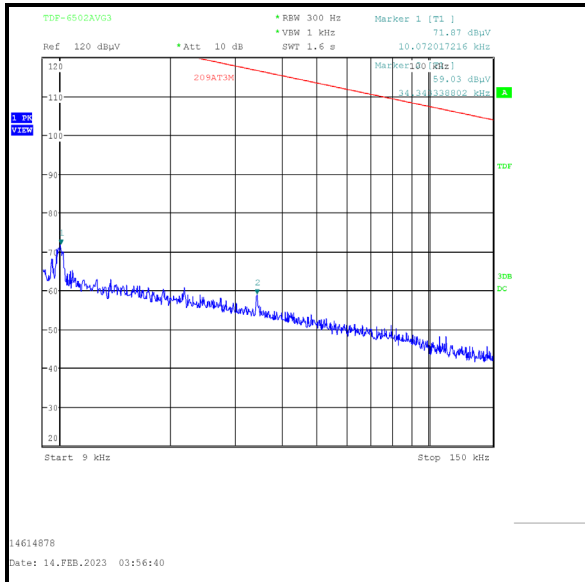

5.2 Transmitter Radiated Emissions >1 GHz

Test Summary:

Test Engineer:	John Ferdinand	Test Dates:	30 January 2023 to 02 February 2023
Test Sample Serial Number:	NQHHW969D9		

FCC Reference:	Parts 15.247(d) & 15.209(a)
ISED Canada Reference:	RSS-Gen 6.13 & 8.9 / RSS-247 5.5
Test Method Used:	FCC KDB 558074 Sections 8.1 c)3), 8.5 & 8.6 referencing ANSI C63.10 Sections 6.3, 6.6, 11.11 & 11.12
Frequency Range	1 GHz to 25 GHz

Environmental Conditions:

Temperature (°C):	20 to 22
Relative Humidity (%):	33 to 37

Note(s):

1. The final measured value, for the given emission, in the table below incorporates the calibrated antenna factor and cable loss.
2. No spurious emissions were detected above the noise floor of the measuring receiver therefore the highest peak and average noise floor readings of the measuring receiver were recorded as shown in the tables below.
3. The emission shown on the 1 GHz to 3 GHz plot at approximately 2441 MHz is the EUT fundamental.
4. Pre-scans above 1 GHz were performed in a fully anechoic chamber (Asset Number K0001) at a distance of 3 metres. The EUT was placed at a height of 1.5 metres above the test chamber floor in the centre of the chamber turntable. All measurement antennas were placed at a fixed height of 1.5 metres above the test chamber floor, in line with the EUT.
5. Pre-scans were performed and a marker placed on the highest measured level of the appropriate plot. The test receiver resolution bandwidth was set to 1 MHz and video bandwidth 3 MHz. The sweep time was set to auto. Peak and average measurements were performed with their own appropriate detectors during the pre-scan measurements.

Results: Peak / Middle Channel / 4DH5 / Beamforming / Core 0 + Core 1

Frequency (MHz)	Antenna Polarity	Level (dB μ V/m)	Limit (dB μ V/m)	Margin (dB)	Result
2996.000	Horizontal	54.5	74.0	19.5	Complied

Results: Average / Middle Channel / 4DH5 / Beamforming / Core 0 + Core 1

Frequency (MHz)	Antenna Polarity	Level (dB μ V/m)	Limit (dB μ V/m)	Margin (dB)	Result
2924.000	Horizontal	47.8	54.0	6.2	Complied