

TEST REPORT

Test Report No. : UL-RPT-RP14614878JD02A

Customer : Apple Inc.
Model No. / HVIN : A2874
PMN : iMac
FCC ID : BCGA2874
ISED Certification No. : IC: 579C-A2874
Technology : *Bluetooth* – EDR (High Power Mode)
Test Standard(s) : FCC Parts 15.209(a) & 15.247
Innovation, Science and Economic Development Canada
RSS-247 Issue 2 February 2017
RSS-Gen Issue 5 February 2021
Test Laboratory : UL International (UK) Ltd, Basingstoke, Hampshire, RG24 8AH,
United Kingdom

1. This test report shall not be reproduced except in full, without the written approval of UL International (UK) Ltd.
2. The results in this report apply only to the sample(s) tested.
3. The sample tested is in compliance with the above standard(s).
4. The test results in this report are traceable to the national or international standards.
5. Version 1.0.

Date of Issue: 17 April 2023

Checked by: 
Sarah Williams
RF Operations Leader, Radio Laboratory

Company Signatory: 
Ben Mercer
Lead Project Engineer, Radio Laboratory



The *Bluetooth*[®] word mark and logos are owned by the *Bluetooth* SIG, Inc. and any use of such marks by UL International (UK) Ltd is under licence. Other trademarks and trade names are those of their respective owners.

UL International (UK) LTD

Unit 1-3 Horizon, Kingsland Business Park, Wade Road, Basingstoke, Hampshire, RG24 8AH, UK
Telephone: +44 (0)1256 312000

Customer Information

Company Name:	Apple Inc.
Address:	One Apple Park Way Cupertino, California 95014 U.S.A.
Contact Name:	Stuart Thomas

Report Revision History

Version Number	Issue Date	Revision Details	Revised By
1.0	17/04/2023	Initial Version	Sarah Williams

Table of Contents

Customer Information.....	2
Report Revision History	2
Table of Contents.....	3
1 Attestation of Test Results.....	4
1.1 Description of EUT	4
1.2 General Information	4
1.3 Summary of Test Results	5
1.4 Deviations from the Test Specification	5
2 Summary of Testing.....	6
2.1 Facilities and Accreditation	6
2.2 Methods and Procedures	6
2.3 Calibration and Uncertainty	7
2.4 Test and Measurement Equipment	8
3 Equipment Under Test (EUT)	10
3.1 Identification of Equipment Under Test (EUT)	10
3.2 Modifications Incorporated in the EUT	10
3.3 Additional Information Related to Testing	11
3.4 Description of Available Antennas	11
3.5 Description of Test Setup	12
4 Antenna Port Test Results	18
4.1 Transmitter 99% Emission Bandwidth	18
4.2 Transmitter 20 dB Bandwidth	25
4.3 Transmitter Carrier Frequency Separation	32
4.4 Transmitter Number of Hopping Frequencies and Average Time of Occupancy	37
4.5 Transmitter Maximum Peak Output Power	40
5 Radiated Test Results.....	51
5.1 Transmitter Radiated Emissions <1 GHz	51
5.2 Transmitter Radiated Emissions >1 GHz	53
5.3 Transmitter Band Edge Radiated Emissions	55
Appendix 1	80
FHSS Duty Cycle Correction Factor Calculation	80

1 Attestation of Test Results

1.1 Description of EUT

The equipment under test was an Apple desktop computer with Bluetooth® Low Energy, Thread and IEEE 802.11 a/b/g/n/ac/ax Wi-Fi capabilities in the 2.4 GHz, 5 GHz and 6 GHz bands.

1.2 General Information

Specification Reference:	47CFR15.247
Specification Title:	Code of Federal Regulations Volume 47 (Telecommunications): Part 15 Subpart C (Intentional Radiators) – Section 15.247
Specification Reference:	47CFR15.209
Specification Title:	Code of Federal Regulations Volume 47 (Telecommunications): Part 15 Subpart C (Intentional Radiators) – Section 15.209
Specification Reference:	RSS-Gen Issue 5 February 2021
Specification Title:	General Requirements for Compliance of Radio Apparatus
Specification Reference:	RSS-247 Issue 2 February 2017
Specification Title:	Digital Transmission Systems (DTSs), Frequency Hopping Systems (FHSs) and Licence-Exempt Local Area Network (LE-LAN) Devices
Site Registration:	FCC: 685609, ISEDC: 20903
FCC Lab. Designation No.:	UK2011
ISEDC CABID:	UK0001
Location of Testing:	Unit 3 Horizon, Wade Road, Kingsland Business Park, Basingstoke, Hampshire, G24 8AH, United Kingdom
Test Dates:	12 January 2023 to 01 March 2023

1.3 Summary of Test Results

FCC Reference (47CFR)	ISED Canada Reference	Measurement	Result
N/A	RSS-Gen 6.7	Transmitter 99% Occupied Bandwidth	Complied
Part 15.247(a)(1)	RSS-Gen 6.7 / RSS-247 5.1(a)	Transmitter 20 dB Bandwidth	Complied
Part 15.247(a)(1)	RSS-247 5.1(b)	Transmitter Carrier Frequency Separation	Complied
Part 15.247(a)(1)(iii)	RSS-247 5.1(d)	Transmitter Number of Hopping Frequencies and Average Time of Occupancy	Complied
Part 15.247(b)(1)	RSS-Gen 6.12 / RSS-247 5.4(b)	Transmitter Maximum Peak Output Power	Complied
Part 15.247(d) & 15.209(a)	RSS-Gen 6.13 / RSS-247 5.5	Transmitter Radiated Emissions	Complied
Part 15.247(d) & 15.209(a)	RSS-Gen 6.13 / RSS-247 5.5	Transmitter Band Edge Radiated Emissions	Complied

1.4 Deviations from the Test Specification

For the measurements contained within this test report, there were no deviations from, additions to, or exclusions from the test specification identified above.

2 Summary of Testing

2.1 Facilities and Accreditation

The test site and measurement facilities used to collect data are located at Unit 3 Horizon, Wade Road, Kingsland Business Park, Basingstoke, Hampshire, RG24 8AH, United Kingdom. The following table identifies which facilities were utilised for radiated emission measurements documented in this report. Specific facilities are also identified in the test results sections.

Site 1	X
Site 2	-
Site 17	X

UL International (UK) Ltd is accredited by the United Kingdom Accreditation Service (UKAS). UKAS is one of the signatories to the International Laboratory Accreditation Co-operation (ILAC) Arrangement for the mutual recognition of test reports. The tests reported herein have been performed in accordance with its terms of accreditation.

2.2 Methods and Procedures

Reference:	ANSI C63.10-2013
Title:	American National Standard of Procedures for Compliance Testing of Unlicensed Wireless Devices
Reference:	KDB 558074 D01 15.247 Meas Guidance v05r02, April 2, 2019
Title:	Guidance for Compliance Measurements on Digital Transmission System, Frequency Hopping Spread Spectrum System, and Hybrid System Devices Operating Under Section 15.247 of the FCC Rules
Reference:	KDB 662911 D01 Multiple Transmitter Output v02r01 October 31, 2013
Title:	Emissions Testing of Transmitters with Multiple Outputs in the Same Band

2.3 Calibration and Uncertainty

Measuring Instrument Calibration

In accordance with UKAS requirements all the measurement equipment is on a calibration schedule. All equipment was within the calibration period on the date of testing.

Measurement Uncertainty & Decision Rule

Overview

No measurement or test can ever be perfect and the imperfections give rise to error of measurement in the results. Consequently the result of a measurement is only an approximation to the value of the measurand (the specific quantity subject to measurement) and is only complete when accompanied by a statement of the uncertainty of the approximation.

The expression of uncertainty of a measurement result allows realistic comparison of results with reference values and limits given in specifications and standards.

Decision Rule

The decision rule applied is based upon the accuracy method criteria. The measurement uncertainty is met and the result is considered in conformance with the requirement criteria if the observed value is within the prescribed limit.

Measurement Uncertainty

The reported expanded uncertainties below are based on a standard uncertainty multiplied by an appropriate coverage factor such that a confidence level of approximately 95% is maintained. For the purposes of this document "approximately" is interpreted as meaning "effectively" or "for most practical purposes".

Measurement Type	Range	Confidence Level (%)	Calculated Uncertainty
99% Occupied Bandwidth	2.4 GHz to 2.4835 GHz	95%	±3.92 %
20 dB Bandwidth	2.4 GHz to 2.4835 GHz	95%	±4.59 %
Carrier Frequency Separation	2.4 GHz to 2.4835 GHz	95%	±4.59 %
Average Time of Occupancy	2.4 GHz to 2.4835 GHz	95%	±3.53 ns
Conducted Maximum Peak Output Power	2.4 GHz to 2.4835 GHz	95%	±1.13 dB
Radiated Spurious Emissions	9 kHz to 30 MHz	95%	±5.32 dB
Radiated Spurious Emissions	30 MHz to 1 GHz	95%	±3.30 dB
Radiated Spurious Emissions	1 GHz to 25 GHz	95%	±3.16 dB

The methods used to calculate the above uncertainties are in line with those recommended within the various measurement specifications. Where measurement specifications do not include guidelines for the evaluation of measurement uncertainty the published guidance of the appropriate accreditation body is followed.

2.4 Test and Measurement Equipment

Test Equipment Used for Transmitter Conducted Tests

Asset No.	Instrument	Manufacturer	Type No.	Serial No.	Date Calibration Due	Cal. Interval (Months)
M2038	Thermohygrometer	Testo	608-H1	45124919	09 Dec 2023	12
A2507	Attenuator	AtlanTecRF	AN18-10	821846#2	Calibrated before use	-
M1996	Signal Analyser	Rohde & Schwarz	FSV13	100975	17 Mar 2023	12
A214336	Attenuator	Atlantic Microwave	ATT06KXP-483082-S4S5	#1	Calibrated before use	-
A214341	Attenuator	Atlantic Microwave	ATT06KXP-483082-S4S5	#6	Calibrated before use	-
A214343	Attenuator	Atlantic Microwave	ATT06KXP-483082-S4S5	#8	Calibrated before use	-
A222203	Switch Box	UL	UK version #10010	#2	Calibrated before use	-
G207635	Signal Generator	Rohde & Schwarz	SMCV100B	103200	07 Oct 2025	36

Test and Measurement Equipment (continued)**Test Equipment Used for Transmitter Radiated Emissions Tests**

Asset No.	Instrument	Manufacturer	Type No.	Serial No.	Date Calibration Due	Cal. Interval (Months)
M2003	Thermohygrometer	Testo	608-H1	45046641	09 Dec 2023	12
K0017	3m RSE Chamber	Rainford	N/A	N/A	08 Nov 2023	12
M1995	Test Receiver	Rohde & Schwarz	ESU40	100428	02 Nov 2023	12
A2863	Pre Amplifier	Agilent	8449B	3008A02100	07 Nov 2023	12
A3167	Pre Amplifier	Com-Power	PAM-103	18020010	02 Nov 2023	12
A223628	Pre Amplifier	Atlantic Microwave	A-LNAKX-380116-S5S5	210837001	02 Nov 2023	12
A3265	Pre Amplifier	Schwarzbeck	BBV 9721	9721-069	31 Oct 2023	12
A490	Antenna	Chase	CBL6111A	1590	06 Oct 2023	12
A2889	Antenna	Schwarzbeck	BBHA 9120 B	653	02 Nov 2023	12
A2890	Antenna	Schwarzbeck	HWRD 750	014	02 Nov 2023	12
A2892	Antenna	Schwarzbeck	BBHA 9170	9170-727	31 Oct 2023	12
A2916	Attenuator	AtlanTecRF	AN18W5-10	832827#1	25 Jan 2024	12
A3036	Low Pass Filter	AtlanTecRF	AFL-02000	15062902848	25 Jan 2024	12
A2914	High Pass Filter	AtlanTecRF	AFH-03000	2155	25 Jan 2024	12
A212035	High Pass Filter	Micro-Tronics	HPS20722	001	25 Jan 2024	12
K0001	3m RSE Chamber	Rainford EMC	N/A	N/A	05 Sep 2023	12
M2040	Thermohygrometer	Testo	608-H1	45124934	09 Dec 2023	12
M1874	Test Receiver	Rohde & Schwarz	ESU26	100553	19 May 2023	12
A3165	Magnetic Loop Antenna	ETS-Lindgren	6502	00224383	05 May 2023	12

Test Equipment Used for Transmitter Band Edge Radiated Emissions Tests

Asset No.	Instrument	Manufacturer	Type No.	Serial No.	Date Calibration Due	Cal. Interval (Months)
M2003	Thermohygrometer	Testo	608-H1	45046641	09 Dec 2023	12
K0017	3m RSE Chamber	Rainford	N/A	N/A	08 Nov 2023	12
M1995	Test Receiver	Rohde & Schwarz	ESU40	100428	02 Nov 2023	12
A2863	Pre Amplifier	Agilent	8449B	3008A02100	07 Nov 2023	12
A2916	Attenuator	AtlanTecRF	AN18W5-10	832827#1	25 Jan 2024	12
A2889	Antenna	Schwarzbeck	BBHA 9120 B	B653	02 Nov 2023	12

3 Equipment Under Test (EUT)

3.1 Identification of Equipment Under Test (EUT)

Brand Name:	Apple
Model Name or Number / HVIN:	A2874
PMN:	iMac
Test Sample Serial Number:	M2662LV76V (<i>Conducted sample</i>)
Hardware Version:	REV 1.0
Software Version:	22E31551a
FCC ID:	BCGA2874
ISED Canada Certification Number:	IC: 579C-A2874
Date of Receipt:	21 February 2023

Brand Name:	Apple
Model Name or Number / HVIN:	A2874
PMN:	iMac
Test Sample Serial Number:	NQHHW969D9 (<i>Radiated sample</i>)
Hardware Version:	REV 1.0
Software Version:	22E31550w
FCC ID:	BCGA2874
ISED Canada Certification Number:	IC: 579C-A2874
Date of Receipt:	10 January 2023

3.2 Modifications Incorporated in the EUT

No modifications were applied to the EUT during testing.

3.3 Additional Information Related to Testing

Technology Tested:	Bluetooth		
Type of Unit:	Transceiver		
Channel Spacing:	1 MHz		
Mode:	Enhanced Data Rate		
Modulation:	$\pi/4$ -DQPSK	8DPSK	
Packet Type (Maximum Payload):	2DH5	3DH5	
Data Rate (Mbit/s):	2	3	
Power Supply Requirement(s):	Nominal	12 VDC via 120 VAC 60 Hz adaptor	
Maximum Conducted Output Power:	19.7 dBm		
Transmit Frequency Range:	2400 MHz to 2483.5 MHz		
Transmit Channels Tested:	Channel ID	Channel Number	Channel Frequency (MHz)
	Bottom	0	2402
	Middle	39	2441
	Top	78	2480

3.4 Description of Available Antennas

The radio utilizes two integrated antennas, with the following maximum gains:

Antenna Port	Frequency Range (MHz)	Antenna Gain (dBi)
Core 0	2400 to 2480	2.1
Core 1	2400 to 2480	3.6

The EUT also supports TxBF with unequal gains and equal transmit powers. Calculations for directional gain were in accordance with KDB 662911 D01 v02r01 Section F)2)d)(i). Directional gain of Core 0 & Core 1 was calculated as:

$N_{ANT} = 2$, $G_{Core0} = 2.1$ dBi, $G_{Core1} = 3.6$ dBi

$$\begin{aligned} \text{Directional Gain} &= 10 \log \left[\frac{\left(10^{\frac{G_1}{20}} + 10^{\frac{G_2}{20}} + \dots + 10^{\frac{G_N}{20}} \right)^2}{N_{ANT}} \right] = 10 \log \left[\frac{\left(10^{\frac{G_1}{20}} + 10^{\frac{G_2}{20}} \right)^2}{2} \right] \\ &= 10 \log \left[\frac{\left(10^{\frac{2.1}{20}} + 10^{\frac{3.6}{20}} \right)^2}{2} \right] = 5.9 \text{ dBi} \end{aligned}$$

3.5 Description of Test Setup

Support Equipment

The following support equipment was used to exercise the EUT during testing:

Description:	Test Laptop
Brand Name:	Apple
Model Name or Number:	MacBook Pro
Serial Number:	C02YK003L59F

Description:	USB Diagnostic Cable
Brand Name:	Apple
Model Name or Number:	Chimp
Serial Number:	428A84

Description:	USB-A Cable. Quantity 2. Length 3 m.
Brand Name:	Not marked or stated
Model Name or Number:	Not marked or stated
Serial Number:	Not marked or stated

Description:	USB-C to A Adaptor. Quantity 2. Length 10 cm.
Brand Name:	Not marked or stated
Model Name or Number:	Not marked or stated
Serial Number:	Not marked or stated

Description:	4 port USB Termination Hub
Brand Name:	Uni
Model Name or Number:	Not marked or stated
Serial Number:	Not marked or stated

Description:	Personal Hands Free (PHF)
Brand Name:	Not marked or stated
Model Name or Number:	Not marked or stated
Serial Number:	Not marked or stated

Description:	Power Adaptor
Brand Name:	Apple
Model Name or Number:	A2290
Serial Number:	Not marked or stated

Support Equipment (continued)

Description:	Test Laptop
Brand Name:	Apple
Model Name or Number:	MacBook Pro
Serial Number:	C02C8009P22C

Description:	USB Diagnostic Cable
Brand Name:	Apple
Model Name or Number:	Chimp
Serial Number:	304708

Operating Modes

The EUT was tested in the following operating mode(s):

- Continuously transmitting at maximum power on bottom, middle and top channels in EDR (2DH5 or 3DH5 packets) as required.
- Continuously transmitting at maximum power in hopping mode on all channels in EDR (2DH5 or 3DH5 packets) as required.

Configuration and Peripherals

The EUT was tested in the following configuration(s):

- Controlled in test mode using a set of commands entered into a terminal application on the test laptop supplied by the customer. The commands were used to enable a continuous transmission and to select the test channels as required. The customer supplied a document containing the setup instructions.
- The EUT has two cores which operate in both SISO and TxBF modes. Core 0 & Core 1 are identical but have unequal gains therefore conducted tests have been performed on the Core with the highest antenna gain. Modes tested were:
 - 2DH5 / SISO / Core 1
 - 3DH5 / SISO / Core 1
 - 2DH5 / Beamforming / Core 0 + Core 1
 - 3DH5 / Beamforming / Core 0 + Core 1
- The customer supplied U.FL RF cables with the EUT in order to perform conducted measurements. This measured additional path loss was included in any path loss calculations.
- The EUT was powered from a 120 VAC 60 Hz single phase mains supply.
- Transmitter radiated spurious emissions tests were performed with the EUT transmitting in 3DH5 Core 0 + Core 1 mode as this mode was found to transmit the highest power and spectral density.
- Radiated spurious emissions were performed with the EUT in its normal orientation. All ports were terminated into suitable terminations and placed under the turntable.

Test Setup Diagrams

Conducted Tests:

Test Setup for Transmitter Conducted Tests

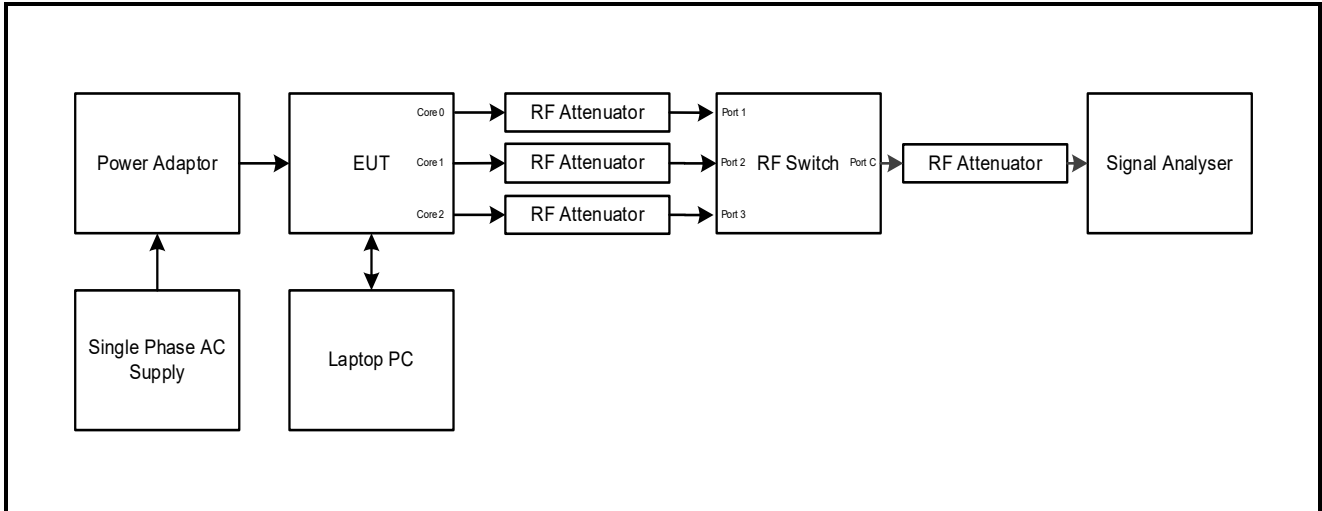

Test Setup Diagrams (continued)

Radiated Tests:

Test Setup for Transmitter Radiated Emissions

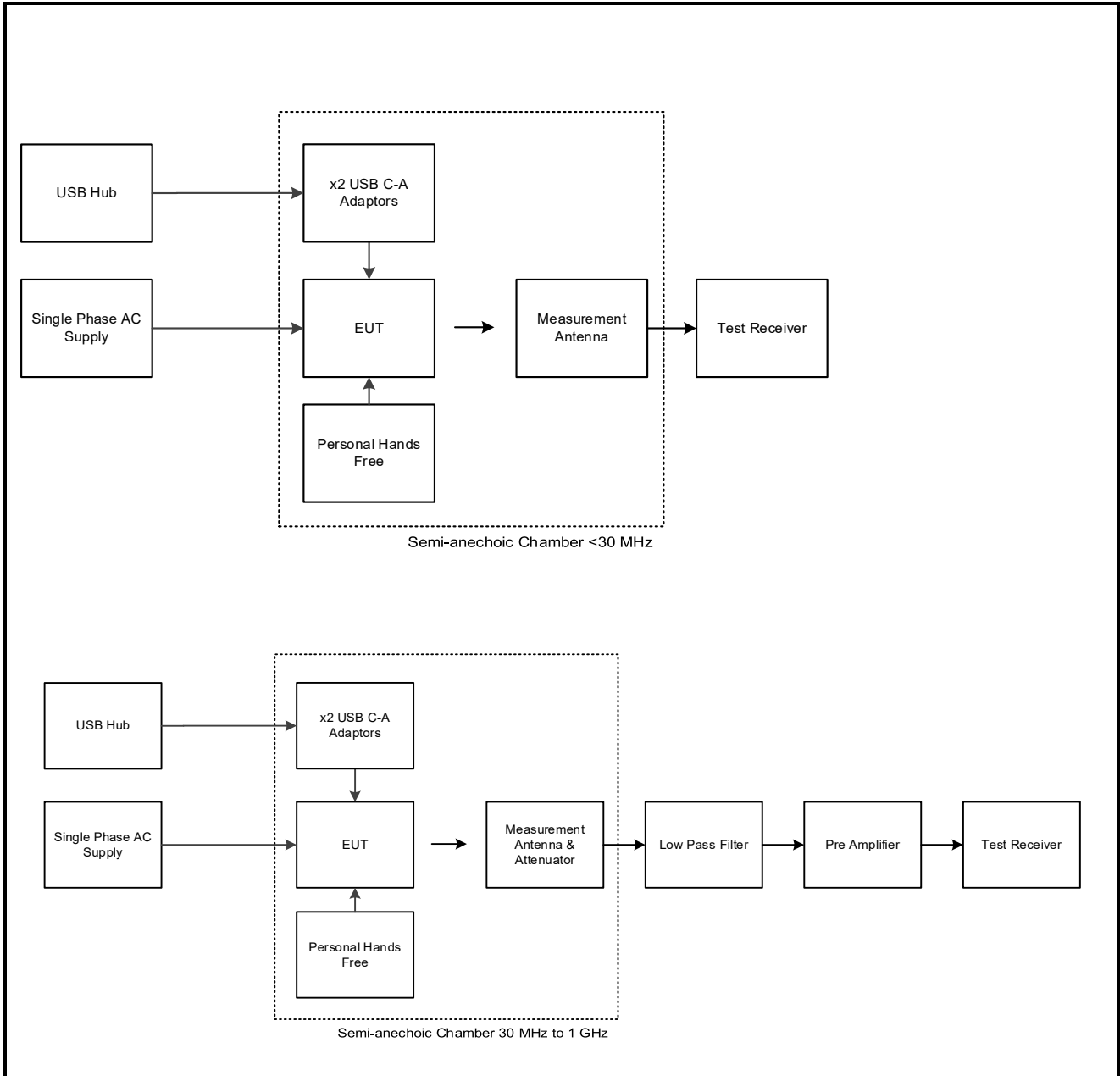

Test Setup Diagrams (continued)

Test Setup for Transmitter Radiated Emissions (continued)

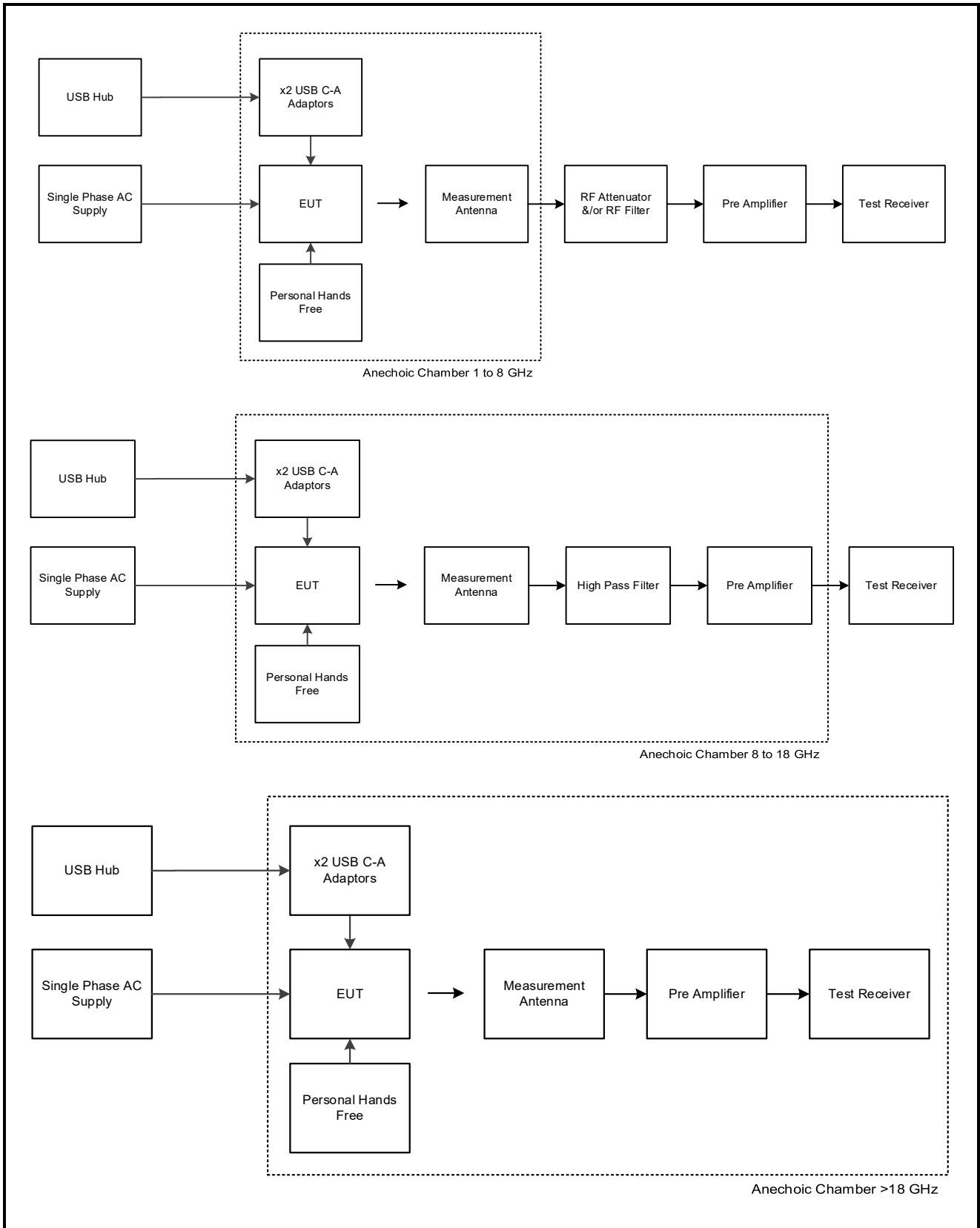

4 Antenna Port Test Results

4.1 Transmitter 99% Emission Bandwidth

Test Summary:

Test Engineers:	Matthew Botfield & Miriam Thompson	Test Date:	24 February 2023
Test Sample Serial Number:	M2662LV76V		

FCC Reference:	N/A
ISED Canada Reference:	RSS-Gen 6.7
Test Method Used:	RSS-Gen 6.7 and Notes below

Environmental Conditions:

Temperature (°C):	21
Relative Humidity (%):	35

Note(s):

1. The 99% emission bandwidth was measured using the signal analyser occupied bandwidth function. The resolution bandwidth was set in the range of 1% to 5% of the occupied bandwidth and the video bandwidth set to 3 times the resolution bandwidth. The span was set to capture all products of the modulation process including emission skirts.
2. The signal analyser resolution bandwidth was set to 30 kHz and video bandwidth 100 kHz. A peak detector was used, sweep time was set to auto and the trace mode was Max Hold. The span was set to 5 MHz. The signal analyser function set the measurements to be made at 99% of the emission bandwidth. The results are given in the tables below.
3. The signal analyser was connected to the RF port on the EUT using suitable attenuation and RF cable.

Transmitter 99% Emission Bandwidth (continued)

Results: 2DH5 / SISO / Core 1

Channel	99% Emission Bandwidth (kHz)
Bottom	1208.791
Middle	1208.791
Top	1208.791

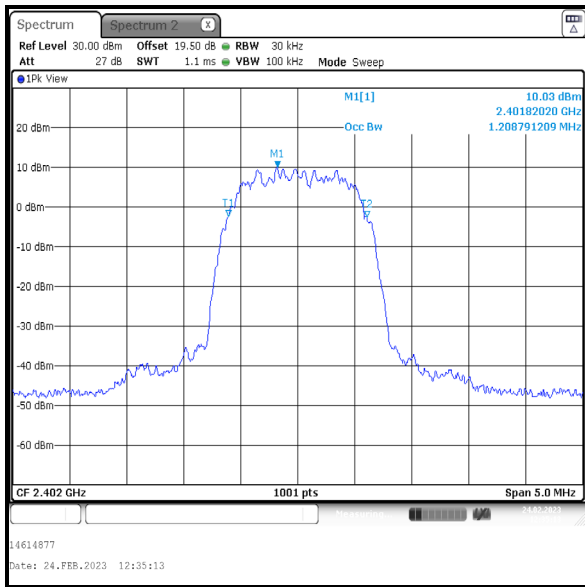

Bottom Channel

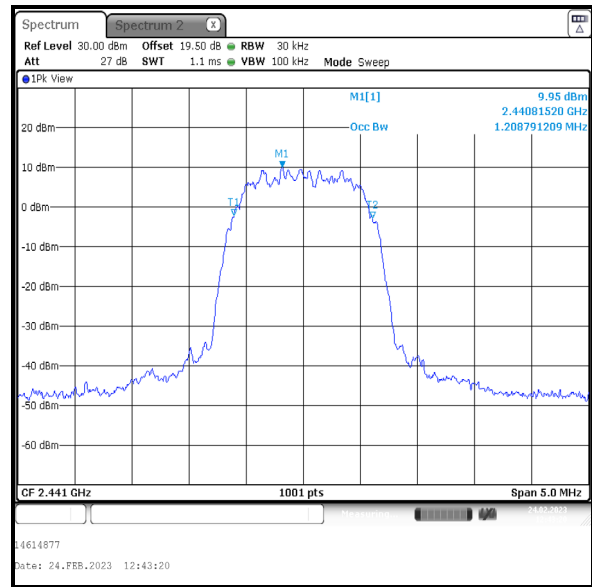

Middle Channel

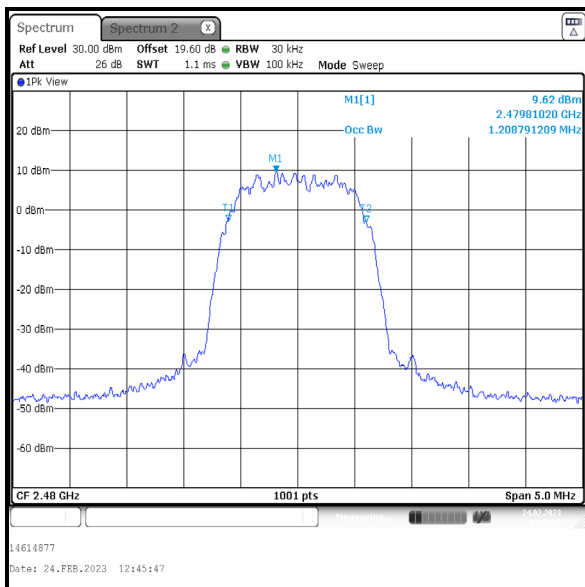

Top Channel

Transmitter 99% Emission Bandwidth (continued)

Results: 3DH5 / SISO / Core 1

Channel	99% Emission Bandwidth (kHz)
Bottom	1208.791
Middle	1208.791
Top	1213.786

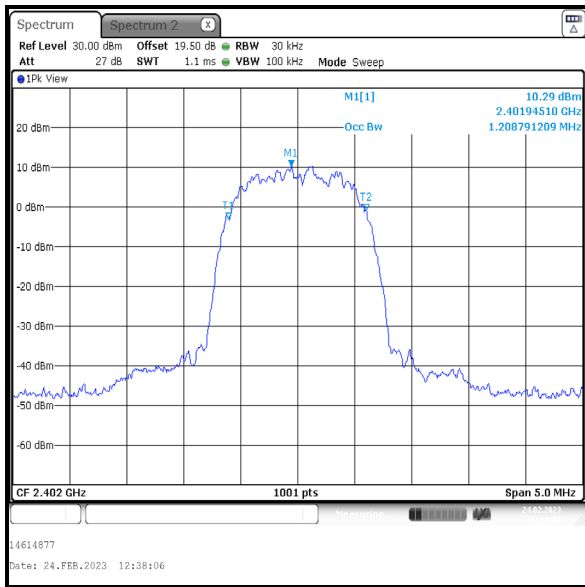

Bottom Channel

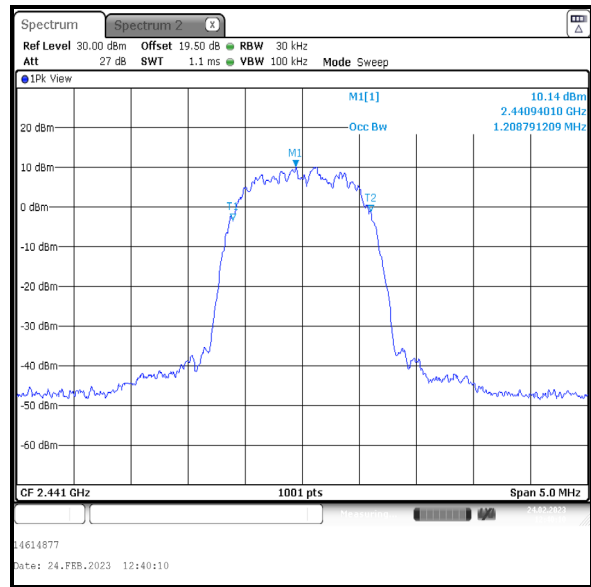

Middle Channel

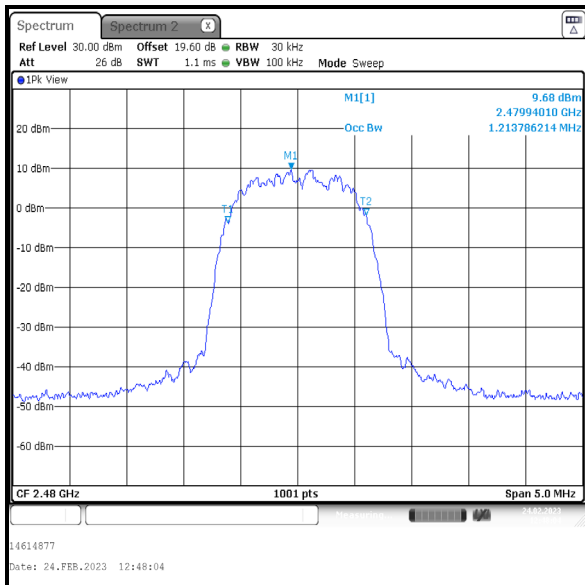

Top Channel

Transmitter 99% Emission Bandwidth (continued)

Results: 2DH5 / Beamforming / Core 0

Channel	99% Emission Bandwidth (kHz)
Bottom	1208.791
Middle	1203.796
Top	1208.791

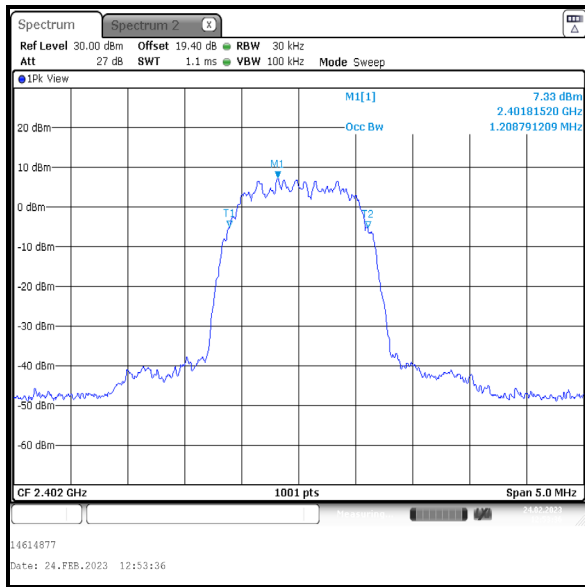

Bottom Channel

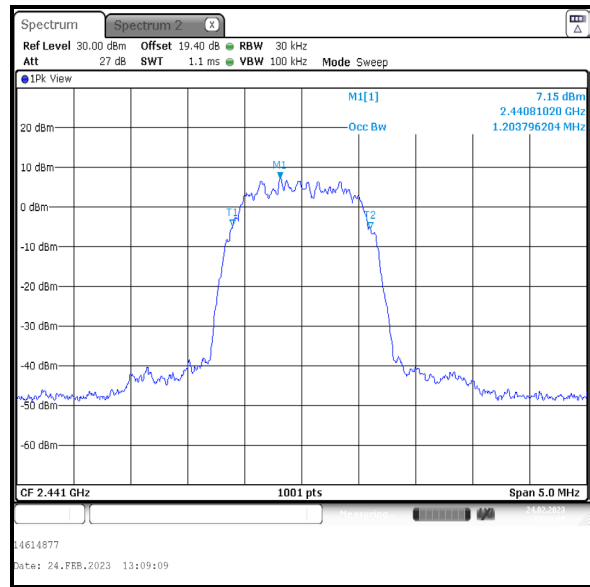

Middle Channel

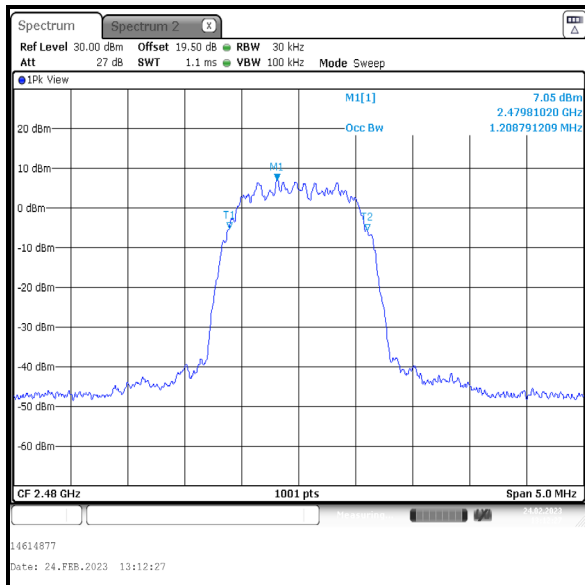

Top Channel

Transmitter 99% Emission Bandwidth (continued)

Results: 2DH5 / Beamforming / Core 1

Channel	99% Emission Bandwidth (kHz)
Bottom	1208.791
Middle	1203.796
Top	1208.791

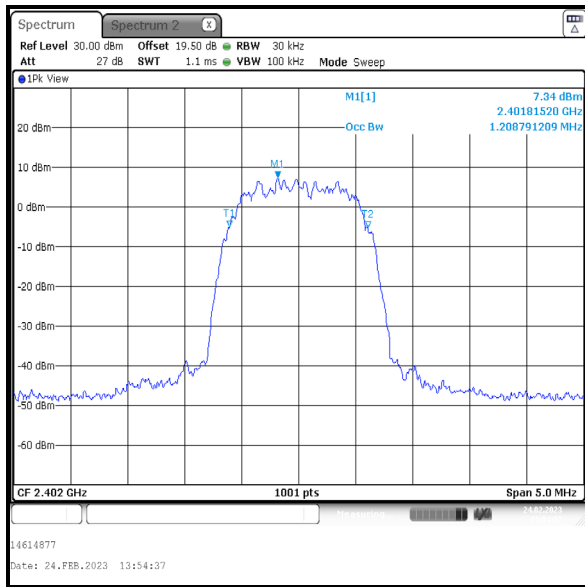

Bottom Channel

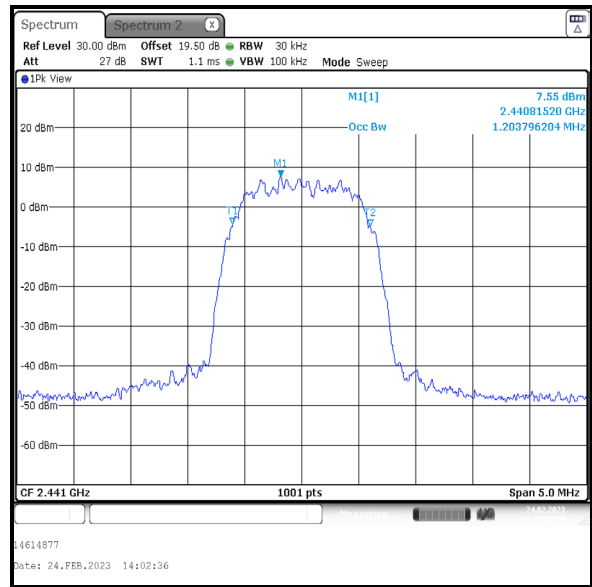

Middle Channel

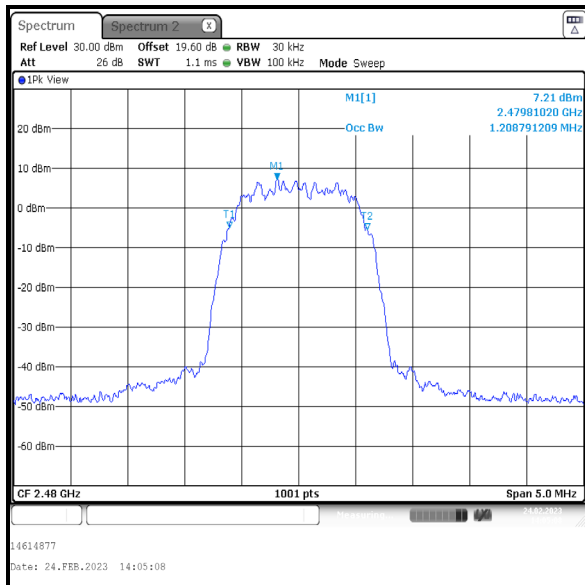

Top Channel

Transmitter 99% Emission Bandwidth (continued)

Results: 3DH5 / Beamforming / Core 0

Channel	99% Emission Bandwidth (kHz)
Bottom	1208.791
Middle	1208.791
Top	1208.791

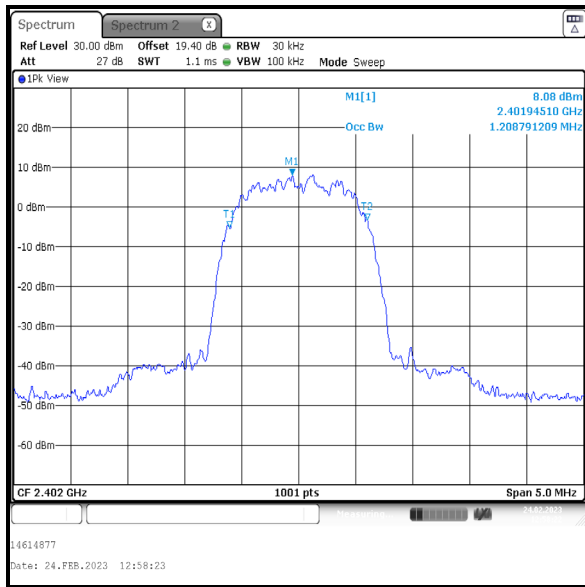

Bottom Channel

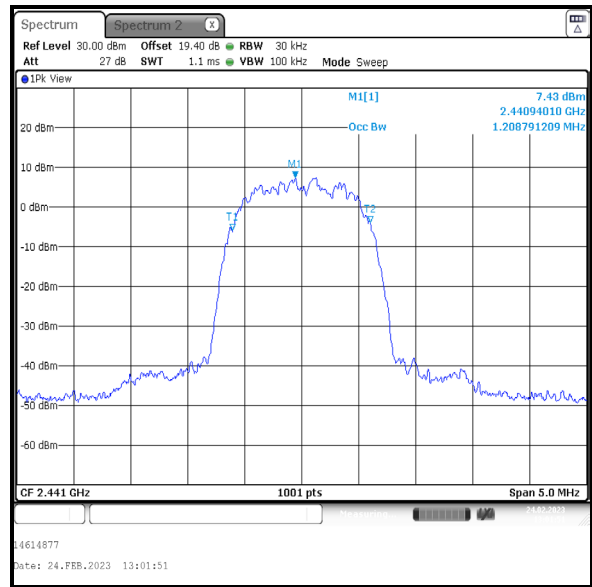

Middle Channel

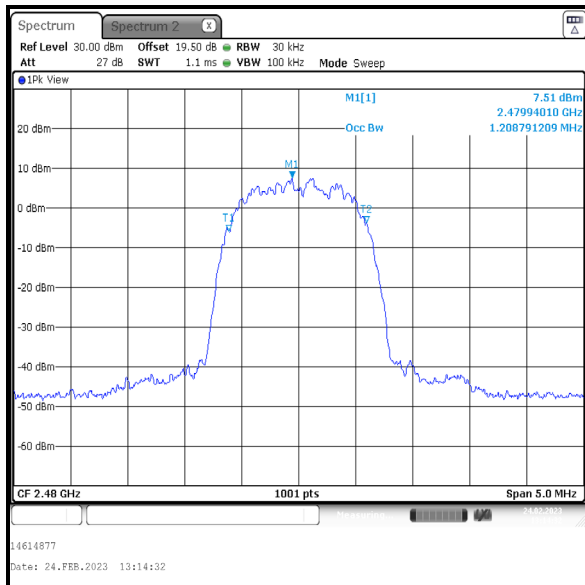

Top Channel

Transmitter 99% Emission Bandwidth (continued)

Results: 3DH5 / Beamforming / Core 1

Channel	99% Emission Bandwidth (kHz)
Bottom	1208.791
Middle	1208.791
Top	1213.786

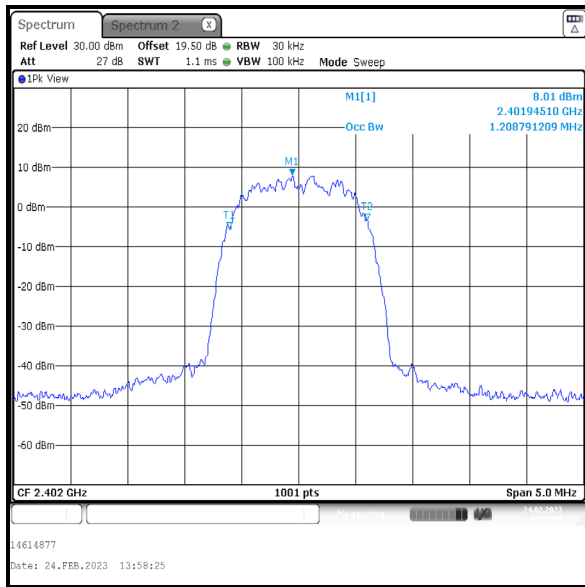

Bottom Channel

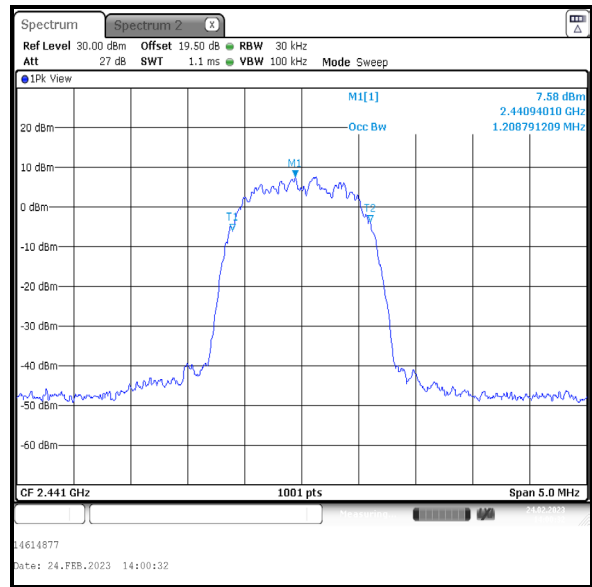

Middle Channel

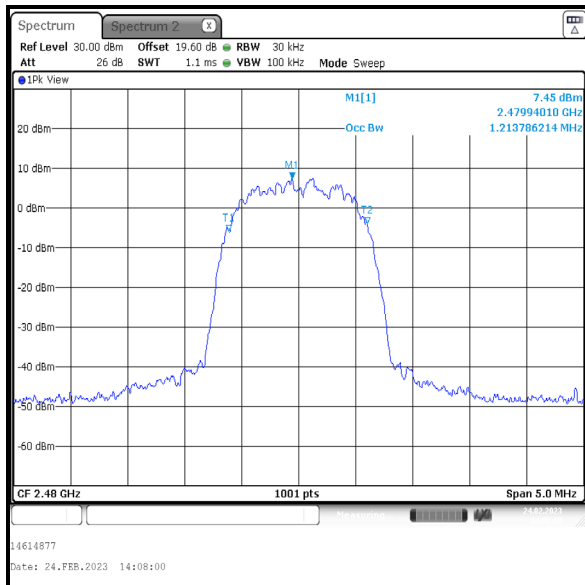

Top Channel

4.2 Transmitter 20 dB Bandwidth

Test Summary:

Test Engineers:	Matthew Botfield & Miriam Thompson	Test Dates:	24 February 2023 to 27 February 2023
Test Sample Serial Number:	M2662LV76V		

FCC Reference:	Part 15.247(a)(1)
ISED Canada Reference:	RSS-Gen 6.7 / RSS-247 5.1(a)
Test Method Used:	ANSI C63.10 Section 6.9.2

Environmental Conditions:

Temperature (°C):	19 to 21
Relative Humidity (%):	32 to 35

Note(s):

1. The signal analyser resolution bandwidth was set to 30 kHz and video bandwidth 100 kHz. A peak detector was used, sweep time was set to auto and the trace mode was Max Hold. The span was set to 4.0 MHz. Normal and delta markers were placed 20 dB down from the peak of the carrier.
2. The signal analyser was connected to the RF port on the EUT using suitable attenuation and RF cable.

Transmitter 20 dB Bandwidth (continued)

Results: 2DH5 / SISO / Core 1

Channel	20 dB Bandwidth (kHz)
Bottom	1378.600
Middle	1378.600
Top	1378.600

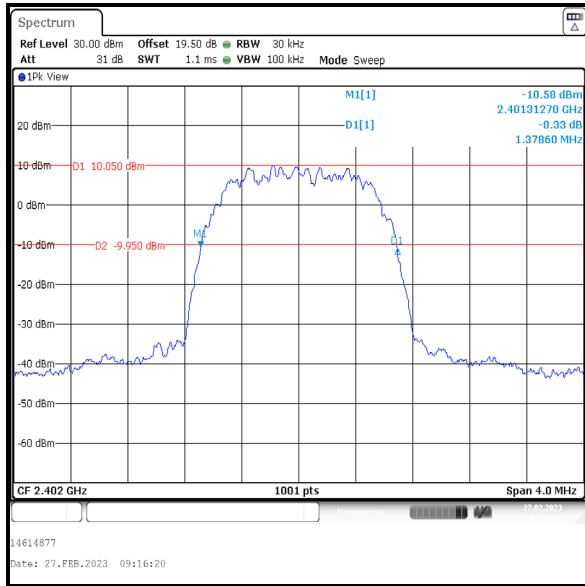

Bottom Channel

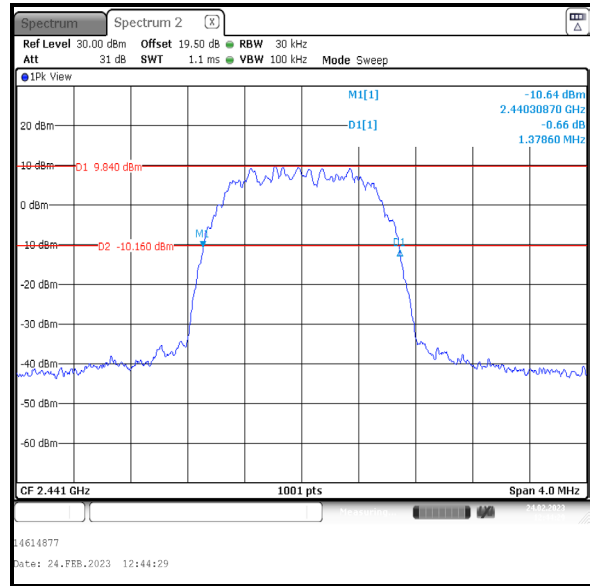

Middle Channel

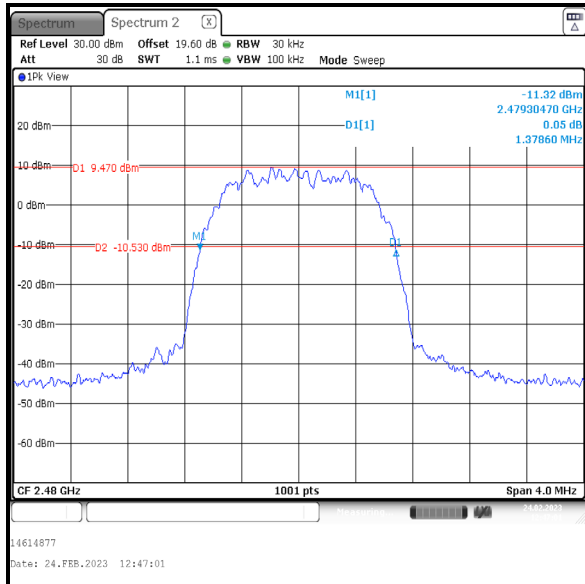

Top Channel

Transmitter 20 dB Bandwidth (continued)

Results: 3DH5 / SISO / Core 1

Channel	20 dB Bandwidth (kHz)
Bottom	1354.600
Middle	1358.600
Top	1354.600

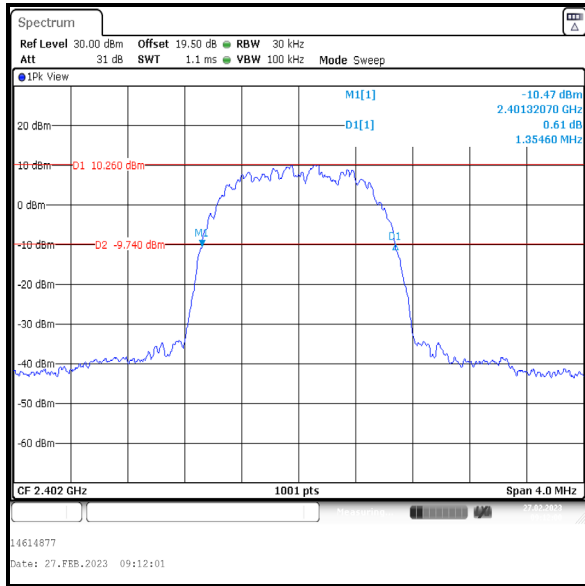

Bottom Channel

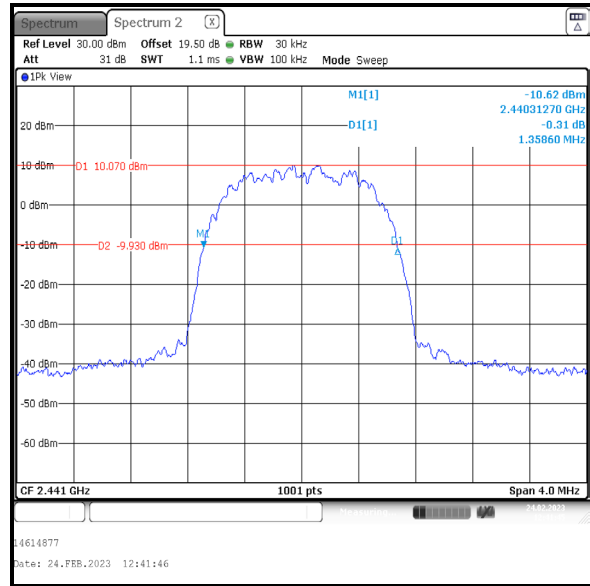

Middle Channel

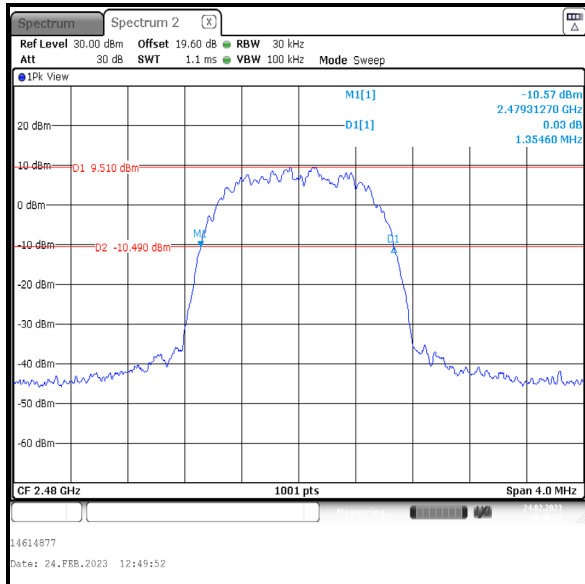

Top Channel

Transmitter 20 dB Bandwidth (continued)

Results: 2DH5 / Beamforming / Core 0

Channel	20 dB Bandwidth (kHz)
Bottom	1378.600
Middle	1374.600
Top	1378.600

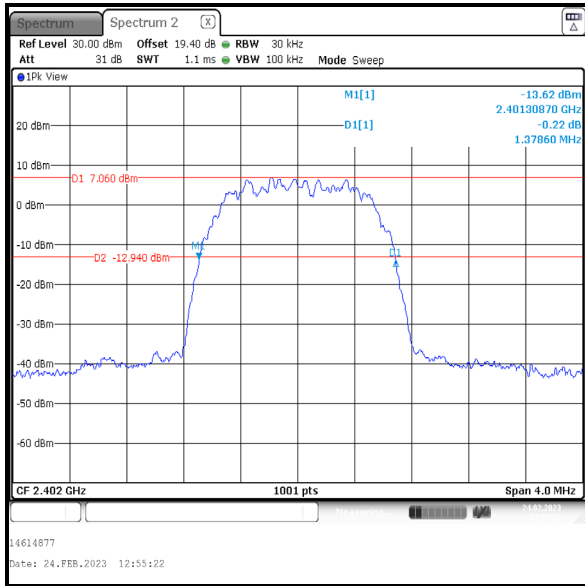

Bottom Channel

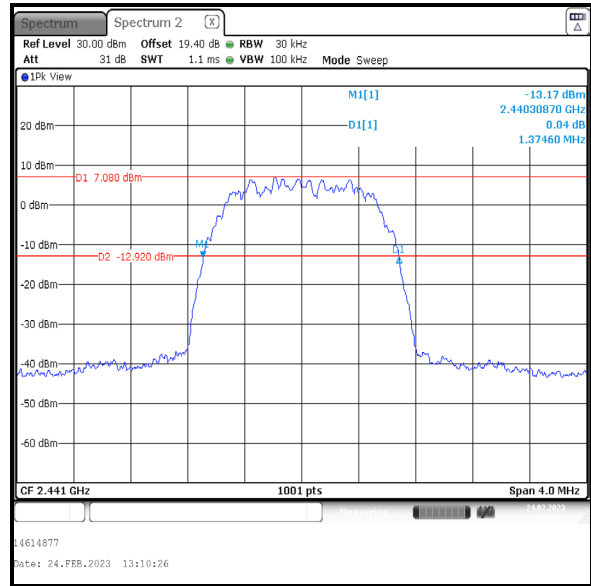

Middle Channel

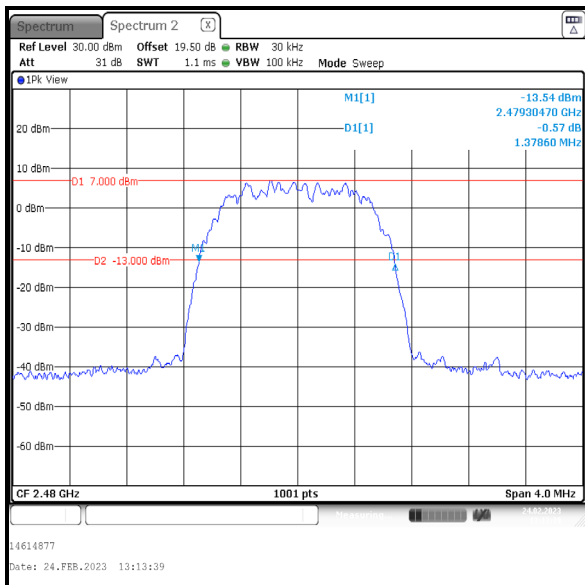

Top Channel

Transmitter 20 dB Bandwidth (continued)

Results: 2DH5 / Beamforming / Core 1

Channel	20 dB Bandwidth (kHz)
Bottom	1378.600
Middle	1374.600
Top	1378.600

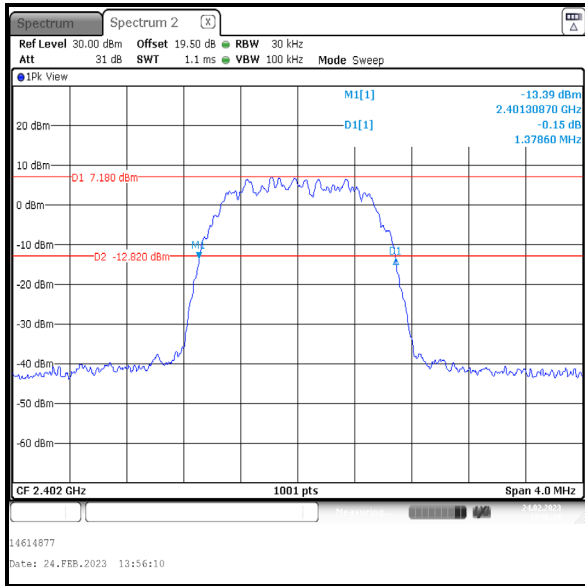

Bottom Channel

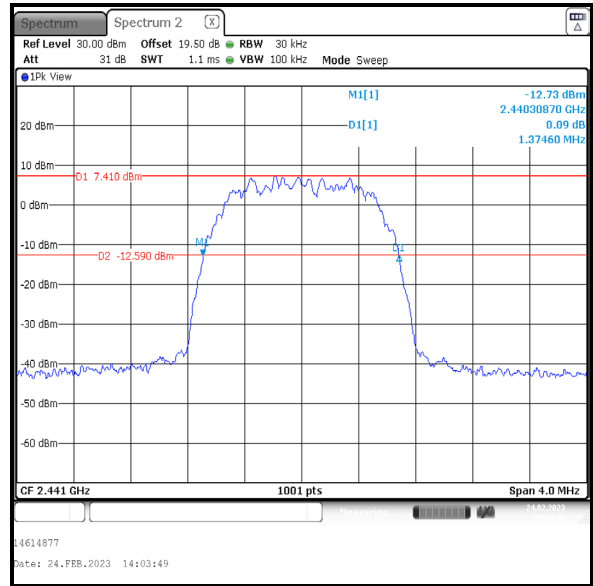

Middle Channel

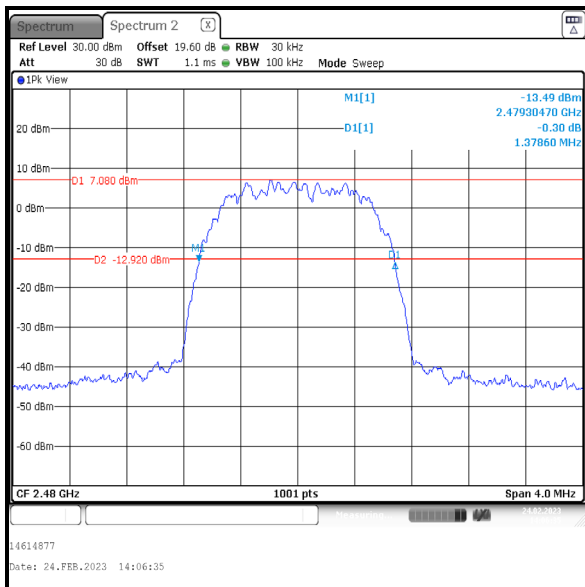

Top Channel

Transmitter 20 dB Bandwidth (continued)

Results: 3DH5 / Beamforming / Core 0

Channel	20 dB Bandwidth (kHz)
Bottom	1354.600
Middle	1358.600
Top	1358.600

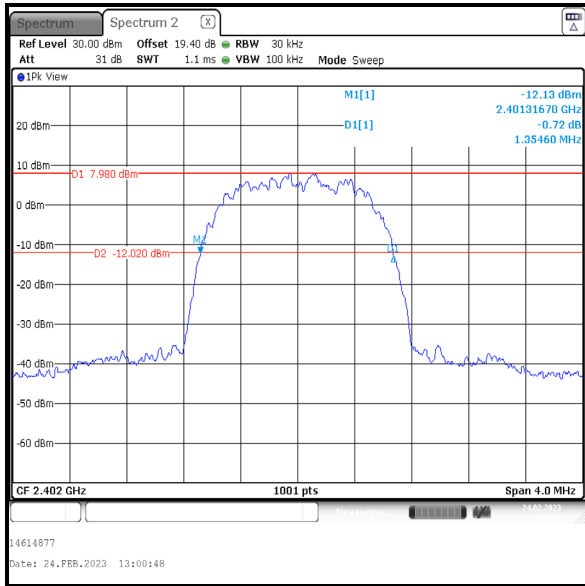

Bottom Channel

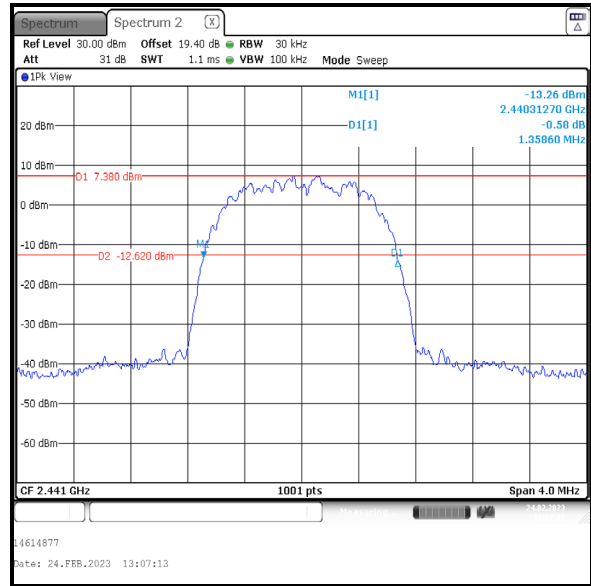

Middle Channel

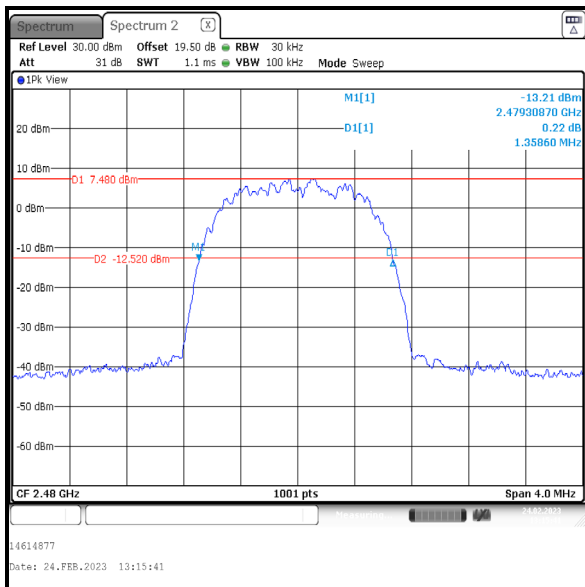

Top Channel

Transmitter 20 dB Bandwidth (continued)

Results: 3DH5 / Beamforming / Core 1

Channel	20 dB Bandwidth (kHz)
Bottom	1354.600
Middle	1358.600
Top	1358.600

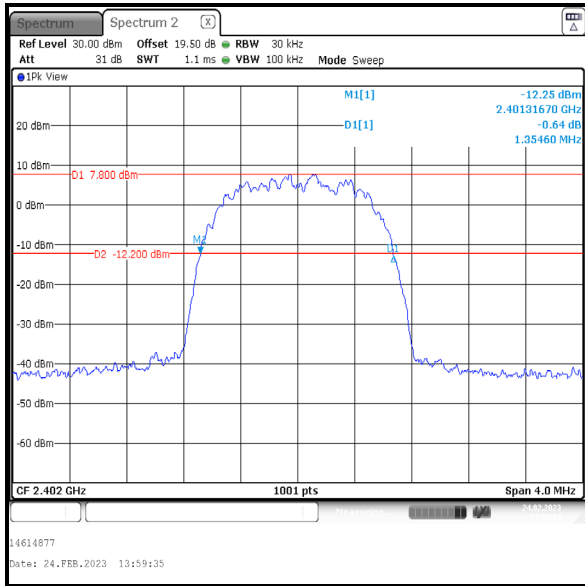

Bottom Channel

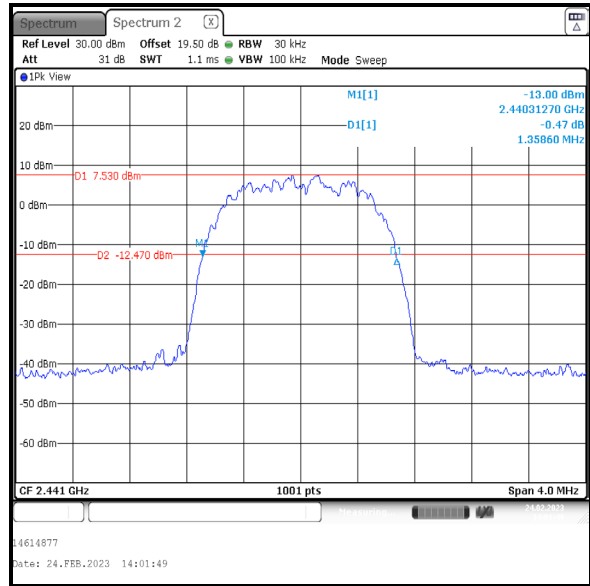

Middle Channel

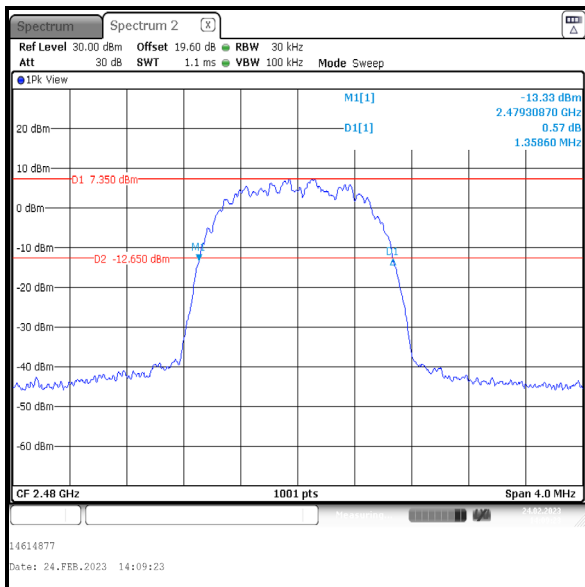

Top Channel

4.3 Transmitter Carrier Frequency Separation

Test Summary:

Test Engineers:	Matthew Botfield & Miriam Thompson	Test Date:	24 February 2023
Test Sample Serial Number:	M2662LV76V		

FCC Reference:	Part 15.247(a)(1)
ISED Canada Reference:	RSS-247 5.1(b)
Test Method Used:	ANSI C63.10 Section 7.8.2

Environmental Conditions:

Temperature (°C):	21
Relative Humidity (%):	35

Note(s):

1. The 20 dB bandwidth measured for the middle channel operating at 2441 MHz was used to calculate the limit.
2. The signal analyser resolution bandwidth was set to 30 kHz and video bandwidth 100 kHz. A peak detector was used, sweep time was set to auto and trace mode was Max Hold. The span was set to 3 MHz. A marker was placed at the centre of one signal and then a delta marker was placed in the same place on the second signal.
3. The signal analyser was connected to the RF port on the EUT using suitable attenuation and RF cable.

Transmitter Carrier Frequency Separation (continued)

Results: 2DH5 / SISO / Core 1

Carrier Frequency Separation (kHz)	Limit ($2/3$ of 20 dB BW) (kHz)	Margin (kHz)	Result
1001.00	919.067	81.933	Complied

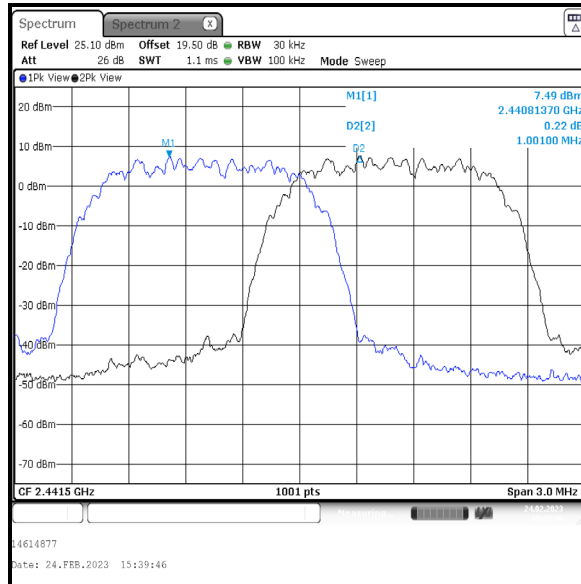

Transmitter Carrier Frequency Separation (continued)

Results: 3DH5 / SISO / Core 1

Carrier Frequency Separation (kHz)	Limit ($2/3$ of 20 dB BW) (kHz)	Margin (kHz)	Result
998.000	905.733	92.267	Complied

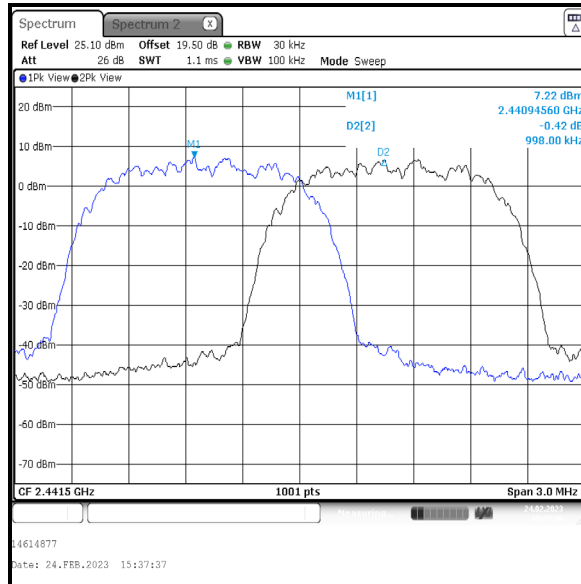

Transmitter Carrier Frequency Separation (continued)

Results: 2DH5 / Beamforming / Core 0

Carrier Frequency Separation (kHz)	Limit ($2/3$ of 20 dB BW) (kHz)	Margin (kHz)	Result
998.000	916.400	81.600	Complied

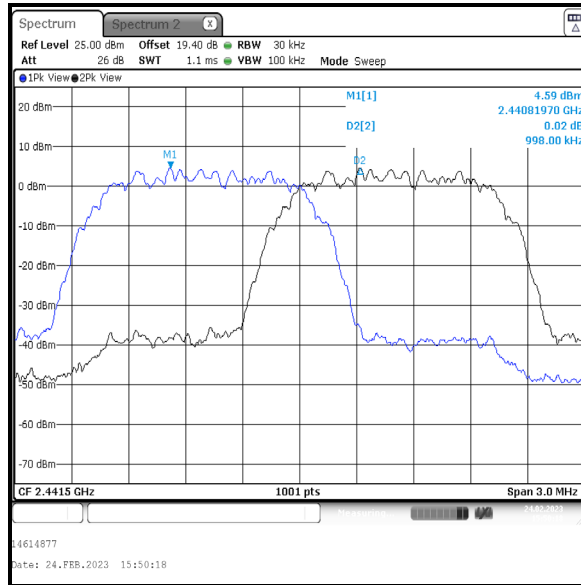

Transmitter Carrier Frequency Separation (continued)

Results: 3DH5 / Beamforming / Core 0

Carrier Frequency Separation (kHz)	Limit ($2/3$ of 20 dB BW) (kHz)	Margin (kHz)	Result
998.000	905.733	92.267	Complied

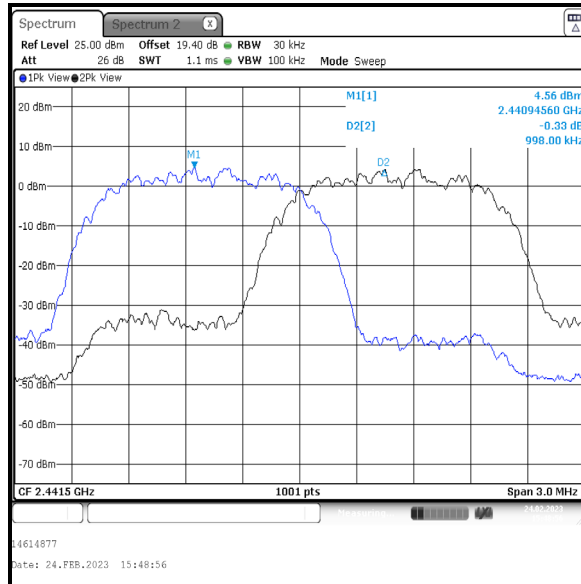

4.4 Transmitter Number of Hopping Frequencies and Average Time of Occupancy

Test Summary:

Test Engineers:	Matthew Botfield & Miriam Thompson	Test Date:	27 February 2023
Test Sample Serial Number:	M2662LV76V		

FCC Reference:	Part 15.247(a)(1)(iii)
ISED Canada Reference:	RSS-247 5.1(d)
Test Method Used:	ANSI C63.10 Sections 7.8.3 & 7.8.4

Environmental Conditions:

Temperature (°C):	19
Relative Humidity (%):	32

Note(s):

1. Tests were performed to identify the average time of occupancy in number of channels (79) x 0.4 seconds. The calculated period is 31.6 seconds.
2. The signal analyser was set up for the Number of Hopping Frequencies measurement as follows: the resolution bandwidth was set to 30 kHz and video bandwidth of 100 kHz. A peak detector was used, sweep time was set to auto and trace mode was Max Hold. The span was set to 83.5 MHz.
3. The signal analyser was set up for the Emission Width measurement as follows: the resolution bandwidth was set to 30 kHz and video bandwidth of 100 kHz. A peak detector was used and sweep time was set to auto with a span of zero Hz. The signal analyser was set to trigger at 1 ms, with a marker placed at the start of the emission and a delta marked place at the end of the emission. The emission width is recorded in the table below
4. The signal analyser was set up for the Number of Hopping Frequencies in 32 seconds measurement as follows: the resolution bandwidth was set to 30 kHz and video bandwidth of 100 kHz. A peak detector was used and sweep time was set to 32 seconds. The EUT was set to transmit in a hopping frequency mode with zero span. The total number of hopping frequencies were recorded in the table below.
5. The signal analyser was connected to the RF port on the EUT using suitable attenuation and RF cable.

Transmitter Number of Hopping Frequencies and Average Time of Occupancy (continued)

Results: SISO / Core 1

Emission Width (μ s)	Number of Hops in 31.6 Seconds	Average Time of Occupancy (s)	Limit (s)	Margin (s)	Result
2927.540	112	0.328	0.4	0.072	Complied

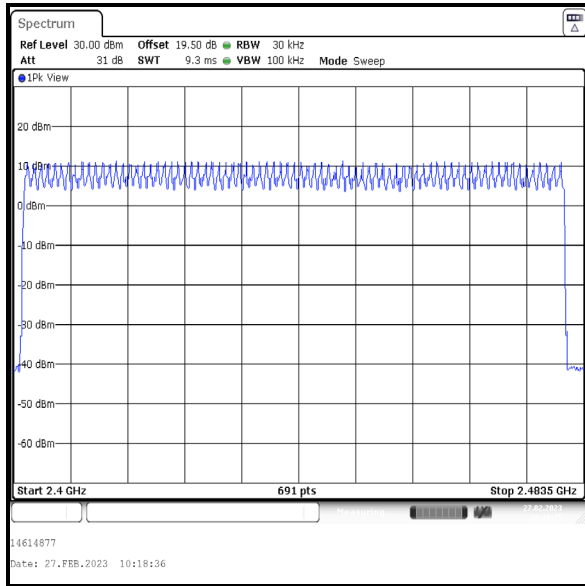

Number of Hopping Frequencies

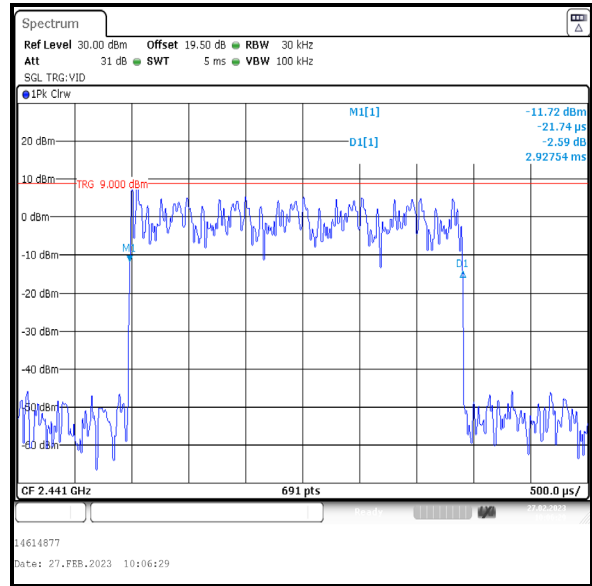

Emission Width

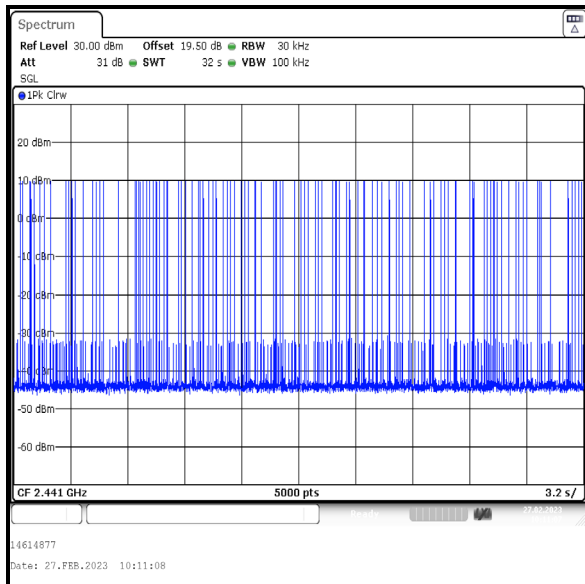

Number of Hopping Frequencies in 32 s

Transmitter Number of Hopping Frequencies and Average Time of Occupancy (continued)

Results: Beamforming / Core 1

Emission Width (μs)	Number of Hops in 31.6 Seconds	Average Time of Occupancy (s)	Limit (s)	Margin (s)	Result
2943.090	103	0.303	0.4	0.097	Complied

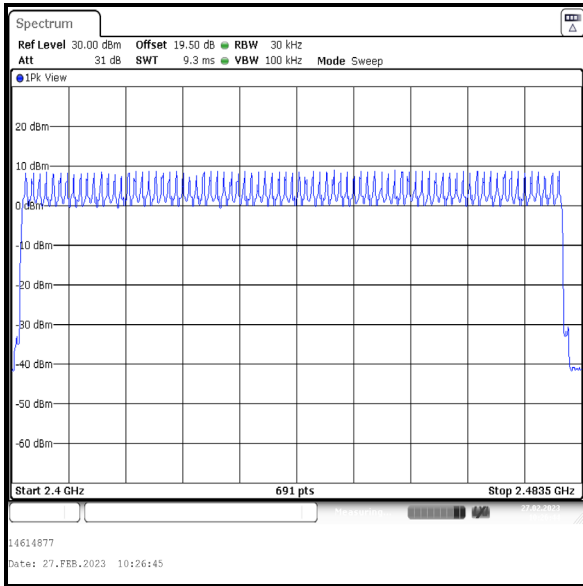

Number of Hopping Frequencies

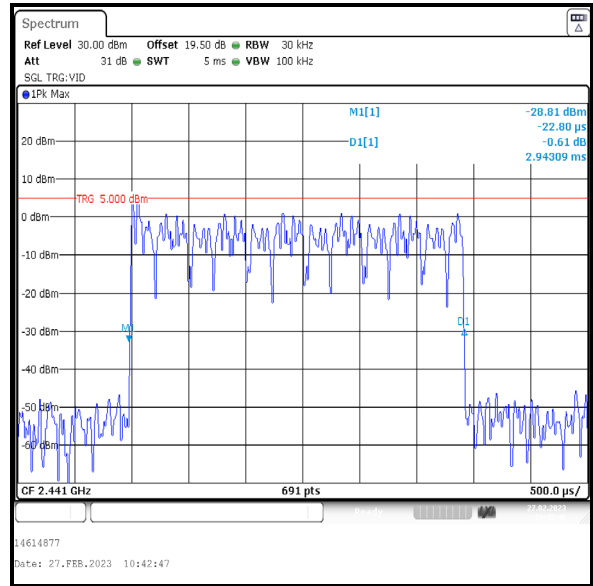

Emission Width

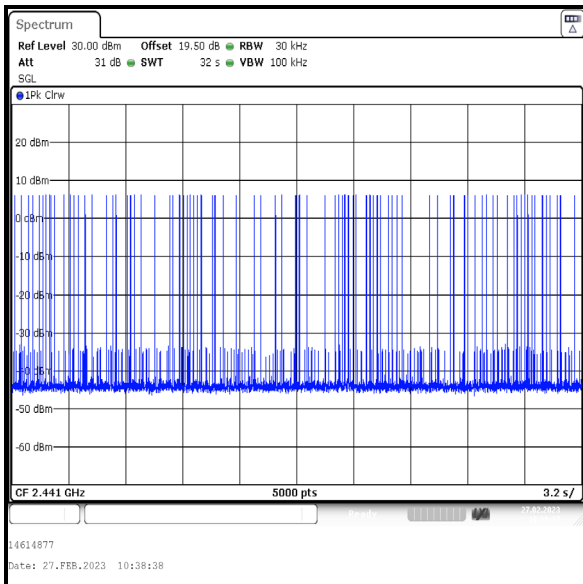

Number of Hopping Frequencies in 32 s

4.5 Transmitter Maximum Peak Output Power

Test Summary:

Test Engineers:	Matthew Botfield & Miriam Thompson	Test Date:	01 March 2023
Test Sample Serial Number:	M2662LV76V		

FCC Reference:	Part 15.247(b)(1)
ISED Canada Reference:	RSS-Gen 6.12 / RSS-247 5.4(b)
Test Method Used:	ANSI C63.10 Section 7.8.5

Environmental Conditions:

Temperature (°C):	21
Relative Humidity (%):	37

Note(s):

1. The signal analyser resolution bandwidth was set to 2 MHz (>20 dB bandwidth) and video bandwidth of 10 MHz. A peak detector was used, sweep time was set to auto and trace mode was Max Hold. The span was set to 7 MHz (approximately five times the 20 dB bandwidth). A marker was placed at the peak of the signal and the results recorded in the tables below.
2. For beamforming modes, conducted power was measured on Core 0 & Core 1 and then combined using the measure-and-sum technique stated in FCC KDB 662911 D01 Section E1). For EIRP, the directional antenna gain was added to the conducted output power.
3. The signal analyser was connected to the RF port on the EUT using suitable attenuation and RF cable. An RF offset level was entered on the signal analyser to compensate for the loss of the attenuator and RF cable.

Transmitter Maximum Peak Output Power (continued)**Results: 2DH5 / SISO / Core 1**

Channel	Conducted Peak Power (dBm)	Conducted Peak Power Limit (dBm)	Margin (dB)	Result
Bottom	18.8	21.0	2.2	Complied
Middle	19.3	21.0	1.7	Complied
Top	19.1	21.0	1.9	Complied

Channel	Conducted Peak Power (dBm)	Declared Antenna Gain (dBi)	EIRP (dBm)	EIRP Limit (dBm)	Margin (dB)	Result
Bottom	18.8	3.6	22.4	36.0	13.6	Complied
Middle	19.3	3.6	22.9	36.0	13.1	Complied
Top	19.1	3.6	22.7	36.0	13.3	Complied

Transmitter Maximum Peak Output Power (continued)

Results: 2DH5 / SISO / Core 1

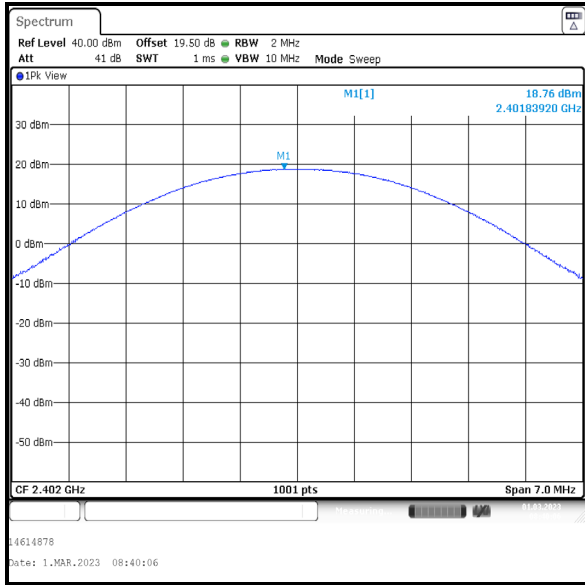

Bottom Channel

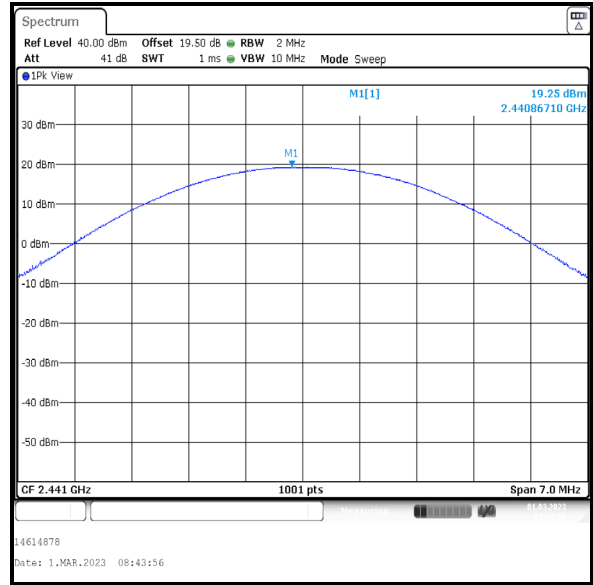

Middle Channel

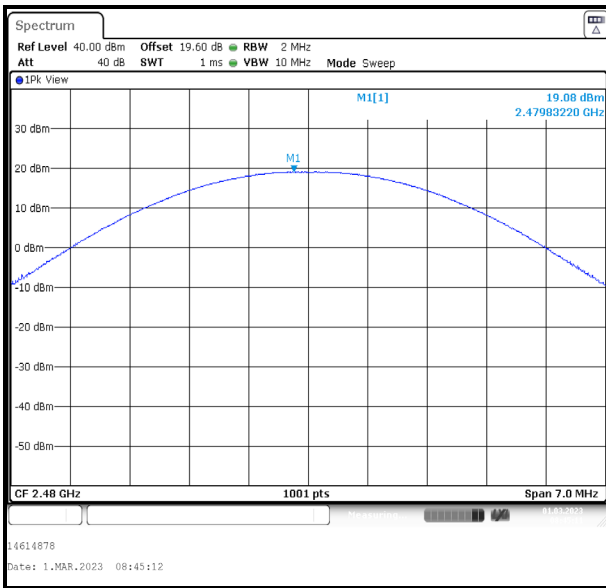

Top Channel

Transmitter Maximum Peak Output Power (continued)**Results: 3DH5 / SISO / Core 1**

Channel	Conducted Peak Power (dBm)	Conducted Peak Power Limit (dBm)	Margin (dB)	Result
Bottom	19.1	21.0	1.9	Complied
Middle	19.5	21.0	1.5	Complied
Top	19.7	21.0	1.3	Complied

Channel	Conducted Peak Power (dBm)	Declared Antenna Gain (dBi)	EIRP (dBm)	EIRP Limit (dBm)	Margin (dB)	Result
Bottom	19.1	3.6	22.7	36.0	13.3	Complied
Middle	19.5	3.6	23.1	36.0	12.9	Complied
Top	19.7	3.6	23.3	36.0	12.7	Complied

Transmitter Maximum Peak Output Power (continued)

Results: 3DH5 / SISO / Core 1

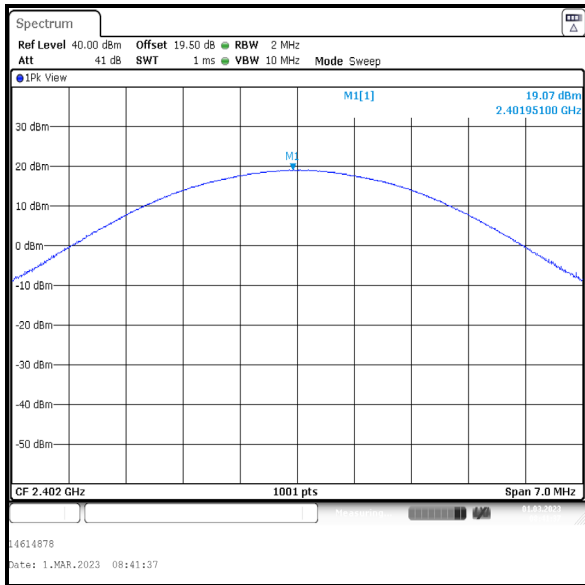

Bottom Channel

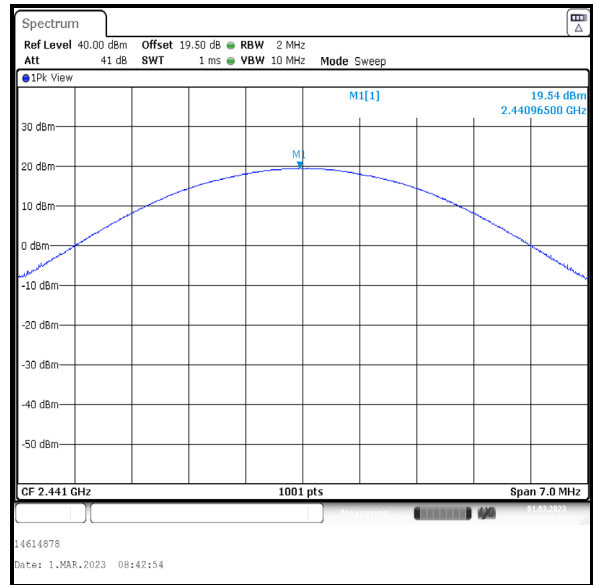

Middle Channel

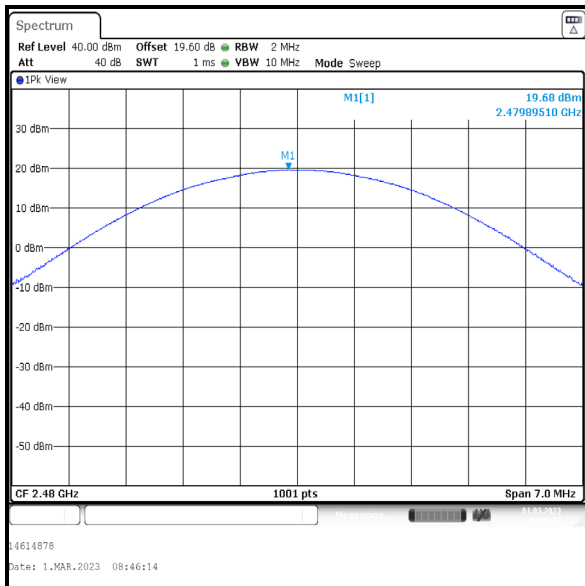

Top Channel

Transmitter Maximum Peak Output Power (continued)**Results: 2DH5 / Beamforming**

Channel	Conducted Peak Power Core 0 (dBm)	Conducted Peak Power Core 1 (dBm)	Combined Conducted Peak Power (dBm)	Conducted Peak Power Limit (dBm)	Margin (dB)	Result
Bottom	16.1	14.2	18.3	21.0	2.7	Complied
Middle	16.1	14.3	18.3	21.0	2.7	Complied
Top	15.9	13.9	18.0	21.0	3.0	Complied

Channel	Combined Conducted Peak Power (dBm)	Declared Antenna Gain (dBi)	EIRP (dBm)	EIRP Limit (dBm)	Margin (dB)	Result
Bottom	18.3	5.9	24.2	36.0	11.8	Complied
Middle	18.3	5.9	24.2	36.0	11.8	Complied
Top	18.0	5.9	23.9	36.0	12.1	Complied