

TEST REPORT

Test Report No. : UL-RPT-RP14614878JD03A

Customer : Apple Inc.
Model No. / HVIN : A2874
PMN : iMac
FCC ID : BCGA2874
ISED Certification No. : IC: 579C-A2874
Technology : Thread (IEEE 802.15.4)
Test Standard(s) : FCC Parts 15.209(a) & 15.247
Innovation, Science and Economic Development Canada
RSS-247 Issue 2 February 2017
RSS-Gen Issue 5 February 2021
Test Laboratory : UL International (UK) Ltd, Basingstoke, Hampshire, RG24 8AH,
United Kingdom

1. This test report shall not be reproduced except in full, without the written approval of UL International (UK) Ltd.
2. The results in this report apply only to the sample(s) tested.
3. The sample tested is in compliance with the above standard(s).
4. The test results in this report are traceable to the national or international standards.
5. Version 1.0.

Date of Issue: 25 April 2023

Checked by:



Ben Mercer
Lead Project Engineer, Radio Laboratory

Company Signatory:



Sarah Williams
RF Operations Leader, Radio Laboratory



5772

Customer Information

Company Name:	Apple Inc.
Address:	One Apple Park Way Cupertino, California 95014 U.S.A.
Contact Name:	Stuart Thomas

Report Revision History

Version Number	Issue Date	Revision Details	Revised By
1.0	25/04/2023	Initial Version	Ben Mercer

Table of Contents

Customer Information	2
Report Revision History	2
Table of Contents	3
1 Attestation of Test Results	4
1.1 Description of EUT	4
1.2 General Information	4
1.3 Summary of Test Results	4
1.4 Deviations from the Test Specification	4
2 Summary of Testing	5
2.1 Facilities and Accreditation	5
2.2 Methods and Procedures	5
2.3 Calibration and Uncertainty	6
2.4 Test and Measurement Equipment	7
3 Equipment Under Test (EUT)	9
3.1 Identification of Equipment Under Test (EUT)	9
3.2 Modifications Incorporated in the EUT	9
3.3 Additional Information Related to Testing	10
3.4 Description of Available Antennas	10
3.5 Description of Test Setup	11
4 Antenna Port Test Results	17
4.1 Transmitter 99% Occupied Bandwidth	17
4.2 Transmitter Minimum 6 dB Bandwidth	21
4.3 Transmitter Maximum Peak Output Power	25
4.4 Transmitter Power Spectral Density	32
5 Radiated Test Results	36
5.1 Transmitter Radiated Emissions <1 GHz	36
5.2 Transmitter Radiated Emissions >1 GHz	38
5.3 Transmitter Band Edge Radiated Emissions	40

1 Attestation of Test Results

1.1 Description of EUT

The equipment under test was an Apple desktop computer with Bluetooth® Low Energy, Thread and IEEE 802.11 a/b/g/n/ac/ax Wi-Fi capabilities in the 2.4 GHz, 5 GHz and 6 GHz bands.

1.2 General Information

Specification Reference:	47CFR15.247
Specification Title:	Code of Federal Regulations Volume 47 (Telecommunications): Part 15 Subpart C (Intentional Radiators) – Section 15.247
Specification Reference:	47CFR15.209
Specification Title:	Code of Federal Regulations Volume 47 (Telecommunications): Part 15 Subpart C (Intentional Radiators) – Section 15.209
Specification Reference:	RSS-Gen Issue 5 February 2021
Specification Title:	General Requirements for Compliance of Radio Apparatus
Specification Reference:	RSS-247 Issue 2 February 2017
Specification Title:	Digital Transmission Systems (DTSs), Frequency Hopping Systems (FHSs) and Licence-Exempt Local Area Network (LE-LAN) Devices
Site Registration:	FCC: 685609, ISEDC: 20903
FCC Lab. Designation No.:	UK2011
ISEDC CABID:	UK0001
Location of Testing:	Unit 3 Horizon, Wade Road, Kingsland Business Park, Basingstoke, Hampshire, G24 8AH, United Kingdom
Test Dates:	15 January 2023 to 23 March 2023

1.3 Summary of Test Results

FCC Reference (47CFR)	ISED Canada Reference	Measurement	Result
N/A	RSS-Gen 6.7	Transmitter 99% Occupied Bandwidth	Complied
Part 15.247(a)(2)	RSS-Gen 6.7 / RSS-247 5.2(a)	Transmitter Minimum 6 dB Bandwidth	Complied
Part 15.247(b)(3)	RSS-Gen 6.12 / RSS-247 5.4(d)	Transmitter Maximum Peak Output Power	Complied
Part 15.247(e)	RSS-247 5.2(b)	Transmitter Power Spectral Density	Complied
Part 15.247(d) & 15.209(a)	RSS-Gen 6.13 / RSS-247 5.5	Transmitter Radiated Emissions	Complied
Part 15.247(d) & 15.209(a)	RSS-Gen 6.13 / RSS-247 5.5	Transmitter Band Edge Radiated Emissions	Complied

1.4 Deviations from the Test Specification

For the measurements contained within this test report, there were no deviations from, additions to, or exclusions from the test specification identified above.

2 Summary of Testing

2.1 Facilities and Accreditation

The test site and measurement facilities used to collect data are located at Unit 3 Horizon, Wade Road, Kingsland Business Park, Basingstoke, Hampshire, RG24 8AH, United Kingdom. The following table identifies which facilities were utilised for radiated emission measurements documented in this report. Specific facilities are also identified in the test results sections.

Site 1	X
Site 2	-
Site 17	X

UL International (UK) Ltd is accredited by the United Kingdom Accreditation Service (UKAS). UKAS is one of the signatories to the International Laboratory Accreditation Co-operation (ILAC) Arrangement for the mutual recognition of test reports. The tests reported herein have been performed in accordance with its terms of accreditation.

2.2 Methods and Procedures

Reference:	ANSI C63.10-2013
Title:	American National Standard of Procedures for Compliance Testing of Unlicensed Wireless Devices
Reference:	KDB 558074 D01 15.247 Meas Guidance v05r02, April 2, 2019
Title:	Guidance for Compliance Measurements on Digital Transmission System, Frequency Hopping Spread Spectrum System, and Hybrid System Devices Operating Under Section 15.247 of the FCC Rules

2.3 Calibration and Uncertainty

Measuring Instrument Calibration

In accordance with UKAS requirements all the measurement equipment is on a calibration schedule. All equipment was within the calibration period on the date of testing.

Measurement Uncertainty & Decision Rule

Overview

No measurement or test can ever be perfect and the imperfections give rise to error of measurement in the results. Consequently the result of a measurement is only an approximation to the value of the measurand (the specific quantity subject to measurement) and is only complete when accompanied by a statement of the uncertainty of the approximation.

The expression of uncertainty of a measurement result allows realistic comparison of results with reference values and limits given in specifications and standards.

Decision Rule

The decision rule applied is based upon the accuracy method criteria. The measurement uncertainty is met and the result is considered in conformance with the requirement criteria if the observed value is within the prescribed limit.

Measurement Uncertainty

The reported expanded uncertainties below are based on a standard uncertainty multiplied by an appropriate coverage factor such that a confidence level of approximately 95% is maintained. For the purposes of this document “approximately” is interpreted as meaning “effectively” or “for most practical purposes”.

Measurement Type	Range	Confidence Level (%)	Calculated Uncertainty
99% Occupied Bandwidth	2.4 GHz to 2.4835 GHz	95%	±3.92 %
Minimum 6 dB Bandwidth	2.4 GHz to 2.4835 GHz	95%	±4.59 %
Spectral Power Density	2.4 GHz to 2.4835 GHz	95%	±1.13 dB
Conducted Maximum Peak Output Power	2.4 GHz to 2.4835 GHz	95%	±1.13 dB
Radiated Spurious Emissions	9 kHz to 30 MHz	95%	±5.32 dB
Radiated Spurious Emissions	30 MHz to 1 GHz	95%	±3.30 dB
Radiated Spurious Emissions	1 GHz to 25 GHz	95%	±3.16 dB

The methods used to calculate the above uncertainties are in line with those recommended within the various measurement specifications. Where measurement specifications do not include guidelines for the evaluation of measurement uncertainty the published guidance of the appropriate accreditation body is followed.

2.4 Test and Measurement Equipment

Test Equipment Used for Transmitter Conducted Tests

Asset No.	Instrument	Manufacturer	Type No.	Serial No.	Date Calibration Due	Cal. Interval (Months)
M2042	Thermohygrometer	Testo	608-H1	45124926	09 Dec 2023	12
A2508	Attenuator	AtlanTecRF	AN18-10	821846#3	Calibrated before use	-
M2036	Signal Analyser	Rohde & Schwarz	FSV30	101791	10 Jun 2023	12
G207635	Signal Generator	Rohde & Schwarz	SMCV100B	103200	07 Oct 2025	36

Test and Measurement Equipment (continued)**Test Equipment Used for Transmitter Radiated Emissions Tests**

Asset No.	Instrument	Manufacturer	Type No.	Serial No.	Date Calibration Due	Cal. Interval (Months)
M2040	Thermohygrometer	Testo	608-H1	45124934	09 Dec 2023	12
K0001	3m RSE Chamber	Rainford EMC	N/A	N/A	05 Sep 2023	12
M1874	Test Receiver	Rohde & Schwarz	ESU26	100553	19 May 2023	12
A3154	Pre-Amplifier	Com Power	PAM-103	18020012	18 Aug 2023	12
A3161	Antenna	Teseq	CBL6111D	50859	03 May 2023	12
A3113	Attenuator	AtlanTecRF	AN18-06	219706#3	03 May 2023	12
A3085	Low Pass Filter	AtlanTecRF	AFL-02000	18051600014	26 Jan 2024	12
A3165	Magnetic Loop Antenna	ETS-Lindgren	6502	00224383	05 May 2023	12
M2003	Thermohygrometer	Testo	608-H1	45046641	09 Dec 2023	12
K0017	3m RSE Chamber	Rainford EMC	N/A	N/A	08 Nov 2023	12
M1995	Test Receiver	Rohde & Schwarz	ESU40	100428	02 Nov 2023	12
A2863	Pre Amplifier	Agilent	8449B	3008A02100	07 Nov 2023	12
A223628	Pre Amplifier	Atlantic Microwave	A-LNAKX-380116-S5S5	210837001	02 Nov 2023	12
A3265	Pre Amplifier	Schwarzbeck	BBV 9721	9721-069	31 Oct 2023	12
A2889	Antenna	Schwarzbeck	BBHA 9120 B	653	02 Nov 2023	12
A2890	Antenna	Schwarzbeck	HWRD 750	014	02 Nov 2023	12
A2892	Antenna	Schwarzbeck	BBHA 9170	9170-727	31 Oct 2023	12
A2916	Attenuator	AtlanTecRF	AN18W5-10	832827#1	25 Jan 2024	12
A2914	High Pass Filter	AtlanTecRF	AFH-03000	2155	25 Jan 2024	12
A2947	High Pass Filter	AtlanTecRF	AFH-07000	1601900001	25 Jan 2024	12

Test Equipment Used for Transmitter Band Edge Radiated Emissions Tests

Asset No.	Instrument	Manufacturer	Type No.	Serial No.	Date Calibration Due	Cal. Interval (Months)
M2003	Thermohygrometer	Testo	608-H1	45046641	09 Dec 2023	12
K0017	3m RSE Chamber	Rainford EMC	N/A	N/A	08 Nov 2023	12
M1995	Test Receiver	Rohde & Schwarz	ESU40	100428	02 Nov 2023	12
A2863	Pre Amplifier	Agilent	8449B	3008A02100	07 Nov 2023	12
A2916	Attenuator	AtlanTecRF	AN18W5-10	832827#1	25 Jan 2024	12
A2889	Antenna	Schwarzbeck	BBHA 9120 B	B653	02 Nov 2023	12

3 Equipment Under Test (EUT)

3.1 Identification of Equipment Under Test (EUT)

Brand Name:	Apple
Model Name or Number / HVIN:	A2874
PMN:	iMac
Test Sample Serial Number:	RHKHHQ9YHK (<i>Conducted sample</i>)
Hardware Version:	REV 1.0
Software Version:	22E31551a
FCC ID:	BCGA2874
ISED Canada Certification Number:	IC: 579C-A2874
Date of Receipt:	21 February 2023

Brand Name:	Apple
Model Name or Number / HVIN:	A2874
PMN:	iMac
Test Sample Serial Number:	NQHHW969D9 (<i>Radiated sample</i>)
Hardware Version:	REV 1.0
Software Version:	22E31550w
FCC ID:	BCGA2874
ISED Canada Certification Number:	IC: 579C-A2874
Date of Receipt:	10 January 2023

3.2 Modifications Incorporated in the EUT

No modifications were applied to the EUT during testing.

3.3 Additional Information Related to Testing

Technology Tested:	Thread (Digital Transmission System)		
Type of Unit:	Transceiver		
Channel Spacing:	5 MHz		
Modulation:	OQPSK		
Data Rate (kbps):	250		
Power Supply Requirement(s):	Nominal	12 VDC via 120 VAC 60 Hz adaptor	
Maximum Conducted Output Power:	21.6 dBm		
Transmit Frequency Range:	2400 MHz to 2483.5 MHz		
Transmit Channels Tested:	Channel ID	Channel Number	Channel Frequency (MHz)
	Bottom	11	2405
	Middle	18	2440
	Top	25	2475

3.4 Description of Available Antennas

The radio utilizes three integrated antennas, with the following maximum gains:

Antenna Port	Frequency Range (MHz)	Antenna Gain (dBi)
Core 0	2400 to 2480	2.1
Core 1	2400 to 2480	3.6
Dedicated Core	2400 to 2480	0.6

3.5 Description of Test Setup

Support Equipment

The following support equipment was used to exercise the EUT during testing:

Description:	Test Laptop
Brand Name:	Apple
Model Name or Number:	MacBook Pro
Serial Number:	C02YK003L59F

Description:	USB Diagnostic Cable
Brand Name:	Apple
Model Name or Number:	Chimp
Serial Number:	428A84

Description:	4 port USB Termination Hub. Quantity 1
Brand Name:	Uni
Model Name or Number:	Not marked or stated
Serial Number:	Not marked or stated

Description:	USB-A Cable. Quantity 2. Length 3m.
Brand Name:	Not marked or stated
Model Name or Number:	Not marked or stated
Serial Number:	Not marked or stated

Description:	USB-C to A Adaptor. Quantity 2. Length 10 cm.
Brand Name:	Not marked or stated
Model Name or Number:	Not marked or stated
Serial Number:	Not marked or stated

Description:	Personal Hands Free (PHF)
Brand Name:	Not marked or stated
Model Name or Number:	Not marked or stated
Serial Number:	Not marked or stated

Description:	Power Adaptor
Brand Name:	Apple
Model Name or Number:	A2290
Serial Number:	Not marked or stated

Support Equipment (continued)

Description:	Test Laptop
Brand Name:	Apple
Model Name or Number:	MacBook Pro
Serial Number:	C02YK007MHL1

Description:	USB Diagnostic Cable
Brand Name:	Apple
Model Name or Number:	Chimp
Serial Number:	428D2A

Operating Modes

The EUT was tested in the following operating mode(s):

- Continuously transmitting at maximum power on bottom, middle and top channels as required.
- Transmitting on Core 0, Core 1 or Core 2 on either the iPA or ePA path.

Configuration and Peripherals

The EUT was tested in the following configuration(s):

- Controlled in test mode using a set of commands entered into a terminal application on the EUT supplied by the customer. The commands were used to enable a continuous transmission and to select the test channels as required. The customer supplied a document containing the setup instructions.
- The EUT has a dedicated core (Core 2), which operates on the iPA path only, in addition to two cores which operate on both ePA and iPA paths. Core 0 & Core 1 are identical but have unequal gains therefore conducted tests have been performed on the Core with the highest antenna gain. Modes tested were:
 - SISO / Core 1 / iPA
 - SISO / Core 1 / ePA
 - SISO / Core 2 / iPA
- The customer supplied U.FL RF cables with the EUT in order to perform conducted measurements. This measured additional path loss was included in any path loss calculations.
- The EUT was powered from a 120 VAC 60 Hz single phase mains supply.
- Transmitter radiated spurious emissions tests were performed with the EUT transmitting on Core 1 as this mode was found to transmit the highest power and spectral density.
- Radiated spurious emissions and band edge tests were performed with the EUT in its normal orientation. All ports were terminated into suitable terminations and placed under the turntable.

Test Setup Diagrams

Conducted Tests:

Test Setup for Transmitter Conducted Tests

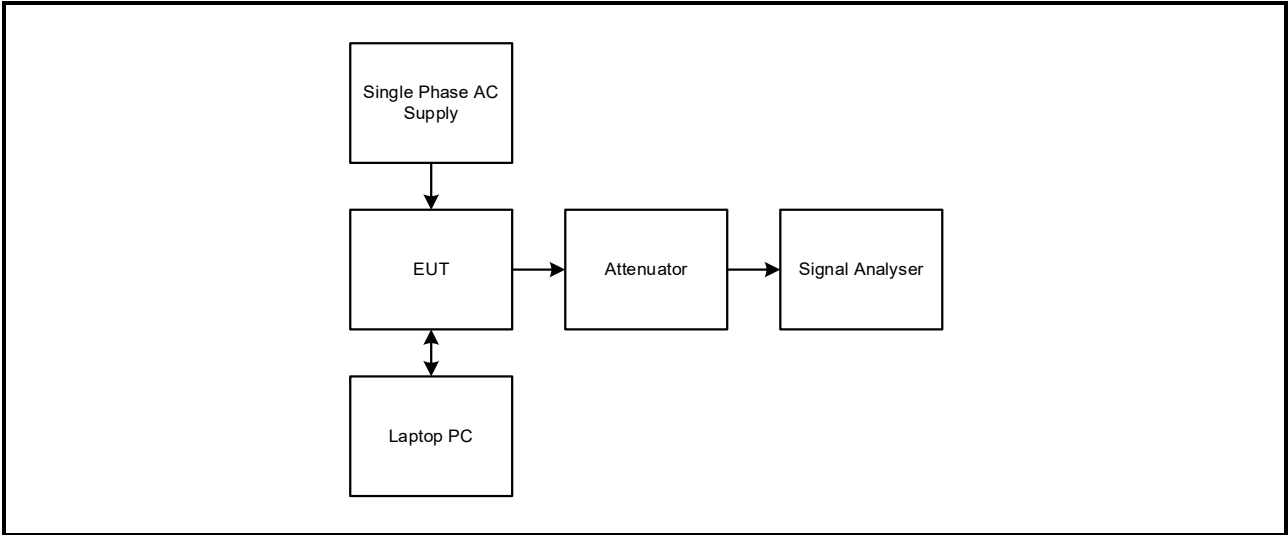

Test Setup Diagrams (continued)

Radiated Tests:

Test Setup for Transmitter Radiated Emissions

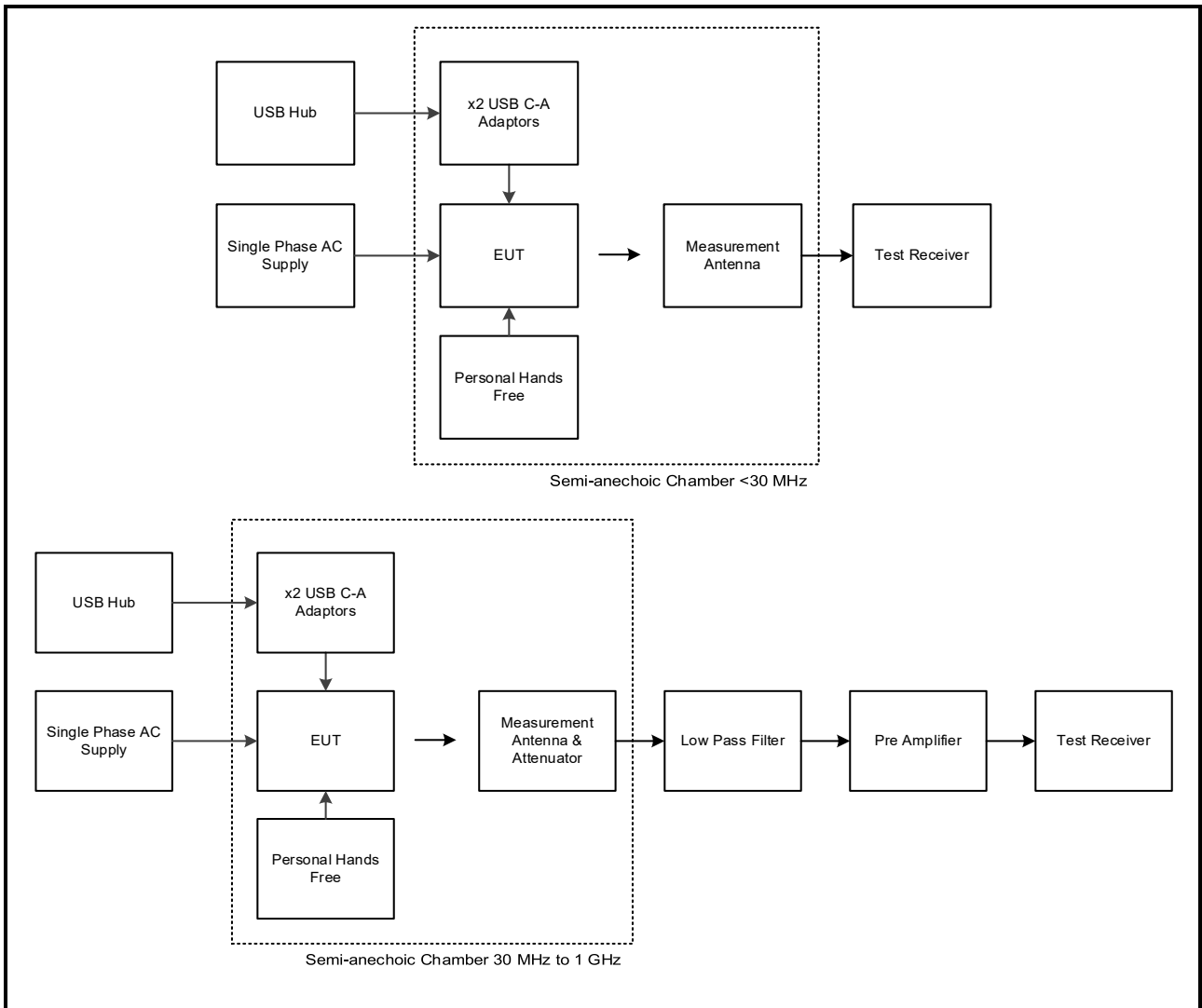

Test Setup Diagrams (continued)

Test Setup for Transmitter Radiated Emissions (continued)

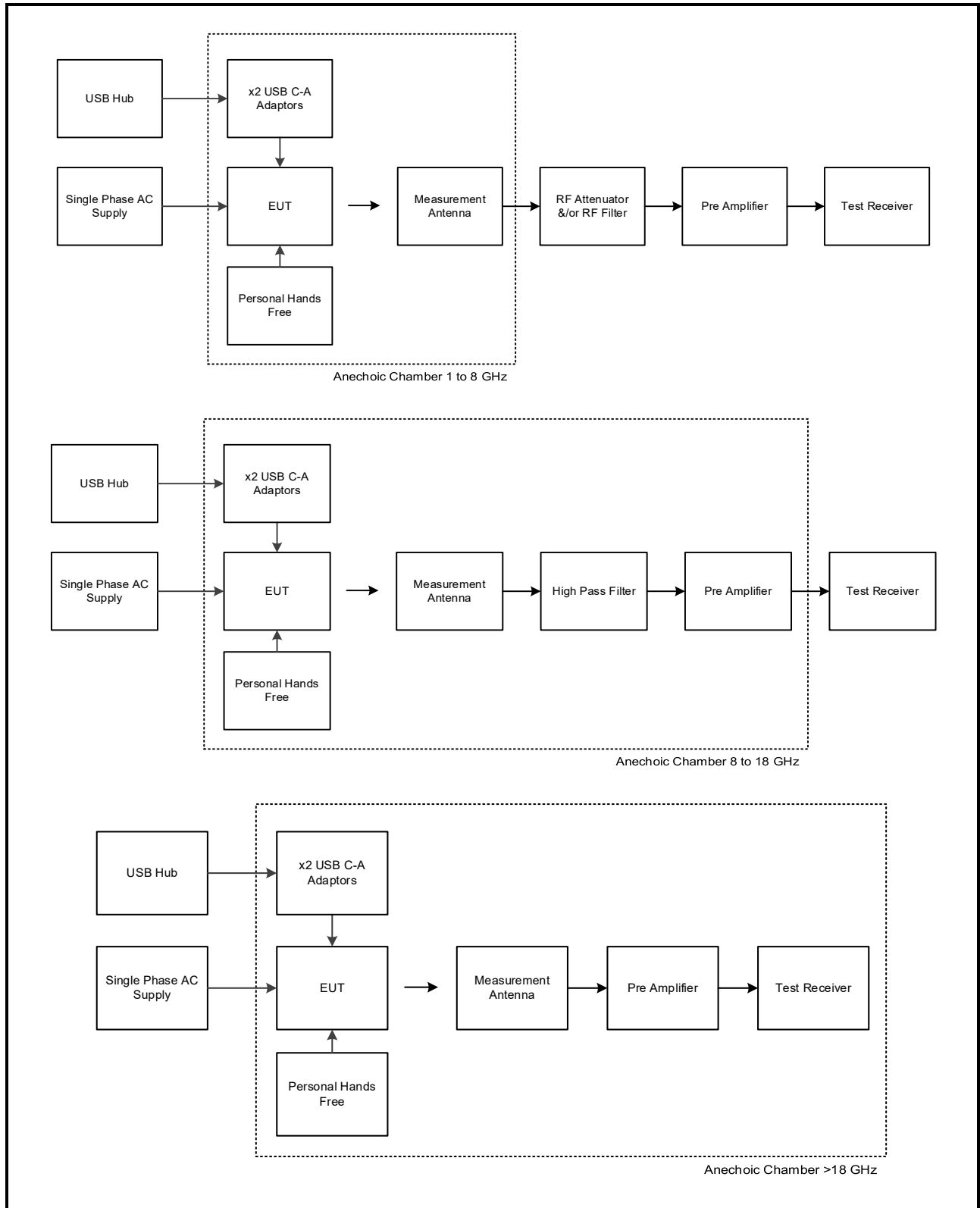

4 Antenna Port Test Results

4.1 Transmitter 99% Occupied Bandwidth

Test Summary:

Test Engineers:	Max Passell & Jiyu Zou	Test Date:	21 March 2023
Test Sample Serial Number:	RHKHHQ9YHK		

FCC Reference:	N/A
ISED Canada Reference:	RSS-Gen 6.7
Test Method Used:	RSS-Gen 6.7 and Notes below

Environmental Conditions:

Temperature (°C):	23
Relative Humidity (%):	48

Note(s):

1. The 99% emission bandwidth was measured using the signal analyser occupied bandwidth function. The resolution bandwidth was set in the range of 1% to 5% of the occupied bandwidth and the video bandwidth set to 3 times the resolution bandwidth. The span was set to capture all products of the modulation process including emission skirts.
2. The signal analyser resolution bandwidth was set to 50 kHz and video bandwidth 200 kHz. A peak detector was used, sweep time was set to auto and the trace mode was Max Hold. The span was set to 8 MHz. The signal analyser function set the measurements to be made at 99% of the emission bandwidth. The results are given in the tables below.
3. The signal analyser was connected to the RF port on the EUT using suitable attenuation and RF cable.

Transmitter 99% Occupied Bandwidth (continued)

Results: Core 1 / iPA

Channel	99% Occupied Bandwidth (kHz)
Bottom	2570.188
Middle	2570.188
Top	2581.766

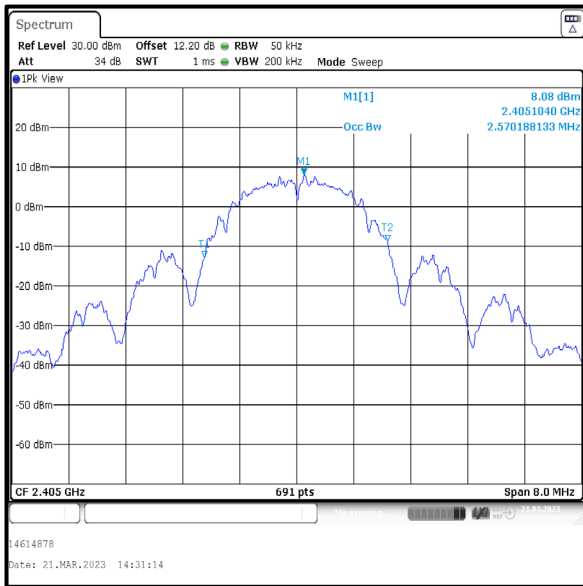

Bottom Channel

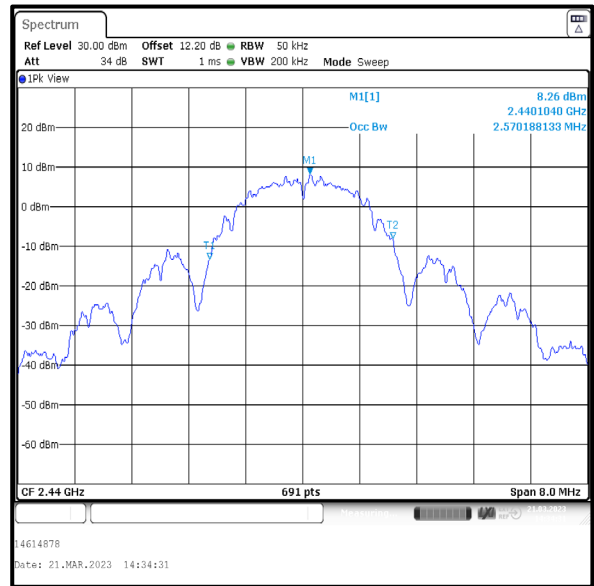

Middle Channel

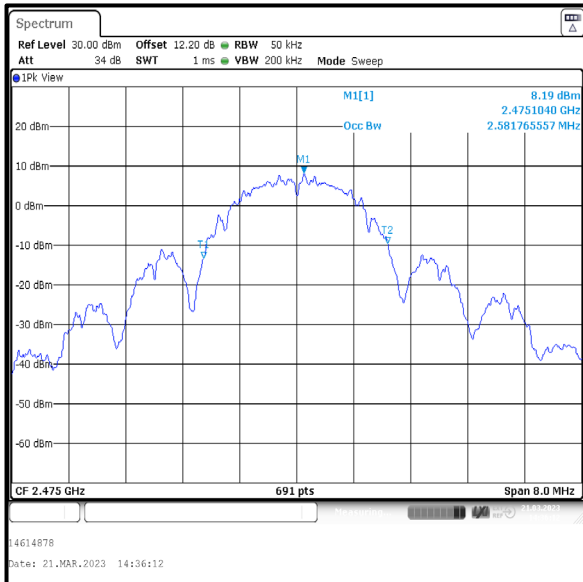

Top Channel

Transmitter 99% Occupied Bandwidth (continued)

Results: Core 1 / ePA

Channel	99% Occupied Bandwidth (kHz)
Bottom	2535.456
Middle	2535.456
Top	2535.456

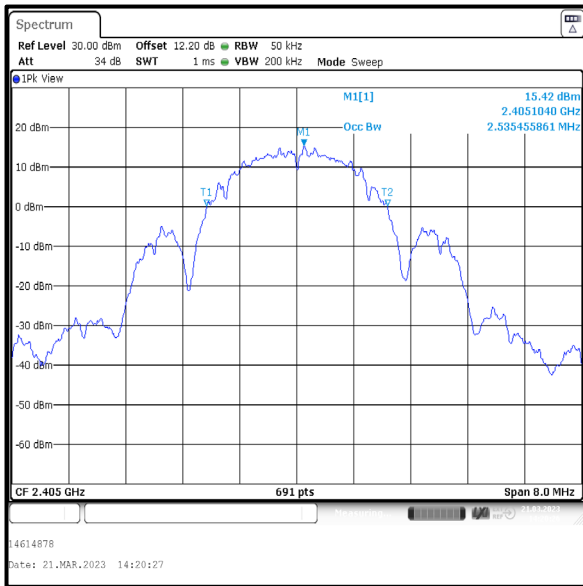

Bottom Channel

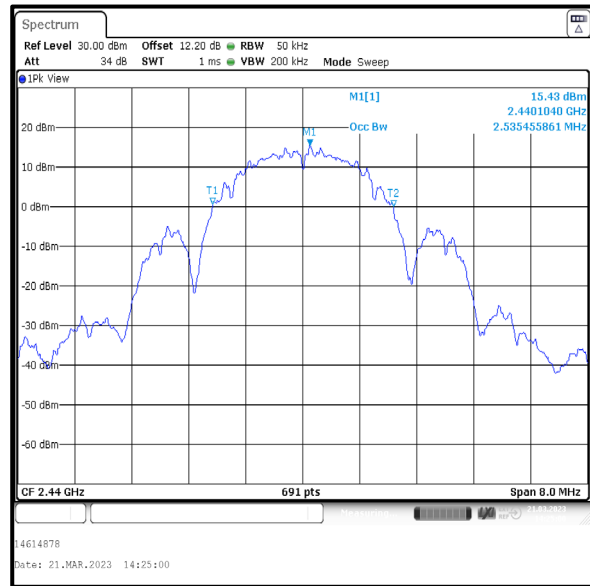

Middle Channel



Top Channel

Transmitter 99% Occupied Bandwidth (continued)

Results: Core 2 / iPA

Channel	99% Occupied Bandwidth (kHz)
Bottom	2523.878
Middle	2523.878
Top	2535.456

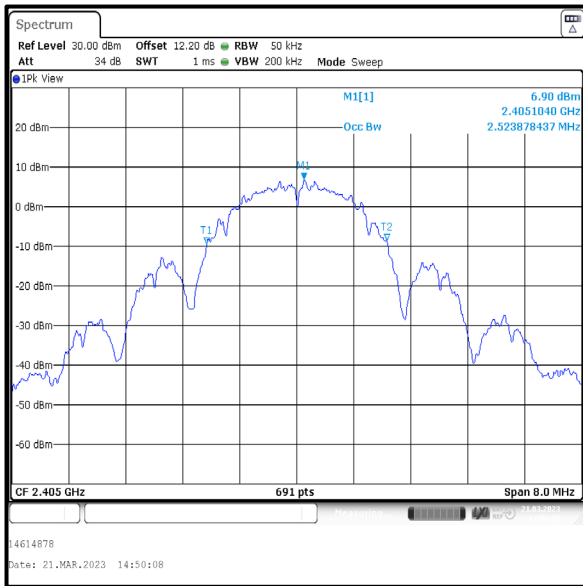

Bottom Channel

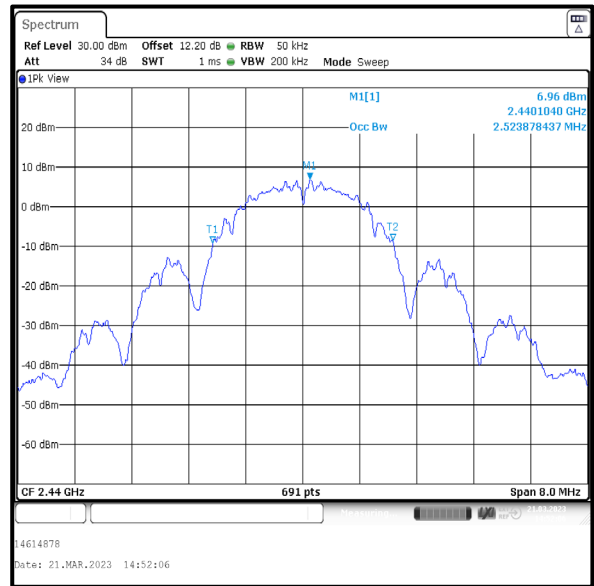

Middle Channel

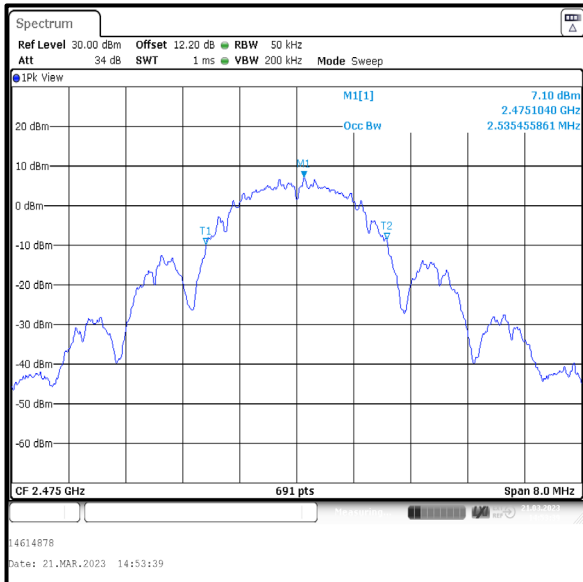

Top Channel

4.2 Transmitter Minimum 6 dB Bandwidth

Test Summary:

Test Engineers:	Max Passell & Jiyu Zou	Test Date:	22 March 2023
Test Sample Serial Number:	RHKHHQ9YHK		

FCC Reference:	Part 15.247(a)(2)
ISED Canada Reference:	RSS-Gen 6.7 / RSS-247 5.2(a)
Test Method Used:	FCC KDB 558074 Section 8.2 referencing ANSI C63.10 Section 11.8.1

Environmental Conditions:

Temperature (°C):	24
Relative Humidity (%):	47

Note(s):

1. 6 dB DTS bandwidth tests were performed using a signal analyser in accordance with ANSI C63.10 Section 11.8.1 Option 1 measurement procedure. The signal analyser resolution bandwidth was set to 100 kHz and video bandwidth 300 kHz. A peak detector was used, sweep time was set to auto and the trace mode was Max Hold. The DTS bandwidth was measured at 6 dB down from the peak of the signal.
2. The signal analyser was connected to the RF port on the EUT using suitable attenuation and RF cable.

Transmitter Minimum 6 dB Bandwidth (continued)

Results: Core 1 / iPA

Channel	6 dB Bandwidth (kHz)	Limit (kHz)	Margin (kHz)	Result
Bottom	1613.60	≥500	1113.60	Complied
Middle	1613.60	≥500	1113.60	Complied
Top	1613.60	≥500	1113.60	Complied

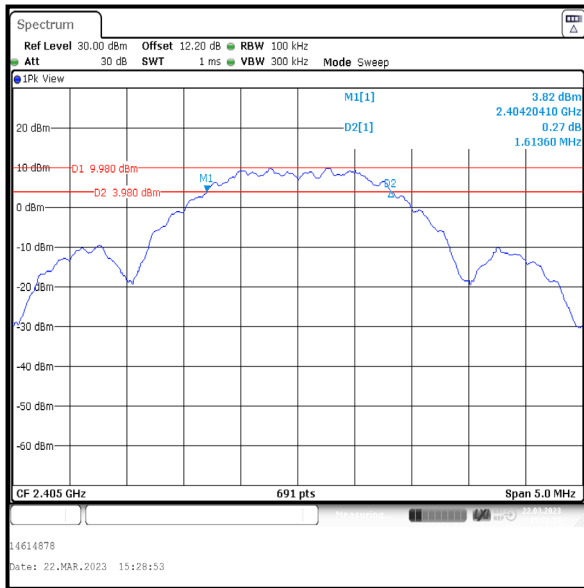

Bottom Channel

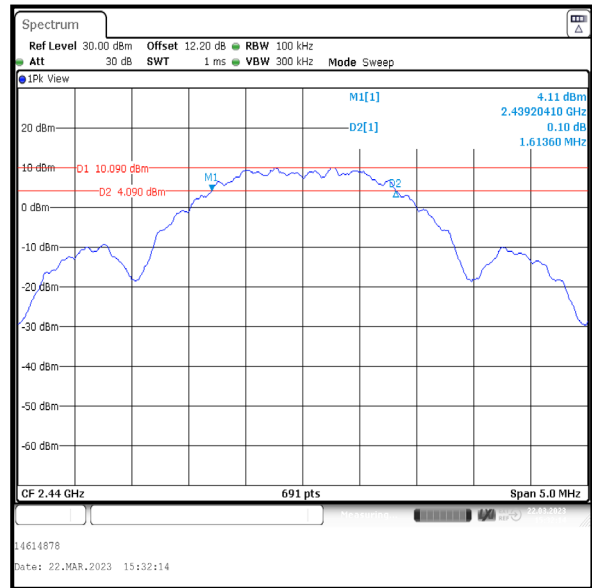

Middle Channel

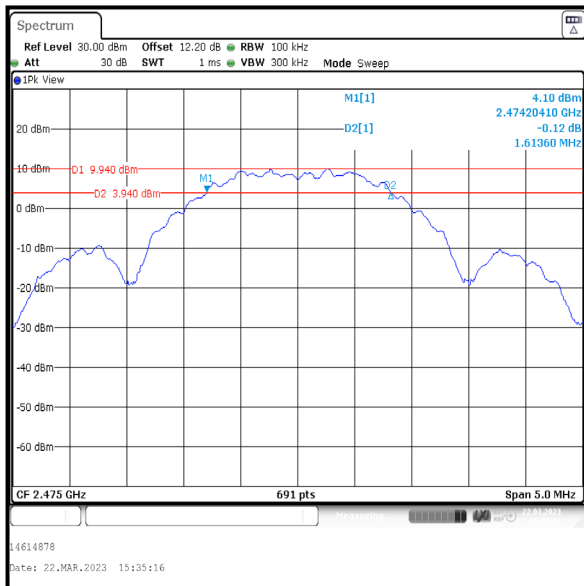

Top Channel

Transmitter Minimum 6 dB Bandwidth (continued)

Results: Core 1 / ePA

Channel	6 dB Bandwidth (kHz)	Limit (kHz)	Margin (kHz)	Result
Bottom	1628.10	≥500	1128.10	Complied
Middle	1628.10	≥500	1128.10	Complied
Top	1628.10	≥500	1128.10	Complied

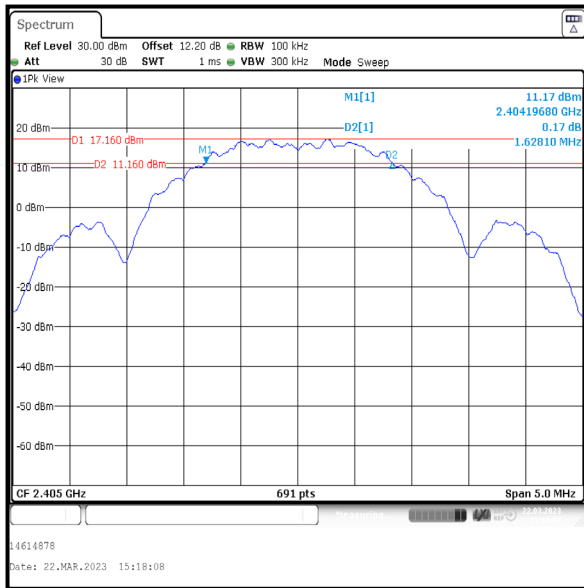

Bottom Channel

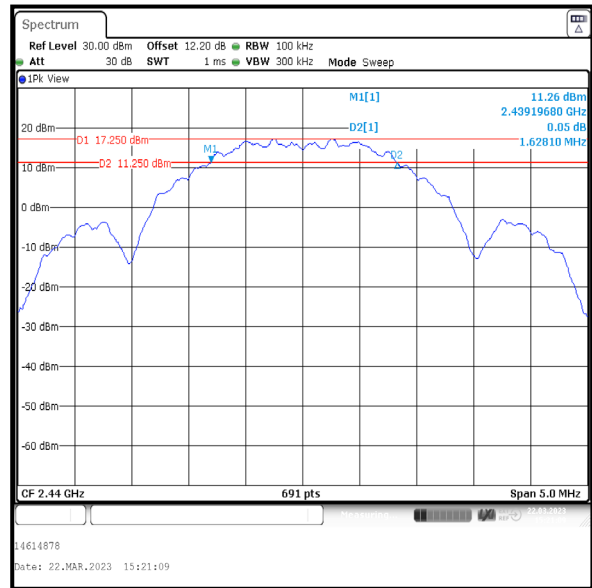

Middle Channel

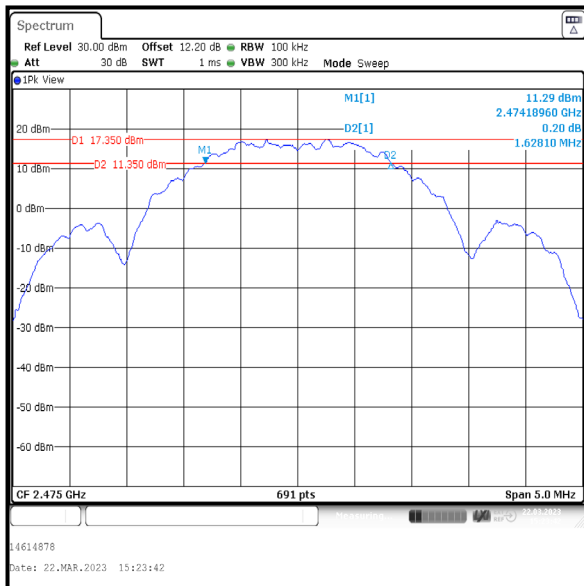

Top Channel

Transmitter Minimum 6 dB Bandwidth (continued)

Results: Core 2 / iPA

Channel	6 dB Bandwidth (kHz)	Limit (kHz)	Margin (kHz)	Result
Bottom	1620.80	≥500	1120.80	Complied
Middle	1620.80	≥500	1120.80	Complied
Top	1620.80	≥500	1120.80	Complied

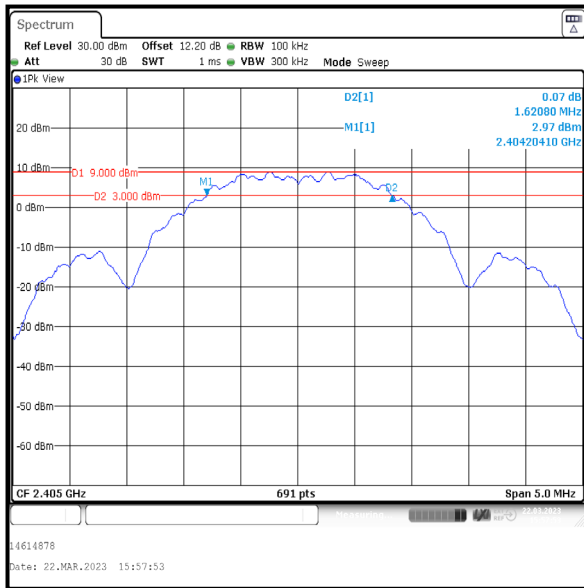

Bottom Channel

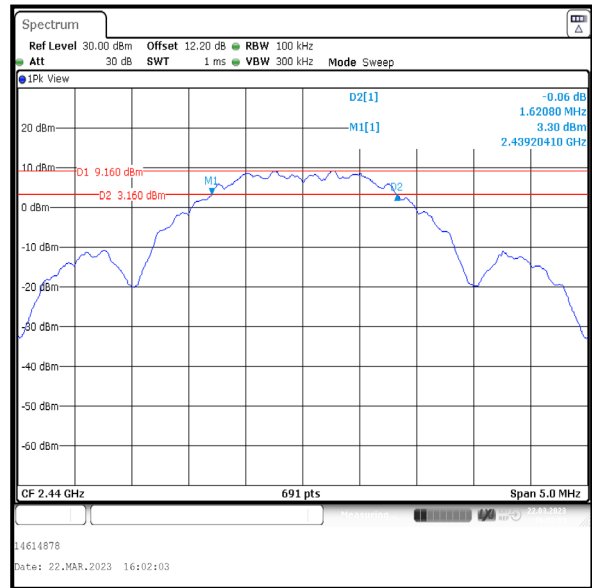

Middle Channel

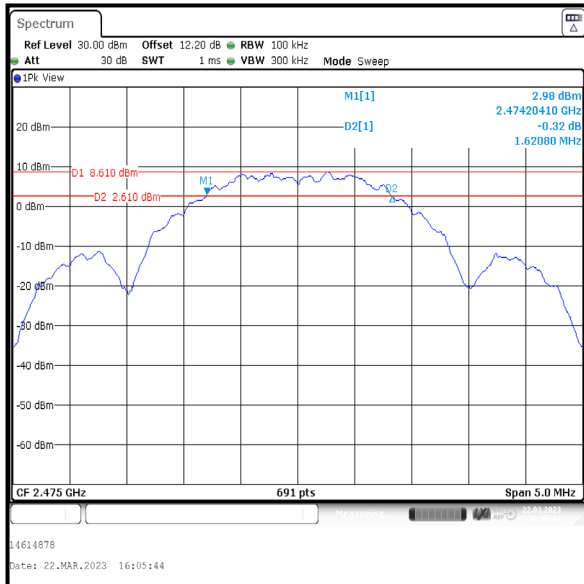

Top Channel

4.3 Transmitter Maximum Peak Output Power

Test Summary:

Test Engineers:	Max Passell & Jiyu Zou	Test Date:	23 March 2023
Test Sample Serial Number:	RHKHHQ9YHK		

FCC Reference:	Part 15.247(b)(3)
ISED Canada Reference:	RSS-Gen 6.12 / RSS-247 5.4(d)
Test Method Used:	FCC KDB 558074 Section 8.3.1.1 referencing ANSI C63.10 Section 11.9.1.1 and Notes below

Environmental Conditions:

Temperature (°C):	24
Relative Humidity (%):	45

Note(s):

1. Conducted power tests were performed using a signal analyser in accordance with ANSI C63.10 Section 11.9.1.1 with the RBW \geq DTS bandwidth procedure.
2. The signal analyser resolution bandwidth was set to 2 MHz and video bandwidth of 10 MHz. A peak detector was used, sweep time was set to auto and trace mode was Max Hold. The span was set to 6 MHz. A marker was placed at the peak of the signal and the results recorded in the tables below.
3. The signal analyser was connected to the RF port on the EUT using suitable attenuation and RF cable. An RF level offset was entered on the signal analyser to compensate for the loss of the attenuator and RF cable.

Transmitter Maximum Peak Output Power (continued)**Results: Core 1 / iPA**

Channel	Conducted Peak Power (dBm)	Conducted Peak Power Limit (dBm)	Margin (dB)	Result
Bottom	13.9	30.0	16.1	Complied
Middle	14.0	30.0	16.0	Complied
Top	13.9	30.0	16.1	Complied

Channel	Conducted Peak Power (dBm)	Declared Antenna Gain (dBi)	EIRP (dBm)	EIRP Limit (dBm)	Margin (dB)	Result
Bottom	13.9	3.6	17.5	36.0	18.5	Complied
Middle	14.0	3.6	17.6	36.0	18.4	Complied
Top	13.9	3.6	17.5	36.0	18.5	Complied

Transmitter Maximum Peak Output Power (continued)

Results: Core 1 / iPA

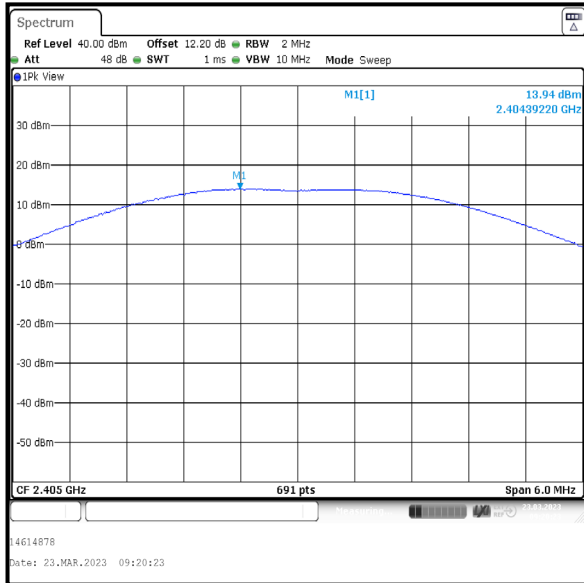

Bottom Channel

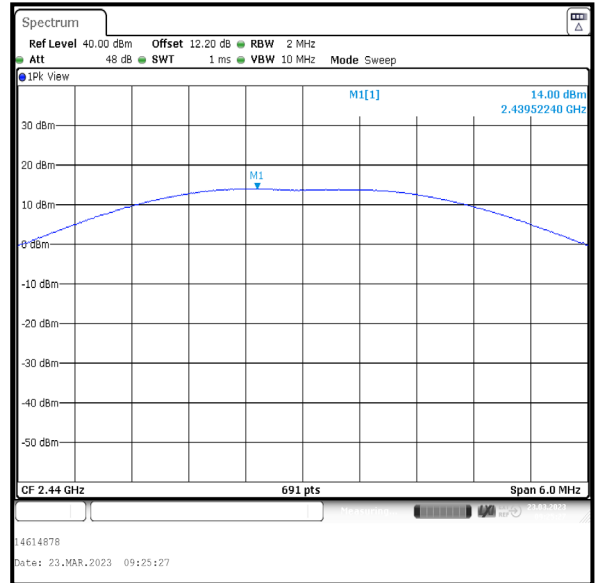

Middle Channel

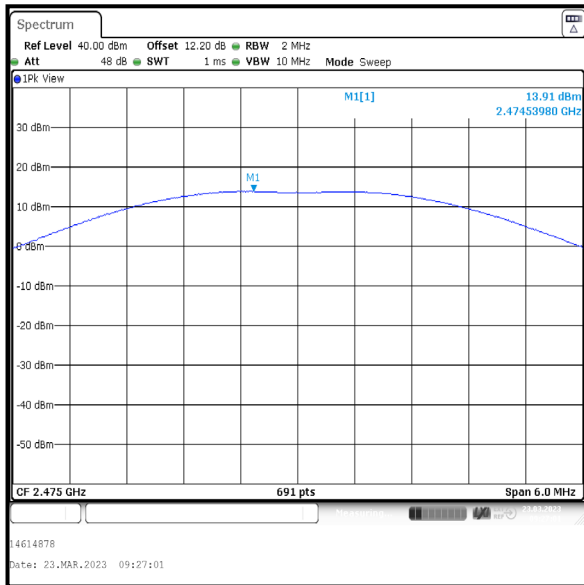

Top Channel

Transmitter Maximum Peak Output Power (continued)**Results: Core 1 / ePA**

Channel	Conducted Peak Power (dBm)	Conducted Peak Power Limit (dBm)	Margin (dB)	Result
Bottom	21.3	30.0	8.7	Complied
Middle	21.3	30.0	8.7	Complied
Top	21.6	30.0	8.4	Complied

Channel	Conducted Peak Power (dBm)	Declared Antenna Gain (dBi)	EIRP (dBm)	EIRP Limit (dBm)	Margin (dB)	Result
Bottom	21.3	3.6	24.9	36.0	11.1	Complied
Middle	21.3	3.6	24.9	36.0	11.1	Complied
Top	21.6	3.6	25.2	36.0	10.8	Complied

Transmitter Maximum Peak Output Power (continued)

Results: Core 1 / ePA

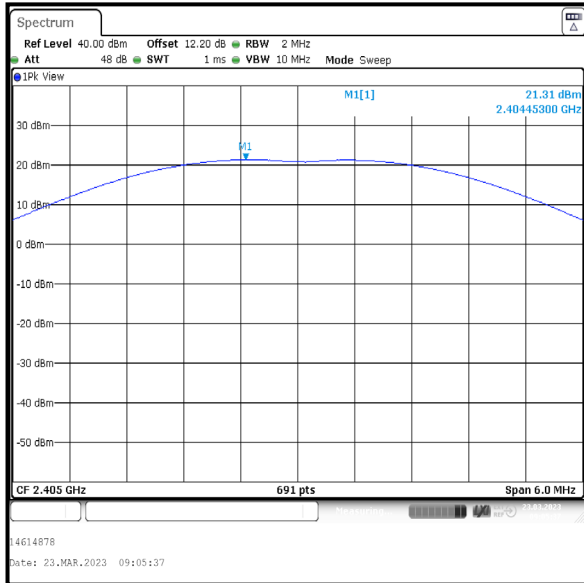

Bottom Channel

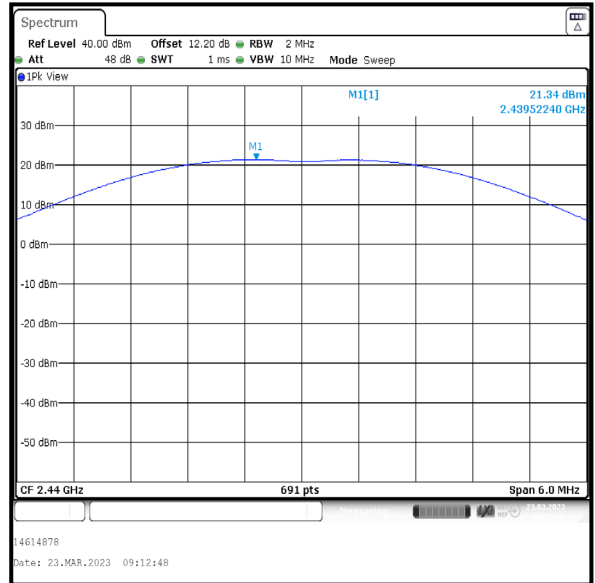

Middle Channel

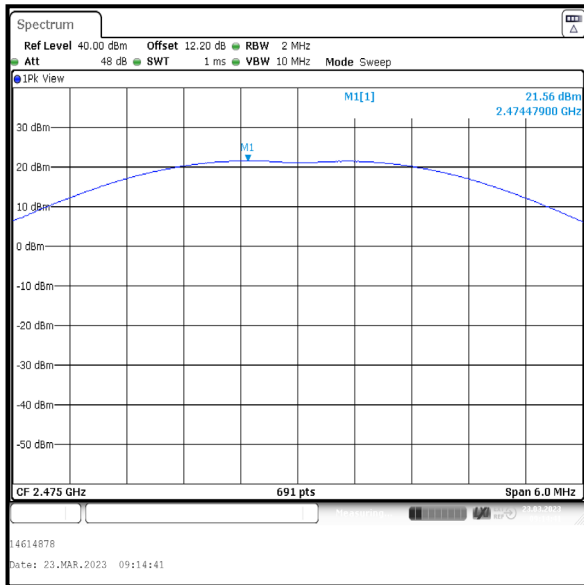

Top Channel

Transmitter Maximum Peak Output Power (continued)**Results: Core 2 / iPA**

Channel	Conducted Peak Power (dBm)	Conducted Peak Power Limit (dBm)	Margin (dB)	Result
Bottom	13.6	30.0	16.4	Complied
Middle	13.8	30.0	16.2	Complied
Top	13.6	30.0	16.4	Complied

Channel	Conducted Peak Power (dBm)	Declared Antenna Gain (dBi)	EIRP (dBm)	EIRP Limit (dBm)	Margin (dB)	Result
Bottom	13.6	0.6	14.2	36.0	21.8	Complied
Middle	13.8	0.6	14.4	36.0	21.6	Complied
Top	13.6	0.6	14.2	36.0	21.8	Complied

Transmitter Maximum Peak Output Power (continued)

Results: Core 2 / iPA

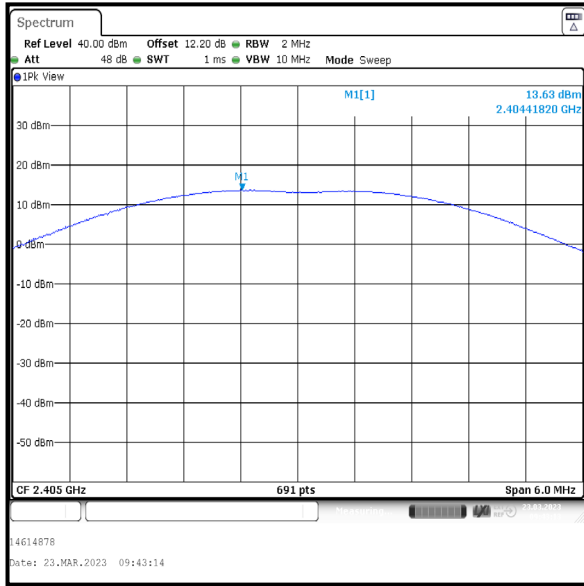

Bottom Channel

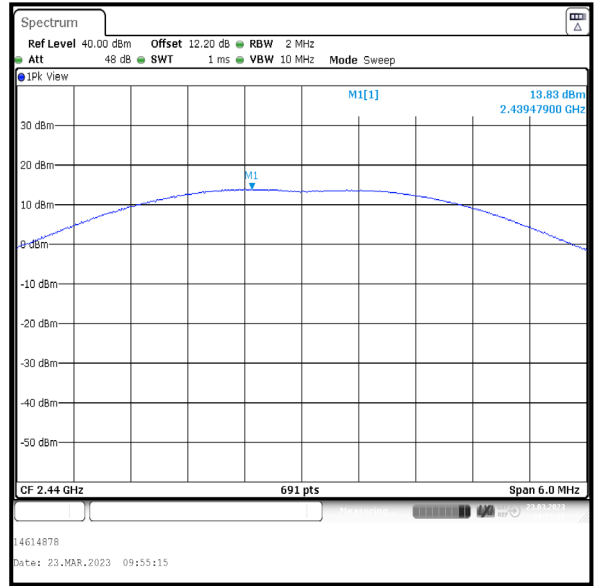

Middle Channel

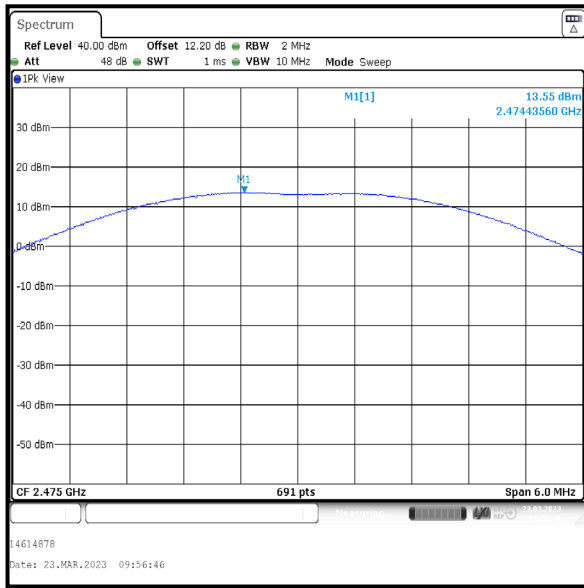

Top Channel

4.4 Transmitter Power Spectral Density

Test Summary:

Test Engineers:	Max Passell & Jiyu Zou	Test Date:	23 March 2023
Test Sample Serial Number:	RHKHHQ9YHK		

FCC Reference:	Part 15.247(e)
ISED Canada Reference:	RSS-247 5.2(b)
Test Method Used:	FCC KDB 558074 Section 8.4 referencing ANSI C63.10 Section 11.10.2

Environmental Conditions:

Temperature (°C):	24
Relative Humidity (%):	45

Note(s):

1. Transmitter Power Spectral Density tests were performed using a signal analyser in accordance with ANSI C63.10 Section 11.10.2.
2. The signal analyser resolution bandwidth was set to 3 kHz and video bandwidth 10 kHz. A Peak detector was used, sweep time was set to auto and the trace mode was Max Hold. The span was set to 1.5 times the measured DTS bandwidth. A marker was placed at the peak of the signal and the results recorded in the table below.
3. The signal analyser was connected to the RF port on the EUT using suitable attenuation and RF cable. An RF level offset was entered on the signal analyser to compensate for the loss of the attenuator and RF cable.

Transmitter Power Spectral Density (continued)

Results: Core 1 / iPA

Channel	PSD (dBm / 3 kHz)	Limit (dBm / 3 kHz)	Margin (dB)	Result
Bottom	-1.1	8.0	9.1	Complied
Middle	-1.2	8.0	9.2	Complied
Top	-1.2	8.0	9.2	Complied

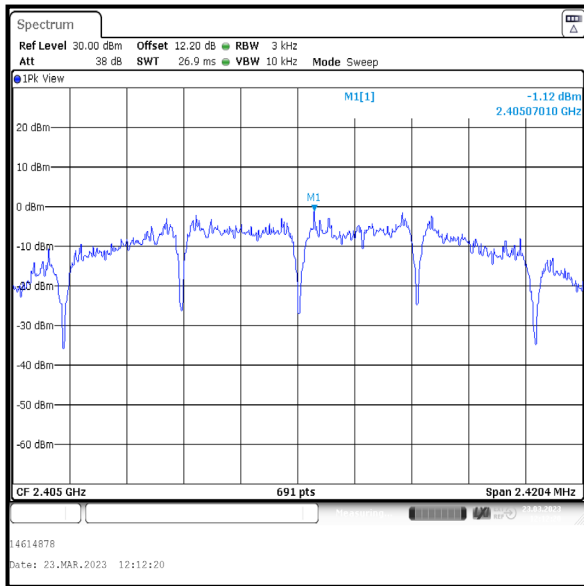

Bottom Channel

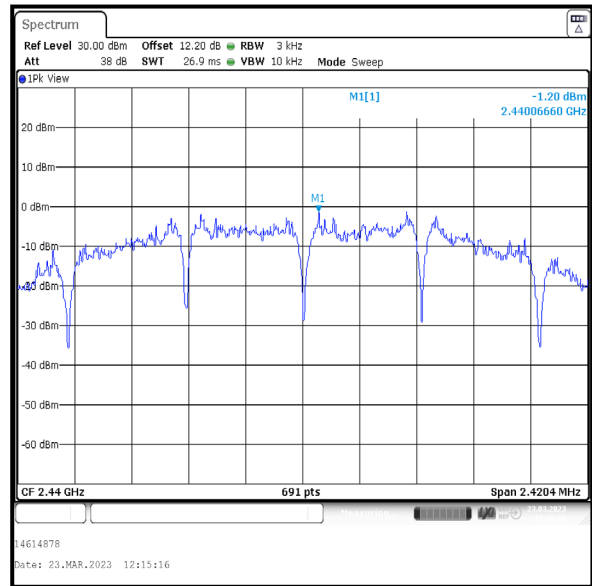

Middle Channel

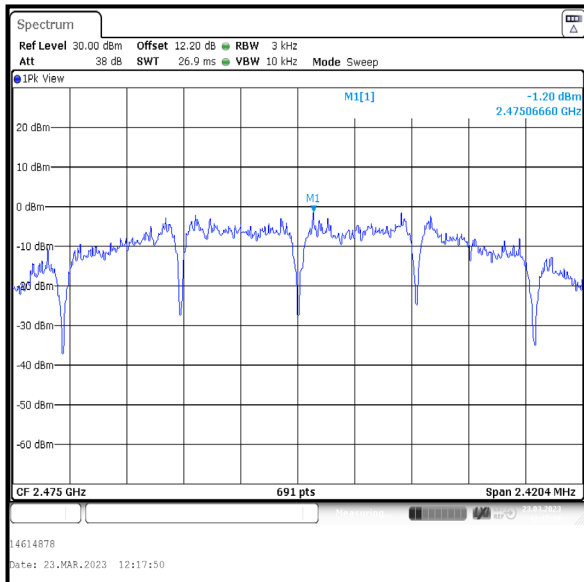

Top Channel

Transmitter Power Spectral Density (continued)

Results: Core 1 / ePA

Channel	PSD (dBm / 3 kHz)	Limit (dBm / 3 kHz)	Margin (dB)	Result
Bottom	5.9	8.0	2.1	Complied
Middle	5.9	8.0	2.1	Complied
Top	6.1	8.0	1.9	Complied

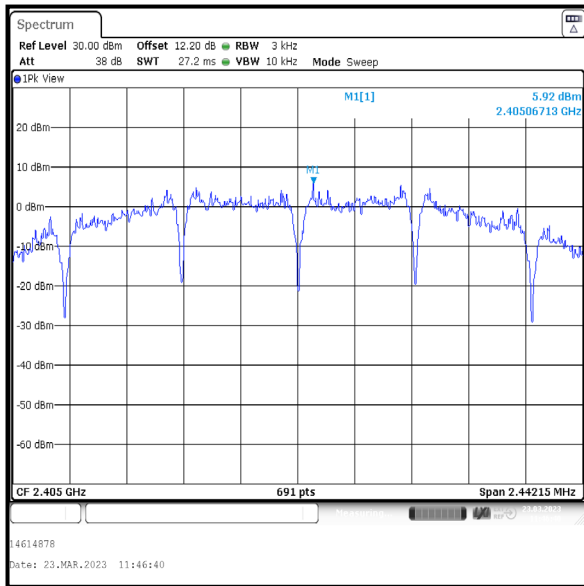

Bottom Channel

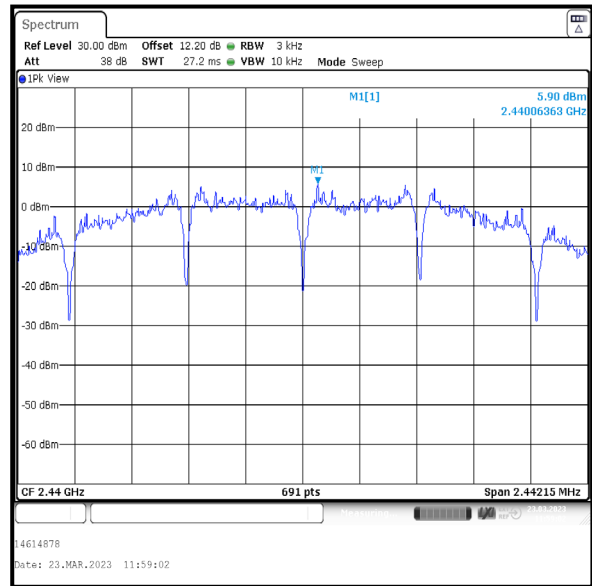

Middle Channel

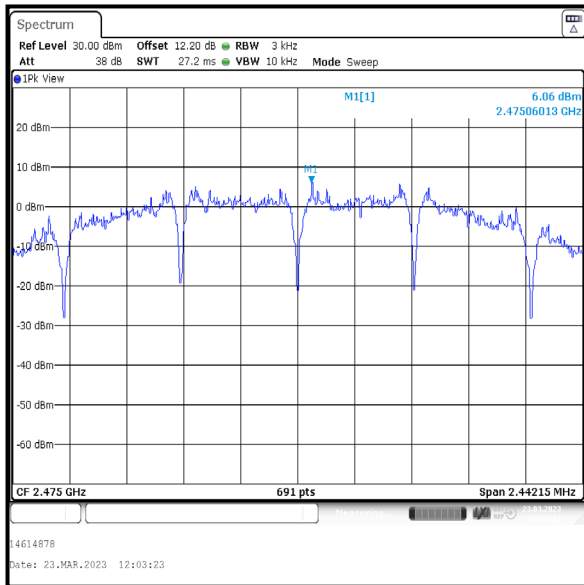

Top Channel

Transmitter Power Spectral Density (continued)

Results: Core 2 / iPA

Channel	PSD (dBm / 3 kHz)	Limit (dBm / 3 kHz)	Margin (dB)	Result
Bottom	-1.9	8.0	9.9	Complied
Middle	-1.7	8.0	9.7	Complied
Top	-2.2	8.0	10.2	Complied

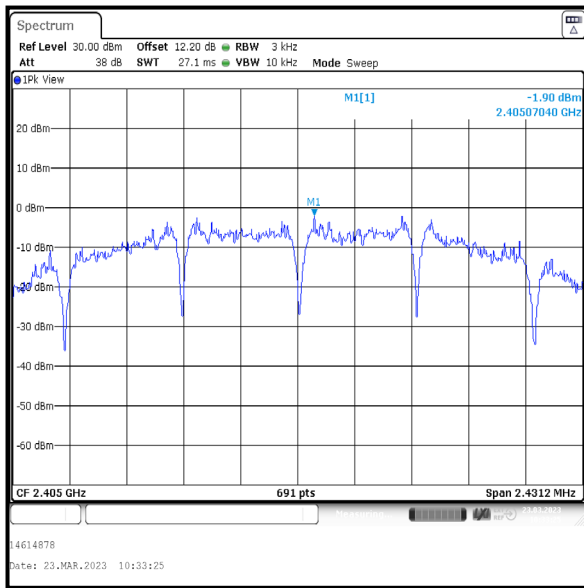

Bottom Channel

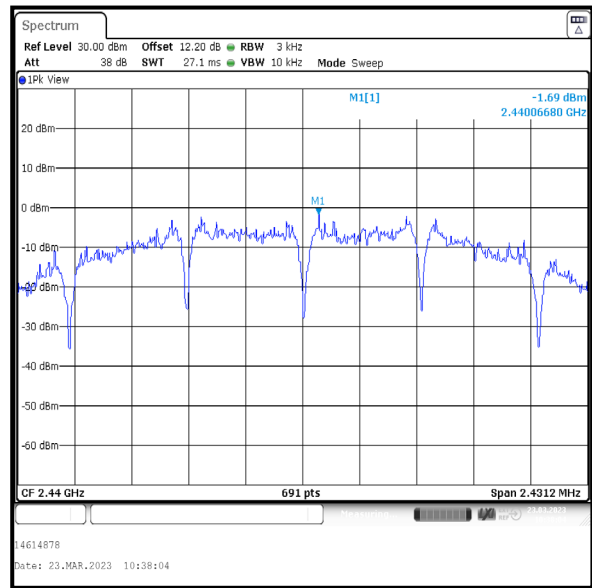

Middle Channel

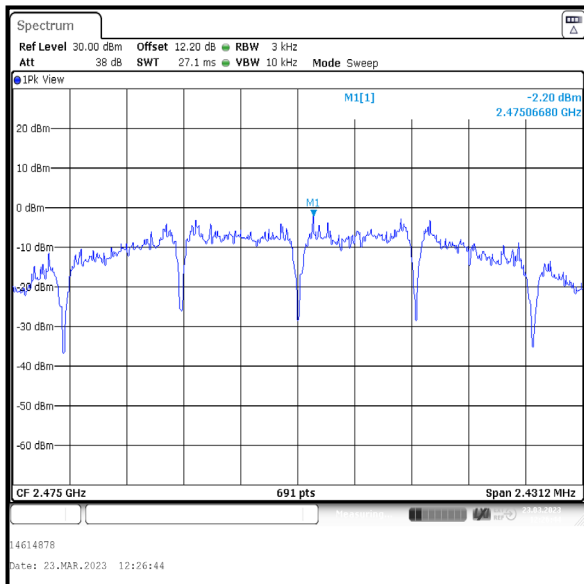

Top Channel

5 Radiated Test Results

5.1 Transmitter Radiated Emissions <1 GHz

Test Summary:

Test Engineer:	Andrew Harding	Test Dates:	15 February 2023 & 16 February 2023
Test Sample Serial Number:	NQHHW969D9		

FCC Reference:	Parts 15.247(d) & 15.209(a)
ISED Canada Reference:	RSS-Gen 6.13 & 8.9 / RSS-247 5.5
Test Method Used:	ANSI C63.10 Sections 6.3, 6.4 and 6.5
Frequency Range	9 kHz to 1000 MHz

Environmental Conditions:

Temperature (°C):	19
Relative Humidity (%):	39

Note(s):

1. The final measured value, for the given emission, in the table below incorporates the calibrated antenna factor and cable loss.
2. All emissions shown on the pre-scans were investigated and found to be ambient, or > 20 dB below the appropriate limit or below the noise floor of the measurement system. Therefore, the highest peak noise floor reading of the measuring receiver was recorded in the table below.
3. The preliminary scans showed similar emission levels below 1 GHz, for each channel of operation. Therefore, final radiated emissions measurements were performed with the EUT set to the middle channel only.
4. Measurements from 9 kHz to 30 MHz were performed in a semi-anechoic chamber (Asset Number K0001) at a distance of 3 metres. The EUT was placed at a height of 80 cm above the reference ground plane in the centre of the chamber turntable.
5. Measurements from 30 MHz to 1 GHz were performed in a semi-anechoic chamber (Asset Number K0001) at a distance of 3 metres. The EUT was placed at a height of 80 cm above the reference ground plane in the centre of the chamber turntable. Maximum emission levels were determined by height searching the measurement antenna over the range 1 metre to 4 metres.
6. Pre-scans were performed, and markers placed on the highest measured levels. The test receiver was configured as follows: For 9 kHz to 150 kHz, the resolution bandwidth was set to 300 Hz and video bandwidth 1 kHz. A peak detector was used, and trace mode was Max Hold. For 150 kHz to 30 MHz, the resolution bandwidth was set to 10 kHz and video bandwidth 30 kHz, trace mode was Max Hold. For 30 MHz to 1 GHz, the resolution bandwidth was set to 120 kHz and video bandwidth 500 kHz. A peak detector was used, sweep time was set to auto and trace mode was Max Hold.

Transmitter Radiated Emissions (continued)

Results: Peak / Middle Channel / Core 1

Frequency (MHz)	Antenna Polarity	Level (dB μ V/m)	Limit (dB μ V/m)	Margin (dB)	Result
950.682	Horizontal	38.0	46.0	8.0	Complied

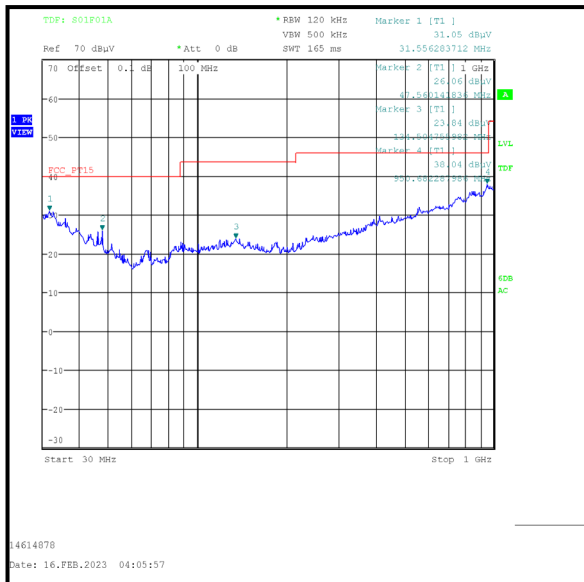
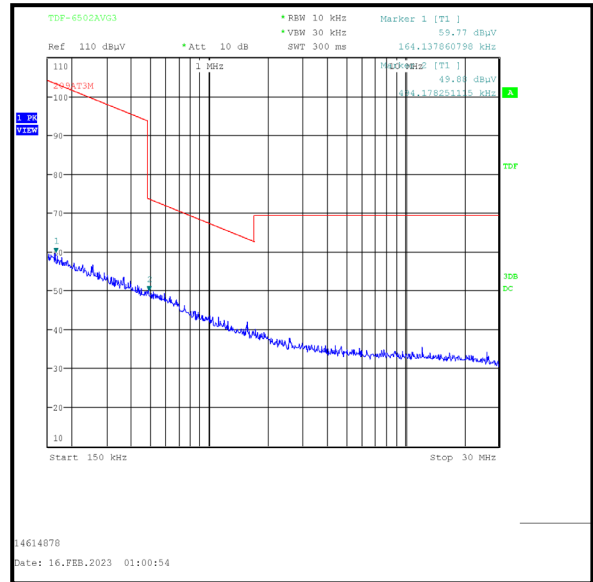
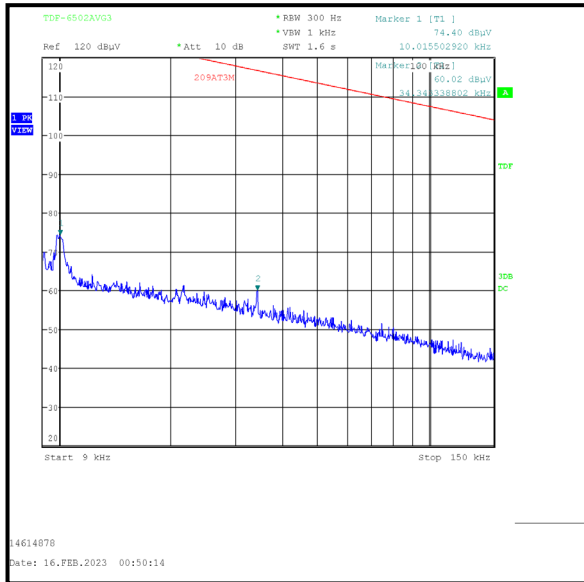

5.2 Transmitter Radiated Emissions >1 GHz

Test Summary:

Test Engineers:	John Ferdinand & Vi Van	Test Date:	17 February 2023
Test Sample Serial Number:	NQHHW969D9		

FCC Reference:	Parts 15.247(d) & 15.209(a)
ISED Canada Reference:	RSS-Gen 6.13 & 8.9 / RSS-247 5.5
Test Method Used:	FCC KDB 558074 Sections 8.1 c)3), 8.5 & 8.6 referencing ANSI C63.10 Sections 6.3, 6.6, 11.11 & 11.12
Frequency Range	1 GHz to 25 GHz

Environmental Conditions:

Temperature (°C):	22
Relative Humidity (%):	39

Note(s):

1. The final measured value, for the given emission, in the table below incorporates the calibrated antenna factor and cable loss.
2. No spurious emissions were detected above the noise floor of the measuring receiver therefore the highest peak and average noise floor readings of the measuring receiver were recorded as shown in the tables below.
3. The emission shown on the 1 GHz to 3 GHz plot is the EUT fundamental.
4. Pre-scans above 1 GHz were performed in a semi-anechoic chamber (Asset Number K0017) at a distance of 3 metres. The EUT was placed at a height of 1.5 m above the reference ground plane in the centre of the chamber turntable. Maximum emission levels were determined by height searching the measurement antenna over the range 1 metre to 4 metres.
5. Pre-scans were performed, and a marker placed on the highest measured level of the appropriate plot. The test receiver resolution bandwidth was set to 1 MHz and video bandwidth 3 MHz. The sweep time was set to auto. Peak and average measurements were performed with their own appropriate detectors during the pre-scan measurements.

Results: Peak / Middle Channel / Core 1

Frequency (MHz)	Antenna Polarity	Level (dB μ V/m)	Limit (dB μ V/m)	Margin (dB)	Result
2974.000	Horizontal	54.1	74.0	19.9	Complied

Results: Average / Middle Channel / Core 1

Frequency (MHz)	Antenna Polarity	Level (dB μ V/m)	Limit (dB μ V/m)	Margin (dB)	Result
2886.000	Horizontal	47.5	54.0	6.5	Complied

Transmitter Radiated Emissions (continued)

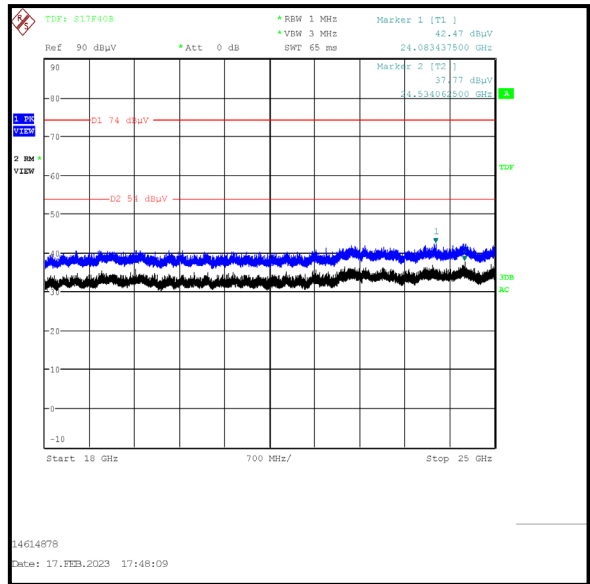
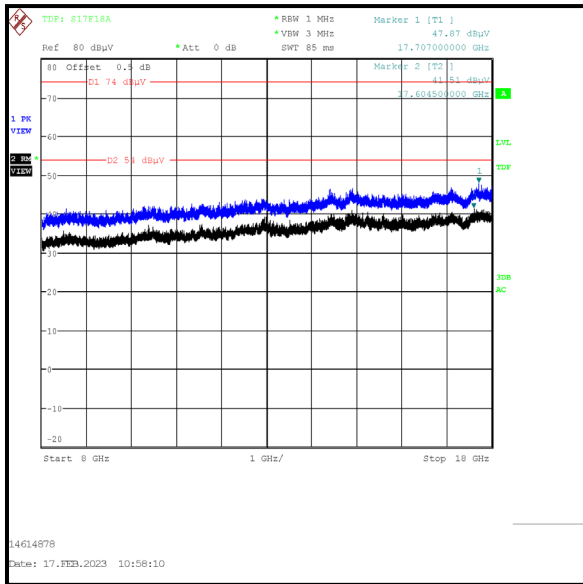
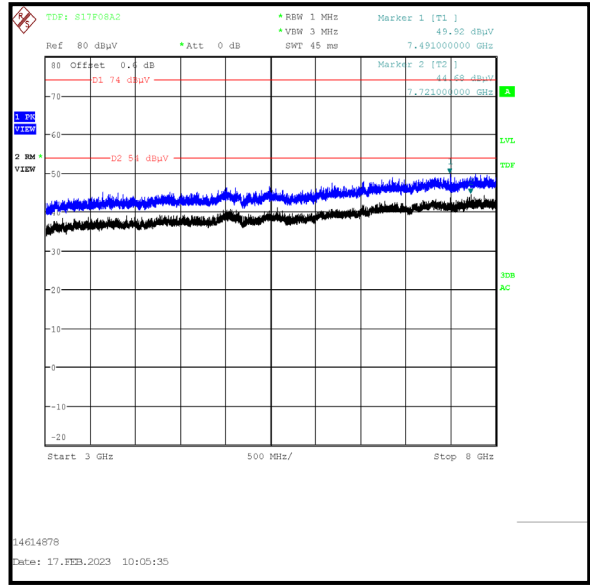
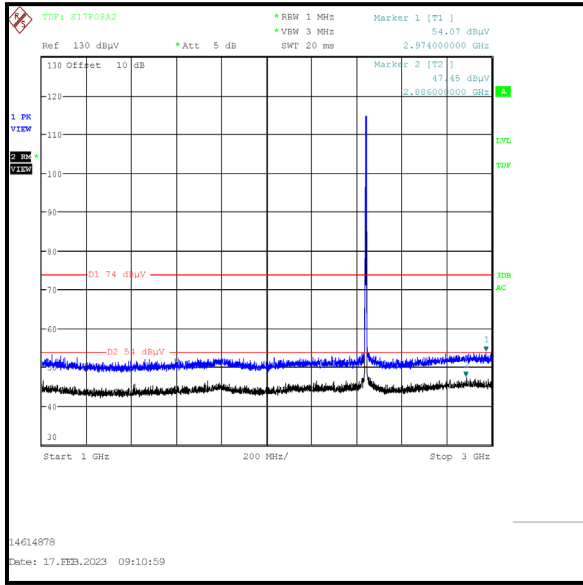

5.3 Transmitter Band Edge Radiated Emissions

Test Summary:

Test Engineer:	John Ferdinand	Test Date:	19 January 2023
Test Sample Serial Number:	NQHHW969D9		

FCC Reference:	Parts 15.247(d) & 15.209(a)
ISED Canada Reference:	RSS-Gen 6.13 / RSS-247 5.5
Test Method Used:	KDB 558074 Section 8.7 referencing ANSI C63.10 Sections 11.11, 11.12 & 11.13

Environmental Conditions:

Temperature (°C):	22
Relative Humidity (%):	40

Note(s):

1. The final measured value, for the given emission, in the table below incorporates the calibrated antenna factor and cable loss.
2. As the lower band edge is adjacent to a non-restricted band, only peak measurements are required. In accordance with ANSI C63.10 Section 11.11.1, the test method in Section 11.11.3 was followed: the test receiver resolution bandwidth was set to 100 kHz and video bandwidth 300 kHz. A peak detector was used, sweep time was set to auto and trace mode was Max Hold. The test receiver was left to sweep for a sufficient length of time in order to maximise the carrier level and out-of-band emissions. A marker and corresponding reference level line were placed on the peak of the carrier. As the maximum peak conducted output power was measured using an peak detector in accordance with ANSI C63.10 Section 11.9.1.1 an out-of-band limit line was placed 20 dB (ANSI C63.10 Section 11.11.1(a)) below the peak level. A marker was placed on the band edge spot frequencies. Marker frequency and levels were recorded.
3. As the upper band edge is adjacent to a restricted band, both peak and average measurements were recorded by placing a marker at the edge of the band. For peak measurements the test receiver resolution bandwidth was set to 1 MHz and the video bandwidth 3 MHz. A peak detector was used, sweep time was set to auto and trace mode was Max Hold. For average measurements the test receiver resolution bandwidth was set to 1 MHz and the video bandwidth 3 MHz. An RMS detector was used, sweep time was set to auto and trace mode was trace averaging over 300 sweeps. A marker was placed on the band edge spot frequencies and a second marker placed on the highest emission level in the adjacent restricted band of operation (where a higher level emission was present). Marker frequencies and levels were recorded.
4. There is a restricted band 10 MHz below the lower band edge. The test receiver was set up as follows: the RBW set to 1 MHz, the VBW set to 3 MHz, with the sweep time set to auto couple. Peak and average measurements were performed with peak and RMS detectors respectively. Markers were placed on the highest point on each trace.
5. * -20 dBc limit.

Transmitter Band Edge Radiated Emissions (continued)**Results: Core 0 / iPA**

Frequency (MHz)	Antenna Polarity	Peak Level (dB μ V/m)	Limit (dB μ V/m)	Margin (dB)	Result
2396.731	Horizontal	43.2	84.8*	41.6	Complied
2400.0	Horizontal	42.4	84.8*	42.4	Complied
2483.5	Horizontal	49.2	74.0	24.8	Complied
2491.994	Horizontal	51.7	74.0	22.3	Complied

Frequency (MHz)	Antenna Polarity	Average Level (dB μ V/m)	Limit (dB μ V/m)	Margin (dB)	Result
2483.5	Horizontal	40.3	54.0	13.7	Complied
2483.901	Horizontal	40.4	54.0	13.6	Complied

Results: 2310 MHz to 2390 MHz Restricted Band / Peak

Frequency (MHz)	Antenna Polarity	Level (dB μ V/m)	Limit (dB μ V/m)	Margin (dB)	Result
2396.410	Horizontal	53.6	74.0	20.4	Complied

Results: 2310 MHz to 2390 MHz Restricted Band / Average

Frequency (MHz)	Antenna Polarity	Level (dB μ V/m)	Limit (dB μ V/m)	Margin (dB)	Result
2386.282	Horizontal	41.5	54.0	12.5	Complied

Transmitter Band Edge Radiated Emissions (continued)

Results: Core 0 / iPA

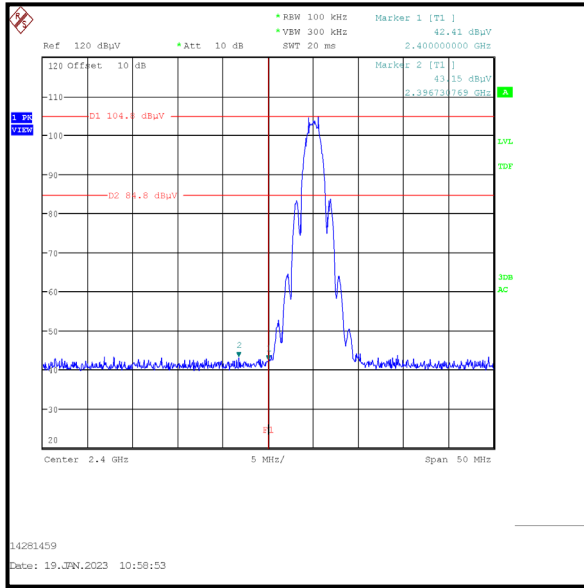

Lower Band Edge

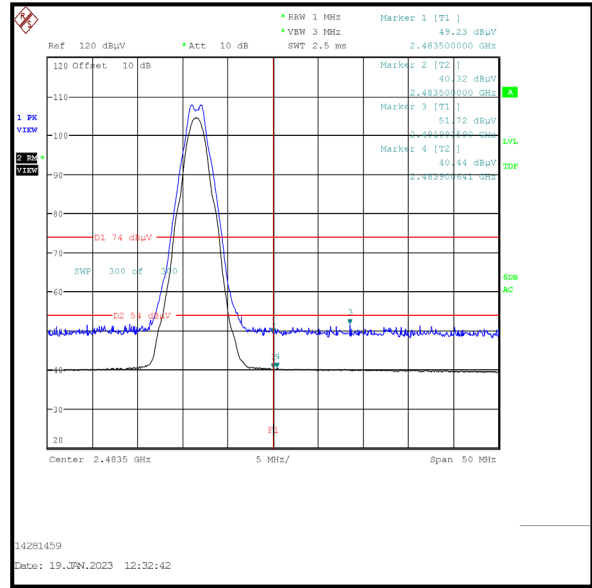

Upper Band Edge

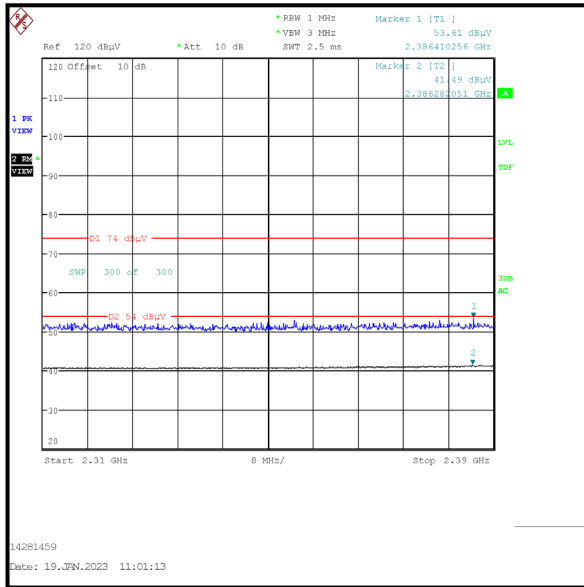

2310 MHz to 2390 MHz Restricted Band

Transmitter Band Edge Radiated Emissions (continued)**Results: Core 0 / ePA**

Frequency (MHz)	Antenna Polarity	Peak Level (dB μ V/m)	Limit (dB μ V/m)	Margin (dB)	Result
2396.350	Horizontal	46.8	89.2*	42.4	Complied
2400.0	Horizontal	46.4	89.2*	42.8	Complied
2483.5	Horizontal	53.4	74.0	20.6	Complied
2485.904	Horizontal	55.4	74.0	18.6	Complied

Frequency (MHz)	Antenna Polarity	Average Level (dB μ V/m)	Limit (dB μ V/m)	Margin (dB)	Result
2483.5	Horizontal	43.0	54.0	11.0	Complied
2483.660	Horizontal	43.1	54.0	10.9	Complied

Results: 2310 MHz to 2390 MHz Restricted Band / Peak

Frequency (MHz)	Antenna Polarity	Level (dB μ V/m)	Limit (dB μ V/m)	Margin (dB)	Result
2389.872	Horizontal	53.8	74.0	20.2	Complied

Results: 2310 MHz to 2390 MHz Restricted Band / Average

Frequency (MHz)	Antenna Polarity	Level (dB μ V/m)	Limit (dB μ V/m)	Margin (dB)	Result
2389.615	Horizontal	42.1	54.0	11.9	Complied

Transmitter Band Edge Radiated Emissions (continued)

Results: Core 0 / ePA

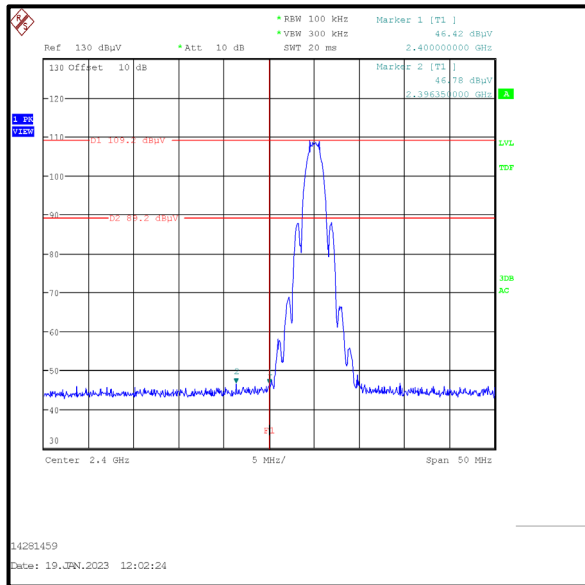

Lower Band Edge

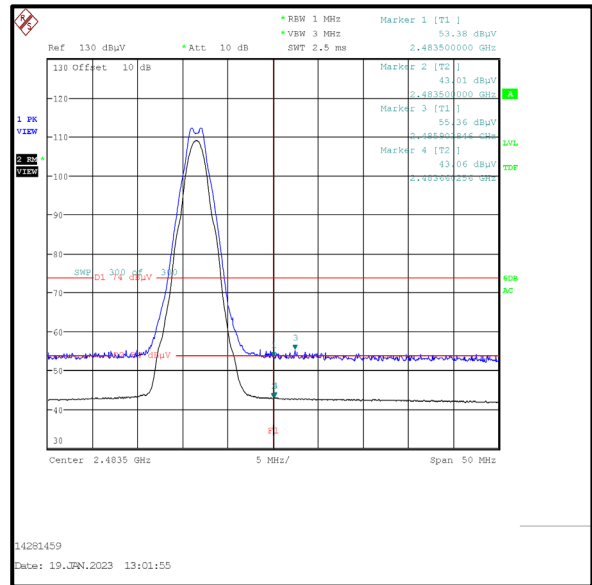

Upper Band Edge

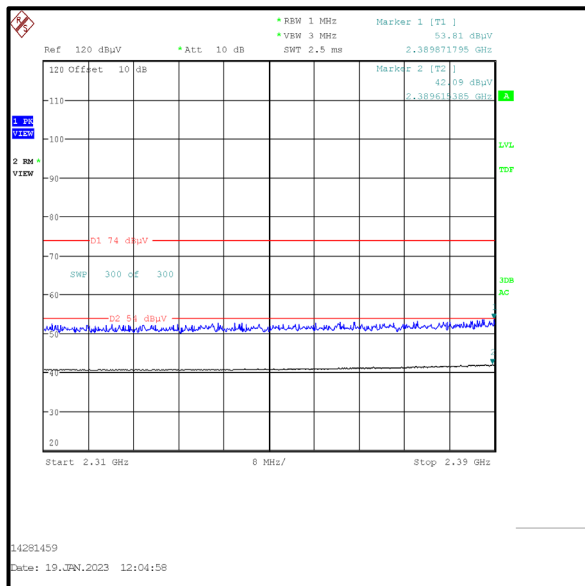

2310 MHz to 2390 MHz Restricted Band

Transmitter Band Edge Radiated Emissions (continued)**Results: Core 1 / iPA**

Frequency (MHz)	Antenna Polarity	Peak Level (dB μ V/m)	Limit (dB μ V/m)	Margin (dB)	Result
2391.900	Horizontal	44.2	85.0*	40.8	Complied
2400.0	Horizontal	43.4	85.0*	41.6	Complied
2483.5	Horizontal	51.3	74.0	22.7	Complied
2489.750	Horizontal	52.4	74.0	21.6	Complied

Frequency (MHz)	Antenna Polarity	Average Level (dB μ V/m)	Limit (dB μ V/m)	Margin (dB)	Result
2483.5	Horizontal	40.4	54.0	13.6	Complied

Results: 2310 MHz to 2390 MHz Restricted Band / Peak

Frequency (MHz)	Antenna Polarity	Level (dB μ V/m)	Limit (dB μ V/m)	Margin (dB)	Result
2354.231	Horizontal	54.1	74.0	19.9	Complied

Results: 2310 MHz to 2390 MHz Restricted Band / Average

Frequency (MHz)	Antenna Polarity	Level (dB μ V/m)	Limit (dB μ V/m)	Margin (dB)	Result
2389.872	Horizontal	41.5	54.0	12.5	Complied

Transmitter Band Edge Radiated Emissions (continued)

Results: Core 1 / iPA

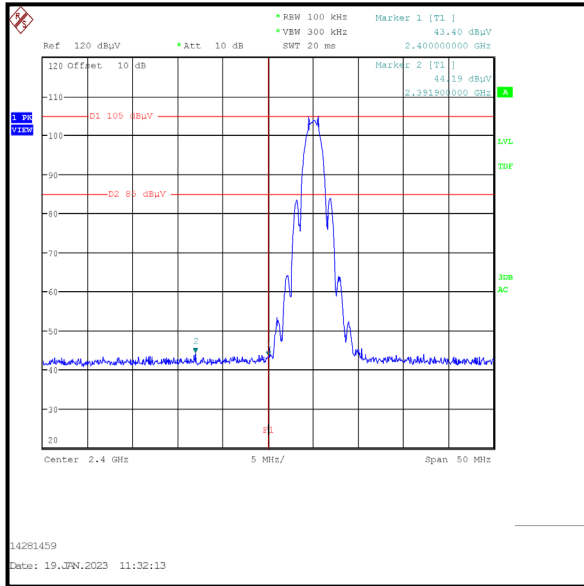

Lower Band Edge

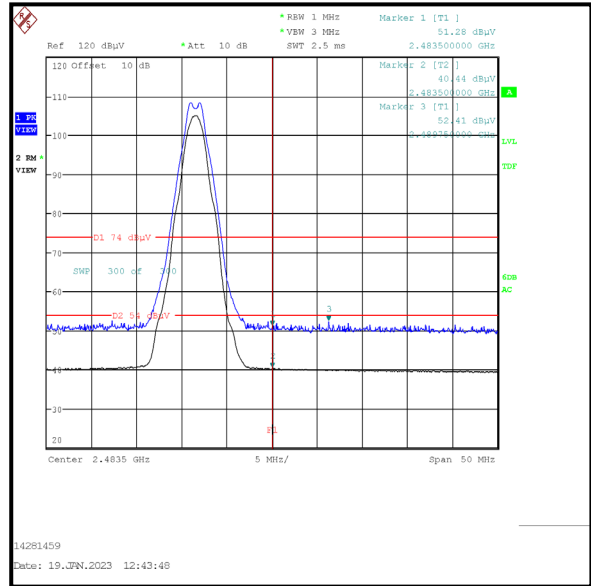

Upper Band Edge

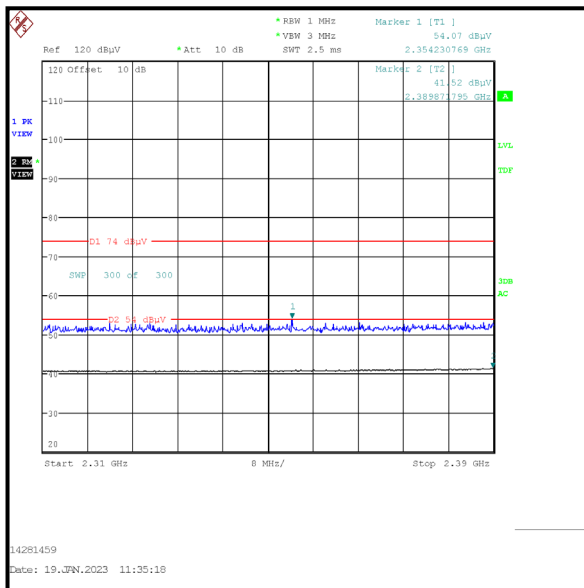

2310 MHz to 2390 MHz Restricted Band

Transmitter Band Edge Radiated Emissions (continued)**Results: Core 1 / ePA**

Frequency (MHz)	Antenna Polarity	Peak Level (dB μ V/m)	Limit (dB μ V/m)	Margin (dB)	Result
2399.900	Horizontal	46.9	90.4*	43.5	Complied
2400.0	Horizontal	46.5	90.4*	43.9	Complied
2483.5	Horizontal	52.2	74.0	21.8	Complied
2484.061	Horizontal	54.1	74.0	19.9	Complied

Frequency (MHz)	Antenna Polarity	Average Level (dB μ V/m)	Limit (dB μ V/m)	Margin (dB)	Result
2483.5	Horizontal	43.0	54.0	11.0	Complied
2484.702	Horizontal	43.3	54.0	10.7	Complied

Results: 2310 MHz to 2390 MHz Restricted Band / Peak

Frequency (MHz)	Antenna Polarity	Level (dB μ V/m)	Limit (dB μ V/m)	Margin (dB)	Result
2375.769	Horizontal	53.6	74.0	20.4	Complied

Results: 2310 MHz to 2390 MHz Restricted Band / Average

Frequency (MHz)	Antenna Polarity	Level (dB μ V/m)	Limit (dB μ V/m)	Margin (dB)	Result
2390.000	Horizontal	42.2	54.0	11.8	Complied

Transmitter Band Edge Radiated Emissions (continued)

Results: Core 1 / ePA

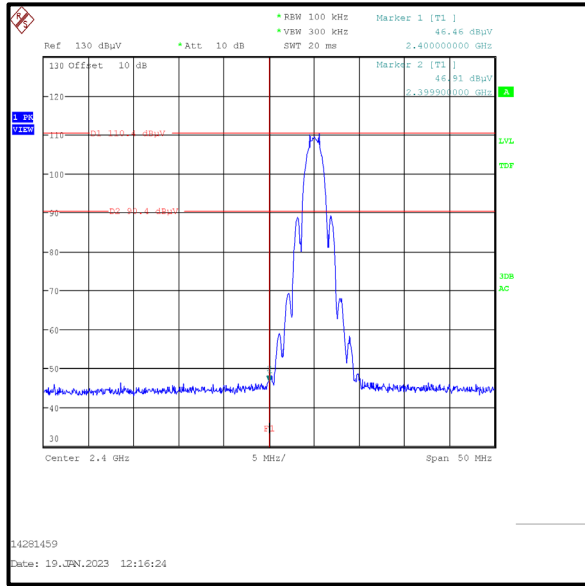

Lower Band Edge

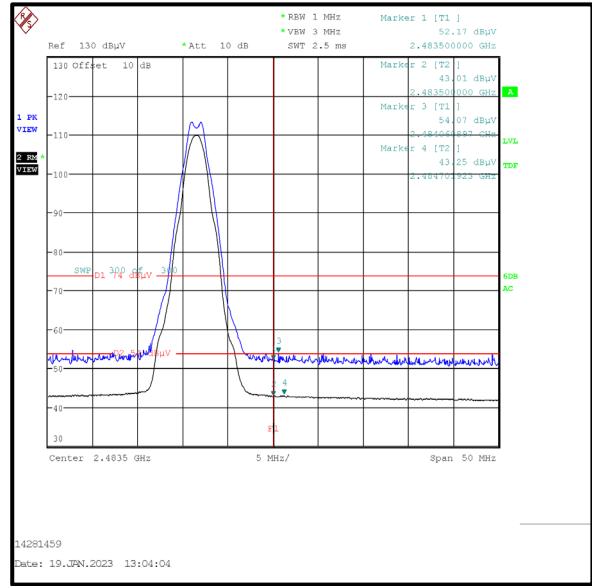

Upper Band Edge

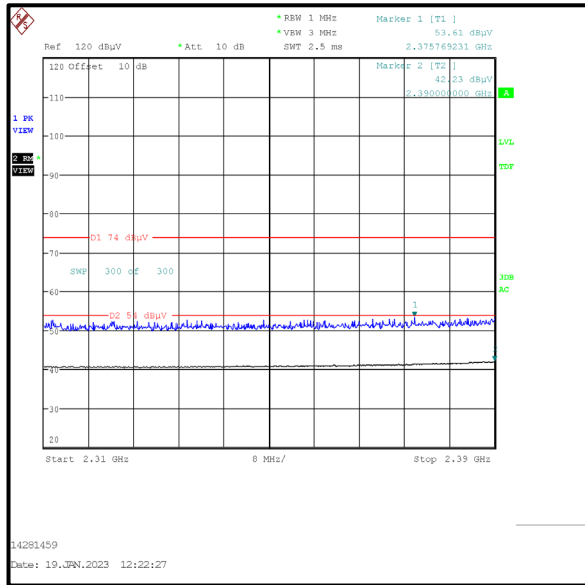

2310 MHz to 2390 MHz Restricted Band

Transmitter Band Edge Radiated Emissions (continued)**Results: Core 2 / iPA**

Frequency (MHz)	Antenna Polarity	Peak Level (dB μ V/m)	Limit (dB μ V/m)	Margin (dB)	Result
2399.950	Horizontal	46.2	84.5*	38.3	Complied
2400.0	Horizontal	45.7	84.5*	38.8	Complied
2483.5	Horizontal	50.3	74.0	23.7	Complied
2495.833	Horizontal	51.9	74.0	22.1	Complied

Frequency (MHz)	Antenna Polarity	Average Level (dB μ V/m)	Limit (dB μ V/m)	Margin (dB)	Result
2483.5	Horizontal	39.6	54.0	14.4	Complied
2497.442	Horizontal	39.8	54.0	14.2	Complied

Results: 2310 MHz to 2390 MHz Restricted Band / Peak

Frequency (MHz)	Antenna Polarity	Level (dB μ V/m)	Limit (dB μ V/m)	Margin (dB)	Result
2340.769	Horizontal	52.8	74.0	21.2	Complied

Results: 2310 MHz to 2390 MHz Restricted Band / Average

Frequency (MHz)	Antenna Polarity	Level (dB μ V/m)	Limit (dB μ V/m)	Margin (dB)	Result
2383.974	Horizontal	41.4	54.0	12.6	Complied

Transmitter Band Edge Radiated Emissions (continued)

Results: Core 2 / iPA

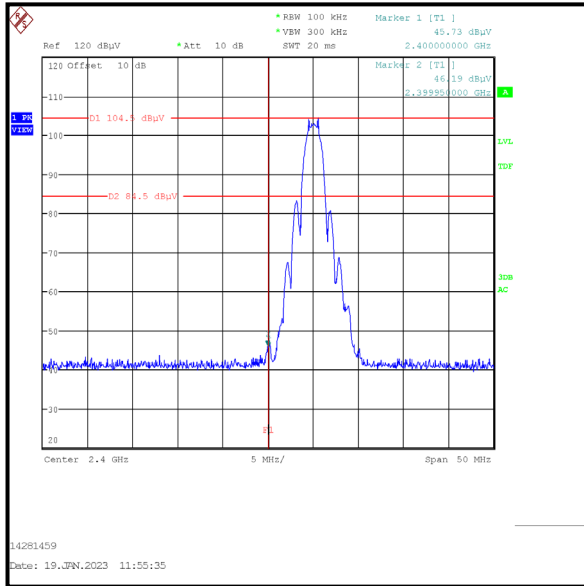

Lower Band Edge

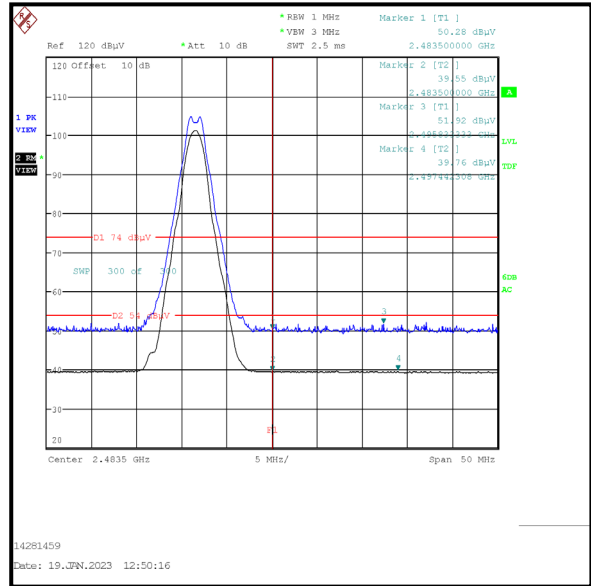

Upper Band Edge

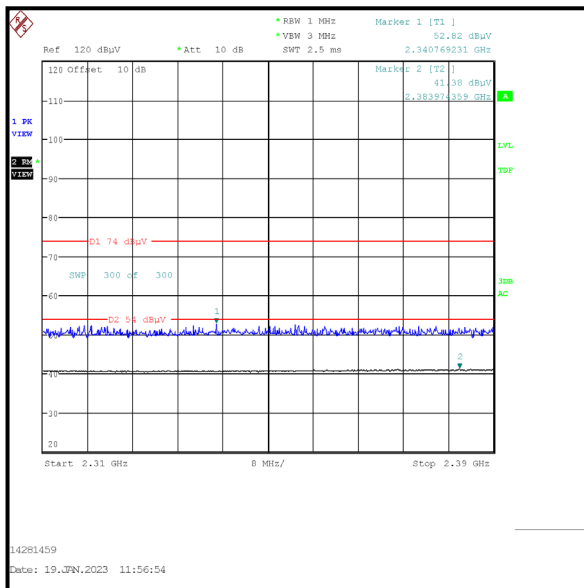

2310 MHz to 2390 MHz Restricted Band

--- END OF REPORT ---