



Frequency (MHz)	Level (dBuV/m)	Limit (dBuV/m)	Margin (dB)	Detector	Angle (°)	Height (cm)	Polarisation
*							

Table 765 - U-NII-2A - 5320 MHz (CH64), HE20, RU52-37, CDD, Core 0 + Core 1, 1 GHz to 40 GHz

*No emissions found within 10 dB of the limit.

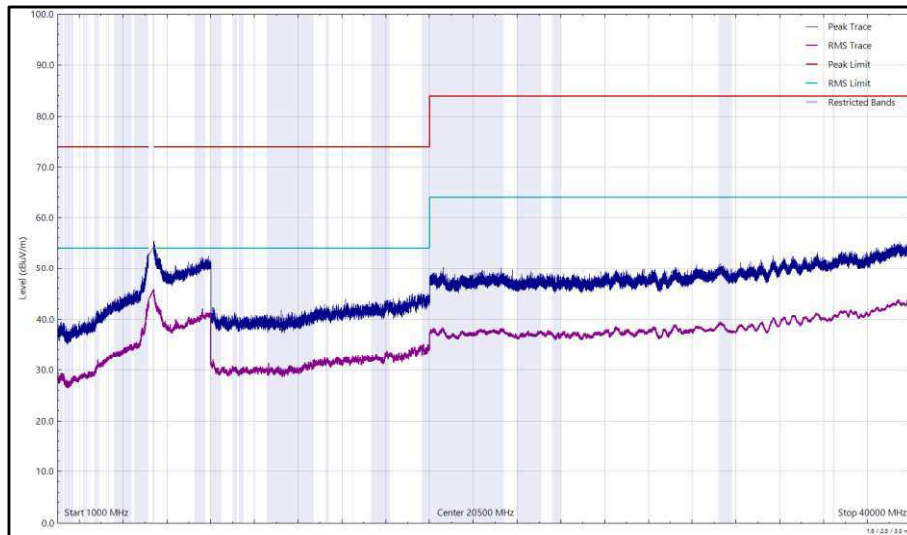

Figure 500 - U-NII-2A - 5320 MHz (CH64), HE20, RU52-37, CDD, Core 0 + Core 1, 1 GHz to 40 GHz, Horizontal

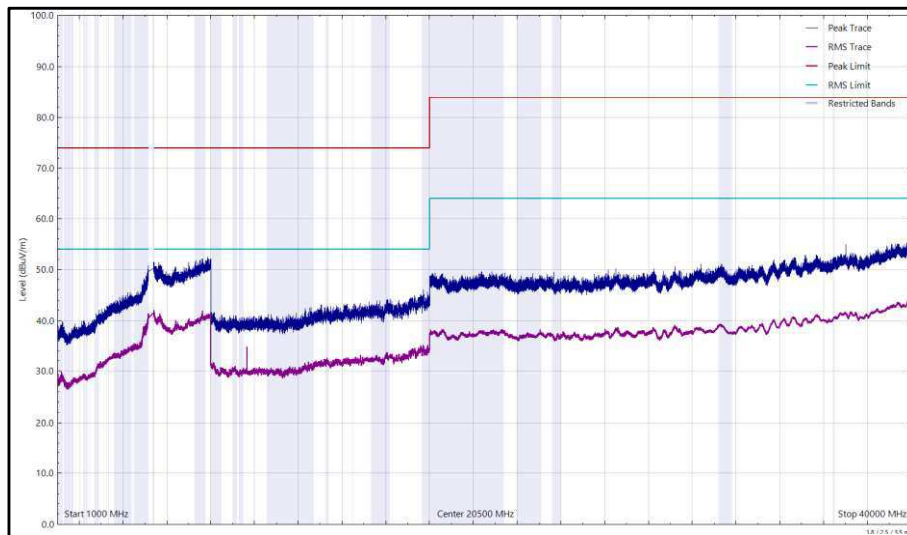

Figure 501 - U-NII-2A - 5320 MHz (CH64), HE20, RU52-37, CDD, Core 0 + Core 1, 1 GHz to 40 GHz, Vertical



Frequency (MHz)	Level (dBuV/m)	Limit (dBuV/m)	Margin (dB)	Detector	Angle (°)	Height (cm)	Polarisation
*							

Table 766 - U-NII-2C - 5500 MHz (CH100), HE20, RU52-37, CDD, Core 0 + Core 1, 1 GHz to 40 GHz

*No emissions found within 10 dB of the limit.

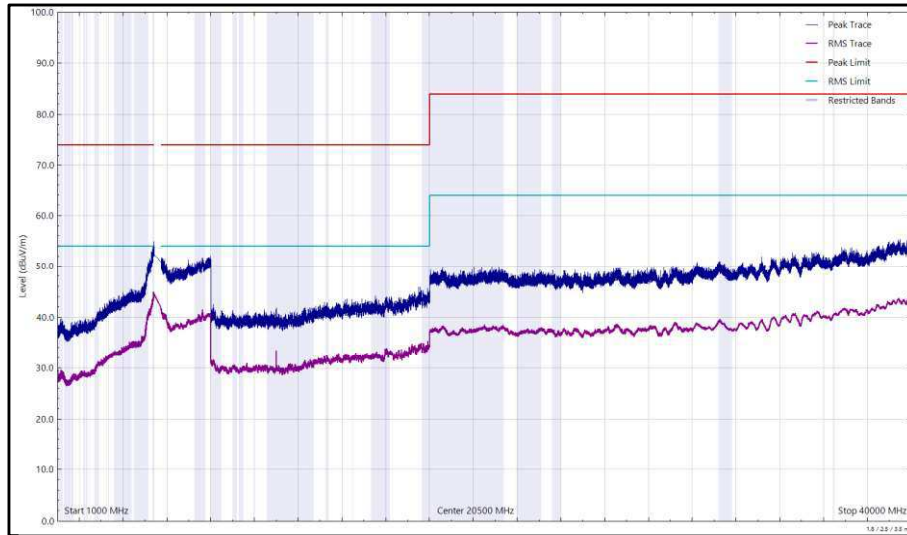

Figure 502 - U-NII-2C - 5500 MHz (CH100), HE20, RU52-37, CDD, Core 0 + Core 1, 1 GHz to 40 GHz, Horizontal

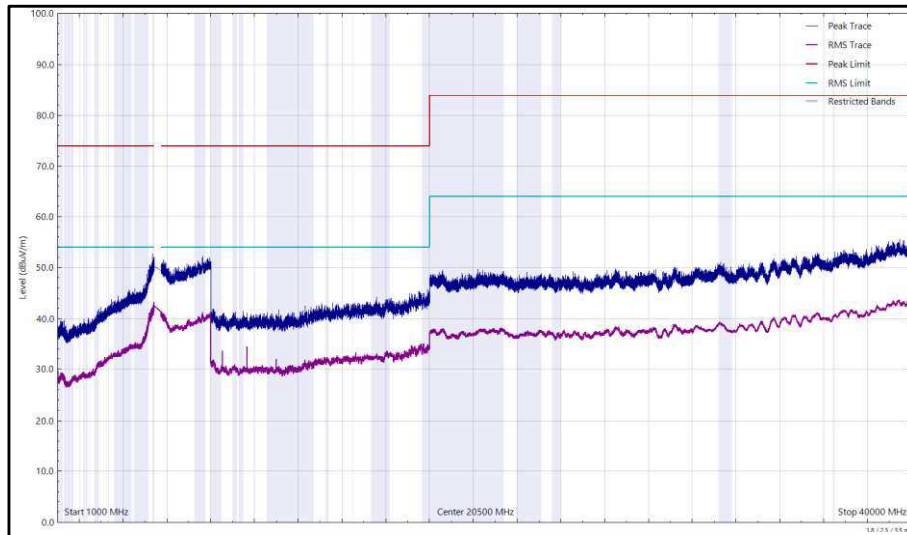

Figure 503 - U-NII-2C - 5500 MHz (CH100), HE20, RU52-37, CDD, Core 0 + Core 1, 1 GHz to 40 GHz, Vertical



Frequency (MHz)	Level (dBuV/m)	Limit (dBuV/m)	Margin (dB)	Detector	Angle (°)	Height (cm)	Polarisation
*							

Table 767 - U-NII-2C - 5700 MHz (CH140), HE20, RU52-37, CDD, Core 0 + Core 1, 1 GHz to 40 GHz

*No emissions found within 10 dB of the limit.

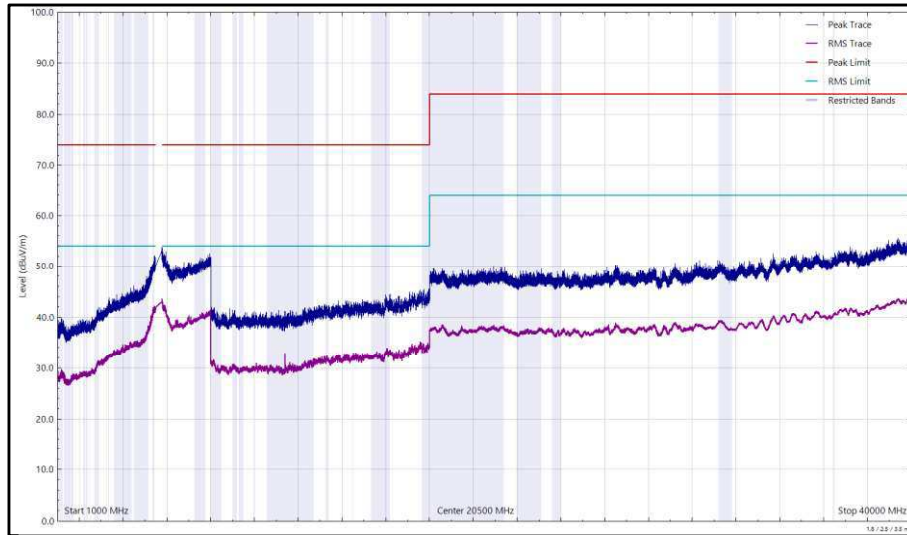

Figure 504 - U-NII-2C - 5700 MHz (CH140), HE20, RU52-37, CDD, Core 0 + Core 1, 1 GHz to 40 GHz, Horizontal

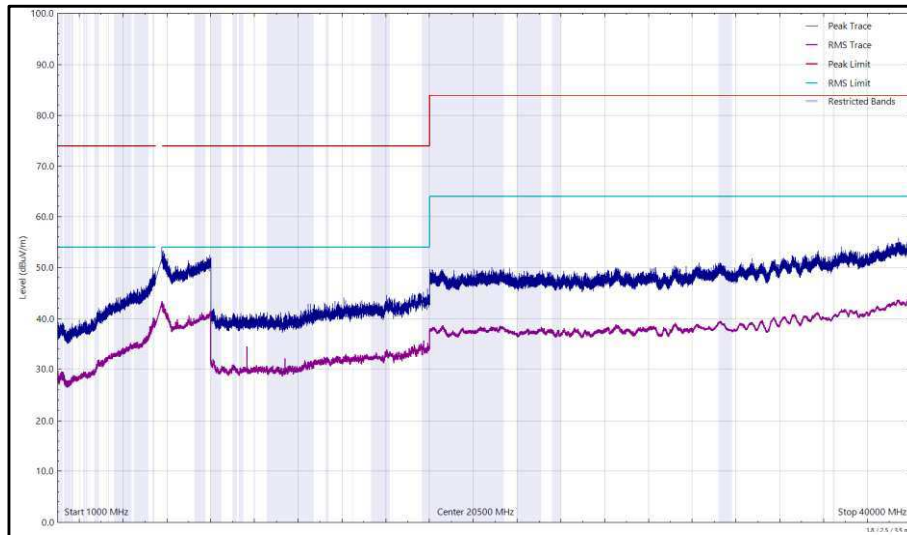

Figure 505 - U-NII-2C - 5700 MHz (CH140), HE20, RU52-37, CDD, Core 0 + Core 1, 1 GHz to 40 GHz, Vertical



Frequency (MHz)	Level (dBuV/m)	Limit (dBuV/m)	Margin (dB)	Detector	Angle (°)	Height (cm)	Polarisation
*							

Table 768 - U-NII-3 - 5745 MHz (CH149), HE20, RU26-0, CDD, Core 0 + Core 1, 1 GHz to 40 GHz

*No emissions found within 10 dB of the limit.

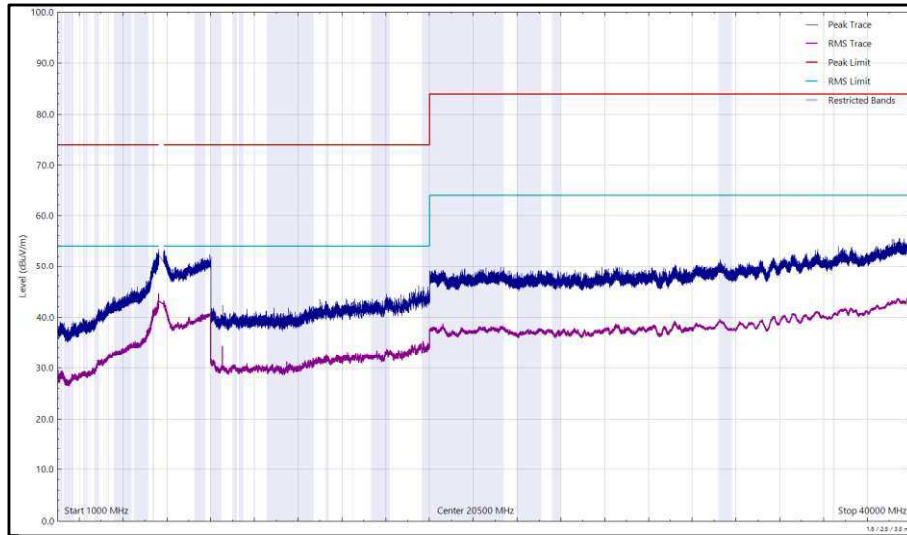

Figure 506 - U-NII-3 - 5745 MHz (CH149), HE20, RU26-0, CDD, Core 0 + Core 1, 1 GHz to 40 GHz, Horizontal

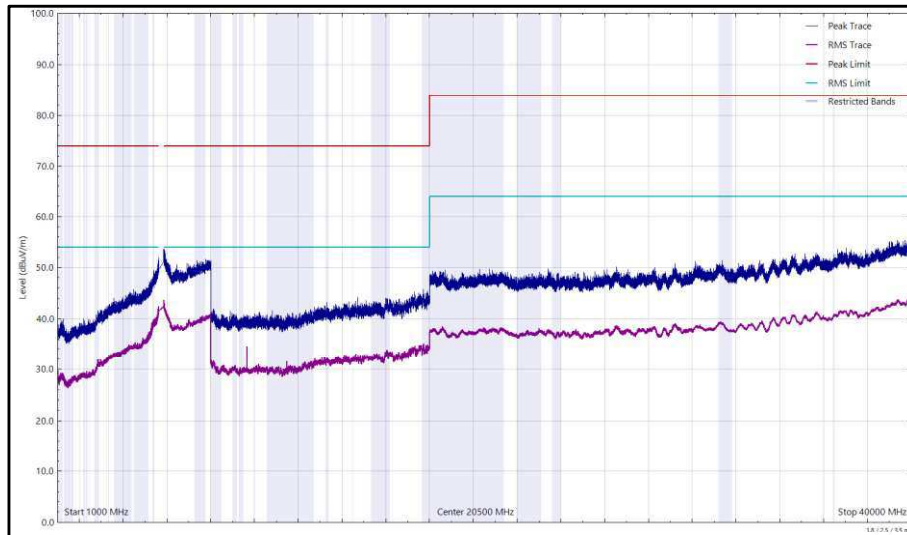

Figure 507 - U-NII-3 - 5745 MHz (CH149), HE20, RU26-0, CDD, Core 0 + Core 1, 1 GHz to 40 GHz, Vertical



Frequency (MHz)	Level (dBuV/m)	Limit (dBuV/m)	Margin (dB)	Detector	Angle (°)	Height (cm)	Polarisation
56.496	22.78	40.00	-17.22	Q-Peak	350	363	Vertical
56.509	22.06	40.00	-17.94	Q-Peak	85	100	Horizontal
11632.651	35.40	54.00	-18.60	RMS	21	163	Vertical
11632.704	36.50	54.00	-17.50	RMS	65	214	Horizontal

Table 769 - U-NII-3 - 5825 MHz (CH165), HE20, RU26-0, CDD, Core 0 + Core 1, 1 GHz to 40 GHz

No other emissions found within 10 dB of the limit.

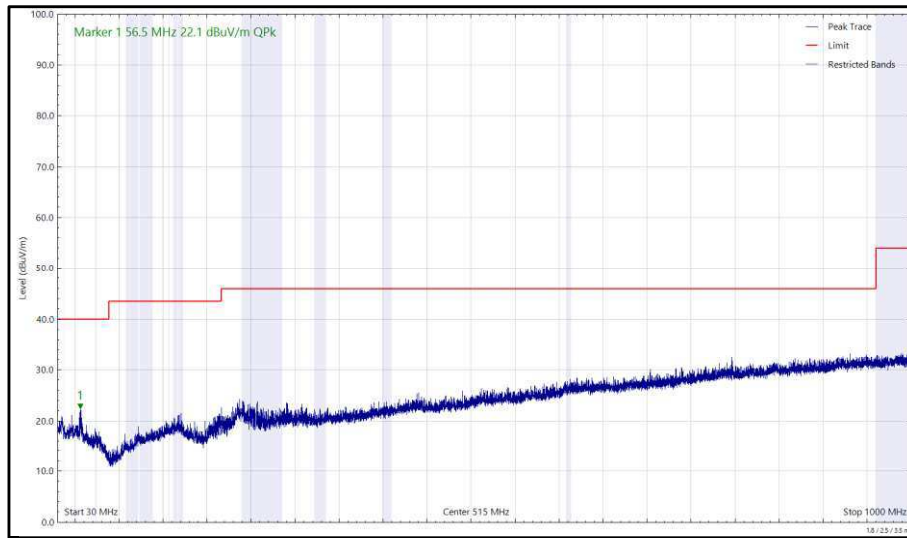

Figure 508 - U-NII-3 - 5825 MHz (CH165), HE20, RU26-0, CDD, Core 0 + Core 1, 30 MHz to 1 GHz, Horizontal (Peak)

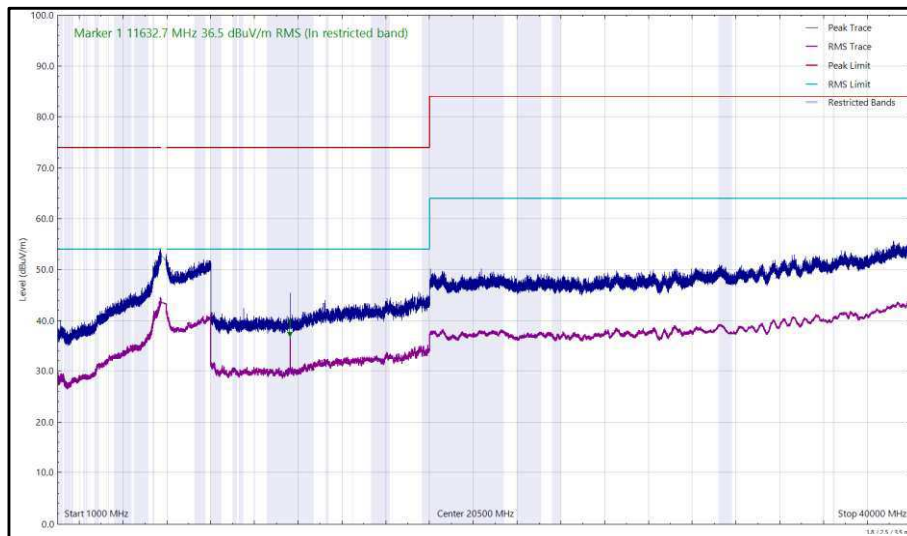

Figure 509 - U-NII-3 - 5825 MHz (CH165), HE20, RU26-0, CDD, Core 0 + Core 1, 1 GHz to 40 GHz, Horizontal

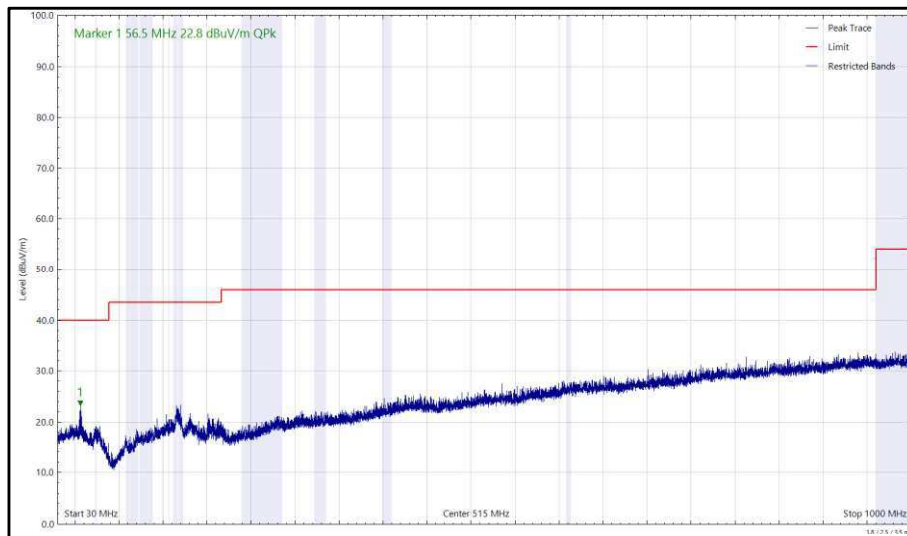

Figure 510 - U-NII-3 - 5825 MHz (CH165), HE20, RU26-0, CDD, Core 0 + Core 1, 30 MHz to 1 GHz, Vertical (Peak)

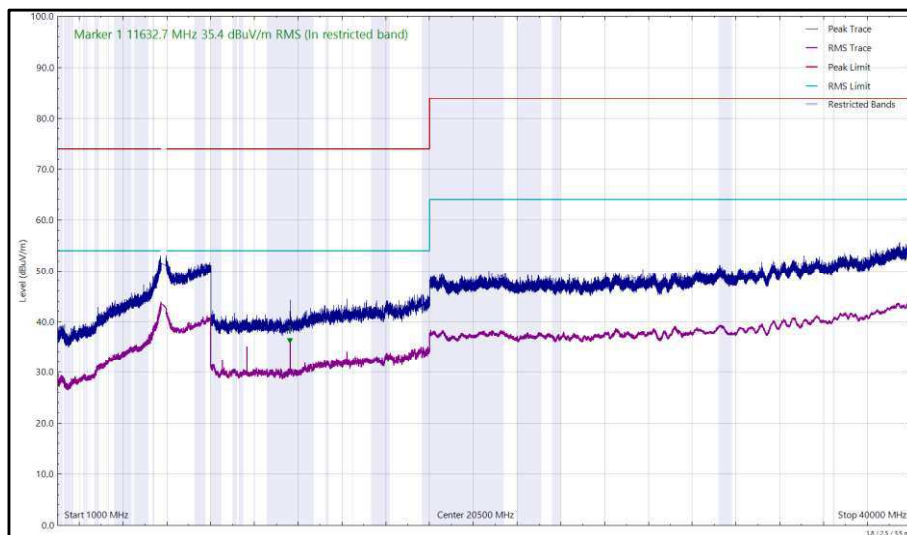

Figure 511 - U-NII-3 - 5825 MHz (CH165), HE20, RU26-0, CDD, Core 0 + Core 1, 1 GHz to 40 GHz, Vertical



Frequency (MHz)	Level (dBuV/m)	Limit (dBuV/m)	Margin (dB)	Detector	Angle (°)	Height (cm)	Polarisation
53.967	21.80	40.00	-18.20	Q-Peak	84	350	Horizontal
54.981	21.88	40.00	-18.12	Q-Peak	0	351	Vertical

Table 770 - U-NII-1 - 5180 MHz (CH36), VHT20, CDD, Core 0 + Core 1, 30 MHz to 40 GHz

No other emissions found within 10 dB of the limit.

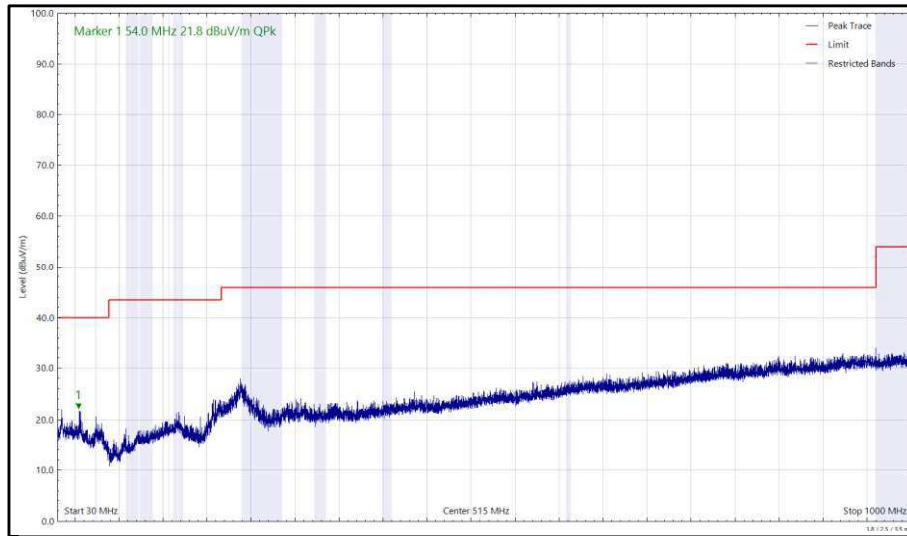

Figure 512 - U-NII-1 - 5180 MHz (CH36), VHT20, CDD, Core 0 + Core 1, 30 MHz to 1 GHz, Horizontal (Peak)

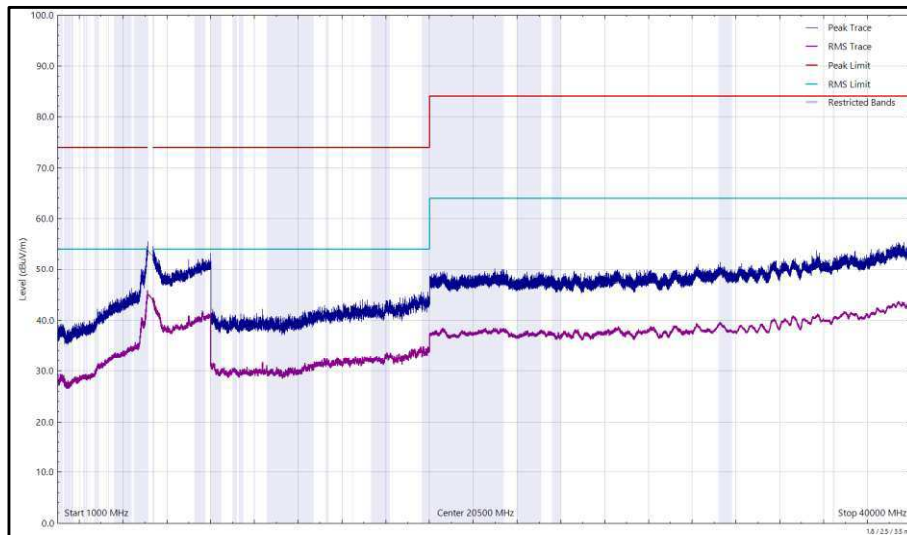

Figure 513 - U-NII-1 - 5180 MHz (CH36), VHT20, CDD, Core 0 + Core 1, 1 GHz to 40 GHz, Horizontal

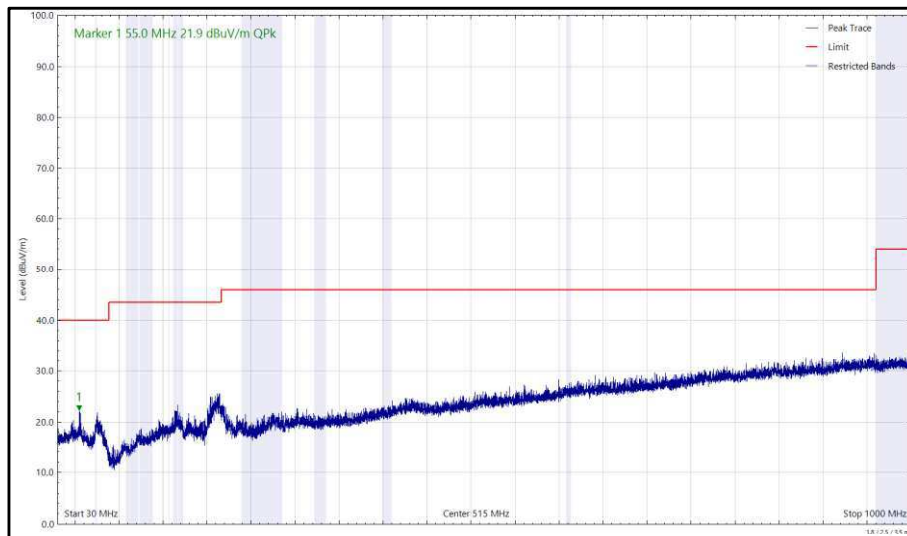

Figure 514 - U-NII-1 - 5180 MHz (CH36), VHT20, CDD, Core 0 + Core 1, 30 MHz to 1 GHz, Vertical (Peak)

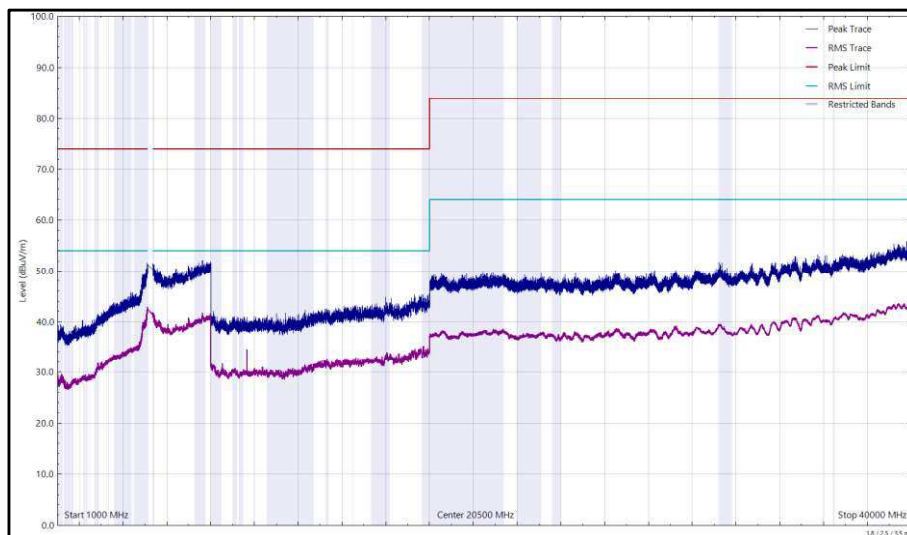

Figure 515 - U-NII-1 - 5180 MHz (CH36), VHT20, CDD, Core 0 + Core 1, 1 GHz to 40 GHz, Vertical



Frequency (MHz)	Level (dBuV/m)	Limit (dBuV/m)	Margin (dB)	Detector	Angle (°)	Height (cm)	Polarisation
*							

Table 771 - U-NII-2A - 5320 MHz (CH64), VHT20, CDD, Core 0 + Core 1, 1 GHz to 40 GHz

*No emissions found within 10 dB of the limit.

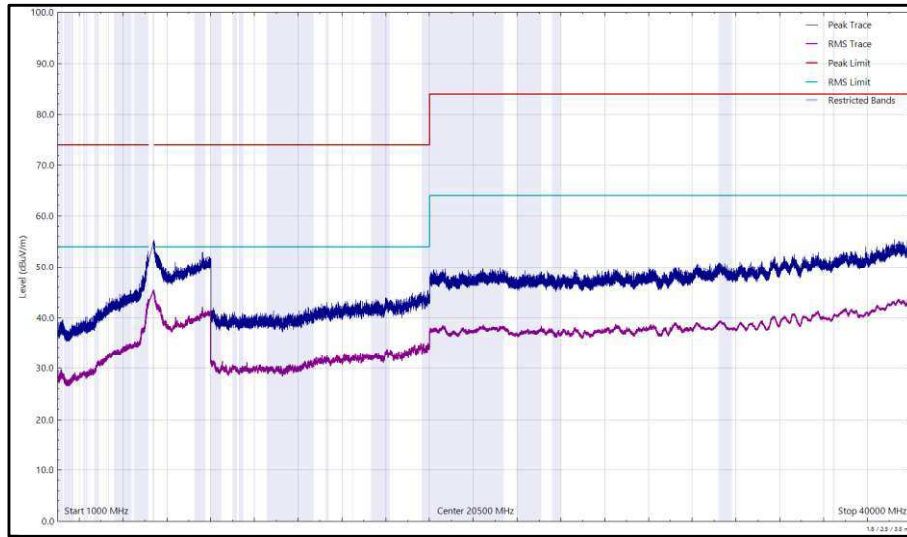

Figure 516 - U-NII-2A - 5320 MHz (CH64), VHT20, CDD, Core 0 + Core 1, 1 GHz to 40 GHz, Horizontal

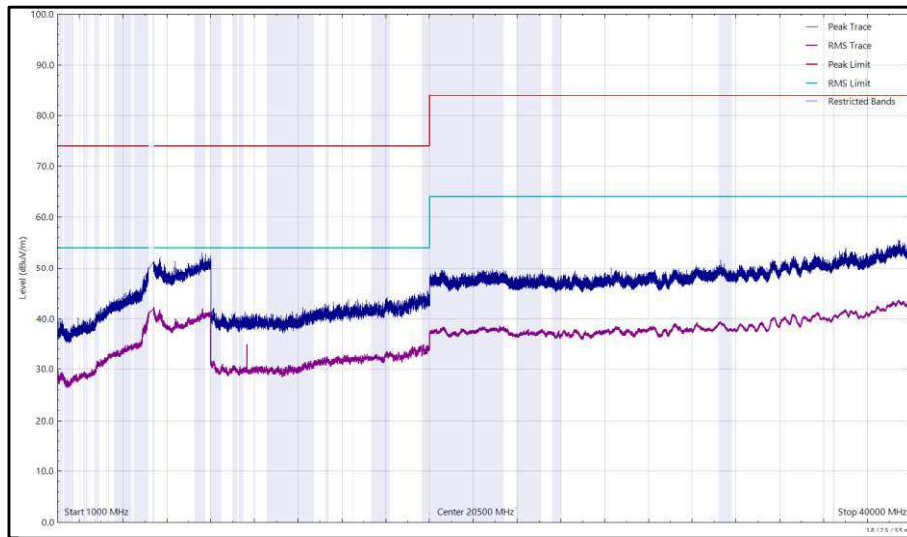

Figure 517 - U-NII-2A - 5320 MHz (CH64), VHT20, CDD, Core 0 + Core 1, 1 GHz to 40 GHz, Vertical



Frequency (MHz)	Level (dBuV/m)	Limit (dBuV/m)	Margin (dB)	Detector	Angle (°)	Height (cm)	Polarisation
*							

Table 772 - U-NII-2C - 5500 MHz (CH100), VHT20, CDD, Core 0 + Core 1, 1 GHz to 40 GHz

*No emissions found within 10 dB of the limit.

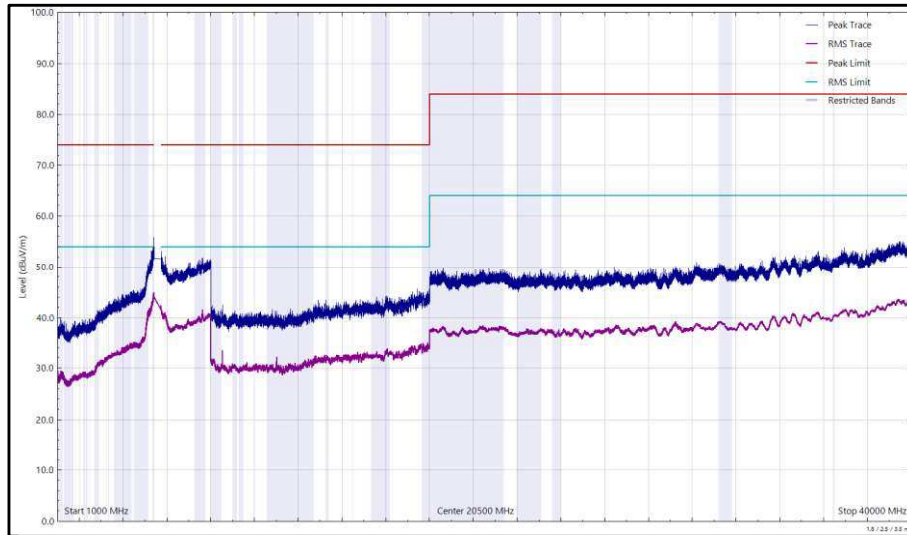

Figure 518 - U-NII-2C - 5500 MHz (CH100), VHT20, CDD, Core 0 + Core 1, 1 GHz to 40 GHz, Horizontal

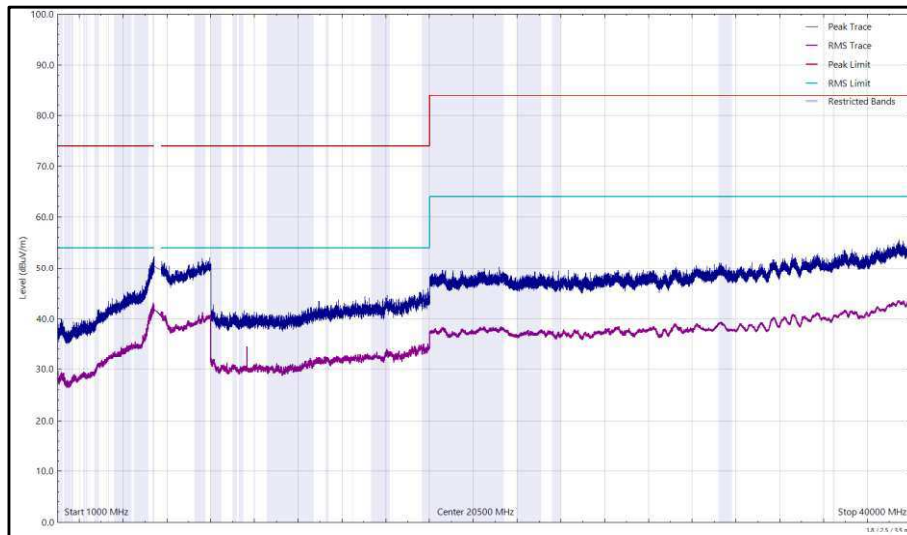

Figure 519 - U-NII-2C - 5500 MHz (CH100), VHT20, CDD, Core 0 + Core 1, 1 GHz to 40 GHz, Vertical



Frequency (MHz)	Level (dBuV/m)	Limit (dBuV/m)	Margin (dB)	Detector	Angle (°)	Height (cm)	Polarisation
*							

Table 773 - U-NII-2C - 5700 MHz (CH140), VHT20, CDD, Core 0 + Core 1, 1 GHz to 40 GHz

*No emissions found within 10 dB of the limit.

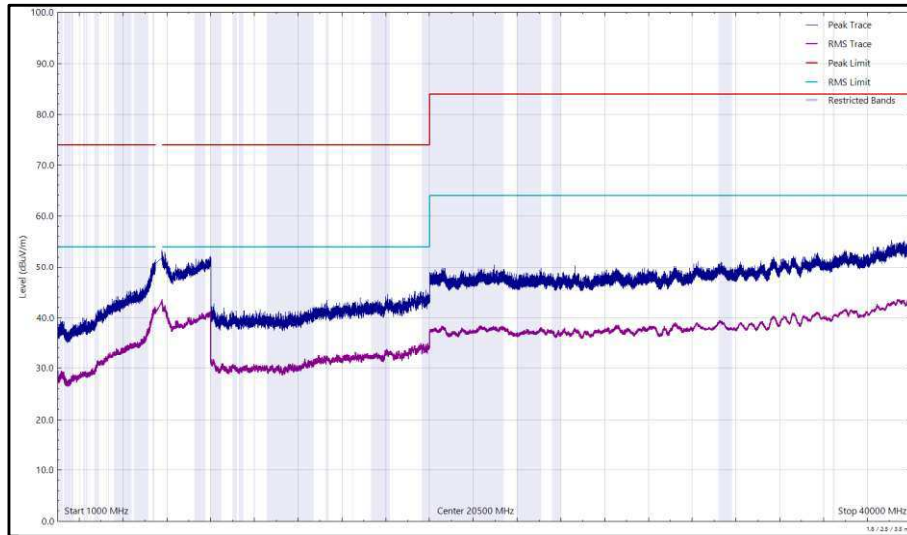

Figure 520 - U-NII-2C - 5700 MHz (CH140), VHT20, CDD, Core 0 + Core 1, 1 GHz to 40 GHz, Horizontal

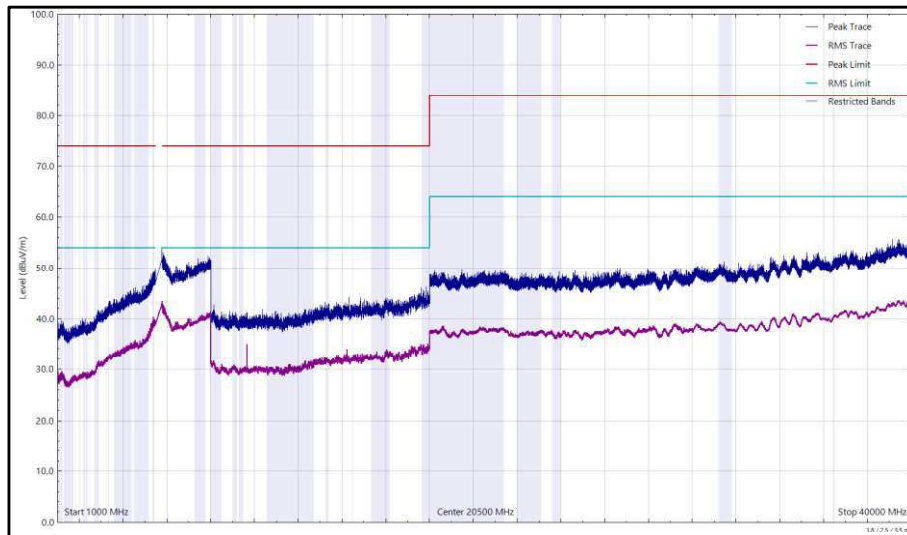

Figure 521 - U-NII-2C - 5700 MHz (CH140), VHT20, CDD, Core 0 + Core 1, 1 GHz to 40 GHz, Vertical



Frequency (MHz)	Level (dBuV/m)	Limit (dBuV/m)	Margin (dB)	Detector	Angle (°)	Height (cm)	Polarisation
*							

Table 774 - U-NII-3 - 5745 MHz (CH149), VHT20, CDD, Core 0 + Core 1, 1 GHz to 40 GHz

*No emissions found within 10 dB of the limit.

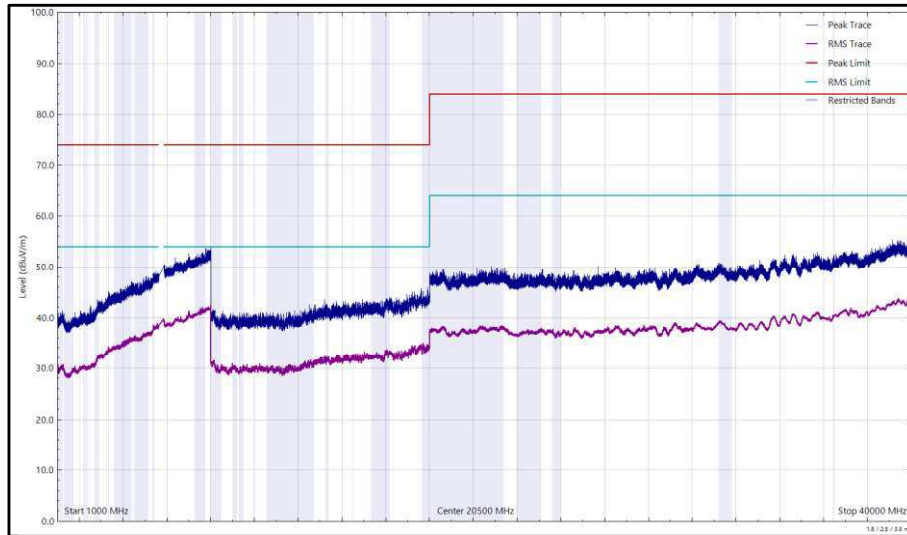

Figure 522 - U-NII-3 - 5745 MHz (CH149), VHT20, CDD, Core 0 + Core 1, 1 GHz to 40 GHz, Horizontal

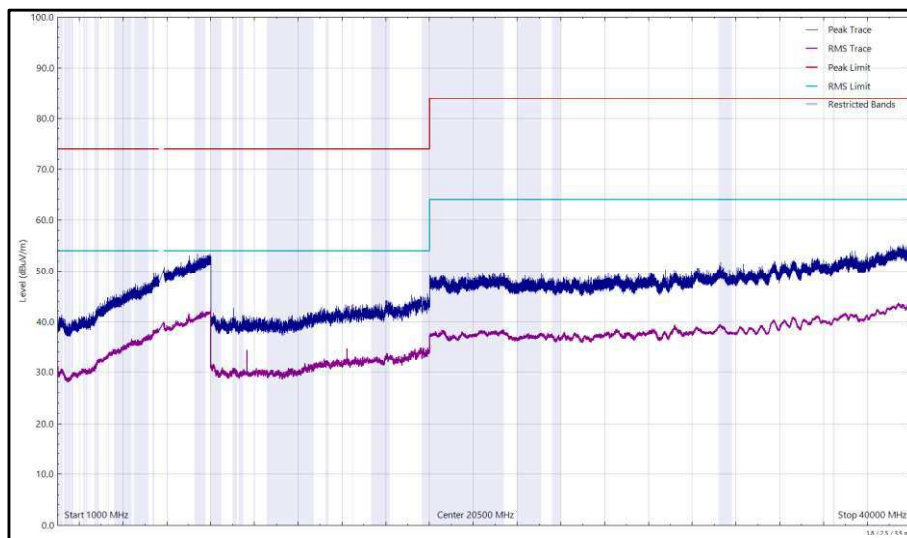

Figure 523 - U-NII-3 - 5745 MHz (CH149), VHT20, CDD, Core 0 + Core 1, 1 GHz to 40 GHz, Vertical



Frequency (MHz)	Level (dBuV/m)	Limit (dBuV/m)	Margin (dB)	Detector	Angle (°)	Height (cm)	Polarisation
*							

Table 775 - U-NII-3 - 5825 MHz (CH165), VHT20, CDD, Core 0 + Core 1, 30 MHz to 40 GHz

*No emissions found within 10 dB of the limit.

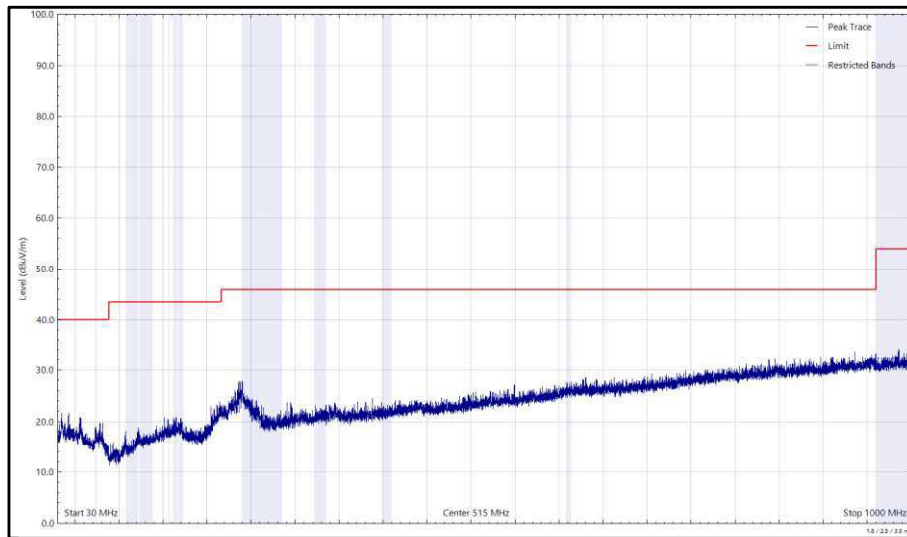

Figure 524 - U-NII-3 - 5825 MHz (CH165), VHT20, CDD, Core 0 + Core 1, 30 MHz to 1 GHz, Horizontal (Peak)

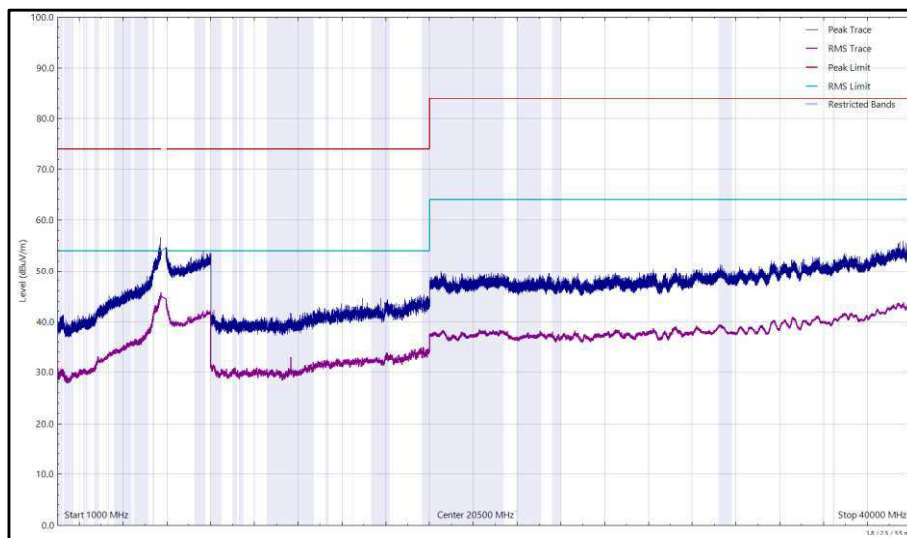

Figure 525 - U-NII-3 - 5825 MHz (CH165), VHT20, CDD, Core 0 + Core 1, 1 GHz to 40 GHz, Horizontal

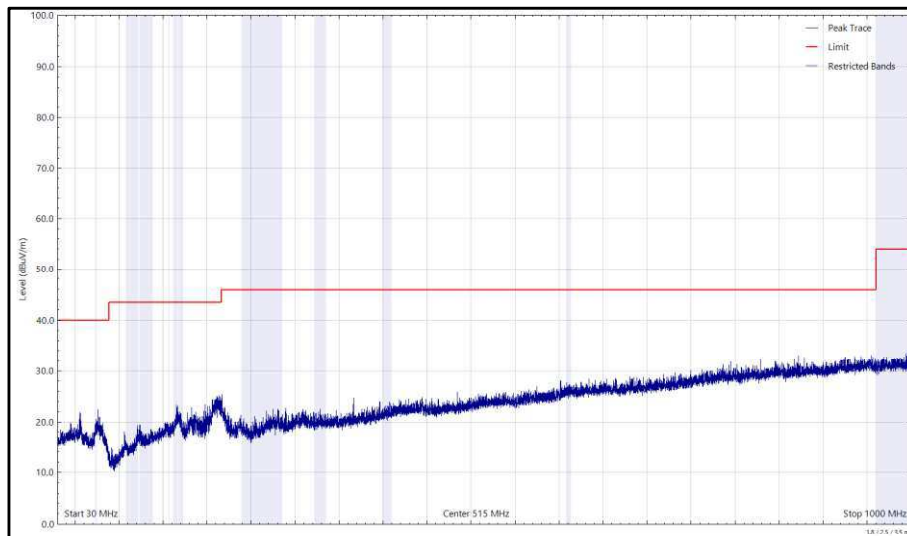

Figure 526 - U-NII-3 - 5825 MHz (CH165), VHT20, CDD, Core 0 + Core 1, 30 MHz to 1 GHz, Vertical (Peak)

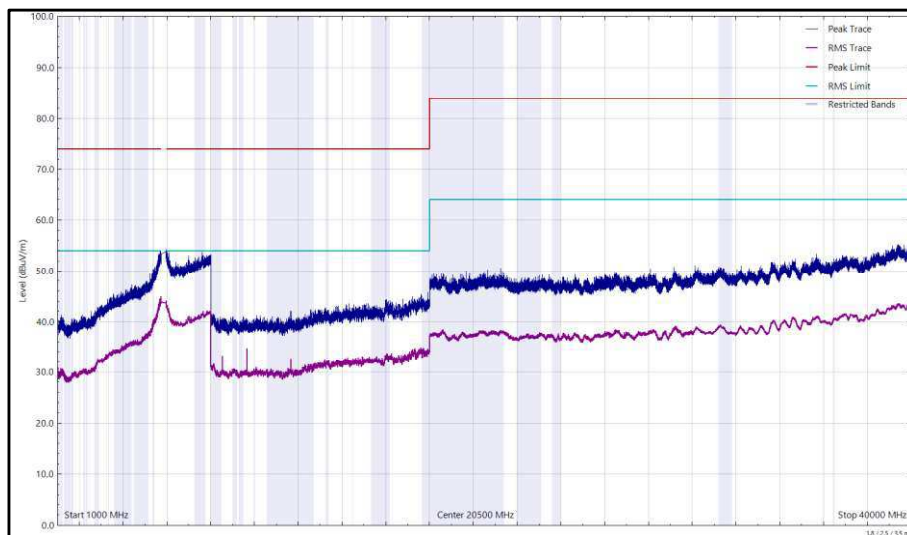

Figure 527 - U-NII-3 - 5825 MHz (CH165), VHT20, CDD, Core 0 + Core 1, 1 GHz to 40 GHz, Vertical



FCC 47 CFR Part 15, Limit Clause 15.407(b)(1)(2)(3)(4)

Emissions not falling within the restricted bands listed in FCC 47 CFR Part 15.209:

For transmitters operating in the 5.15-5.25 GHz band: ≤ -27 dBm/MHz outside 5150-5350 MHz.

For transmitters operating in the 5.25-5.35 GHz band: ≤ -27 dBm/MHz outside 5150-5350 MHz.

For transmitters operating in the 5.47-5.725 GHz band: ≤ -27 dBm/MHz outside 5470-5725 MHz

For transmitters operating in the 5.725-5.85 GHz band: All emissions shall be limited to a level of -27 dBm/MHz at 75 MHz or more above or below the band edge increasing linearly to 10 dBm/MHz at 25 MHz above or below the band edge, and from 25 MHz above or below the band edge increasing linearly to a level of 15.6 dBm/MHz at 5 MHz above or below the band edge, and from 5 MHz above or below the band edge increasing linearly to a level of 27 dBm/MHz at the band edge.

Emissions within the restricted bands listed in FCC 47 CFR Part 15.209:

Frequency (MHz)	Field Strength Limit at 3m (μ V/m)	Field Strength Limit at 3m (dB μ V/m)
30 to 88	100	40.00
88 to 216	150	43.52
216 to 960	200	46.02
Above 960	500	53.98

Table 776 - Radiated Emissions Limit Table (FCC)



ISED RSS-247, Limit Clause 6.2.1.2, 6.2.2.2, 6.2.3.2 and 6.2.4.2 and ISED RSS-GEN, Limit Clause 8.9

Emissions not falling within the restricted bands listed in ISED RSS-GEN, Clause 8.10:

For transmitters with operating frequencies in the band 5150-5250 MHz, all emissions outside the band 5150-5350 MHz shall not exceed -27 dBm/MHz e.i.r.p. Any unwanted emissions that fall into the band 5250-5350 MHz shall be attenuated below the channel power by at least 26 dB.

For transmitters with operating frequencies in the bands 5250-5350 MHz and 5470-5725 MHz, all emissions outside the band 5250-5350 MHz and 5470-5725 MHz shall not exceed -27 dBm/MHz e.i.r.p.

Devices operating in the band 5725-5850 MHz shall have e.i.r.p. of unwanted emissions comply with the following:

- a) 27 dBm/MHz at frequencies from the band edges decreasing linearly to 15.6 dBm/MHz at 5 MHz above or below the band edges;
- b) 15.6 dBm/MHz at 5 MHz above or below the band edges decreasing linearly to 10 dBm/MHz at 25 MHz above or below the band edges;
- c) 10 dBm/MHz at 25 MHz above or below the band edges decreasing linearly to -27 dBm/MHz at 75 MHz above or below the band edges; and
- d) -27 dBm/MHz at frequencies more than 75 MHz above or below the band edges.

Emissions falling within the restricted bands listed in ISED RSS-GEN, Clause 8.10:

Frequency (MHz)	Field Strength Limit at 3m ($\mu\text{V}/\text{m}$)	Field Strength Limit at 3m ($\text{dB}\mu\text{V}/\text{m}$)
30 to 88	100	40.00
88 to 216	150	43.52
216 to 960	200	46.02
Above 960	500	53.98

Table 777 - Radiated Emissions Limit Table (ISED)



2.6.8 Test Location and Test Equipment Used

This test was carried out in RF Chamber 14.

Instrument	Manufacturer	Type No.	TE No.	Calibration Period (months)	Calibration Expiry Date
Emissions Software	TUV SUD	EmX V3.1.10	5125	-	Software
EMI Test Receiver	Rohde & Schwarz	ESW44	5912	12	17-Mar-2023
Cable (K Type 2m)	Junkosha	MWX241-02000KMSKMS/B	5937	12	14-May-2023
DRG Horn Antenna (7.5-18GHz)	Schwarzbeck	HWRD750	5941	12	29-May-2023
TRILOG Super Broadband Test Antenna	Schwarzbeck	VULB 9168	5943	24	03-Feb-2024
1500W (300V 12A) AC Power Supply	iTech	IT7324	5956	-	O/P Mon
5m Semi-Anechoic Chamber (Dual-Axis)	Albatross Projects	RF Chamber 14	5958	36	26-Apr-2025
Compact Antenna Mast	Maturo Gmbh	CAM4.0-P	5959	-	TU
Mast & Turntable Controller	Maturo Gmbh	FCU3.0	5960	-	TU
Tilt Antenna Mast	Maturo Gmbh	BAM4.5-P	5961	-	TU
Turntable	Maturo Gmbh	TT1.5SI	5962	-	TU
Cable (SMA to SMA 1m)	Junkosha	MWX221-01000AMSAMS/A	5997	12	06-Jun-2023
Cable (SMA to SMA 6.5m)	Junkosha	MWX221-06500AMSAMS/B	6003	12	07-Jun-2023
Cable (SMA to SMA 1m)	Junkosha	MWX221-01000AMSAMS/A	6008	12	06-Jun-2023
Cable (N to N 1m)	Junkosha	MWX221-01000AMSAMS/B	6009	12	07-Jun-2023
Cable (N to N 7m)	Junkosha	MWX221-07000NMSNMS/B	6016	12	05-Jun-2023
Cable (N to N 8m)	Junkosha	MWX221-08000NMSNMS/A	6017	12	05-Jun-2023
Horn Antenna (1-10 GHz)	Schwarzbeck	BBHA9120B	6141	12	21-Jun-2023
SAC Switch Unit	TUV SUD	TUV_SSU_001	6144	12	05-Dec-2023
Double Ridge Active Horn Antenna (18-40 GHz)	Com-Power	AHA-840	6188	24	02-Jun-2024
8 GHz Highpass Filter	Wainwright	WHKX 7150 8000 18000 50SS	6194	12	15-Jul-2023
Pre Amp 8 - 18 GHz	Wright Technologies	APS06 0061	6199	12	19-Jul-2023
Attenuator 4dB	Pasternack	PE7074-4	6202	24	16-Jul-2024
Cable (SMA to SMA 20cm)	TUV SUD	MH-FH 8-18	6215	12	25-Jul-2023

Table 778

TU - Traceability Unscheduled

O/P Mon - Output Monitored using calibrated equipment



2.7 Channel Move Time, Channel Closing Transmission Time and Non-Occupancy Period

2.7.1 Specification Reference

FCC 47 CFR Part 15E, Clause 15.407 (h)(2)(iii)(iv)
ISED RSS-247 Clause, 6.3.2(c)(d)(e)

2.7.2 Equipment Under Test and Modification State

A2873, S/N: DX9R95FW3R - Modification State 0

2.7.3 Date of Test

22-March-2023

2.7.4 Test Method

This test was performed in accordance with FCC KDB 905462 D02, clause 7.8.3.

To calibrate the level of the radar at the input to the DFS Master device, the DFS Master was replaced by the spectrum analyser and the output of the vector signal generator adjusted to give -62 dBm.

Radar Pulse Type 0 was then transmitted, and the spectrum monitored. The transmissions from the UUT were observed for a period of 12 seconds after the final injected Radar Pulse.

It was checked that all transmissions stopped within the 10 second period defined from the point of the end of the final Radar pulse + 10 seconds. In addition, the aggregate on time during the first 200ms and the following 9.8 seconds of the Channel Move Time was computed.

The markers on the trace data correspond to the following time periods:

Yellow - End of Radar Burst, (T0)

Purple - End of Channel Move Time, (T0 + 10 seconds)

To verify the non-occupancy period, the external trigger was used to trigger a 30-minute sweep from the moment the radar burst sequence was injected. It was verified that no transmissions occurred on the test channel during this time period.

The EUT supports direct communication with another client while under supervision of a DFS Master. Therefore, this direct client-to-client mode was also tested in accordance with KDB 905462 D03 clause (b)3.

2.7.5 Environmental Conditions

Ambient Temperature 24.4 °C

Relative Humidity 43.0 %

2.7.6 Test Results

5 GHz WLAN – Master to Client - 802.11ac VHT160

The equipment was set up as shown in the diagram below.

A test laptop was connected via an Ethernet cable to the Master device and was configured to run iPerf, transmitting UDP to the EUT. An appropriate rate and buffer was found and used to achieve the correct channel loading. The EUT The channel loading was set to >17% by adjusting the bandwidth specified in the iPerf UDP transfer.

Radar Type	Pulse Width (µs)	PRI (µs)	Number of Pulses
0	1	1428	18

Table 779 - Radar Pulse Type 0 Characteristics

Manufacturer	Model	Serial Number	FCC ID
ASUS	GT-AXE11000	M8IG0X400285XVN	MSQ-RTAXJF00

Table 780 - Details of Master Device used to support testing

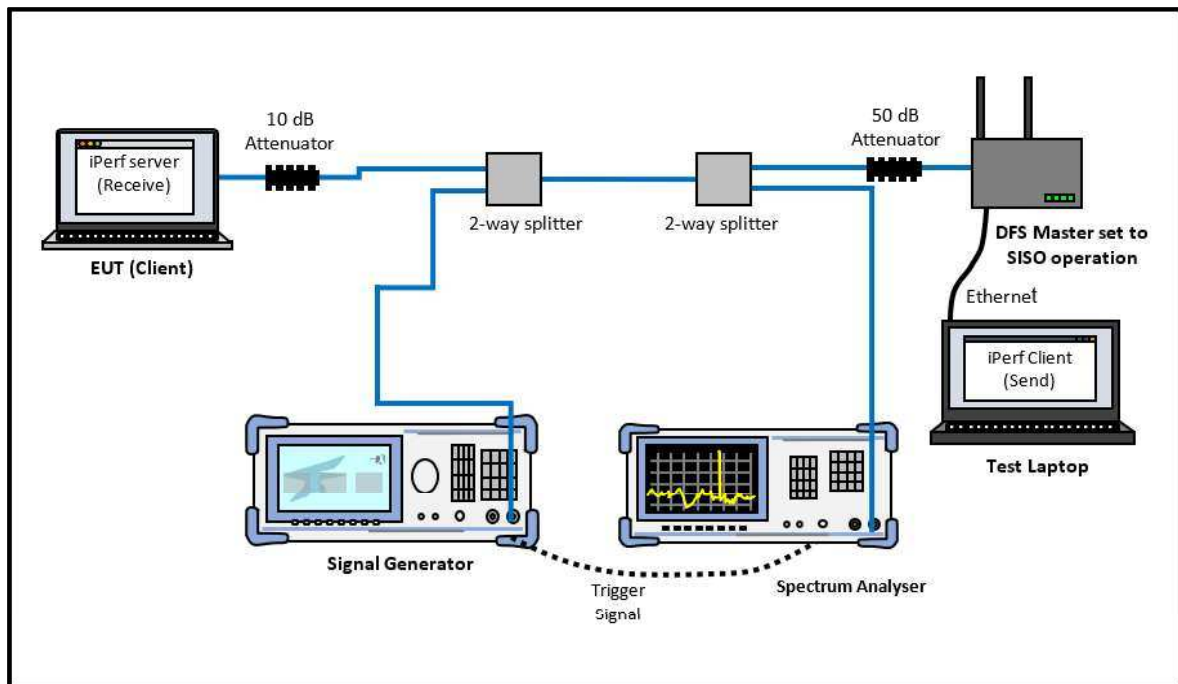

Figure 528 - Test Equipment Setup Diagram for Client without Radar Detection with Injection at the Master

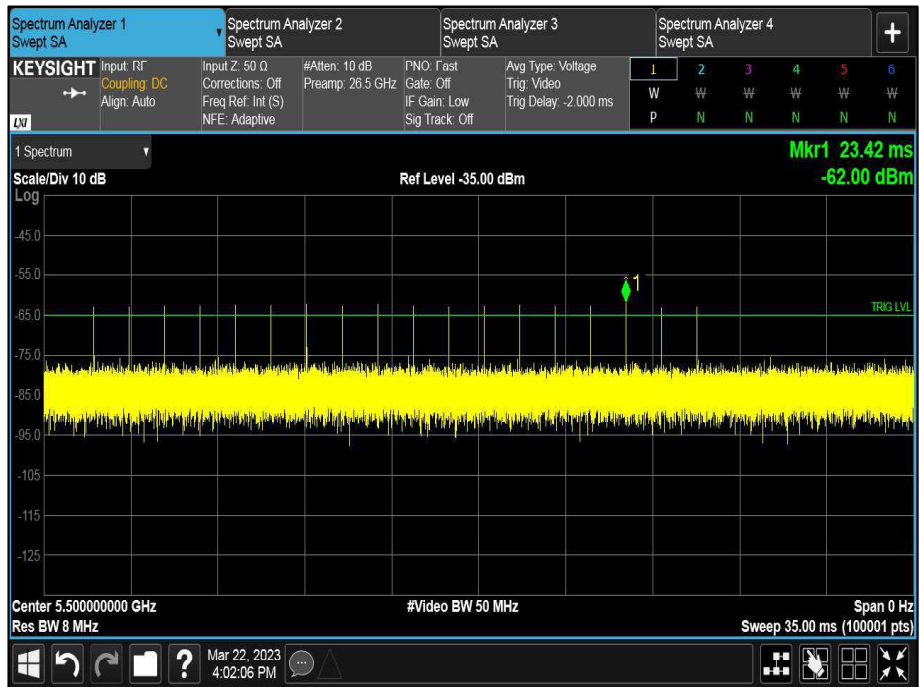

Figure 529 - Verification of Radar Type 0

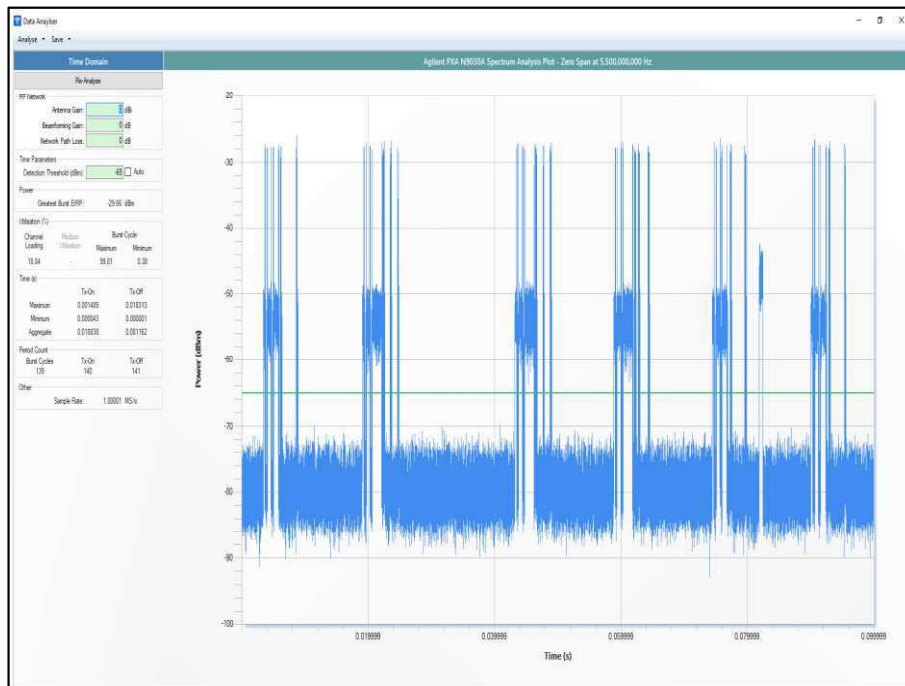

Figure 530 - Channel Loading

The channel loading was 18.84%.



Maximum Transmit Power	Value (Notes 1 and 2)
≥ 200 milliwatt	-64 dBm
< 200 milliwatt	-62 dBm
Note 1: This is the level at the input of the receiver assuming a 0 dBi receive antenna. Note 2: Throughout these test procedures an additional 1 dB has been added to the amplitude of the test transmission waveforms to account for variations in measurement equipment. This will ensure that the test signal is at or above the detection threshold level to trigger a DFS response.	

Table 781 - DFS Detection Thresholds for Master Devices and Client Devices with Radar Detection

Test Parameter	Result
Test Channel	CH114 (5570 MHz), Control CH100 (5500 MHz)
Channel Move Time	0.819 s
Channel Closing Time (Aggregate Time During 200 ms)	36.000 ms
Channel Closing Time (Aggregate Time During 200 ms to 10 s)	5.125 ms
Channel Closing Time (Aggregate Time During 10 s)	41.125 ms
Transmission Observed During Non-Occupancy Period	No

Table 782 - In-Service Monitoring Test Results

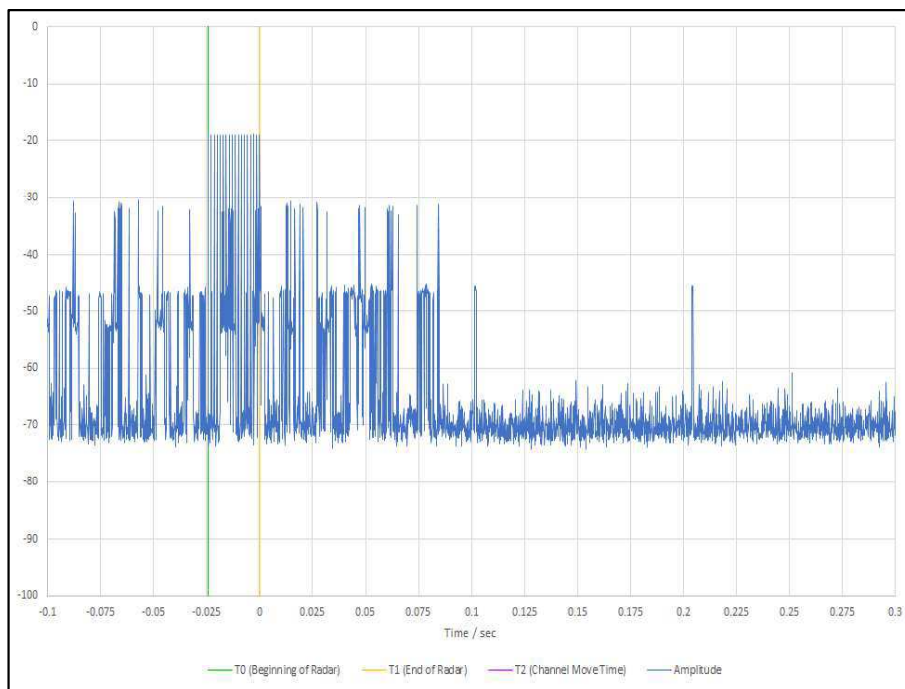

Figure 531 - First 200 ms of Channel Shutdown Period

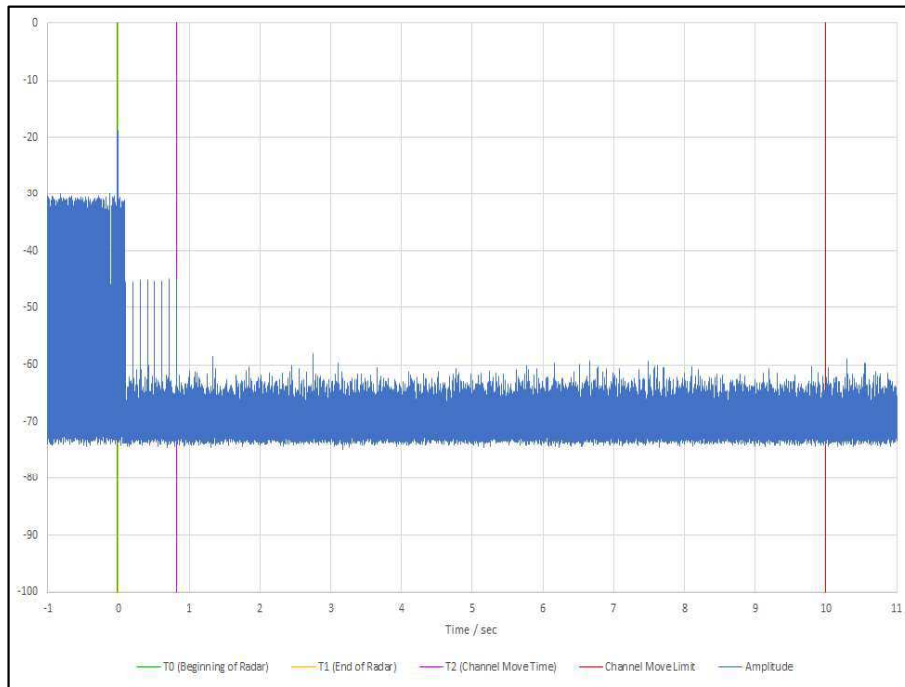

Figure 532 - First 12 s of Channel Shutdown Period

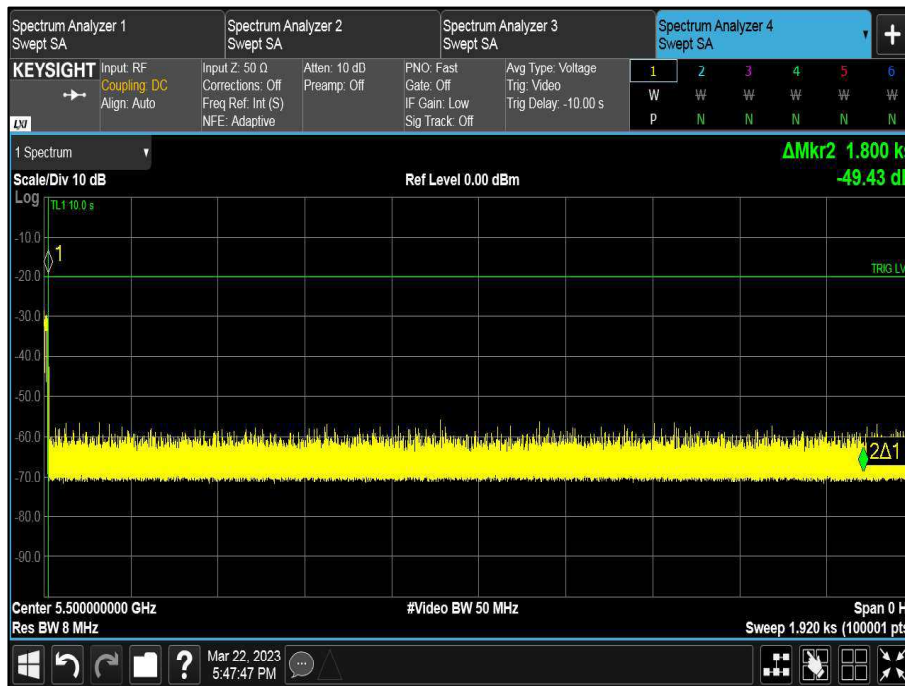

Figure 533 - 30 minute Non-Occupancy Period

5 GHz WLAN - Client to Client - 802.11ac VHT160

The equipment was set up as shown in the diagram below.

The EUT and a 2nd client device were both connected to the DFS Master device. The 2nd client device was set to stream video directly to the EUT using the AirPlay protocol, while under the supervision of the DFS master (but without the DFS master re-transmitting the data packets). The channel loading was checked to ensure it was >17%.

Radar Type	Pulse Width (μ s)	PRI (μ s)	Number of Pulses
0	1	1428	18

Table 783 - Radar Pulse Type 0 Characteristics

Manufacturer	Model	Serial Number	FCC ID
ASUS	GT-AXE11000	M81G0X400285XVN	MSQ-RTAXJF00

Table 784 - Details of Master Device used to support testing

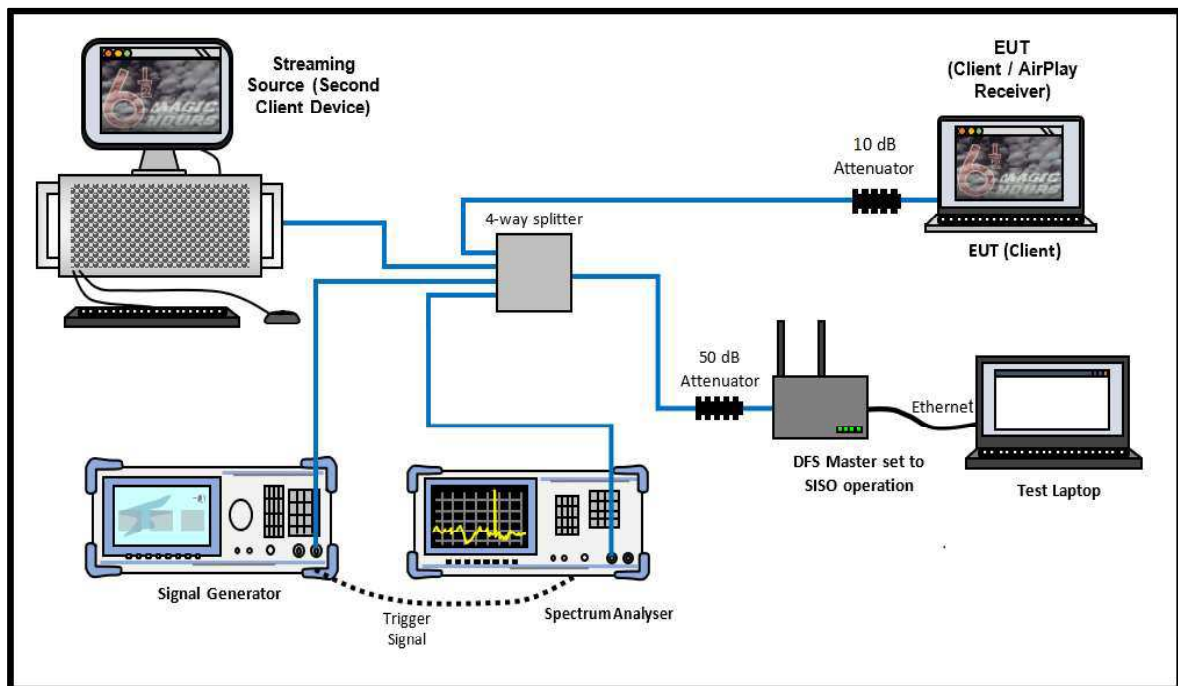

Figure 534 - Test Equipment Setup Diagram for Client without Radar Detection with Injection at the Master

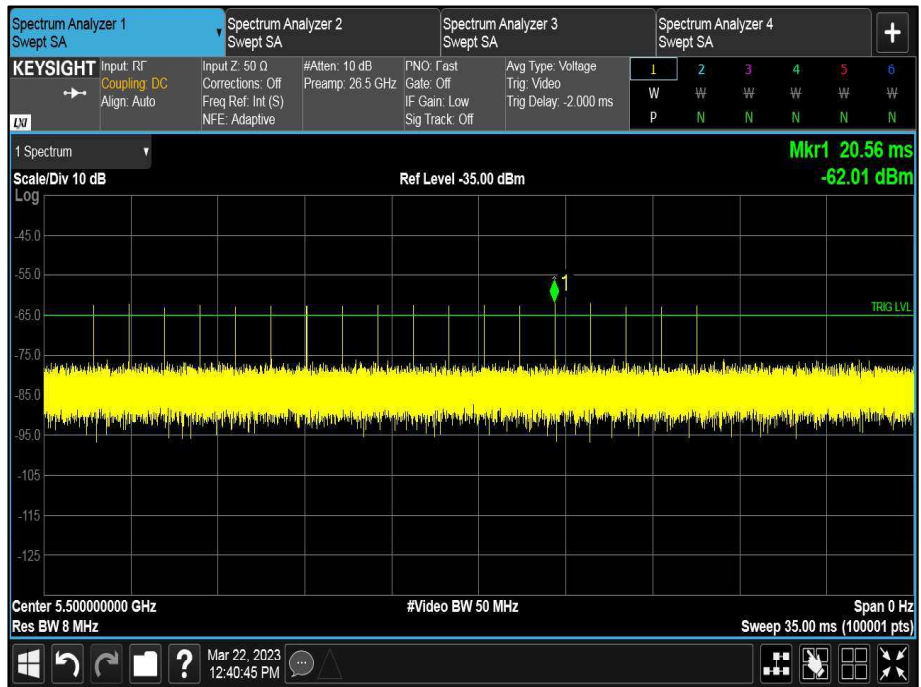

Figure 535 - Verification of Radar Type 0

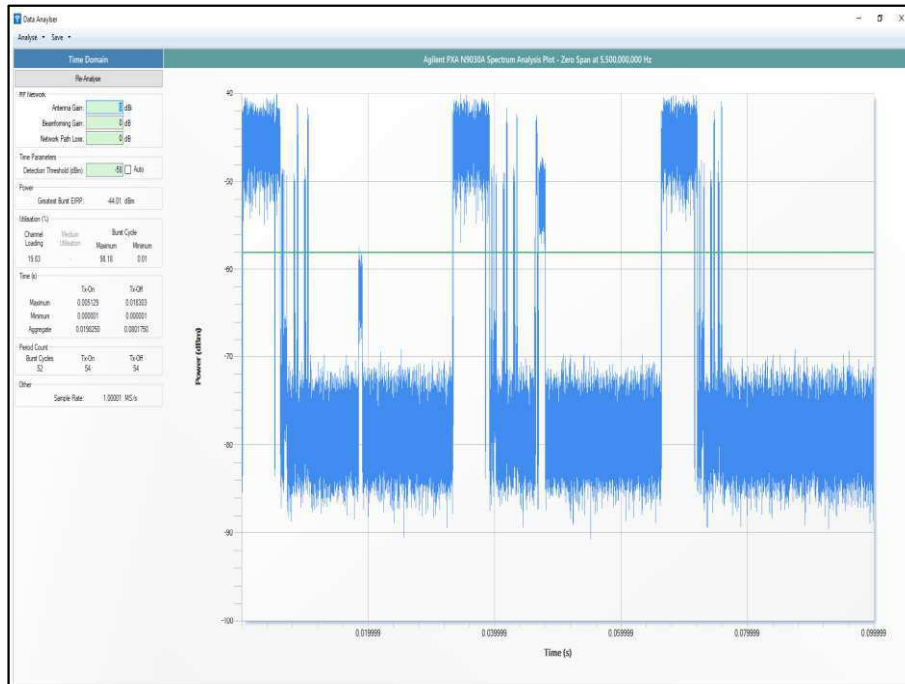

Figure 536 - Channel Loading

The channel loading was 19.83%.



Maximum Transmit Power	Value (Notes 1 and 2)
≥ 200 milliwatt	-64 dBm
< 200 milliwatt	-62 dBm
Note 1: This is the level at the input of the receiver assuming a 0 dBi receive antenna. Note 2: Throughout these test procedures an additional 1 dB has been added to the amplitude of the test transmission waveforms to account for variations in measurement equipment. This will ensure that the test signal is at or above the detection threshold level to trigger a DFS response.	

Table 785 - DFS Detection Thresholds for Master Devices and Client Devices with Radar Detection

Test Parameter	Result
Test Channel	CH114 (5570 MHz), Control CH100 (5500 MHz)
Channel Move Time	0.837 s
Channel Closing Time (Aggregate Time During 200 ms)	28.500 ms
Channel Closing Time (Aggregate Time During 200 ms to 10 s)	7.500 ms
Channel Closing Time (Aggregate Time During 10 s)	36.000 ms
Transmission Observed During Non-Occupancy Period	No

Table 786 - In-Service Monitoring Test Results

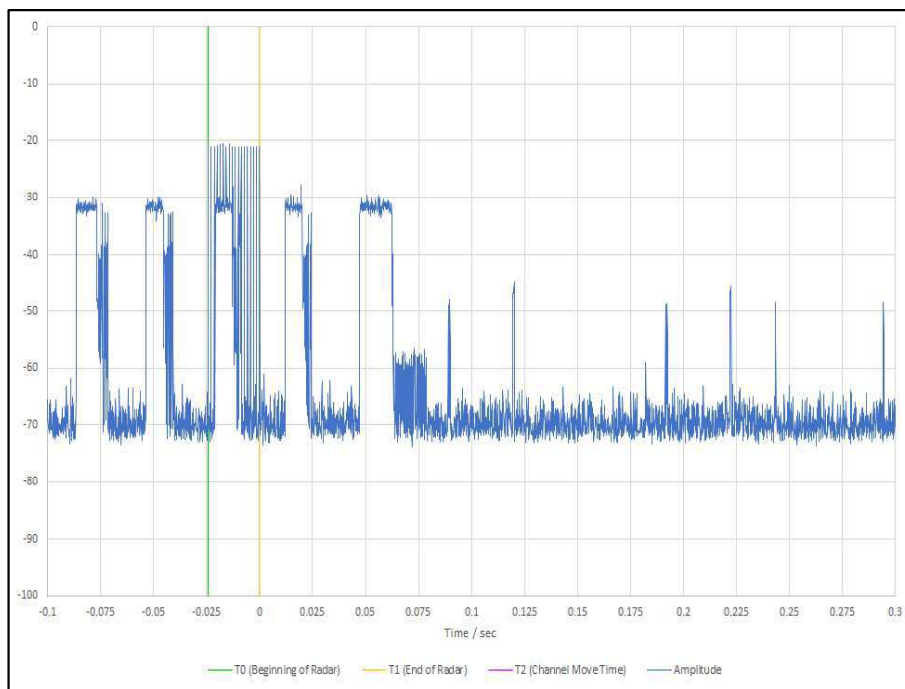

Figure 537 - First 200 ms of Channel Shutdown Period

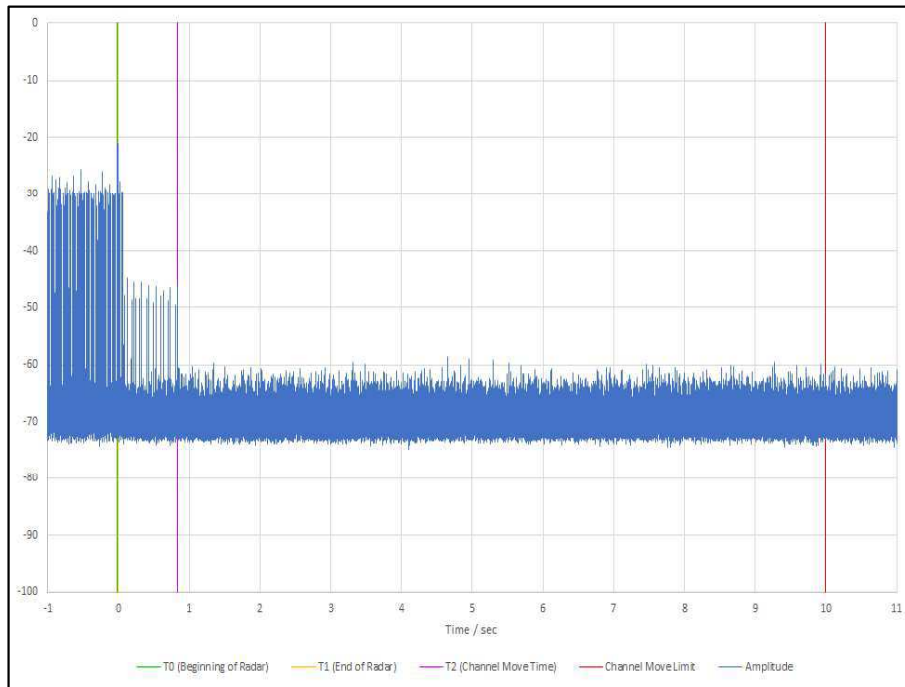

Figure 538 - First 12 s of Channel Shutdown Period

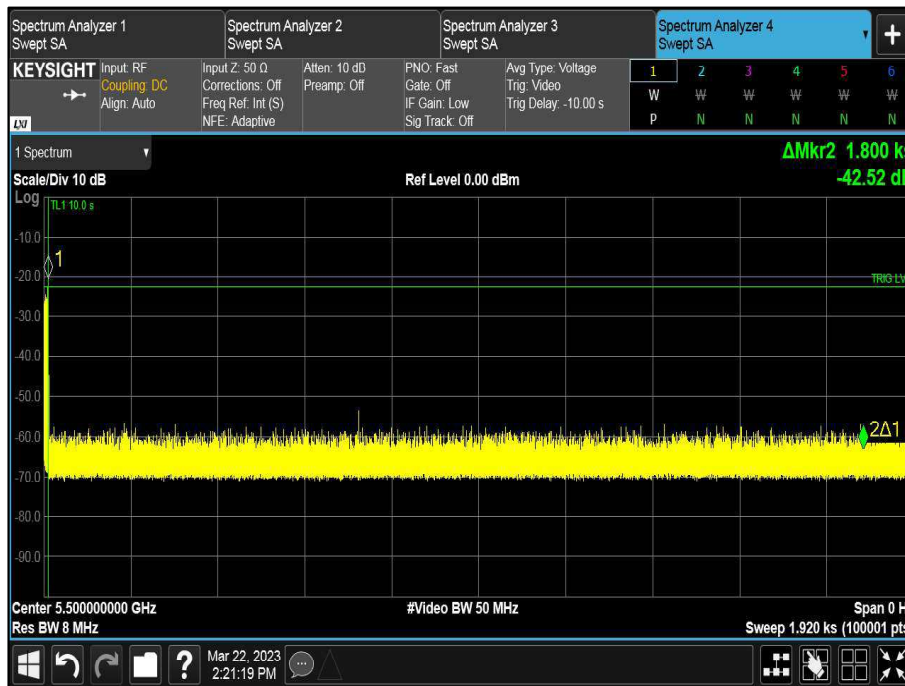

Figure 539 - 30 minute Non-Occupancy Period



FCC 47 CFR Part 15, Limit Clause 15.407 (h)(2)(iii)

Channel Move Time	<10 seconds
Channel Closing Time (Aggregate Time During 200ms)	<200 ms
Channel Closing Time (Aggregate Time During +200ms to 10s)	<60 ms

Table 787 - Channel Move Time and Channel Closing Transmission Time Limit

FCC 47 CFR Part 15, Limit Clause 15.407 (h)(2)(iv)

Non-occupancy Period	> 30 minutes
----------------------	--------------

Table 788 - Non-Occupancy Limit

ISED RSS-247, Limit Clause 6.3.2

Devices shall comply with the following requirements, however, the requirement for in-service monitoring does not apply to slave devices without radar detection.

In-service monitoring: an LE-LAN device shall be able to monitor the operating channel to check that a co-channel radar has not moved or started operation within range of the LE-LAN device. During in-service monitoring, the LE-LAN radar detection function continuously searches for radar signals between normal LE-LAN transmissions.

Channel availability check time: the device shall check whether there is a radar system already operating on the channel before it initiates a transmission on a channel and when it moves to a channel. The device may start using the channel if no radar signal with a power level greater than the interference threshold value specified in Section 6.3.1 above is detected within 60 seconds. This requirement only applies in the master operational mode.

Channel move time: after a radar signal is detected, the device shall cease all transmissions on the operating channel within 10 seconds.

Channel closing transmission time: is comprised of 200 ms starting at the beginning of the channel move time plus any additional intermittent control signals required to facilitate a channel move (an aggregate of 60 ms) over the remaining 10-second period of the channel move time.

Non-occupancy period: a channel that has been flagged as containing a radar signal, either by a channel availability check or in-service monitoring, is subject to a 30-minute non-occupancy period where the channel cannot be used by the LE-LAN device. The non-occupancy period starts from the time that the radar signal is detected



2.7.7 Test Location and Test Equipment Used

This test was carried out in RF Chamber 18.

Instrument	Manufacturer	Type No.	TE No.	Calibration Period (months)	Calibration Expiry Date
Attenuator (20dB, 1W)	Sealectro	60-674-1020-89	1520	-	O/P Mon
Power splitter - 4 port	Mini-Circuits	ZN4PD1-63-S+	4744	12	21-Feb-2024
EXA	Keysight Technologies	N9010B	4969	24	07-Feb-2024
Cable (18 GHz)	Rosenberger	LU7-071-1000	5103	12	18-Dec-2023
Cable (18 GHz)	Rosenberger	LU7-071-2000	5106	12	18-Dec-2023
2.92mm 1m cable	Junkosha	MWX211/B	5415	12	24-Jul-2023
3.5 mm 1m Cable	Junkosha	MWX221-01000DMS	5416	12	06-Mar-2024
3.5 mm 2m Cable	Junkosha	MWX221-02000DMS	5427	12	29-Mar-2023
Attenuator 5W 30dB DC-18GHz	Aaren	AT40A-4041-D18-30	5505	12	21-Feb-2024
2-Way Power Divider (2 to 8 GHz)	Aaren	AT30A-TE0208-2-AF	5684	12	21-Dec-2023
2-Way Power Divider (2-8 GHz)	Aaren	AT30A-TE0208-2-AF	5685	12	21-Dec-2023
Vector Signal Generator	Rohde & Schwarz	SMM100A	5915	36	01-Mar-2026
WiFi 6E Tri-Band Gaming Router	Asus	GT-AXE110000	5926	-	TU
Humidity & Temperature meter	R.S Components	1364	6148	12	17-Jun-2023
Coaxial Fixed Attenuator DC-18GHz 5W 10dB	RF-Lambda	RFS5G18B10SMP	6177	12	17-Jul-2023

Table 789

TU - Traceability Unscheduled
 O/P Mon - Output Monitored using calibrated equipment



3 Measurement Uncertainty

For a 95% confidence level, the measurement uncertainties for defined systems are:

Test Name	Measurement Uncertainty
Restricted Band Edges	± 6.3 dB
Emission Bandwidth	± 3.914 MHz
Maximum Conducted Output Power	± 1.38 dB
Maximum Conducted Power Spectral Density	±1.49 dB
Authorised Band Edges	± 6.3 dB
Spurious Radiated Emissions	30 MHz to 1 GHz: ± 5.2 dB 1 GHz to 40 GHz: ± 6.3 dB
Channel Move Time, Channel Closing Transmission Time and Non-Occupancy Period	Time: ± 0.47 % Power: ± 1.29 dB

Table 790

Measurement Uncertainty Decision Rule – Accuracy Method

Determination of conformity with the specification limits is based on the decision rule according to IEC Guide 115:2021, Clause 4.4.3 (Procedure 2). The measurement results are directly compared with the test limit to determine conformance with the requirements of the standard.

Risk: The uncertainty of measurement about the measured result is negligible with regard to the final pass/fail decision. The measurement result can be directly compared with the test limit to determine conformance with the requirement (compare IEC Guide 115). The level of risk to falsely accept and falsely reject items is further described in ILAC-G8.