

Threaded rack

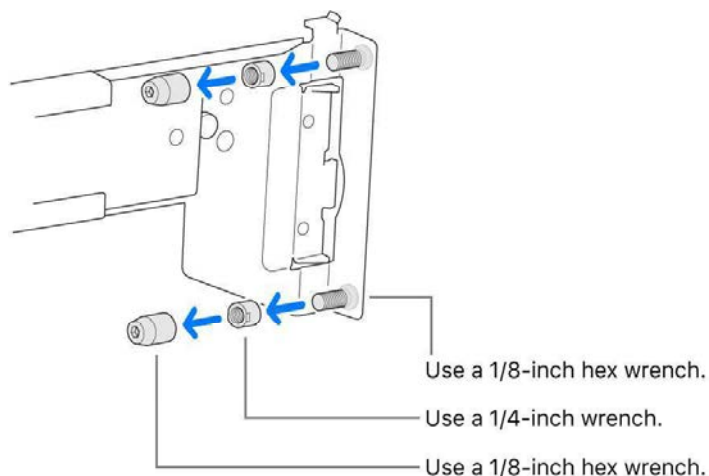

To install Mac Pro into a rack, you need to attach the rail assemblies to Mac Pro and the rack. (The minimum depth of the rack must be at least 24 inches.)

Note: Mac Pro requires five rack units (5U). The top two units should be left vacant, the rail assemblies should be installed in the next two units, and one unit below the rail assemblies should be left vacant.

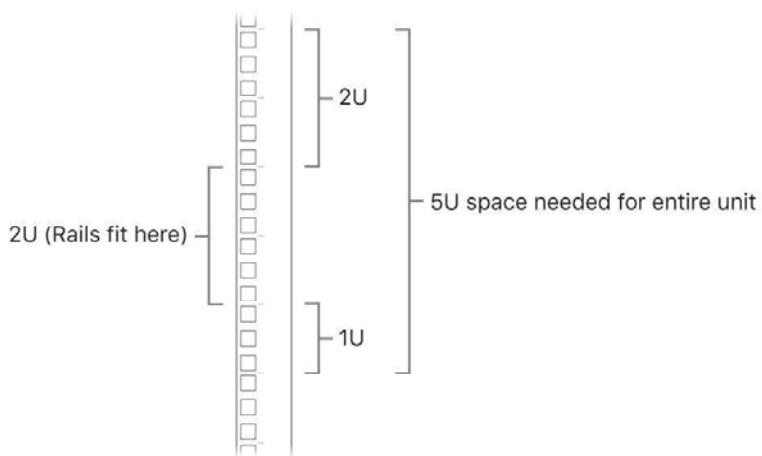

Air that cools Mac Pro flows from front to back. Make sure nothing blocks any of the openings in the front and back of the housing.

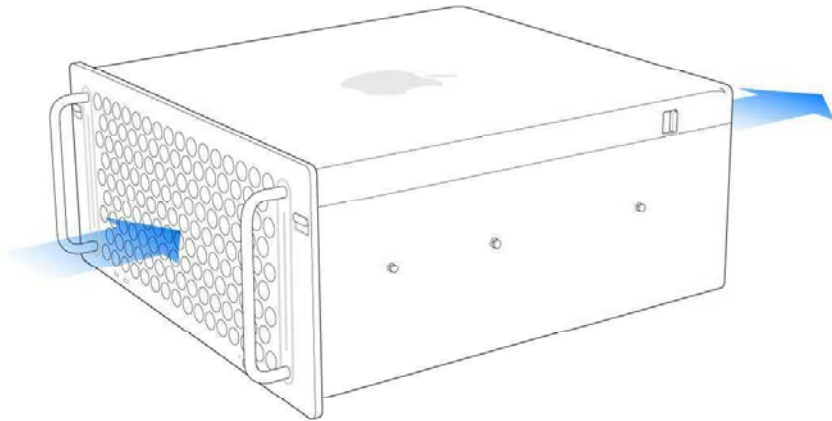

1. Extend the first rail assembly of one of the unmounted rails (left or right assembly).

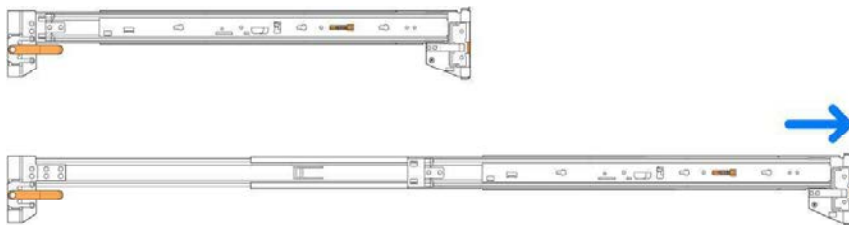

2. Insert the rear rail assembly's pins into the back of the rack, then push the front of the assembly into the rack.

The rail should insert in the rack and the assembly should snap into place. If this doesn't happen, the rail may be locked. In this case, pull the orange lever on the rail to unlock it.

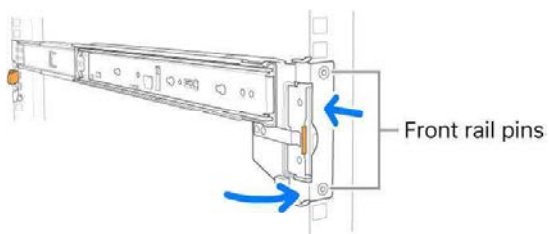
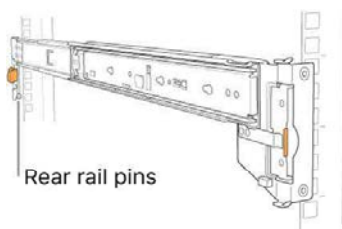

- Slide out the inner rail until it locks.

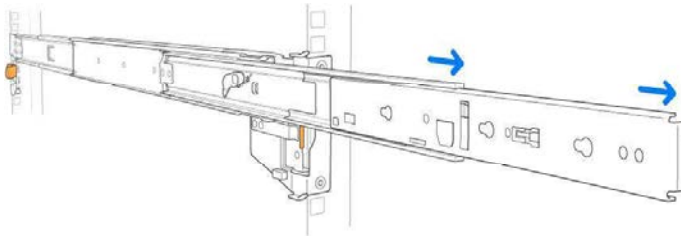

- Slide the release latch to detach the inner rail from the assembly.

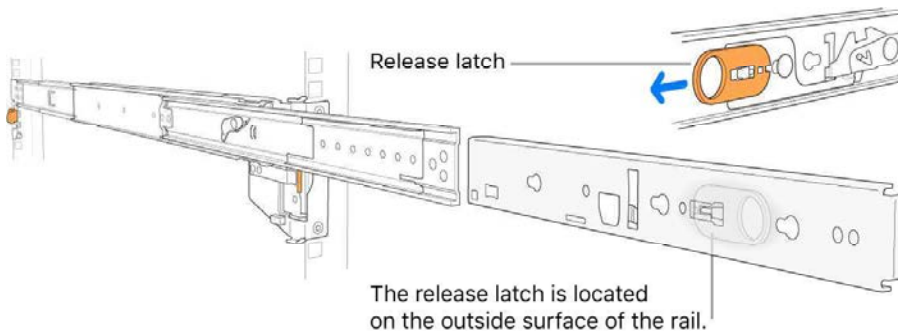

- Repeat steps 1 to 3 for the other rail assembly.
- Attach the inner rails to the sides of Mac Pro, making sure that release latches are towards the front of the computer and the rail eyelets are well placed onto the Mac Pro rail posts.

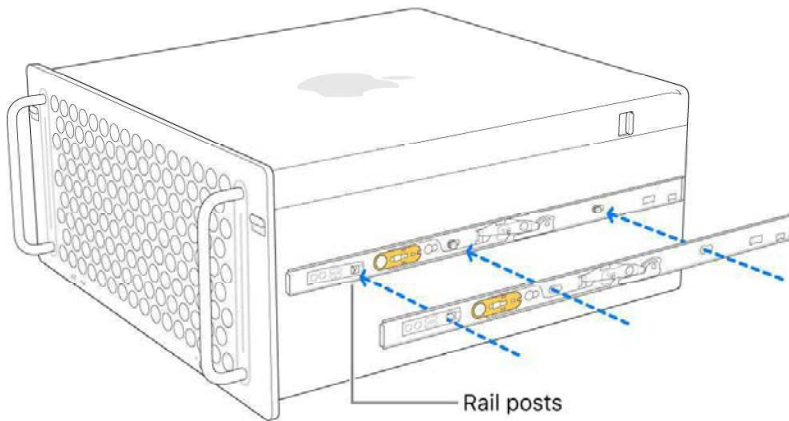

7. Slide the rail section forward until the spring lock engages the forward post.

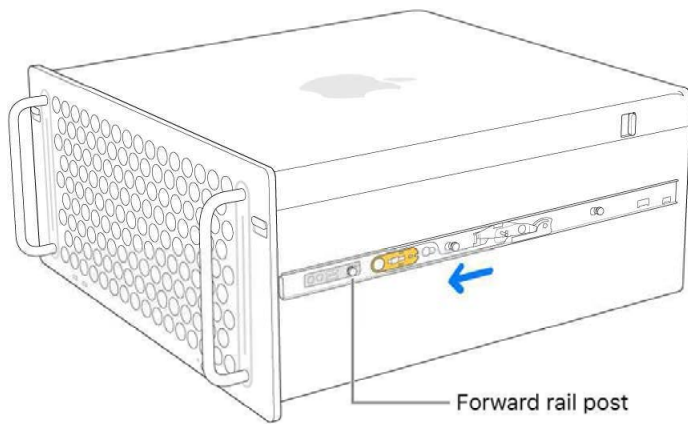

8. Slide out the middle rails on the rack.

9. Use two people to lift the computer.

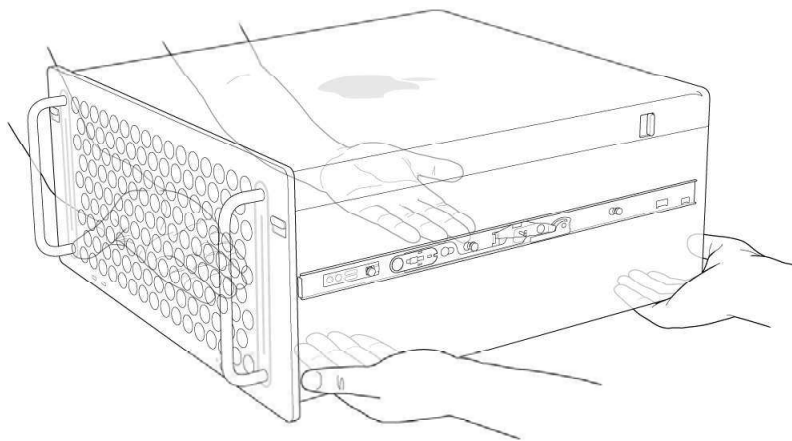

10. Align the rails attached to Mac Pro with the middle rails in the rack, then slide the computer into the rack.

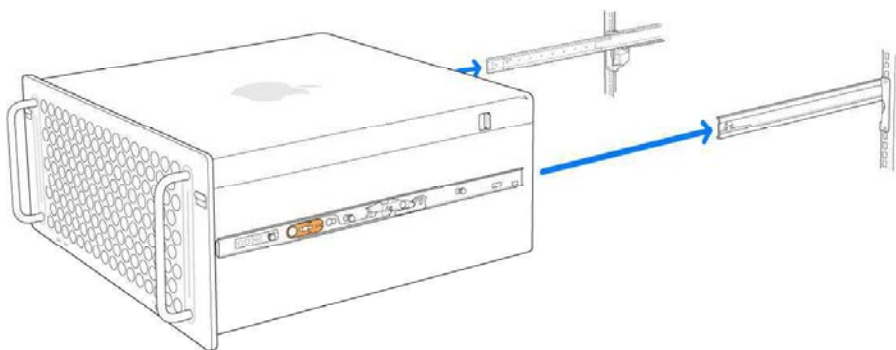

Remove Mac Pro from a rack

Follow these steps to remove Mac Pro from a rack.

Note: These instructions are for the Mac Pro rack workstation with Apple silicon. If you have an Intel-based Mac Pro rack workstation, see [Remove Mac Pro from a rack](#).

1. Move both locking latches down to the unlocked position.
2. Slide out the computer until it stops.

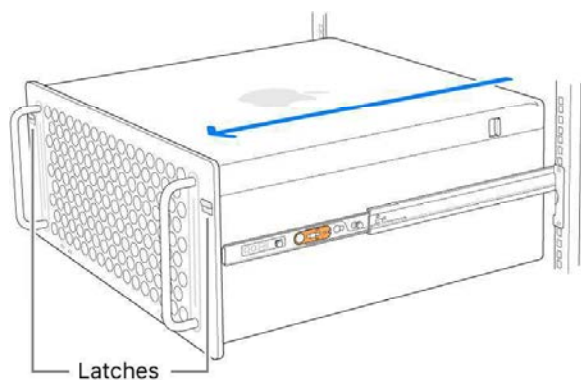

3. Use two people to safely hold Mac Pro.

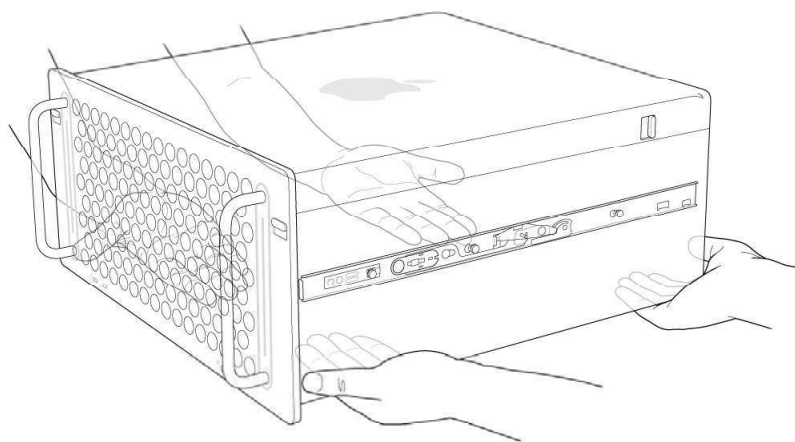

4. Pull the release latches on both rails, then remove Mac Pro from the rack.

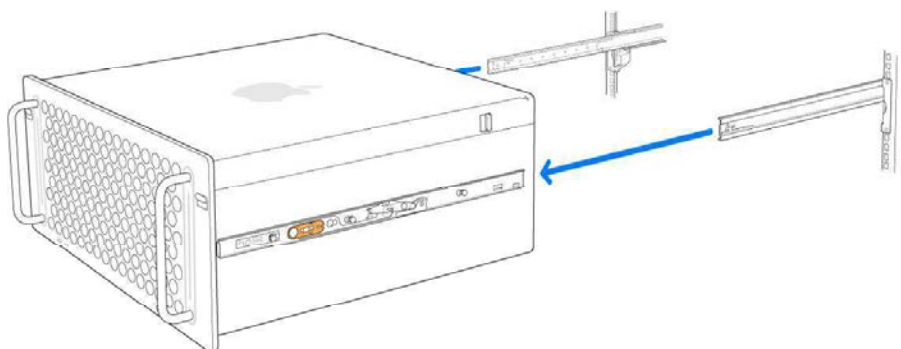

Note: You can detach the rails from the side of Mac Pro by pulling the spring latch forward, then sliding the rail back.

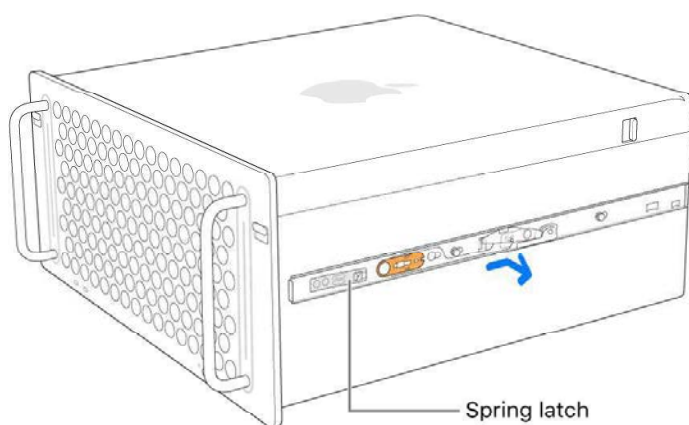

Remove Mac Pro rails from a rack

Follow these steps to remove Mac Pro rails from a rack.

Note: These instructions are for the Mac Pro rack workstation with Apple silicon. If you have an Intel-based Mac Pro rack workstation, see [Remove Mac Pro rails from a rack](#).

1. If the inner rail is extended, push down on the latch, then slide the rail in.

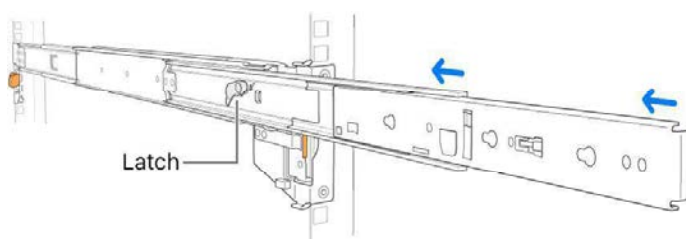

2. Push in the latch at the back of the rail, then push the assembly back to unhook the back pins.

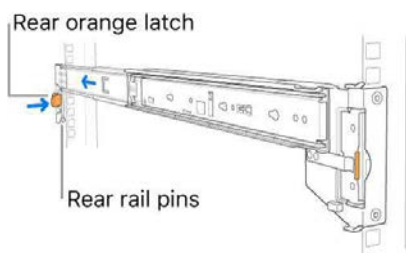

3. Push the latch at the front of the assembly to release the front pins, then lift the assembly out of the rack.

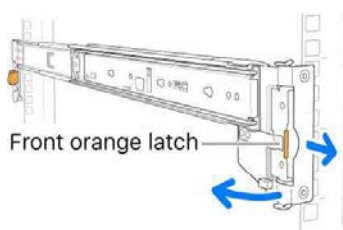

Customize your Mac Pro (Rack)

Configure your Mac Pro (Rack)

You can configure the expansion cards and SSD Modules in your Mac Pro. You can also use the internal USB-A port and internal SATA ports to connect accessories.

Note: These options are for the Mac Pro rack workstation with Apple silicon. If you have an Intel-based Mac Pro rack workstation, see [Configure your Mac Pro](#). If you have a Mac Pro tower workstation, see [Configure your Mac Pro](#).

Component	Configuration options*
PCI Express expansion cards	7 expansion slots
SSD Modules	1 TB (1 x 1 TB) 2 TB (1 x 2 TB) 4 TB (2 x 2 TB) 8 TB (2 x 4 TB)

WARNING: To avoid damaging internal components or the components you want to install, always turn off and then unplug your Mac Pro. Don't attempt to open the computer or install items while it's plugged in.

Your Mac Pro also has an internal USB-A port and 2 internal SATA ports. The internal USB-A port can be used to connect accessories and supports USB 3 and USB 2 devices at up to 5 Gbit/s. The internal SATA ports can support third-party accessories.

* Subject to availability.

Install Expansion Cards in Mac Pro (Rack)

You can configure your Mac Pro by installing additional cards in the PCI Express expansion slots.

All slots are connected through a PCI Express switch on the Mac Pro main logic board. PCI Express switch bandwidth is automatically configured through pool allocations. You can use the Expansion Slot Utility to manually configure pool allocations. For more information about the Expansion Slot Utility, see the Apple Support article [Install PCIe cards in your Mac Pro](#).

For optimal performance, use any slot that has at least as many lanes as the card in use. See the table below for details.

MPX Modules from the Intel-based Mac Pro are not supported in Mac Pro with Apple silicon.

Note: These options are for the Mac Pro rack workstation with Apple silicon. If you have an Intel-based Mac Pro rack workstation, see [Install Expansion Cards in Mac Pro](#). If you have a Mac Pro tower workstation, see [Install Expansion Cards in Mac Pro](#).

Slot	Number of lanes	PCI Express Support
Slot 7	x4 (Preinstalled with the Apple I/O card)	PCIe 3.0
Slot 6	x8	PCIe 4.0
Slot 5	x8	PCIe 4.0
Slot 4	x8	PCIe 4.0
Slot 3	x8	PCIe 4.0
Slot 2	x16	PCIe 4.0
Slot 1	x16	PCIe 4.0

Mac Pro has four double-wide slots and three single-wide slots, which can be customized with cards to expand Mac Pro capabilities. Slot 7 is preinstalled with the Apple I/O card, but this card can be removed in order to install other PCIe cards.

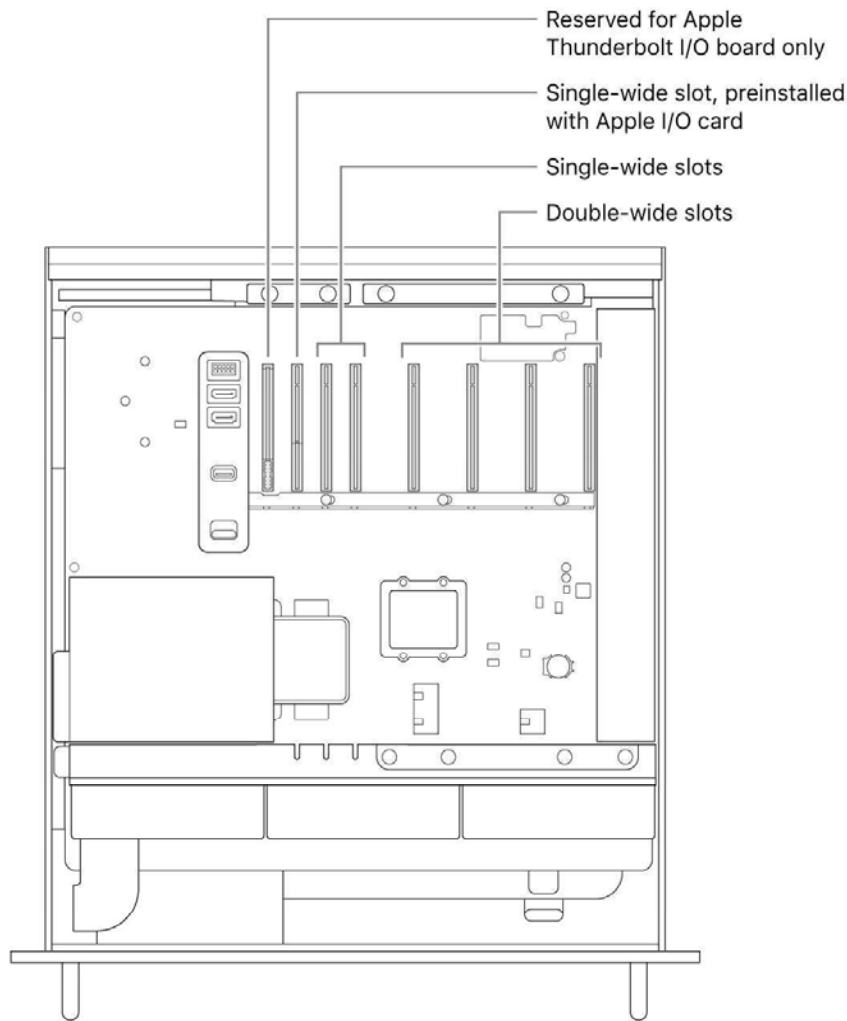

WARNING: For optimum ventilation, space cards out as you install them. If you remove a card and don't install a replacement, place a port access cover over the empty slot to keep foreign objects out of the enclosure. An uncovered slot may cause damage by affecting the airflow that cools the internal components.

Important: Connect cards to the appropriate power source, as illustrated below. Only use cables sold online at apple.com or at an Apple Store, or cables that come with compatible third-party PCIe cards.

Take care when connecting to the AUX connectors. When installing an accessory into your system that uses AUX power, first attach the AUX connector, then install the module. Be careful not to drop the module while connected to the AUX connector, as doing so may result in damage to the AUX connector or logic board. If the AUX connector becomes damaged, don't turn on your computer because doing so may further damage it. For more information about repairing your Mac Pro, see [Important safety information for your Mac](#).

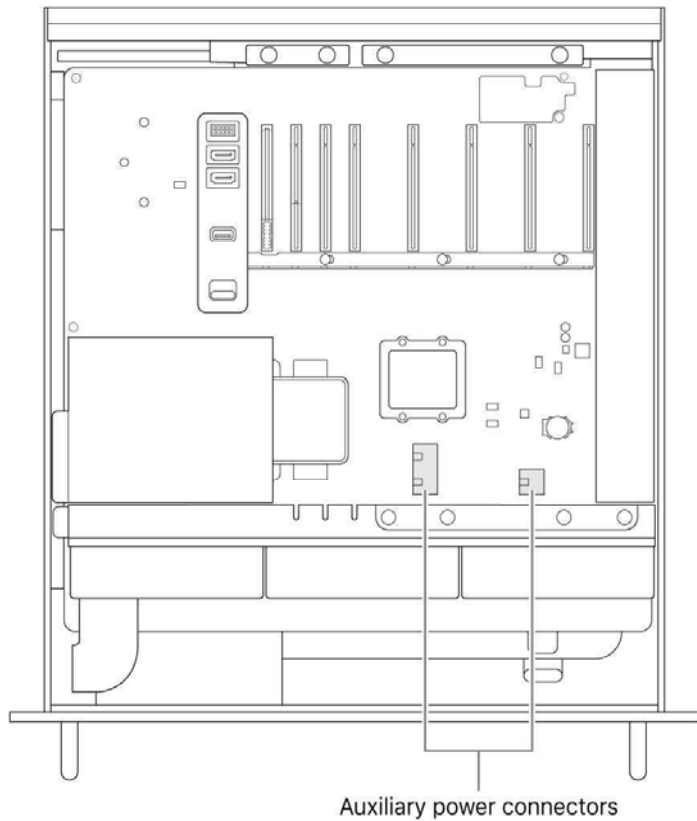

Follow these steps to install expansion cards in your Mac Pro.

1. Turn off your Mac Pro by choosing Apple menu  > Shut Down.

Let it cool down for 5 to 10 minutes before you touch the internal components, which may be hot.

2. Disconnect all cables except the power cord from your Mac Pro.
3. Touch the metal on the outside of your Mac Pro to discharge any static electricity.

Note: Always discharge static before you touch parts or install components inside your Mac Pro. To avoid generating static, don't walk around the room until you finish installing the expansion cards.

4. Disconnect the power cord.
5. Slide Mac Pro out of the rack.

Note: You can install expansion cards while Mac Pro remains installed in the rack.

6. Push in the latches on either side of the cover, then lift up the cover and slide it off the computer.

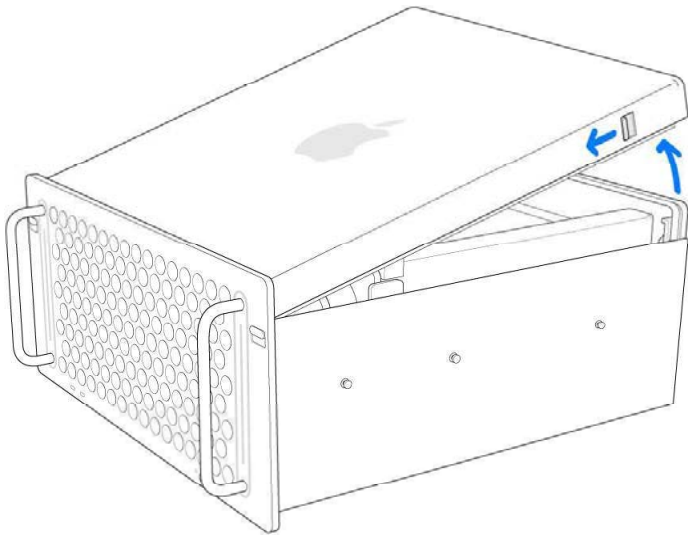

7. Remove the necessary side brackets.

- If you're installing a card into Slots 1, 2, 3, or 4, remove the side bracket on the bottom-right.
- If you're installing a card into Slot 5, 6, or 7, remove the side bracket on the top-right.
- If you're installing a full-length card, remove the left side bracket.

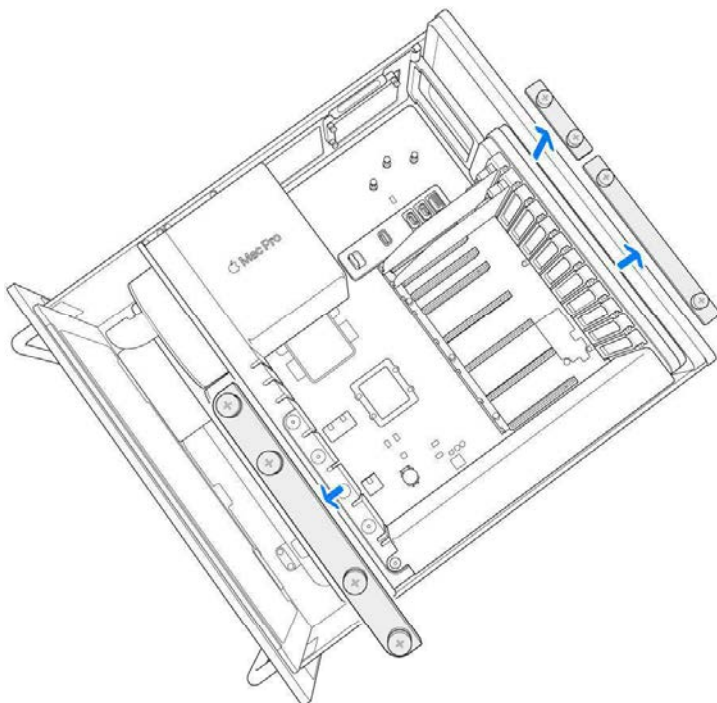

8. Remove the slot covers.

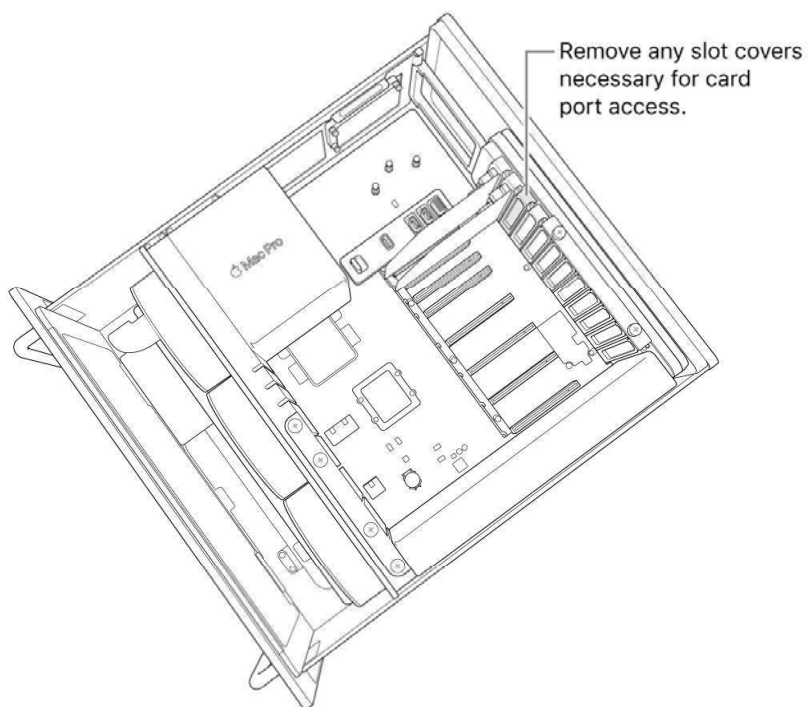

9. Slide the lock to the right.

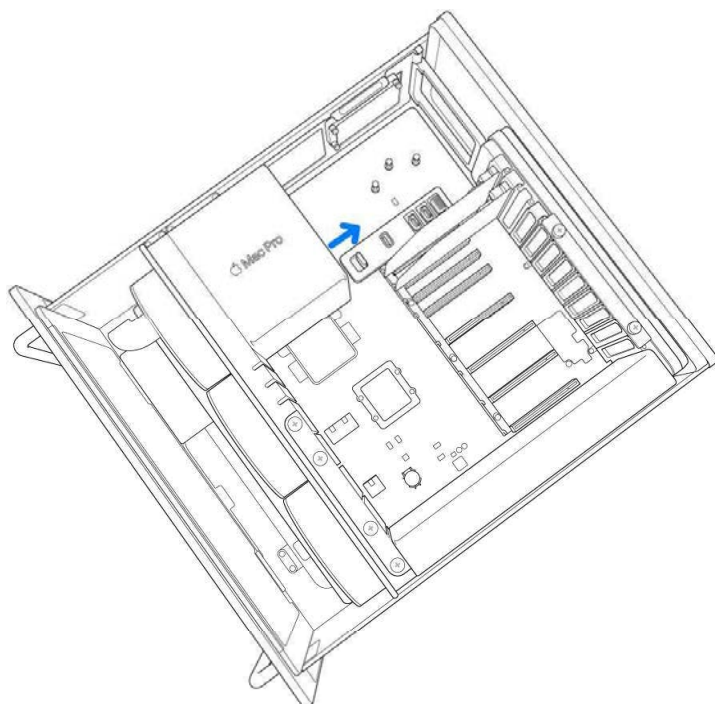

10. Remove the new card from its static-proof bag and hold it by its corners. Don't touch the gold connector or the components on the card.

Note: Use only PCIe modules that are safety certified (CSA, UL, or equivalent) and specifically state that they are compliant with the industry standard PCIe specification.

11. Slide the card into place.

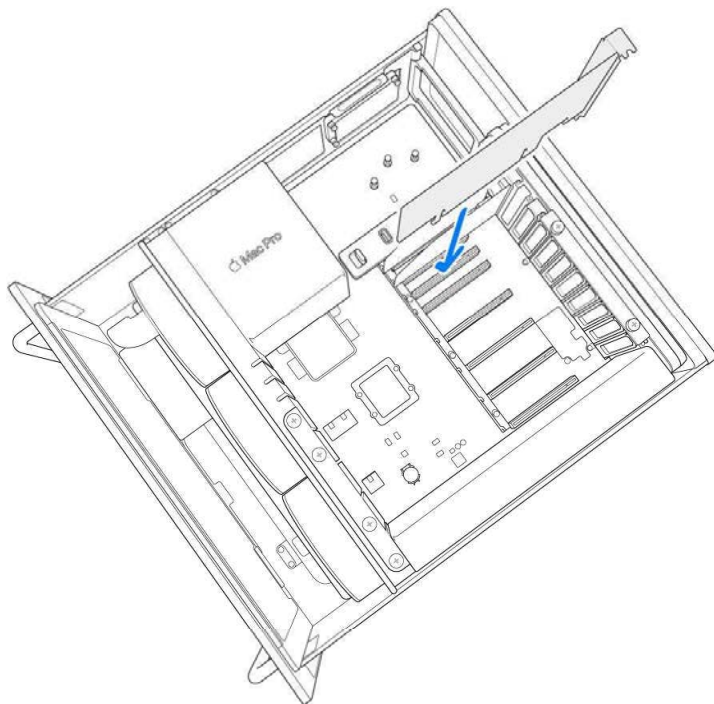

12. Slide the lock to the left.

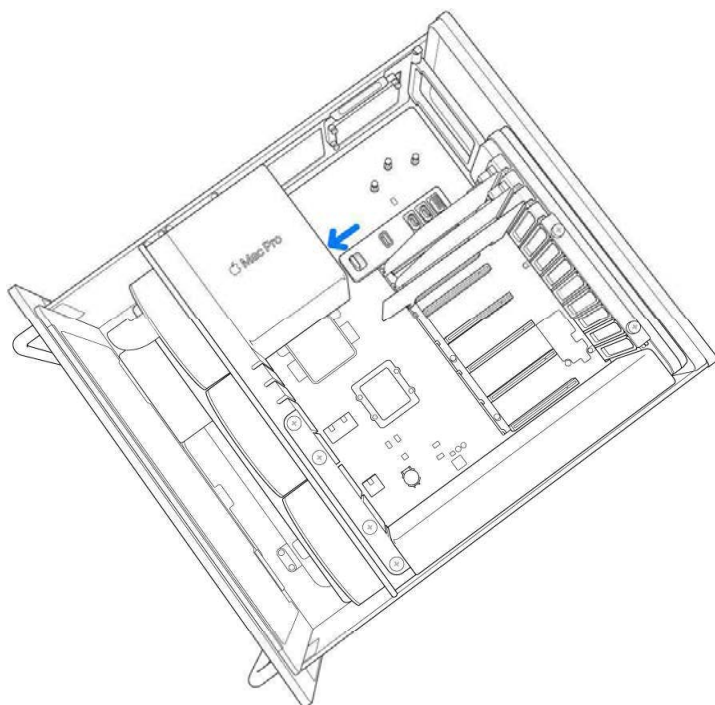

13. Reinstall the right side brackets. If you installed a full-length card and also removed the left side bracket, reinstall the left side bracket as well.

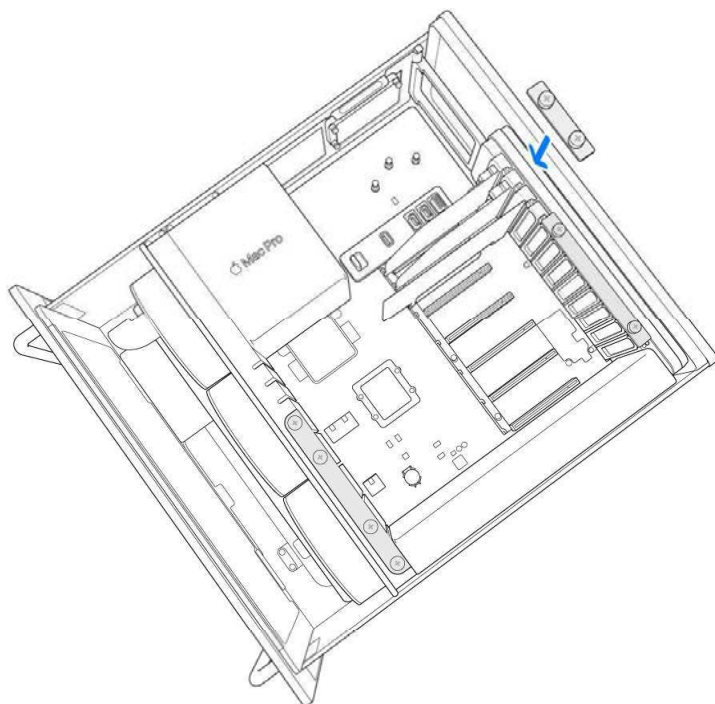

14. Reinstall the cover, making sure the latches lock.

Mac Pro can't start up until the cover has been reinstalled.

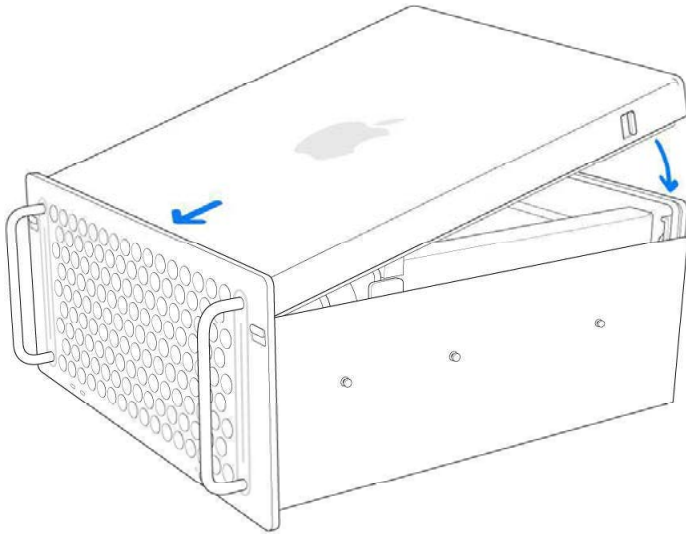

15. Reinstall Mac Pro back into the rack.
16. Reconnect all cables and the power cord to your Mac Pro.

Uninstall and install SSD modules in Mac Pro (Rack)

Follow these steps to uninstall and install SSD modules in your Mac Pro. To perform this process, you must have:

- Apple Configurator 2.12 or later installed on any Mac that supports macOS 12.4 or later, is plugged into a power source, and has internet access.

You may need to configure your web proxy or firewall ports to allow all network traffic from Apple devices to Apple's network 17.0.0.0/8. For more information on the ports used by Apple products, see the Apple Support article [Use Apple products on enterprise networks](#).

- A supported USB-C to USB-C charge cable

The USB-C cable must support both power and data. Thunderbolt 3 cables aren't supported.

- SSD modules that are compatible with the current Mac Pro.

Intel-based Mac Pro SSD modules are not compatible with the current Mac Pro.

WARNING: Make sure all data from the existing SSD has been backed up. The encrypted data on the original SSD modules is not readable by any other Mac. After a new SSD pairing operation has started, the data on the existing SSD is not recoverable or accessible to any system including the original Mac Pro they came from.

Note: These options are for the Mac Pro rack workstation with Apple silicon. If you have an Intel-based Mac Pro rack workstation, see [Uninstall and install SSD modules in Mac Pro](#). If you have a Mac Pro tower workstation, see [Uninstall and install SSD modules in Mac Pro](#).

1. Turn off your Mac Pro by choosing Apple menu  > Shut Down.

Let the computer cool down for 5 to 10 minutes before you touch the internal components, which may be hot.

2. Disconnect all cables except the power cord from your Mac Pro.
3. Touch the metal on the outside of your Mac Pro to discharge any static electricity.

Note: Always discharge static before you touch parts or install components inside your Mac Pro. To avoid generating static, don't walk around the room until you finish installing the expansion cards.

4. Disconnect the power cord.
5. Remove Mac Pro from the rack.
6. Place the computer on its back, on a nonscratch surface.

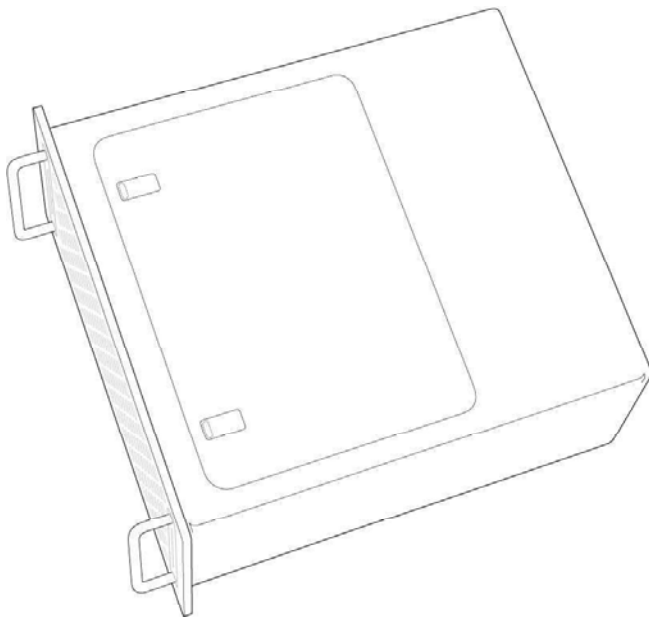

7. Push in the top of the latches, then pull the latches to remove the access panel.

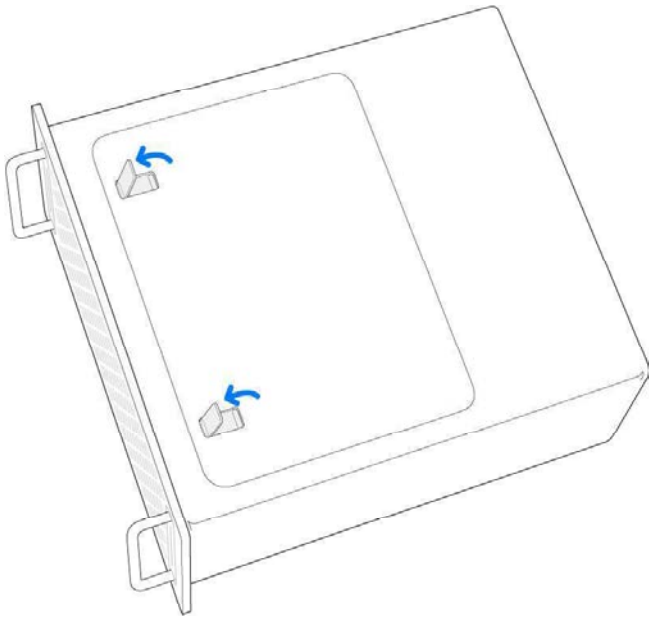

8. Remove the access panel.

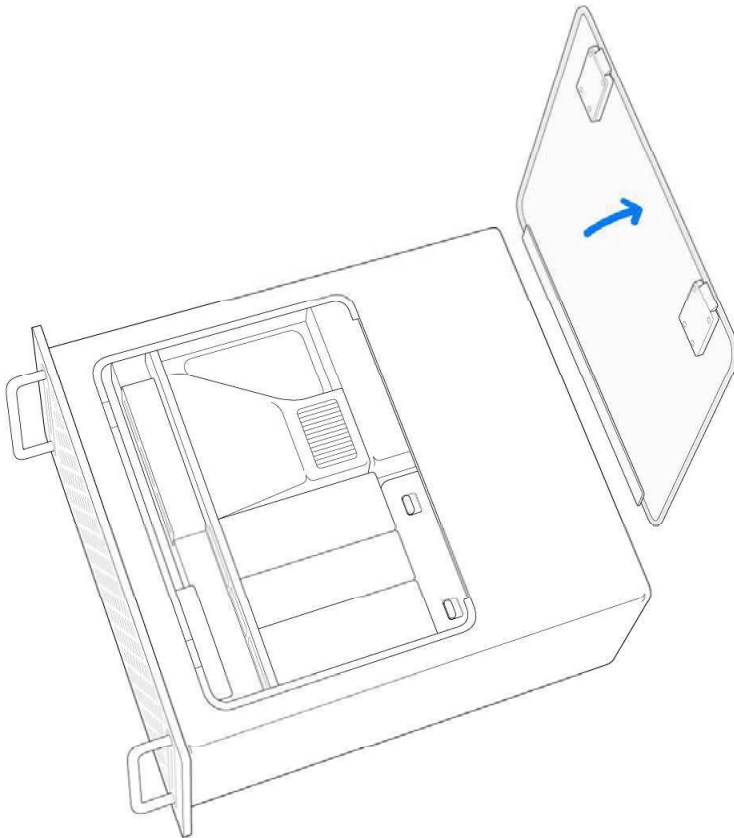

9. Slide the SSD module cover switch.

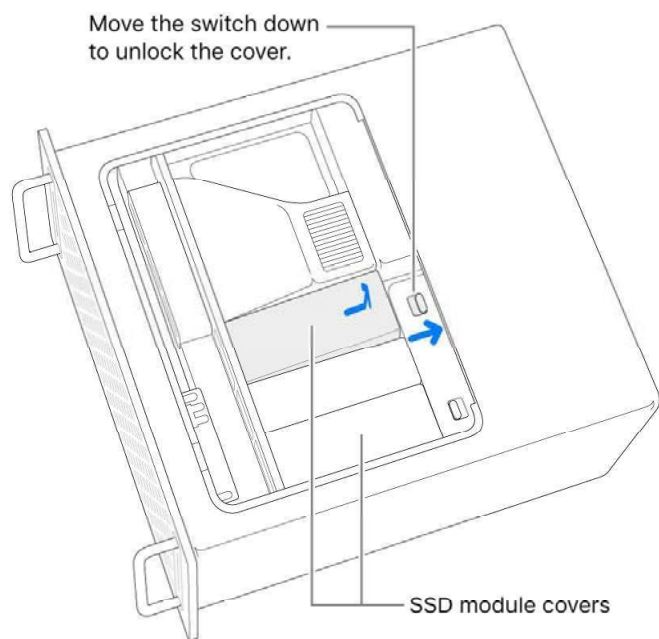

10. Remove the SSD module covers.

11. Use a T8 screwdriver to remove the two screws.

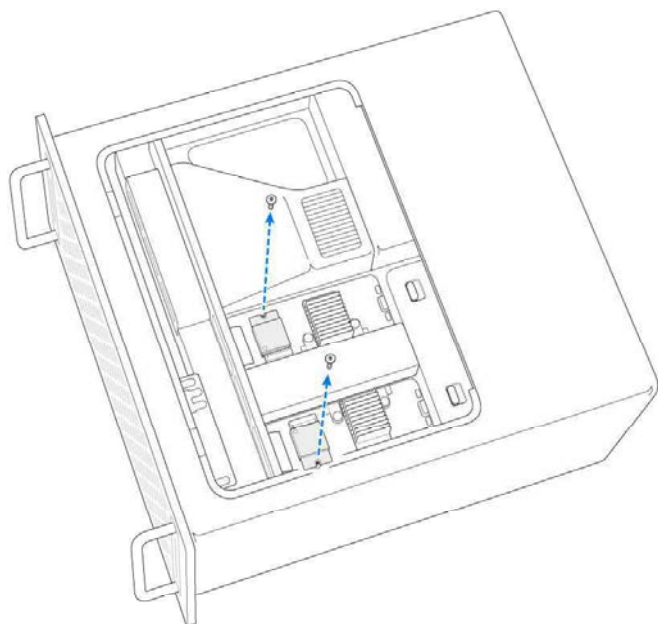

12. Pull an SSD module straight out. Repeat with the other module.

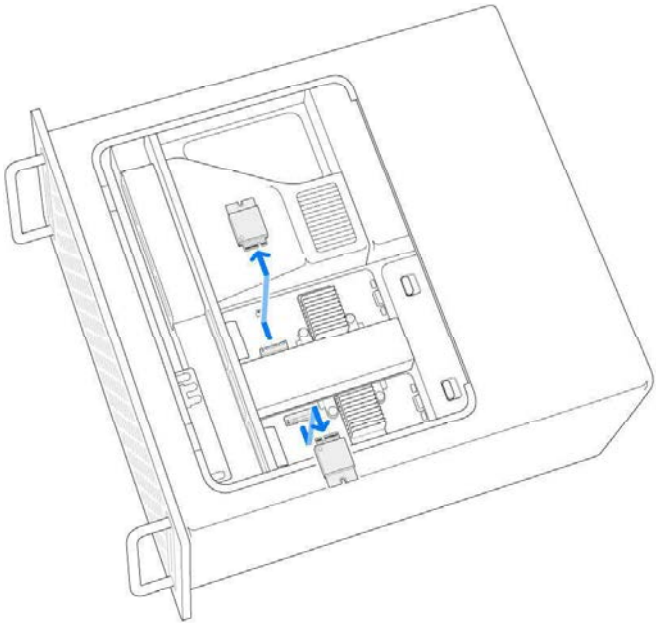

13. Slide the new modules into place, making sure to place each module in the correct socket.

Important: The modules are marked "1" and "2." The module marked "1" must be installed in the socket marked "1" and the module marked "2" must be installed in the socket marked "2."

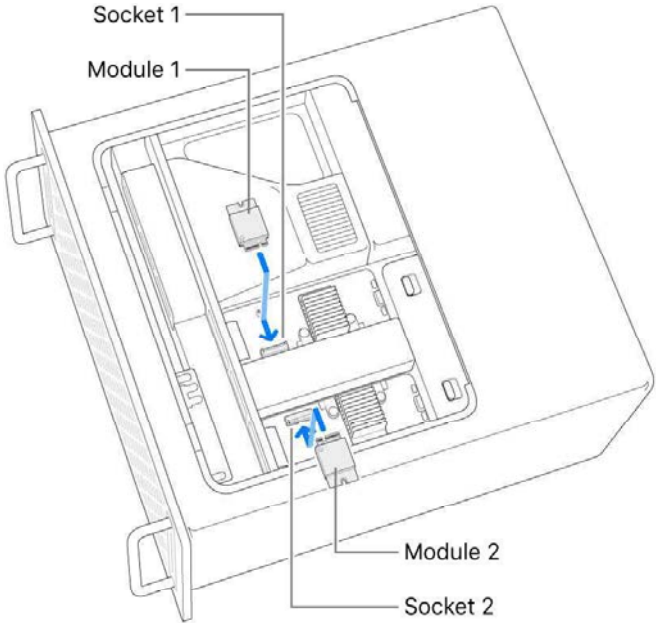

14. Use a T8 screwdriver to install the two screws that came with the new modules.

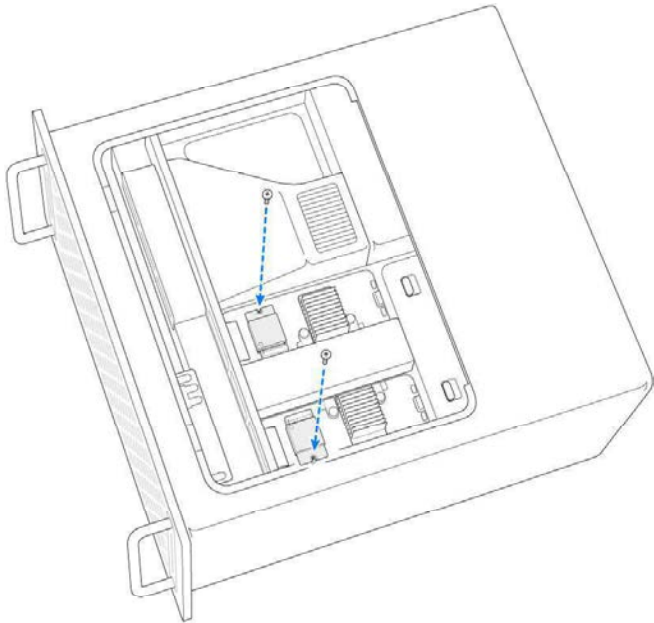

15. Reinstall the SSD module cover.

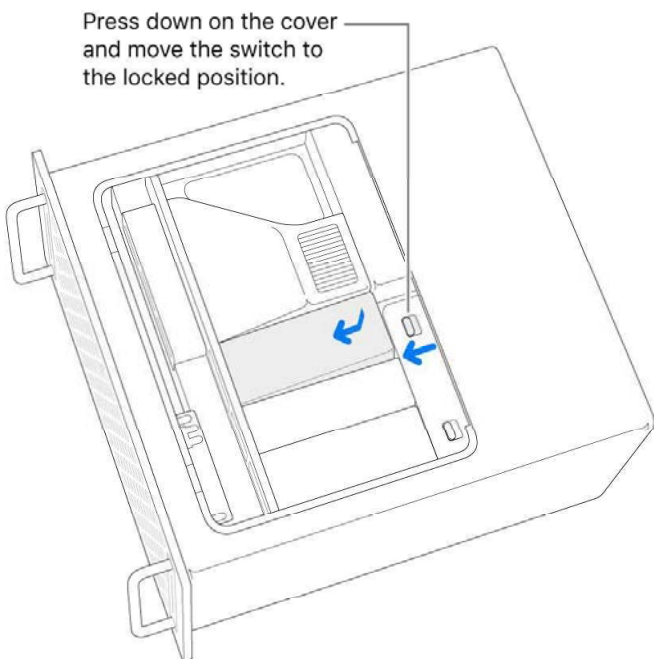

16. Reinstall the access panel.

Mac Pro can't start up until the access panel has been reinstalled.

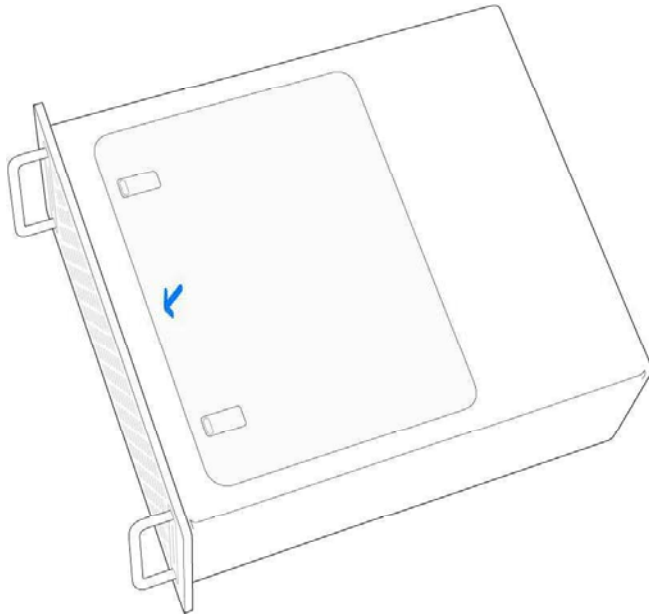

17. Reinstall Mac Pro in the rack.
18. Reconnect all cables, except the power cord, to your Mac Pro.
19. Plug in a monitor so you can see when the process of restoring the firmware is complete.
20. Plug the USB-C cable into the Thunderbolt port closest to the power button. Plug the other end of the cable into the Mac that you will use to restore Mac Pro.

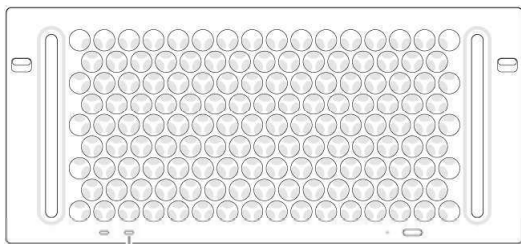

Thunderbolt 4 port

21. While holding down the power button, connect Mac Pro to power and continue to hold down the power button for about 3 seconds. The status indicator light turns solid amber.
Note: You won't see any screen activity from Mac Pro.
 22. To restore the firmware on Mac Pro, follow the steps outlined in [Revive or restore a Mac with Apple silicon](#) in the Apple Configurator User Guide.
-

Set up your Mac

Set up your Mac Pro

When you set up your new Mac Pro, you can customize certain settings for your Mac, set up features like Touch ID, and transfer data from another computer. If you already have a Mac, iPad, or iPhone, you may also have the option to skip several steps by using your existing settings in order to set up your new Mac more quickly.



If you need additional support while setting up your Mac, you can speak with an Apple expert by chat, email, on the phone, or set up an appointment at the Genius Bar. Learn more at [Genius Bar Reservation and Apple Support Options](#).

Setup Assistant walks you through the settings needed to start using your Mac. When setup is complete, see [When you're done setting up your Mac Pro](#) for next steps.

If you'd like to walk through each step of the process, choose a link below.

- *If you're new to Mac:* See [Set up your Mac Pro for new Mac users](#).
- *If you're already a Mac user:* See [Set up your Mac Pro for current Mac users](#).

Set up your Mac Pro for new Mac users

This walk-through covers each step of the set up process and is intended to be used alongside Setup Assistant.

 **Tip:** Some steps may require you to scroll to select an option. If you have a Magic Mouse or Magic Trackpad and you're not sure how to scroll on a Mac, just slide two fingers up and down on your trackpad. If you'd like to adjust gestures later, learn how to do so with [Magic Mouse](#) or [Magic Trackpad](#).

Before you begin

- If you have an iPhone or iPad, keep these close at hand during setup, since some steps may require verification on another device.
- Connect a display to your Mac Pro. Consult the documentation that came with your display to understand what port and cable you need to use. For more information, see [Connect a display to Mac Pro](#).
- You have the opportunity to transfer data from another computer, like a Windows PC, during setup. If you want to do this, make sure that you have the computer that you want to transfer data from, and that it is updated to the latest available software version.
- Setup Assistant makes setting up your Mac Pro easy and shouldn't take too long to complete. If you choose to transfer data, however, set aside additional time.

Connect a mouse or trackpad and keyboard

At the beginning of setup, you can connect a mouse or trackpad and keyboard to your Mac Pro.

If your new Mac came with a Magic Mouse, Magic Trackpad, or Magic Keyboard, they should already be paired. Turn on your Magic Mouse, Magic Trackpad, or Magic Keyboard by sliding the on/off switch so that the green is visible.

If you're using a mouse, trackpad, or keyboard that did not come with your new Mac, you need to pair them. You may also use a cable to physically connect the accessory to your Mac. Consult the documentation that came with your accessory to learn how to pair or connect it.

If you have additional questions about connecting a mouse, trackpad, or keyboard during setup, see the Apple Support Article [If your keyboard or mouse won't connect during Mac setup](#).

Set your language, country or region, and connect to Wi-Fi

Choose your language. This sets the language for your Mac. To change the language later, open System Settings, click Language & Region in sidebar, then choose your options.

Set your country or region. This sets the format of dates, currencies, temperature, and more for your Mac. To change these settings later, open System Settings, click General in the sidebar, click Language & Region, then choose your options.

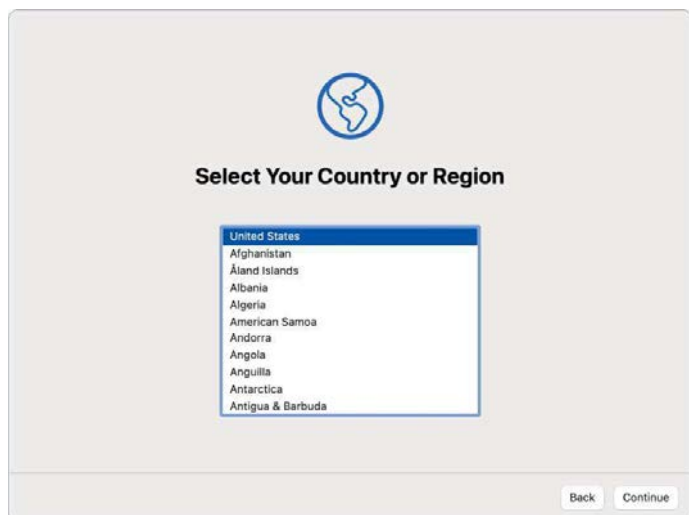

Turn on Accessibility features. View accessibility options for Vision, Motor, Hearing, and Cognitive abilities, or click Not Now. To learn more, see [Accessibility on your Mac](#).

Connect to a Wi-Fi network. Choose your Wi-Fi network and enter the password, if necessary. If you're using Ethernet, you can also click Other Network Options and follow the onscreen instructions.

To change the Wi-Fi network later, open System Settings, click Wi-Fi in the sidebar, then choose a network and enter the password, if necessary.

Transfer information from another computer

You can migrate your data—like files, contacts, accounts, and more—from a Windows PC to your new Mac. If you have another Mac you'd like to transfer from, see [Transfer information from another Mac](#). You can either transfer the data wirelessly, or you can connect your Windows PC to your Mac Pro with an Ethernet cable.

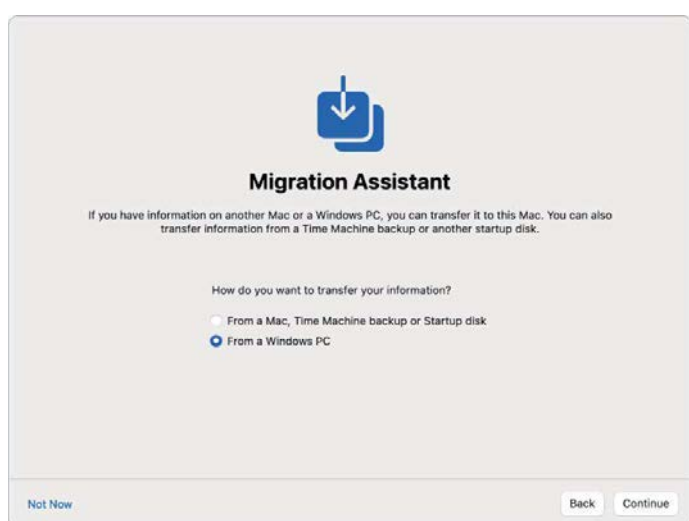

Before you begin. Ensure that your Windows PC is updated to the latest available software version. Then download Migration Assistant on your Windows PC. To download the right Migration Assistant for your operating system, and to learn more about this process, see [Transfer from PC to Mac with Migration Assistant](#).

Transfer data wirelessly. Your Windows PC and your new Mac must be on the same Wi-Fi network. Click your Windows PC on the setup screen and follow the instructions.

Transfer data using an Ethernet cable. Directly connect your Windows PC to your Mac Pro by using an Ethernet cable. After you connect them, click your Windows PC on the setup screen and follow the instructions.

Transfer data later. You may also choose to not transfer data at this time. If so, click Not Now in the Migration Assistant Window. To transfer data after setup, see [Set up your Mac Pro](#).

Sign in with Apple ID and set up your computer account

Sign in with your Apple ID. If you already have another Apple device, like an iPhone or iPad, you likely have an Apple ID. If you don't have an Apple ID, you can create one now (it's free).

Your Apple ID consists of an email address and a password. It's the account you use for everything you do with Apple—including using the App Store, Apple TV app, iCloud, and more. Your Apple ID is not the same as the username and password you use to sign into your Mac computer account. To learn more, see [Apple ID on Mac](#).

 **Tip:** It's best to have your own Apple ID and not share it.

On this screen, do any of the following:

- *If you have an Apple ID:* Enter your email address and password for your Apple ID. If you have an iPhone or iPad, a verification code is sent to this device. If you don't have an iPhone or iPad, a verification code is texted to the phone number associated with your Apple ID. If you don't receive the verification code or you don't receive the text, follow the onscreen prompts.
- *If you don't have an Apple ID:* Click "Create new Apple ID."
- *If you have forgotten your Apple ID or password:* Click "Forgot Apple ID or password."
- *If you don't want to sign in with or create an Apple ID at this time:* Click Set Up Later. After setup, you can sign in with an Apple ID or create a new Apple ID. Open System Settings, then click "Sign in with your Apple ID" in the sidebar.

Note: After you've signed in with your Apple ID, read the terms and conditions. To accept, check the box, then click Agree and proceed.

Create a computer account. Add your name, then create an account name and password, which can later be used to unlock your Mac Pro or approve other actions. You can add an optional hint to help retrieve your computer account's password if you forget it. To change your account's login picture, click it, then choose an option.

Create a Computer Account

Fill out the following information to create your computer account.

Full name: Ashley Rico

Account name: ashleyrico
This will be the name of your home folder.

Password: new password verify

Hint: optional

Allow my Apple ID to reset this password

Back Continue

Note: Your computer account is not the same as your Apple ID, though if you ever forget the password to unlock your Mac, you can use your Apple ID to reset the password if you check this option during setup.

Make this your new Mac

If you've already set up another device with iOS 15 or later or iPadOS 15 or later, a screen appears for express setup, Make This Your New Mac. If you don't have an iPhone or iPad with the right software version, you do not see this step. (Not sure what software version is on your iPhone or iPad? See [Find the software version on your iPhone, iPad, or iPod.](#))

When you use Make This Your New Mac, you skip several of the setup steps by using the settings stored in your iCloud account. To use your current settings, click Continue. If you have paired a Magic Keyboard with Touch ID, the setup process jumps to [Set up Touch ID and Apple Pay](#). If you use your current settings and haven't paired a Magic Keyboard with Touch ID, the setup process is complete; see [When you're done setting up your Mac Pro](#).

If you want to customize your settings for your new Mac Pro, click Customize Settings and proceed to the next step.

Customize your Mac's privacy and security settings, turn on Screen Time, and more

Enable Location Services. Choose whether to allow apps like Maps to use your Mac's location. To change your Location Services settings later, open System Settings, click Privacy & Security in the sidebar, then click Location Services, and choose your options.

If you don't enable Location Services, next you see a screen to choose your time zone.

Share analytics with Apple and Developers. Choose whether to send diagnostics and data to Apple, and whether Apple can share crash and usage data with developers. To change these settings later, open System Settings, click Privacy & Security in the sidebar, click Analytics & Improvements (you may need to scroll), and choose options.

Set up Screen Time. Screen Time lets you see your daily and weekly usage of your Mac Pro, set limits on how long you can use certain apps, manage children's screen time, and more. To turn on, click Continue; otherwise click Set Up Later. If you choose to set up later, open System Settings and click Screen Time in the sidebar to choose your options. For more options and details, see [Screen Time on Mac](#).

Secure your data with FileVault. FileVault helps to keep your data secure. During setup, you can choose to turn on FileVault to protect your data, and you can choose to allow your iCloud account to unlock your disk if you forget your password. To learn more about FileVault and how to set it up later, see [Encrypt Mac data with FileVault](#).

Set up Touch ID and Apple Pay

Note: These steps appear if you have paired a Magic Keyboard with Touch ID.

Set up Touch ID. You can add a fingerprint to Touch ID (the top-right button on your keyboard) during setup, which you can use to unlock your Mac Pro, authorize purchases with Apple Pay, and sign into some third-party apps. Follow the onscreen instructions to set up Touch ID. To set up Touch ID later, or to add additional fingerprints, open System Settings, then click Touch ID & Password in the sidebar. To add a fingerprint, click + and follow the onscreen instructions.

To learn more, see [Use Touch ID on Mac](#) in the macOS User Guide.

Set up Apple Pay. If you set up Touch ID, you can set up Apple Pay and add a debit, credit, or store card that can be used to make purchases with Touch ID. Enter your card details and follow the onscreen prompts. If you already use a card for media purchases, you might be prompted to verify this card first.

To set up Apple Pay or add additional cards later, open System Settings, then click Wallet & Apple Pay. Follow the onscreen prompts to set up Apple Pay.

Note: The card issuer determines whether your card is eligible to use with Apple Pay, and may ask you to provide additional information to complete the verification process. Many credit and debit cards can be used with Apple Pay. For information about Apple Pay availability and current credit card issuers, see the Apple Support article [Apple Pay participating banks](#).

Set desktop appearance

Choose your look. Select Light, Dark, or Auto for your desktop appearance. Later, if you want to change the choice you made during setup, open System Settings, click Appearance, then select an option. You can also set other appearance settings, such as highlight color or sidebar icon size. If you choose to do express setup with Make This Your New Mac, you skip this step.

Note: If you choose to do express setup with Make This Your New Mac, you skip this step.

Setup is complete

Your new Mac Pro is ready to go. See [When you're done setting up your Mac Pro](#) for next steps.

Set up your Mac Pro for current Mac users

This walk-through covers each step of the setup process and is intended to be used alongside Setup Assistant.

Before you begin

- Keep your other Mac, or your iPhone or iPad, close at hand during setup, since some steps may require verification on another device.
- Connect a display to your Mac Pro. Consult the documentation that came with your display to understand what port and cable you need to use. For more information, see [Connect a display to Mac Pro](#).
- You have the opportunity to transfer data from another Mac during setup. If you want to do this, make sure that you have the computer that you want to transfer data from, and that it is updated to the latest available software version.
- Setup Assistant makes setting up your Mac Pro easy and shouldn't take too long to complete. If you choose to transfer data, however, set aside additional time.

Connect a mouse or trackpad and keyboard

At the beginning of setup, you can connect a mouse or trackpad and keyboard to your Mac Pro.

If your new Mac came with a Magic Mouse, Magic Trackpad, or Magic Keyboard, they should already be paired. Turn on your Magic Mouse, Magic Trackpad, or Magic Keyboard by sliding the on/off switch so that the green is visible.

If you're using a mouse, trackpad, or keyboard that did not come with your new Mac, you need to pair them. You may also use a cable to physically connect the accessory to your Mac. Consult the documentation that came with your accessory to learn how to pair or connect it.

If you have additional questions about connecting a mouse, trackpad, or keyboard during setup, see the Apple Support Article [If your keyboard or mouse won't connect during Mac setup](#).

Set your language, country or region, and connect to Wi-Fi

Choose your language. This sets the language for your Mac. To change the language later, open System Settings, click Language & Region in sidebar, then choose your options.

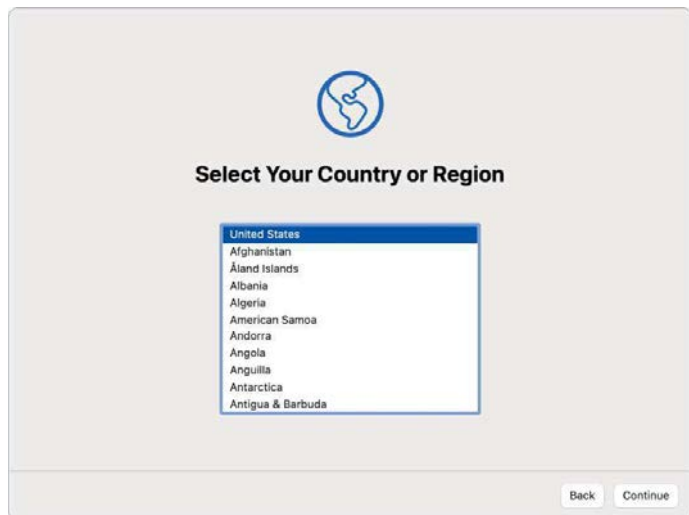

Set your country or region. This sets the format of dates, currencies, temperature, and more for your Mac. To change these settings later, open System Settings, click General in the sidebar, click Language & Region, then choose your options.



Turn on Accessibility features. View accessibility options for Vision, Motor, Hearing, and Cognitive abilities, or click Not Now. To learn more, see [Accessibility on your Mac](#).

Connect to a Wi-Fi network. Choose your Wi-Fi network and enter the password, if necessary. If you're using Ethernet, you can also click Other Network Options and follow the onscreen instructions.

To change the Wi-Fi network later, click the Wi-Fi status icon  in the menu bar, or open System Settings, click Wi-Fi in the sidebar, then choose a network and enter the password, if necessary.

 **Tip:** After setup, if you don't see the Wi-Fi status icon  in the menu bar, you can add it. Open System Settings, click Control Center in the sidebar, then select "Show in Menu Bar" for Wi-Fi.

Transfer information from another Mac

You can migrate your data—like files, contacts, accounts, and more—from another Mac to your new Mac Pro. You may also choose to transfer information from a Time Machine backup or a startup disk located on your Mac. When transferring from another Mac, you can either transfer the data wirelessly, or you can connect your Mac to your new Mac Pro with an Ethernet cable.

If you're restoring your Mac, see [Restore your Mac from a back up](#).

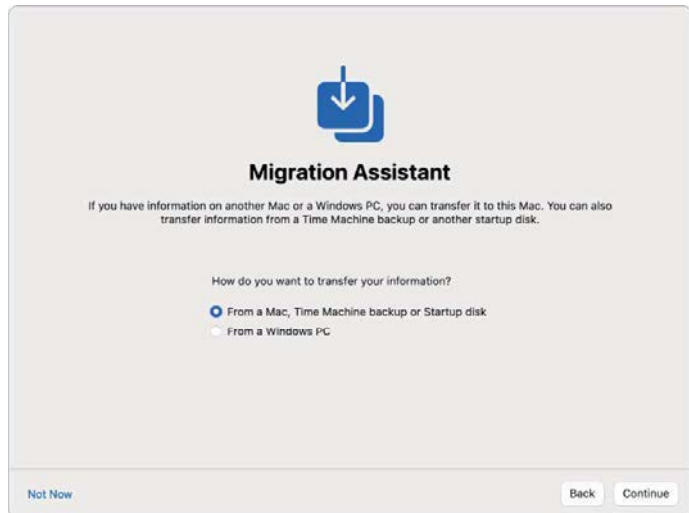

Before you begin. Ensure that the other Mac is updated to the latest available software version. Then open Migration Assistant on the Mac that you are transferring from. Migration Assistant is located in the Utilities folder of the Applications folder.

Transfer data wirelessly. Transfer information wirelessly from another Mac to your new Mac, if both computers are near each other. Click your other Mac on the setup screen, and follow the instructions.

Transfer data using an Ethernet cable. Directly connect your Mac Pro to the other Mac by using an Ethernet cable. After they are connected, click your other Mac on the setup screen and follow the instructions.

Transfer data later. You may also choose to not transfer data at this time. If so, click Not Now in the Migration Assistant Window. To transfer data after setup, see [Transfer your data to your new Mac Pro](#).

Learn more. To learn more about this process, see [Transfer to a new Mac with Migration Assistant](#).

Sign in with Apple ID and set up your computer account

Sign in with your Apple ID. When you sign in with your Apple ID during setup, you receive a verification code on your other Apple devices. In order to proceed, enter the verification code on your new Mac Pro. If you don't receive the code, or don't have the device, you may choose to have the verification code sent to you by text or phone call. If you can't use the phone number associated with your Apple ID, choose "Can't use this number" and follow the onscreen instructions.

If you need to create an Apple ID, choose "Create new Apple ID." If you have forgotten your Apple ID or password, choose "Forgot Apple ID or password."

If you don't want to sign in with or create a new Apple ID now, click Set Up Later. After setup, you can sign in with an Apple ID or create a new Apple ID. Open System Settings, then click "Sign in with your Apple ID" in the sidebar.

Note: After you've signed in with your Apple ID, you must read and accept the terms and conditions. Then check the box, click Agree, and proceed.

Create a computer account. Add your name and create an account name and password, which can later be used to unlock your Mac Pro or approve other actions. You can add an optional hint to help retrieve your computer account's password if you forget it. To change your account's login picture, click it, then choose an option.

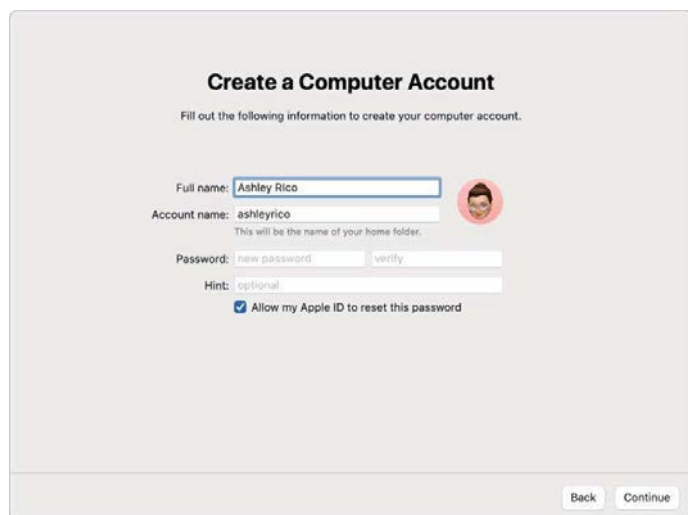

Create a Computer Account

Fill out the following information to create your computer account.

Full name: Ashley Rice

Account name: ashleyrico
This will be the name of your home folder.

Password: new password verify

Hint: optional

Allow my Apple ID to reset this password

Back Continue

Note: Your computer account is not the same as your Apple ID, though if you ever forget the password to unlock your Mac, you can use your Apple ID to reset the password if you check this option during setup.

Make this your new Mac

If you've already set up another device with macOS 12 or later, iOS 15 or later, or iPadOS 15 or later, a screen appears for express setup, Make This Your New Mac. If you don't have a Mac, iPad, or iPhone with the right software version, you don't see this step. (Not sure what software version is on your Mac, iPhone, or iPad? See [Find out which macOS your Mac is using](#) or [Find the software version on your iPhone, iPad, or iPod.](#))

When you use Make This Your New Mac, you skip several of the setup steps by using the settings stored in your iCloud account. To use your current settings, click Continue. If you have paired a Magic Keyboard with Touch ID, the setup process jumps to [Set up Touch ID and Apple Pay](#). If you use your current settings and haven't paired a Magic Keyboard with Touch ID, the setup process is complete; see [When you're done setting up your Mac Pro](#).

If you want to customize your settings for your new Mac Pro, click Customize Settings and proceed to the next step.

Customize your Mac's privacy and security settings, turn on Screen Time, and more

Enable Location Services. Choose whether to allow apps like Maps to use your Mac's location. To change your Location Services settings later, open System Settings, click Privacy & Security in the sidebar, then click Location Services, and choose your options.

If you don't choose to enable location services, next you see a screen to choose your time zone.

Share analytics with Apple and Developers. Choose whether to send diagnostics and data to Apple, and whether Apple can share crash and usage data with developers. To change these settings later, open System Settings, click Privacy & Security in the sidebar, click Analytics & Improvements (you may need to scroll), and choose options.

Set up Screen Time. Screen Time lets you see your daily and weekly usage of your Mac Pro, set limits on how long you can use certain apps, manage children's screen time, and more. To turn on Screen Time, click Continue; otherwise click Set Up Later. If you choose to set up later, open System Settings and click Screen Time in the sidebar to choose your options. For more options and details, see [Screen Time on Mac](#).

Secure your data with FileVault. FileVault helps to keep your data secure. During setup, you can choose to turn on FileVault to protect your data, and you can choose to allow your iCloud account to unlock your disk if you forget your password. To learn more about FileVault, and how to set it up later if you choose to not set up now, see [Encrypt Mac data with FileVault](#).

Set up Touch ID and Apple Pay

Note: These steps appear if you have paired a Magic Keyboard with Touch ID.

Set up Touch ID. You can add a fingerprint to Touch ID, which you can use to unlock your Mac Pro, authorize purchases with Apple Pay, and sign into some third-party apps. Follow the onscreen instructions to set up Touch ID. To set up Touch ID later, or to add additional fingerprints, open System Settings, then click Touch ID & Password in the sidebar. To add a fingerprint, click + and follow the onscreen instructions.

To learn more, see [Use Touch ID on Mac](#) in the macOS User Guide.

Set up Apple Pay. If you set up Touch ID, you can set up Apple Pay and add a debit, credit, or store card that can be used to make purchases with Touch ID. Enter your card details and follow the onscreen prompts. If you already use a card for media purchases, you might be prompted to verify this card first.

To set up Apple Pay later or to add additional cards, open System Settings, then click Wallet & Apple Pay. Follow the onscreen prompts to set up Apple Pay.

Note: The card issuer determines whether your card is eligible to use with Apple Pay, and may ask you to provide additional information to complete the verification process. Many credit and debit cards can be used with Apple Pay. For information about Apple Pay availability and current credit card issuers, see the Apple Support article [Apple Pay participating banks](#).

Set desktop appearance

Choose your look. Select Light, Dark, or Auto for your desktop appearance. Later, if you want to change the choice you made during setup, open System Settings, click Appearance, then select an option. You can also set other appearance settings, such as highlight color or sidebar icon size.

Note: If you choose to do express setup with Make This Your New Mac, you skip this step.

Setup is complete

Your new Mac Pro is ready to go. See [When you're done setting up your Mac Pro](#) for next steps.

When you're done setting up your Mac Pro

After you're done setting up your Mac Pro, you can now start making it yours. Start to personalize your Mac by [setting up email](#) and [calendar accounts](#), adjusting text display by [making text and other items on the screen bigger](#), or [customizing the desktop picture on your Mac](#). Learn how to seamlessly use your Mac Pro with other Apple devices with [iCloud and Continuity](#). If you're interested in apps, learn more about the [Apps on your Mac Pro](#) or how to install new apps, including iPhone and iPad apps that you have previously purchased, on your Mac with [App Store](#). (Note that many, but not all, iPhone and iPad apps are available on Mac.)

If you're new to Mac, see [Are you new to Mac?](#) to learn some helpful tips. You may also find [What's it called on my Mac?](#) in the macOS User Guide and the Apple Support article [Mac tips for Windows switchers](#) useful. Whether you're new to Mac or looking for a refresher on macOS, learn more about getting started with your Mac and explore the [Desktop and menu bar](#), [Finder](#), [Dock](#), [Control Center](#), and more.

 **Tip:** Check out Tips for your Mac. Open Finder, click Help in the Menu bar, then choose "Tips for your Mac."

Finally, you can get to know your new Mac Pro. Learn more about Mac Pro with [Take a tour of Mac Pro](#), [Configure your Mac Pro](#) with SSD Modules or expansion cards, and get to know your [Magic Keyboard with Touch ID and Numeric Keypad](#) and [Magic Mouse](#) or [Magic Trackpad](#). You can also learn how to [Connect a display](#) or [Connect Bluetooth accessories](#)..

Get started

Apple ID on Mac

Your Apple ID is an account that lets you access all Apple services. Use your Apple ID to download apps from the App Store; access media in Apple Music, Apple Podcasts, Apple TV, and Apple Books; keep your content up to date across devices using iCloud; set up a Family Sharing group; and more.

You can also use your Apple ID to access other apps and websites (see [Use Sign in with Apple on Mac](#) in the macOS User Guide).

Important: If you forget your Apple ID password, you don't need to create a new Apple ID. Just click the "Forgot Apple ID or password?" link in the sign-in window to retrieve your password.

If other family members use Apple devices, make sure that each family member has their own Apple ID. You can create Apple ID accounts for your kids and share purchases and subscriptions with Family Sharing, described later in this section.

To view the services you can use with your Apple ID, see the Apple Support article [Where can I use my Apple ID?](#)

All in one place. Manage everything related to your Apple ID in the same place. Open System Settings on your Mac Pro—your Apple ID and Family Sharing settings are at the top of the sidebar. To sign in with Apple ID, if you haven't already, click "Sign in with your Apple ID" at the top of the sidebar.

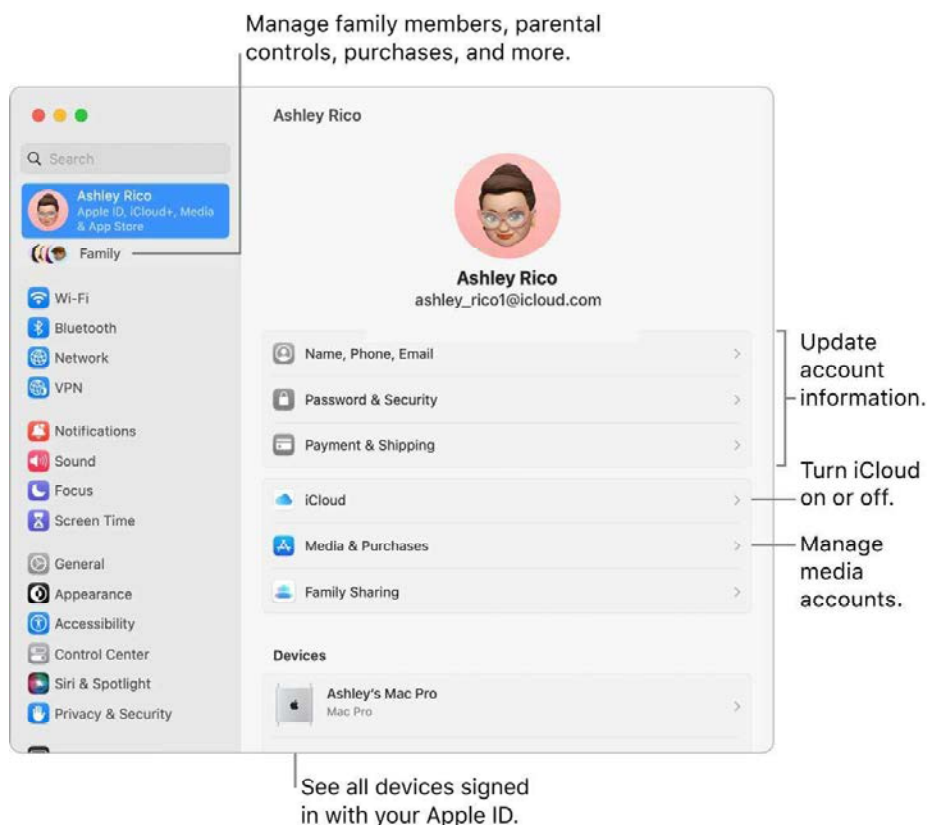

Update account, security, and payment information. In System Settings, click your Apple ID in the sidebar, then select an item to review and update the information associated with your account.

- **Overview:** Lets you know if your account is set up and working properly—if not, you see tips and notifications here.
- **Name, Phone, Email:** Update the name and contact information associated with your Apple ID. You can also manage Apple email newsletter subscriptions.
- **Password & Security:** Change your Apple ID password, turn on two-factor authentication, add or remove trusted phone numbers, and generate verification codes to sign in to another device or [iCloud.com](#). You can also manage which apps and websites use "Sign in with Apple." See [Use Sign in with Apple](#) in the macOS User Guide.

- *Payment & Shipping*: Manage the payment methods associated with your Apple ID, and your shipping address for purchases from the Apple Store.
- *iCloud*: Click iCloud, then choose which iCloud features you want to turn on or off. When you turn on an iCloud feature, your content is stored in iCloud and not locally on your Mac, so you can access any content on any device with iCloud turned on and signed in with the same Apple ID.
- *Media & Purchases*: Manage the accounts linked to Apple Music, Apple Podcasts, Apple TV, and Apple Books; select purchasing settings; and manage your subscriptions.

See all your devices. See all the devices linked to your Apple ID. You can verify that Find My [*device*] is turned on for each one (see [Find My](#)), see the status of iCloud Backup for an iOS or iPadOS device, or remove a device from your account if you no longer own it.

Family Sharing. With Family Sharing, you can set up a family group for up to six members. Then you can share and manage purchases, share device locations, or mark devices as lost in Find My. You can also manage how your children use their devices by creating Apple ID accounts for your kids and set Screen Time limits (see [Screen Time on Mac](#)). To manage your family sharing settings, click Family in System Settings. To learn more, see the Apple Support article [Set up Family Sharing](#).

Share purchases and storage with Family Sharing. Up to six members of your family can share their purchases from the App Store, Apple TV app, Apple Books, and iTunes Store, and share the same storage plan—even if they each use their own iCloud account. You can pay for family purchases with one credit card, while approving your kids' spending right from your Mac Pro.

Account Recovery. Add one or more people you trust as a recovery contact or set up a recovery key to help you reset your password and regain access to your account. Click Password & Security, then click Manage for Account Recovery.

Legacy Contact. Designate one or more persons as Legacy Contacts so they can access your account and personal information after your death. Click Password & Security, then click Manage for Legacy Contact.

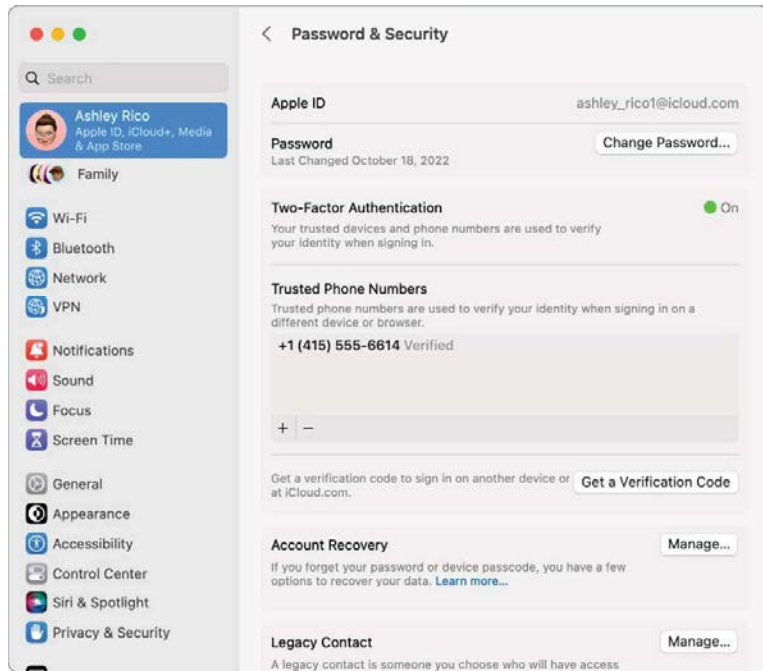

Learn more. To learn more about iCloud and Family Sharing, see [Access your iCloud content on your Mac Pro](#) and [Manage a Family Sharing group on Mac](#) in the macOS User Guide.

Find your way around



Desktop and menu bar on your Mac

The first thing you see on your Mac Pro is the *desktop*. The *menu bar* runs along the top of the screen, and the *dock* appears at bottom.





Tip: Can't find the pointer on the screen? To magnify it temporarily, slide the mouse back and forth quickly.

Desktop. The desktop is where you do your work—whether it's opening and using apps, working on files, searching your Mac Pro or the web with Spotlight, and more. To change your desktop picture, open System Settings, click Wallpaper in the sidebar, then choose an option. You can also store files on your desktop and keep them organized using stacks. To learn more about the desktop, see [Get to know the Mac desktop](#).

Menu bar. The menu bar runs along the top of the screen. Use the menus on the left side to choose commands and perform tasks in apps. The menu items change, depending on which app you're using. Use the icons on the right side to connect to a Wi-Fi network, check your Wi-Fi status , open Control Center , search using Spotlight , and more.

Tip: You can change the icons that appear in the menu bar. See [Control Center on your Mac](#).

Apple menu . The Apple menu contains frequently used commands and always appears in the upper-left corner of the screen. To open it, click the Apple icon .

App menu. You can have multiple apps and windows open at the same time. The name of the app that's active appears in bold to the right of the Apple menu , followed by that app's unique menus. If you open a different app or click an open window in a different app, the name of the app menu changes to that app and the menus in the menu bar change along with it. If you're looking for a command in a menu and can't find it, check the app menu to see if the app you want is active.

Help menu. Help for your Mac Pro is always available in the menu bar. To get help, open the Finder in the Dock, click the Help menu, and choose macOS Help to open the macOS User Guide. Or type in the search field and choose a suggestion. To get help for a specific app, open the app and click Help in the menu bar. See [Use the macOS User Guide](#).



Stay organized with stacks. You can gather files on the desktop into stacks to keep them organized in groups (by kind, date, or tag), and to keep your desktop orderly. To view what's inside a stack, click the stack to expand its contents, or place your pointer over a stack to view thumbnail images of the files. To create stacks on your desktop, click the desktop, then choose View > Use Stacks. To see grouping options for your stacks, go to View > Clean Up By and choose an option. Then any new files you add to the desktop are automatically sorted into the appropriate stack. To learn more, see [Use desktop stacks on Mac](#) in the macOS User Guide.

Learn more. See [Finder on your Mac](#) and [Dock on your Mac](#).

Finder on your Mac

Represented by the blue icon with the smiling face, the Finder is the home base for your Mac. You use it to organize and access almost everything on your Mac, including documents, images, movies, and any other files you have. To open a Finder window, click the Finder icon  in the Dock at the bottom of the screen.

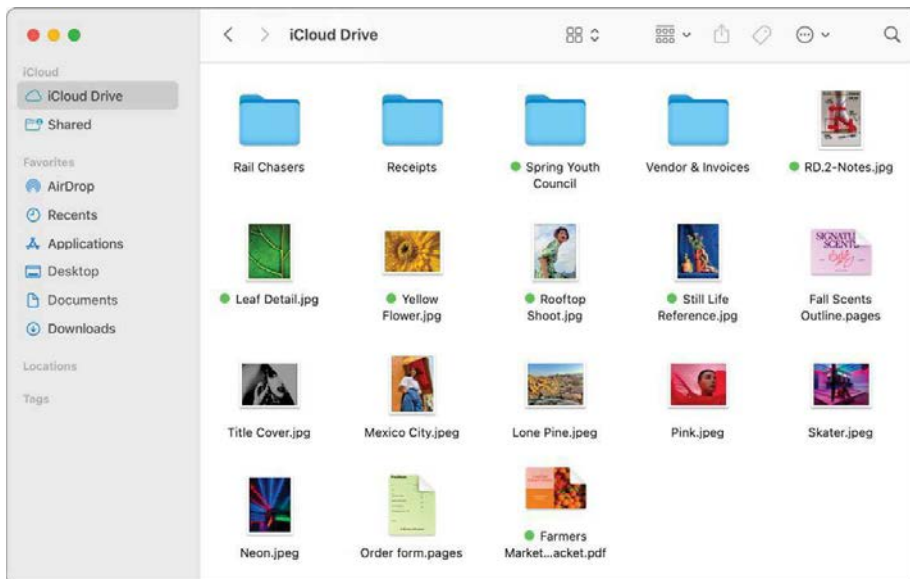

The Finder window. Click the pop-up menu button at the top of the Finder window to change how you view documents and folders. View them as icons, in a list, in hierarchical columns, or in a gallery. The sidebar on the left shows the items you use often or want to open quickly. To see all your documents stored on iCloud Drive, click the iCloud Drive folder in the sidebar. To see only the documents you're sharing and that are shared with you, click the Shared folder. To change what's shown in the sidebar, choose Finder > Settings.

Get organized. Your Mac has folders already created for common types of content—Documents, Pictures, Applications, Music, and more. As you create documents, install apps, and do other work, you can create new folders to stay organized. To create a new folder, choose File > New Folder. See [Organize files in folders](#) in the macOS User Guide.

Sync devices. When you connect a device like an iPhone or iPad, it appears in the Finder sidebar. Click the device’s name to see options to back up, update, sync, and restore your device.

Gallery View. With Gallery View, you can see a large preview of your selected file, so you can visually identify your images, video clips, and other documents. The Preview pane on the right shows information to help you identify the file you want. Use the scrubber bar at the bottom to quickly locate what you’re looking for. To close or open the Preview pane, press Shift-Command-P. To show the Preview pane options in the Finder, choose View > Show Preview. To customize what’s shown, choose View > Show Preview Options, then select the options for your file type.

 **Tip:** To show filenames in Gallery View, press Command-J and select “Show filename.”

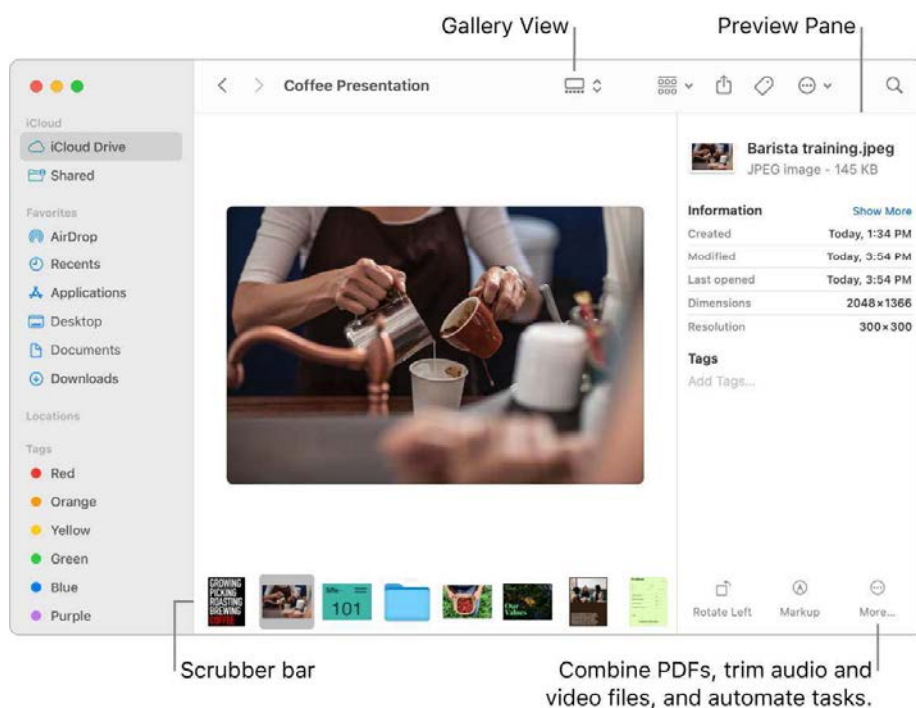

Quick Actions. In Gallery View, click the More button  at the bottom right of the Finder window for shortcuts to manage and edit files directly in the Finder. You can rotate an image, annotate or crop an image in Markup, combine images and PDFs into a single file, trim audio and video files, run shortcuts created with the Shortcuts app, and create custom actions through Automator workflows (for example, watermarking a file). See [Perform quick actions in the Finder on Mac](#) in the macOS User Guide.

Quick Look. Select a file and press the Space bar to open Quick Look. Use the buttons at the top of the Quick Look window to sign PDFs; trim audio and video files; and mark up, rotate, and crop images without opening a separate app. To learn more about Quick Look and markup features, see [View and edit files with Quick Look on Mac](#) and [Mark up files on Mac](#) in the macOS User Guide.



Tip: You can add alternative image descriptions that can be read by VoiceOver using Markup in Preview or Quick Look.

Get there faster. The Go menu in the menu bar is a quick way to get to folders and locations. Instead of using several clicks to navigate to the Utilities folder, choose Go > Utilities. You can also choose Go > Enclosing Folder to return to the top level of nested folders. If you know the path to a specific folder, choose Go > Go to Folder, then type the path. See [Go directly to a specific folder](#) in the macOS User Guide.

Dock on your Mac

The Dock, at the bottom of the screen, is a convenient place to keep the apps and documents you use frequently.





Open an app or file. Click an app icon in the Dock, or click the Launchpad icon  in the Dock to see all the apps on your Mac, then click the app you want. You can also search for an app using Spotlight  (in the top-right corner of the menu bar), then open the app directly from your Spotlight search results. Recently opened apps appear in the center section of the Dock.



Close an app. When you click the red dot in the top-left corner of an open window, the window closes but the app stays open. Open apps have a black dot beneath them in the Dock. To close an app, Control-click the app icon in the Dock and click Quit.

Add an item to the Dock. Drag the item and drop it where you want it. Place apps in the left section of the Dock, and files or folders in the right section.

Remove an item from the Dock. Drag it out of the Dock. The item isn't removed from your Mac Pro—just from the Dock.

See everything that's open on your Mac. Press the Mission Control key  on your keyboard to view your open windows, desktop spaces, full-screen apps, and more, making it easy to switch between them. You can also add the Mission Control icon  to the Dock. See the Apple Support article [Use Mission Control on your Mac](#).

 **Tip:** Click Dock & Menu Bar in System Settings to change the appearance and behavior of the Dock. Make the Dock larger or smaller, move it to the left or right side of the screen, set it to hide when you're not using it, and more.



Learn more. See [Use the Dock on Mac](#) in the macOS User Guide.

Notification Center on your Mac

Notification Center keeps all of your important information, reminders, and widgets in one convenient place. Get details about calendar events, stocks, weather, and more—and catch up on notifications you might have missed (emails, messages, reminders, and more).

Open Notification Center. Click the date or time at the top right of the screen, or swipe left from the right edge of the trackpad with two fingers. Scroll down to see more.



Focus on what you're doing. When you're working, having dinner, or just don't want to be disturbed, Focus can automatically filter your notifications so you see only the ones you specify. Focus can pause all notifications or allow only certain ones to appear, and it can tell contacts that your notifications are silenced using a status in Messages. To set up Focus, open System Settings , click Focus in the sidebar, then click Add Focus. To turn Focus on or off, click  in the menu bar, then click the Focus section and choose a Focus.

You can customize a Focus to fit what you're currently doing, and allow notifications from certain people or apps, for phone calls or upcoming events, and more. You can also share your Focus across devices and use Focus filters to hide distracting content in apps like Calendar and Messages.

Interact with your notifications. Reply to an email, listen to the latest podcast, or view details about calendar events. Click the arrow in the top-right corner of a notification to view options, take action, or get more information.



Set your notification settings. Open System Settings, click Notifications, then select which notifications you see. Notifications are sorted by most recent.

Customize your widgets. Click Edit Widgets (at the bottom of your notifications) to add, remove, or rearrange widgets. You can also add third-party widgets from the Mac App Store.

Learn more. See [Use Notifications on Mac](#) in the macOS User Guide.

Control Center on your Mac

Control Center groups all your menu bar extras into a single place, giving you instant access to the controls you use the most—like Bluetooth, AirDrop, Stage Manager, Screen Mirroring, Focus, and brightness and volume controls—right from the menu bar. Click  in the upper-right corner of the screen to open Control Center.

Click for more options. Click a button to see more options. For example, click the Wi-Fi button  to see your preferred networks, other networks, or to open Wi-Fi Settings. To return to the main Control Center view, click  again.

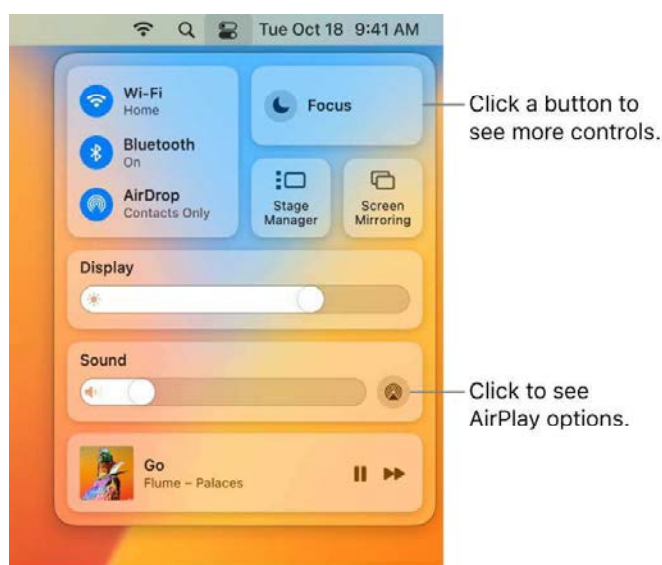

Manage your desktop. Use Stage Manager to organize your apps and windows in a single view and quickly switch between them. You can also group apps together to create workspaces ideal for your workflow. See [Window management on your Mac](#).

Monitor your mic. The recording indicator shows if your computer's microphone is in use or if it was used recently. This light increases security and privacy on your Mac by letting you know if an app has access to the microphone.

Note: Mac Pro requires an external microphone.

Pin your Control Center favorites. Drag a favorite item from Control Center to the menu bar to pin it there, so you can easily access it with a single click. To change what appears in the menu bar, open Control Center settings, then use the dropdown menu next to each module to select "Show in Menu Bar." You see a preview of where the control will appear in the menu bar. Some items can't be added to or removed from Control Center or the menu bar.

 **Tip:** To quickly remove an item from the menu bar, press and hold the Command key and drag the item out of the menu bar.