

FCC and ISED Test Report

Apple Inc
Model: A2787

In accordance with FCC 47 CFR Part 15, ISED RSS-247, ISED RSS-248 and ISED RSS-GEN (2.4 GHz Bluetooth, 2.4 GHz WLAN, 5 GHz WLAN, 6 GHz WLAN and Narrowband)

Prepared for: Apple Inc
One Apple Park Way
Cupertino
California
95014,
USA



Add value.
Inspire trust.

FCC ID: BCGA2787

IC: 579C-A2787

COMMERCIAL-IN-CONFIDENCE

Document 75955427-12 Issue 01

SIGNATURE

NAME	JOB TITLE	RESPONSIBLE FOR	ISSUE DATE
Steve Marshall	Senior Engineer	Authorised Signatory	13 March 2023

Signatures in this approval box have checked this document in line with the requirements of TÜV SÜD document control rules.

ENGINEERING STATEMENT

The measurements shown in this report were made in accordance with the procedures described on test pages. All reported testing was carried out on a sample equipment to demonstrate limited compliance with FCC 47 CFR Part 15, ISED RSS-247, ISED RSS-248 and ISED RSS-GEN. The sample tested was found to comply with the requirements defined in the applied rules.

RESPONSIBLE FOR	NAME	DATE	SIGNATURE
Report Generation	Lauren Walters	13 March 2023	

FCC Accreditation
90987 Octagon House, Fareham Test Laboratory

ISED Accreditation
12669A Octagon House, Fareham Test Laboratory

EXECUTIVE SUMMARY

A sample of this product was tested and found to be compliant with FCC 47 CFR Part 15: 2021, ISED RSS-247: Issue 2 (2017-02), ISED RSS-248: Issue 1 (2021-11) and ISED RSS-GEN: Issue 5 (2018-04) + A2 (2021-02) for the tests detailed in section 1.3.



DISCLAIMER AND COPYRIGHT

This non-binding report has been prepared by TÜV SÜD with all reasonable skill and care. The document is confidential to the potential Client and TÜV SÜD. No part of this document may be reproduced without the prior written approval of TÜV SÜD. © 2023 TÜV SÜD. This report relates only to the actual item/items tested.

ACCREDITATION

Our UKAS Accreditation does not cover opinions and interpretations and any expressed are outside the scope of our UKAS Accreditation. Results of tests not covered by our UKAS Accreditation Schedule are marked NUA (Not UKAS Accredited).

TÜV SÜD
is a trading name of TÜV SÜD Ltd
Registered in Scotland at East Kilbride,
Glasgow G75 0QF, United Kingdom
Registered number: SC215164

TÜV SÜD Ltd is a
TÜV SÜD Group Company

Phone: +44 (0) 1489 558100
Fax: +44 (0) 1489 558101
www.tuvsud.com/en

TÜV SÜD
Octagon House
Concorde Way
Fareham
Hampshire PO15 5RL
United Kingdom



Contents

1	Report Summary	2
1.1	Report Modification Record.....	2
1.2	Introduction.....	2
1.3	Brief Summary of Results	3
1.4	Product Information	4
1.5	Deviations from the Standard.....	4
1.6	EUT Modification Record	4
1.7	Test Location	4
2	Test Details	5
2.1	Radiated Spurious Emissions (Simultaneous Transmission)	5
3	Measurement Uncertainty	30



1 Report Summary

1.1 Report Modification Record

Alterations and additions to this report will be issued to the holders of each copy in the form of a complete document.

Issue	Description of Change	Date of Issue
1	First Issue	13-March-2023

Table 1

1.2 Introduction

Applicant	Apple Inc
Manufacturer	Apple Inc
Model Number(s)	A2787
Serial Number(s)	C2VL734Q54
Hardware Version(s)	REV 1.0
Software Version(s)	22E71580u
Number of Samples Tested	1
Test Specification/Issue/Date	FCC 47 CFR Part 15: 2021 ISED RSS-247: Issue 2 (2017-02) ISED RSS-248: Issue 1 (2021-11) ISED RSS-GEN: Issue 5 (2018-04) + A2 (2021-02)
Order Number	0540246998
Start of Test	11-February-2023
Finish of Test	13-February-2023
Name of Engineer(s)	Thomas Randall and Colin Brain
Related Document(s)	ANSI C63.26: 2015 ANSI C63.10: 2013 ANSI C63.10: 2020 KDB 789033



1.3 Brief Summary of Results

A brief summary of the tests carried out in accordance with FCC 47 CFR Part 15, ISED RSS-247, ISED RSS-248 and ISED RSS-GEN is shown below.

Section	Specification Clause				Test Description	Result	Comments/Base Standard
	Part 15	RSS-247	RSS-248	RSS-GEN			
Configuration and Mode: CoTx - 2.4 GHz Bluetooth and 5 GHz WLAN							
2.1	15.209, 15.247(d) and 15.407(b)	5.5 and 6.2	-	8.9	Radiated Spurious Emissions (Simultaneous Transmission)	Pass	
Configuration and Mode: CoTx - 2.4 GHz Bluetooth and 6 GHz WLAN							
2.1	15.209, 15.247(d) and 15.407(b)	5.5	4.7	8.9	Radiated Spurious Emissions (Simultaneous Transmission)	Pass	
Configuration and Mode: CoTx - 2.4 GHz WLAN and Narrowband							
2.1	15.209, 15.247(d) and 15.407(b)	5.5 and 6.2	-	8.9	Radiated Spurious Emissions (Simultaneous Transmission)	Pass	

Table 2



1.4 Product Information

1.4.1 Technical Description

The equipment under test was a rack mounted Apple computer, with Bluetooth® and IEEE 802.11 a/b/g/n/ac/ax Wi-Fi capabilities in the 2.4 GHz, 5 GHz and 6 GHz bands.

1.5 Deviations from the Standard

No deviations from the applicable test standard were made during testing.

1.6 EUT Modification Record

The table below details modifications made to the EUT during the test programme.

The modifications incorporated during each test are recorded on the appropriate test pages.

Modification State	Description of Modification still fitted to EUT	Modification Fitted By	Date Modification Fitted
Model: A2787, Serial Number: C2VL734Q54			
0	As supplied by the customer	Not Applicable	Not Applicable

Table 3

1.7 Test Location

TÜV SÜD conducted the following tests at our Concorde Park Test Laboratory.

Test Name	Name of Engineer(s)	Accreditation
Configuration and Mode: CoTx - 2.4 GHz Bluetooth + 5 GHz WLAN		
Radiated Spurious Emissions (Simultaneous Transmission)	Thomas Randall and Colin Brain	UKAS
Configuration and Mode: CoTx - 2.4 GHz Bluetooth + 6 GHz WLAN		
Radiated Spurious Emissions (Simultaneous Transmission)	Thomas Randall and Colin Brain	UKAS
Configuration and Mode: CoTx - 2.4 GHz WLAN and Narrowband		
Radiated Spurious Emissions (Simultaneous Transmission)	Thomas Randall and Colin Brain	UKAS

Table 4

Office Address:

TÜV SÜD
 Concorde Park
 Concorde Way
 Fareham
 Hampshire
 PO15 5FG
 United Kingdom



2 Test Details

2.1 Radiated Spurious Emissions (Simultaneous Transmission)

2.1.1 Specification Reference

FCC 47 CFR Part 15, Clause 15.209, 15.247(d) and 15.407(b)
ISED RSS-247, Clause 5.5 and 6.2
ISED RSS-248, Clause 4.7
ISED RSS-GEN, Clause 8.9

2.1.2 Equipment Under Test and Modification State

A2787, S/N: C2VL734Q54 - Modification State 0

2.1.3 Date of Test

11-February-2023 to 13-February-2023

2.1.4 Test Method

This test was performed in accordance with ANSI C63.10, clause 6.3, 6.5 and 6.6.

The EUT was placed on the non-conducting platform in a manner typical of a normal installation.

Ports on the EUT were terminated with loads as described in ANSI C63.4 clause 6.2.4 for each type of port on the EUT.

For frequencies > 1 GHz, plots for average measurements were taken in accordance with ANSI C63.10, clause 4.1.4.2.5 to characterize the EUT. Where emissions were detected, final average measurements were taken in accordance with ANSI C63.10, clause 4.1.4.2.2, 11.11, 11.12, 12.7.2 or 12.7.3 depending on the nature of the emission measured.

The plots shown are the characterisation of the EUT. The limits on the plots represent the most stringent case for restricted bands, (74/54 dBuV/m) when compared to non-restricted band limits. The limits shown have been used as a threshold to determine where further measurements are necessary. Where results are within 10 dB of the limits shown on the plots, further investigation was carried out and reported in results tables.

The following conversion can be applied to convert from dB μ V/m to μ V/m:
 $10^{(\text{Field Strength in dB}\mu\text{V/m}/20)}$.

At a measurement distance of 1 meter the limit line was increased by $20 \cdot \text{LOG}(3/1) = 9.54$ dB.

2.1.5 Example Test Setup Diagram

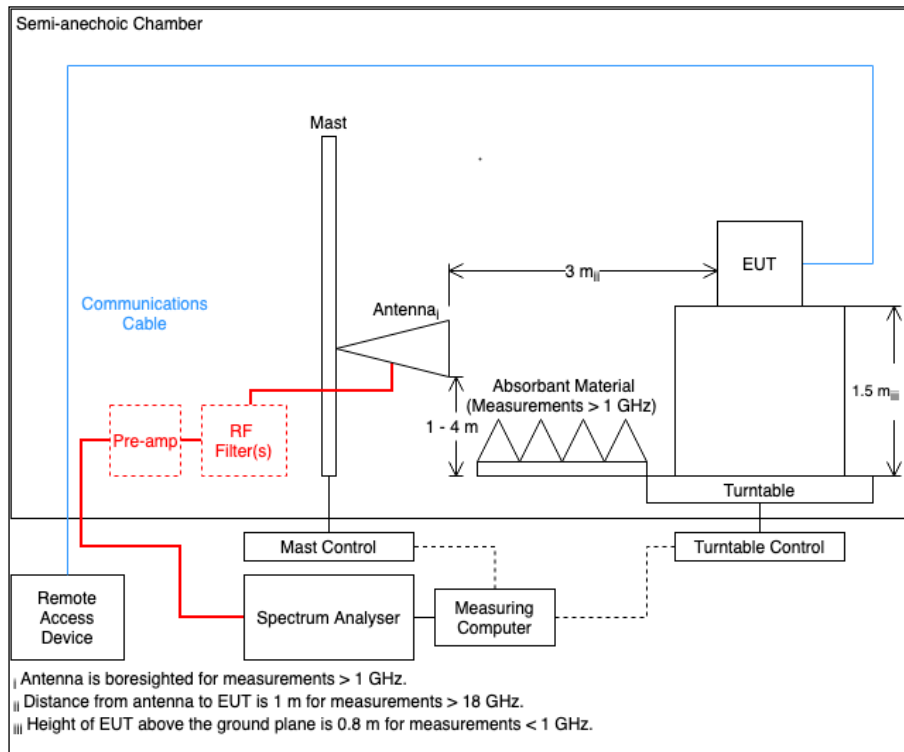

Figure 1

2.1.6 Environmental Conditions

Ambient Temperature	21.4 - 22.6 °C
Relative Humidity	33.6 - 38.9 %



2.1.7 Test Results

CoTx - 2.4 GHz Bluetooth + 5 GHz WLAN

Frequency (MHz)	Level (dBuv/m)	Limit (dBuv/m)	Margin (dB)	Detector	Angle (°)	Height (cm)	Polarisation
2800.132	36.81	54.00	-17.19	RMS	328	100	Horizontal
4881.706	41.16	54.00	-12.84	CISPR Avg	296	110	Horizontal
15999.960	41.65	54.00	-12.35	RMS	321	158	Horizontal
16000.115	39.68	54.00	-14.32	RMS	324	155	Vertical

Table 5 - U-NII-1 - 5240 MHz (CH48), VHT20, CDD, Core 0 + Core 1 and 2441 MHz (CH39), 2-DH5, ePA, Core 0 + Core 1, 30 MHz to 40 GHz

No other emissions found within 10 dB of the limit.

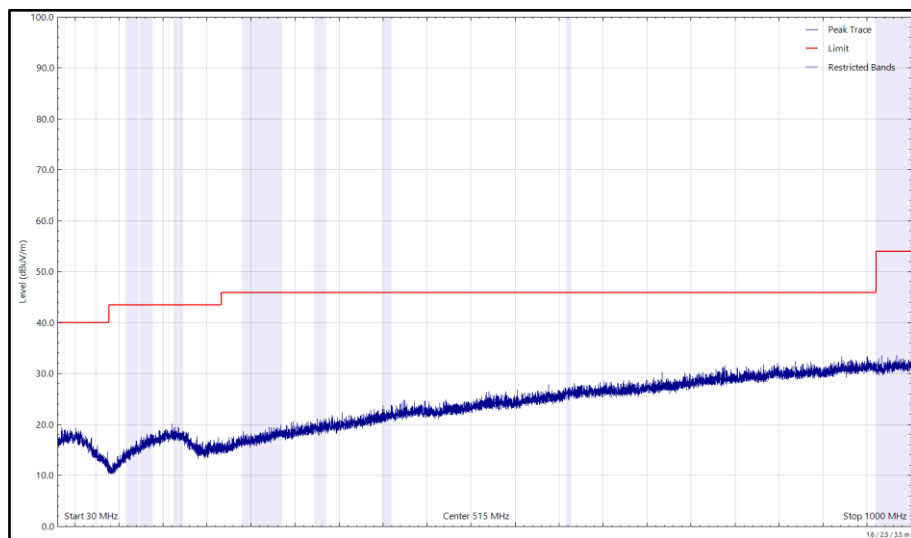

Figure 2 - U-NII-1 - 5240 MHz (CH48), VHT20, CDD, Core 0 + Core 1 and 2441 MHz (CH39), 2-DH5, ePA, Core 0 + Core 1, 30 MHz to 1 GHz, Horizontal (Peak)

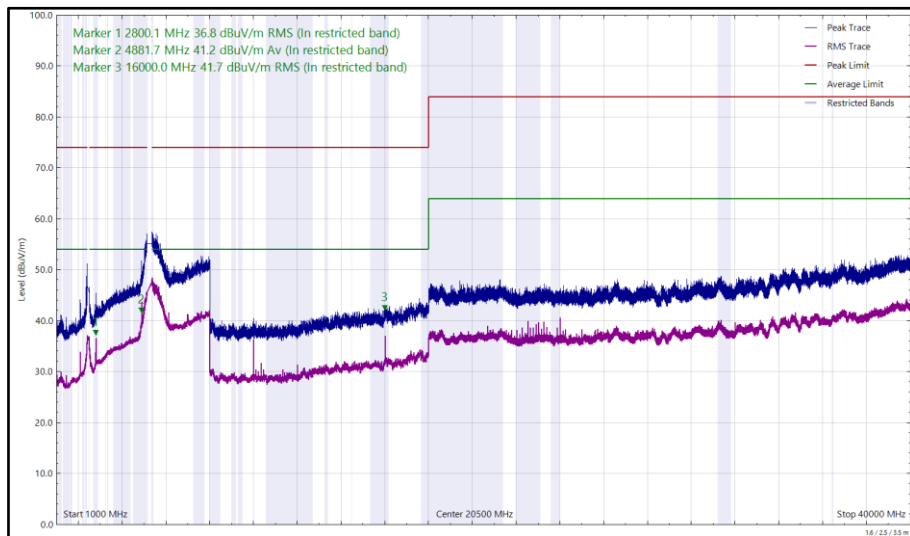

Figure 3 - U-NII-1 - 5240 MHz (CH48), VHT20, CDD, Core 0 + Core 1 and 2441 MHz (CH39), 2-DH5, ePA, Core 0 + Core 1, 1 GHz to 40 GHz, Horizontal

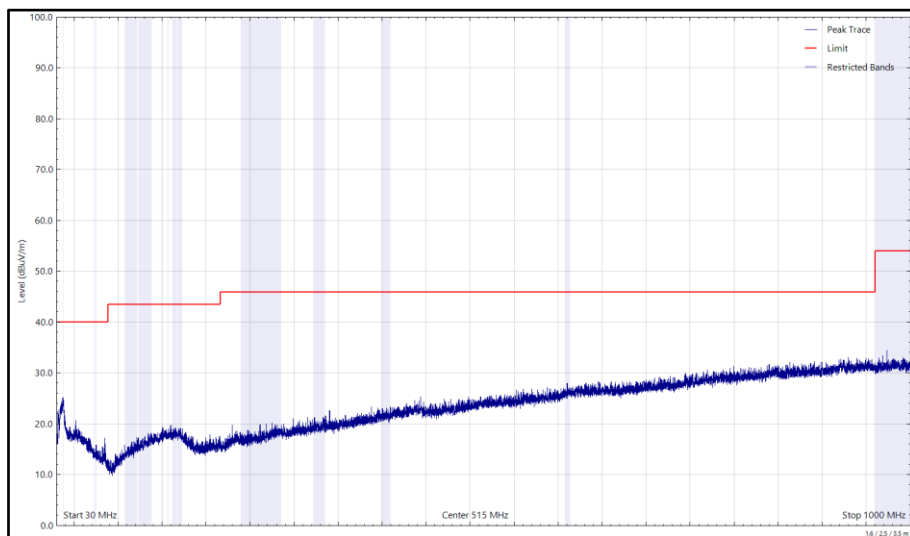

Figure 4 - U-NII-1 - 5240 MHz (CH48), VHT20, CDD, Core 0 + Core 1 and 2441 MHz (CH39), 2-DH5, ePA, Core 0 + Core 1, 30 MHz to 1 GHz, Vertical (Peak)

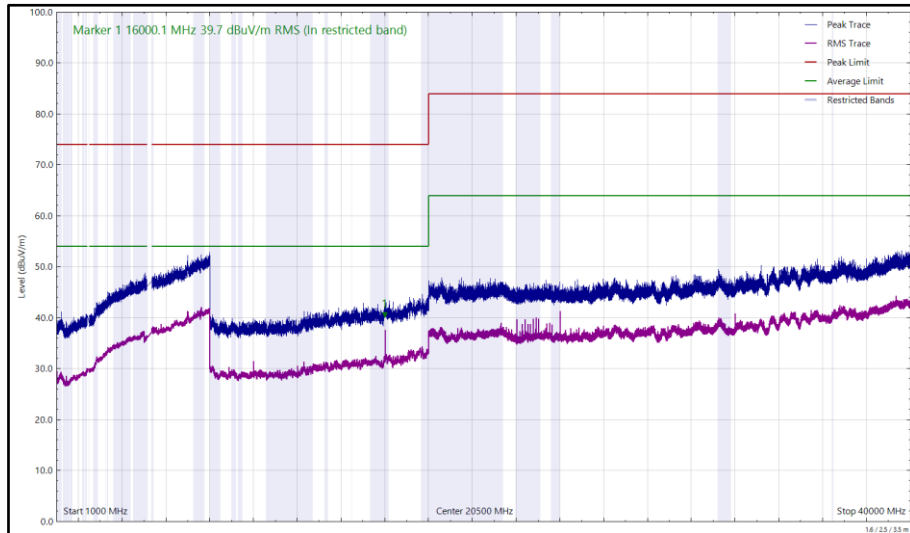

Figure 5 - U-NII-1 - 5240 MHz (CH48), VHT20, CDD, Core 0 + Core 1 and 2441 MHz (CH39), 2-DH5, ePA, Core 0 + Core 1, 1 GHz to 40 GHz, Vertical



Frequency (MHz)	Level (dBuV/m)	Limit (dBuV/m)	Margin (dB)	Detector	Angle (°)	Height (cm)	Polarisation
37.642	20.07	40.00	-19.93	Q-Peak	341	313	Vertical
4881.743	40.67	54.00	-13.33	CISPR Avg	313	102	Horizontal
15999.980	40.18	54.00	-13.82	RMS	322	174	Horizontal
16000.095	40.76	54.00	-13.24	RMS	325	175	Vertical

Table 6 - U-NII-2C - 5640 MHz (CH128), VHT20, CDD, Core 0 + Core 1 and 2441 MHz (CH39), 2-DH5, ePA, Core 0 + Core 1, 30 MHz to 40 GHz

No other emissions found within 10 dB of the limit.

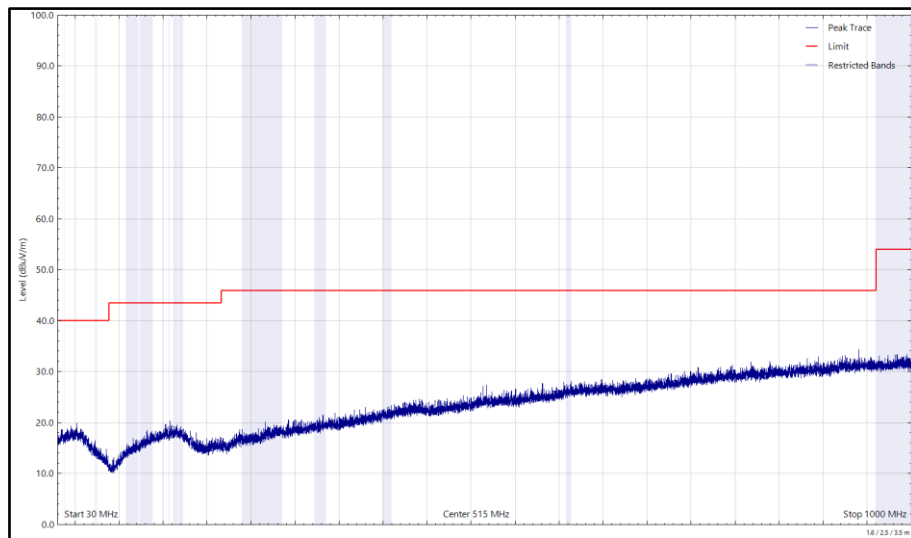

Figure 6 - U-NII-2C - 5640 MHz (CH128), VHT20, CDD, Core 0 + Core 1 and 2441 MHz (CH39), 2-DH5, ePA, Core 0 + Core 1, 30 MHz to 1 GHz, Horizontal (Peak)

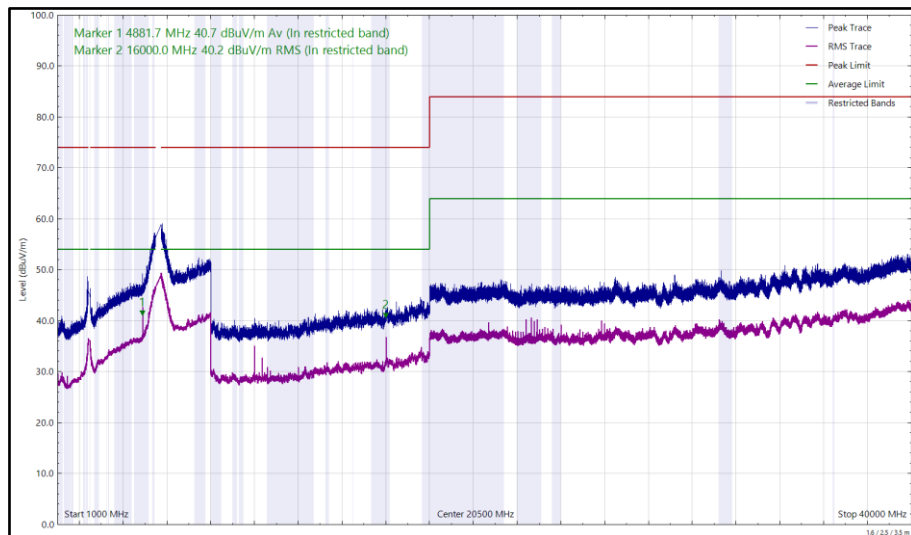

Figure 7 - U-NII-2C - 5640 MHz (CH128), VHT20, CDD, Core 0 + Core 1 and 2441 MHz (CH39), 2-DH5, ePA, Core 0 + Core 1, 1 GHz to 40 GHz, Horizontal

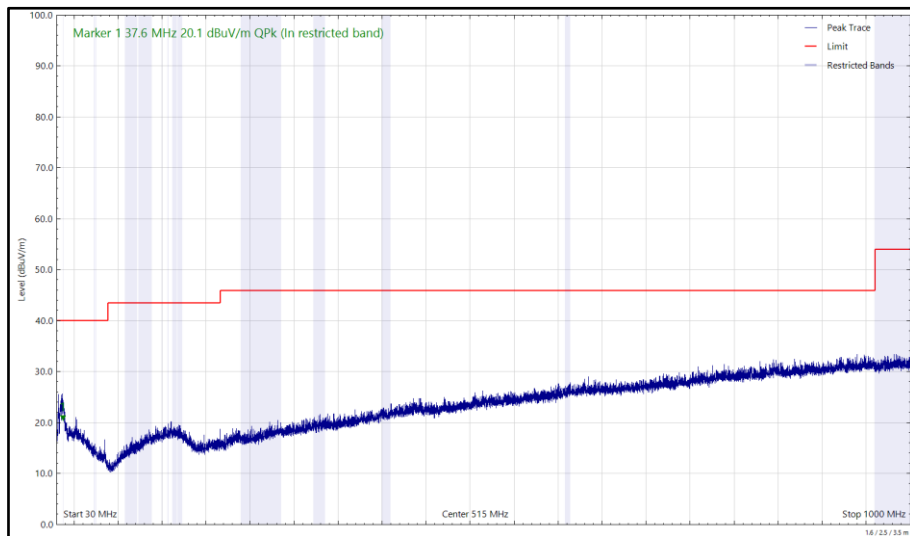

Figure 8 - U-NII-2C - 5640 MHz (CH128), VHT20, CDD, Core 0 + Core 1 and 2441 MHz (CH39), 2-DH5, ePA, Core 0 + Core 1, 30 MHz to 1 GHz, Vertical (Peak)

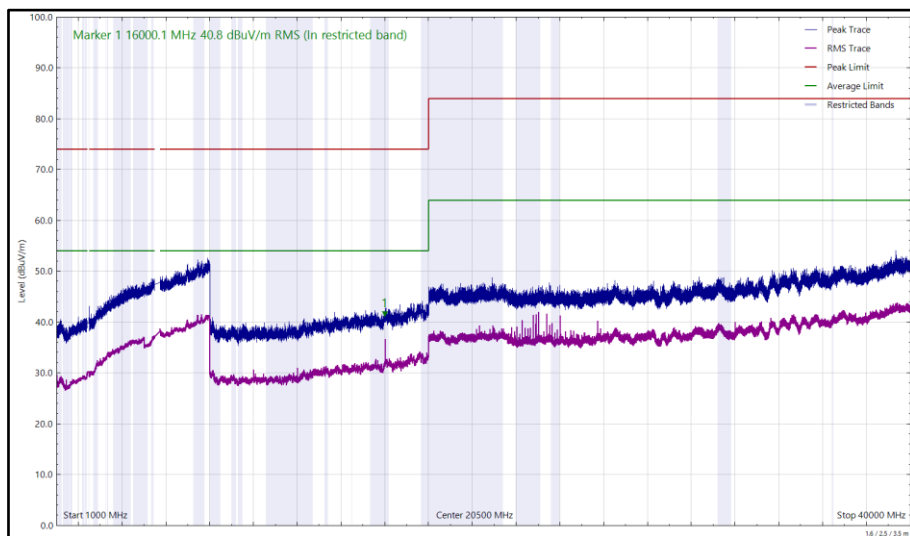

Figure 9 - U-NII-2C - 5640 MHz (CH128), VHT20, CDD, Core 0 + Core 1 and 2441 MHz (CH39), 2-DH5, ePA, Core 0 + Core 1, 1 GHz to 40 GHz, Vertical



Frequency (MHz)	Level (dBuV/m)	Limit (dBuV/m)	Margin (dB)	Detector	Angle (°)	Height (cm)	Polarisation
4881.618	40.11	54.00	-13.89	CISPR Avg	313	110	Horizontal
15999.870	41.43	54.00	-12.57	RMS	321	161	Horizontal
15999.995	41.78	54.00	-12.22	RMS	326	194	Vertical
22892.389	44.56	54.00	-9.44	RMS	93	100	Vertical
23015.528	43.50	54.00	-10.50	RMS	110	100	Horizontal

Table 7 - U-NII-3 - 5785 MHz (CH157), VHT20, CDD, Core 0 + Core 1 and 2441 MHz (CH39), 2-DH5, ePA, Core 0 + Core 1, 30 MHz to 40 GHz

No other emissions found within 10 dB of the limit.

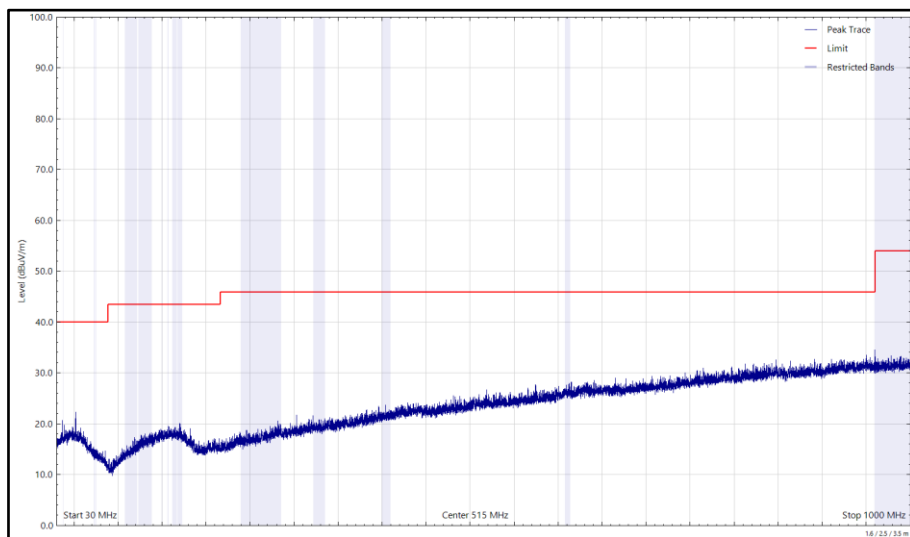

Figure 10 - U-NII-3 - 5785 MHz (CH157), VHT20, CDD, Core 0 + Core 1 and 2441 MHz (CH39), 2-DH5, ePA, Core 0 + Core 1, 30 MHz to 1 GHz, Horizontal (Peak)

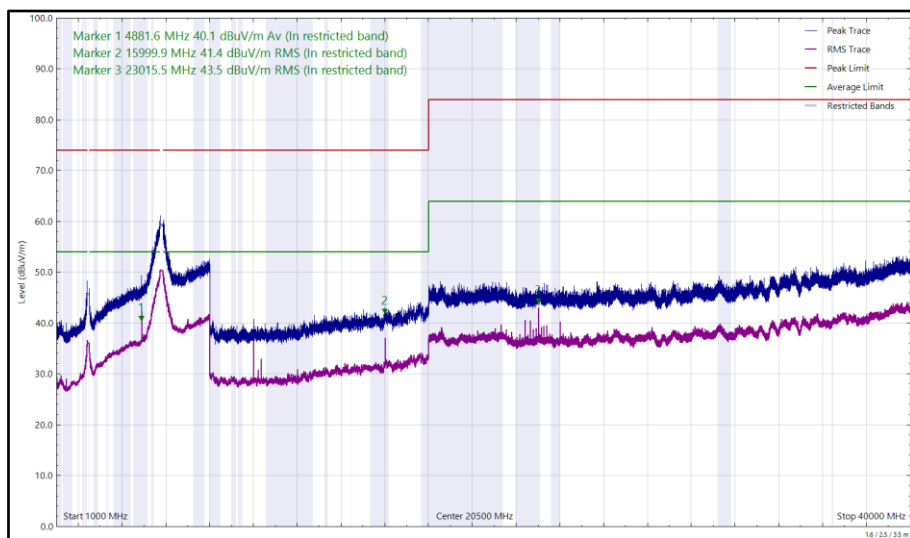

Figure 11 - U-NII-3 - 5785 MHz (CH157), VHT20, CDD, Core 0 + Core 1 and 2441 MHz (CH39), 2-DH5, ePA, Core 0 + Core 1, 1 GHz to 40 GHz, Horizontal

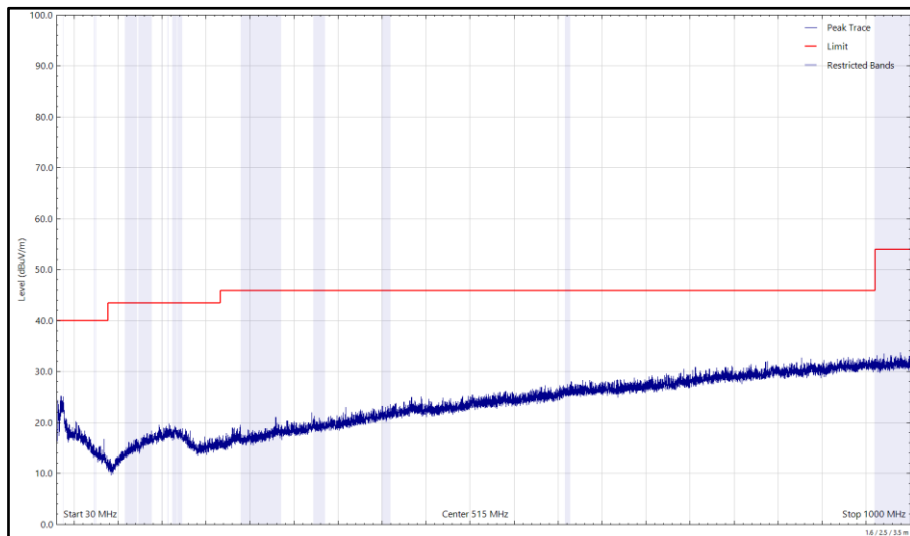

Figure 12 - U-NII-3 - 5785 MHz (CH157), VHT20, CDD, Core 0 + Core 1 and 2441 MHz (CH39), 2-DH5, ePA, Core 0 + Core 1, 30 MHz to 1 GHz, Vertical (Peak)

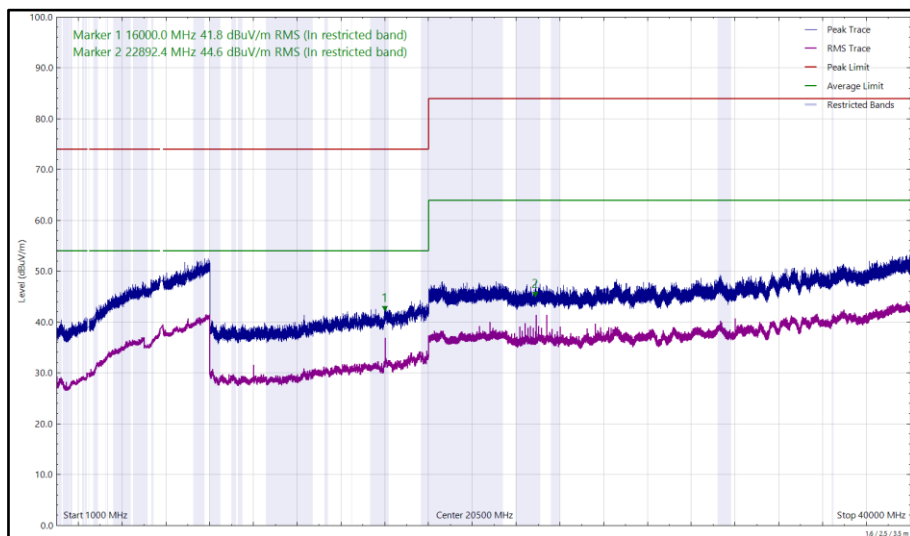

Figure 13 - U-NII-3 - 5785 MHz (CH157), VHT20, CDD, Core 0 + Core 1 and 2441 MHz (CH39), 2-DH5, ePA, Core 0 + Core 1, 1 GHz to 40 GHz, Vertical



FCC 47 CFR Part 15, ISED RSS-247 and ISED RSS-GEN

The least stringent limit from the applicable rule parts was used to determine compliance for Radiated Emissions testing of multiple transmission sources.

The least stringent applicable limit was:

Clause	Limit
Part 15.247 (d) / RSS-247 Clause 5.5	-20 dBc
-Part 15.407 (b) / RSS-247 Clause 6.2	-27 dBm e.i.r.p
Part 15.209 / RSS-GEN Clause 8.9	Peak: 74 dB μ V/m at 3m, Average 54 dB μ V/m at 3m (Restricted bands > 1 GHz)

Table 8



CoTx - 2.4 GHz Bluetooth + 6 GHz WLAN

Frequency (MHz)	Level (dBuV/m)	Limit (dBuV/m)	Margin (dB)	Detector	Angle (°)	Height (cm)	Polarisation
7323.103	37.67	54.00	-16.33	CISPR Avg	13	161	Horizontal
15999.950	41.18	54.00	-12.82	RMS	329	185	Vertical
16000.055	39.92	54.00	-14.08	RMS	318	154	Horizontal
22892.397	43.58	54.00	-10.42	RMS	93	100	Vertical

Table 9 - U-NII-5 - 5955 MHz (CH1), HE20, SU, CDD, Core 0 + Core 1 and 2441 MHz (CH39), 2-DH5, ePA, Core 0 + Core 1, 30 MHz to 40 GHz

No other emissions found within 10 dB of the limit.

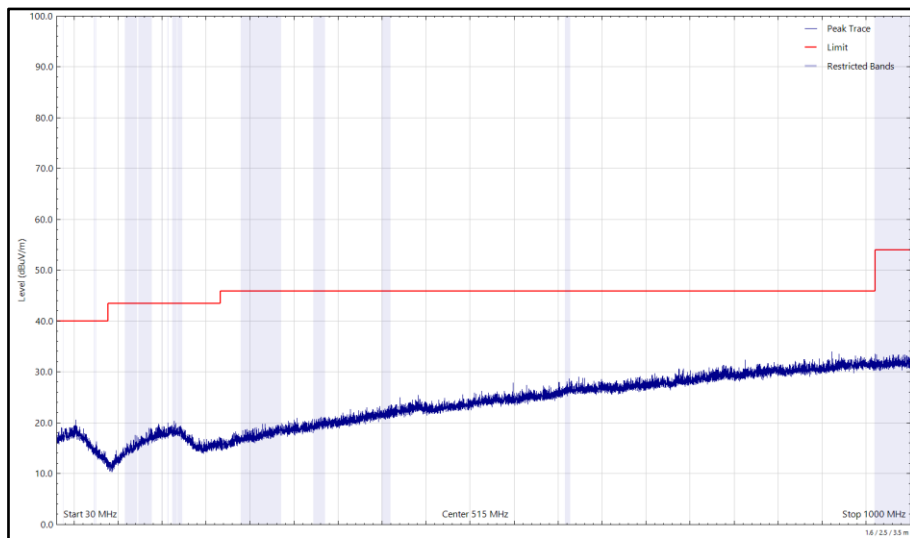

Figure 14 - U-NII-5 - 5955 MHz (CH1), HE20, SU, CDD, Core 0 + Core 1 and 2441 MHz (CH39), 2-DH5, ePA, Core 0 + Core 1, 30 MHz to 1 GHz, Horizontal (Peak)

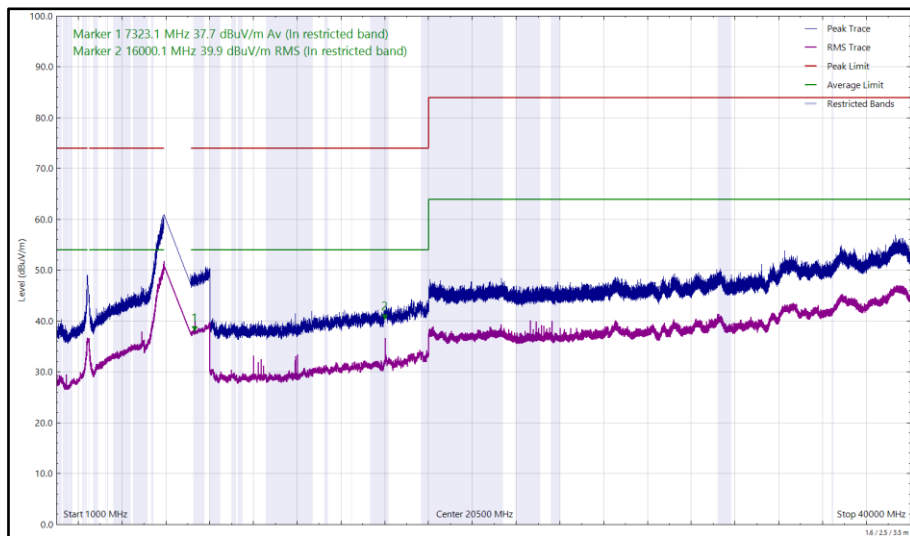

Figure 15 - U-NII-5 - 5955 MHz (CH1), HE20, SU, CDD, Core 0 + Core 1 and 2441 MHz (CH39), 2-DH5, ePA, Core 0 + Core 1, 1 GHz to 40 GHz, Horizontal

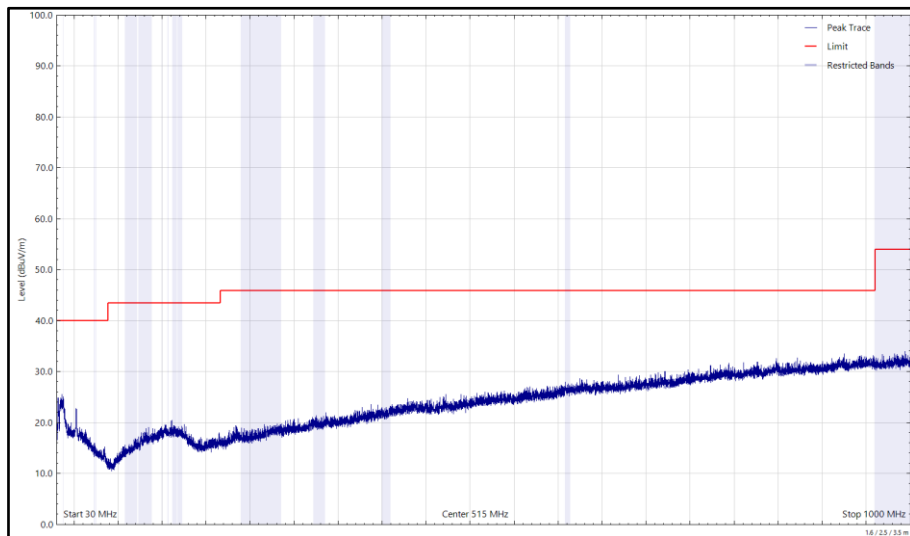

Figure 16 - U-NII-5 - 5955 MHz (CH1), HE20, SU, CDD, Core 0 + Core 1 and 2441 MHz (CH39), 2-DH5, ePA, Core 0 + Core 1, 30 MHz to 1 GHz, Vertical (Peak)

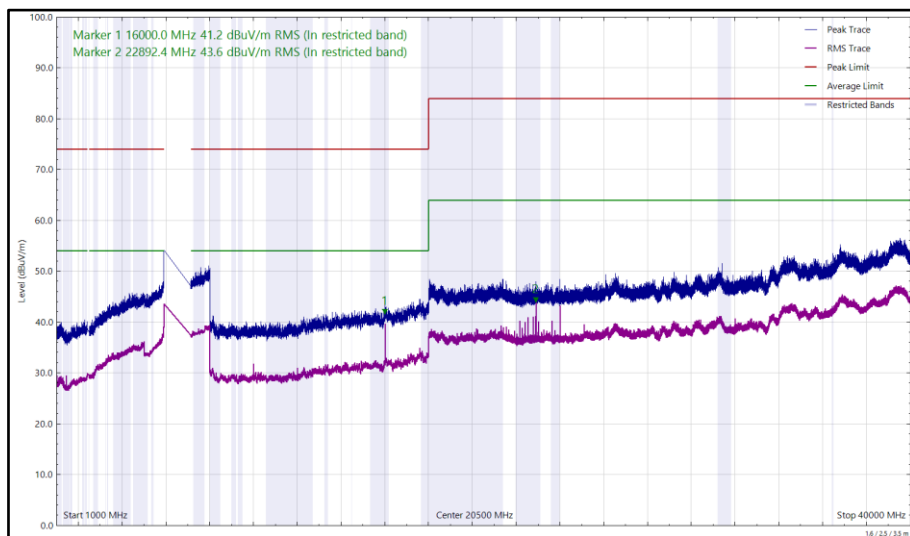

Figure 17 - U-NII-5 - 5955 MHz (CH1), HE20, SU, CDD, Core 0 + Core 1 and 2441 MHz (CH39), 2-DH5, ePA, Core 0 + Core 1, 1 GHz to 40 GHz, Vertical



Frequency (MHz)	Level (dBuV/m)	Limit (dBuV/m)	Margin (dB)	Detector	Angle (°)	Height (cm)	Polarisation
5334.392	61.40	68.20	-6.80	Peak	319	166	Horizontal
7323.166	37.28	54.00	-16.72	CISPR Avg	352	157	Horizontal
15999.850	38.24	54.00	-15.76	RMS	320	152	Vertical
16000.055	38.07	54.00	-15.93	RMS	321	159	Horizontal

Table 10 - U-NII-8 - 7115 MHz (CH233), HE20, SU, CDD, Core 0 + Core 1 and 2441 MHz (CH39), 2-DH5, ePA, Core 0 + Core 1, 30 MHz to 40 GHz

No other emissions found within 10 dB of the limit.

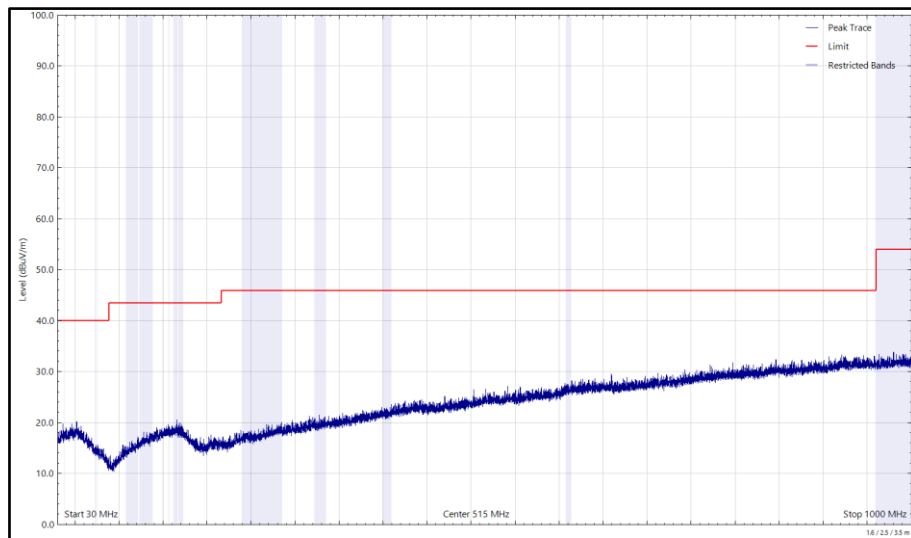

Figure 18 - U-NII-8 - 7115 MHz (CH233), HE20, SU, CDD, Core 0 + Core 1 and 2441 MHz (CH39), 2-DH5, ePA, Core 0 + Core 1, 30 MHz to 1 GHz, Horizontal (Peak)

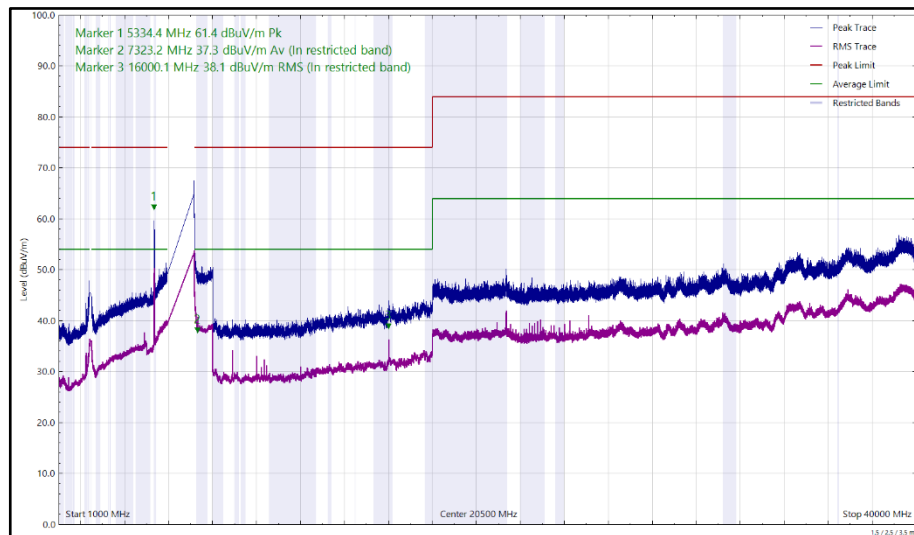

Figure 19 - U-NII-8 - 7115 MHz (CH233), HE20, SU, CDD, Core 0 + Core 1 and 2441 MHz (CH39), 2-DH5, ePA, Core 0 + Core 1, 1 GHz to 40 GHz, Horizontal

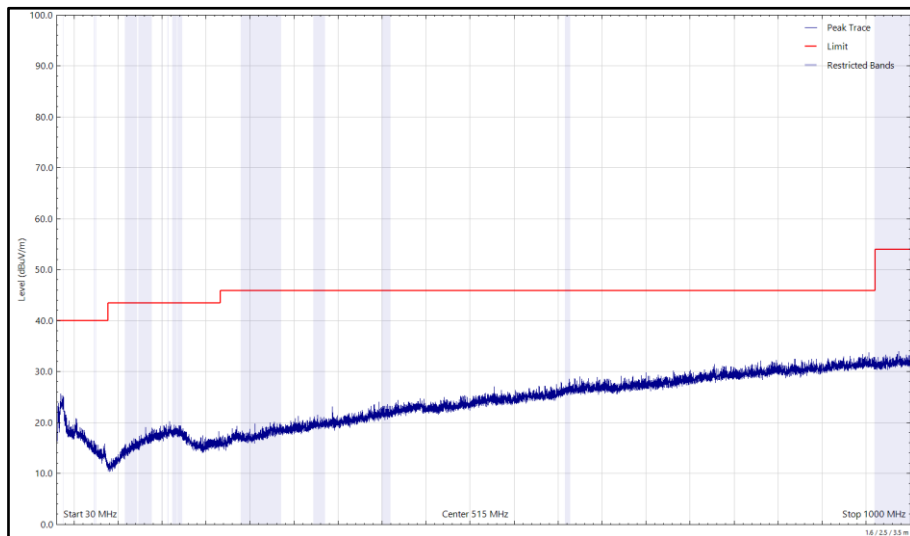

Figure 20 - U-NII-8 - 7115 MHz (CH233), HE20, SU, CDD, Core 0 + Core 1 and 2441 MHz (CH39), 2-DH5, ePA, Core 0 + Core 1, 30 MHz to 1 GHz, Vertical (Peak)

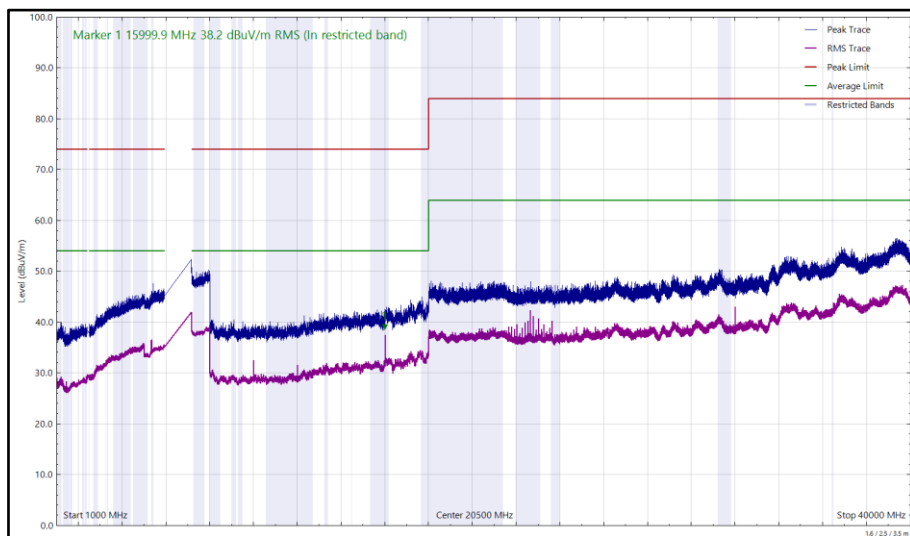

Figure 21 - U-NII-8 - 7115 MHz (CH233), HE20, SU, CDD, Core 0 + Core 1 and 2441 MHz (CH39), 2-DH5, ePA, Core 0 + Core 1, 1 GHz to 40 GHz, Vertical



FCC 47 CFR Part 15, ISED RSS-247, ISED RSS-248 and ISED RSS-GEN

The least stringent limit from the applicable rule parts was used to determine compliance for Radiated Emissions testing of multiple transmission sources.

The least stringent applicable limit was:

Clause	Limit
Part 15.247 (d) / RSS-247 Clause 5.5	-20 dBc
Part 15.407 (b) / RSS-248 Clause 4.7.2	Peak: -7 dBm/MHz e.i.r.p, Average: -27 dBm/MHz e.i.r.p
Part 15.209 / RSS-GEN Clause 8.9	Peak: 74 dB μ V/m at 3m, Average 54 dB μ V/m at 3m (Restricted bands > 1 GHz)

Table 11



CoTx - 2.4 GHz WLAN and Narrowband

Frequency (MHz)	Level (dBuV/m)	Limit (dBuV/m)	Margin (dB)	Detector	Angle (°)	Height (cm)	Polarisation
37.522	22.24	40.00	-17.76	Q-Peak	223	109	Vertical
16000.015	42.29	54.00	-11.71	RMS	325	176	Vertical
16000.195	37.96	54.00	-16.04	RMS	320	110	Horizontal

Table 12 - 2437 MHz (CH6), HT20, Core 0 and 5204 MHz, HDR4, ePA, Core 1, 30 MHz to 40 GHz

No other emissions found within 10 dB of the limit.

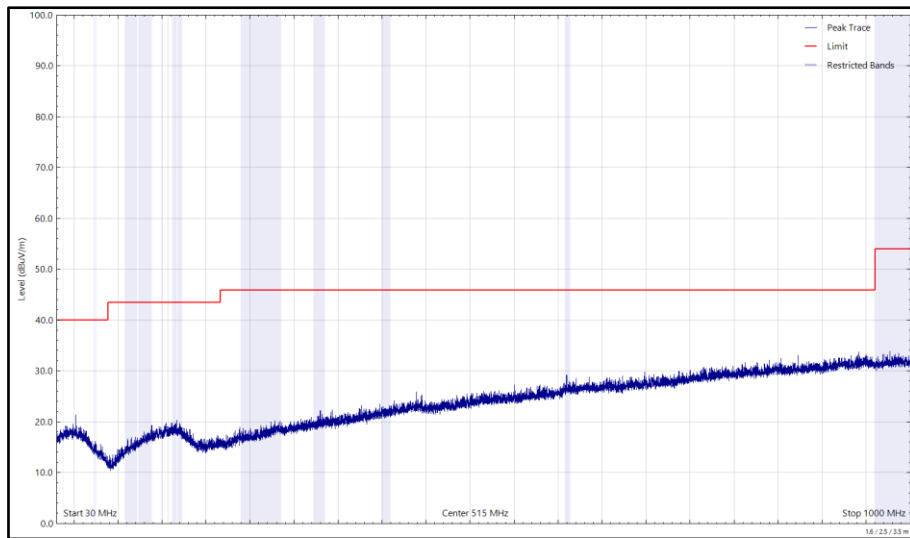

Figure 22 - 2437 MHz (CH6), HT20, Core 0 and 5204 MHz, HDR4, ePA, Core 1, 30 MHz to 1 GHz, Horizontal (Peak)

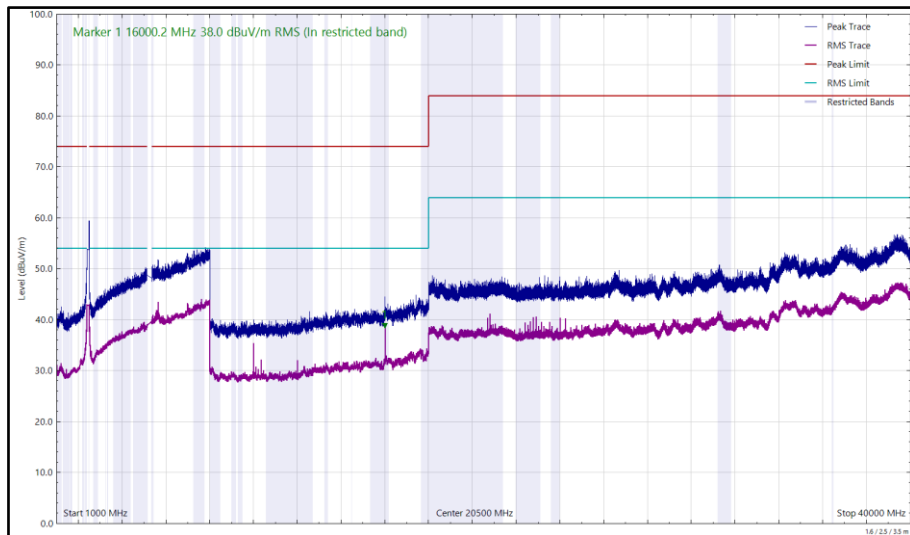

Figure 23 - 2437 MHz (CH6), HT20, Core 0 and 5204 MHz, HDR4, ePA, Core 1, 1 GHz to 40 GHz, Horizontal

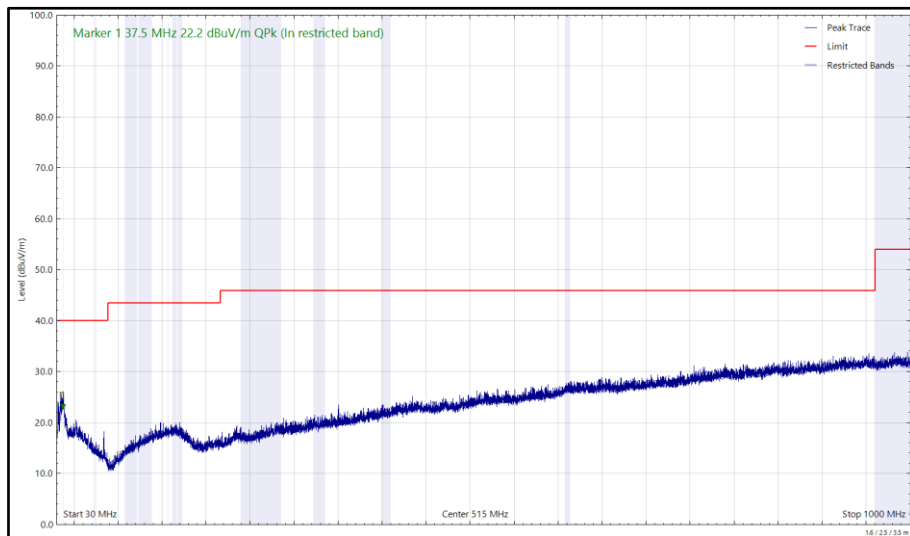

Figure 24 - 2437 MHz (CH6), HT20, Core 0 and 5204 MHz, HDR4, ePA, Core 1, 30 MHz to 1 GHz, Vertical (Peak)

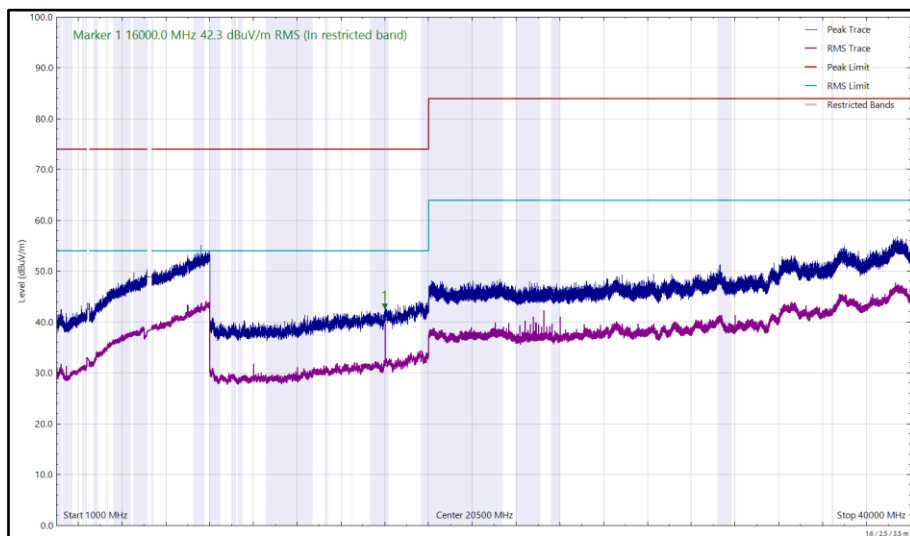

Figure 25 - 2437 MHz (CH6), HT20, Core 0 and 5204 MHz, HDR4, ePA, Core 1, 1 GHz to 40 GHz, Vertical



Frequency (MHz)	Level (dBuV/m)	Limit (dBuV/m)	Margin (dB)	Detector	Angle (°)	Height (cm)	Polarisation
5374.455	42.78	54.00	-11.22	RMS	327	128	Horizontal
15999.861	37.84	54.00	-16.16	RMS	320	164	Horizontal
16000.090	41.62	54.00	-12.38	RMS	324	190	Vertical
23015.271	43.55	54.00	-10.45	RMS	92	100	Vertical

Table 13 - 2437 MHz (CH6), HT20, Core 0 and 5788 MHz, HDR4, ePA, Core 1, 30 MHz to 40 GHz

No other emissions found within 10 dB of the limit.

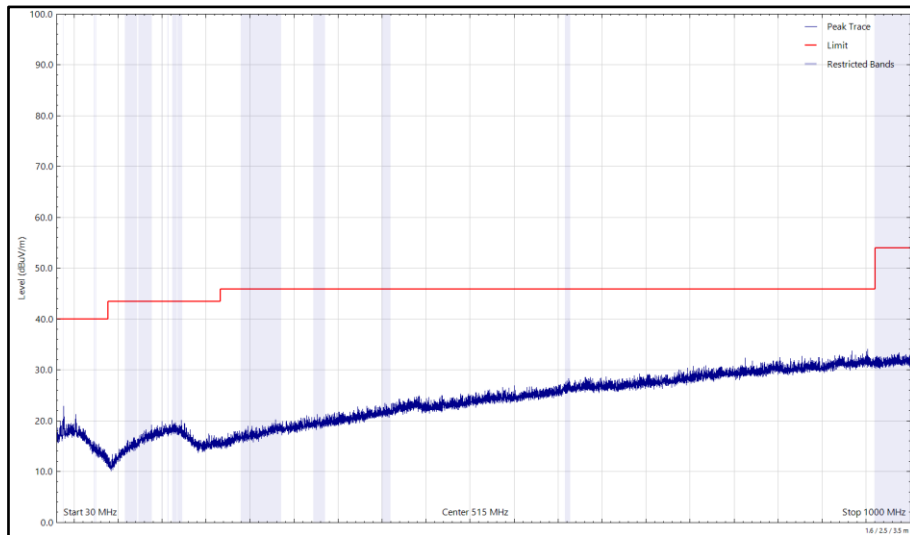

Figure 26 - 2437 MHz (CH6), HT20, Core 0 and 5788 MHz, HDR4, ePA, Core 1, 30 MHz to 1 GHz, Horizontal (Peak)

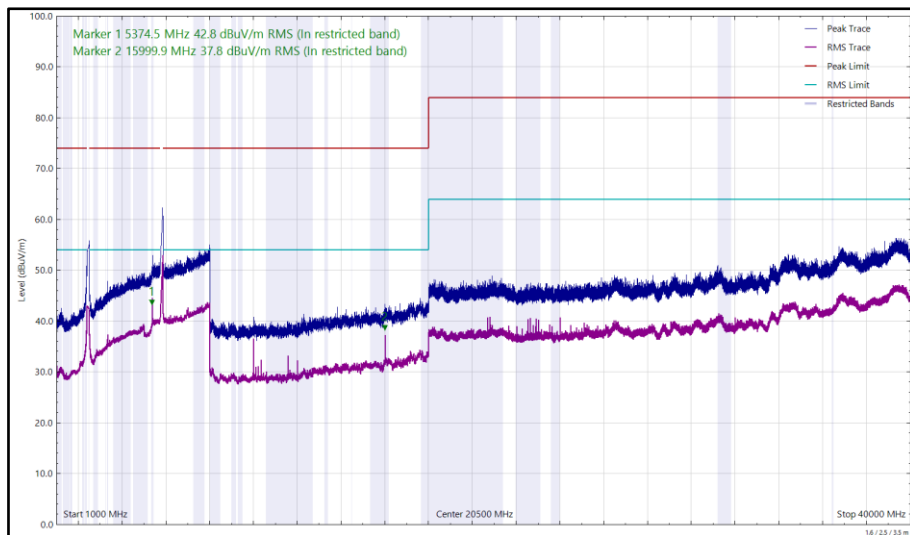

Figure 27 - 2437 MHz (CH6), HT20, Core 0 and 5788 MHz, HDR4, ePA, Core 1, 1 GHz to 40 GHz, Horizontal

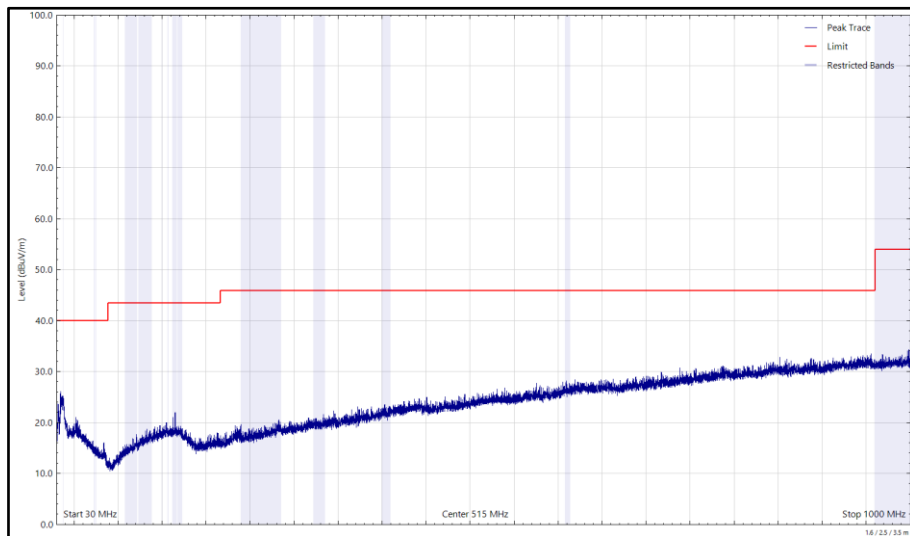

Figure 28 - 2437 MHz (CH6), HT20, Core 0 and 5788 MHz, HDR4, ePA, Core 1, 30 MHz to 1 GHz, Vertical (Peak)

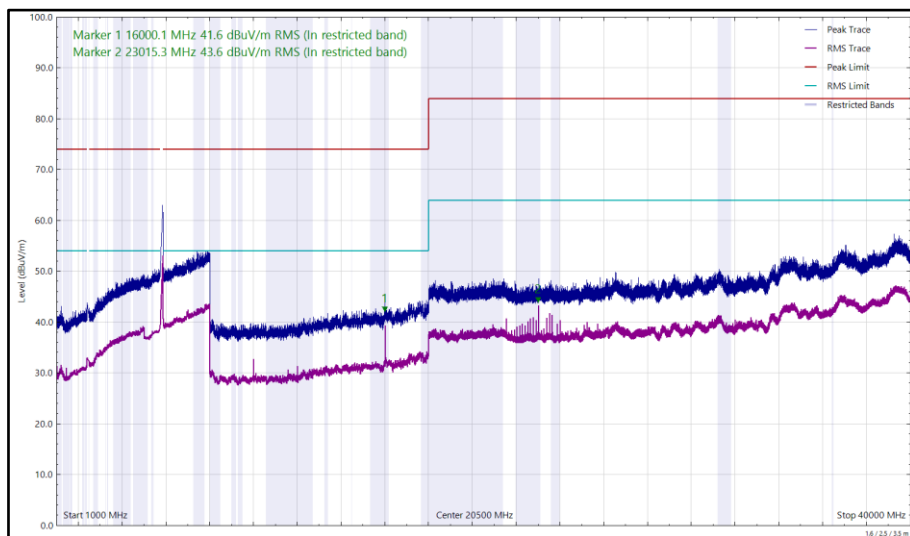

Figure 29 - 2437 MHz (CH6), HT20, Core 0 and 5788 MHz, HDR4, ePA, Core 1, 1 GHz to 40 GHz, Vertical



Frequency (MHz)	Level (dBuV/m)	Limit (dBuV/m)	Margin (dB)	Detector	Angle (°)	Height (cm)	Polarisation
2746.604	55.29	74.00	-18.71	Peak	312	100	Horizontal
2746.604	37.96	54.00	-16.04	RMS	312	100	Horizontal
4868.431	54.99	74.00	-19.01	Peak	296	214	Horizontal
4868.431	40.48	54.00	-13.52	RMS	296	214	Horizontal
15999.983	39.38	54.00	-14.62	RMS	313	169	Horizontal
16000.038	42.80	54.00	-11.20	RMS	326	171	Vertical

Table 14 - 2437 MHz (CH6), HT20, Core 1 and 5204 MHz, HDR4, ePA, Core 0, 30 MHz to 40 GHz

No other emissions found within 10 dB of the limit.

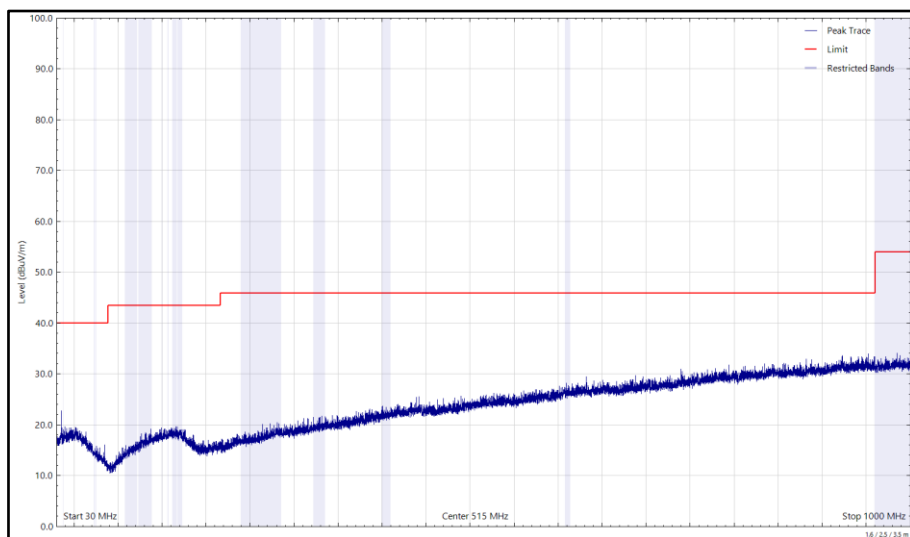

Figure 30 - 2437 MHz (CH6), HT20, Core 1 and 5204 MHz, HDR4, ePA, Core 0, 30 MHz to 1 GHz, Horizontal (Peak)

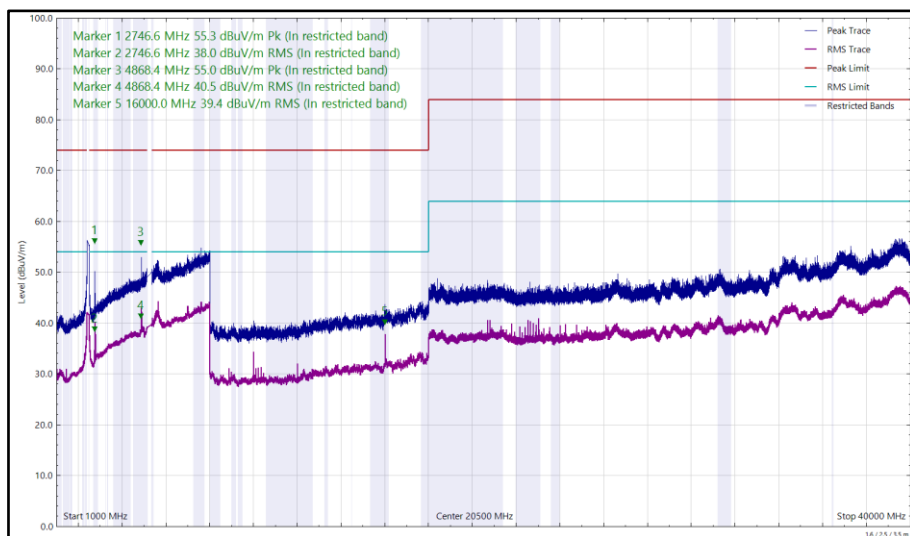

Figure 31 - 2437 MHz (CH6), HT20, Core 1 and 5204 MHz, HDR4, ePA, Core 0, 1 GHz to 40 GHz, Horizontal

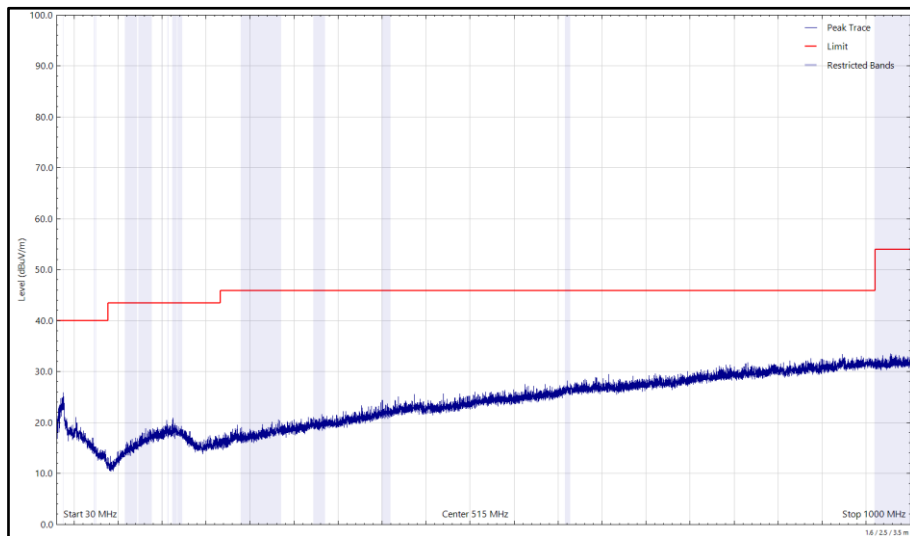

Figure 32 - 2437 MHz (CH6), HT20, Core 1 and 5204 MHz, HDR4, ePA, Core 0, 30 MHz to 1 GHz, Vertical (Peak)

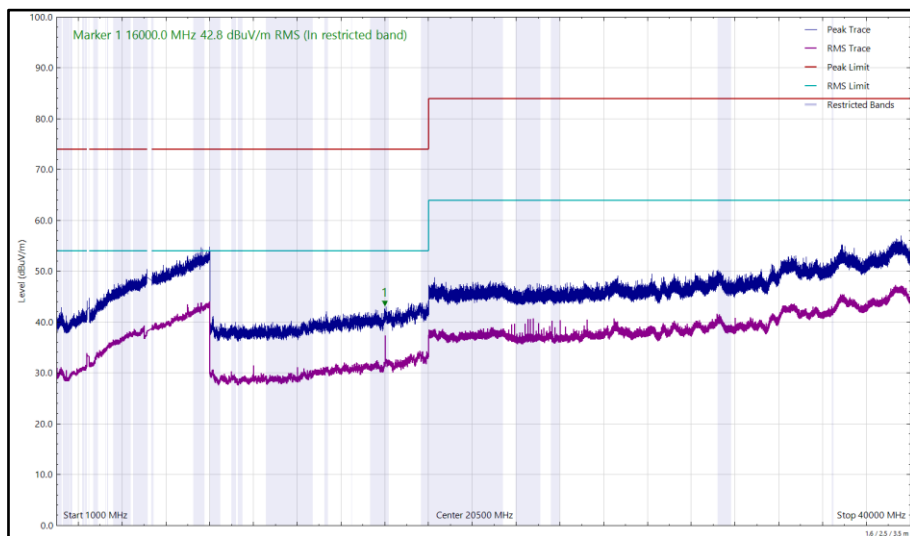

Figure 33 - 2437 MHz (CH6), HT20, Core 1 and 5204 MHz, HDR4, ePA, Core 0, 1 GHz to 40 GHz, Vertical



Frequency (MHz)	Level (dBuV/m)	Limit (dBuV/m)	Margin (dB)	Detector	Angle (°)	Height (cm)	Polarisation
5374.069	41.23	54.00	-12.77	RMS	303	159	Horizontal
16000.025	37.41	54.00	-16.59	RMS	316	210	Vertical
16000.180	41.02	54.00	-12.98	RMS	329	203	Horizontal
22769.249	44.91	54.00	-9.09	RMS	93	100	Vertical

Table 15 - 2437 MHz (CH6), HT20, Core 1 and 5788 MHz, HDR4, ePA, Core 0, 30 MHz to 40 GHz

No other emissions found within 10 dB of the limit.

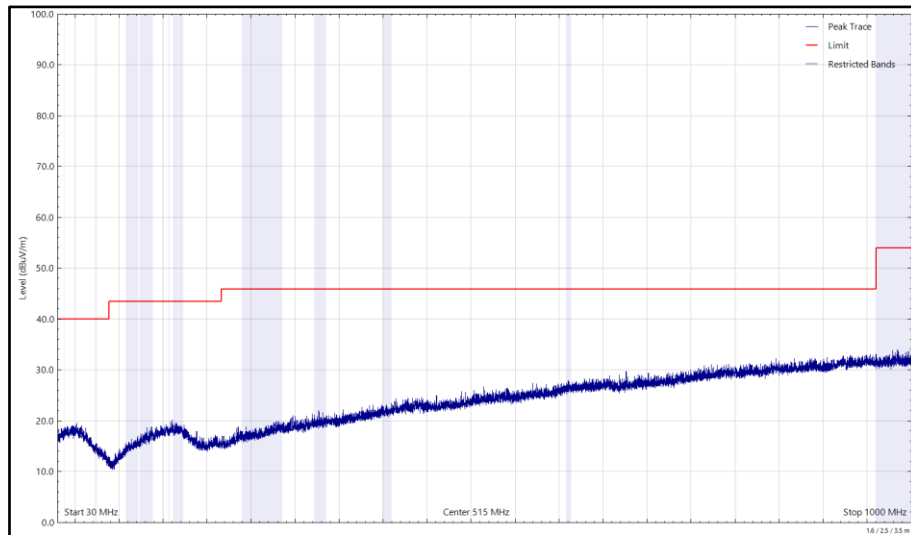

Figure 34 - 2437 MHz (CH6), HT20, Core 1 and 5788 MHz, HDR4, ePA, Core 0, 30 MHz to 1 GHz, Horizontal (Peak)

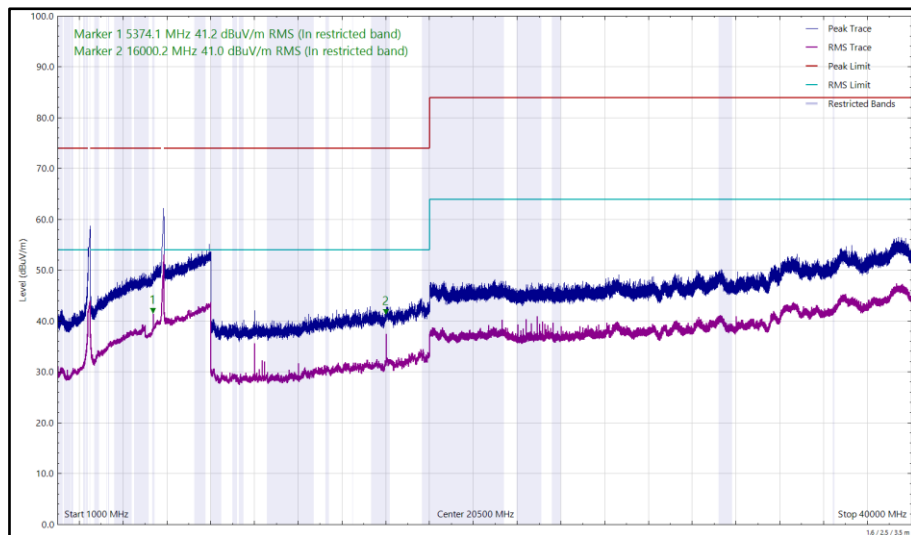

Figure 35 - 2437 MHz (CH6), HT20, Core 1 and 5788 MHz, HDR4, ePA, Core 0, 1 GHz to 40 GHz, Horizontal

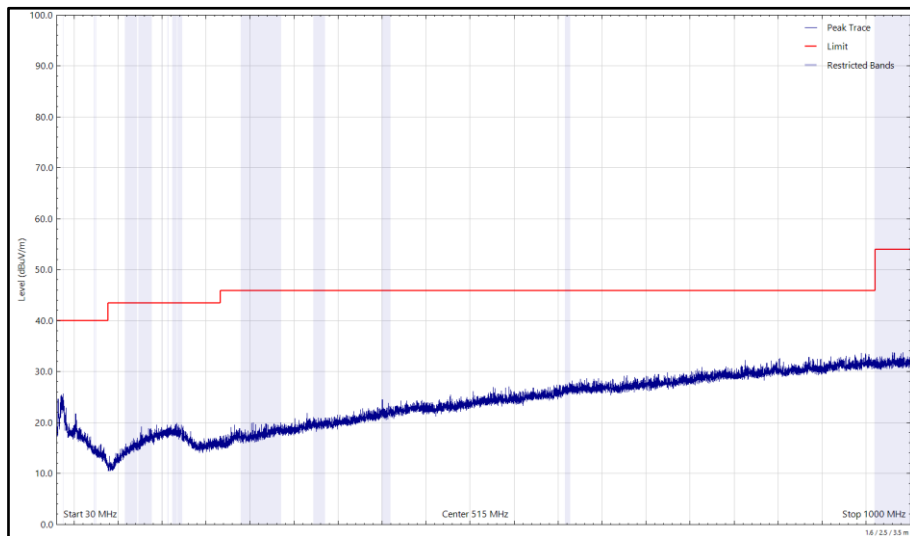

Figure 36 - 2437 MHz (CH6), HT20, Core 1 and 5788 MHz, HDR4, ePA, Core 0, 30 MHz to 1 GHz, Vertical (Peak)

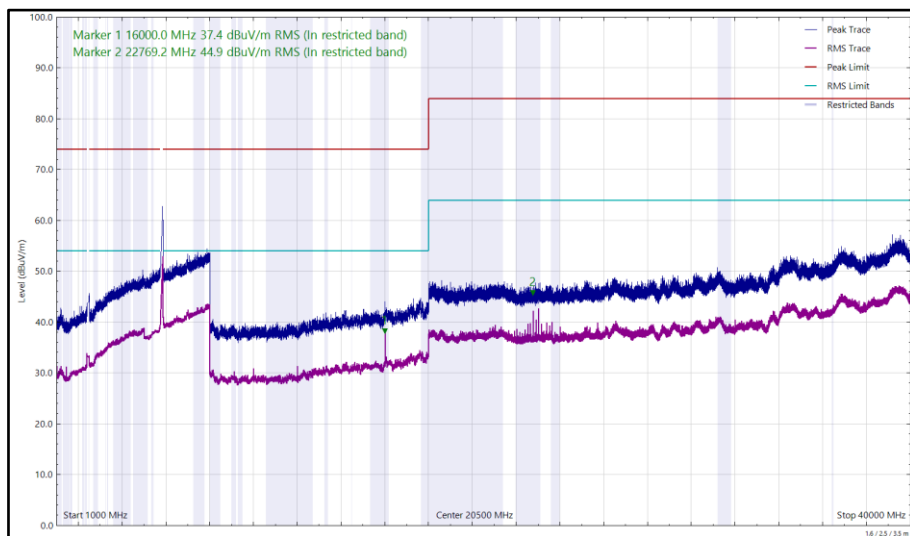

Figure 37 - 2437 MHz (CH6), HT20, Core 1 and 5788 MHz, HDR4, ePA, Core 0, 1 GHz to 40 GHz, Vertical



FCC 47 CFR Part 15, ISED RSS-247 and ISED RSS-GEN

The least stringent limit from the applicable rule parts was used to determine compliance for Radiated Emissions testing of multiple transmission sources.

The least stringent applicable limit was:

Clause	Limit
Part 15.247 (d) / RSS-247 Clause 5.5	-30 dBc
Part 15.407 (b) / RSS-247 Clause 6.2	-27 dBm e.i.r.p
Part 15.209 / RSS-GEN Clause 8.9	Peak: 74 dB μ V/m at 3m, Average 54 dB μ V/m at 3m (Restricted bands > 1 GHz)

Table 16



2.1.8 Test Location and Test Equipment Used

This test was carried out in RF Chamber 14.

Instrument	Manufacturer	Type No.	TE No.	Calibration Period (months)	Calibration Expiry Date
Emissions Software	TUV SUD	EmX V3.1.10	5125	-	Software
EMI Test Receiver	Rohde & Schwarz	ESW44	5912	12	17-Feb-2023
Cable (K Type 2m)	Junkosha	MWX241-02000KMSKMS/B	5937	12	14-May-2023
DRG Horn Antenna (7.5-18GHz)	Schwarzbeck	HWRD750	5941	12	29-May-2023
TRILOG Super Broadband Test Antenna	Schwarzbeck	VULB 9168	5943	24	03-Feb-2024
1500W (300V 12A) AC Power Supply	iTech	IT7324	5955	-	O/P Mon
5m Semi-Anechoic Chamber (Dual-Axis)	Albatross Projects	RF Chamber 14	5958	36	26-Apr-2025
Compact Antenna Mast	Maturo Gmbh	CAM4.0-P	5959	-	TU
Mast & Turntable Controller	Maturo Gmbh	FCU3.0	5960	-	TU
Tilt Antenna Mast	Maturo Gmbh	BAM4.5-P	5961	-	TU
Turntable	Maturo Gmbh	TT1.5SI	5962	-	TU
Cable (SMA to SMA 1m)	Junkosha	MWX221-01000AMSAMS/A	5997	12	06-Jun-2023
Cable (SMA to SMA 6.5m)	Junkosha	MWX221-06500AMSAMS/B	6003	12	07-Jun-2023
Cable (SMA to SMA 1m)	Junkosha	MWX221-01000AMSAMS/A	6008	12	06-Jun-2023
Cable (N to N 1m)	Junkosha	MWX221-01000AMSAMS/B	6009	12	07-Jun-2023
Cable (N to N 7m)	Junkosha	MWX221-07000NMSNMS/B	6016	12	05-Jun-2023
Cable (N to N 8m)	Junkosha	MWX221-08000NMSNMS/A	6017	12	05-Jun-2023
Horn Antenna (1-10 GHz)	Schwarzbeck	BBHA9120B	6141	12	21-Jun-2023
SAC Switch Unit	TUV SUD	TUV_SSU_001	6144	12	05-Dec-2023
Digital Multimeter	Fluke	115	6146	12	16-Jun-2023
Humidity & Temperature meter	R.S Components	1364	6149	12	17-Jun-2023
Double Ridge Active Horn Antenna (18-40 GHz)	Com-Power	AHA-840	6188	24	02-Jun-2024
8GHz Highpass Filter	Wainwright	WHKX 7150 8000 18000 50SS	6194	12	15-Jul-2023
Pre Amp 8 - 18 GHz	Wright Technologies	APS06 0061	6199	12	19-Jul-2023
Attenuator 4dB	Pasternack	PE7074-4	6202	24	16-Jul-2024
Cable (SMA to SMA 20cm)	TUV SUD	MH-FH 8-18	6125	12	25-Jul-2023

Table 17

TU - Traceability Unscheduled
 O/P Mon - Output Monitored using calibrated equipment



3 Measurement Uncertainty

For a 95% confidence level, the measurement uncertainties for defined systems are:

Test Name	Measurement Uncertainty
Radiated Spurious Emissions (Simultaneous Transmission)	30 MHz to 1 GHz: ± 5.2 dB
	1 GHz to 40 GHz: ± 6.3 dB

Table 18

Measurement Uncertainty Decision Rule – Accuracy Method

Determination of conformity with the specification limits is based on the decision rule according to IEC Guide 115:2021, Clause 4.4.3 (Procedure 2). The measurement results are directly compared with the test limit to determine conformance with the requirements of the standard.

Risk: The uncertainty of measurement about the measured result is negligible with regard to the final pass/fail decision. The measurement result can be directly compared with the test limit to determine conformance with the requirement (compare IEC Guide 115). The level of risk to falsely accept and falsely reject items is further described in ILAC-G8.