

# TEST REPORT

**Test Report No. :** UL-RPT-RP14614876JD04A

**Customer :** Apple Inc.

**Model No. :** A2787

**FCC ID :** BCGA2787

**Technology :** NB-FHSS

**Test Standard(s) :** FCC Parts 15.209(a) & 15.407

**Test Laboratory :** UL International (UK) Ltd, Basingstoke, Hampshire, RG24 8AH, United Kingdom

1. This test report shall not be reproduced except in full, without the written approval of UL International (UK) Ltd.
2. The results in this report apply only to the sample(s) tested.
3. The sample tested is in compliance with the above standard(s).
4. The test results in this report are traceable to the national or international standards.
5. Version 1.0

**Date of Issue:** 14 March 2023

**Checked by:**

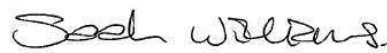

Sarah Williams  
RF Operations Leader, Radio Laboratory

**Sarah Williams**  
Digitally signed by Sarah Williams  
Date: 2023.03.14 16:59:50 Z

**Company Signatory:**



Ben Mercer  
Lead Project Engineer, Radio Laboratory

**Ben Mercer**  
Digitally signed by Ben Mercer  
Date: 2023.03.14 17:00:13 Z



**Customer Information**

<b>Company Name:</b>	Apple Inc.
<b>Address:</b>	One Apple Park Way Cupertino, California 95014 U.S.A.
<b>Contact Name:</b>	Stuart Thomas

**Report Revision History**

<b>Version Number</b>	<b>Issue Date</b>	<b>Revision Details</b>	<b>Revised By</b>
1.0	14/03/2023	Initial Version	Sarah Williams

## **Table of Contents**

<b>Customer Information.....</b>	<b>2</b>
<b>Report Revision History .....</b>	<b>2</b>
<b>1 Attestation of Test Results.....</b>	<b>4</b>
1.1 Description of EUT	4
1.2 General Information	4
1.3 Summary of Test Results	5
1.4 Deviations from the Test Specification	5
<b>2 Summary of Testing.....</b>	<b>6</b>
2.1 Facilities and Accreditation	6
2.2 Methods and Procedures	6
2.3 Calibration and Uncertainty	7
2.4 Test and Measurement Equipment	8
<b>3 Equipment Under Test (EUT) .....</b>	<b>10</b>
3.1 Identification of Equipment Under Test (EUT)	10
3.2 Modifications Incorporated in the EUT	10
3.3 Additional Information Related to Testing	11
3.4 Description of Available Antennas	12
3.5 Description of Test Setup	13
<b>4 Antenna Port Test Results .....</b>	<b>20</b>
4.1 Transmitter Duty Cycle	20
4.2 Transmitter 26 dB Emission Bandwidth	22
4.2.1 5.15-5.25 GHz band	23
4.2.2 5.725-5.85 GHz band	43
4.3 Transmitter Minimum 6 dB Bandwidth (5.725-5.85 GHz band)	63
4.4 Transmitter Maximum Conducted Output Power	84
4.4.1 5.15-5.25 GHz band	84
4.4.2 5.725-5.85 GHz band	106
4.5 Transmitter Maximum Power Spectral Density	128
4.5.1 5.15-5.25 GHz band	128
4.5.2 5.725-5.85 GHz band	133
<b>5 Radiated Test Results.....</b>	<b>138</b>
5.1 Transmitter Out of Band Radiated Emissions <1 GHz	138
5.2 Transmitter Out of Band Radiated Emissions >1 GHz	140
5.2.1 5.15-5.25 GHz band	140
5.2.2 5.725-5.85 GHz band	145
5.3 Transmitter Band Edge Radiated Emissions	150
5.3.1 5.15-5.25 GHz band	150
5.3.2 5.725-5.85 GHz band	166

## **1 Attestation of Test Results**

### **1.1 Description of EUT**

The equipment under test was a rack mounted Apple computer, with Bluetooth® and IEEE 802.11 a/b/g/n/ac/ax Wi-Fi capabilities in the 2.4 GHz, 5 GHz and 6 GHz bands.

### **1.2 General Information**

<b>Specification Reference:</b>	47CFR15.407 and 47CFR15.403
<b>Specification Title:</b>	Code of Federal Regulations Volume 47 (Telecommunications): Part 15 Subpart E (Unlicensed National Information Infrastructure Devices) – Sections 15.403 and 15.407
<b>Specification Reference:</b>	47CFR15.209
<b>Specification Title:</b>	Code of Federal Regulations Volume 47 (Telecommunications): Part 15 Subpart C (Intentional Radiators) - Sections 15.209
<b>Site Registration:</b>	685609
<b>Lab. Designation No.:</b>	UK2011
<b>Location of Testing:</b>	Unit 3 Horizon, Wade Road, Kingsland Business Park, Basingstoke, Hampshire, RG24 8AH, United Kingdom
<b>Test Dates:</b>	21 November 2022 to 08 February 2023

### **1.3 Summary of Test Results**

<b>FCC Reference (47CFR)</b>	<b>Measurement</b>	<b>Result</b>
Part 15.35(c)	Transmitter Duty Cycle	Note 1
Part 15.403	Transmitter 26 dB Emission Bandwidth	Complied
Part 15.407(e)	Transmitter Minimum 6 dB Bandwidth (5.725-5.85 GHz band)	Complied
Part 15.407(a)(1)(iv)	Transmitter Maximum Conducted Output Power (5.15-5.25 GHz band)	Complied
Part 15.407(a)(3)(i)	Transmitter Maximum Conducted Output Power (5.725-5.85 GHz band)	Complied
Part 15.407(a)(1)(iv)	Transmitter Maximum Power Spectral Density (5.15-5.25 GHz band)	Complied
Part 15.407(a)(3)(i)	Transmitter Maximum Power Spectral Density (5.725-5.85 GHz band)	Complied
Part 15.407(b) & 15.209(a)	Transmitter Out of Band Radiated Emissions	Complied
Part 15.407(b) & 15.209(a)	Transmitter Band Edge Radiated Emissions	Complied
Part 15.407(g)	Transmitter Frequency Stability (Temperature & Voltage Variation)	Note 2

#### **Note(s):**

1. The measurement was performed to assist in the calculation of the level of average output power, power spectral density and emissions as the EUT employs pulsed operation.
2. Frequency stability is better than 20 ppm which ensures that the signal remains in the allocated bands under all operational conditions stated in the user manual.

### **1.4 Deviations from the Test Specification**

For the measurements contained within this test report, there were no deviations from, additions to, or exclusions from the test specifications identified above.

## **2 Summary of Testing**

### **2.1 Facilities and Accreditation**

The test site and measurement facilities used to collect data are located at Unit 3 Horizon, Wade Road, Kingsland Business Park, Basingstoke, Hampshire, RG24 8AH, United Kingdom. The following table identifies which facilities were utilised for radiated emission measurements documented in this report. Specific facilities are also identified in the test results sections.

Site 1	X
Site 2	-
Site 17	X

UL International (UK) Ltd is accredited by the United Kingdom Accreditation Service (UKAS). UKAS is one of the signatories to the International Laboratory Accreditation Co-operation (ILAC) Arrangement for the mutual recognition of test reports. The tests reported herein have been performed in accordance with its terms of accreditation.

### **2.2 Methods and Procedures**

<b>Reference:</b>	ANSI C63.10-2013
<b>Title:</b>	American National Standard of Procedures for Compliance Testing of Unlicensed Wireless Devices
<b>Reference:</b>	KDB 789033 D02 General U-NII Test Procedures New Rules v02r01 December 14, 2017
<b>Title:</b>	Guidelines for Compliance Testing of Unlicensed National Information Infrastructure (U-NII) Devices (Part 15, Subpart E)
<b>Reference:</b>	KDB 662911 D01 Multiple Transmitter Output v02r01 October 31, 2013
<b>Title:</b>	Emissions Testing of Transmitters with Multiple Outputs in the Same Band

## **2.3 Calibration and Uncertainty**

### **Measuring Instrument Calibration**

In accordance with UKAS requirements all the measurement equipment is on a calibration schedule. All equipment was within the calibration period on the date of testing.

### **Measurement Uncertainty & Decision Rule**

#### **Overview**

No measurement or test can ever be perfect and the imperfections give rise to error of measurement in the results. Consequently the result of a measurement is only an approximation to the value of the measurand (the specific quantity subject to measurement) and is only complete when accompanied by a statement of the uncertainty of the approximation.

The expression of uncertainty of a measurement result allows realistic comparison of results with reference values and limits given in specifications and standards.

#### **Decision Rule**

The decision rule applied is based upon the accuracy method criteria. The measurement uncertainty is met and the result is considered in conformance with the requirement criteria if the observed value is within the prescribed limit.

#### **Measurement Uncertainty**

The reported expanded uncertainties below are based on a standard uncertainty multiplied by an appropriate coverage factor such that a confidence level of approximately 95% is maintained. For the purposes of this document "approximately" is interpreted as meaning "effectively" or "for most practical purposes".

<b>Measurement Type</b>	<b>Range</b>	<b>Confidence Level (%)</b>	<b>Calculated Uncertainty</b>
Duty Cycle	5.15 GHz to 5.850 GHz	95%	±1.14 %
26 dB Emission Bandwidth	5.15 GHz to 5.850 GHz	95%	±4.59 %
Minimum 6 dB Emission Bandwidth	5.15 GHz to 5.850 GHz	95%	±4.59 %
Maximum Conducted Output Power	5.15 GHz to 5.850 GHz	95%	±1.13 dB
Maximum Power Spectral Density	5.15 GHz to 5.850 GHz	95%	±1.13 dB
Radiated Spurious Emissions	9 kHz to 30 MHz	95%	±5.32 dB
Radiated Spurious Emissions	30 MHz to 1 GHz	95%	±3.30 dB
Radiated Spurious Emissions	1 GHz to 40 GHz	95%	±3.16 dB

The methods used to calculate the above uncertainties are in line with those recommended within the various measurement specifications. Where measurement specifications do not include guidelines for the evaluation of measurement uncertainty the published guidance of the appropriate accreditation body is followed.

## **2.4 Test and Measurement Equipment**

### **Test Equipment Used for Transmitter Duty Cycle, Minimum 6 dB Bandwidth (5.725-5.85 GHz band), Maximum Conducted Output Power and Power Spectral Density**

<b>Asset No.</b>	<b>Instrument</b>	<b>Manufacturer</b>	<b>Type No.</b>	<b>Serial No.</b>	<b>Date Calibration Due</b>	<b>Cal. Interval (Months)</b>
M2037	Thermohygrometer	Testo	608-H1	45124925	08 Dec 2023	12
M2018	Signal Analyser	Rohde & Schwarz	FSV7	102699	05 Oct 2023	12
G0614	Signal Generator	Rohde & Schwarz	SMB100A	177687	19 May 2023	36
A213953	Attenuator	Atlantic Microwave	ATT10KXP-483082-N4N5	21415050	Calibrated before use	-

### **Test Equipment Used for Transmitter 99% Emission Bandwidth**

<b>Asset No.</b>	<b>Instrument</b>	<b>Manufacturer</b>	<b>Type No.</b>	<b>Serial No.</b>	<b>Date Calibration Due</b>	<b>Cal. Interval (Months)</b>
M2037	Thermohygrometer	Testo	608-H1	45124925	08 Dec 2023	12
L217614	Signal Analyser	Keysight	N9030B	MY60070411	22 Apr 2023	12
G0614	Signal Generator	Rohde & Schwarz	SMB100A	177687	19 May 2023	36
A213953	Attenuator	Atlantic Microwave	ATT10KXP-483082-N4N5	21415050	Calibrated before use	-



**Test and Measurement Equipment (continued)****Test Equipment Used for Transmitter Radiated Emissions**

Asset No.	Instrument	Manufacturer	Type No.	Serial No.	Date Calibration Due	Cal. Interval (Months)
M2040	Thermohygrometer	Testo	608-H1	45124934	09 Dec 2023	12
K0001	3m RSE Chamber	Rainford EMC	N/A	N/A	05 Sep 2023	12
M1874	Test Receiver	Rohde & Schwarz	ESU26	100553	19 May 2023	12
A222867	Pre Amplifier	Atlantic Microwave	A-LNAKX-380116-S5S5	210865001	26 Aug 2023	12
A3165	Antenna	ETS-Lindgren	6502	00224383	05 May 2023	12
A3139	Antenna	Schwarzbeck	HWRD 750	00027	22 Aug 2023	12
A3095	High Pass Filter	AtlanTecRF	AFH-07000	18051600012	27 Jan 2023	12
A212041	High Pass Filter	Micro-Tronics	HPS20723	001	27 Jan 2023	12
M2003	Thermohygrometer	Testo	608-H1	45046641	09 Dec 2023	12
K0017	3m RSE Chamber	Rainford EMC	N/A	N/A	08 Nov 2023	12
M1995	Test Receiver	Rohde & Schwarz	ESU40	100428	02 Nov 2023	12
A3167	Pre Amplifier	Com-Power	PAM-103	18020010	02 Nov 2023	12
A2863	Pre Amplifier	Agilent	8449B	3008A02100	07 Nov 2023	12
A223638	Pre-Amplifier	Atlantic Microwave	A-LNAKX-380116-S5S5	210837001	03 Nov 2023	12
A3265	Pre Amplifier	Schwarzbeck	BBV 9721	9721-069	31 Oct 2023	12
A490	Antenna	Chase	CBL6111A	1590	06 Oct 2023	12
A2889	Antenna	Schwarzbeck	BBHA 9120 B	00653	02 Nov 2023	12
A2890	Antenna	Schwarzbeck	HWRD 750	00014	02 Nov 2023	12
A2892	Antenna	Schwarzbeck	BBHA 9170	9170-727	31 Oct 2023	12
A2148	Attenuator	AtlanTecRF	AN18-06	090202-06	06 Oct 2023	12
A2889	Antenna	Schwarzbeck	BBHA 9120 B	00653	02 Nov 2023	12
A3036	Low Pass Filter	AtlanTecRF	AFL-02000	15062902848	25 Jan 2024	12
A212038	High Pass Filter	Micro-Tronics	HPS20723	004	25 Jan 2024	12

**Test Equipment Used for Transmitter Band Edge Radiated Emissions**

Asset No.	Instrument	Manufacturer	Type No.	Serial No.	Date Calibration Due	Cal. Interval (Months)
M2003	Thermohygrometer	Testo	608-H1	45046641	09 Dec 2023	12
K0017	3m RSE Chamber	Rainford EMC	N/A	N/A	08 Nov 2023	12
M1995	Test Receiver	Rohde & Schwarz	ESU40	100428	02 Nov 2023	12
A2863	Pre Amplifier	Agilent	8449B	3008A02100	07 Nov 2023	12
A2889	Antenna	Schwarzbeck	BBHA 9120 B	00653	02 Nov 2023	12
A2916	Attenuator	AtlanTecRF	AN18W5-10	832827#2	26 Jan 2023	12

### **3 Equipment Under Test (EUT)**

#### **3.1 Identification of Equipment Under Test (EUT)**

<b>Brand Name:</b>	Apple
<b>Model Name or Number:</b>	A2787
<b>Test Sample Serial Number:</b>	FQP20QF2CT ( <i>Radiated sample #1</i> )
<b>Hardware Version:</b>	REV 1.0
<b>Software Version:</b>	22E51010k
<b>FCC ID:</b>	BCGA2787
<b>Date of Receipt:</b>	14 November 2022

<b>Brand Name:</b>	Apple
<b>Model Name or Number:</b>	A2787
<b>Test Sample Serial Number:</b>	C2QY43Q3QM ( <i>Radiated sample #2</i> )
<b>Hardware Version:</b>	REV 1.0
<b>Software Version:</b>	22E71580u
<b>FCC ID:</b>	BCGA2787
<b>Date of Receipt:</b>	11 January 2023

<b>Brand Name:</b>	Apple
<b>Model Name or Number:</b>	A2787
<b>Test Sample Serial Number:</b>	CQCHHKN7YM ( <i>Conducted sample</i> )
<b>Hardware Version:</b>	REV 1.0
<b>Software Version:</b>	22E71580u
<b>FCC ID:</b>	BCGA2787
<b>Date of Receipt:</b>	24 January 2023

#### **3.2 Modifications Incorporated in the EUT**

No modifications were applied to the EUT during testing.

**3.3 Additional Information Related to Testing**

<b>Technology Tested:</b>	NarrowBand FHSS		
<b>Type of Unit:</b>	Transceiver		
<b>Mode:</b>	Basic Rate	High Data Rate	
<b>Modulation:</b>	GFSK	$\pi/4$ -DQPSK	
<b>Packet Type (Maximum Payload):</b>	DH5	4DH5	8DH5
<b>Data Rate (Mbit/s):</b>	1	4	8
<b>Power Supply Requirement:</b>	Nominal	12.0 VDC via 120 VAC 60 Hz adaptor	
<b>Maximum Conducted Output Power:</b>	DH5	12.7 dBm	
	4DH5	13.7 dBm	
	8DH5	13.9 dBm	
<b>Channel Bandwidth(s):</b>	1, 2 & 4 MHz		
<b>Transmit Frequency Range:</b>	5150 MHz to 5250 MHz		
<b>Transmit Channels Tested:</b>	<b>Channel ID</b>	<b>Channel Frequency (MHz)</b>	
	Bottom	5162	
	Middle	5203	
	Top	5245	
<b>Transmit Frequency Range:</b>	5725 MHz to 5850 MHz		
<b>Transmit Channels Tested:</b>	<b>Channel ID</b>	<b>Channel Frequency (MHz)</b>	
	Bottom	5733	
	Middle	5788	
	Top	5844	

### **3.4 Description of Available Antennas**

The radio utilizes two integrated antennas, with the following maximum gains:

Antenna Port	Frequency Range (MHz)	Antenna Gain (dBi)
Core 0	5150 to 5250	9.7
	5725 to 5850	8.4
Core 1	5150 to 5250	6.9
	5725 to 5850	9.2

The EUT also supports TxBF with unequal gains and equal transmit powers. Calculations for directional gain were in accordance with KDB 662911 D01 v02r01 Section F)2)d)(i). Directional gain of Core 0 & Core 1 was calculated as:

#### **Frequency Band 5150-5250 MHz**

$N_{SS}=1$ ,  $N_{ANT}=2$ ,  $G_1 = G_{Core\ 0} = 9.7$  dBi,  $G_2 = G_{Core\ 1} = 6.9$  dBi:

$$\begin{aligned} \text{Directional Gain} &= 10 \log \left[ \frac{\left( 10^{\frac{G_1}{20}} + 10^{\frac{G_2}{20}} + \dots + 10^{\frac{G_N}{20}} \right)^2}{N_{ANT}} \right] = 10 \log \left[ \frac{\left( 10^{\frac{G_1}{20}} + 10^{\frac{G_2}{20}} \right)^2}{2} \right] \\ &= 10 \log \left[ \frac{\left( 10^{\frac{9.7}{20}} + 10^{\frac{6.9}{20}} \right)^2}{2} \right] = 11.4 \text{ dBi} \end{aligned}$$

#### **Frequency Band 5725-5850 MHz**

$N_{SS}=1$ ,  $N_{ANT}=2$ ,  $G_1 = G_{ANTENNA\ Core\ 0} = 8.4$  dBi,  $G_2 = G_{ANTENNA\ Core\ 1} = 9.2$  dBi:

$$\begin{aligned} \text{Directional Gain} &= 10 \log \left[ \frac{\left( 10^{\frac{G_1}{20}} + 10^{\frac{G_2}{20}} + \dots + 10^{\frac{G_N}{20}} \right)^2}{N_{ANT}} \right] = 10 \log \left[ \frac{\left( 10^{\frac{G_1}{20}} + 10^{\frac{G_2}{20}} \right)^2}{2} \right] \\ &= 10 \log \left[ \frac{\left( 10^{\frac{8.4}{20}} + 10^{\frac{9.2}{20}} \right)^2}{2} \right] = 11.8 \text{ dBi} \end{aligned}$$

### **3.5 Description of Test Setup**

#### **Support Equipment**

The following support equipment was used to exercise the EUT during testing:

<b>Description:</b>	Test Laptop
<b>Brand Name:</b>	Apple
<b>Model Name or Number:</b>	MacBook Pro
<b>Serial Number:</b>	FVFDH03JQ05G

<b>Description:</b>	USB Diagnostic Cable
<b>Brand Name:</b>	Apple
<b>Model Name or Number:</b>	Chimp
<b>Serial Number:</b>	428CBE

<b>Description:</b>	Test Laptop
<b>Brand Name:</b>	Apple
<b>Model Name or Number:</b>	MacBook Pro
<b>Serial Number:</b>	C02DJ05D0HDF

<b>Description:</b>	USB Diagnostic Cable
<b>Brand Name:</b>	Apple
<b>Model Name or Number:</b>	Chimp
<b>Serial Number:</b>	427A65

<b>Description:</b>	Test Laptop
<b>Brand Name:</b>	Apple
<b>Model Name or Number:</b>	MacBook Pro
<b>Serial Number:</b>	C02C800FP0CW

<b>Description:</b>	USB Diagnostic Cable
<b>Brand Name:</b>	Apple
<b>Model Name or Number:</b>	Chimp
<b>Serial Number:</b>	428A48

<b>Description:</b>	Termination – Laptop 1
<b>Brand Name:</b>	Dell
<b>Model Name or Number:</b>	Latitude 54300
<b>Serial Number:</b>	2089G4J

**Support Equipment (continued)**

<b>Description:</b>	Termination – Laptop 2
<b>Brand Name:</b>	Lenovo
<b>Model Name or Number:</b>	ThinkPad L440
<b>Serial Number:</b>	R9-019EA2 14/04

<b>Description:</b>	USB Hub
<b>Brand Name:</b>	Hama
<b>Model Name or Number:</b>	USB 2.0
<b>Serial Number:</b>	00078498

<b>Description:</b>	USB-C Cables. Quantity 2. Length 3m.
<b>Brand Name:</b>	Nimaso
<b>Model Name or Number:</b>	Not marked or stated
<b>Serial Number:</b>	Not marked or stated

<b>Description:</b>	USB-A Cables. Quantity 8. Length 3m.
<b>Brand Name:</b>	Not marked or stated
<b>Model Name or Number:</b>	Not marked or stated
<b>Serial Number:</b>	Not marked or stated

<b>Description:</b>	Personal Hands Free (PHF)
<b>Brand Name:</b>	Not marked or stated
<b>Model Name or Number:</b>	Not marked or stated
<b>Serial Number:</b>	Not marked or stated

<b>Description:</b>	Ethernet Cable. Quantity 2. Length 3m.
<b>Brand Name:</b>	Not marked or stated
<b>Model Name or Number:</b>	Not marked or stated
<b>Serial Number:</b>	Not marked or stated

<b>Description:</b>	USB A to C Adaptor. Quantity 8.
<b>Brand Name:</b>	Not marked or stated
<b>Model Name or Number:</b>	Not marked or stated
<b>Serial Number:</b>	Not marked or stated

**Support Equipment (continued)**

<b>Description:</b>	HDMI Cables. Quantity 2. Length 3m.
<b>Brand Name:</b>	KabelDirekt
<b>Model Name or Number:</b>	Not marked or stated
<b>Serial Number:</b>	Not marked or stated

## **Operating Modes**

The EUT was tested in the following operating mode(s):

- Continuously transmitting with a modulated carrier at maximum power on the bottom, middle and top channels as required using the supported packet types.
- Transmitting on Core 0 or Core 1 in SISO configuration or Core 0 + Core 1 in Transmitter Beamforming configuration, on either the iPA or ePA path.

## **Configuration and Peripherals**

The EUT was tested in the following configuration(s):

- A test laptop with the customer's test application was used to place the EUT into NarrowBand test mode. The application was used to enable continuous transmission and to select the test channels & packet types as required. The customer supplied instructions to configure the EUT into test mode.
- The customer supplied U.FL RF cables with the EUT in order to perform conducted measurements. The measured additional path loss was included in any path loss calculations.
- RF cables and attenuators connecting the test equipment to the EUT were calibrated before use and the calibration data incorporated into the conducted measurement results.
- The EUT was powered from a 120 VAC 60 Hz single phase mains supply.
- Transmitter radiated spurious emissions tests were performed with the EUT transmitting in 4DH5 Beamforming / Core 0 + Core 1 / ePA, as this mode was found to transmit the highest spectral density.
- Radiated spurious emissions were performed with the EUT in the position that produced worst case with respect to emissions. All ports were terminated into suitable terminations and placed under the turntable.
- Transmitter radiated band edge measurement were performed with the EUT Y orientation/position as declared by the customer.



**Test Setup Diagrams**

**Conducted Tests:**

**Test Setup for Transmitter Conducted Tests**

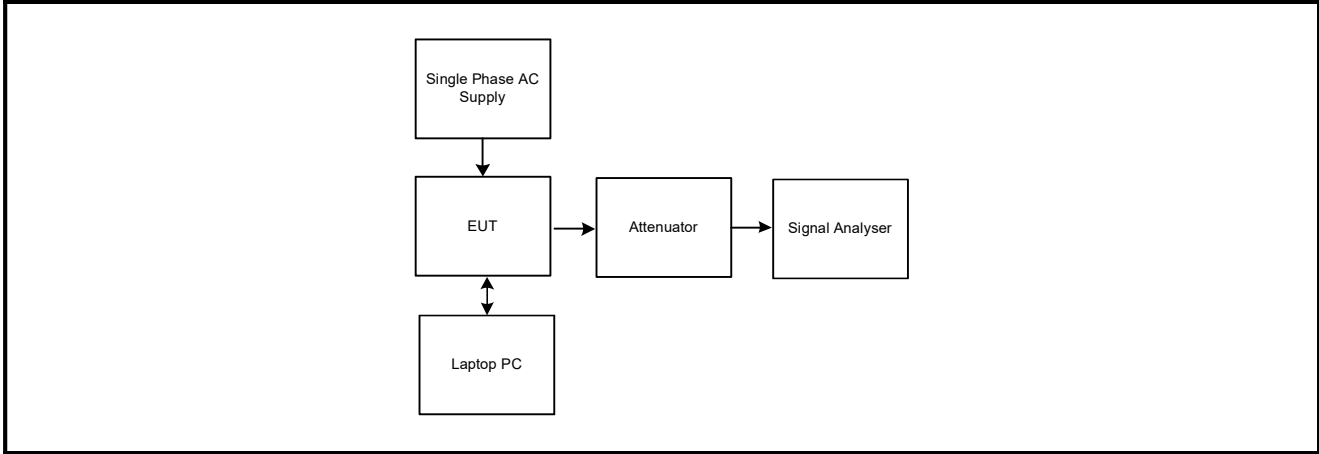

**Radiated Tests:**

**Test Setup for Transmitter Radiated Emissions**

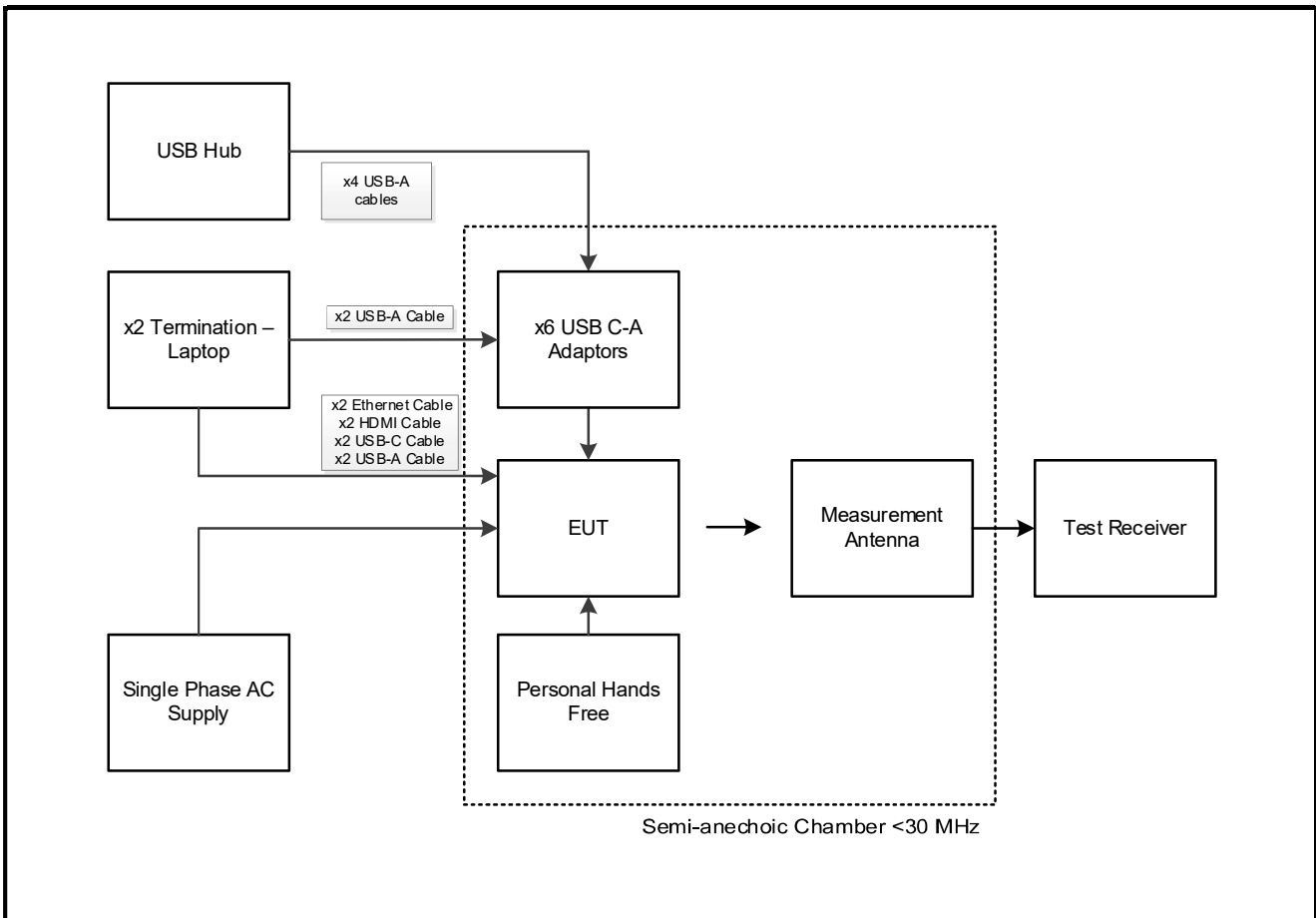

**Test Setup Diagrams (continued)**

**Test Setup for Transmitter Radiated Emissions (continued)**

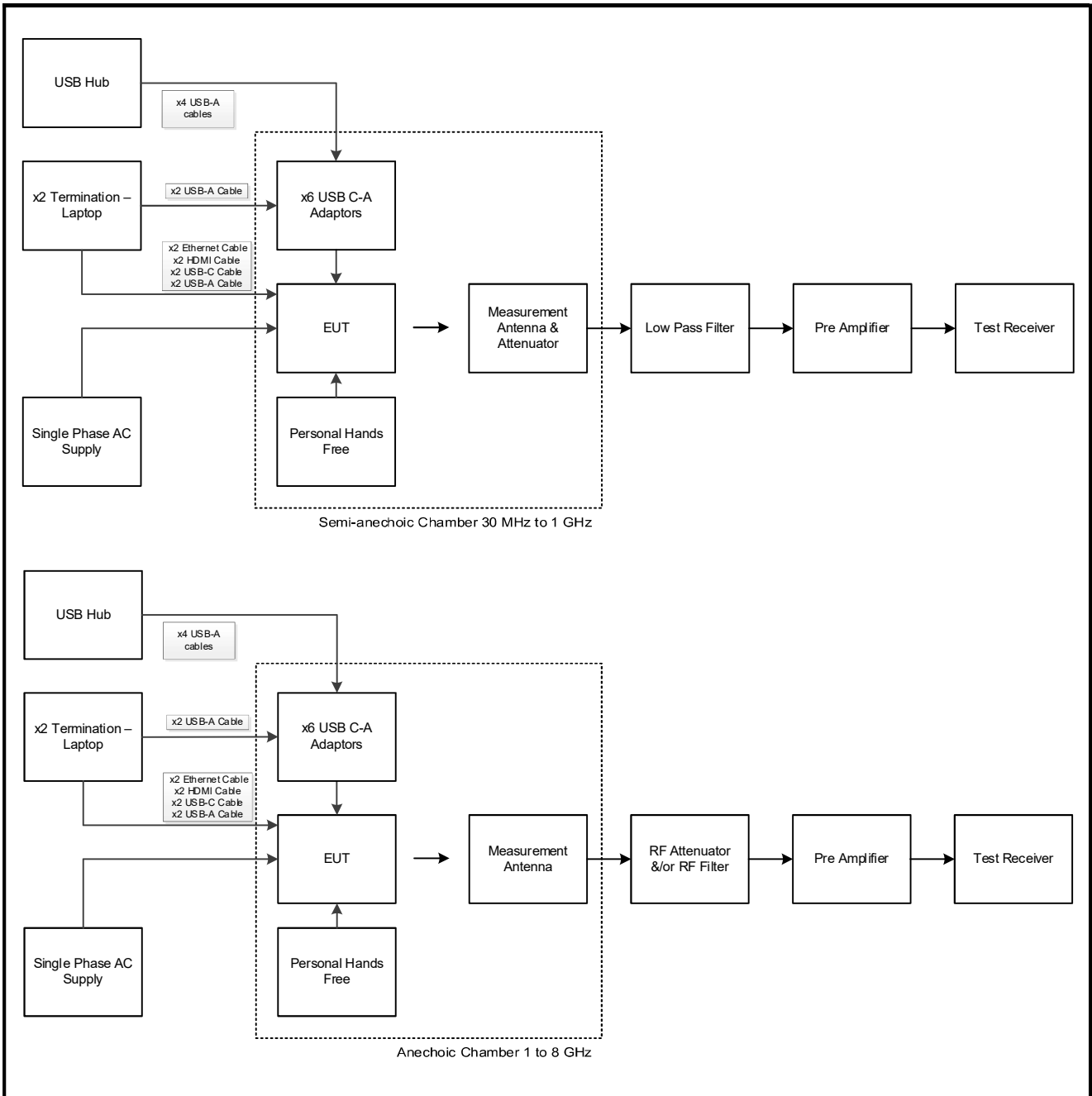

**Test Setup Diagrams (continued)**

**Test Setup for Transmitter Radiated Emissions (continued)**

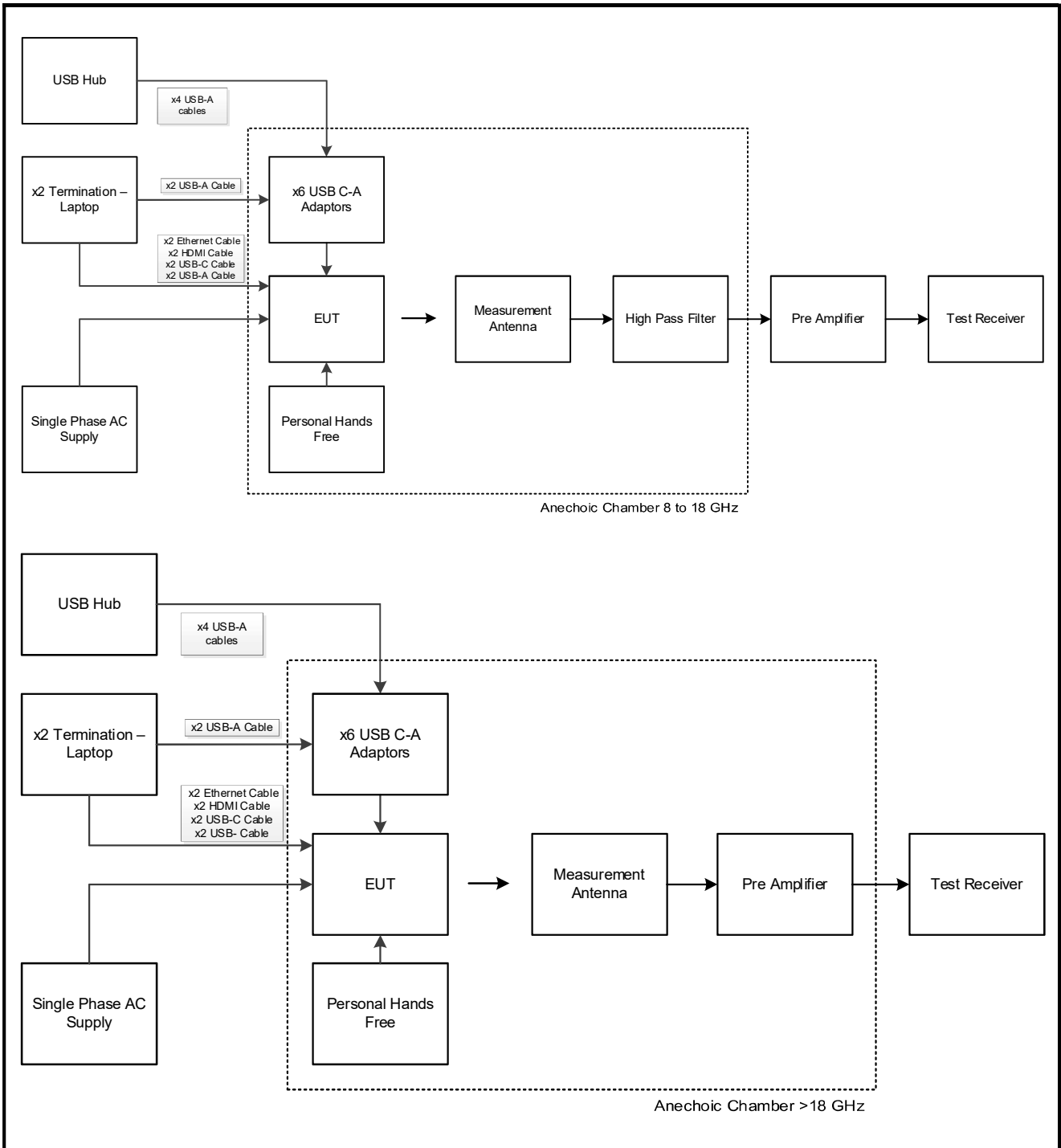

## **4 Antenna Port Test Results**

### **4.1 Transmitter Duty Cycle**

#### **Test Summary:**

<b>Test Engineers:</b>	Luis Pazos Perez & Jose Bayona	<b>Test Date:</b>	30 January 2023
<b>Test Sample Serial Number:</b>	CQCHHKN7YM		

<b>FCC Reference:</b>	Part 15.35(c)
<b>Test Method Used:</b>	KDB 789033 D02 Section II.B.2.b)

#### **Environmental Conditions:**

<b>Temperature (°C):</b>	20
<b>Relative Humidity (%):</b>	41

#### **Note(s):**

- In order to assist with the determination of the average level of fundamental and spurious emissions field strength, measurements were made of duty cycle to determine the transmission duration and the silent period time of the transmitter. The transmitter duty cycle was measured using a spectrum analyser in the time domain and calculated by using the following calculation:

$$10 \log 1 / (\text{On Time} / [\text{Period or } 100\text{ms whichever is the lesser}]).$$

$$DH5 \text{ duty cycle: } 10 \log (1 / (2.900/3.760)) = 1.1 \text{ dB}$$

- 4DH5 and 8DH5 modes duty cycle were measured and found to be greater than 98%. No duty cycle correction is required to assist with calculating the average emission levels.
- The signal analyser was connected to the RF port on the EUT using an RF switch, suitable attenuation and RF cables. An RF level offset was entered on the signal analyser to compensate for the loss of the switch, attenuators and RF cables.

**Transmitter Duty Cycle (continued)**

**Results: DH5**

Pulse Duration (ms)	Period (ms)	Duty Cycle (dB)
2.900	3.760	1.1

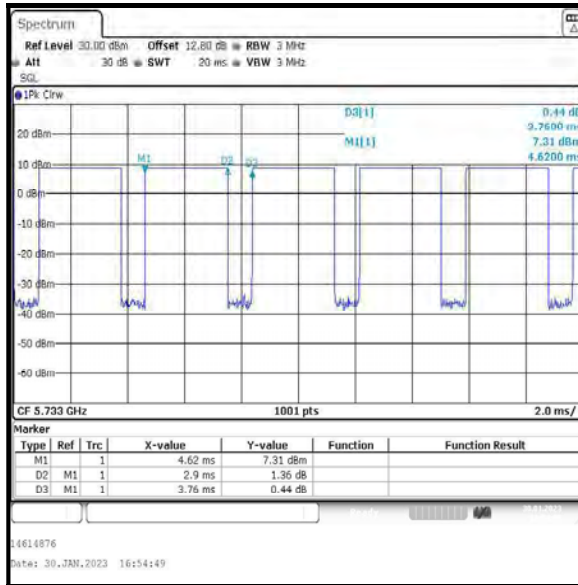

## **4.2 Transmitter 26 dB Emission Bandwidth**

### **Test Summary:**

<b>Test Engineers:</b>	Jose Bayona & Luis Pazos Perez	<b>Test Dates:</b>	27 January 2023 & 30 January 2023
<b>Test Sample Serial Number:</b>	CQCHHKN7YM		

<b>FCC Reference:</b>	Part 15.403
<b>Test Method Used:</b>	KDB 789033 D02 Section II.C.1.

### **Environmental Conditions:**

<b>Temperatures (°C):</b>	20 to 22
<b>Relative Humidity (%):</b>	33 to 41

### **Note(s):**

1. The signal analyser's resolution bandwidth was set to approximately 1% of the measured 26 dB emission bandwidth.
2. The signal analyser was connected to the RF port on the EUT using suitable attenuation and RF cable.

**Transmitter 26 dB Emission Bandwidth (5.15-5.25 GHz band) (continued)**

**4.2.1 5.15-5.25 GHz band**

**Results: DH5 / SISO / Core 0 / iPA**

Channel	Frequency (MHz)	26 dB Emission Bandwidth (MHz)
Bottom	5162	1.250
Middle	5203	1.249
Top	5245	1.247

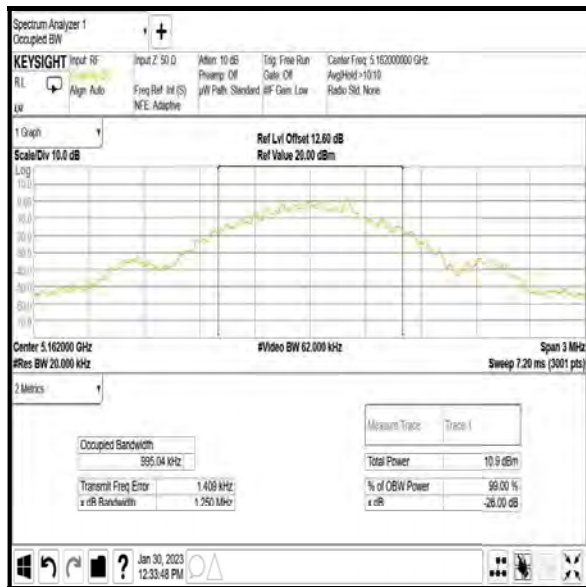

**Bottom Channel**

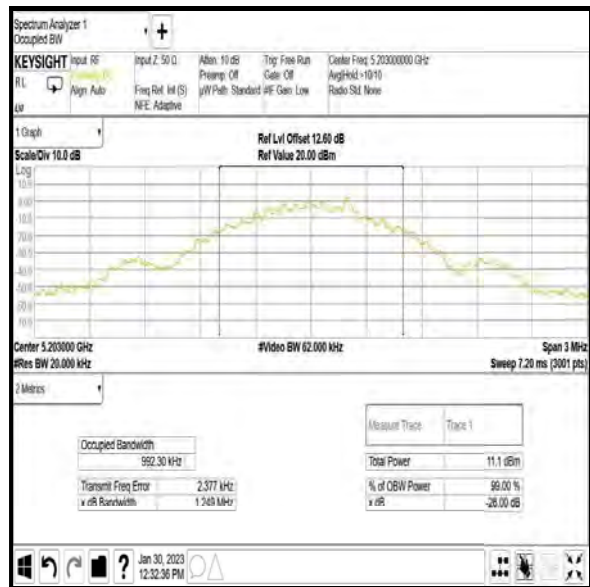

**Middle Channel**

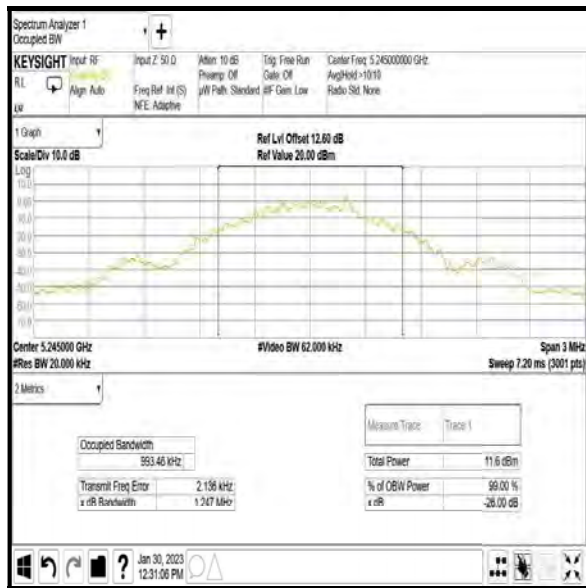

**Top Channel**

**Transmitter 26 dB Emission Bandwidth (5.15-5.25 GHz band) (continued)**

**Results: 4DH5 / SISO / Core 0 / iPA**

Channel	Frequency (MHz)	26 dB Emission Bandwidth (MHz)
Bottom	5162	2.780
Middle	5203	2.778
Top	5245	2.784

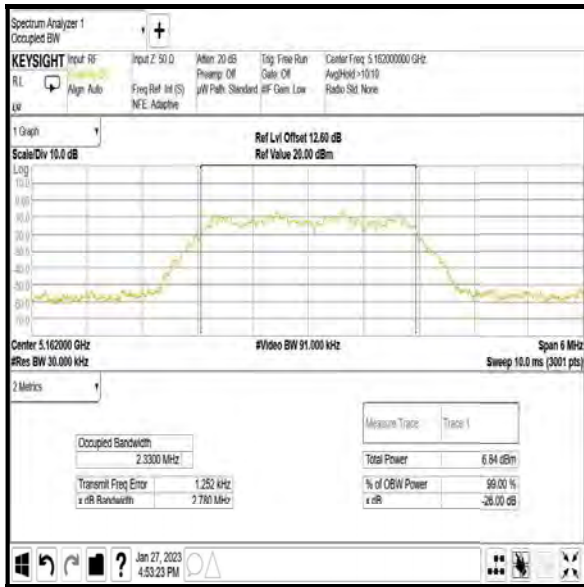

Bottom Channel

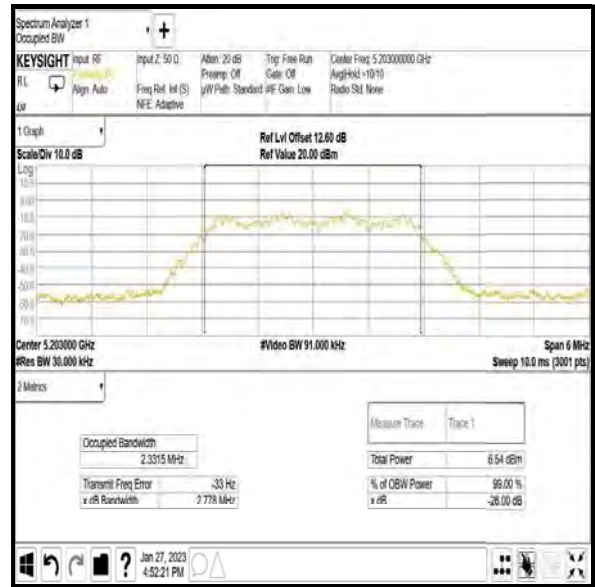

Middle Channel

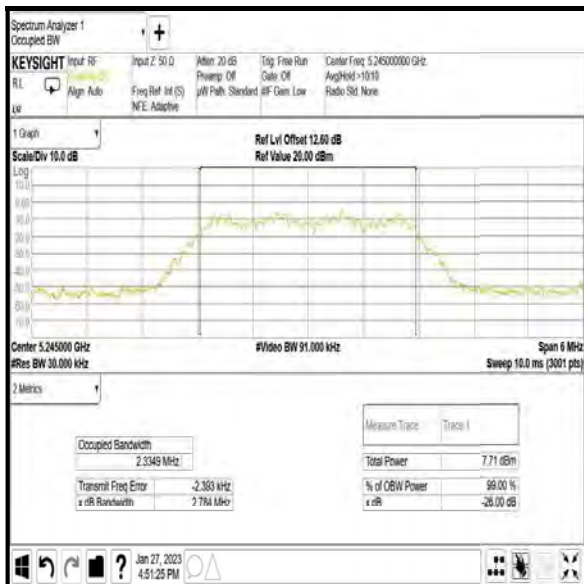

Top Channel



**Transmitter 26 dB Emission Bandwidth (5.15-5.25 GHz band) (continued)**

**Results: 4DH5 / SISO / Core 0 / ePA**

Channel	Frequency (MHz)	26 dB Emission Bandwidth (MHz)
Bottom	5162	2.780
Middle	5203	2.782
Top	5245	2.781

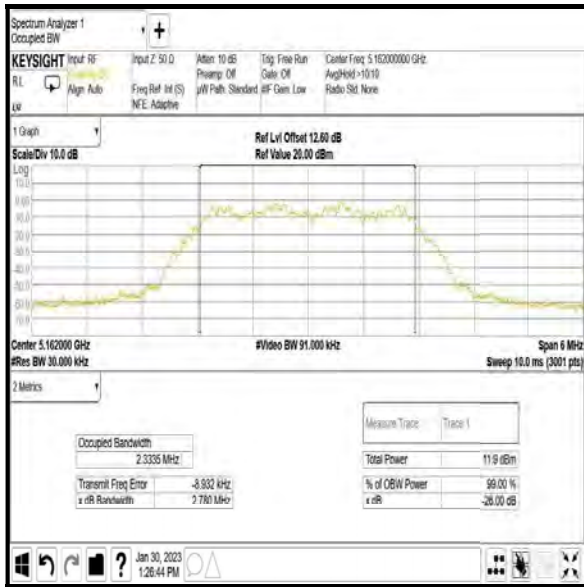

Bottom Channel

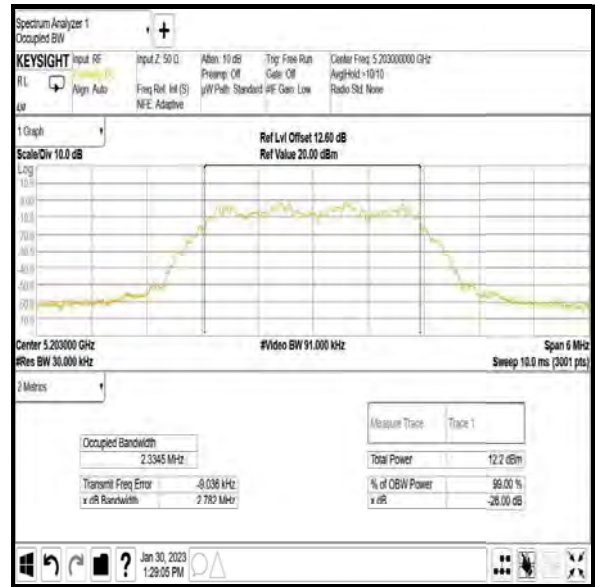

Middle Channel

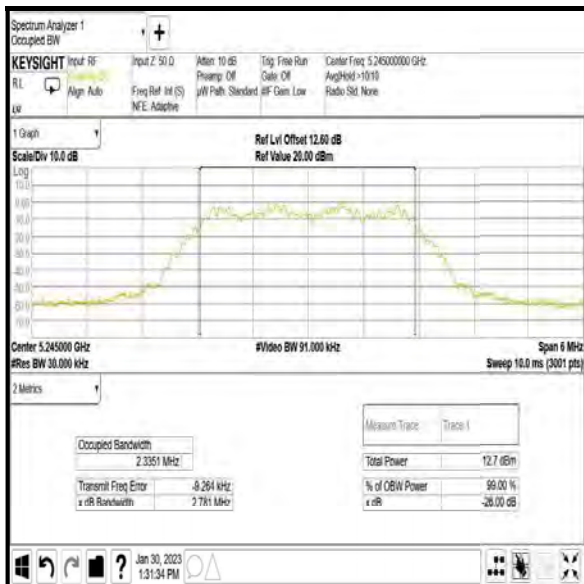

Top Channel

**Transmitter 26 dB Emission Bandwidth (5.15-5.25 GHz band) (continued)**

**Results: 8DH5 / SISO / Core 0 / iPA**

Channel	Frequency (MHz)	26 dB Emission Bandwidth (MHz)
Bottom	5162	5.700
Middle	5203	5.694
Top	5245	5.695

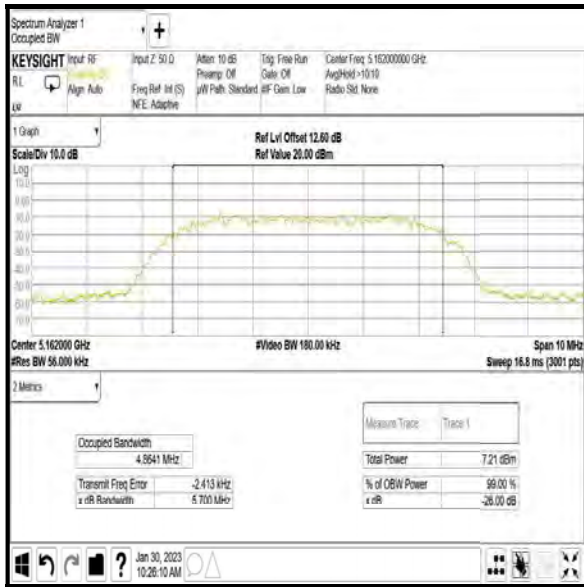

Bottom Channel

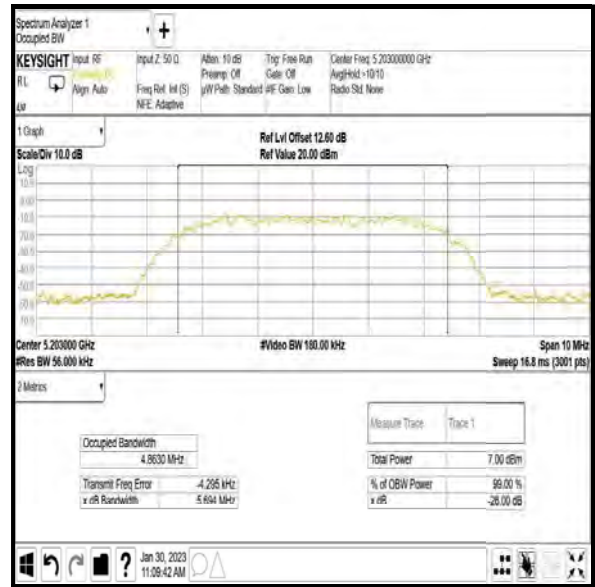

Middle Channel

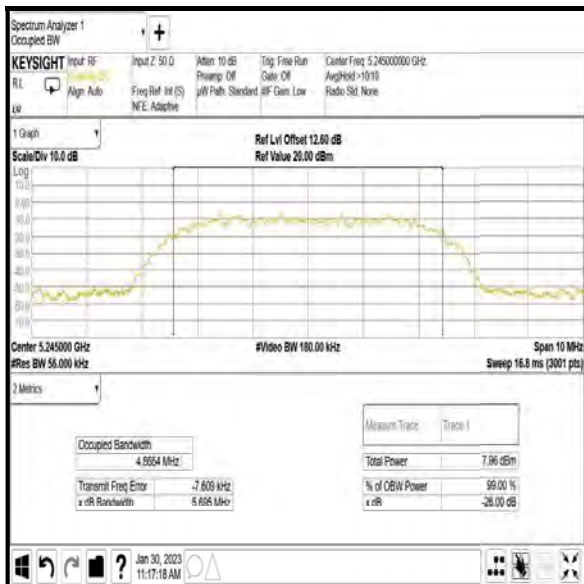

Top Channel

**Transmitter 26 dB Emission Bandwidth (5.15-5.25 GHz band) (continued)**

**Results: 8DH5 / SISO / Core 0 / ePA**

Channel	Frequency (MHz)	26 dB Emission Bandwidth (MHz)
Bottom	5162	5.673
Middle	5203	5.674
Top	5245	5.675

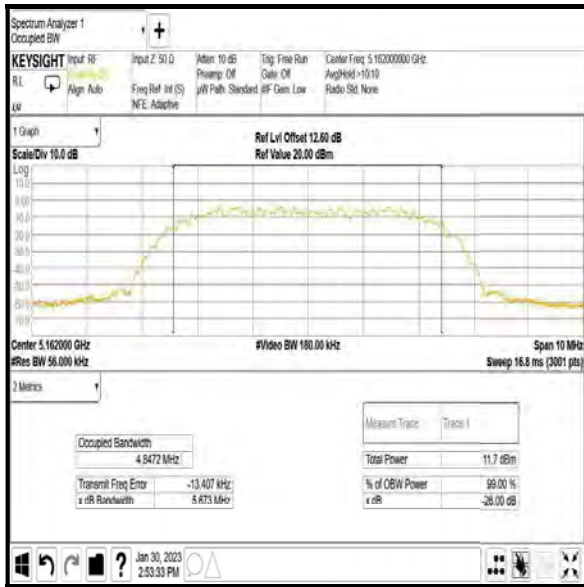

Bottom Channel

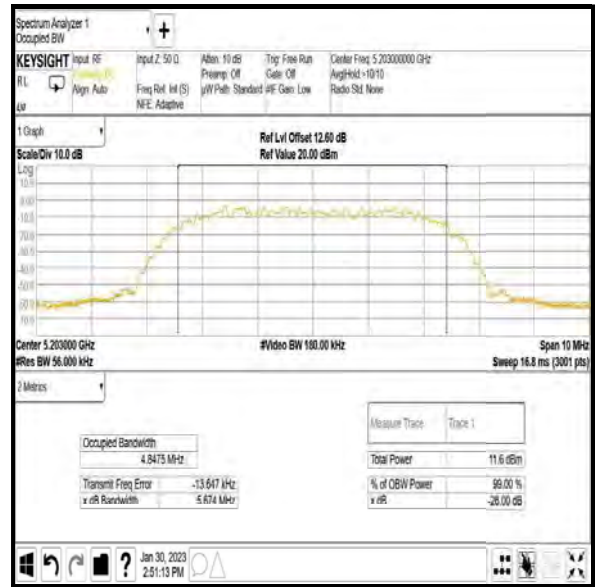

Middle Channel

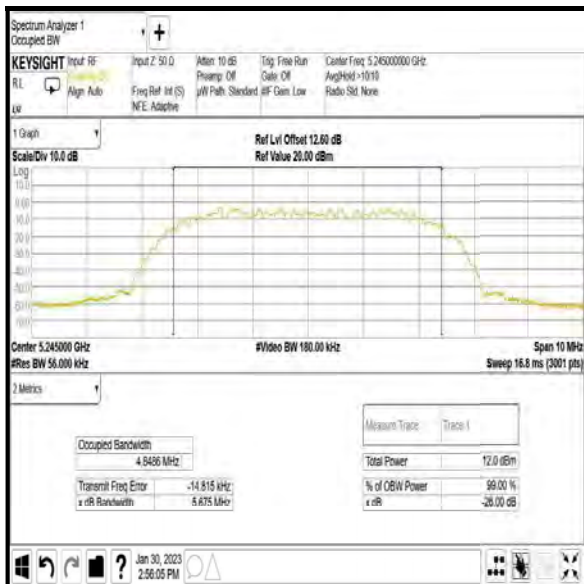

Top Channel

**Transmitter 26 dB Emission Bandwidth (5.15-5.25 GHz band) (continued)**

**Results: DH5 / SISO / Core 1 / iPA**

Channel	Frequency (MHz)	26 dB Emission Bandwidth (MHz)
Bottom	5162	1.247
Middle	5203	1.247
Top	5245	1.247

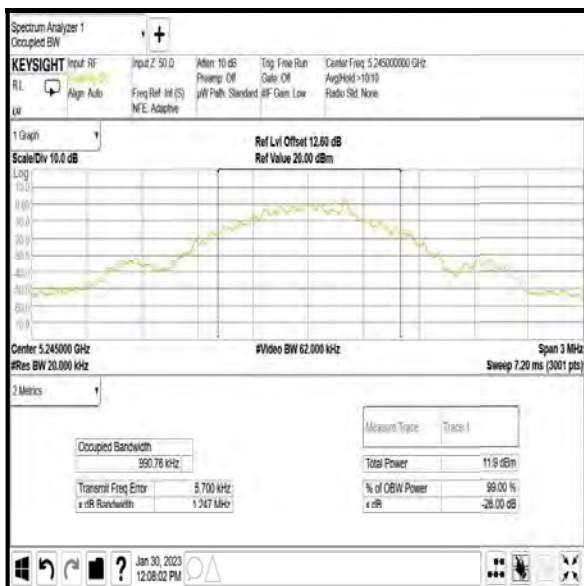
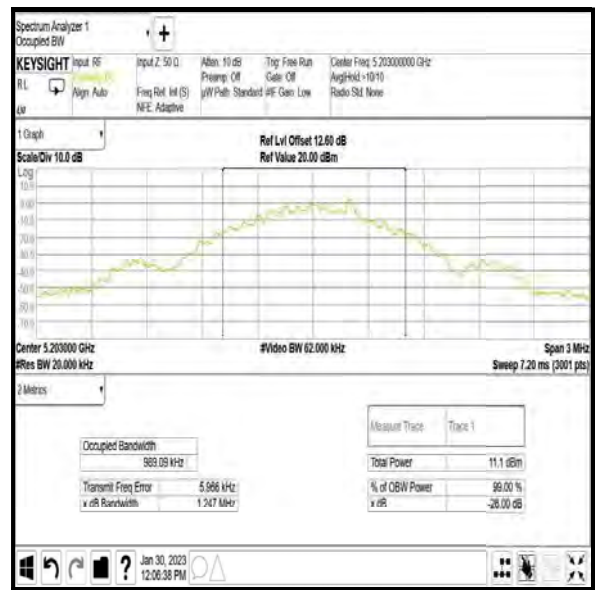
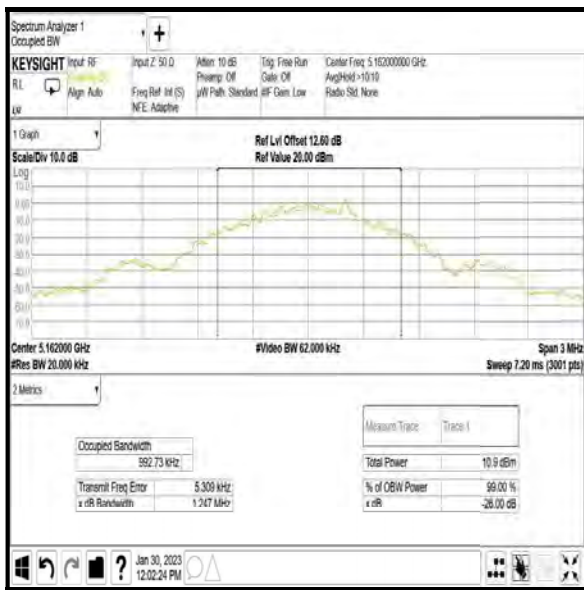

**Transmitter 26 dB Emission Bandwidth (5.15-5.25 GHz band) (continued)**

**Results: 4DH5 / SISO / Core 1 / iPA**

Channel	Frequency (MHz)	26 dB Emission Bandwidth (MHz)
Bottom	5162	2.780
Middle	5203	2.777
Top	5245	2.777

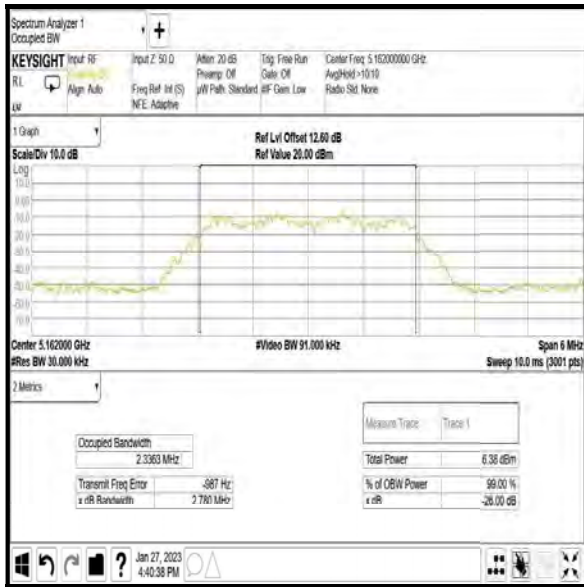

Bottom Channel

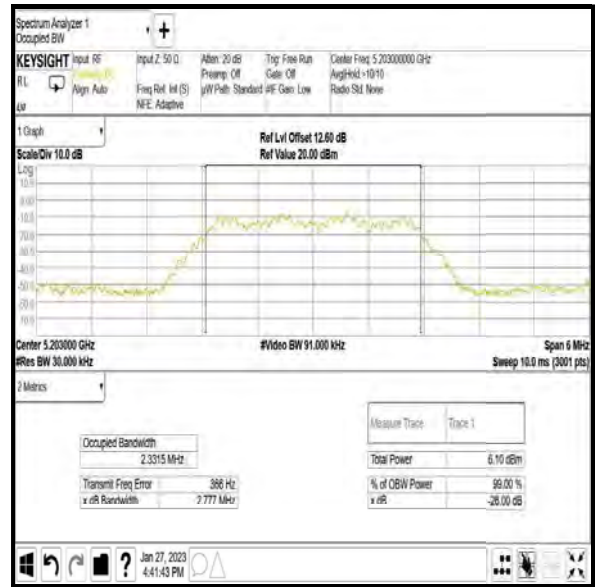

Middle Channel

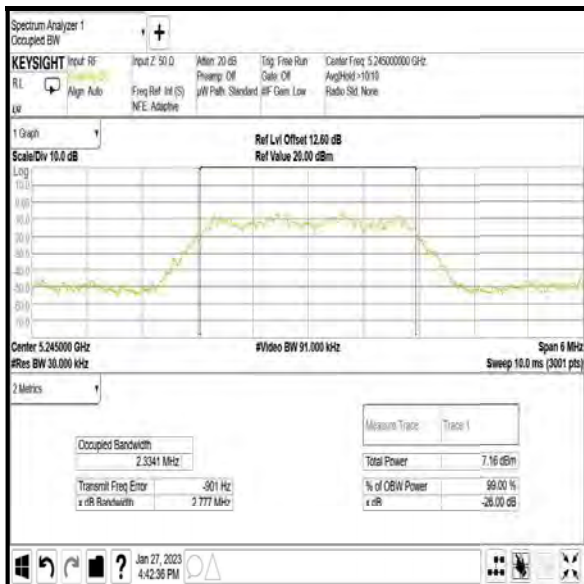

Top Channel

**Transmitter 26 dB Emission Bandwidth (5.15-5.25 GHz band) (continued)**

**Results: 4DH5 / SISO / Core 1 / ePA**

Channel	Frequency (MHz)	26 dB Emission Bandwidth (MHz)
Bottom	5162	2.779
Middle	5203	2.777
Top	5245	2.777

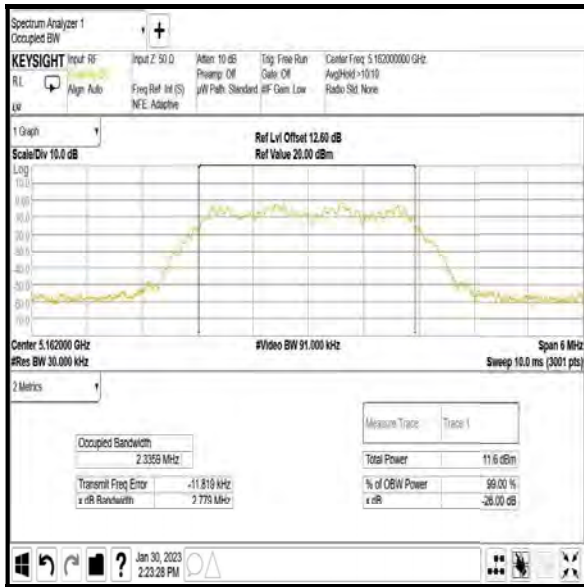

Bottom Channel

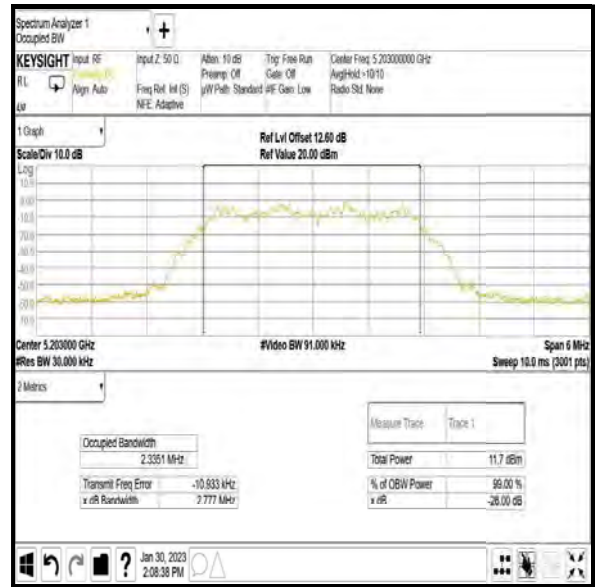

Middle Channel

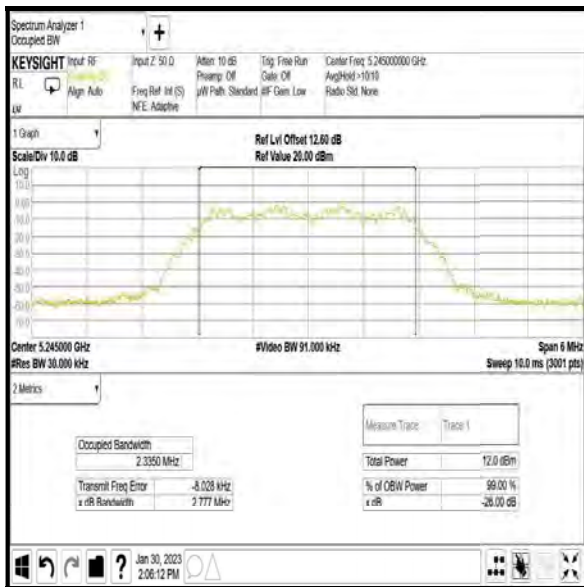

Top Channel

**Transmitter 26 dB Emission Bandwidth (5.15-5.25 GHz band) (continued)**

**Results: 8DH5 / SISO / Core 1 / iPA**

Channel	Frequency (MHz)	26 dB Emission Bandwidth (MHz)
Bottom	5162	5.699
Middle	5203	5.706
Top	5245	5.704

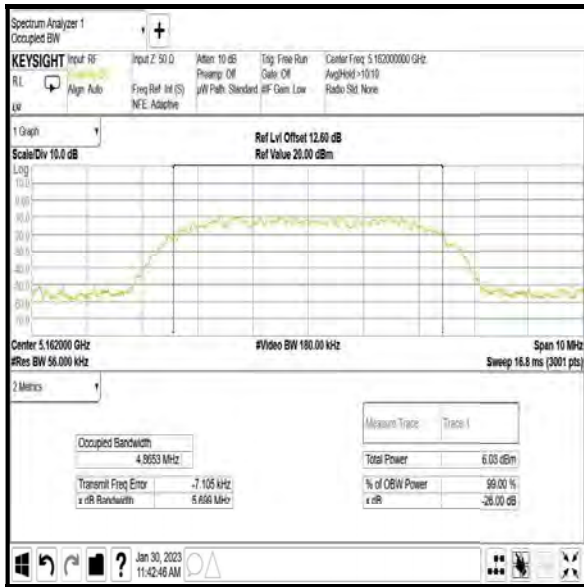

Bottom Channel

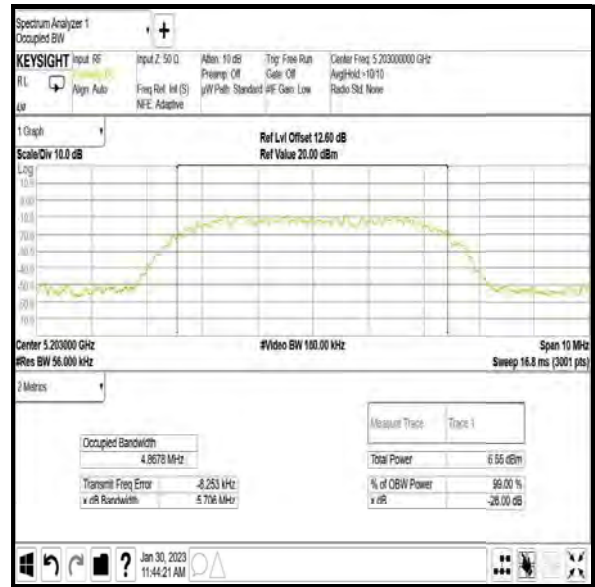

Middle Channel

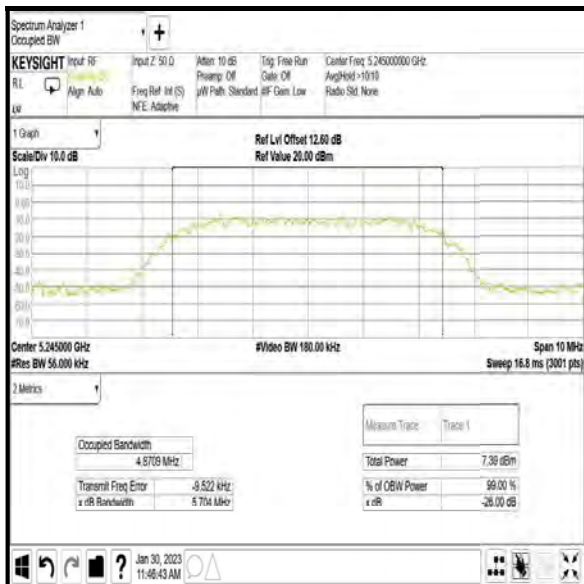

Top Channel

**Transmitter 26 dB Emission Bandwidth (5.15-5.25 GHz band) (continued)**

**Results: 8DH5 / SISO / Core 1 / ePA**

Channel	Frequency (MHz)	26 dB Emission Bandwidth (MHz)
Bottom	5162	5.676
Middle	5203	5.654
Top	5245	5.655

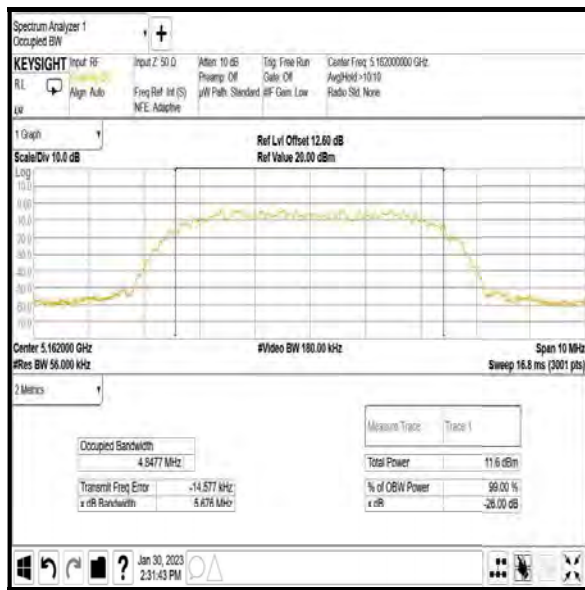

Bottom Channel

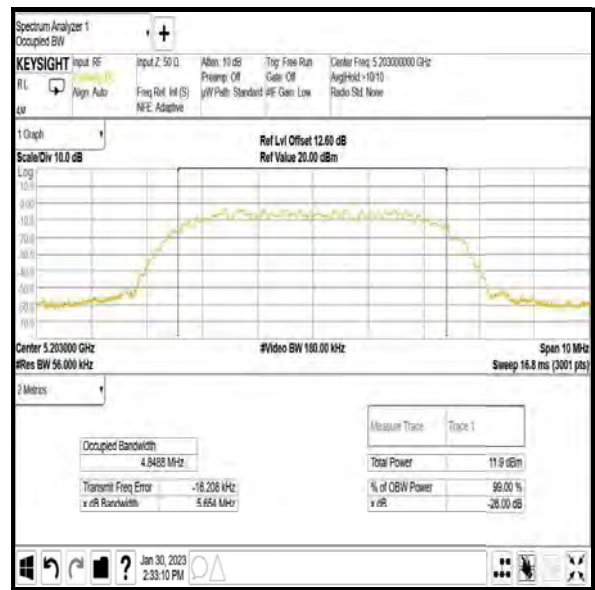

Middle Channel

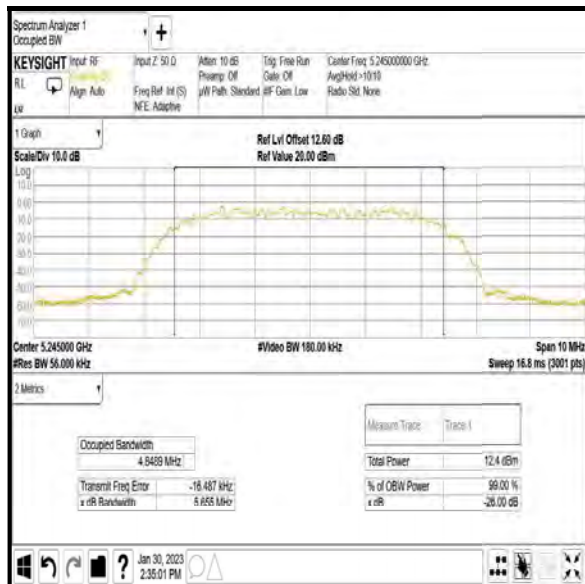

Top Channel



**Transmitter 26 dB Emission Bandwidth (5.15-5.25 GHz band) (continued)**

**Results: DH5 / Beamforming / Core 0 + Core 1 / IPA**

Channel	Frequency (MHz)	26 dB Emission Bandwidth (MHz)	
		Core 0	Core 1
Bottom	5162	1.248	1.249
Middle	5203	1.250	1.251
Top	5245	1.249	1.249

**Results: Core 0**

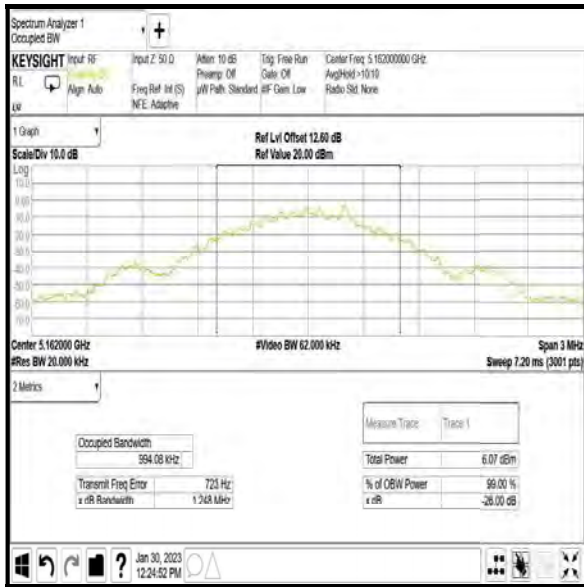

Bottom Channel

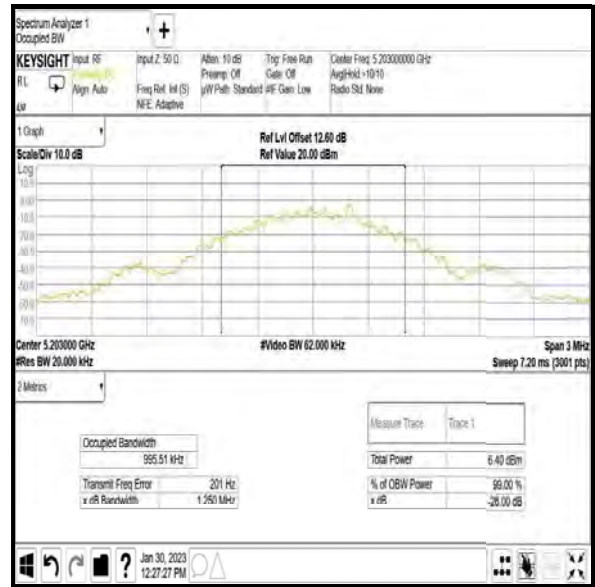

Middle Channel

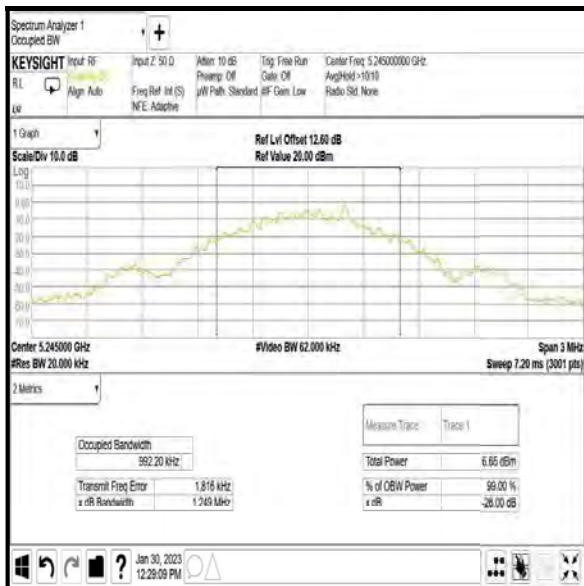

Top Channel

**Transmitter 26 dB Emission Bandwidth (5.15-5.25 GHz band) (continued)**

**Results: Core 1**

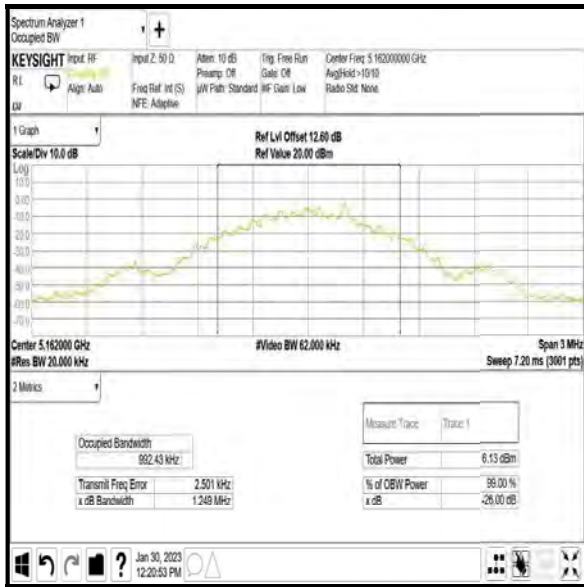

Bottom Channel

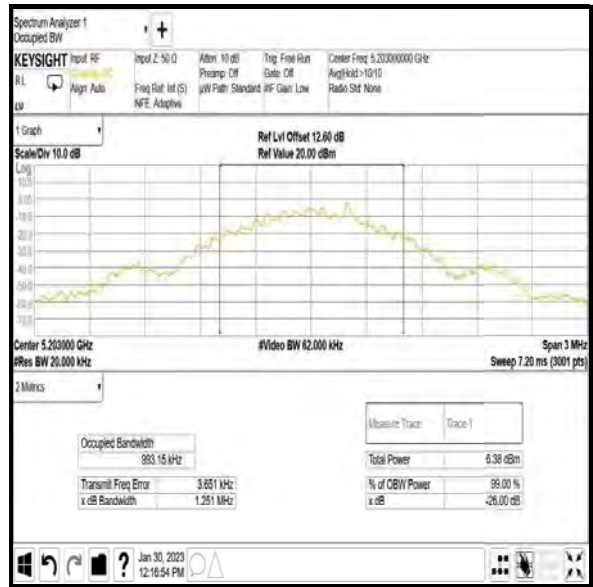

Middle Channel

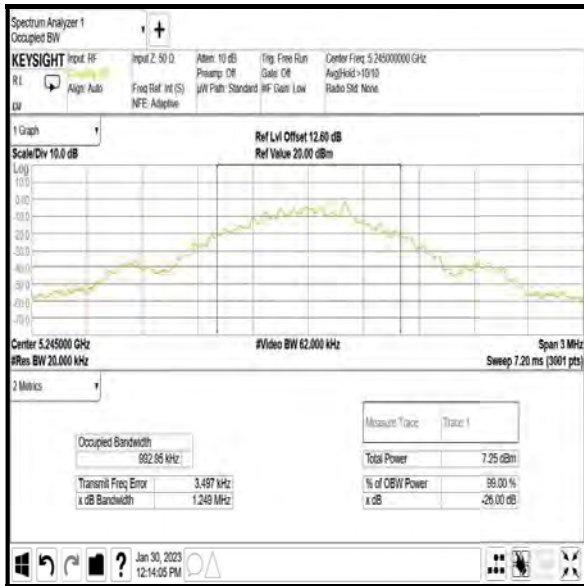

Top Channel

**Transmitter 26 dB Emission Bandwidth (5.15-5.25 GHz band) (continued)**

**Results: 4DH5 / Beamforming / Core 0 + Core 1 / iPA**

Channel	Frequency (MHz)	26 dB Emission Bandwidth (MHz)	
		Core 0	Core 1
Bottom	5162	2.782	2.785
Middle	5203	2.781	2.778
Top	5245	2.784	2.778

**Results: Core 0**

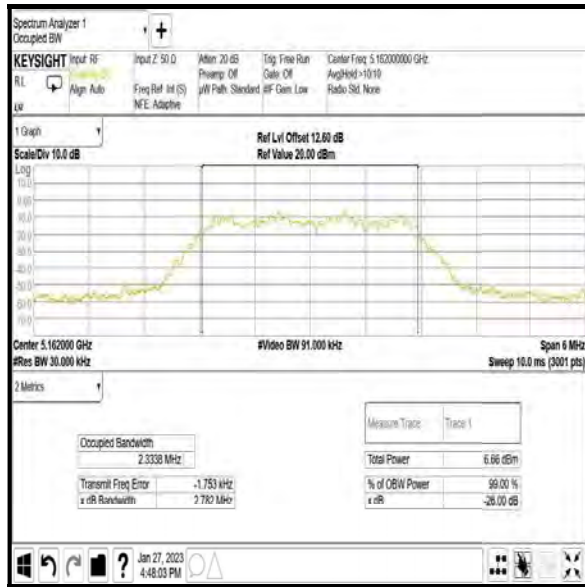

Bottom Channel

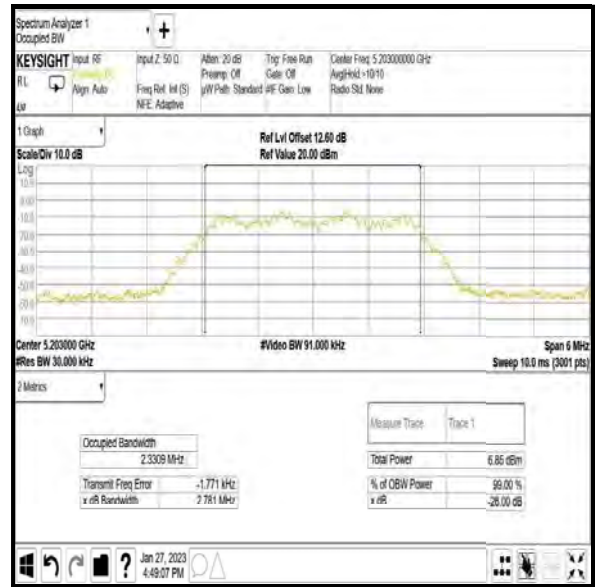

Middle Channel

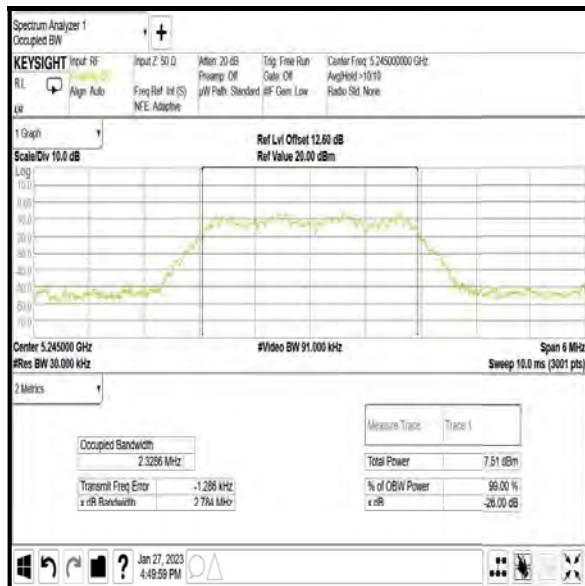

Top Channel

### Transmitter 26 dB Emission Bandwidth (5.15-5.25 GHz band) (continued)

#### Results: Core 1

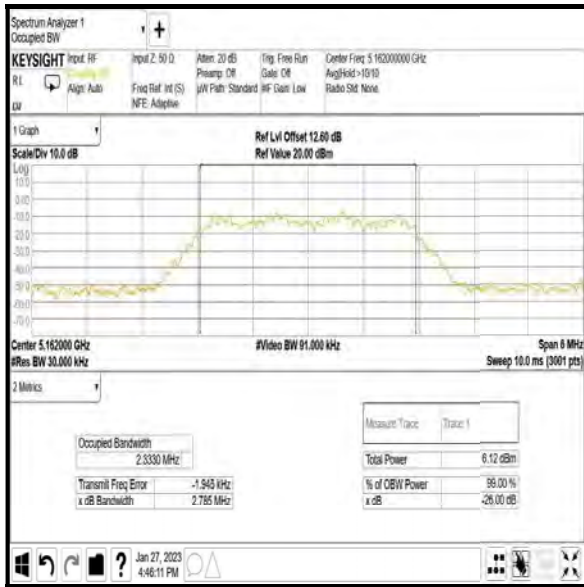

Bottom Channel

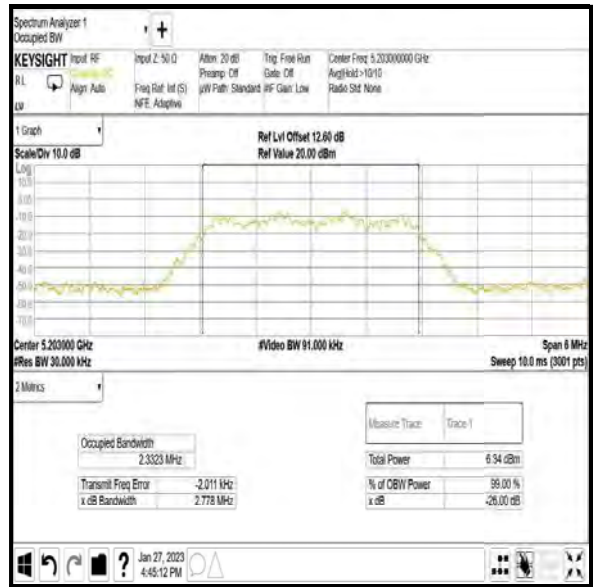

Middle Channel

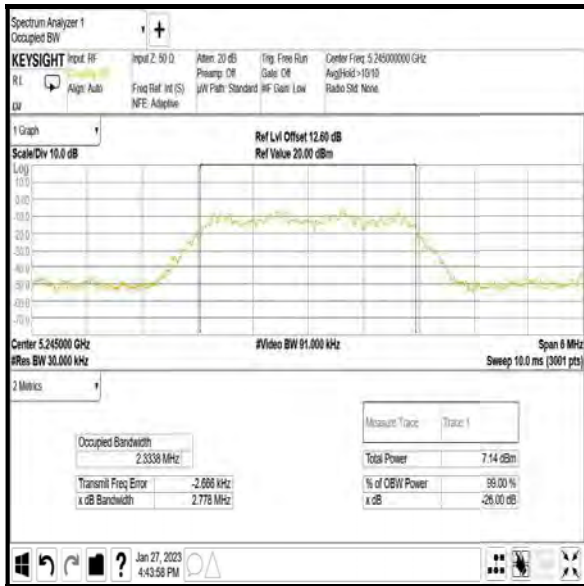

Top Channel

**Transmitter 26 dB Emission Bandwidth (5.15-5.25 GHz band) (continued)**

**Results: 4DH5 / Beamforming / Core 0 + Core 1 / ePA**

Channel	Frequency (MHz)	26 dB Emission Bandwidth (MHz)	
		Core 0	Core 1
Bottom	5162	2.781	2.778
Middle	5203	2.780	2.779
Top	5245	2.779	2.779

**Results: Core 0**

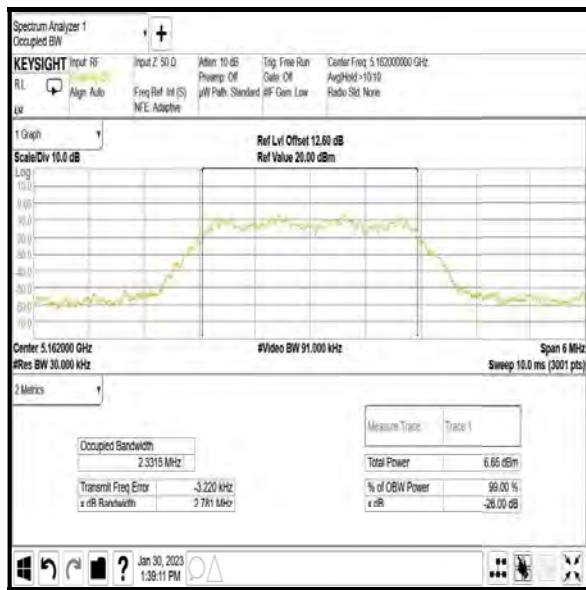

Bottom Channel



Middle Channel

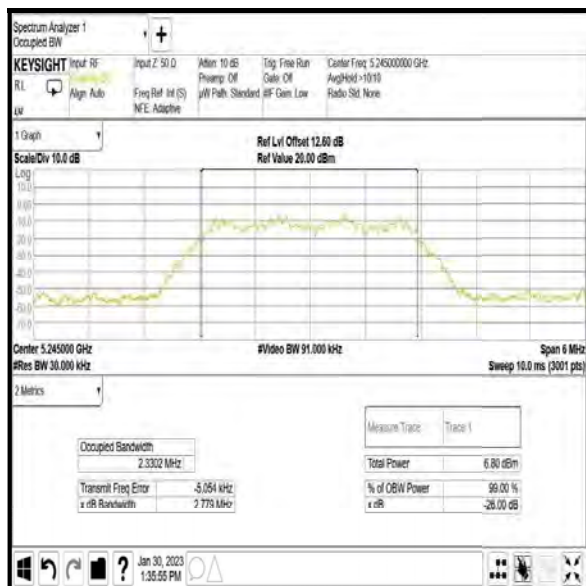

Top Channel

**Transmitter 26 dB Emission Bandwidth (5.15-5.25 GHz band) (continued)**

**Results: Core 1**

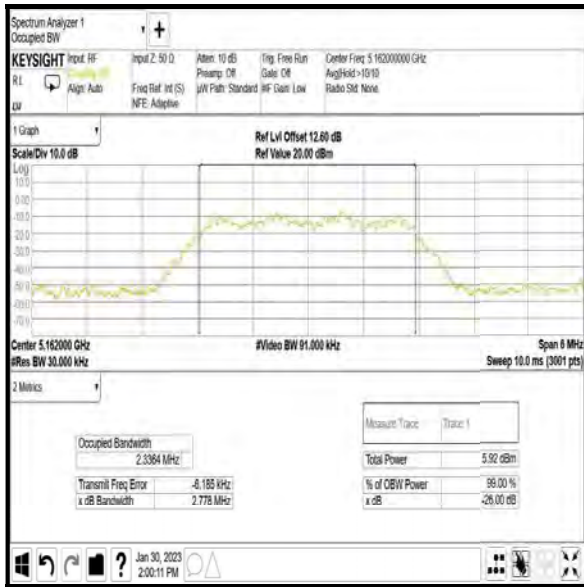

Bottom Channel

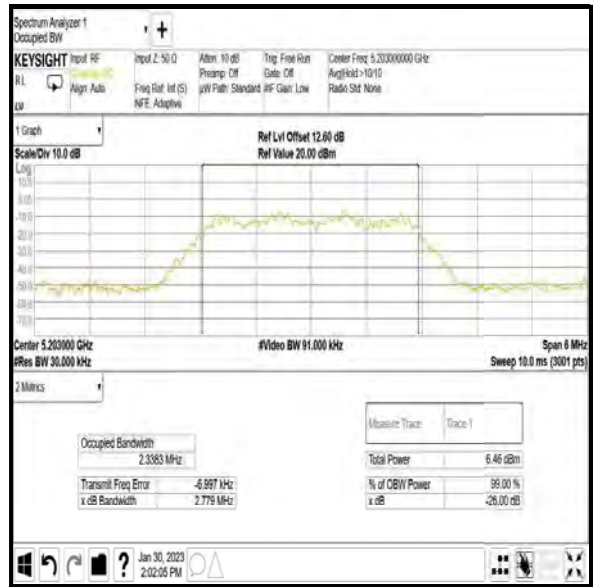

Middle Channel

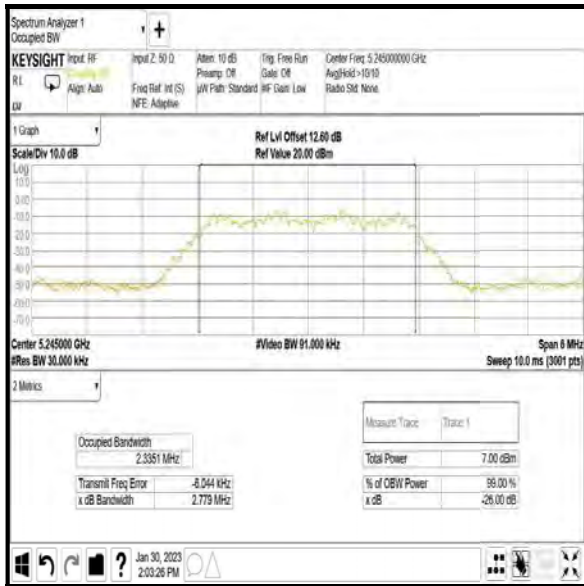

Top Channel

**Transmitter 26 dB Emission Bandwidth (5.15-5.25 GHz band) (continued)**

**Results: 8DH5 / Beamforming / Core 0 + Core 1 / iPA**

Channel	Frequency (MHz)	26 dB Emission Bandwidth (MHz)	
		Core 0	Core 1
Bottom	5162	5.695	5.699
Middle	5203	5.693	5.704
Top	5245	5.691	5.710

**Results: Core 0**

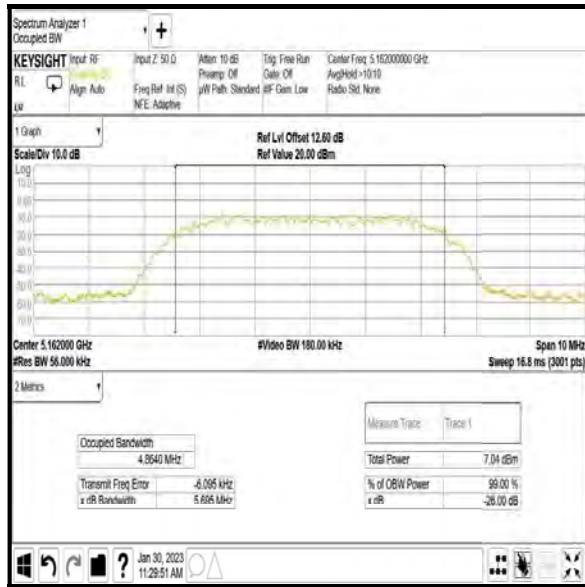

Bottom Channel

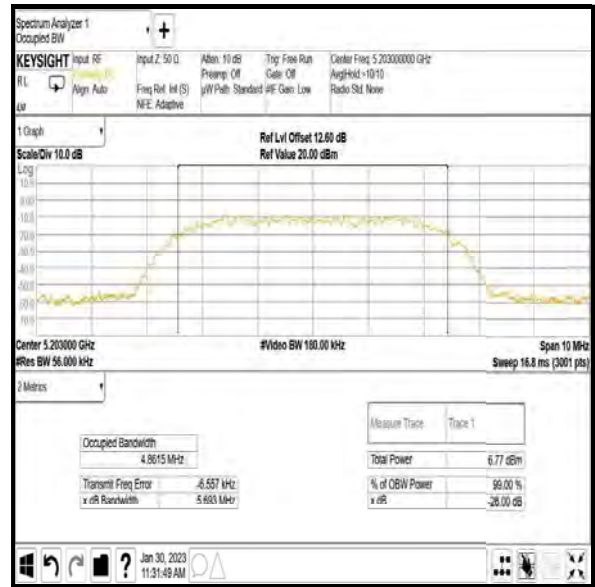

Middle Channel

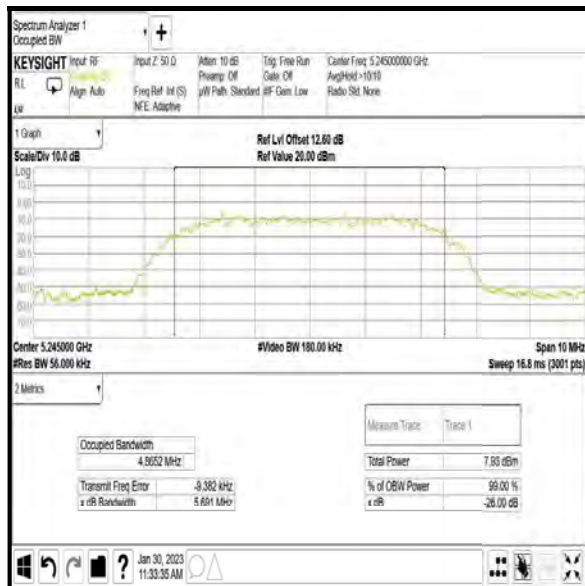

Top Channel

**Transmitter 26 dB Emission Bandwidth (5.15-5.25 GHz band) (continued)**

**Results: Core 1**

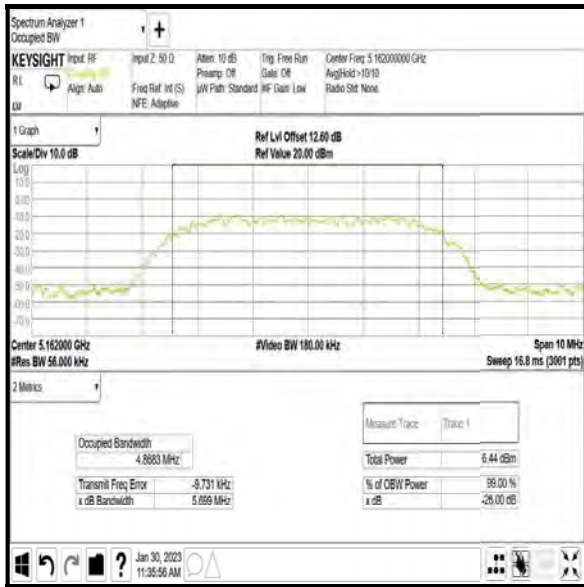

Bottom Channel

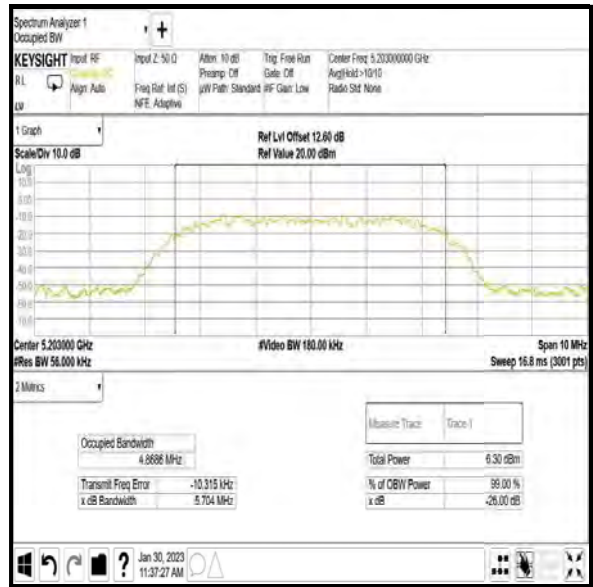

Middle Channel

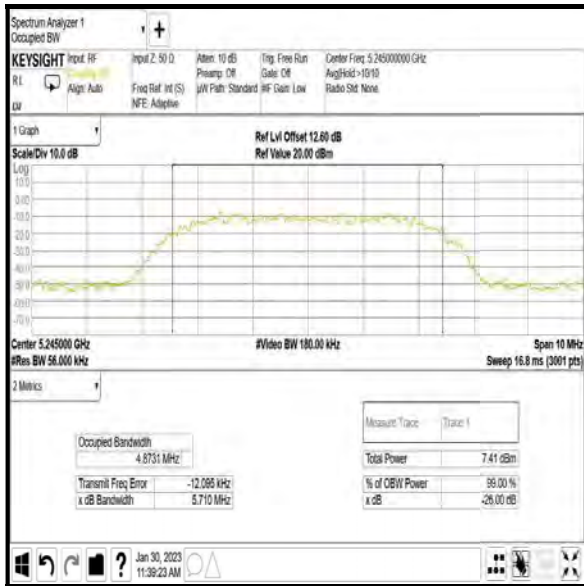

Top Channel



**Transmitter 26 dB Emission Bandwidth (5.15-5.25 GHz band) (continued)**

**Results: 8DH5 / Beamforming / Core 0 + Core 1 / ePA**

Channel	Frequency (MHz)	26 dB Emission Bandwidth (MHz)	
		Core 0	Core 1
Bottom	5162	5.696	5.701
Middle	5203	5.700	5.703
Top	5245	5.693	5.707

**Results: Core 0**

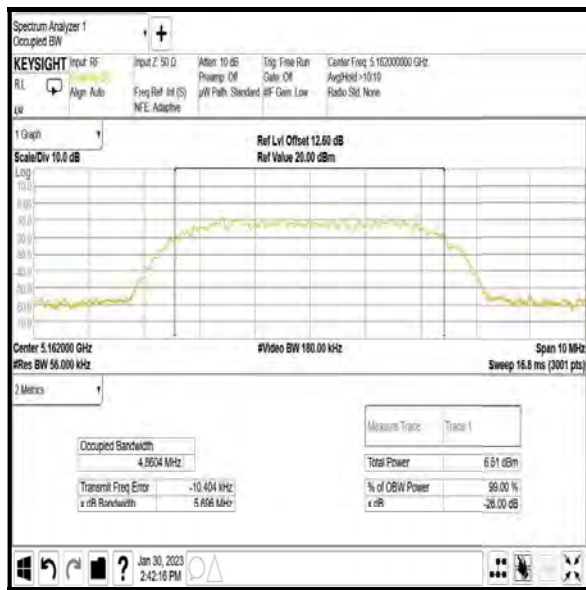

Bottom Channel

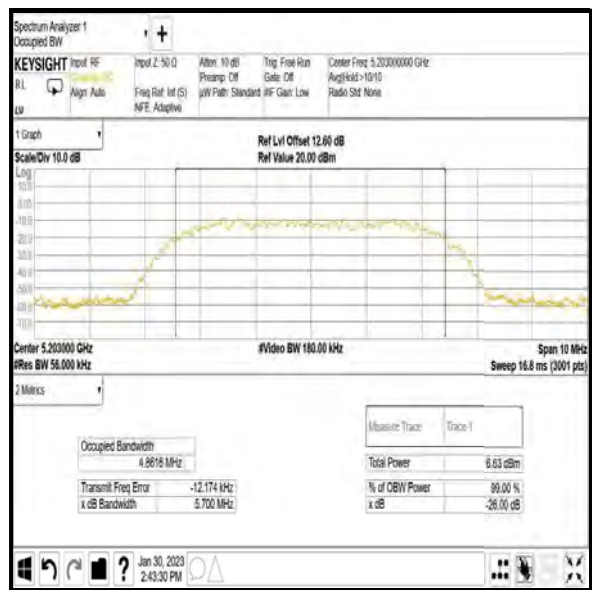

Middle Channel

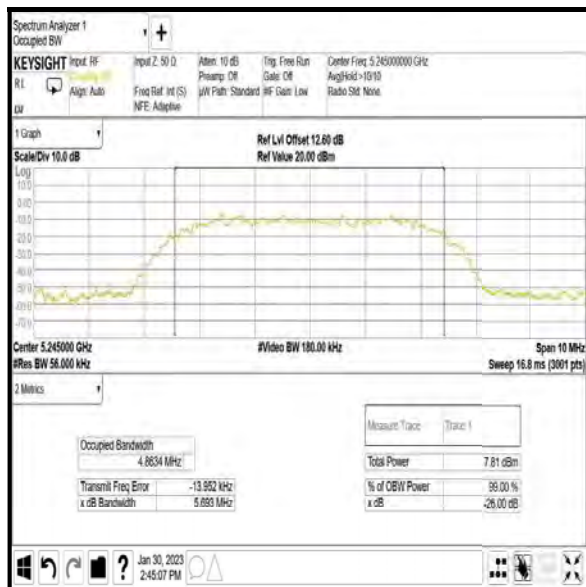

Top Channel

**Transmitter 26 dB Emission Bandwidth (5.15-5.25 GHz band) (continued)**

**Results: Core 1**

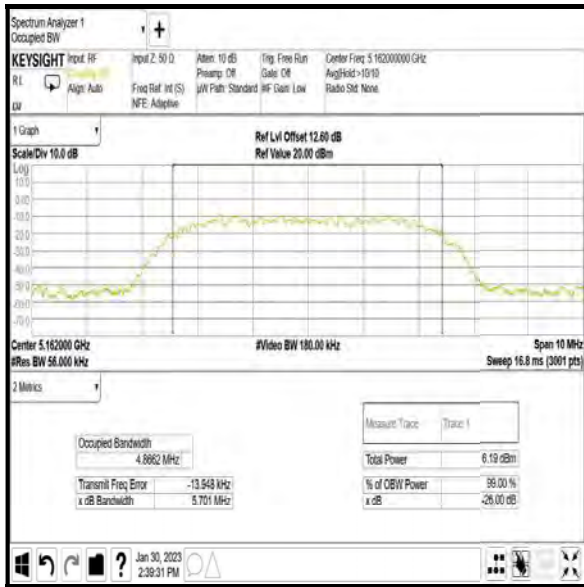

**Bottom Channel**

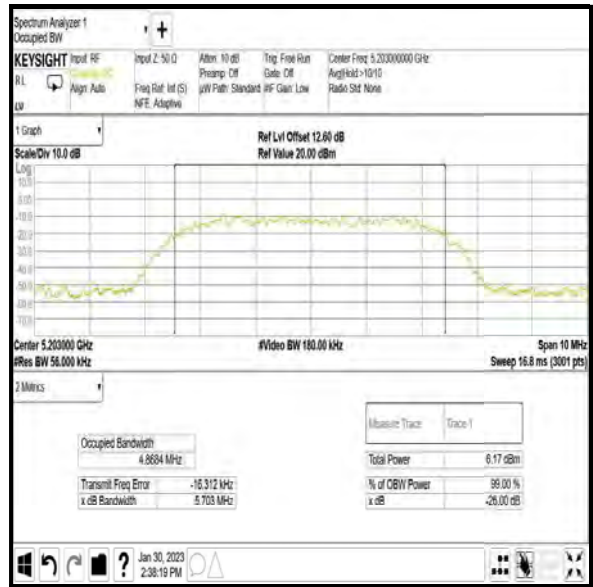

**Middle Channel**

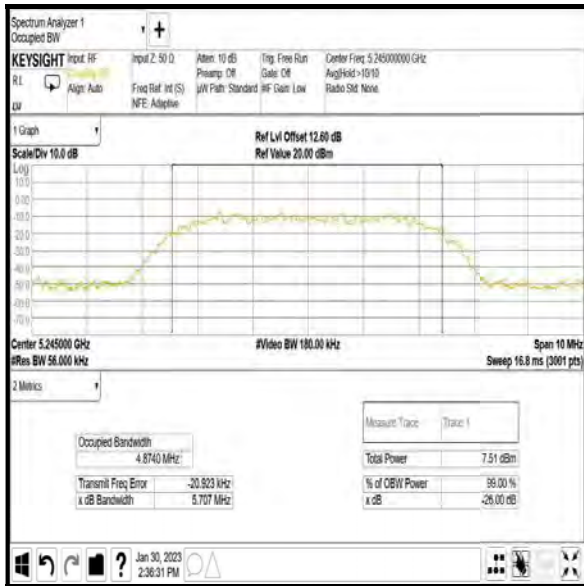

**Top Channel**

**Transmitter 26 dB Emission Bandwidth (5.725-5.85 GHz band) (continued)**

**4.2.2 5.725-5.85 GHz band**

**Results: DH5 / SISO / Core 0 / iPA**

Channel	Frequency (MHz)	26 dB Emission Bandwidth (MHz)
Bottom	5733	1.248
Middle	5788	1.246
Top	5844	1.247

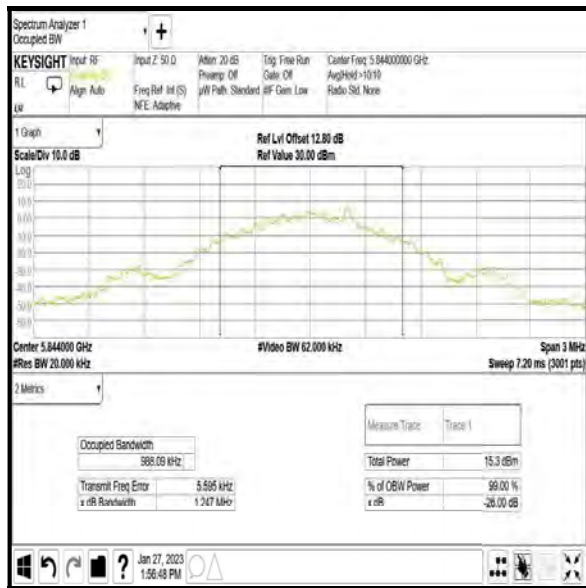
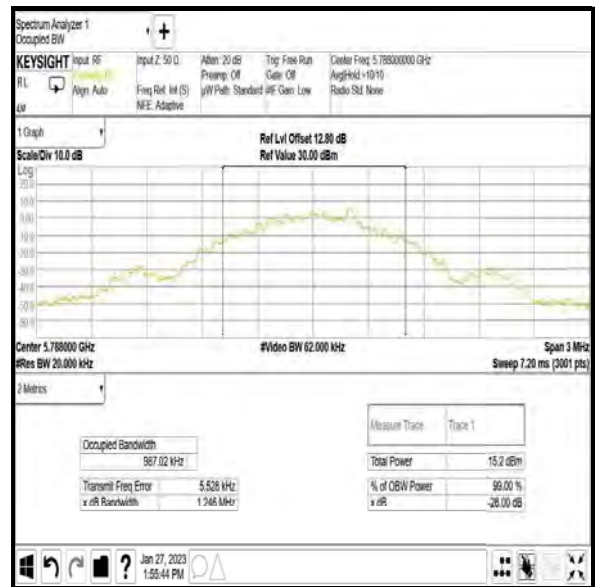
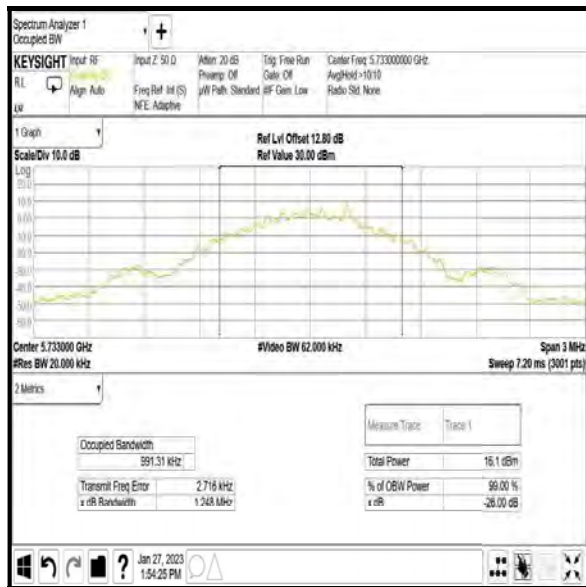

**Transmitter 26 dB Emission Bandwidth (5.725-5.85 GHz band) (continued)**

**Results: 4DH5 / SISO / Core 0 / iPA**

Channel	Frequency (MHz)	26 dB Emission Bandwidth (MHz)
Bottom	5733	2.778
Middle	5788	2.781
Top	5844	2.781

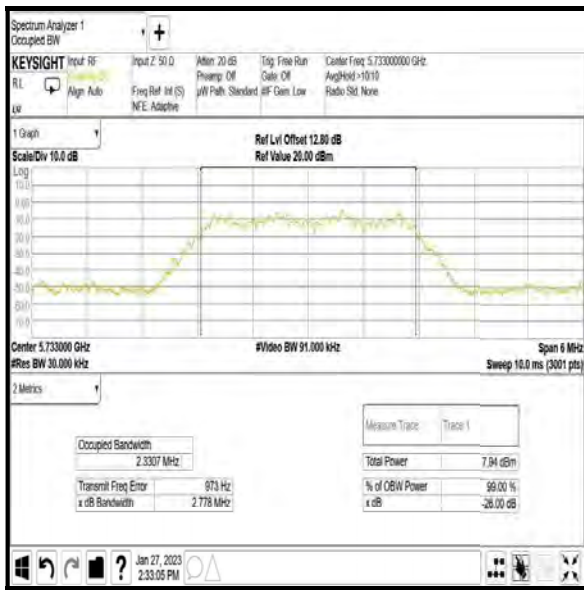

Bottom Channel

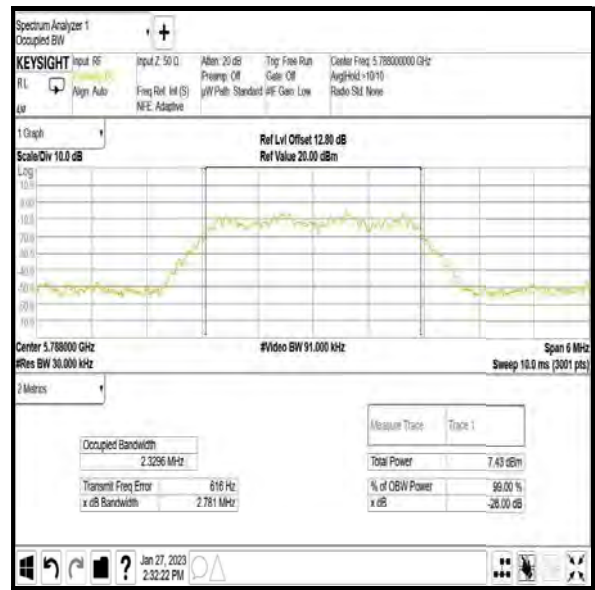

Middle Channel

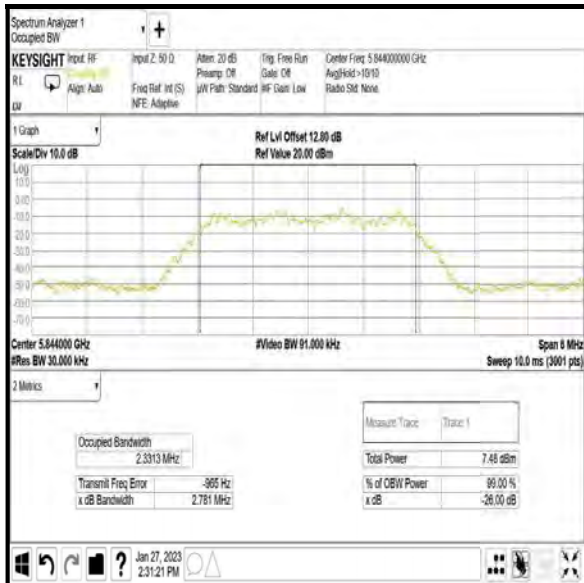

Top Channel

**Transmitter 26 dB Emission Bandwidth (5.725-5.85 GHz band) (continued)**

**Results: 4DH5 / SISO / Core 0 / ePA**

Channel	Frequency (MHz)	26 dB Emission Bandwidth (MHz)
Bottom	5733	2.781
Middle	5788	2.780
Top	5844	2.779

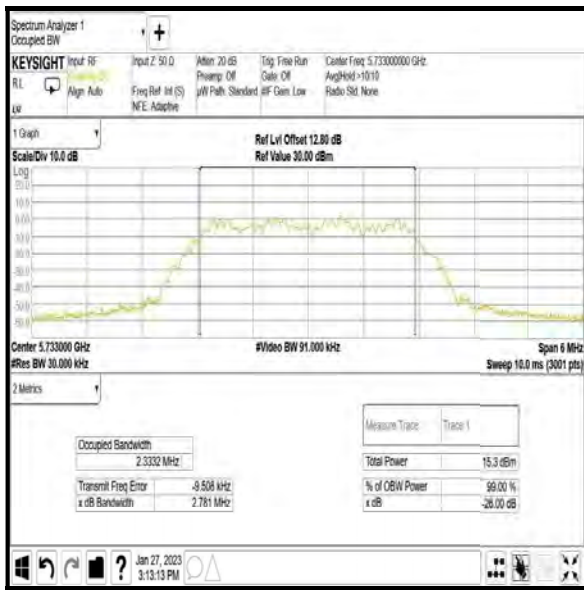

Bottom Channel

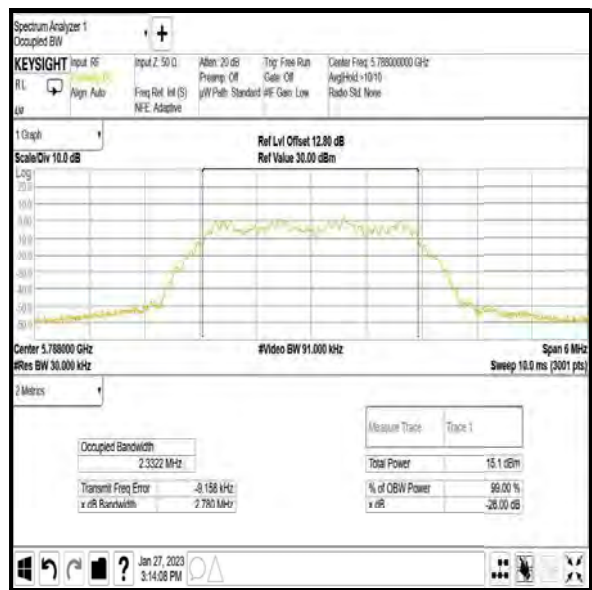

Middle Channel

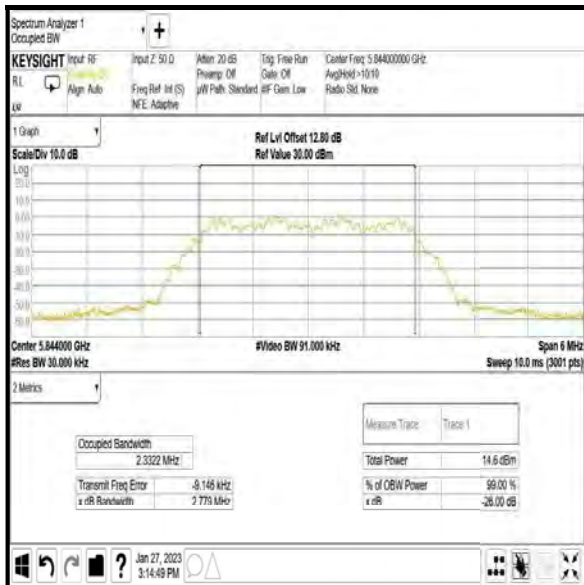

Top Channel

**Transmitter 26 dB Emission Bandwidth (5.725-5.85 GHz band) (continued)**

**Results: 8DH5 / SISO / Core 0 / iPA**

Channel	Frequency (MHz)	26 dB Emission Bandwidth (MHz)
Bottom	5733	5.706
Middle	5788	5.706
Top	5844	5.709

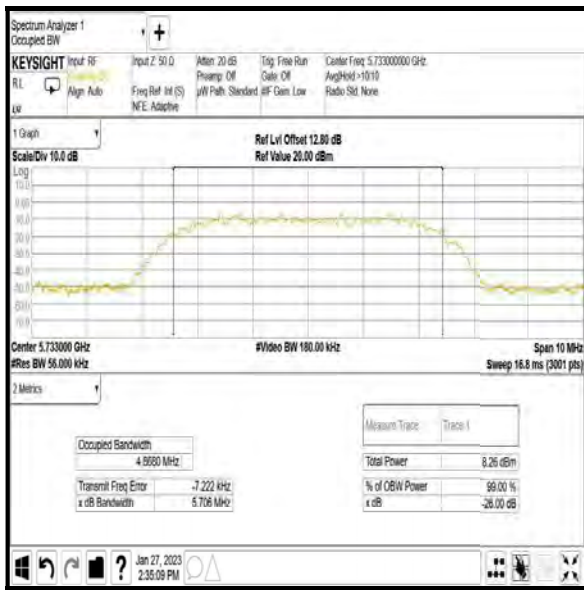

Bottom Channel

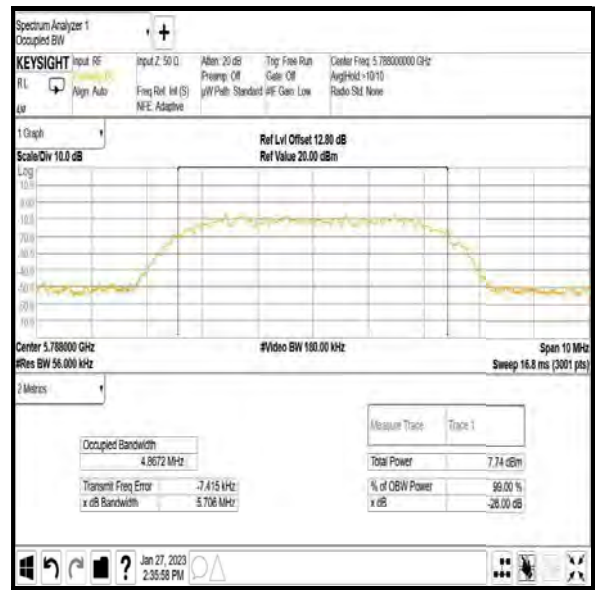

Middle Channel

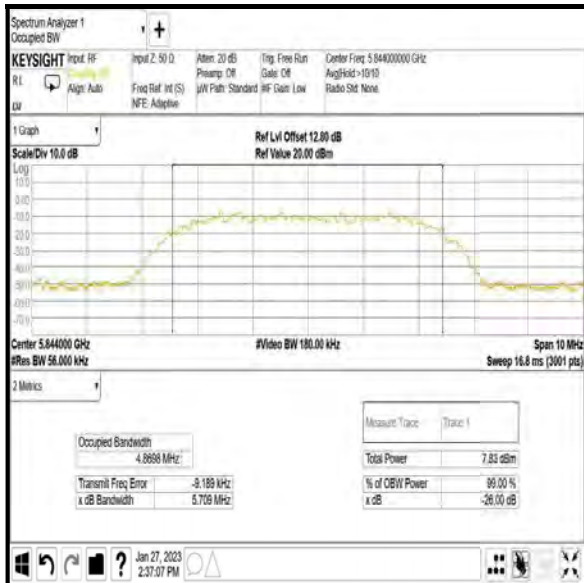

Top Channel

**Transmitter 26 dB Emission Bandwidth (5.725-5.85 GHz band) (continued)**

**Results: 8DH5 / SISO / Core 0 / ePA**

Channel	Frequency (MHz)	26 dB Emission Bandwidth (MHz)
Bottom	5733	5.661
Middle	5788	5.682
Top	5844	5.679

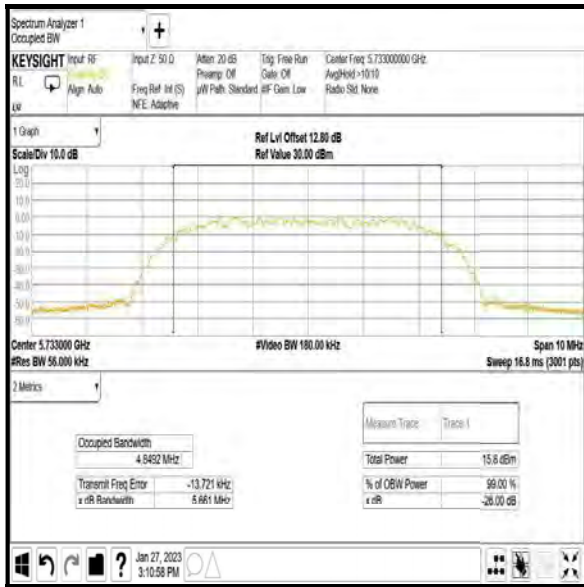

Bottom Channel

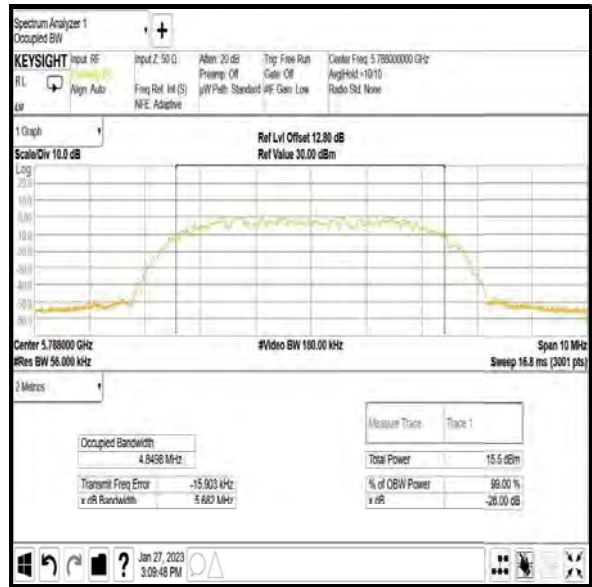

Middle Channel

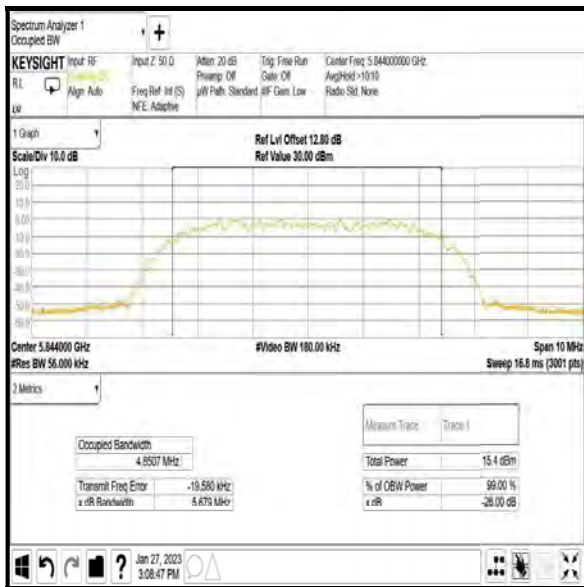

Top Channel

**Transmitter 26 dB Emission Bandwidth (5.725-5.85 GHz band) (continued)**

**Results: DH5 / SISO / Core 1 / iPA**

Channel	Frequency (MHz)	26 dB Emission Bandwidth (MHz)
Bottom	5733	1.247
Middle	5788	1.247
Top	5844	1.247

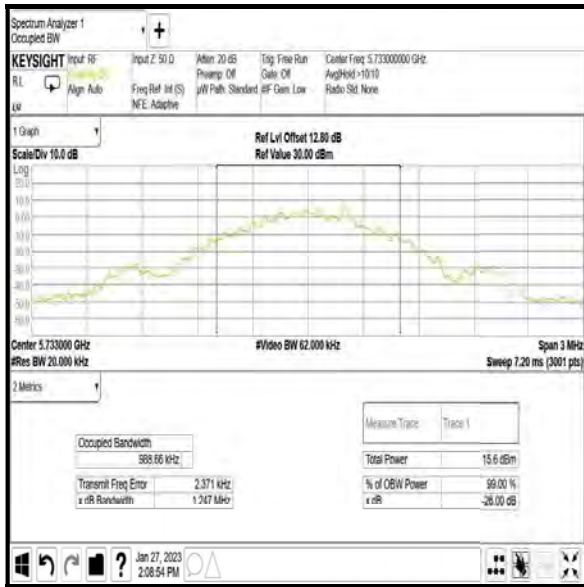

Bottom Channel

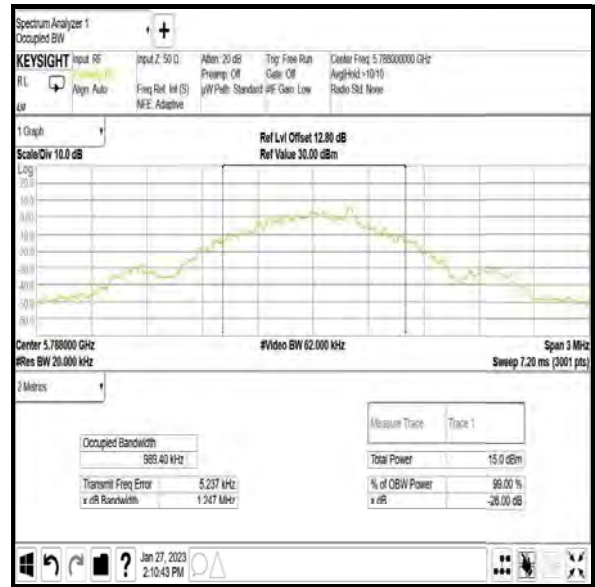

Middle Channel

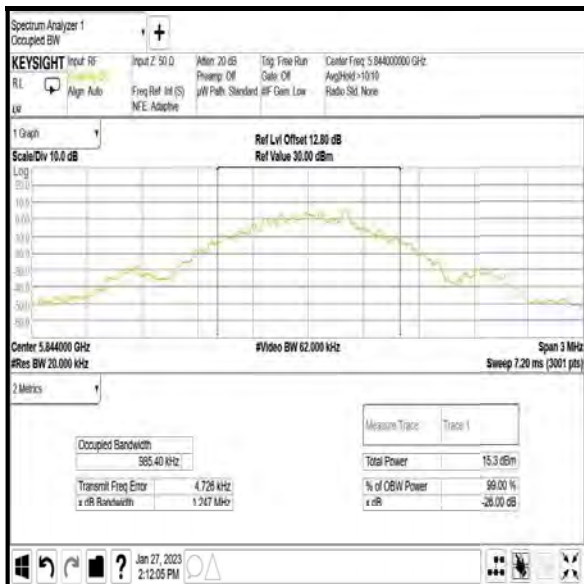

Top Channel



**Transmitter 26 dB Emission Bandwidth (5.725-5.85 GHz band) (continued)**

**Results: 4DH5 / SISO / Core 1 / iPA**

Channel	Frequency (MHz)	26 dB Emission Bandwidth (MHz)
Bottom	5733	2.780
Middle	5788	2.781
Top	5844	2.779

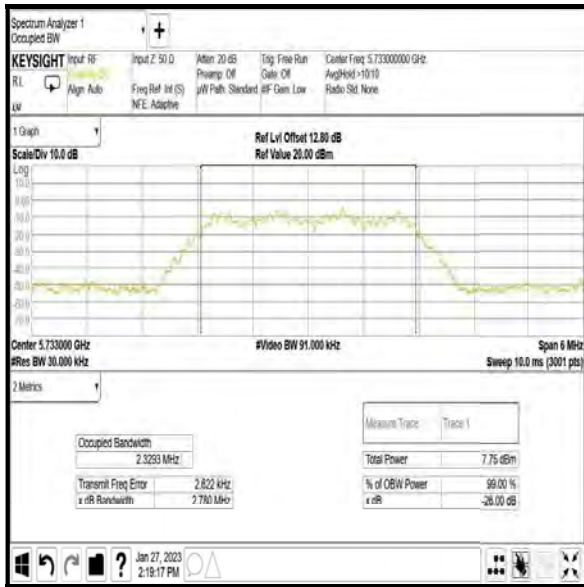

Bottom Channel

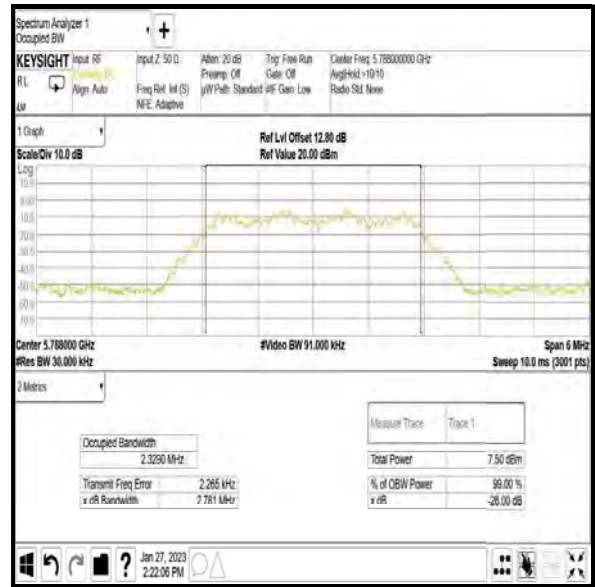

Middle Channel

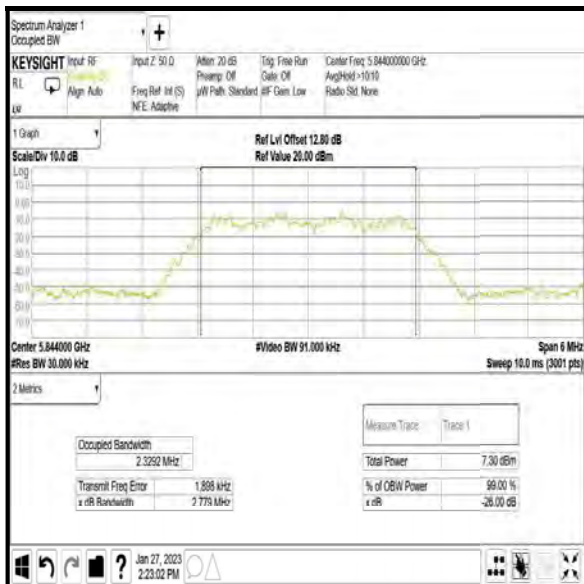

Top Channel

**Transmitter 26 dB Emission Bandwidth (5.725-5.85 GHz band) (continued)**

**Results: 4DH5 / SISO / Core 1 / ePA**

Channel	Frequency (MHz)	26 dB Emission Bandwidth (MHz)
Bottom	5733	2.783
Middle	5788	2.782
Top	5844	2.785

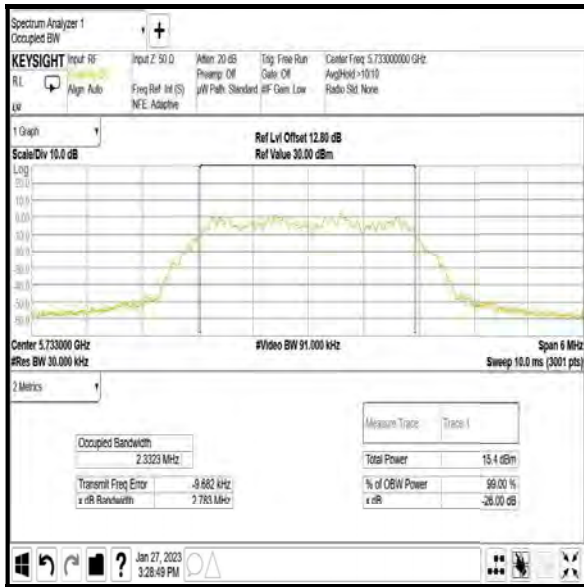

Bottom Channel

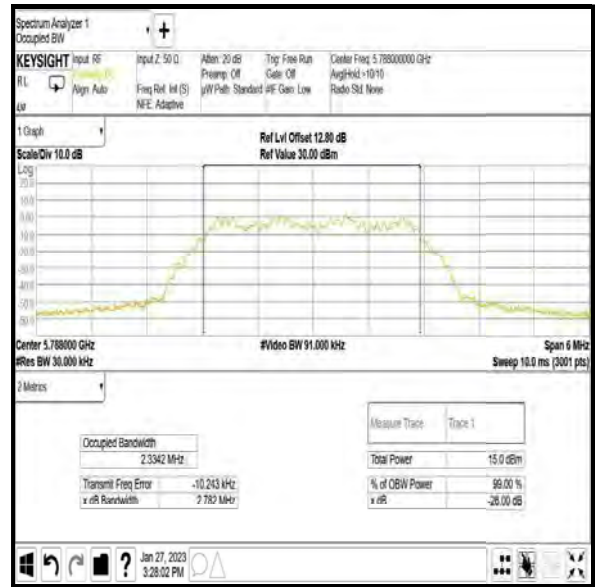

Middle Channel

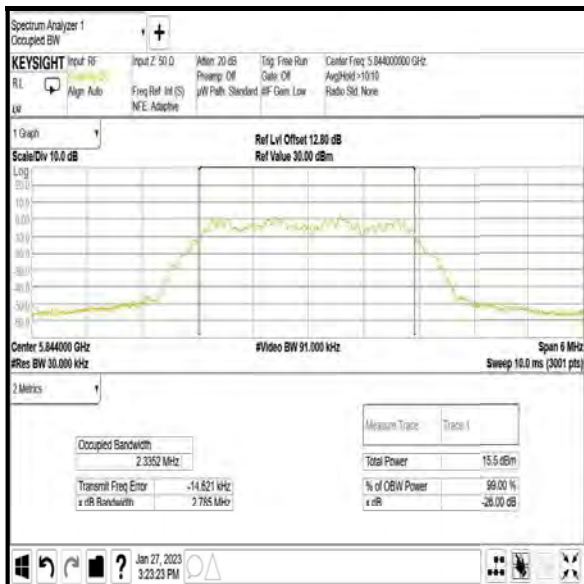

Top Channel

**Transmitter 26 dB Emission Bandwidth (5.725-5.85 GHz band) (continued)**

**Results: 8DH5 / SISO / Core 1 / iPA**

Channel	Frequency (MHz)	26 dB Emission Bandwidth (MHz)
Bottom	5733	5.704
Middle	5788	5.710
Top	5844	5.700

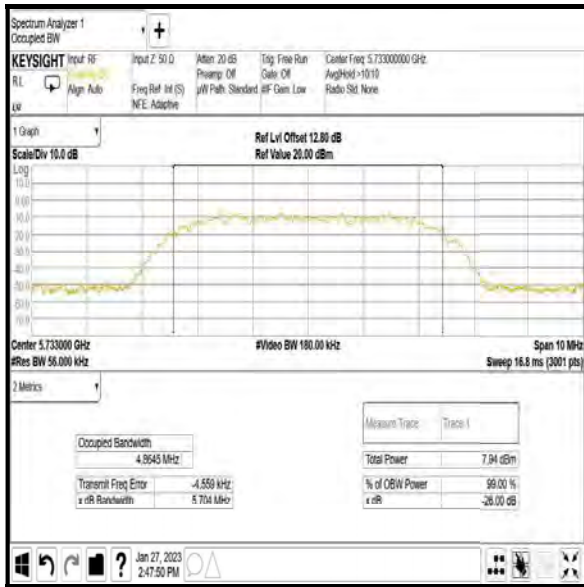

Bottom Channel

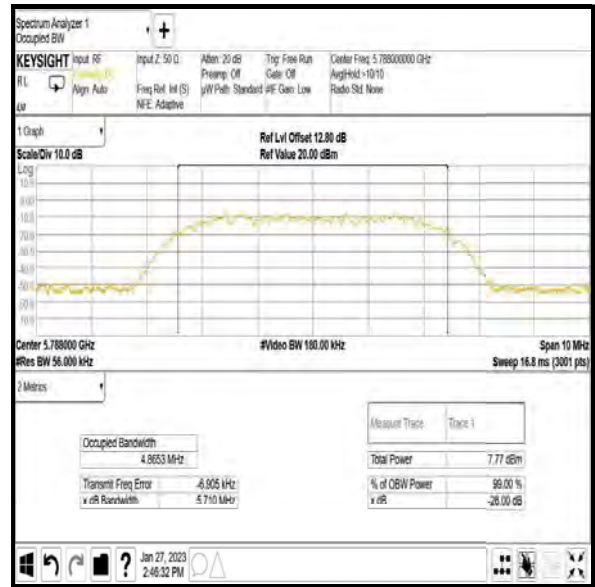

Middle Channel

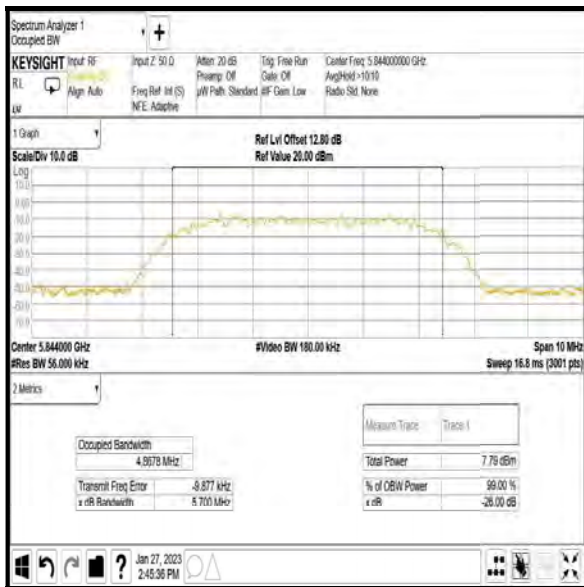

Top Channel

**Transmitter 26 dB Emission Bandwidth (5.725-5.85 GHz band) (continued)**

**Results: 8DH5 / SISO / Core 1 / ePA**

Channel	Frequency (MHz)	26 dB Emission Bandwidth (MHz)
Bottom	5733	5.681
Middle	5788	5.686
Top	5844	5.681

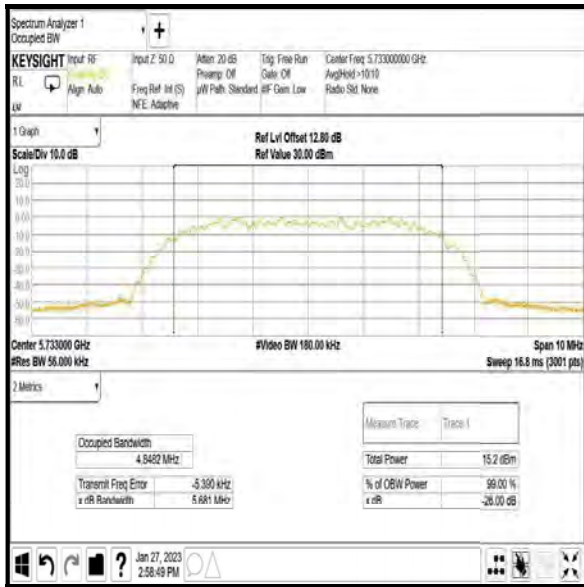

Bottom Channel

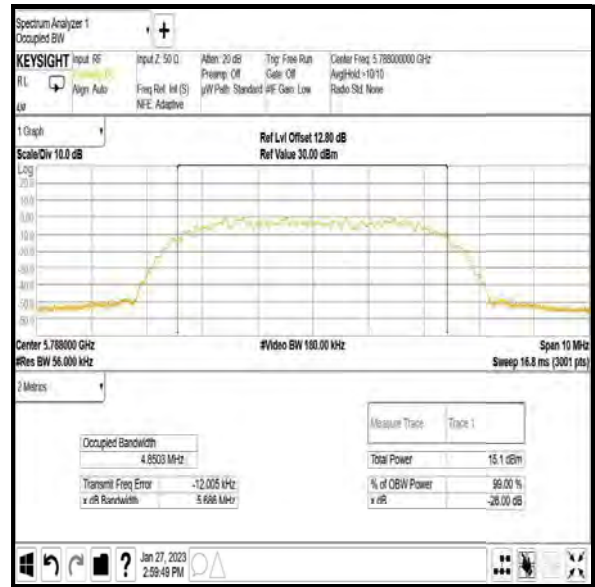

Middle Channel

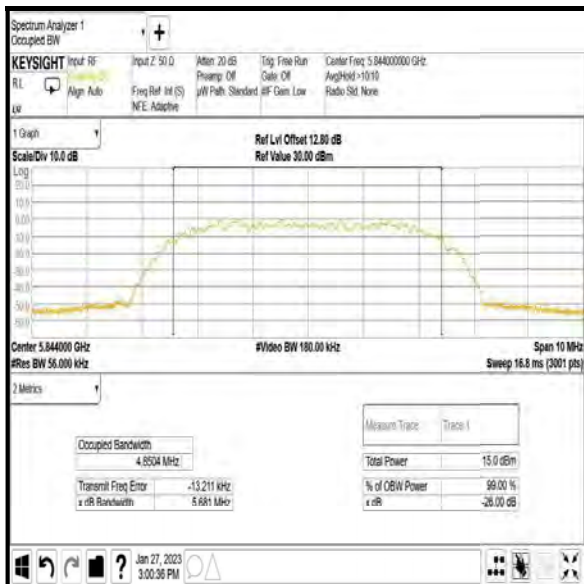

Top Channel

**Transmitter 26 dB Emission Bandwidth (5.725-5.85 GHz band) (continued)**

**Results: DH5 / Beamforming / Core 0 + Core 1 / iPA**

Channel	Frequency (MHz)	26 dB Emission Bandwidth (MHz)	
		Core 0	Core 1
Bottom	5733	1.249	1.248
Middle	5788	1.246	1.248
Top	5844	1.247	1.248

**Results: Core 0**

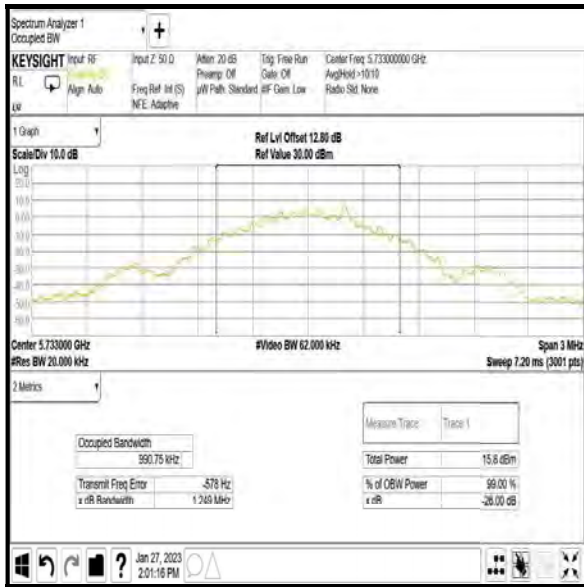

Bottom Channel

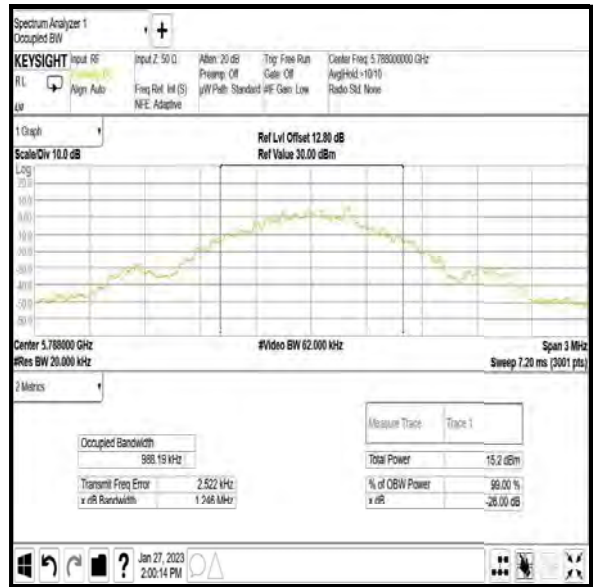

Middle Channel

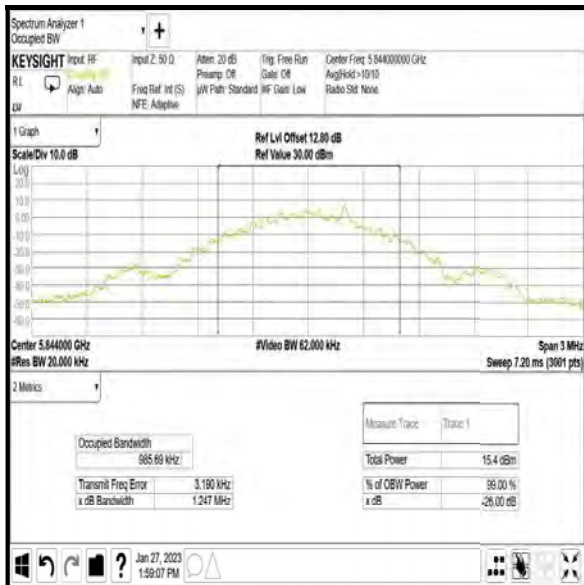

Top Channel

**Transmitter 26 dB Emission Bandwidth (5.725-5.85 GHz band) (continued)**

**Results: Core 1**

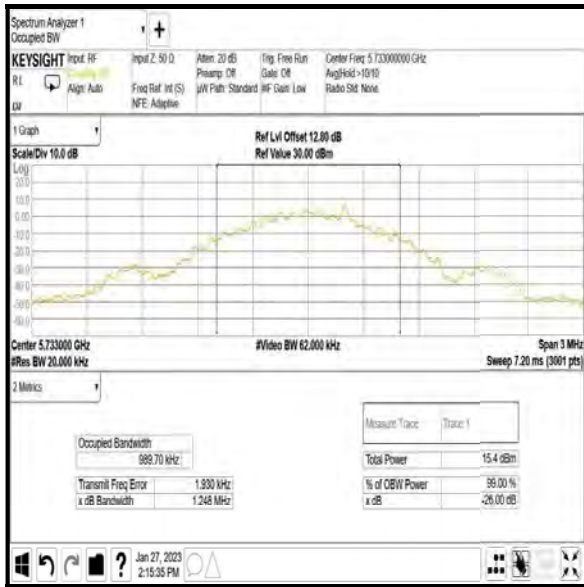

**Bottom Channel**

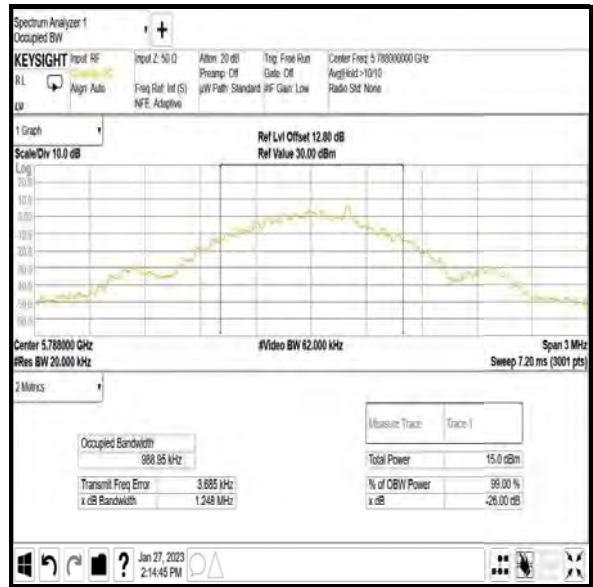

**Middle Channel**

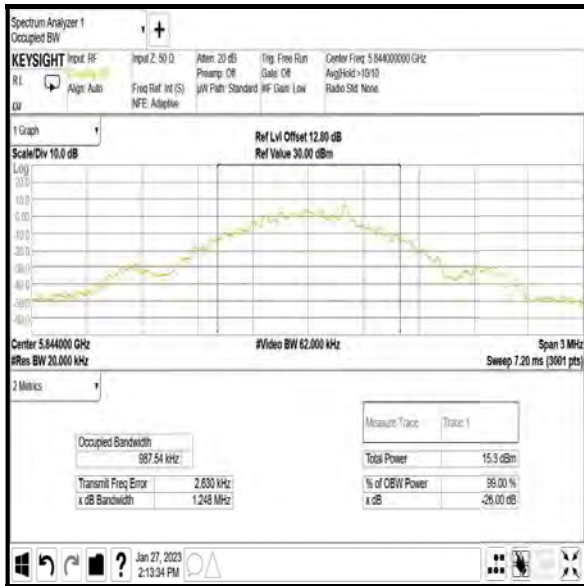

**Top Channel**

**Transmitter 26 dB Emission Bandwidth (5.725-5.85 GHz band) (continued)**

**Results: 4DH5 / Beamforming / Core 0 + Core 1 / iPA**

Channel	Frequency (MHz)	26 dB Emission Bandwidth (MHz)	
		Core 0	Core 1
Bottom	5733	2.779	2.779
Middle	5788	2.779	2.777
Top	5844	2.779	2.781

**Results: Core 0**

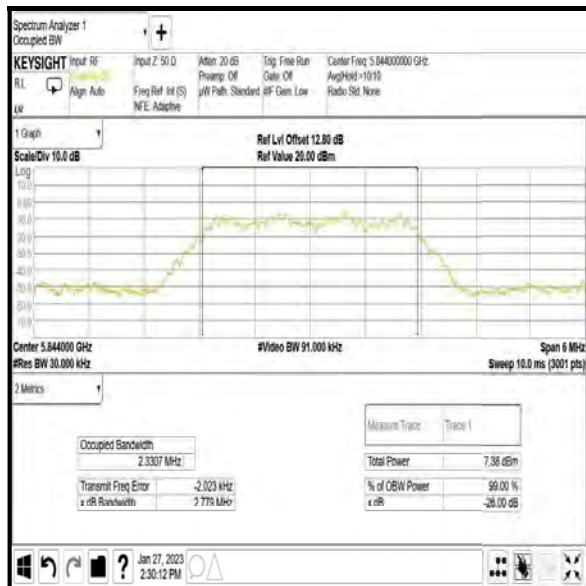
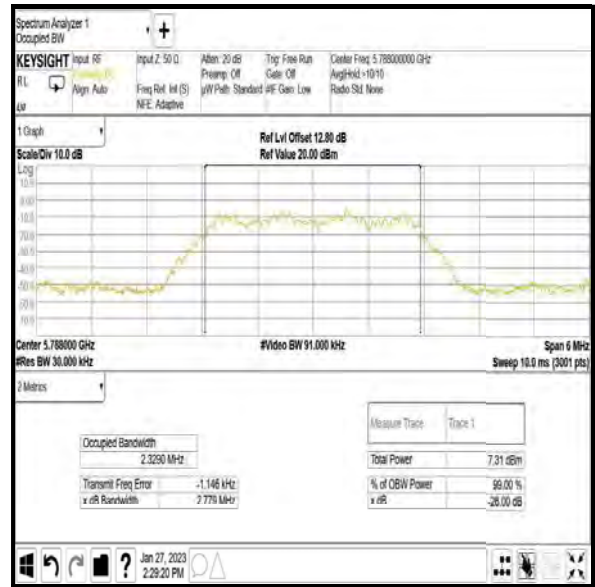
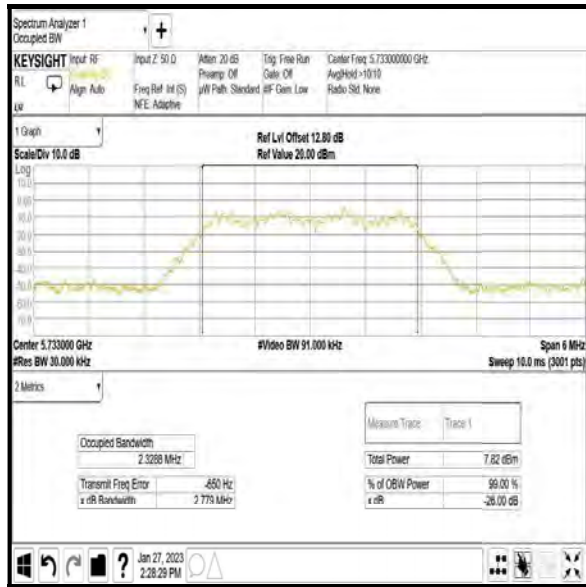

**Transmitter 26 dB Emission Bandwidth (5.725-5.85 GHz band) (continued)**

**Results: Core 1**

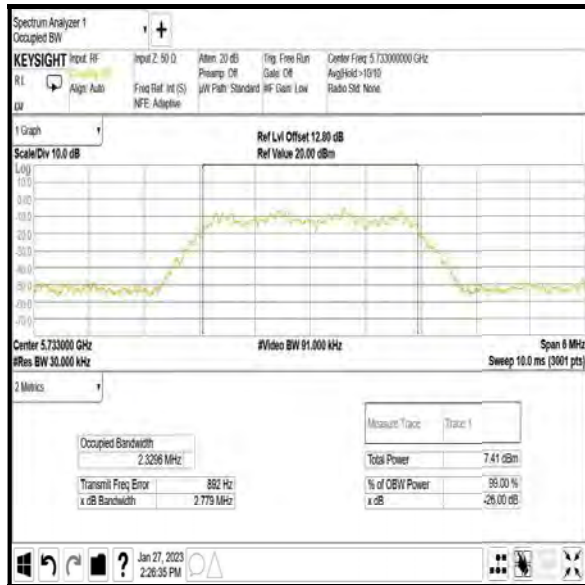

**Bottom Channel**

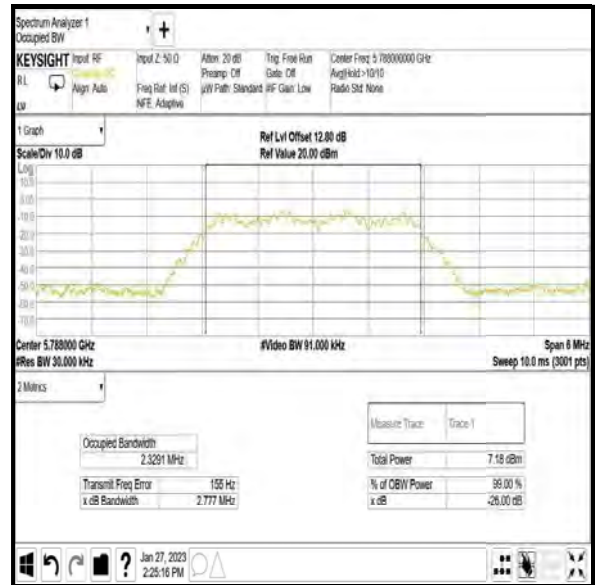

**Middle Channel**

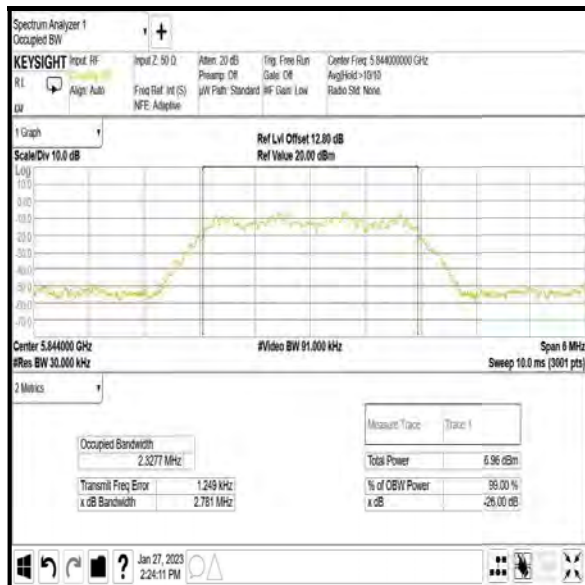

**Top Channel**



**Transmitter 26 dB Emission Bandwidth (5.725-5.85 GHz band) (continued)**

**Results: 4DH5 / Beamforming / Core 0 + Core 1 / ePA**

Channel	Frequency (MHz)	26 dB Emission Bandwidth (MHz)	
		Core 0	Core 1
Bottom	5733	2.783	2.780
Middle	5788	2.784	2.784
Top	5844	2.780	2.784

**Results: Core 0**

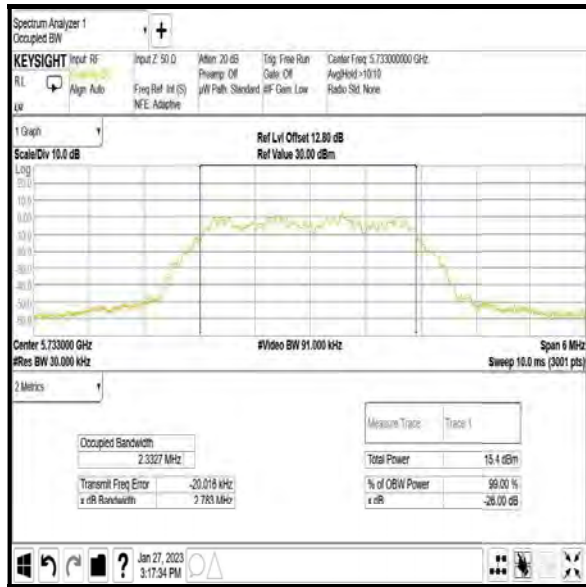

Bottom Channel

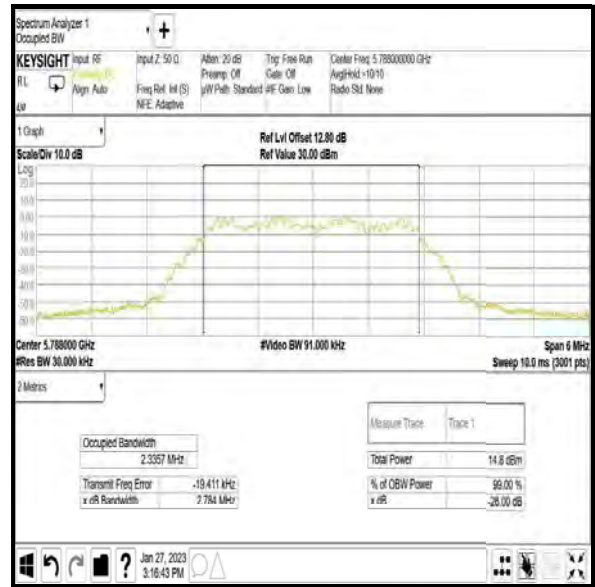

Middle Channel

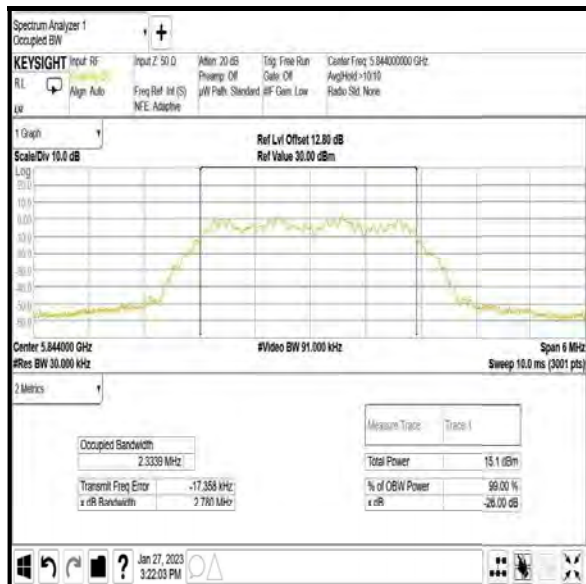

Top Channel

**Transmitter 26 dB Emission Bandwidth (5.725-5.85 GHz band) (continued)**

**Results: Core 1**

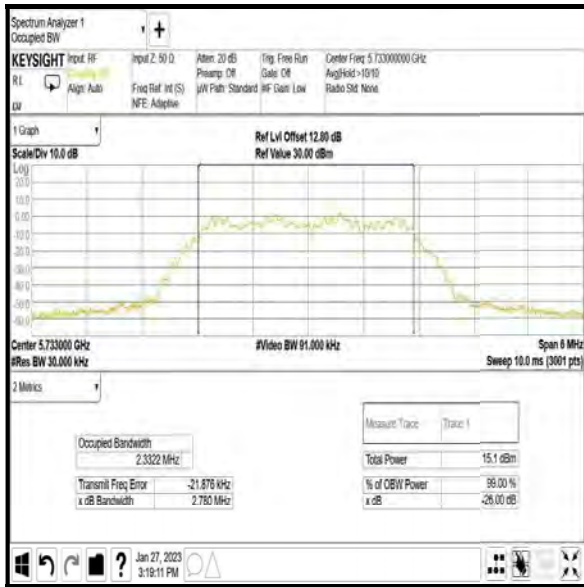

**Bottom Channel**

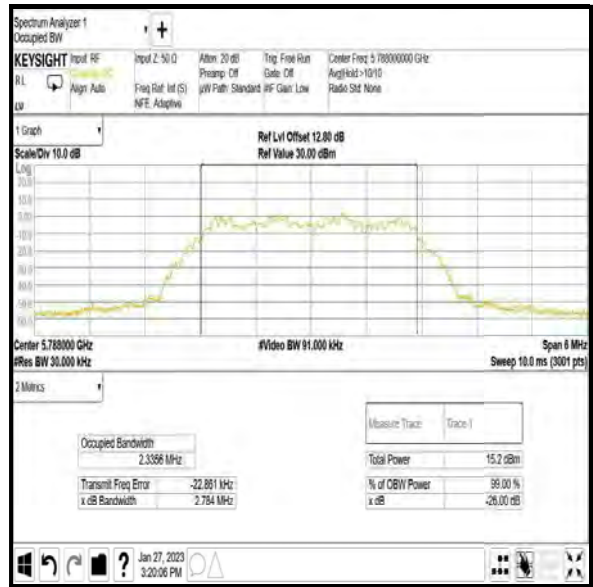

**Middle Channel**

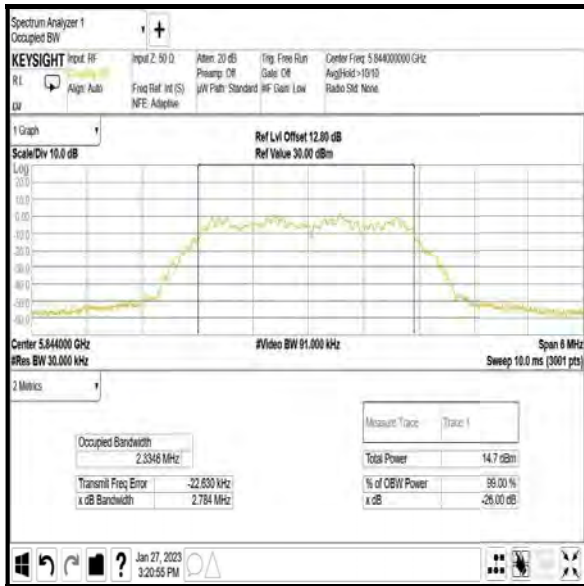

**Top Channel**

**Transmitter 26 dB Emission Bandwidth (5.725-5.85 GHz band) (continued)**

**Results: 8DH5 / Beamforming / Core 0 + Core 1 / iPA**

Channel	Frequency (MHz)	26 dB Emission Bandwidth (MHz)	
		Core 0	Core 1
Bottom	5733	5.715	5.708
Middle	5788	5.711	5.699
Top	5844	5.706	5.697

**Results: Core 0**

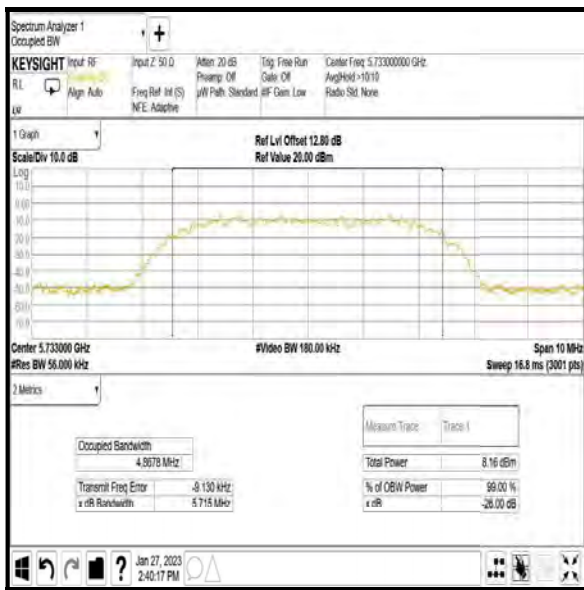

Bottom Channel

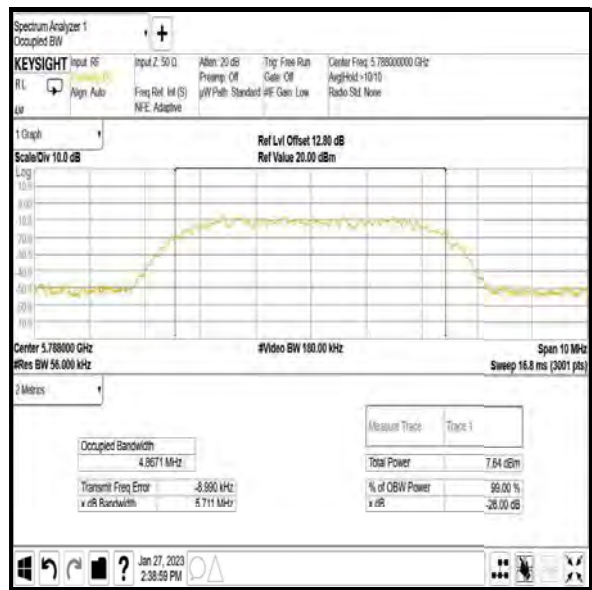

Middle Channel

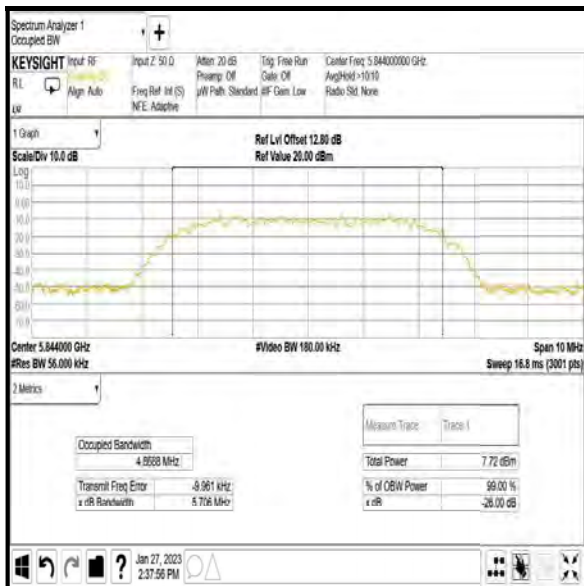

Top Channel

**Transmitter 26 dB Emission Bandwidth (5.725-5.85 GHz band) (continued)**

**Results: Core 1**

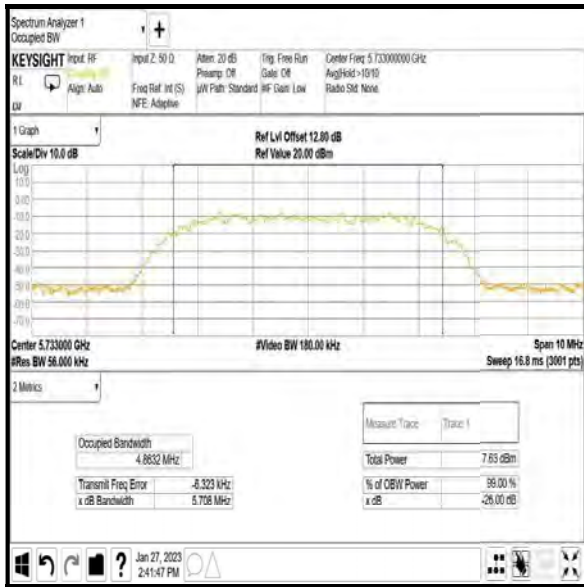

Bottom Channel

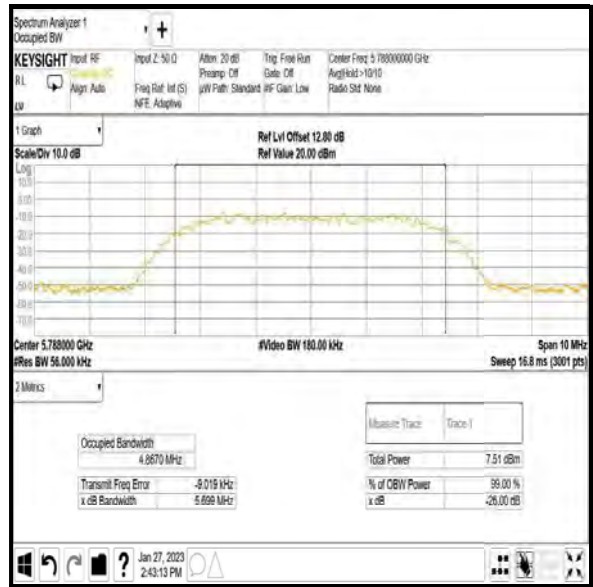

Middle Channel

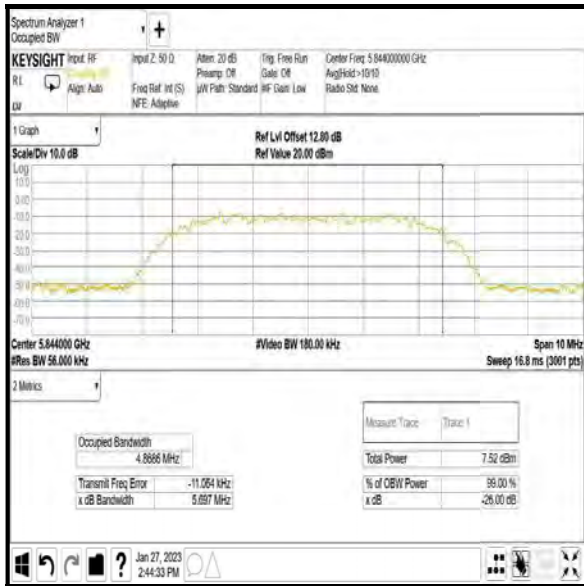

Top Channel

**Transmitter 26 dB Emission Bandwidth (5.725-5.85 GHz band) (continued)**

**Results: 8DH5 / Beamforming / Core 0 + Core 1 / ePA**

Channel	Frequency (MHz)	26 dB Emission Bandwidth (MHz)	
		Core 0	Core 1
Bottom	5733	5.689	5.681
Middle	5788	5.677	5.681
Top	5844	5.673	5.682

**Results: Core 0**

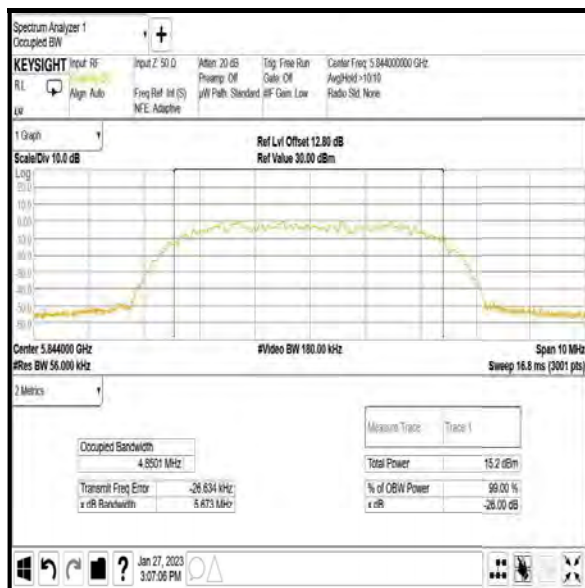
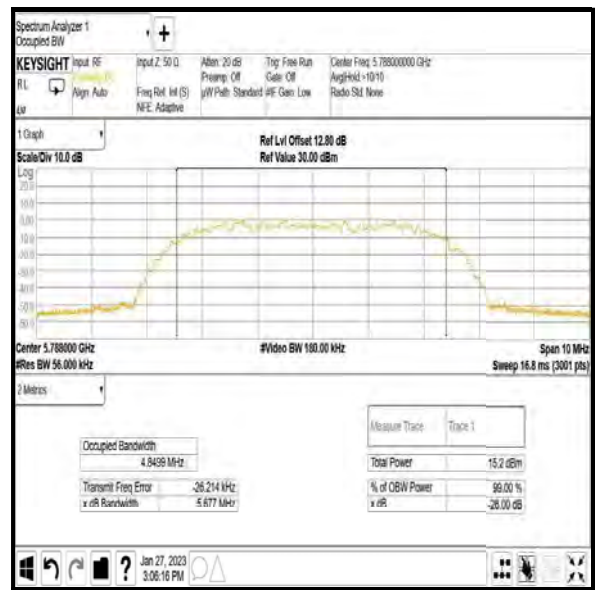
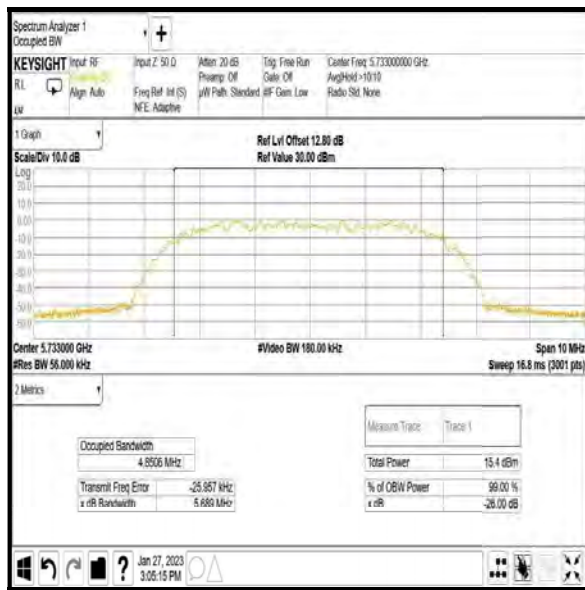

**Transmitter 26 dB Emission Bandwidth (5.725-5.85 GHz band) (continued)**

**Results: Core 1**

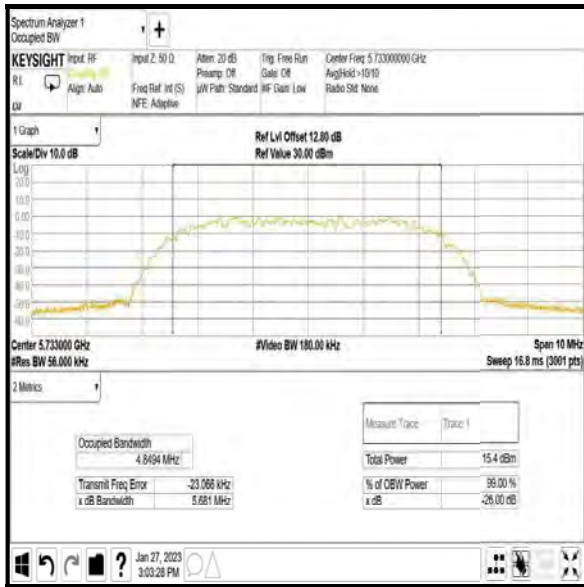

Bottom Channel

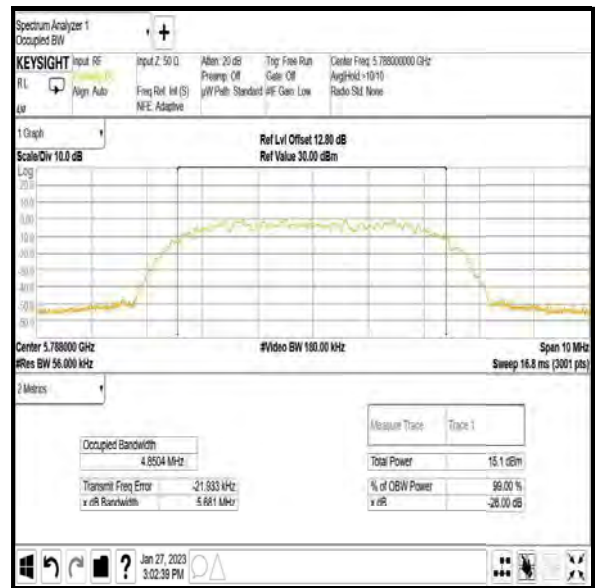

Middle Channel

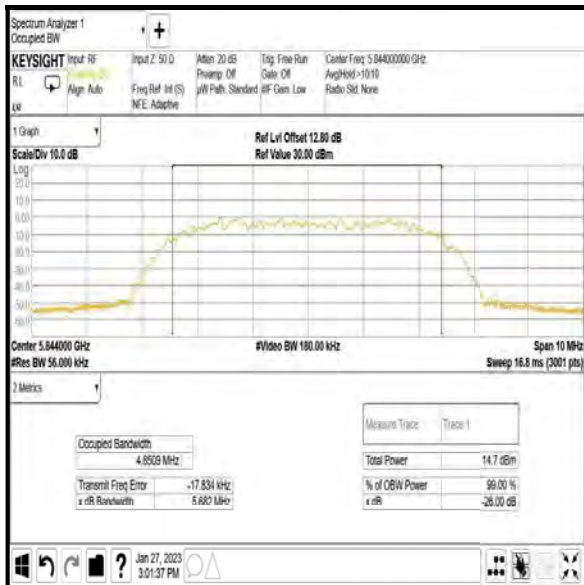

Top Channel

**4.3 Transmitter Minimum 6 dB Bandwidth (5.725-5.85 GHz band)****Test Summary:**

<b>Test Engineers:</b>	Jose Bayona & Luis Pazos Perez	<b>Test Dates:</b>	31 January 2023 & 01 February 2023
<b>Test Sample Serial Number:</b>	CQCHHKN7YM		

<b>FCC Reference:</b>	Part 15.407(e)
<b>Test Method Used:</b>	KDB 789033 D02 Section II.C.2.

**Environmental Conditions:**

<b>Temperature (°C):</b>	20 to 23
<b>Relative Humidity (%):</b>	32 to 37

**Note(s):**

1. The test receiver resolution bandwidth was set to 100 kHz and video bandwidth 300 kHz. A peak detector was used, sweep time was set to auto and the trace mode was Max Hold. The span was set to 4 MHz for DH5, 6 MHz for 4DH5 and 10 MHz for 8DH5. The bandwidth was measured at 6 dB down from the peak of the signal.
2. The signal analyser was connected to the RF port on the EUT using suitable attenuation and RF cable.

**Transmitter Minimum 6 dB Bandwidth (5.725-5.85 GHz band) (continued)**

**Results: DH5 / SISO / Core 0 / iPA**

Channel	6 dB Bandwidth (kHz)	Limit (kHz)	Margin (kHz)	Result
Bottom	579.400	≥500	79.400	Complied
Middle	575.400	≥500	75.400	Complied
Top	567.400	≥500	67.400	Complied



Bottom Channel

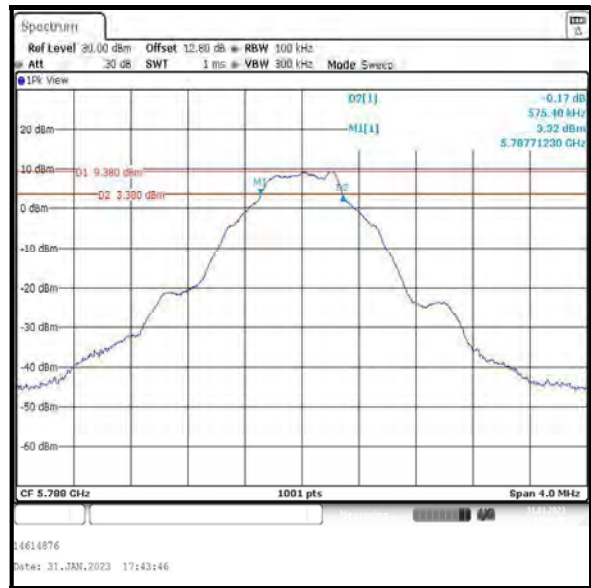

Middle Channel



Top Channel



**Transmitter Minimum 6 dB Bandwidth (5.725-5.85 GHz band) (continued)**

**Results: 4DH5 / SISO / Core 0 / iPA**

Channel	6 dB Bandwidth (kHz)	Limit (kHz)	Margin (kHz)	Result
Bottom	2139.900	≥500	1639.900	Complied
Middle	2139.900	≥500	1639.900	Complied
Top	2133.900	≥500	1633.900	Complied

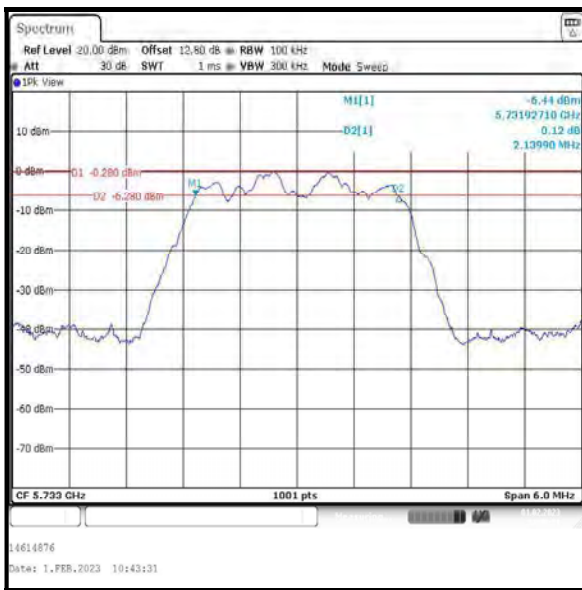

Bottom Channel

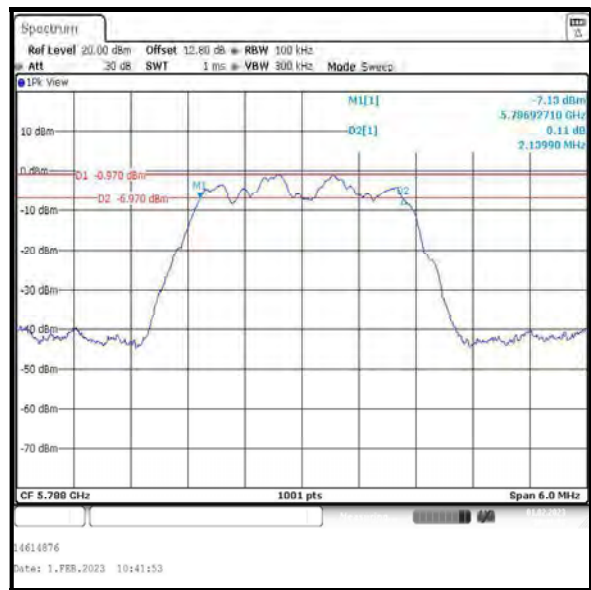

Middle Channel

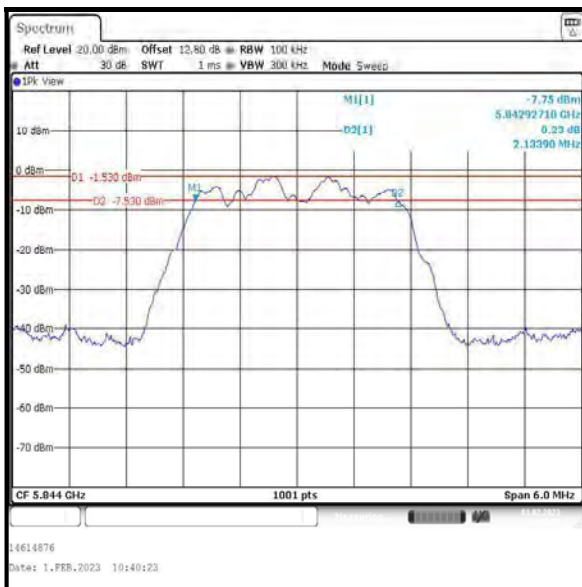

Top Channel

**Transmitter Minimum 6 dB Bandwidth (5.725-5.85 GHz band) (continued)**

**Results: 4DH5 / SISO / Core 0 / ePA**

Channel	6 dB Bandwidth (kHz)	Limit (kHz)	Margin (kHz)	Result
Bottom	2127.900	≥500	1627.900	Complied
Middle	2127.900	≥500	1627.900	Complied
Top	2121.900	≥500	1621.900	Complied

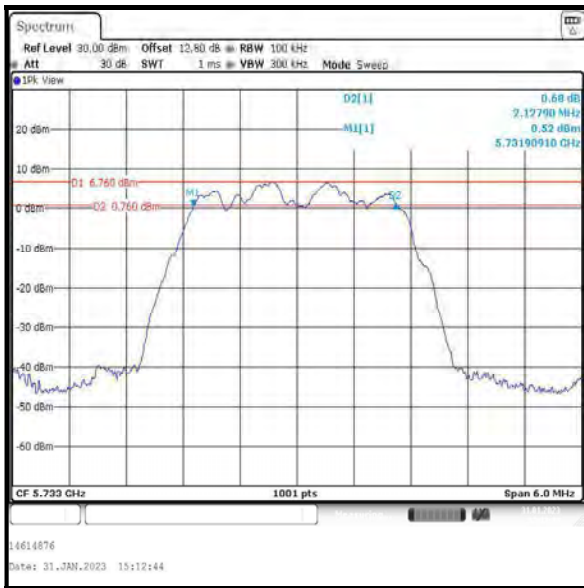

Bottom Channel

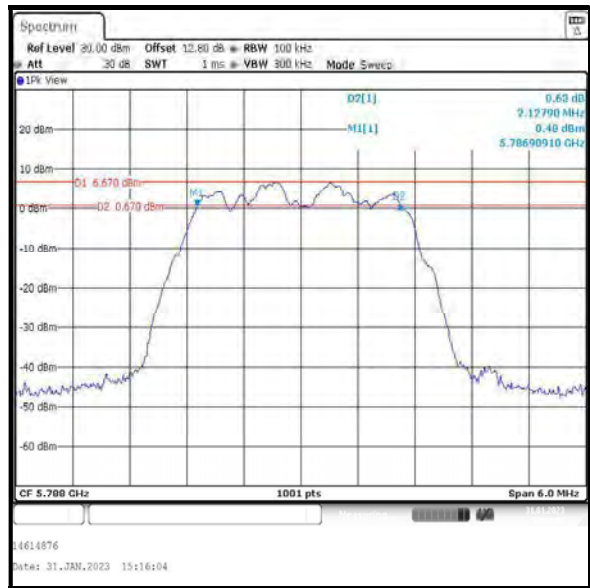

Middle Channel

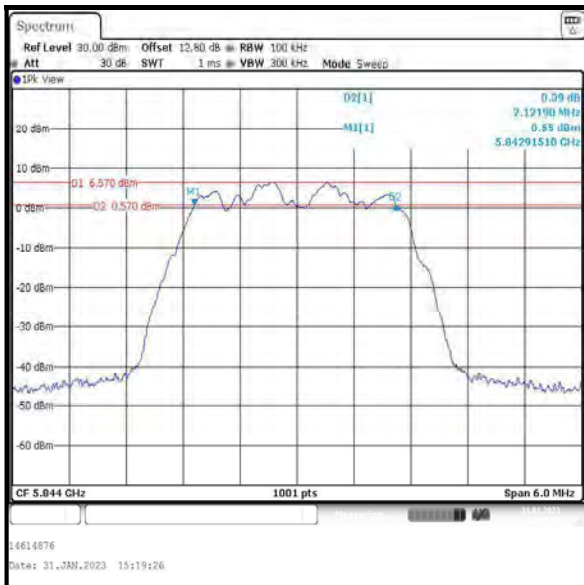

Top Channel

**Transmitter Minimum 6 dB Bandwidth (5.725-5.85 GHz band) (continued)**

**Results: 8DH5 / SISO / Core 0 / iPA**

Channel	6 dB Bandwidth (kHz)	Limit (kHz)	Margin (kHz)	Result
Bottom	4214.000	≥500	3714.000	Complied
Middle	4216.000	≥500	3716.000	Complied
Top	4216.000	≥500	3716.000	Complied

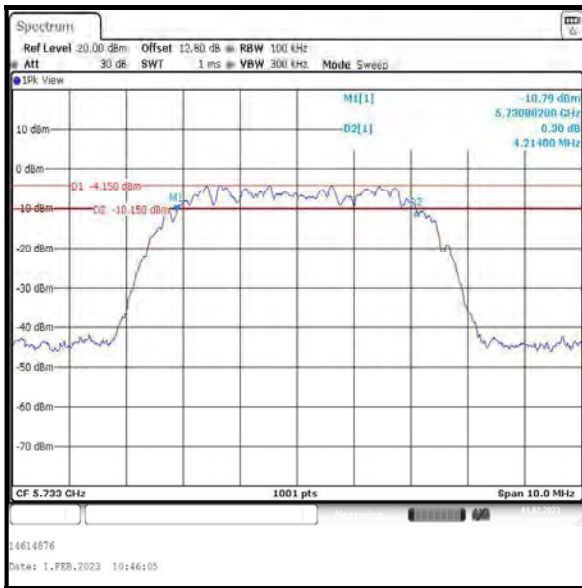

Bottom Channel

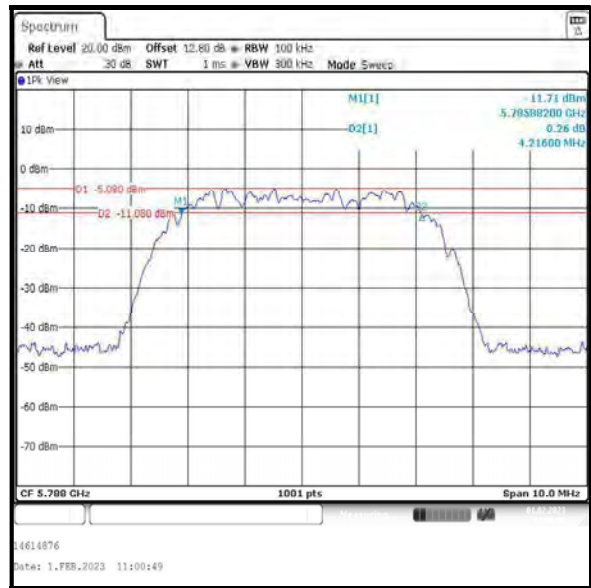

Middle Channel

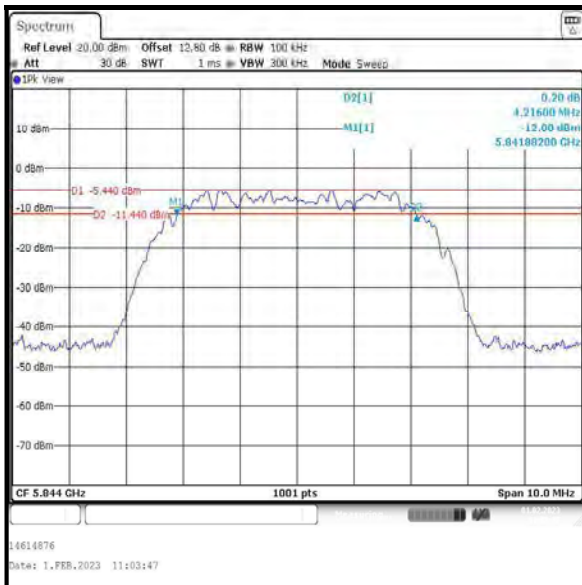

Top Channel

**Transmitter Minimum 6 dB Bandwidth (5.725-5.85 GHz band) (continued)**

**Results: 8DH5 / SISO / Core 0 / ePA**

Channel	6 dB Bandwidth (kHz)	Limit (kHz)	Margin (kHz)	Result
Bottom	4206.000	≥500	3706.000	Complied
Middle	4206.000	≥500	3706.000	Complied
Top	4206.000	≥500	3706.000	Complied

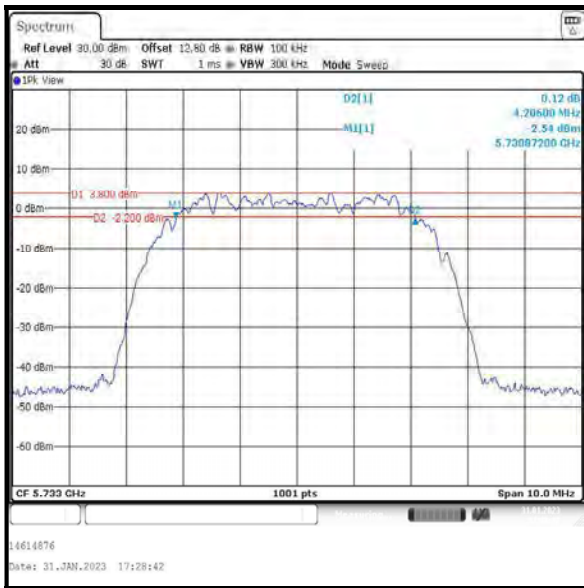

Bottom Channel

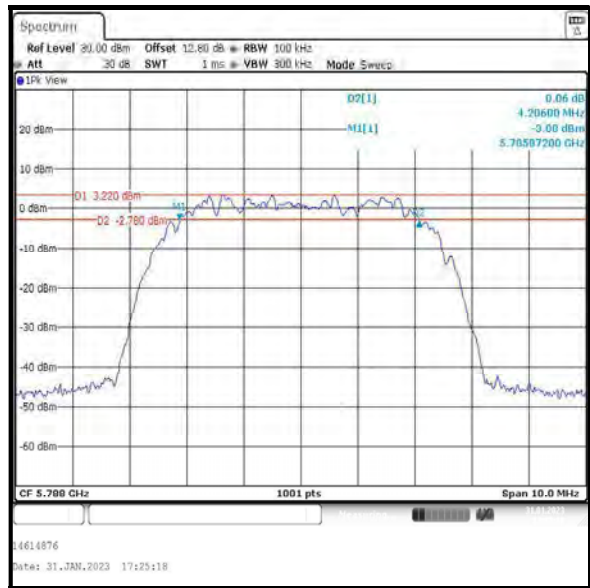

Middle Channel

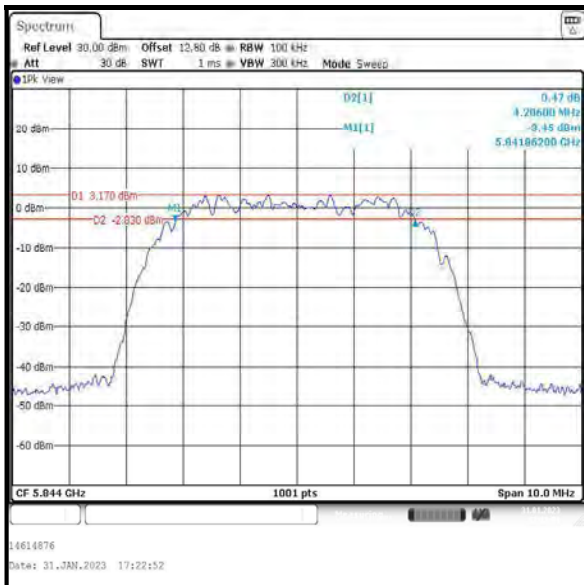

Top Channel

**Transmitter Minimum 6 dB Bandwidth (5.725-5.85 GHz band) (continued)**

**Results: DH5 / SISO / Core 1 / iPA**

Channel	6 dB Bandwidth (kHz)	Limit (kHz)	Margin (kHz)	Result
Bottom	567.400	≥500	67.400	Complied
Middle	555.400	≥500	55.400	Complied
Top	555.400	≥500	55.400	Complied



Bottom Channel

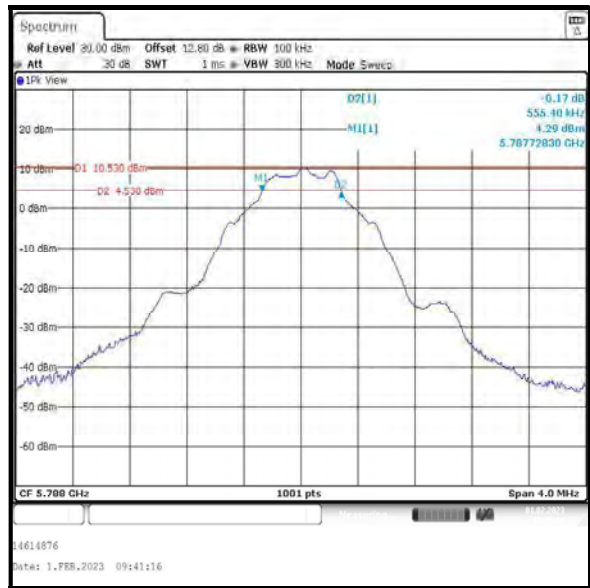

Middle Channel

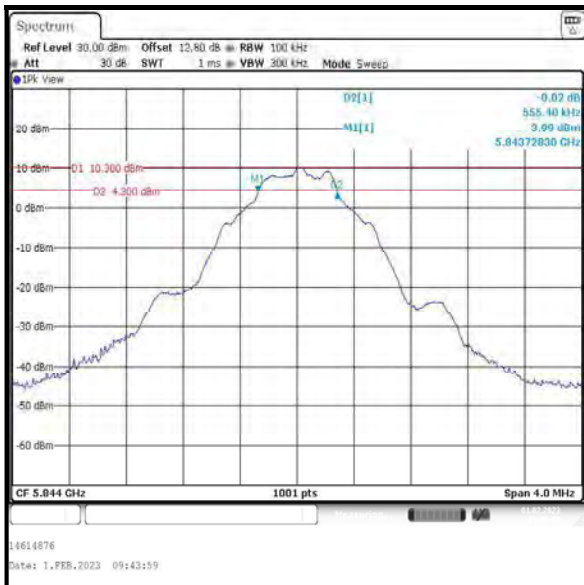

Top Channel

**Transmitter Minimum 6 dB Bandwidth (5.725-5.85 GHz band) (continued)**

**Results: 4DH5 / SISO / Core 1 / iPA**

Channel	6 dB Bandwidth (kHz)	Limit (kHz)	Margin (kHz)	Result
Bottom	2139.900	≥500	1639.900	Complied
Middle	2151.800	≥500	1651.800	Complied
Top	2133.900	≥500	1633.900	Complied

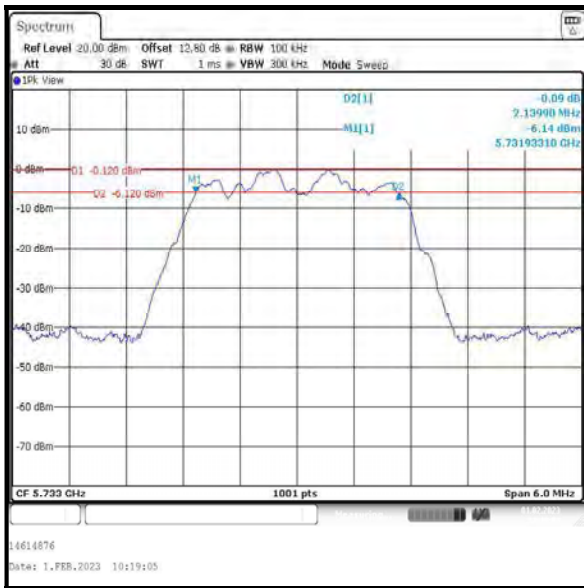

Bottom Channel

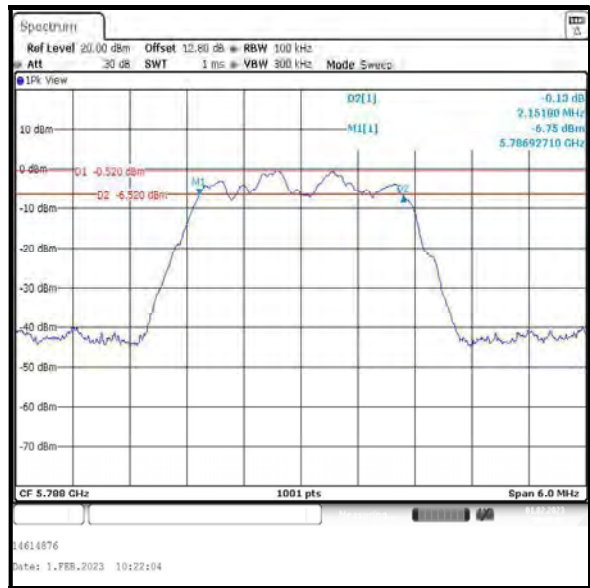

Middle Channel

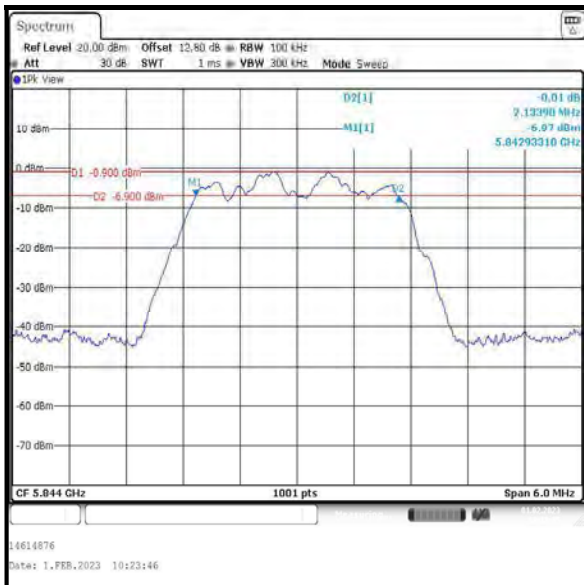

Top Channel

**Transmitter Minimum 6 dB Bandwidth (5.725-5.85 GHz band) (continued)**

**Results: 4DH5 / SISO / Core 1 / ePA**

Channel	6 dB Bandwidth (kHz)	Limit (kHz)	Margin (kHz)	Result
Bottom	2151.800	≥500	1651.800	Complied
Middle	2181.800	≥500	1681.800	Complied
Top	2151.800	≥500	1651.800	Complied

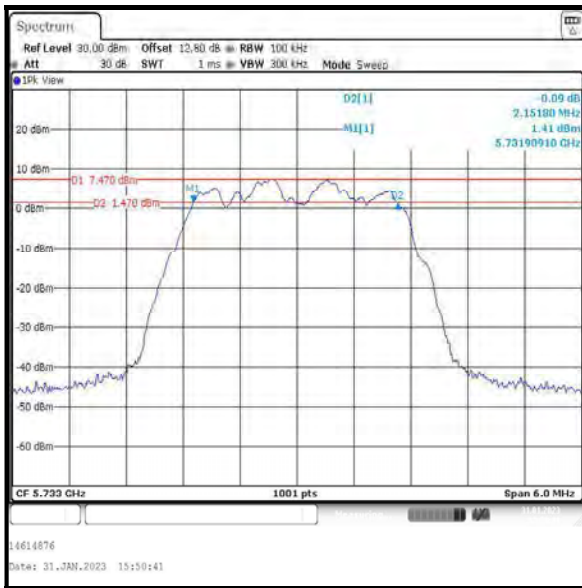

Bottom Channel

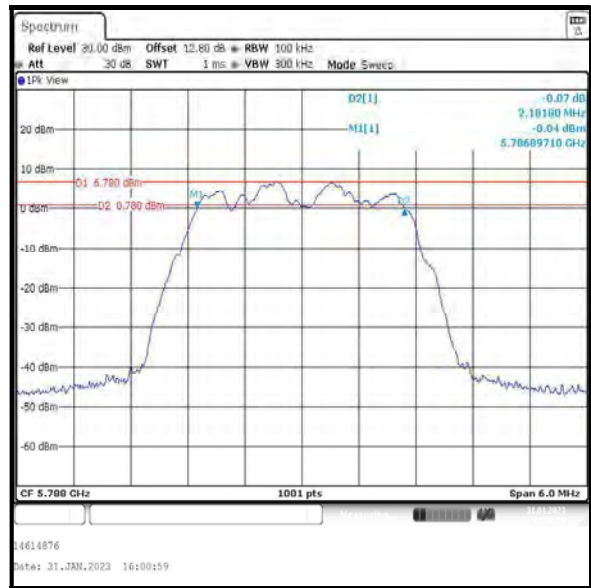

Middle Channel

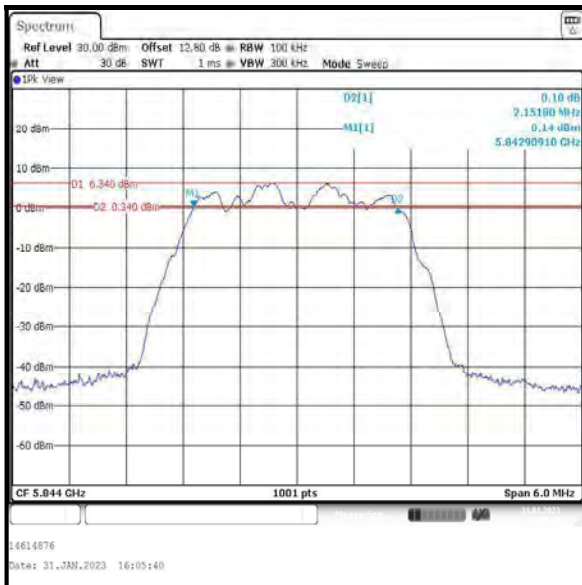

Top Channel

**Transmitter Minimum 6 dB Bandwidth (5.725-5.85 GHz band) (continued)**

**Results: 8DH5 / SISO / Core 1 / iPA**

Channel	6 dB Bandwidth (kHz)	Limit (kHz)	Margin (kHz)	Result
Bottom	4216.000	≥500	3716.000	Complied
Middle	4206.000	≥500	3706.000	Complied
Top	4206.000	≥500	3706.000	Complied

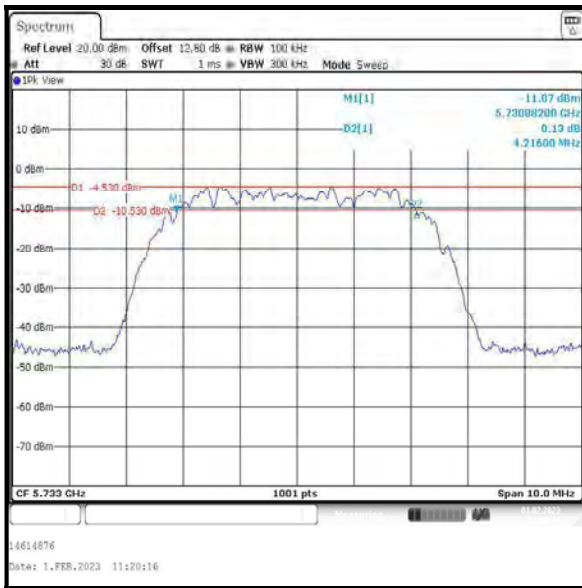

Bottom Channel

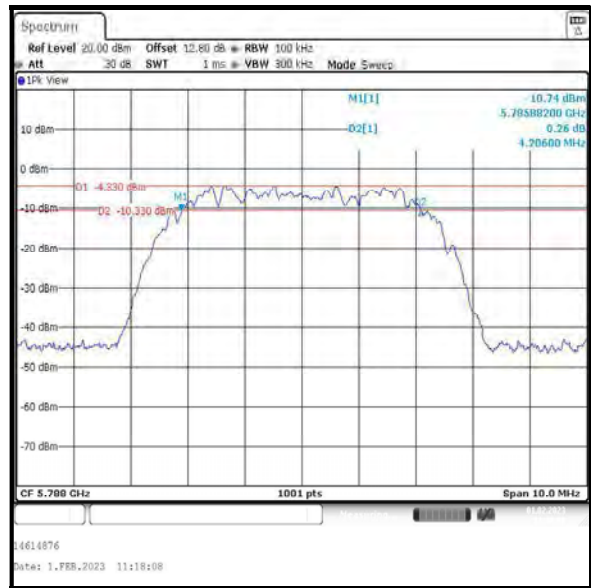

Middle Channel

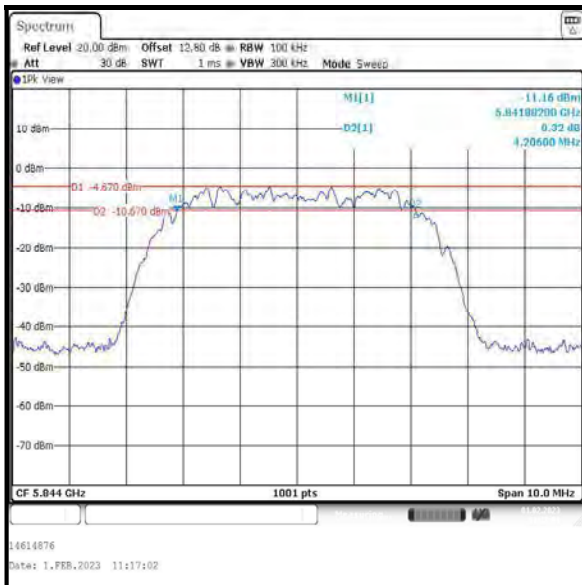

Top Channel



**Transmitter Minimum 6 dB Bandwidth (5.725-5.85 GHz band) (continued)**

**Results: 8DH5 / SISO / Core 1 / ePA**

Channel	6 dB Bandwidth (kHz)	Limit (kHz)	Margin (kHz)	Result
Bottom	4206.000	≥500	3706.000	Complied
Middle	4206.000	≥500	3706.000	Complied
Top	4206.000	≥500	3706.000	Complied

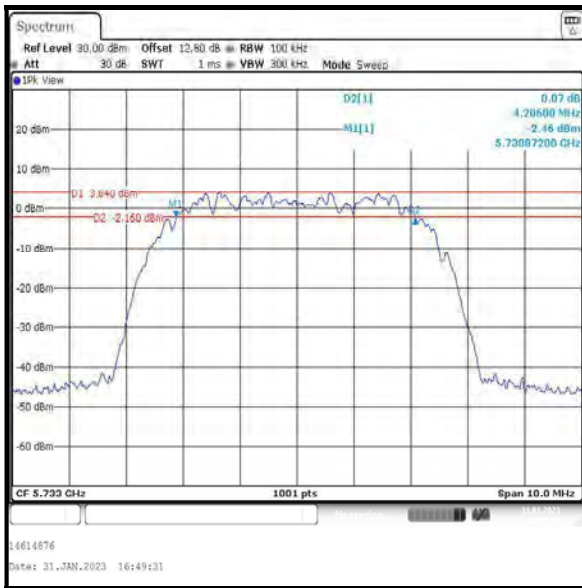

Bottom Channel

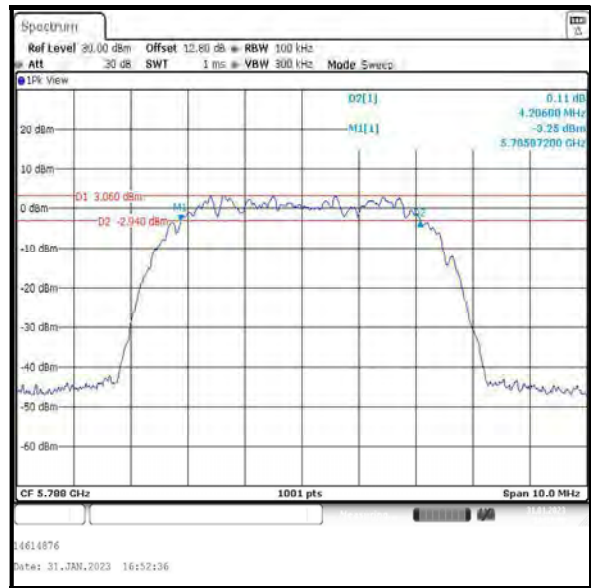

Middle Channel

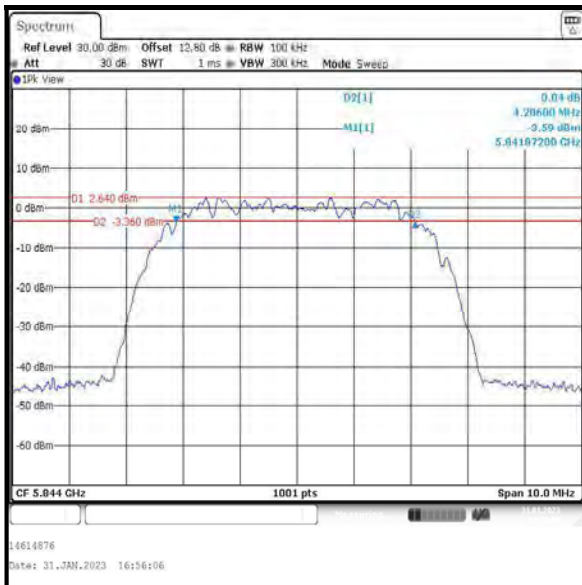

Top Channel

**Transmitter Minimum 6 dB Bandwidth (5.725-5.85 GHz band) (continued)**

**Results: DH5 / Beamforming / Core 0 / iPA**

Channel	6 dB Bandwidth (kHz)	Limit (kHz)	Margin (kHz)	Result
Bottom	575.400	≥500	75.400	Complied
Middle	571.400	≥500	71.400	Complied
Top	571.400	≥500	71.400	Complied



Bottom Channel



Middle Channel



Top Channel

**Transmitter Minimum 6 dB Bandwidth (5.725-5.85 GHz band) (continued)**

**Results: DH5 / Beamforming / Core 1 / iPA**

Channel	6 dB Bandwidth (kHz)	Limit (kHz)	Margin (kHz)	Result
Bottom	571.400	≥500	71.400	Complied
Middle	551.400	≥500	51.400	Complied
Top	555.400	≥500	55.400	Complied



Bottom Channel

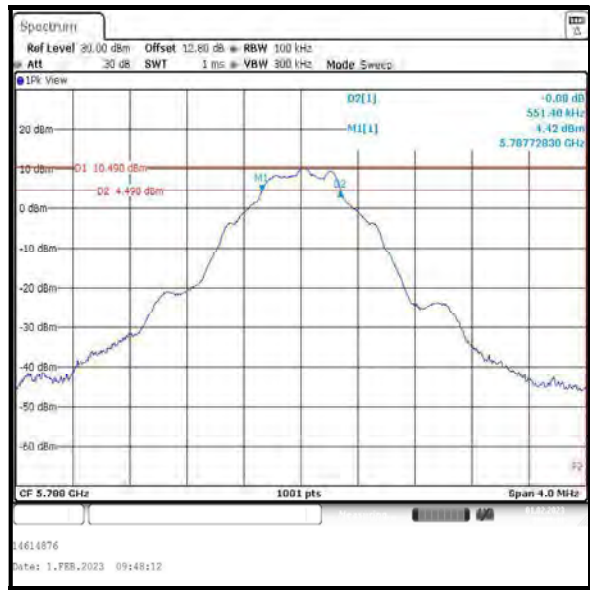

Middle Channel



Top Channel

**Transmitter Minimum 6 dB Bandwidth (5.725-5.85 GHz band) (continued)**

**Results: 4DH5 / Beamforming / Core 0 / iPA**

Channel	6 dB Bandwidth (kHz)	Limit (kHz)	Margin (kHz)	Result
Bottom	2139.900	≥500	1639.900	Complied
Middle	2139.900	≥500	1639.900	Complied
Top	2127.900	≥500	1627.900	Complied

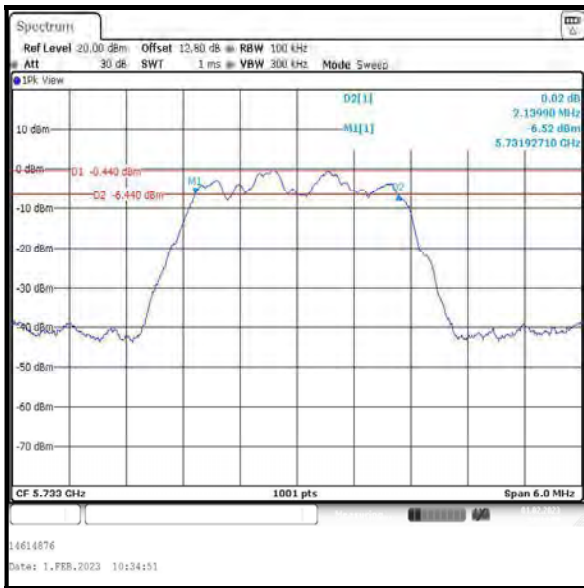

Bottom Channel

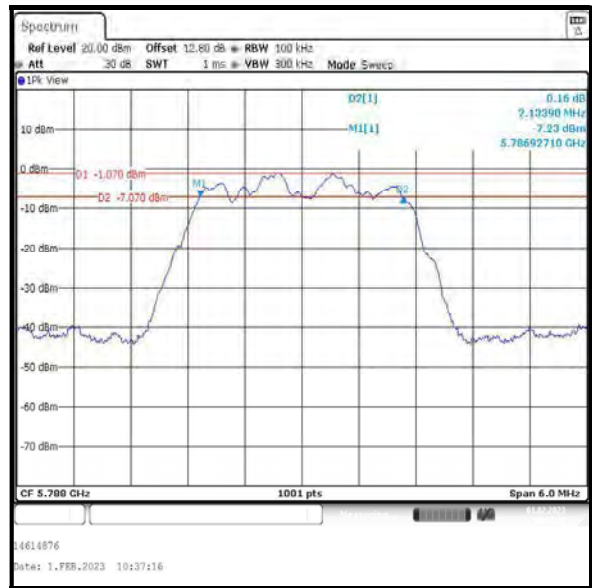

Middle Channel

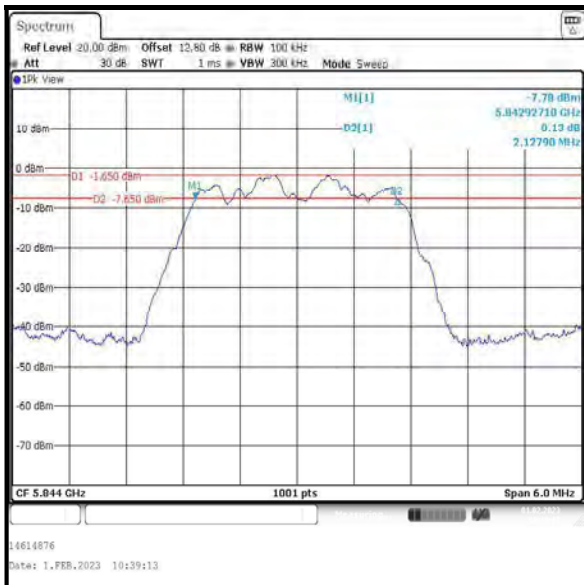

Top Channel

**Transmitter Minimum 6 dB Bandwidth (5.725-5.85 GHz band) (continued)**

**Results: 4DH5 / Beamforming / Core 1 / iPA**

Channel	6 dB Bandwidth (kHz)	Limit (kHz)	Margin (kHz)	Result
Bottom	2139.900	≥500	1639.900	Complied
Middle	2139.900	≥500	1639.900	Complied
Top	2139.900	≥500	1639.900	Complied

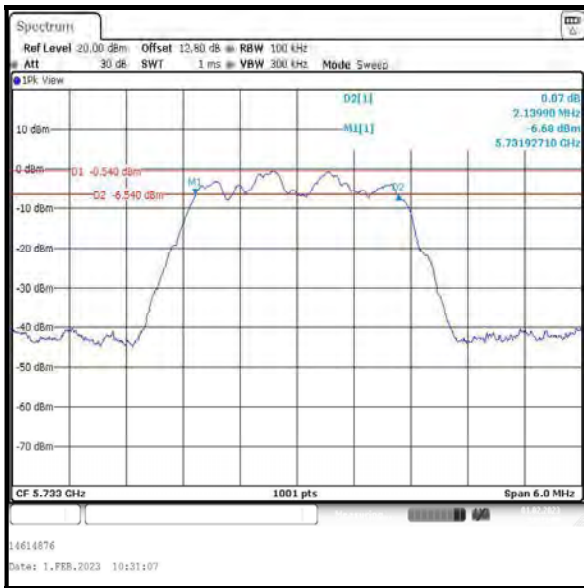

Bottom Channel

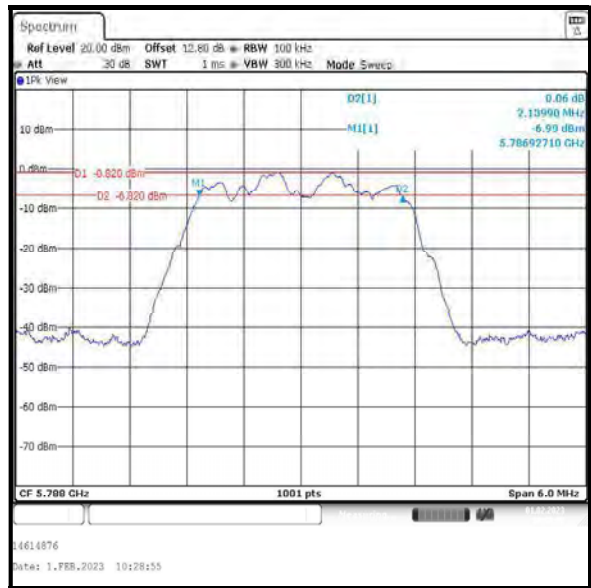

Middle Channel

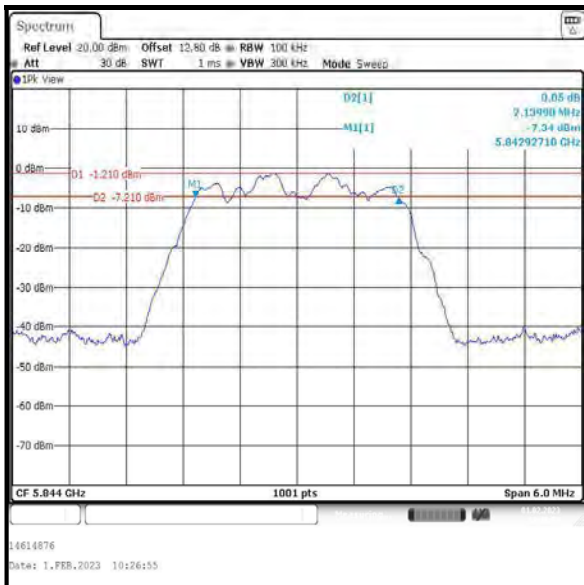

Top Channel

**Transmitter Minimum 6 dB Bandwidth (5.725-5.85 GHz band) (continued)**

**Results: 4DH5 / Beamforming / Core 0 / ePA**

Channel	6 dB Bandwidth (kHz)	Limit (kHz)	Margin (kHz)	Result
Bottom	2157.800	≥500	1657.800	Complied
Middle	2145.900	≥500	1645.900	Complied
Top	2145.900	≥500	1645.900	Complied

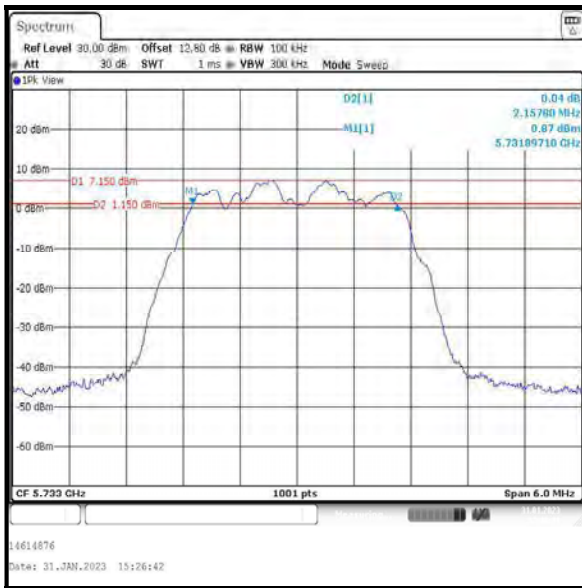

Bottom Channel

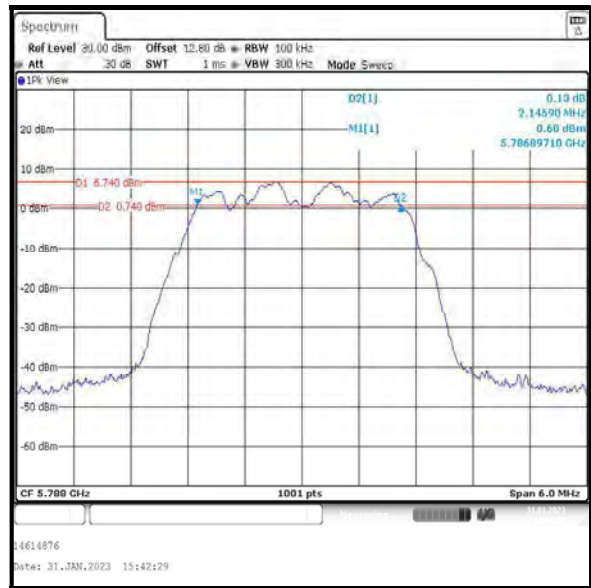

Middle Channel

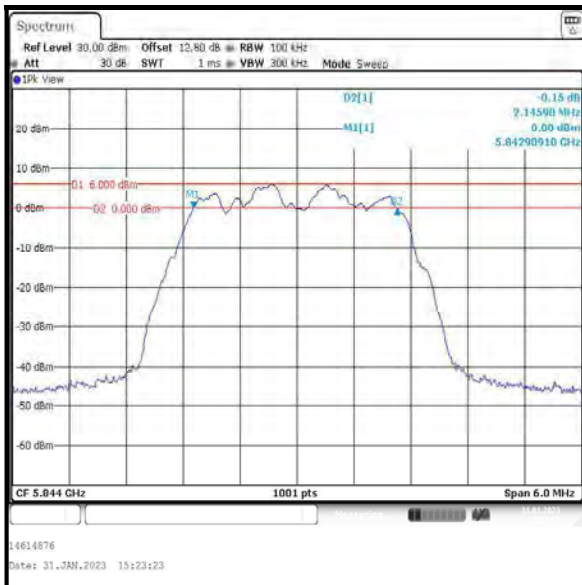

Top Channel

**Transmitter Minimum 6 dB Bandwidth (5.725-5.85 GHz band) (continued)**

**Results: 4DH5 / Beamforming / Core 1 / ePA**

Channel	6 dB Bandwidth (kHz)	Limit (kHz)	Margin (kHz)	Result
Bottom	2145.900	≥500	1645.900	Complied
Middle	2151.800	≥500	1651.800	Complied
Top	2151.800	≥500	1651.800	Complied

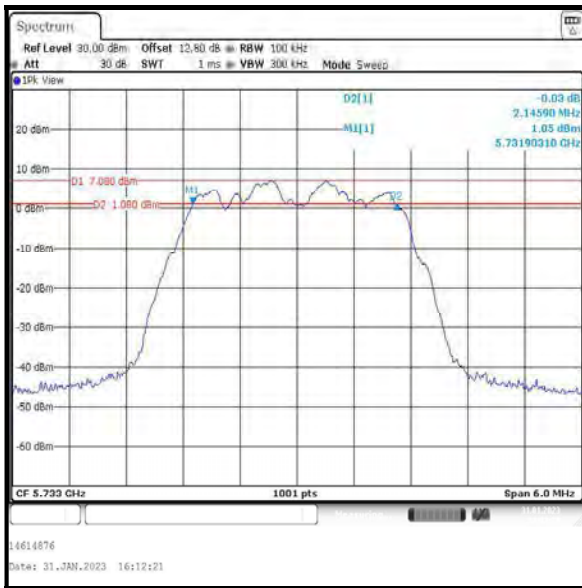

Bottom Channel

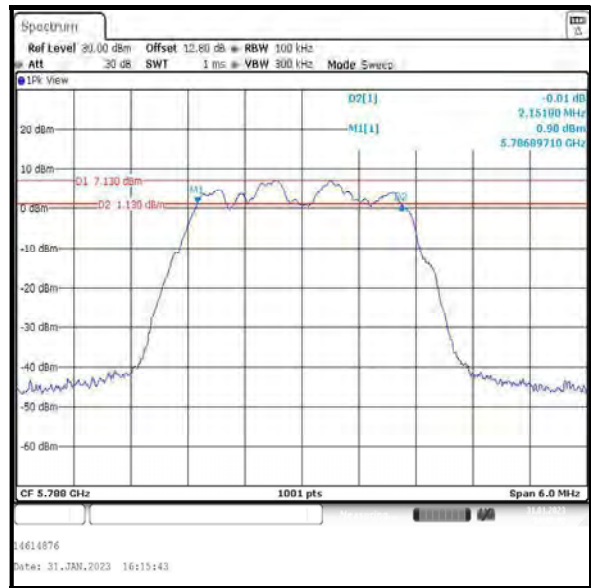

Middle Channel

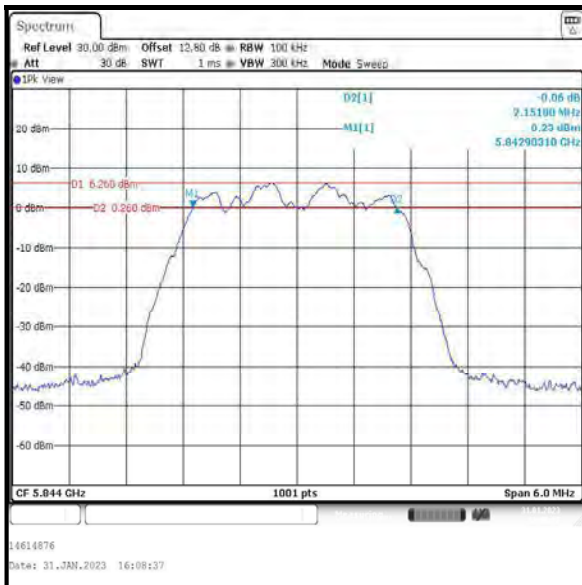

Top Channel

**Transmitter Minimum 6 dB Bandwidth (5.725-5.85 GHz band) (continued)**

**Results: 8DH5 / Beamforming / Core 0 / iPA**

Channel	6 dB Bandwidth (kHz)	Limit (kHz)	Margin (kHz)	Result
Bottom	4206.000	≥500	3706.000	Complied
Middle	4206.000	≥500	3706.000	Complied
Top	4216.000	≥500	3716.000	Complied

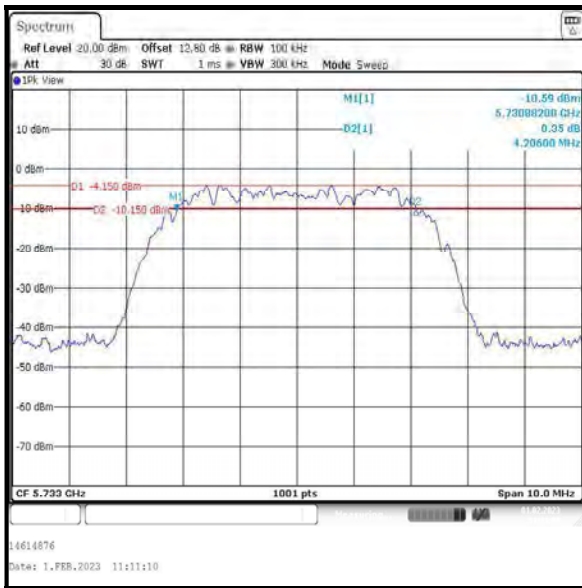

Bottom Channel

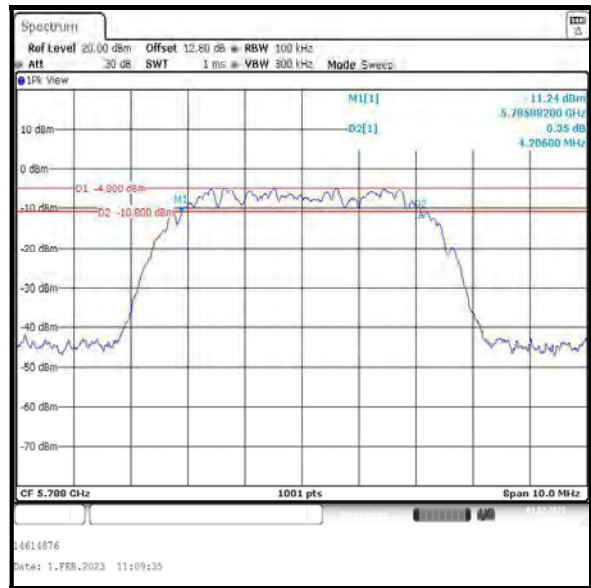

Middle Channel

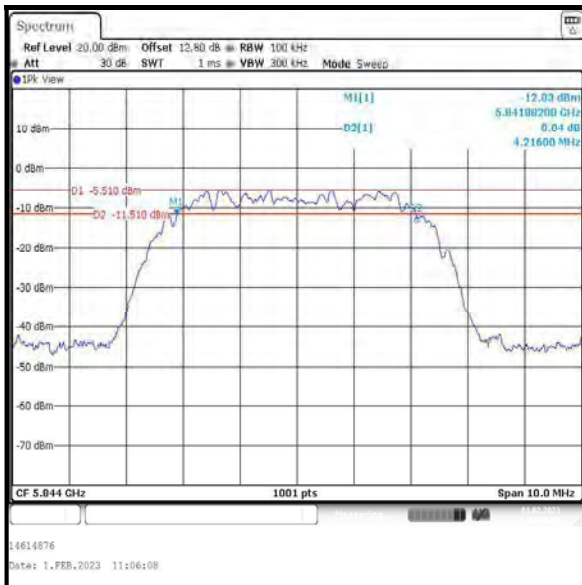

Top Channel



**Transmitter Minimum 6 dB Bandwidth (5.725-5.85 GHz band) (continued)**

**Results: 8DH5 / Beamforming / Core 1 / iPA**

Channel	6 dB Bandwidth (kHz)	Limit (kHz)	Margin (kHz)	Result
Bottom	4206.000	≥500	3706.000	Complied
Middle	4206.000	≥500	3706.000	Complied
Top	4206.000	≥500	3706.000	Complied

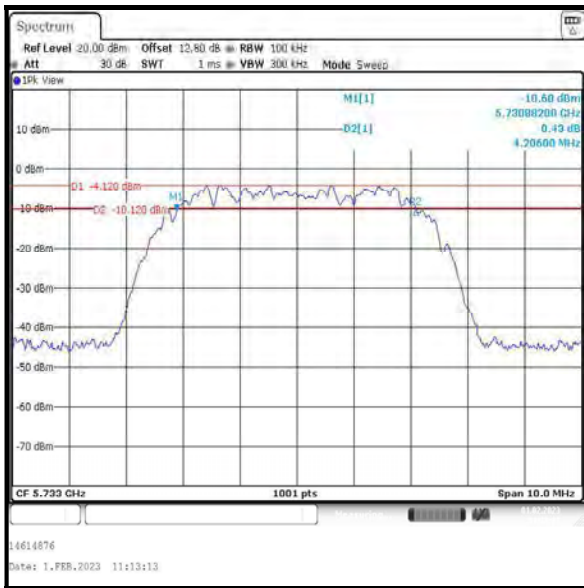

Bottom Channel

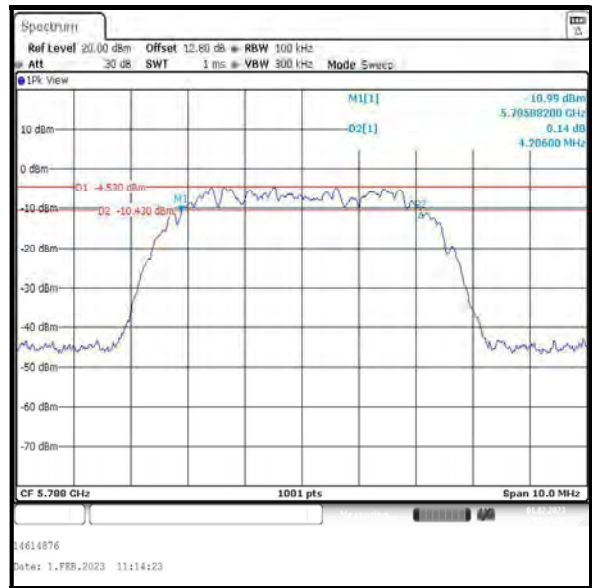

Middle Channel

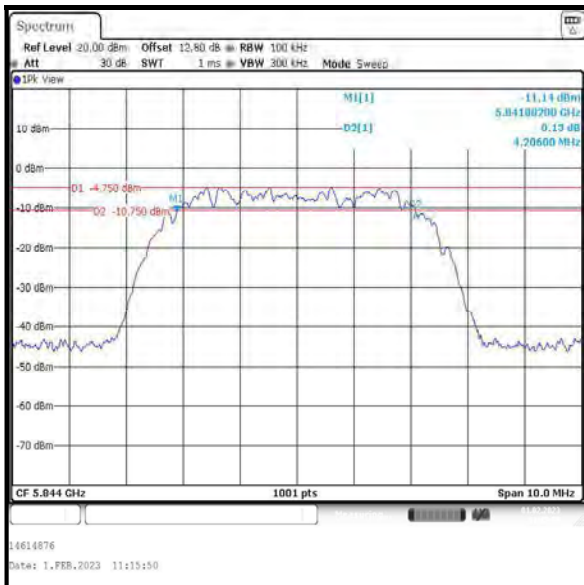

Top Channel

**Transmitter Minimum 6 dB Bandwidth (5.725-5.85 GHz band) (continued)**

**Results: 8DH5 / Beamforming / Core 0 / ePA**

Channel	6 dB Bandwidth (kHz)	Limit (kHz)	Margin (kHz)	Result
Bottom	4206.000	≥500	3706.000	Complied
Middle	4206.000	≥500	3706.000	Complied
Top	4206.000	≥500	3706.000	Complied



Bottom Channel

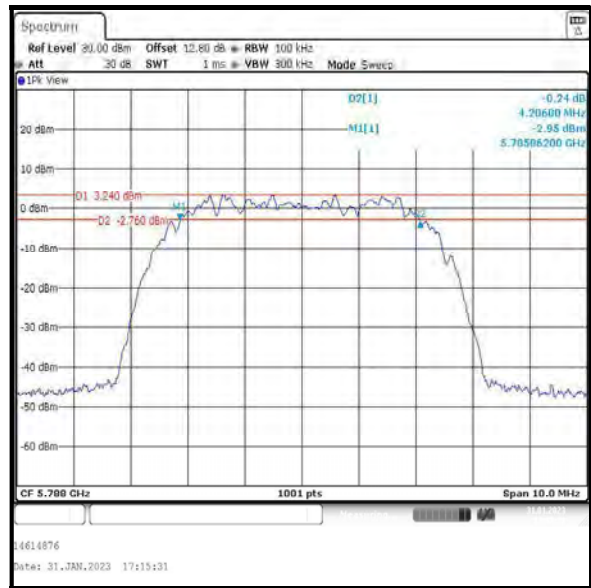

Middle Channel

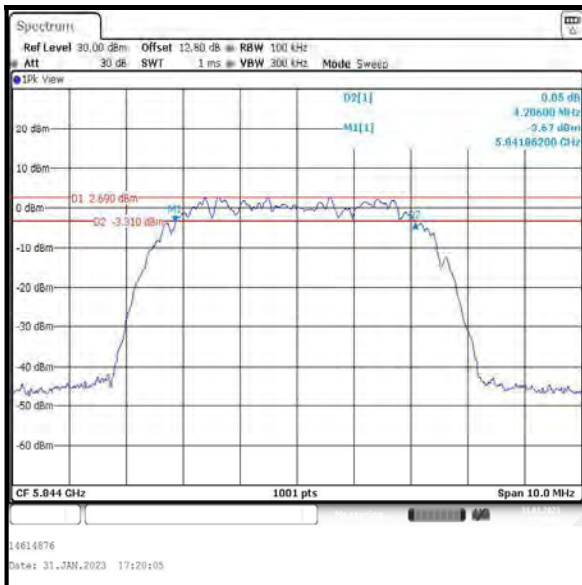

Top Channel

**Transmitter Minimum 6 dB Bandwidth (5.725-5.85 GHz band) (continued)**

**Results: 8DH5 / Beamforming / Core 1 / ePA**

Channel	6 dB Bandwidth (kHz)	Limit (kHz)	Margin (kHz)	Result
Bottom	4206.000	≥500	3706.000	Complied
Middle	4206.000	≥500	3706.000	Complied
Top	4206.000	≥500	3706.000	Complied



Bottom Channel

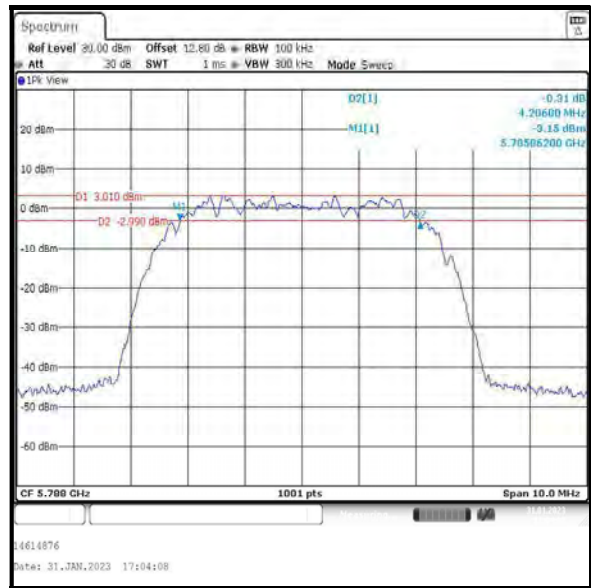

Middle Channel

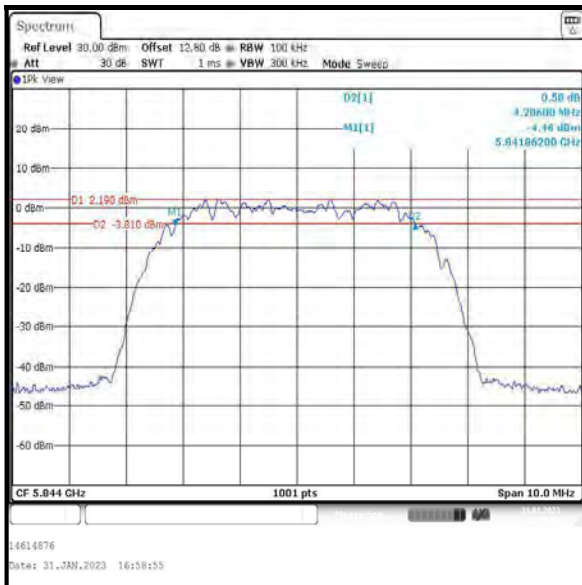

Top Channel

## **4.4 Transmitter Maximum Conducted Output Power**

### **4.4.1 5.15-5.25 GHz band**

#### **Test Summary:**

<b>Test Engineers:</b>	Jose Bayona & Luis Pazos Perez	<b>Test Dates:</b>	02 February 2023 to 08 February 2023
<b>Test Sample Serial Number:</b>	CQCHHKN7YM		

<b>FCC Reference:</b>	Part 15.407(a)(1)(iv)
<b>Test Method Used:</b>	KDB 789033 D02 Section II.E.2.b) and II.E.2.d)

#### **Environmental Conditions:**

<b>Temperature (°C):</b>	23
<b>Relative Humidity (%):</b>	35 to 38

#### **Note(s):**

- For conducted power tests where the duty cycle is >98%, the measurements were performed using a signal analyser in accordance with FCC KDB 789033 II.E.2.b) Method SA-1. Where the duty cycle is <98%, the measurements were performed in accordance with FCC KDB 789033 II.E.2.d) Method SA-2. The signal analyser's integration function was used to integrate across the 26 dB emission bandwidth. The resolution bandwidth was set to 1 MHz and video bandwidth 3 MHz. An RMS detector was used and sweep time was set to auto and 500 traces performed. The span was set to encompass the entire 26 dB emission bandwidth. The channel power results are recorded in the tables below.
- For DH5 where the EUT was transmitting at <98% duty cycle, the calculated duty cycle in Section 4.1 was added to the measured power in order to compute the average power during the actual transmission time.
- The Part 15.407(a)(1)(iv) limit shall not exceed 250 mW (24.0 dBm).
- For Beamforming modes, conducted power was measured on both ports and then combined using the measure-and-sum method stated in FCC KDB 662911 D01 Section E)1).
- For details on antenna gains refer to Section 3.4 of this test report.
- For all modes of operation, the antenna gain is > 6 dBi. In accordance with Part 15.407(a)(1)(iv), the limit was reduced by the amount in dB the antenna gain exceeds 6 dBi. Therefore the limit of 24 dBm has been reduced by using the following calculation:
 
$$\begin{aligned} \text{SISO / Core 0: } & 24 \text{ dBm} - 3.7 \text{ dB} = 20.3 \text{ dBm} \\ \text{SISO / Core 1: } & 24 \text{ dBm} - 0.9 \text{ dB} = 23.1 \text{ dBm} \\ \text{Beamforming / Core 0+ Core 1: } & 24 \text{ dBm} - 5.4 \text{ dB} = 18.6 \text{ dBm} \end{aligned}$$
- The signal analyser was connected to the RF port on the EUT using an RF suitable attenuation and RF cable. An RF level offset was entered on the signal analyser to compensate for the loss of the attenuator and RF cable.

**Transmitter Maximum Conducted Output Power (5.15-5.25 GHz band) (continued)**

**Results: DH5 / SISO / Core 0 / iPA**

Channel	Frequency (MHz)	Conducted Power (dBm)	Duty cycle correction factor (dB)	Corrected Conducted Power (dBm)	Limit (dBm)	Margin (dB)	Result
Bottom	5162	4.9	1.1	6.0	20.3	14.3	Complied
Middle	5203	4.8	1.1	5.9	20.3	14.4	Complied
Top	5245	4.6	1.1	5.7	20.3	14.6	Complied

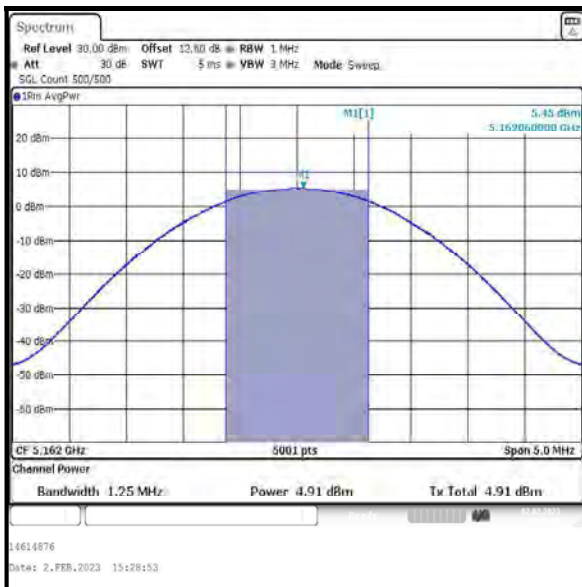

Bottom Channel

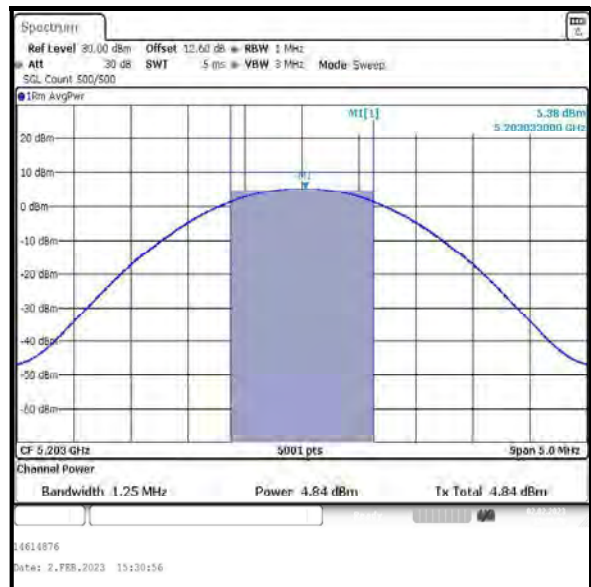

Middle Channel

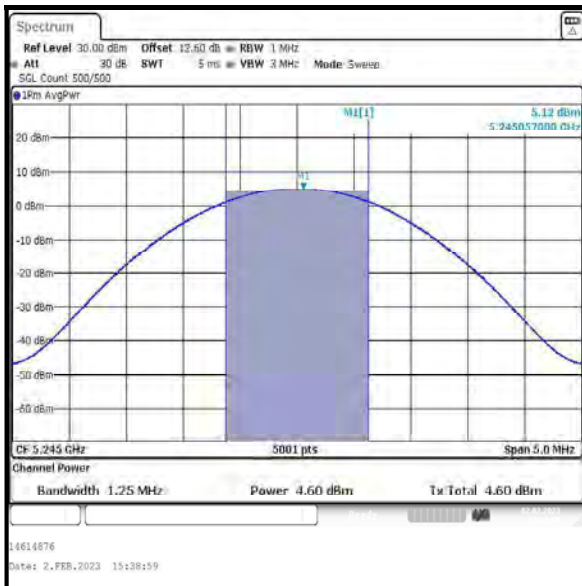

Top Channel

**Transmitter Maximum Conducted Output Power (5.15-5.25 GHz band) (continued)**

**Results: 4DH5 / SISO / Core 0 / iPA**

Channel	Frequency (MHz)	Conducted Power (dBm)	Limit (dBm)	Margin (dB)	Result
Bottom	5162	3.5	20.3	16.8	Complied
Middle	5203	3.4	20.3	16.9	Complied
Top	5245	3.3	20.3	17.0	Complied

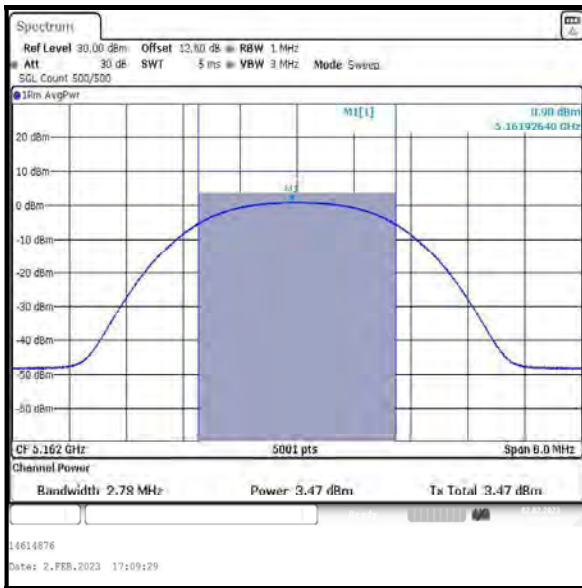

**Bottom Channel**

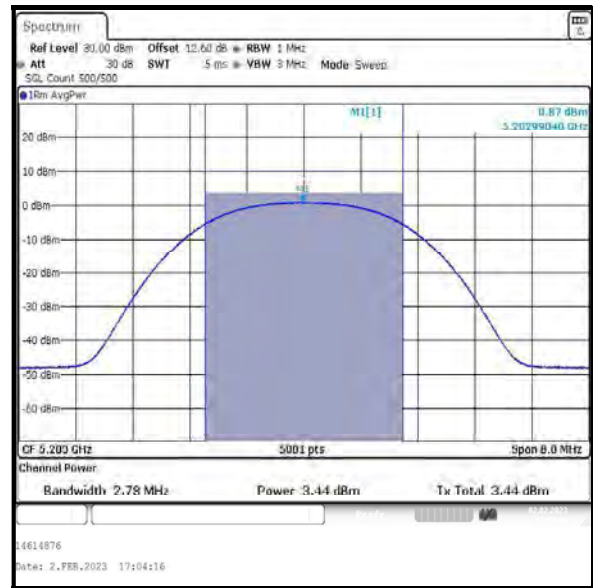

**Middle Channel**

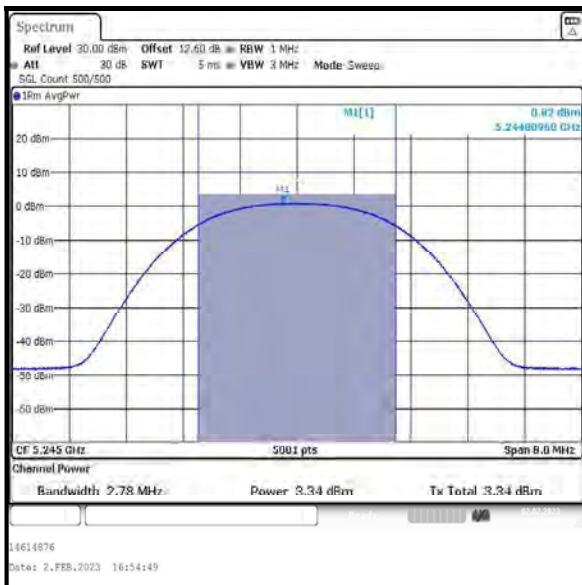

**Top Channel**

**Transmitter Maximum Conducted Output Power (5.15-5.25 GHz band) (continued)**

**Results: 4DH5 / SISO / Core 0 / ePA**

Channel	Frequency (MHz)	Conducted Power (dBm)	Limit (dBm)	Margin (dB)	Result
Bottom	5162	7.6	20.3	12.7	Complied
Middle	5203	7.8	20.3	12.5	Complied
Top	5245	7.9	20.3	12.4	Complied

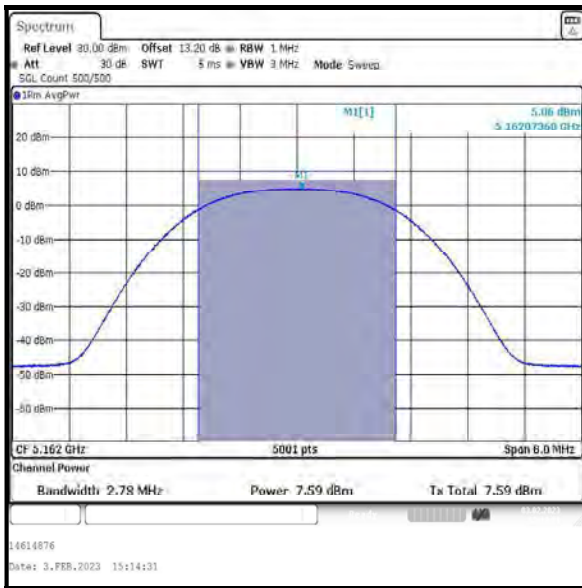

**Bottom Channel**

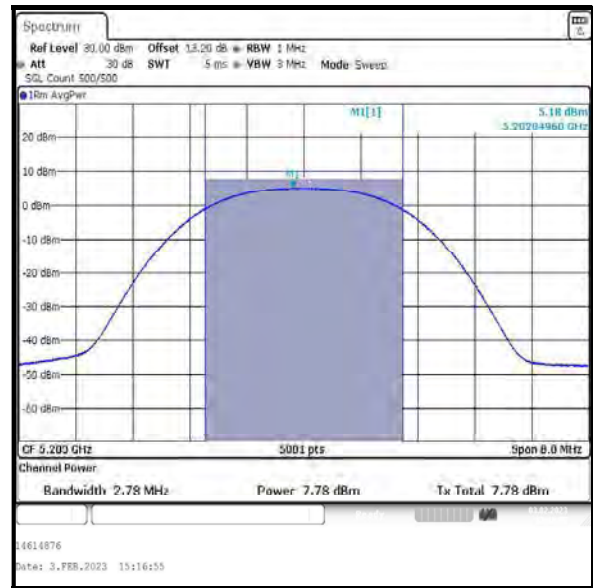

**Middle Channel**

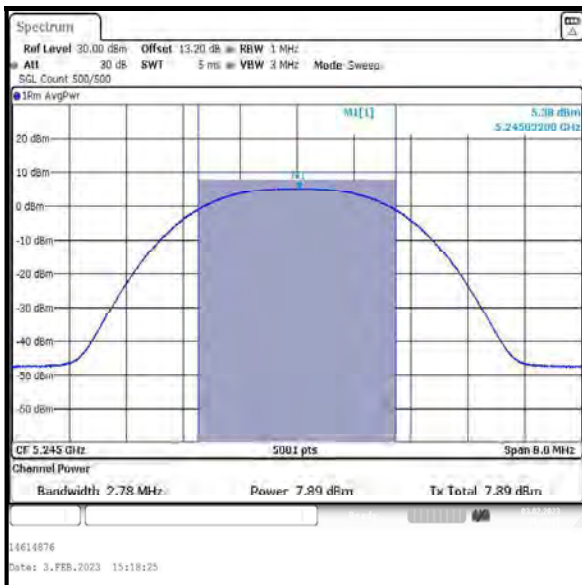

**Top Channel**

**Transmitter Maximum Conducted Output Power (5.15-5.25 GHz band) (continued)**

**Results: 8DH5 / SISO / Core 0 / iPA**

Channel	Frequency (MHz)	Conducted Power (dBm)	Limit (dBm)	Margin (dB)	Result
Bottom	5162	3.5	20.3	16.8	Complied
Middle	5203	3.0	20.3	17.3	Complied
Top	5245	3.3	20.3	17.0	Complied

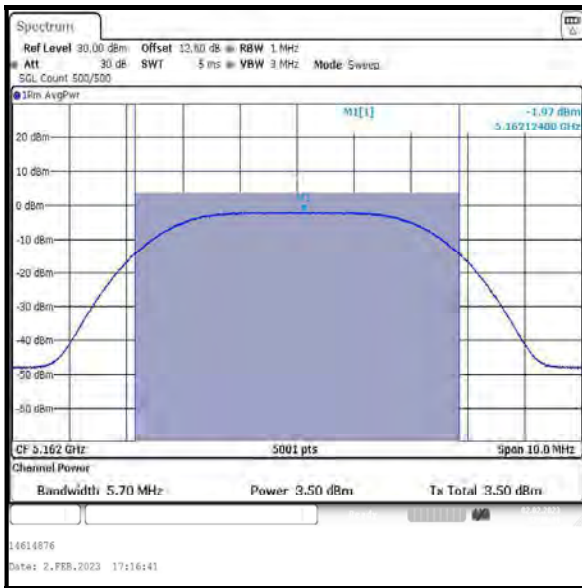

**Bottom Channel**

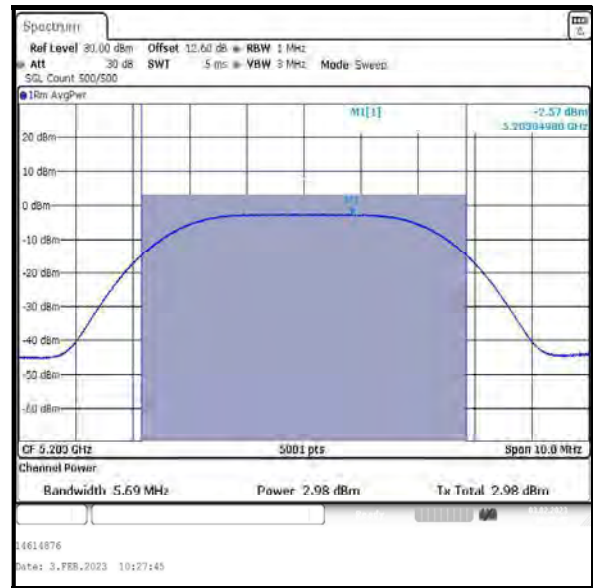

**Middle Channel**

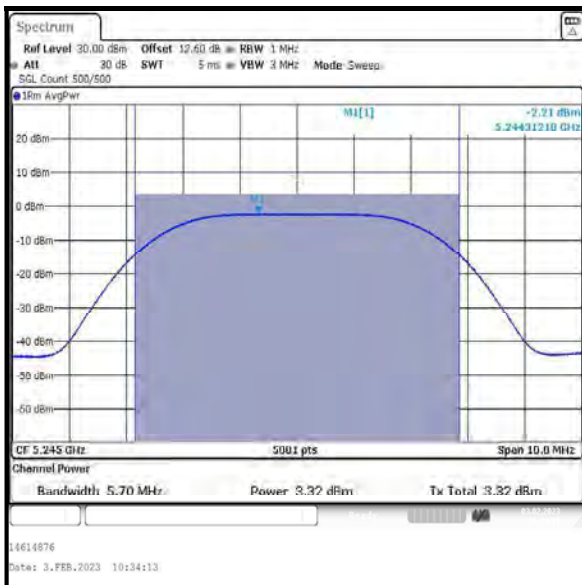

**Top Channel**



**Transmitter Maximum Conducted Output Power (5.15-5.25 GHz band) (continued)**

**Results: 8DH5 / SISO / Core 0 / ePA**

Channel	Frequency (MHz)	Conducted Power (dBm)	Limit (dBm)	Margin (dB)	Result
Bottom	5162	8.0	20.3	12.3	Complied
Middle	5203	7.7	20.3	12.6	Complied
Top	5245	7.9	20.3	12.4	Complied

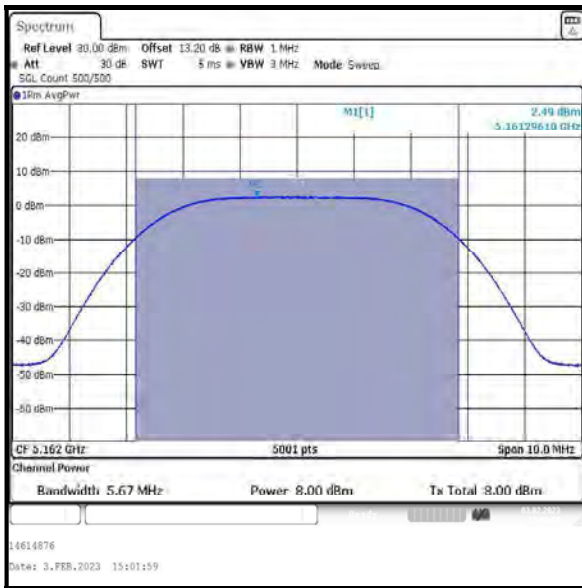

**Bottom Channel**

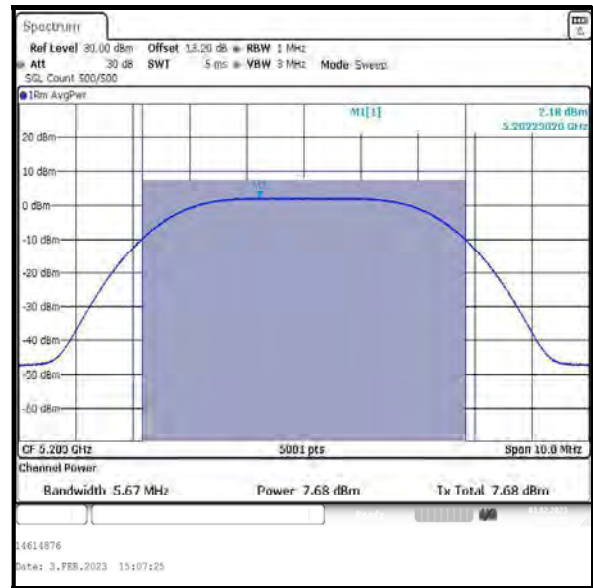

**Middle Channel**

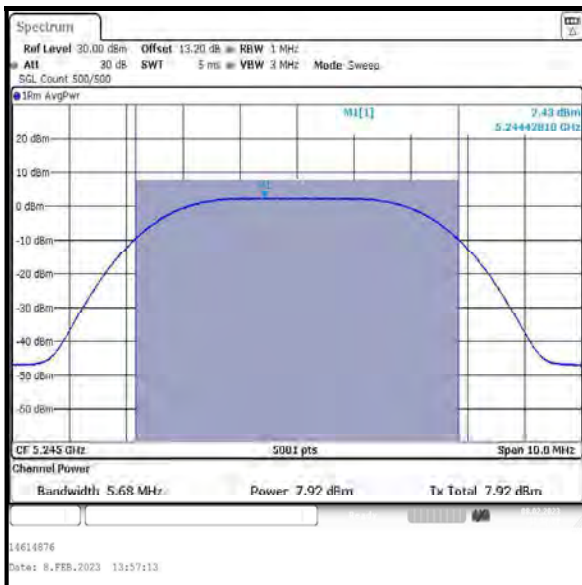

**Top Channel**

**Transmitter Maximum Conducted Output Power (5.15-5.25 GHz band) (continued)**

**Results: DH5 / SISO / Core 1 / iPA**

Channel	Frequency (MHz)	Conducted Power (dBm)	Duty cycle correction factor (dB)	Corrected Conducted Power (dBm)	Limit (dBm)	Margin (dB)	Result
Bottom	5162	7.7	1.1	8.8	23.1	14.3	Complied
Middle	5203	7.6	1.1	8.7	23.1	14.4	Complied
Top	5245	7.9	1.1	9.0	23.1	14.1	Complied

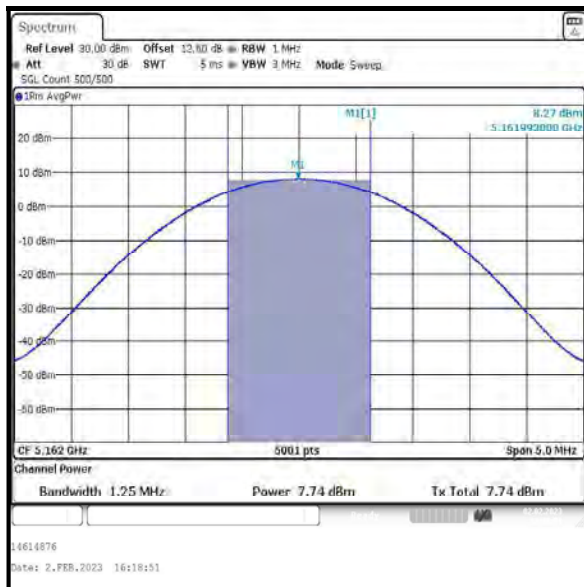

**Bottom Channel**

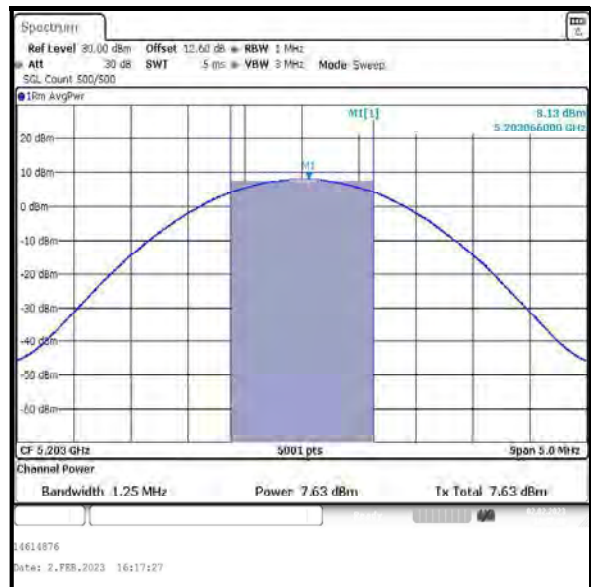

**Middle Channel**

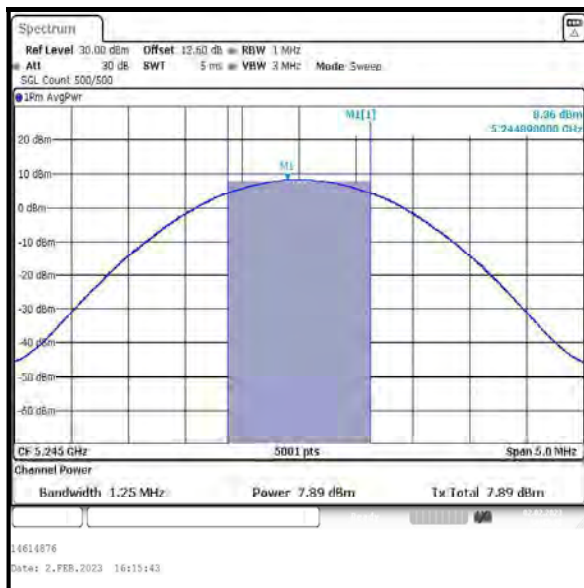

**Top Channel**

**Transmitter Maximum Conducted Output Power (5.15-5.25 GHz band) (continued)**

**Results: 4DH5 / SISO / Core 1 / iPA**

Channel	Frequency (MHz)	Conducted Power (dBm)	Limit (dBm)	Margin (dB)	Result
Bottom	5162	3.2	23.1	19.9	Complied
Middle	5203	3.4	23.1	19.7	Complied
Top	5245	3.3	23.1	19.8	Complied

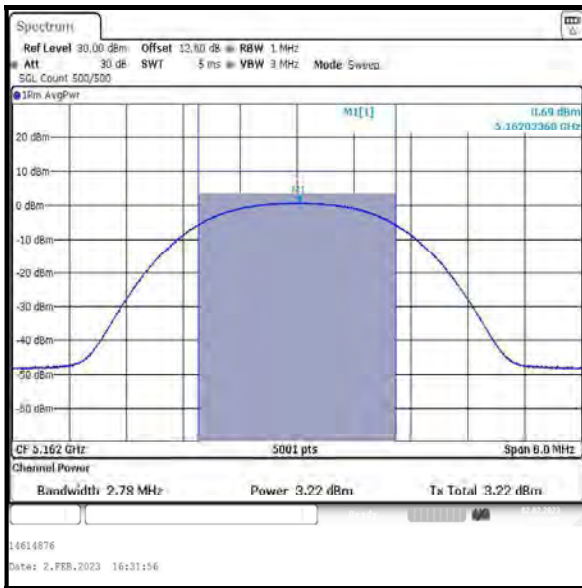

**Bottom Channel**

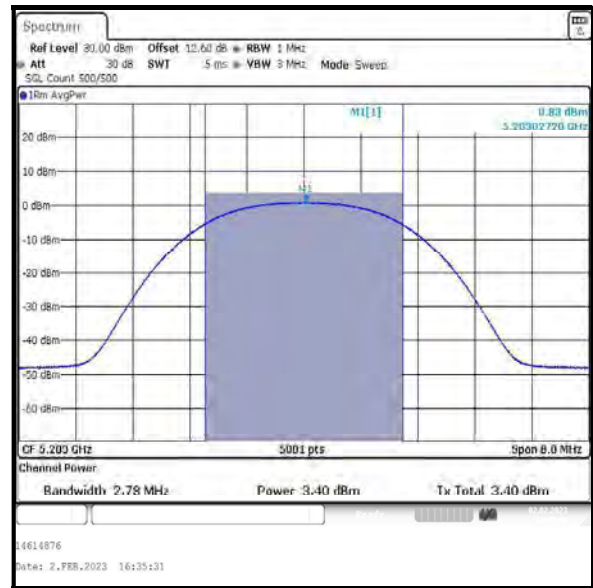

**Middle Channel**

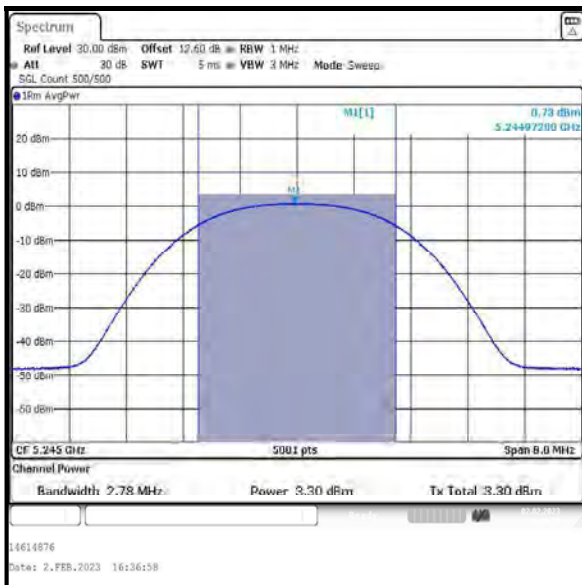

**Top Channel**

**Transmitter Maximum Conducted Output Power (5.15-5.25 GHz band) (continued)**

**Results: 4DH5 / SISO / Core 1 / ePA**

Channel	Frequency (MHz)	Conducted Power (dBm)	Limit (dBm)	Margin (dB)	Result
Bottom	5162	10.6	23.1	12.5	Complied
Middle	5203	10.9	23.1	12.2	Complied
Top	5245	10.6	23.1	12.5	Complied

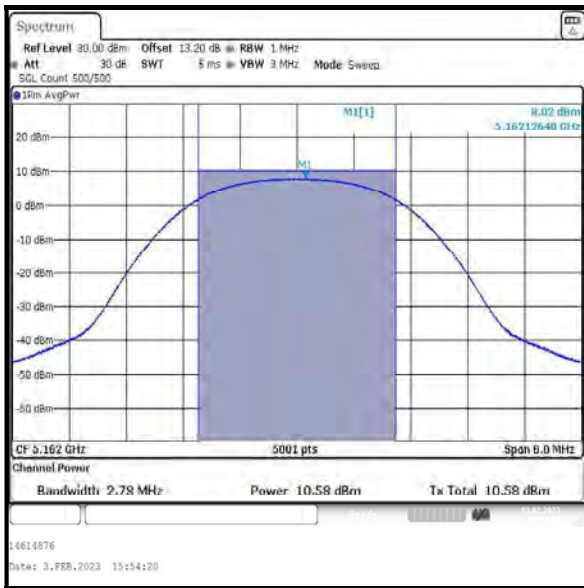

**Bottom Channel**

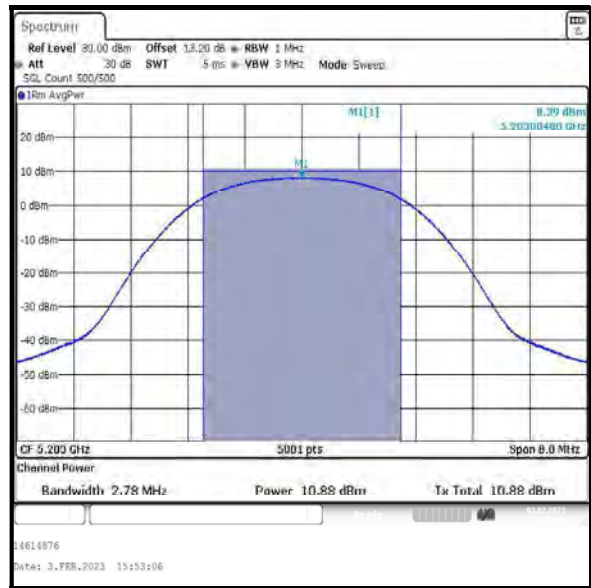

**Middle Channel**

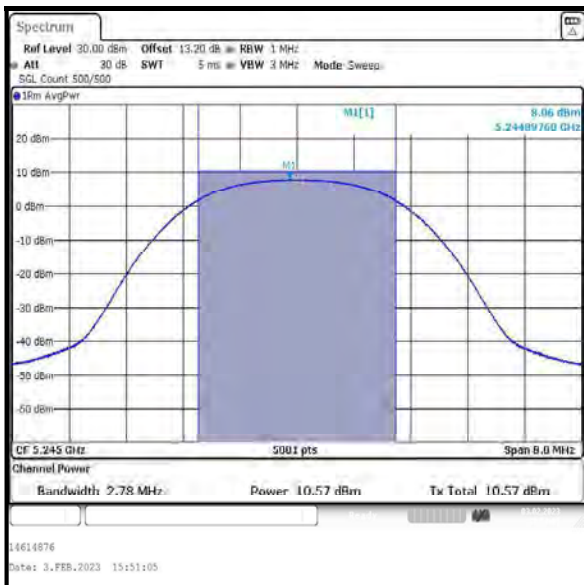

**Top Channel**