

# TEST REPORT

**Test Report No. :** UL-RPT-RP14614876JD02E

**Customer** : Apple Inc.  
**Model No. / HVIN** : A2787  
**PMN** : Mac Pro  
**FCC ID** : BCGA2787  
**ISED Certification No.** : IC: 579C-A2787  
**Technology** : *Bluetooth* – Low Energy  
**Test Standard(s)** : FCC Parts 15.209(a) & 15.247  
Innovation, Science and Economic Development Canada  
RSS-247 Issue 2 February 2017  
RSS-Gen Issue 5 February 2021  
**Test Laboratory** : UL International (UK) Ltd, Basingstoke, Hampshire, RG24 8AH,  
United Kingdom

1. This test report shall not be reproduced except in full, without the written approval of UL International (UK) Ltd.
2. The results in this report apply only to the sample(s) tested.
3. The sample tested is in compliance with the above standard(s).
4. The test results in this report are traceable to the national or international standards.
5. Version 1.0.

**Date of Issue:** 22 March 2023

**Checked by:**



Sarah Williams  
RF Operations Leader, Radio Laboratory

**Sarah Williams** Digitally signed  
by Sarah Williams  
Date: 2023.03.22  
16:31:19 Z

**Company Signatory:**



Ben Mercer  
Lead Project Engineer, Radio Laboratory

**Ben Mercer** Digitally signed  
by Ben Mercer  
Date: 2023.03.22  
16:31:37 Z



The *Bluetooth*® word mark and logos are owned by the *Bluetooth* SIG, Inc. and any use of such marks by UL International (UK) Ltd is under licence. Other trademarks and trade names are those of their respective owners.

**UL International (UK) LTD**

Unit 1-3 Horizon, Kingsland Business Park, Wade Road, Basingstoke, Hampshire, RG24 8AH, UK  
Telephone: +44 (0)1256 312000

**Customer Information**

<b>Company Name:</b>	Apple Inc.
<b>Address:</b>	One Apple Park Way Cupertino, California 95014 U.S.A.
<b>Contact Name:</b>	Stuart Thomas

**Report Revision History**

<b>Version Number</b>	<b>Issue Date</b>	<b>Revision Details</b>	<b>Revised By</b>
1.0	22/03/2023	Initial Version	Sarah Williams

---

## **Table of Contents**

<b>Customer Information.....</b>	<b>2</b>
<b>Report Revision History .....</b>	<b>2</b>
<b>Table of Contents.....</b>	<b>3</b>
<b>1 Attestation of Test Results.....</b>	<b>4</b>
1.1 Description of EUT	4
1.2 General Information	4
1.3 Summary of Test Results	4
1.4 Deviations from the Test Specification	4
<b>2 Summary of Testing.....</b>	<b>5</b>
2.1 Facilities and Accreditation	5
2.2 Methods and Procedures	5
2.3 Calibration and Uncertainty	6
2.4 Test and Measurement Equipment	7
<b>3 Equipment Under Test (EUT) .....</b>	<b>9</b>
3.1 Identification of Equipment Under Test (EUT)	9
3.2 Modifications Incorporated in the EUT	9
3.3 Additional Information Related to Testing	10
3.4 Description of Available Antennas	10
3.5 Description of Test Setup	11
<b>4 Antenna Port Test Results .....</b>	<b>18</b>
4.1 Transmitter 99% Occupied Bandwidth	18
4.2 Transmitter Minimum 6 dB Bandwidth	27
4.3 Transmitter Maximum Peak Output Power	36
4.4 Transmitter Power Spectral Density	51
<b>5 Radiated Test Results.....</b>	<b>54</b>
5.1 Transmitter Radiated Emissions <1 GHz	54
5.2 Transmitter Radiated Emissions >1 GHz	56
5.3 Transmitter Band Edge Radiated Emissions	60

## **1 Attestation of Test Results**

### **1.1 Description of EUT**

The equipment under test was a rack mounted Apple computer, with Bluetooth® and IEEE 802.11 a/b/g/n/ac/ax Wi-Fi capabilities in the 2.4 GHz, 5 GHz and 6 GHz bands.

### **1.2 General Information**

<b>Specification Reference:</b>	47CFR15.247
<b>Specification Title:</b>	Code of Federal Regulations Volume 47 (Telecommunications): Part 15 Subpart C (Intentional Radiators) – Section 15.247
<b>Specification Reference:</b>	47CFR15.209
<b>Specification Title:</b>	Code of Federal Regulations Volume 47 (Telecommunications): Part 15 Subpart C (Intentional Radiators) – Sections 15.209
<b>Specification Reference:</b>	RSS-Gen Issue 5 February 2021
<b>Specification Title:</b>	General Requirements for Compliance of Radio Apparatus
<b>Specification Reference:</b>	RSS-247 Issue 2 February 2017
<b>Specification Title:</b>	Digital Transmission Systems (DTSs), Frequency Hopping Systems (FHSs) and Licence-Exempt Local Area Network (LE-LAN) Devices
<b>Site Registration:</b>	FCC: 685609, ISEDC: 20903
<b>FCC Lab. Designation No.:</b>	UK2011
<b>ISEDC CABID:</b>	UK0001
<b>Location of Testing:</b>	Unit 3 Horizon, Wade Road, Kingsland Business Park, Basingstoke, Hampshire, G24 8AH, United Kingdom
<b>Test Dates:</b>	15 November 2022 to 08 March 2023

### **1.3 Summary of Test Results**

<b>FCC Reference (47CFR)</b>	<b>ISED Canada Reference</b>	<b>Measurement</b>	<b>Result</b>
N/A	RSS-Gen 6.7	Transmitter 99% Occupied Bandwidth	Complied
Part 15.247(a)(2)	RSS-Gen 6.7 / RSS-247 5.2(a)	Transmitter Minimum 6 dB Bandwidth	Complied
Part 15.247(b)(3)	RSS-Gen 6.12 / RSS-247 5.4(d)	Transmitter Maximum Peak Output Power	Complied
Part 15.247(e)	RSS-247 5.2(b)	Transmitter Power Spectral Density	Complied
Part 15.247(d) & 15.209(a)	RSS-Gen 6.13 / RSS-247 5.5	Transmitter Radiated Emissions	Complied
Part 15.247(d) & 15.209(a)	RSS-Gen 6.13 / RSS-247 5.5	Transmitter Band Edge Radiated Emissions	Complied

### **1.4 Deviations from the Test Specification**

For the measurements contained within this test report, there were no deviations from, additions to, or exclusions from the test specification identified above.

## **2 Summary of Testing**

### **2.1 Facilities and Accreditation**

The test site and measurement facilities used to collect data are located at Unit 3 Horizon, Wade Road, Kingsland Business Park, Basingstoke, Hampshire, RG24 8AH, United Kingdom. The following table identifies which facilities were utilised for radiated emission measurements documented in this report. Specific facilities are also identified in the test results sections.

Site 1	X
Site 2	-
Site 17	X

UL International (UK) Ltd is accredited by the United Kingdom Accreditation Service (UKAS). UKAS is one of the signatories to the International Laboratory Accreditation Co-operation (ILAC) Arrangement for the mutual recognition of test reports. The tests reported herein have been performed in accordance with its terms of accreditation.

### **2.2 Methods and Procedures**

<b>Reference:</b>	ANSI C63.10-2013
<b>Title:</b>	American National Standard of Procedures for Compliance Testing of Unlicensed Wireless Devices
<b>Reference:</b>	KDB 558074 D01 15.247 Meas Guidance v05r02, April 2, 2019
<b>Title:</b>	Guidance for Compliance Measurements on Digital Transmission System, Frequency Hopping Spread Spectrum System, and Hybrid System Devices Operating Under Section 15.247 of the FCC Rules
<b>Reference:</b>	KDB 662911 D01 Multiple Transmitter Output v02r01 October 31, 2013
<b>Title:</b>	Emissions Testing of Transmitters with Multiple Outputs in the Same Band

## **2.3 Calibration and Uncertainty**

### **Measuring Instrument Calibration**

In accordance with UKAS requirements all the measurement equipment is on a calibration schedule. All equipment was within the calibration period on the date of testing.

### **Measurement Uncertainty & Decision Rule**

#### **Overview**

No measurement or test can ever be perfect and the imperfections give rise to error of measurement in the results. Consequently the result of a measurement is only an approximation to the value of the measurand (the specific quantity subject to measurement) and is only complete when accompanied by a statement of the uncertainty of the approximation.

The expression of uncertainty of a measurement result allows realistic comparison of results with reference values and limits given in specifications and standards.

#### **Decision Rule**

The decision rule applied is based upon the accuracy method criteria. The measurement uncertainty is met and the result is considered in conformance with the requirement criteria if the observed value is within the prescribed limit.

#### **Measurement Uncertainty**

The reported expanded uncertainties below are based on a standard uncertainty multiplied by an appropriate coverage factor such that a confidence level of approximately 95% is maintained. For the purposes of this document "approximately" is interpreted as meaning "effectively" or "for most practical purposes".

<b>Measurement Type</b>	<b>Range</b>	<b>Confidence Level (%)</b>	<b>Calculated Uncertainty</b>
99% Occupied Bandwidth	2.4 GHz to 2.4835 GHz	95%	±3.92 %
Minimum 6 dB Bandwidth	2.4 GHz to 2.4835 GHz	95%	±4.59 %
Spectral Power Density	2.4 GHz to 2.4835 GHz	95%	±1.13 dB
Conducted Maximum Peak Output Power	2.4 GHz to 2.4835 GHz	95%	±1.13 dB
Radiated Spurious Emissions	9 kHz to 30 MHz	95%	±5.32 dB
Radiated Spurious Emissions	30 MHz to 1 GHz	95%	±3.30 dB
Radiated Spurious Emissions	1 GHz to 25 GHz	95%	±3.16 dB

The methods used to calculate the above uncertainties are in line with those recommended within the various measurement specifications. Where measurement specifications do not include guidelines for the evaluation of measurement uncertainty the published guidance of the appropriate accreditation body is followed.

## **2.4 Test and Measurement Equipment**

### **Test Equipment Used for Transmitter Conducted Tests**

<b>Asset No.</b>	<b>Instrument</b>	<b>Manufacturer</b>	<b>Type No.</b>	<b>Serial No.</b>	<b>Date Calibration Due</b>	<b>Cal. Interval (Months)</b>
M2001	Thermohygrometer	Testo	608-H1	45041824	09 Dec 2023	12
A2507	Attenuator	AtlanTecRF	AN18-10	821846#2	Calibrated before use	-
M1996	Signal Analyser	Rohde & Schwarz	FSV13	100975	17 Mar 2023	12
A214336	Attenuator	Atlantic Microwave	ATT06KXP-483082-S4S5	#1	Calibrated before use	-
A214341	Attenuator	Atlantic Microwave	ATT06KXP-483082-S4S5	#6	Calibrated before use	-
A214343	Attenuator	Atlantic Microwave	ATT06KXP-483082-S4S5	#8	Calibrated before use	-
A222203	Switch Box	UL	UK version #10010	#2	Calibrated before use	-
G0614	Signal Generator	Rohde & Schwarz	SMB100A	177687	19 May 2023	36

**Test and Measurement Equipment (continued)****Test Equipment Used for Transmitter Radiated Emissions Tests**

Asset No.	Instrument	Manufacturer	Type No.	Serial No.	Date Calibration Due	Cal. Interval (Months)
M2040	Thermohygrometer	Testo	608-H1	45124934	09 Dec 2023	12
K0001	3m RSE Chamber	Rainford EMC	N/A	N/A	05 Sep 2023	12
M1874	Test Receiver	Rohde & Schwarz	ESU26	100553	19 May 2023	12
A222867	Pre-Amplifier	Atlantic Microwave	A-LNAKX-380116-S5S5	210865001	26 Aug 2023	12
A3265	Pre-Amplifier	Schwarzbeck	BBV 9721	9721-069	31 Oct 2023	12
A3165	Magnetic Loop Antenna	ETS-Lindgren	6502	00224383	05 May 2023	12
A3139	Antenna	Schwarzbeck	HWRD 750	00027	22 Aug 2023	12
A2892	Antenna	Schwarzbeck	BBHA 9170	9170-727	31 Oct 2023	12
A3095	High Pass Filter	AtlanTecRF	AFH-07000	18051600012	27 Jan 2023	12
M2003	Thermohygrometer	Testo	608-H1	45046641	09 Dec 2023	12
K0017	3m RSE Chamber	Rainford EMC	N/A	N/A	08 Nov 2023	12
M1995	Test Receiver	Rohde & Schwarz	ESU40	100428	02 Nov 2023	12
A3167	Pre-Amplifier	Com-Power	PAM-103	18020010	02 Nov 2023	12
A2863	Pre-Amplifier	Agilent	8449B	3008A02100	07 Nov 2023	12
A223628	Pre-Amplifier	Atlantic Microwave	A-LNAKX-380116-S5S5	210837001	03 Nov 2023	12
A490	Antenna	Chase	CBL6111A	1590	06 Oct 2023	12
A2889	Antenna	Schwarzbeck	BBHA 9120 B	00653	02 Nov 2023	12
A2890	Antenna	Schwarzbeck	HWRD 750	014	02 Nov 2023	12
A2148	Attenuator	AtlanTecRF	AN18-06	090202-06	06 Oct 2023	12
A2916	Attenuator	AtlanTecRF	AN18W5-10	832827#2	26 Jan 2023	12
A2914	High Pass Filter	AtlanTecRF	AFH-03000	2155	25 Jan 2023	12
A2947	High Pass Filter	AtlanTecRF	AFH-07000	1601900001	25 Jan 2023	12

**Test Equipment Used for Transmitter Band Edge Radiated Emissions Tests**

Asset No.	Instrument	Manufacturer	Type No.	Serial No.	Date Calibration Due	Cal. Interval (Months)
M2003	Thermohygrometer	Testo	608-H1	45046641	09 Dec 2023	12
K0017	3m RSE Chamber	Rainford EMC	N/A	N/A	08 Nov 2023	12
M1995	Test Receiver	Rohde & Schwarz	ESU40	100428	02 Nov 2023	12
A2863	Pre-Amplifier	Agilent	8449B	3008A02100	07 Nov 2023	12
A2889	Antenna	Schwarzbeck	BBHA 9120 B	00653	02 Nov 2023	12
A2916	Attenuator	AtlanTecRF	AN18W5-10	832827#2	26 Jan 2023	12



### **3 Equipment Under Test (EUT)**

#### **3.1 Identification of Equipment Under Test (EUT)**

<b>Brand Name:</b>	Apple
<b>Model Name or Number / HVIN:</b>	A2787
<b>PMN:</b>	Mac Pro
<b>Test Sample Serial Number:</b>	GW7L977HC0 ( <i>Conducted sample #1</i> )
<b>Hardware Version:</b>	REV 1.0
<b>Software Version:</b>	22E51010k
<b>FCC ID:</b>	BCGA2787
<b>ISED Canada Certification Number:</b>	IC: 579C-A2787
<b>Date of Receipt:</b>	11 January 2023

<b>Brand Name:</b>	Apple
<b>Model Name or Number / HVIN:</b>	A2787
<b>PMN:</b>	Mac Pro
<b>Test Sample Serial Number:</b>	FQP20QF2CT ( <i>Radiated sample #1</i> )
<b>Hardware Version:</b>	REV 1.0
<b>Software Version:</b>	22E51010k
<b>FCC ID:</b>	BCGA2787
<b>ISED Canada Certification Number:</b>	IC: 579C-A2787
<b>Date of Receipt:</b>	14 November 2022

<b>Brand Name:</b>	Apple
<b>Model Name or Number / HVIN:</b>	A2787
<b>PMN:</b>	Mac Pro
<b>Test Sample Serial Number:</b>	C2QY43Q3QM ( <i>Radiated sample #2</i> )
<b>Hardware Version:</b>	REV 1.0
<b>Software Version:</b>	22E71580u
<b>FCC ID:</b>	BCGA2787
<b>ISED Canada Certification Number:</b>	IC: 579C-A2787
<b>Date of Receipt:</b>	11 January 2023

#### **3.2 Modifications Incorporated in the EUT**

No modifications were applied to the EUT during testing.

### 3.3 Additional Information Related to Testing

<b>Technology Tested:</b>	<i>Bluetooth</i> Low Energy (Digital Transmission System)		
<b>Type of Unit:</b>	Transceiver		
<b>Channel Spacing:</b>	2 MHz		
<b>Modulation:</b>	GFSK		
<b>Data Rate: LE1M</b>	1 Mbps		
<b>Data Rate: LE2M</b>	2 Mbps		
<b>Power Supply Requirement(s):</b>	Nominal	12.0 VDC via 120 VAC 60 Hz adaptor	
<b>Maximum Conducted Output Power:</b>	8.6 dBm		
<b>Transmit Frequency Range:</b>	2400 MHz to 2483.5 MHz		
<b>Transmit Channels Tested:</b>	<b>Channel ID</b>	<b>Channel Number</b>	<b>Channel Frequency (MHz)</b>
	Bottom	37	2402
	Middle	17	2440
	Top	39	2480

### 3.4 Description of Available Antennas

The radio utilizes three integrated antennas, with the following maximum gains:

Antenna Port	Frequency Range (MHz)	Antenna Gain (dBi)
Core 0	2400 to 2480	5.0
Core 1	2400 to 2480	4.7
Dedicated Core	2400 to 2480	5.2

The EUT also supports TxBF with unequal gains and equal transmit powers. Calculations for directional gain were in accordance with KDB 662911 D01 v02r01 Section F)2)d)(i). Directional gain of Core 0 & Core 1 was calculated as:

$N_{ANT} = 2$ ,  $G_{Core0} = 5.0$  dBi,  $G_{Core1} = 4.7$  dBi

$$\begin{aligned} \text{Directional Gain} &= 10 \log \left[ \frac{\left( 10^{\frac{G_1}{20}} + 10^{\frac{G_2}{20}} + \dots + 10^{\frac{G_N}{20}} \right)^2}{N_{ANT}} \right] = 10 \log \left[ \frac{\left( 10^{\frac{G_1}{20}} + 10^{\frac{G_2}{20}} \right)^2}{2} \right] \\ &= 10 \log \left[ \frac{\left( 10^{\frac{5.0}{20}} + 10^{\frac{4.7}{20}} \right)^2}{2} \right] = 7.9 \text{ dBi} \end{aligned}$$

### **3.5 Description of Test Setup**

#### **Support Equipment**

The following support equipment was used to exercise the EUT during testing:

<b>Description:</b>	Test Laptop
<b>Brand Name:</b>	Apple
<b>Model Name or Number:</b>	MacBook Pro
<b>Serial Number:</b>	C02C8009P22C

<b>Description:</b>	USB Diagnostic Cable
<b>Brand Name:</b>	Apple
<b>Model Name or Number:</b>	Chimp
<b>Serial Number:</b>	304708

<b>Description:</b>	Test Laptop
<b>Brand Name:</b>	Apple
<b>Model Name or Number:</b>	MacBook Pro
<b>Serial Number:</b>	FVFDH03JQ05G

<b>Description:</b>	USB Diagnostic Cable
<b>Brand Name:</b>	Apple
<b>Model Name or Number:</b>	Chimp
<b>Serial Number:</b>	428CBE

<b>Description:</b>	Test Laptop
<b>Brand Name:</b>	Apple
<b>Model Name or Number:</b>	MacBook Pro
<b>Serial Number:</b>	C02DJ05D0HDF

<b>Description:</b>	USB Diagnostic Cable
<b>Brand Name:</b>	Apple
<b>Model Name or Number:</b>	Chimp
<b>Serial Number:</b>	427A65

<b>Description:</b>	Termination – Laptop 1
<b>Brand Name:</b>	Dell
<b>Model Name or Number:</b>	Latitude 54300
<b>Serial Number:</b>	2089G4J

**Support Equipment (continued)**

<b>Description:</b>	Termination – Laptop 1
<b>Brand Name:</b>	Lenovo
<b>Model Name or Number:</b>	ThinkPad L440
<b>Serial Number:</b>	R9-019EA2 14/04

<b>Description:</b>	USB Hub
<b>Brand Name:</b>	Hama
<b>Model Name or Number:</b>	USB 2.0
<b>Serial Number:</b>	00078498

<b>Description:</b>	USB-C Cables. Quantity 2. Length 3m.
<b>Brand Name:</b>	Nimaso
<b>Model Name or Number:</b>	Not marked or stated
<b>Serial Number:</b>	Not marked or stated

<b>Description:</b>	USB-A Cables. Quantity 8. Length 3m.
<b>Brand Name:</b>	Not marked or stated
<b>Model Name or Number:</b>	Not marked or stated
<b>Serial Number:</b>	Not marked or stated

<b>Description:</b>	Personal Hands Free (PHF)
<b>Brand Name:</b>	Not marked or stated
<b>Model Name or Number:</b>	Not marked or stated
<b>Serial Number:</b>	Not marked or stated

<b>Description:</b>	Ethernet Cable. Quantity 2. Length 3m.
<b>Brand Name:</b>	Not marked or stated
<b>Model Name or Number:</b>	Not marked or stated
<b>Serial Number:</b>	Not marked or stated

<b>Description:</b>	USB A to C Adaptor. Quantity 8.
<b>Brand Name:</b>	Not marked or stated
<b>Model Name or Number:</b>	Not marked or stated
<b>Serial Number:</b>	Not marked or stated

**Support Equipment (continued)**

<b>Description:</b>	HDMI Cables. Quantity 2. Length 3m.
<b>Brand Name:</b>	KabelDirekt
<b>Model Name or Number:</b>	Not marked or stated
<b>Serial Number:</b>	Not marked or stated

## **Operating Modes**

The EUT was tested in the following operating mode(s):

- Transmitting at maximum power in *Bluetooth* LE1M mode with modulation, maximum possible data length available and Pseudorandom Bit Sequence 9.
- Transmitting at maximum power in *Bluetooth* LE2M mode with modulation, maximum possible data length available and Pseudorandom Bit Sequence 9.

## **Configuration and Peripherals**

The EUT was tested in the following configuration(s):

- Controlled in test mode using a set of commands entered into a terminal application on the EUT supplied by the customer. The commands were used to enable a continuous transmission and to select the test channels as required. The customer supplied a document containing the setup instructions.
- The EUT has a dedicated core (core 2), which operates in SISO mode only, in addition to two cores which operate in both SISO and TxBF modes. Core 0 & Core 1 are identical but have unequal gains therefore conducted tests have been performed on the Core with the highest antenna gain. Modes tested were:
  - LE1M / SISO / Core 0
  - LE2M / SISO / Core 0
  - LE1M / SISO / Core 2
  - LE2M / SISO / Core 2
  - LE1M / Beamforming / Core 0 + Core 1
  - LE2M / Beamforming / Core 0 + Core 1
- The customer supplied U.FL RF cables with the EUT in order to perform conducted measurements. This measured additional path loss was included in any path loss calculations.
- The EUT was powered from a 120 VAC 60 Hz single phase mains supply.
- Transmitter radiated spurious emissions tests were performed with the EUT transmitting in LE1M Beamforming Core 0 + Core 1 mode, as this mode was found to transmit the highest power.
- Radiated spurious emissions were performed with the EUT in the position that produced worst case with respect to emissions. All ports were terminated into suitable terminations and placed under the turntable.
- Transmitter radiated band edge measurements were performed with the EUT in the Y orientation / position as declared by the customer.

**Test Setup Diagrams**

**Conducted Tests:**

**Test Setup for Transmitter Conducted Tests**

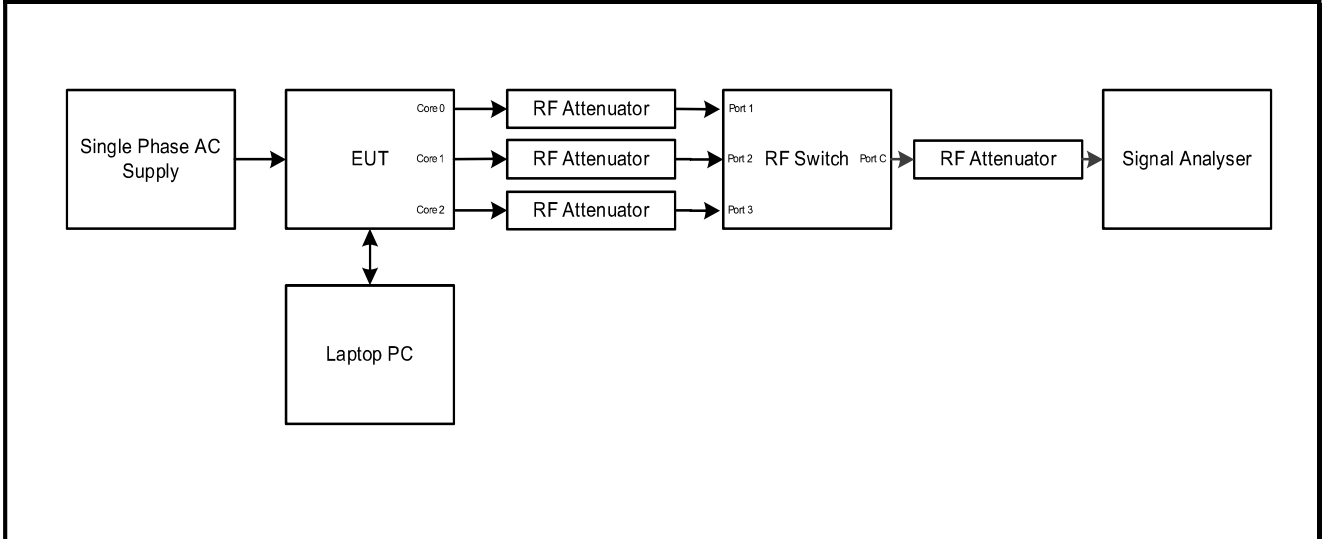

**Radiated Tests:**

**Test Setup for Transmitter Radiated Emissions**

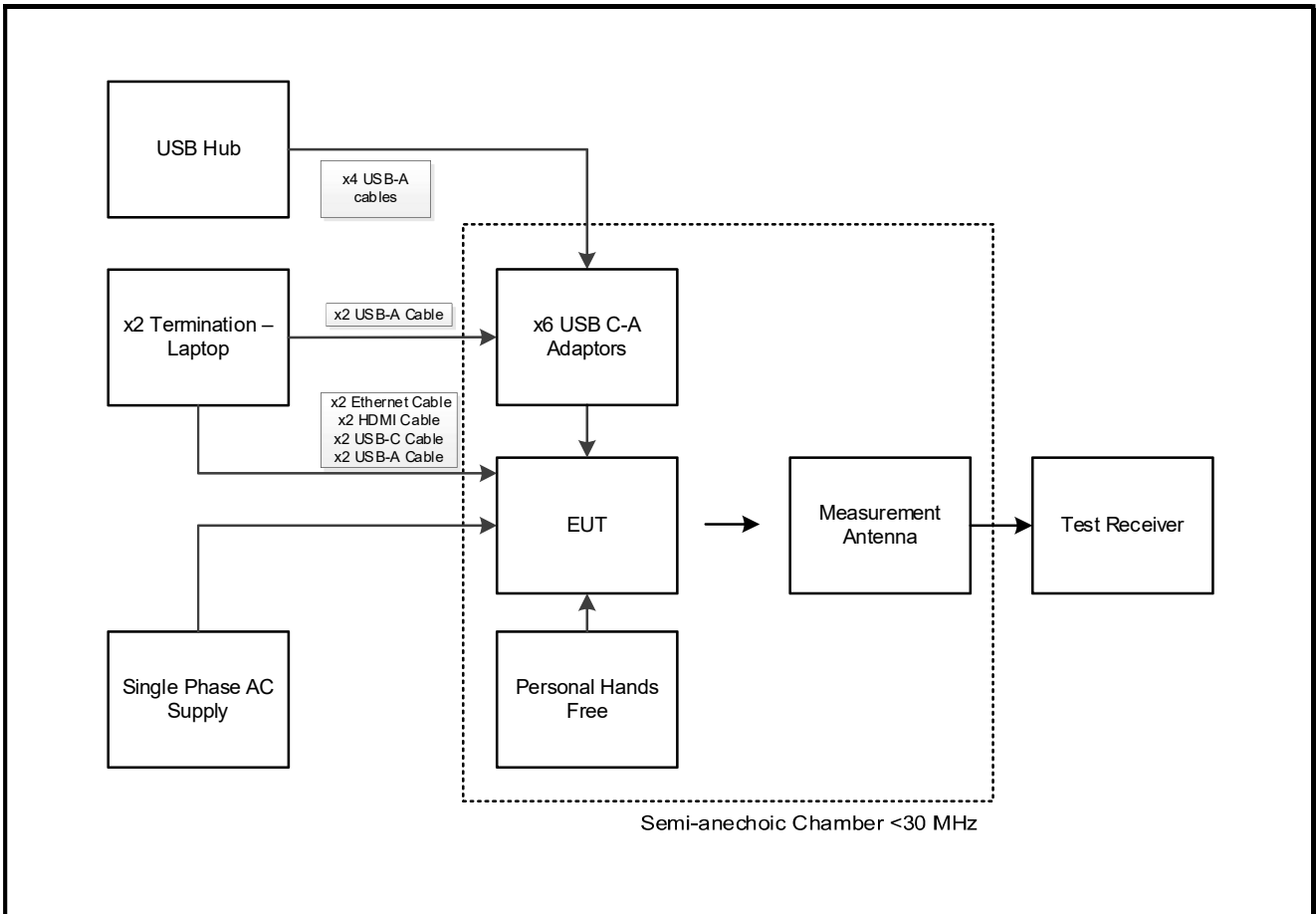

**Test Setup Diagrams (continued)**

**Test Setup for Transmitter Radiated Emissions (continued)**

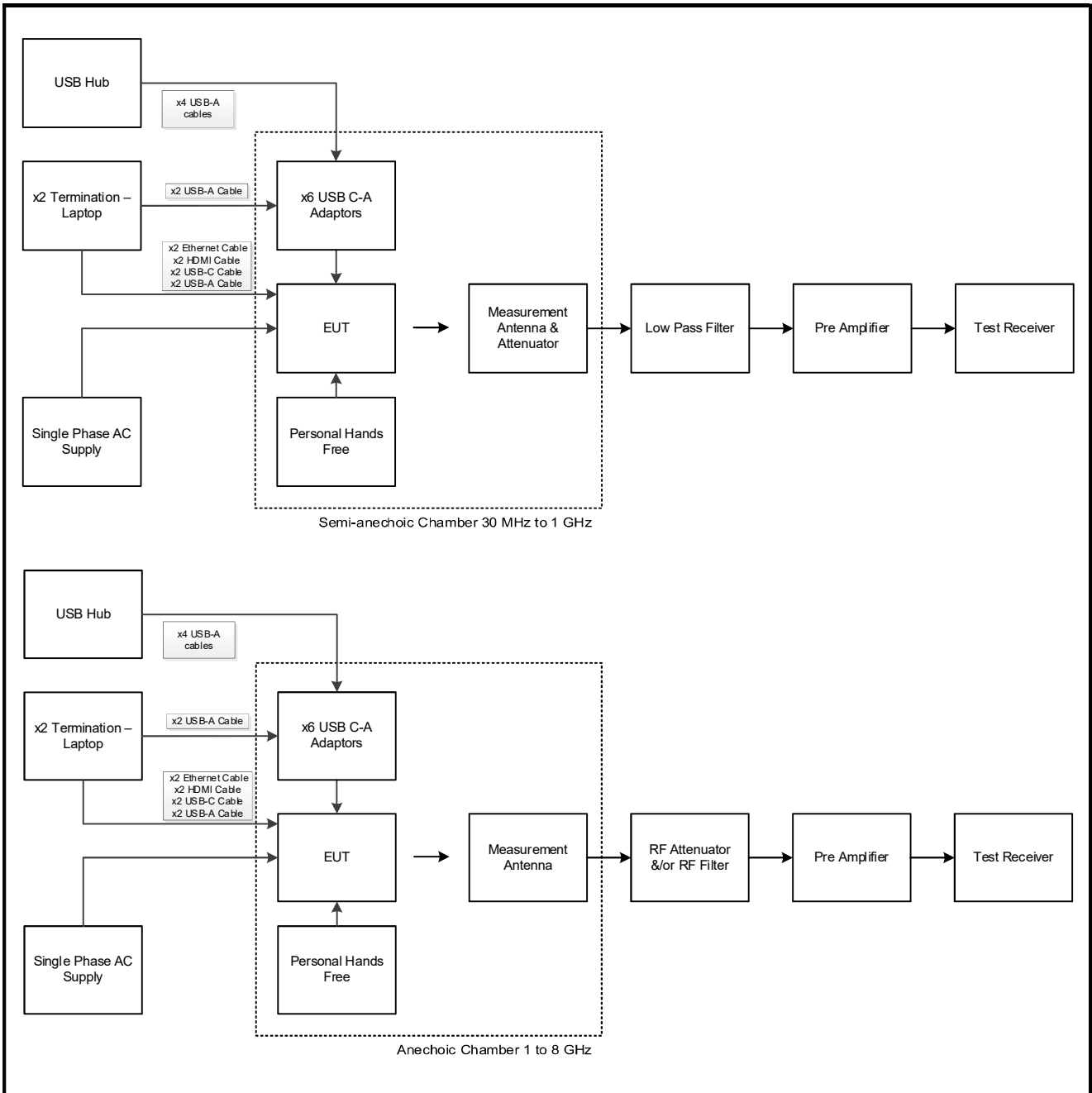



**Test Setup Diagrams (continued)**

**Test Setup for Transmitter Radiated Emissions (continued)**

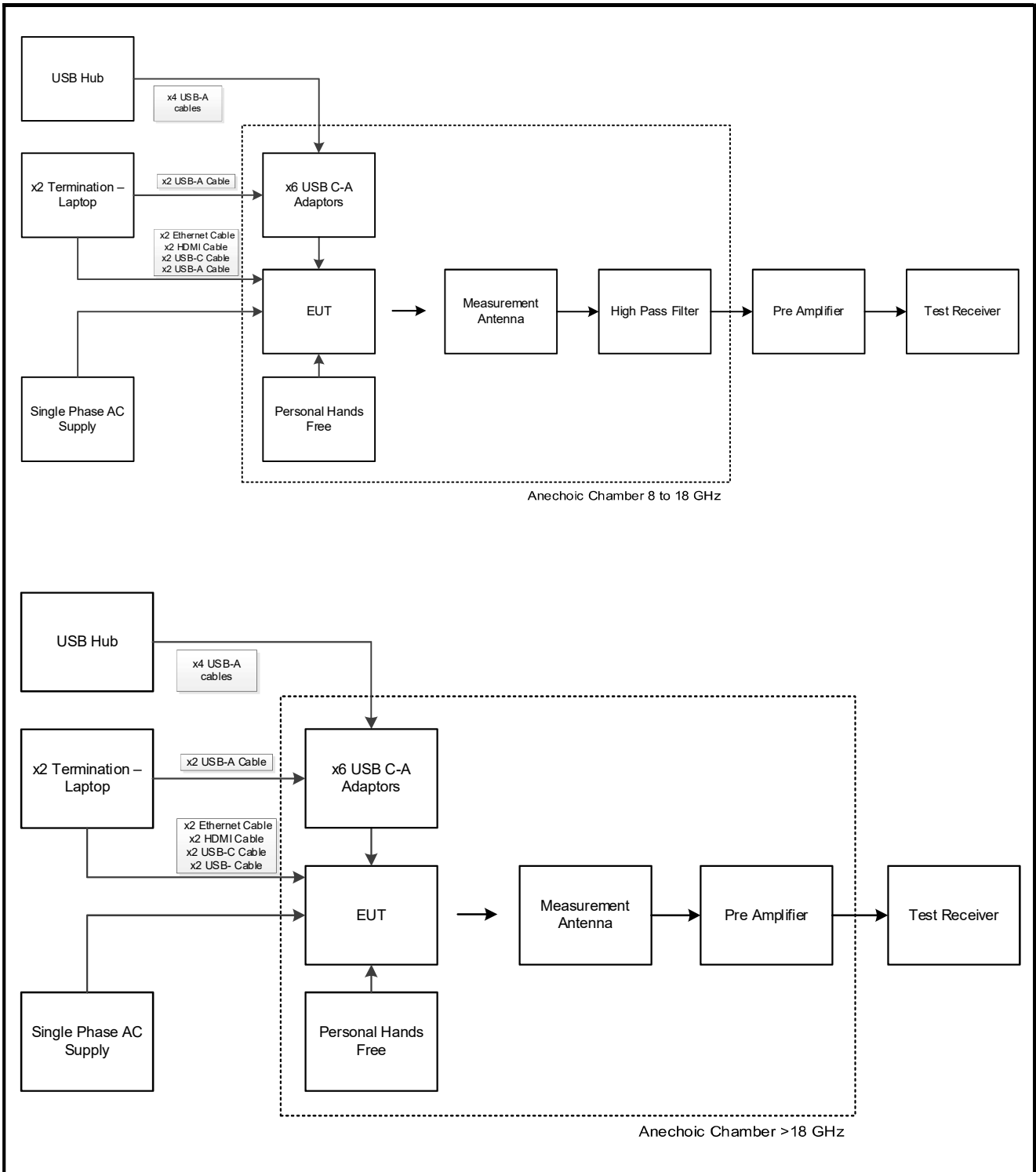

## **4 Antenna Port Test Results**

### **4.1 Transmitter 99% Occupied Bandwidth**

#### **Test Summary:**

<b>Test Engineer:</b>	Raghavendra Katti	<b>Test Date:</b>	25 January 2023
<b>Test Sample Serial Number:</b>	GW7L977HC0		

<b>FCC Reference:</b>	N/A
<b>ISED Canada Reference:</b>	RSS-Gen 6.7
<b>Test Method Used:</b>	RSS-Gen 6.7 and Notes below

#### **Environmental Conditions:**

<b>Temperature (°C):</b>	22
<b>Relative Humidity (%):</b>	32

#### **Note(s):**

1. The 99% emission bandwidth was measured using the signal analyser occupied bandwidth function. The resolution bandwidth was set in the range of 1% to 5% of the occupied bandwidth and the video bandwidth set to 3 times the resolution bandwidth. The span was set to capture all products of the modulation process including emission skirts.
2. The signal analyser resolution bandwidth was set to 30 kHz and video bandwidth 100 kHz. A peak detector was used, sweep time was set to auto and the trace mode was Max Hold. The span was set to 5 MHz. The signal analyser function set the measurements to be made at 99% of the emission bandwidth. The results are given in the tables below.
3. The signal analyser was connected to the RF port on the EUT using suitable attenuation and RF cable.

**Transmitter 99% Occupied Bandwidth (continued)**

**Results: LE1M / SISO / Core 0**

Channel	99% Occupied Bandwidth (kHz)
Bottom	1033.966
Middle	1043.956
Top	1048.951

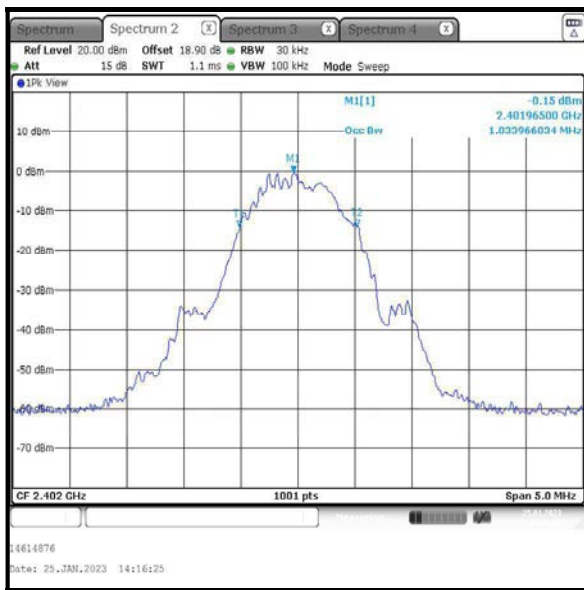

**Bottom Channel**

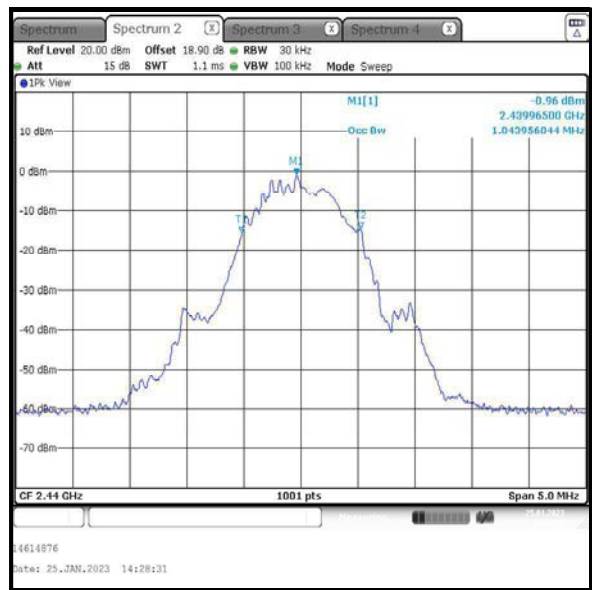

**Middle Channel**

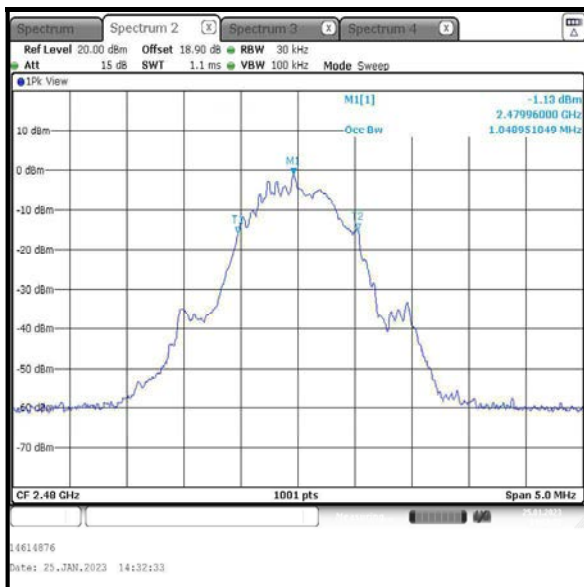

**Top Channel**

**Transmitter 99% Occupied Bandwidth (continued)**

**Results: LE2M / SISO / Core 0**

Channel	99% Occupied Bandwidth (kHz)
Bottom	2087.912
Middle	2082.917
Top	2082.917



Bottom Channel

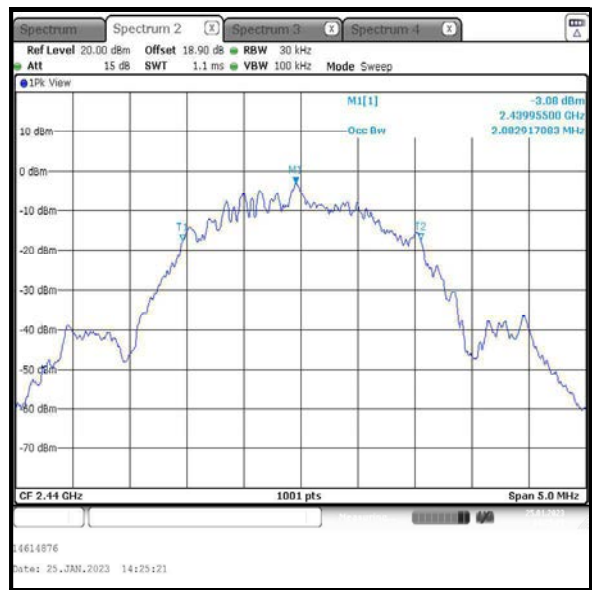

Middle Channel

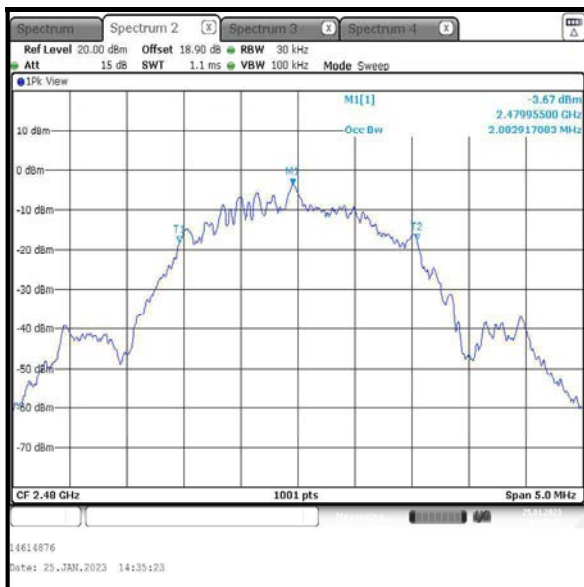

Top Channel

**Transmitter 99% Occupied Bandwidth (continued)**

**Results: LE1M / SISO / Core 2**

Channel	99% Occupied Bandwidth (kHz)
Bottom	1033.966
Middle	1038.961
Top	1038.961

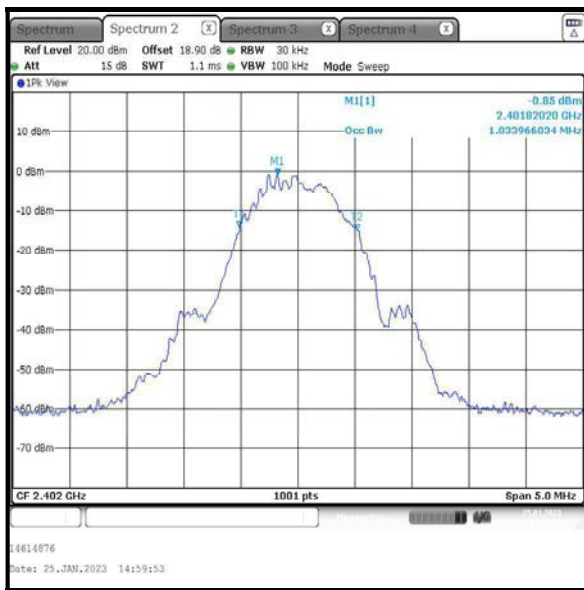

**Bottom Channel**

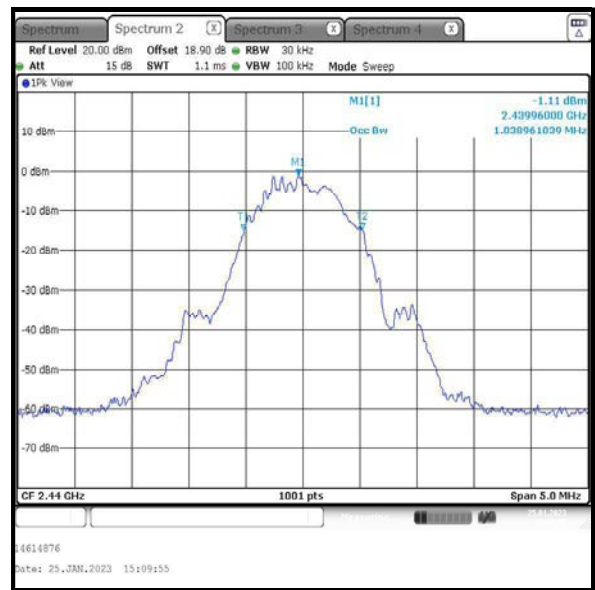

**Middle Channel**



**Top Channel**

**Transmitter 99% Occupied Bandwidth (continued)**

**Results: LE2M / SISO / Core 2**

Channel	99% Occupied Bandwidth (kHz)
Bottom	2082.917
Middle	2082.917
Top	2087.912



**Bottom Channel**

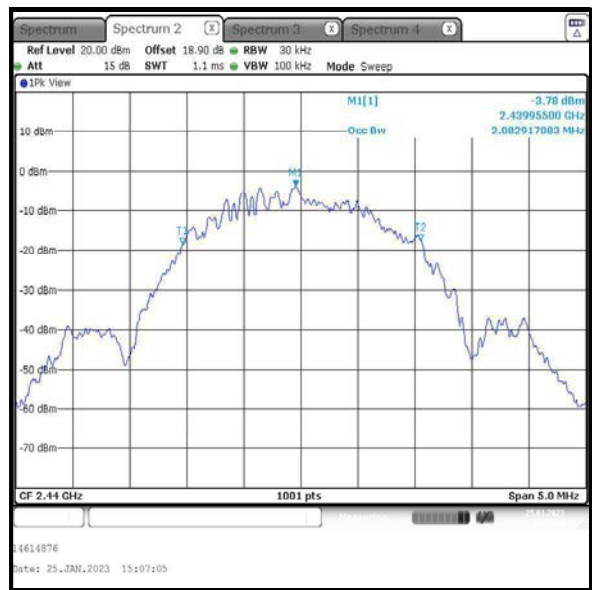

**Middle Channel**



**Top Channel**

**Transmitter 99% Occupied Bandwidth (continued)**

**Results: LE1M / Beamforming / Core 0**

Channel	99% Occupied Bandwidth (kHz)
Bottom	1033.966
Middle	1043.956
Top	1043.956

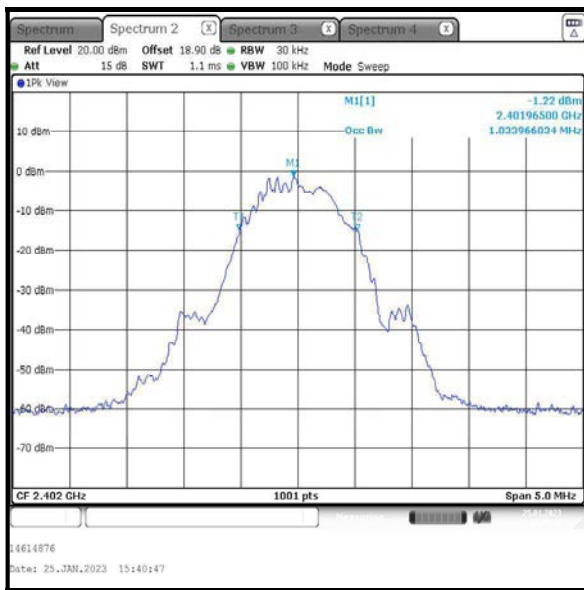

**Bottom Channel**

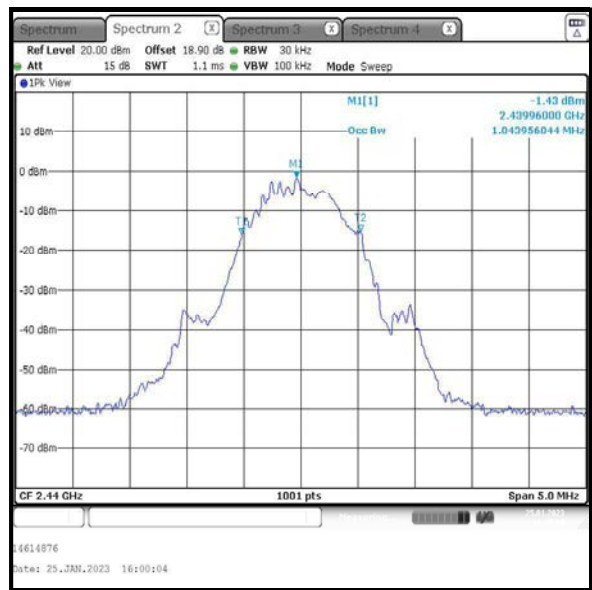

**Middle Channel**

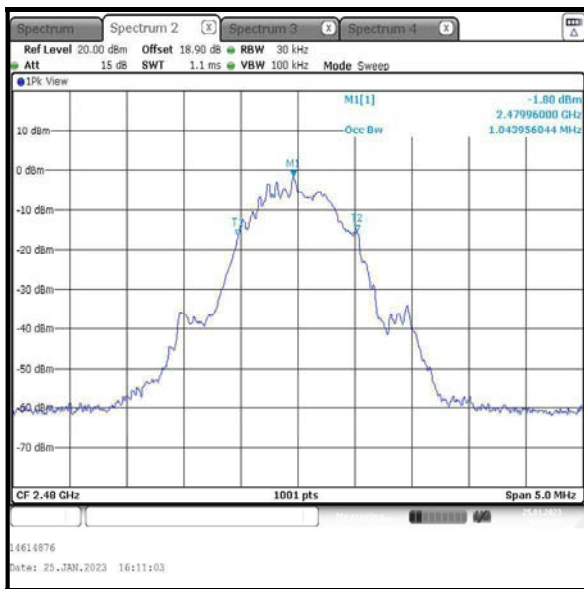

**Top Channel**

**Transmitter 99% Occupied Bandwidth (continued)**

**Results: LE1M / Beamforming / Core 1**

Channel	99% Occupied Bandwidth (kHz)
Bottom	1033.966
Middle	1038.961
Top	1043.956

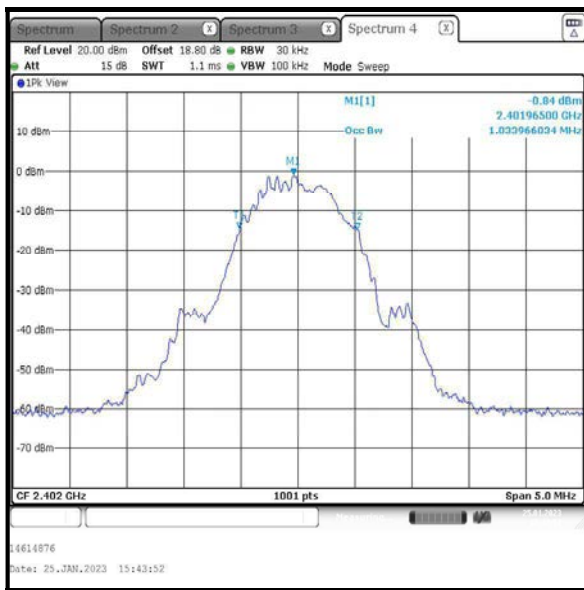

**Bottom Channel**

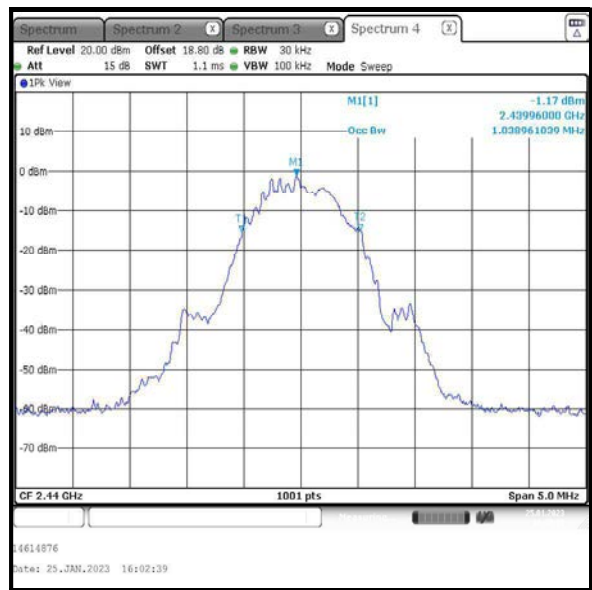

**Middle Channel**

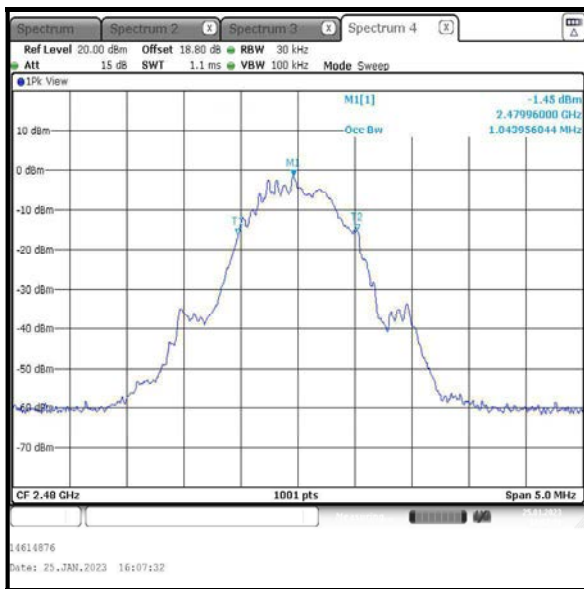

**Top Channel**



**Transmitter 99% Occupied Bandwidth (continued)**

**Results: LE2M / Beamforming / Core 0**

Channel	99% Occupied Bandwidth (kHz)
Bottom	2087.912
Middle	2087.912
Top	2087.912



Bottom Channel



Middle Channel

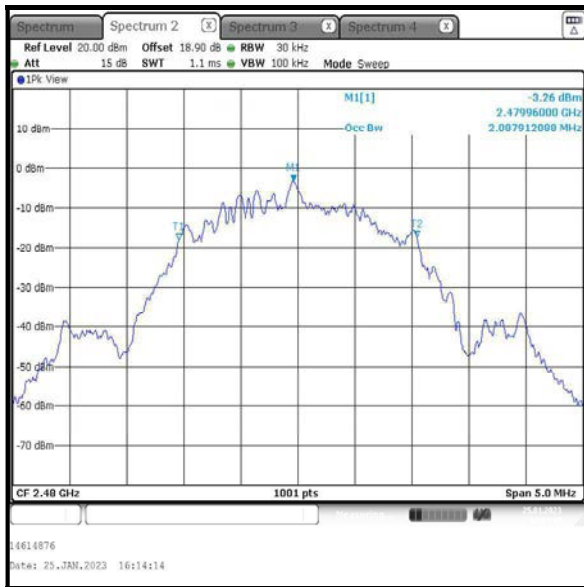

Top Channel

**Transmitter 99% Occupied Bandwidth (continued)**

**Results: LE2M / Beamforming / Core 1**

Channel	99% Occupied Bandwidth (kHz)
Bottom	2087.912
Middle	2082.917
Top	2082.917

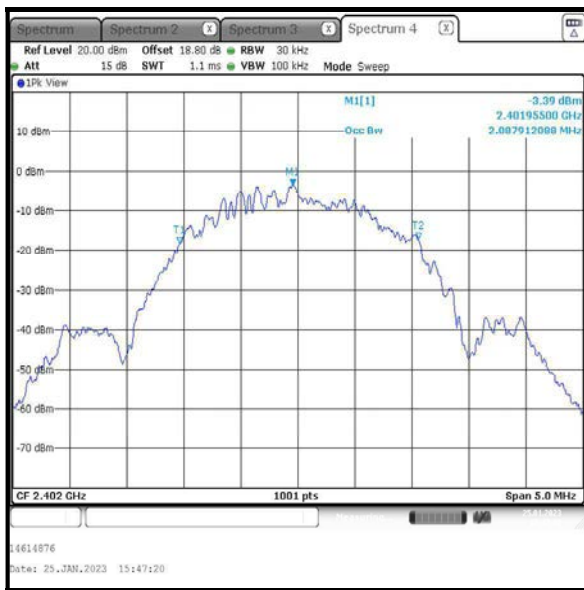

Bottom Channel

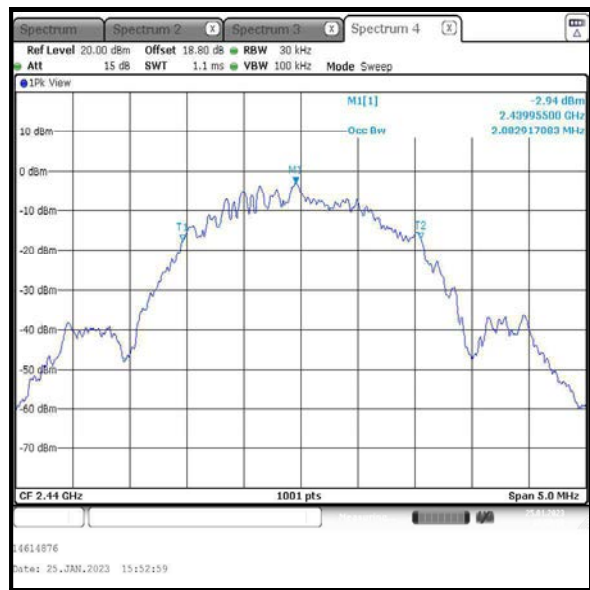

Middle Channel

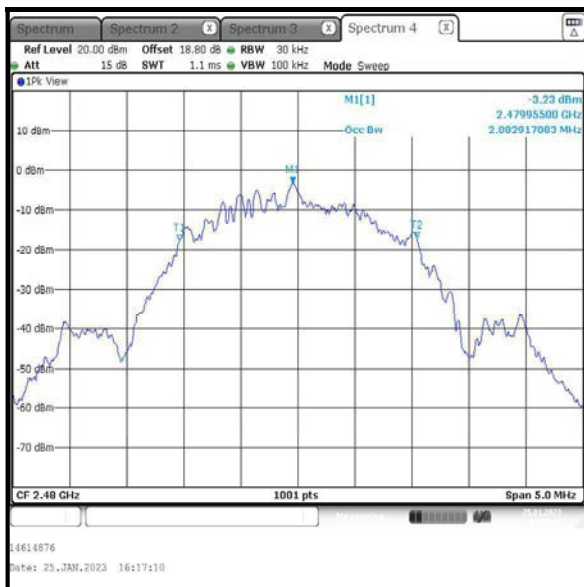

Top Channel

## **4.2 Transmitter Minimum 6 dB Bandwidth**

### **Test Summary:**

<b>Test Engineer:</b>	Raghavendra Katti	<b>Test Dates:</b>	07 March 2023 & 08 March 2023
<b>Test Sample Serial Number:</b>	GW7L977HC0		

<b>FCC Reference:</b>	Part 15.247(a)(2)
<b>ISED Canada Reference:</b>	RSS-Gen 6.7 / RSS-247 5.2(a)
<b>Test Method Used:</b>	FCC KDB 558074 Section 8.2 referencing ANSI C63.10 Section 11.8.1

### **Environmental Conditions:**

<b>Temperature (°C):</b>	20 to 22
<b>Relative Humidity (%):</b>	38 to 41

### **Note(s):**

1. 6 dB DTS bandwidth tests were performed using a signal analyser in accordance with ANSI C63.10 Section 11.8.1 Option 1 measurement procedure. The signal analyser resolution bandwidth was set to 100 kHz and video bandwidth 300 kHz. A peak detector was used, sweep time was set to auto and the trace mode was Max Hold. The DTS bandwidth was measured at 6 dB down from the peak of the signal.
2. The signal analyser was connected to the RF port on the EUT using suitable attenuation and RF cable.

**Transmitter Minimum 6 dB Bandwidth (continued)**

**Results: LE1M / SISO / Core 0**

Channel	6 dB Bandwidth (kHz)	Limit (kHz)	Margin (kHz)	Result
Bottom	704.300	≥500	204.300	Complied
Middle	679.300	≥500	179.300	Complied
Top	664.300	≥500	164.300	Complied



Bottom Channel

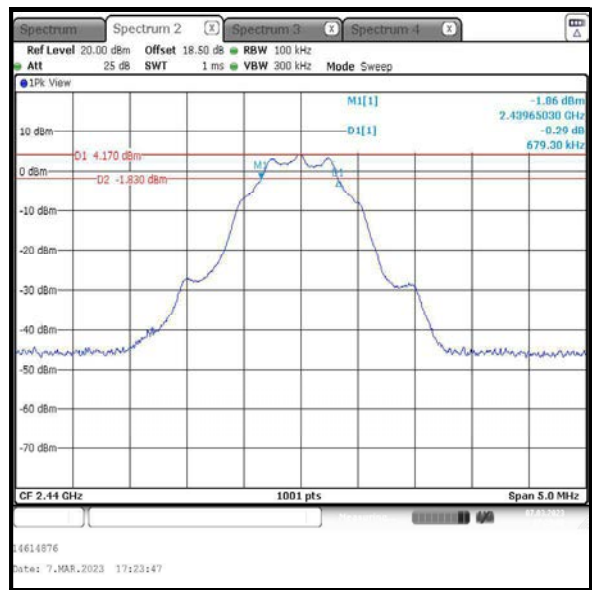

Middle Channel

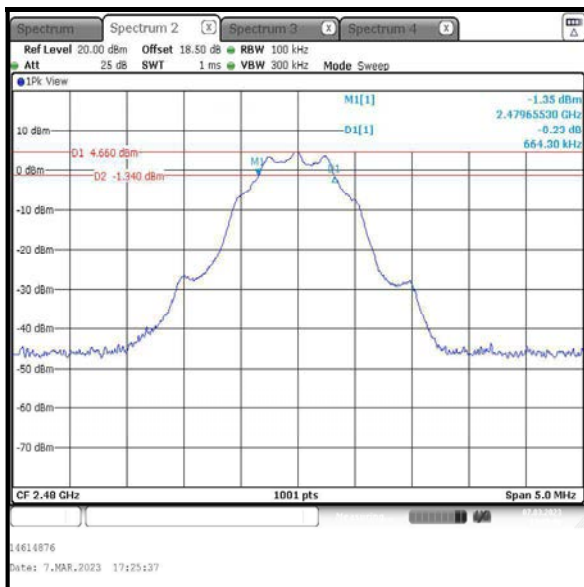

Top Channel

**Transmitter Minimum 6 dB Bandwidth (continued)**

**Results: LE2M / SISO / Core 0**

Channel	6 dB Bandwidth (kHz)	Limit (kHz)	Margin (kHz)	Result
Bottom	1288.700	≥500	788.700	Complied
Middle	1158.800	≥500	658.800	Complied
Top	1128.900	≥500	628.900	Complied



Bottom Channel



Middle Channel

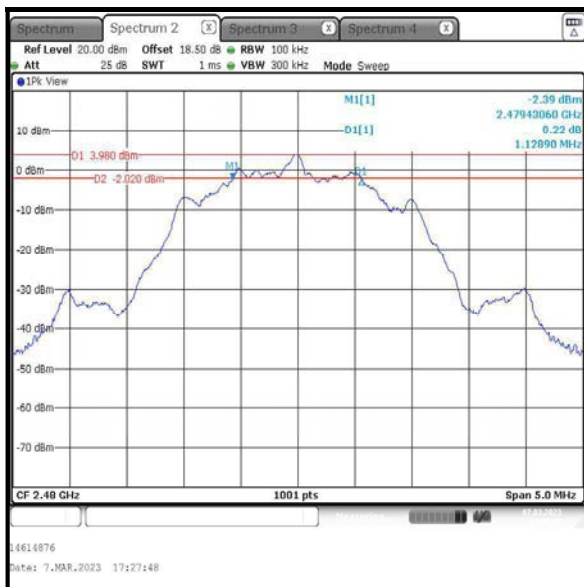

Top Channel

**Transmitter Minimum 6 dB Bandwidth (continued)**

**Results: LE1M / SISO / Core 2**

Channel	6 dB Bandwidth (kHz)	Limit (kHz)	Margin (kHz)	Result
Bottom	724.300	≥500	224.300	Complied
Middle	714.300	≥500	214.300	Complied
Top	714.300	≥500	214.300	Complied



Bottom Channel

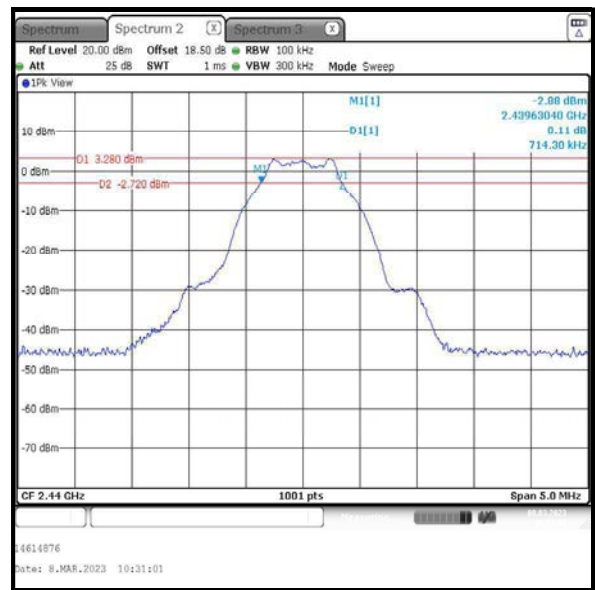

Middle Channel

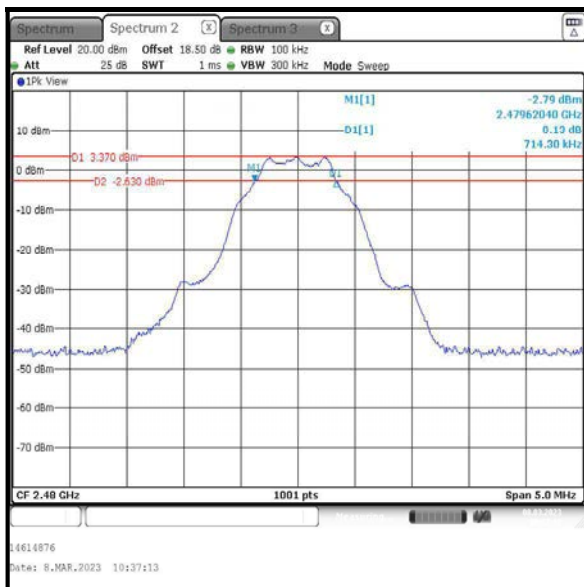

Top Channel

**Transmitter Minimum 6 dB Bandwidth (continued)**

**Results: LE2M / SISO / Core 2**

Channel	6 dB Bandwidth (kHz)	Limit (kHz)	Margin (kHz)	Result
Bottom	1383.600	≥500	883.600	Complied
Middle	1348.700	≥500	848.700	Complied
Top	1273.700	≥500	773.700	Complied



Bottom Channel

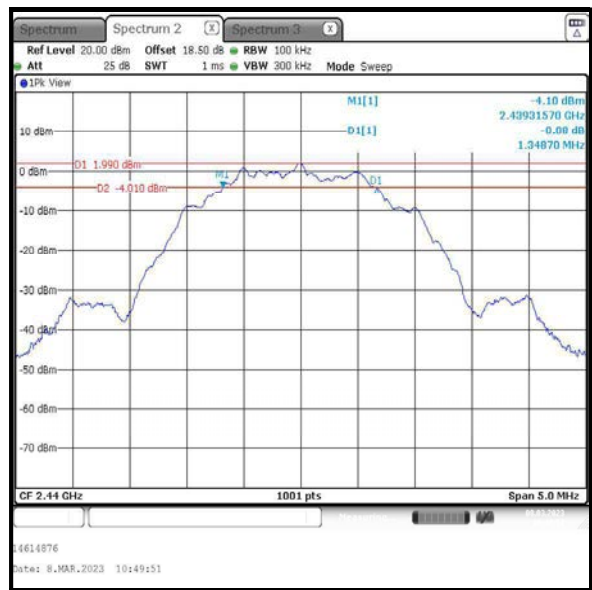

Middle Channel



Top Channel

**Transmitter Minimum 6 dB Bandwidth (continued)**

**Results: LE1M / Beamforming / Core 0**

Channel	6 dB Bandwidth (kHz)	Limit (kHz)	Margin (kHz)	Result
Bottom	719.300	≥500	219.300	Complied
Middle	669.300	≥500	169.300	Complied
Top	654.300	≥500	154.300	Complied

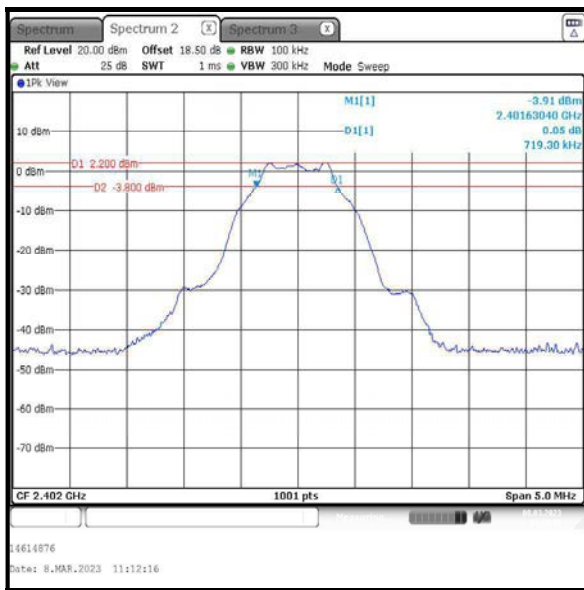

Bottom Channel

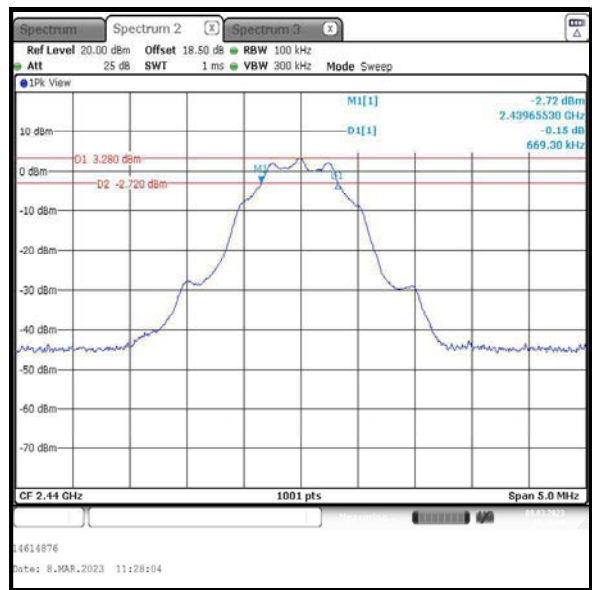

Middle Channel

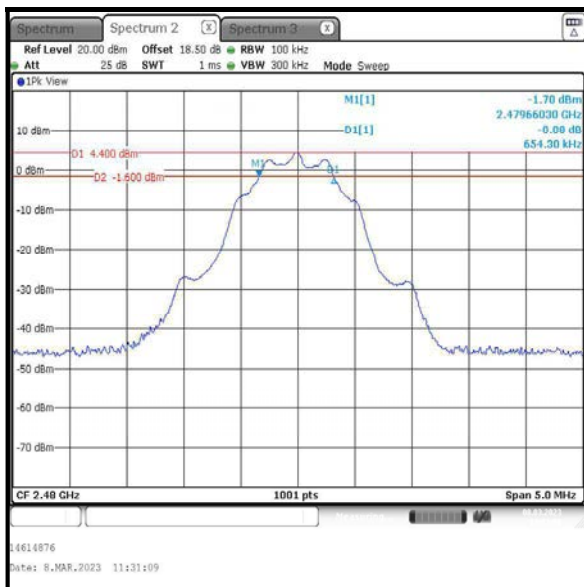

Top Channel



**Transmitter Minimum 6 dB Bandwidth (continued)**

**Results: LE1M / Beamforming / Core 1**

Channel	6 dB Bandwidth (kHz)	Limit (kHz)	Margin (kHz)	Result
Bottom	714.300	≥500	124.300	Complied
Middle	704.300	≥500	204.300	Complied
Top	679.300	≥500	179.300	Complied

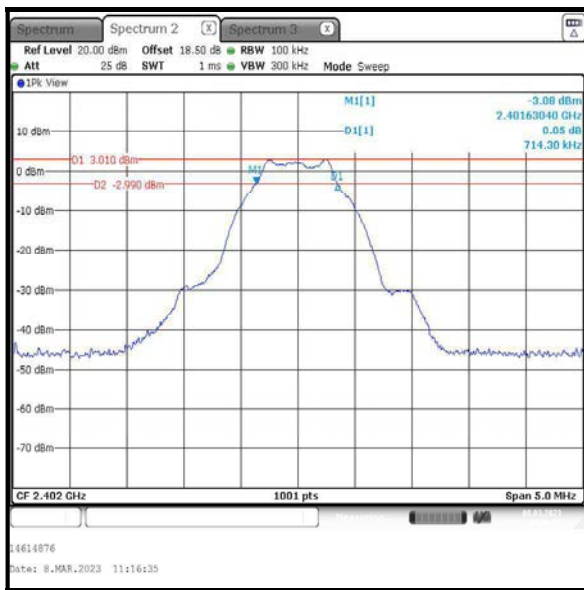

Bottom Channel

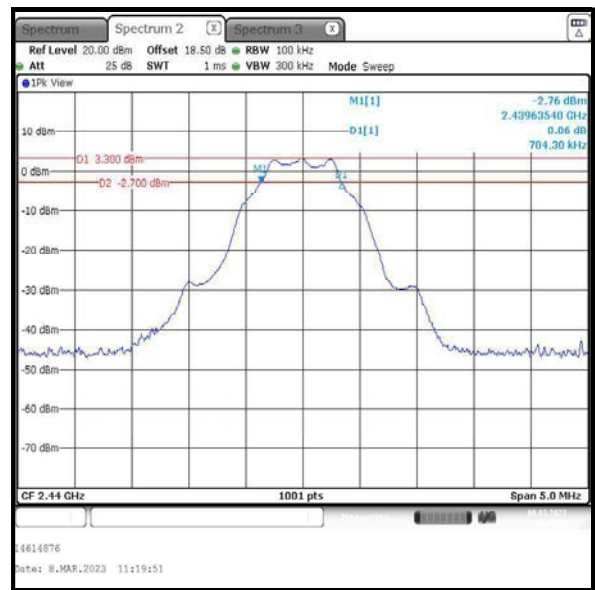

Middle Channel

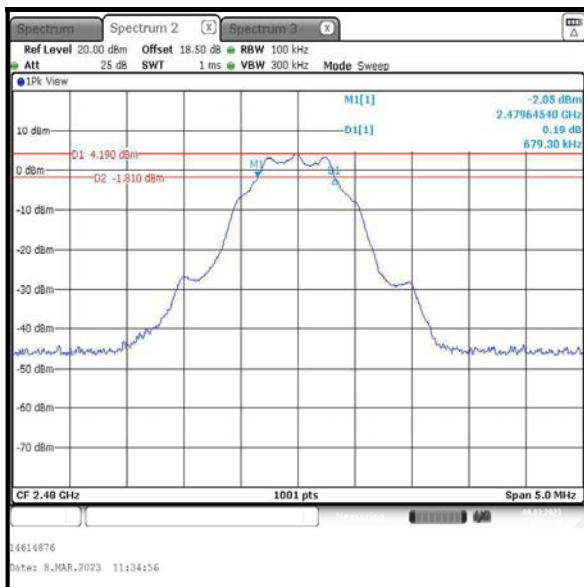

Top Channel

**Transmitter Minimum 6 dB Bandwidth (continued)**

**Results: LE2M / Beamforming / Core 0**

Channel	6 dB Bandwidth (kHz)	Limit (kHz)	Margin (kHz)	Result
Bottom	1278.700	≥500	778.700	Complied
Middle	1138.900	≥500	638.900	Complied
Top	1118.900	≥500	618.900	Complied



Bottom Channel

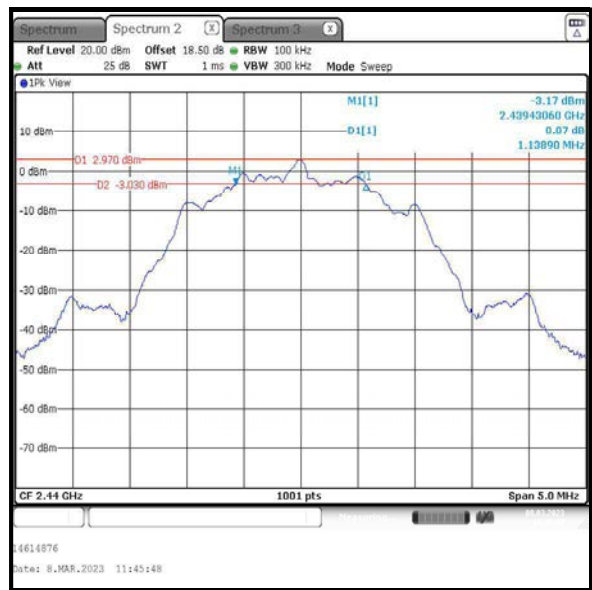

Middle Channel

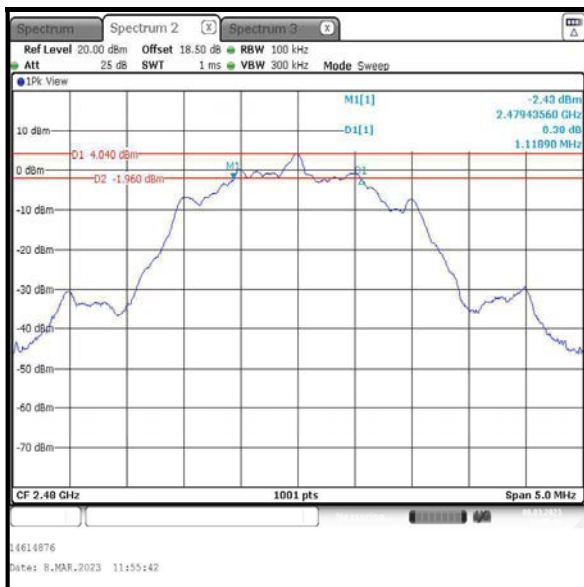

Top Channel

**Transmitter Minimum 6 dB Bandwidth (continued)**

**Results: LE2M / Beamforming / Core 1**

Channel	6 dB Bandwidth (kHz)	Limit (kHz)	Margin (kHz)	Result
Bottom	1348.700	≥500	848.700	Complied
Middle	1258.700	≥500	758.700	Complied
Top	1163.800	≥500	663.800	Complied



Bottom Channel



Middle Channel



Top Channel

### **4.3 Transmitter Maximum Peak Output Power**

#### **Test Summary:**

<b>Test Engineer:</b>	Raghavendra Katti	<b>Test Date:</b>	08 March 2023
<b>Test Sample Serial Number:</b>	GW7L977HC0		

<b>FCC Reference:</b>	Part 15.247(b)(3)
<b>ISED Canada Reference:</b>	RSS-Gen 6.12 / RSS-247 5.4(d)
<b>Test Method Used:</b>	FCC KDB 558074 Section 8.3.1.1 referencing ANSI C63.10 Section 11.9.1.1 and Notes below

#### **Environmental Conditions:**

<b>Temperature (°C):</b>	20
<b>Relative Humidity (%):</b>	41

#### **Note(s):**

1. Conducted power tests were performed using a signal analyser in accordance with ANSI C63.10 Section 11.9.1.1 with the RBW  $\geq$  DTS bandwidth procedure.
2. For LE1M, the signal analyser resolution bandwidth was set to 1 MHz and video bandwidth of 3 MHz. A peak detector was used, sweep time was set to auto and trace mode was Max Hold. The span was set to equal to or greater than three times the RBW. A marker was placed at the peak of the signal and the results recorded in the tables below.
3. For LE2M, the signal analyser resolution bandwidth was set to 2 MHz and video bandwidth of 10 MHz. A peak detector was used, sweep time was set to auto and trace mode was Max Hold. The span was set to equal to or greater than three times the RBW. A marker was placed at the peak of the signal and the results recorded in the tables below.
4. For beamforming modes, conducted power was measured on Core 0 & Core 1 and then combined using the measure-and-sum technique stated in FCC KDB 662911 D01 Section E)1). For EIRP, the directional antenna gain was added to the conducted output power.
5. For beamforming modes, the limit for conducted output power has been reduced by the same amount in dB that the directional gain of the antenna exceeds 6 dBi, in accordance with 15.247(b)(4).
6. The signal analyser was connected to the RF port on the EUT using suitable attenuation and RF cable. An RF level offset was entered on the signal analyser to compensate for the loss of the attenuator and RF cable.

**Transmitter Maximum Peak Output Power (continued)****Results: LE1M / SISO / Core 0**

Channel	Conducted Peak Power (dBm)	Conducted Peak Power Limit (dBm)	Margin (dB)	Result
Bottom	4.2	30.0	25.8	Complied
Middle	5.6	30.0	24.4	Complied
Top	6.1	30.0	23.9	Complied

Channel	Conducted Peak Power (dBm)	Declared Antenna Gain (dBi)	EIRP (dBm)	EIRP Limit (dBm)	Margin (dB)	Result
Bottom	4.2	5.0	9.2	36.0	26.8	Complied
Middle	5.6	5.0	10.6	36.0	25.4	Complied
Top	6.1	5.0	11.1	36.0	24.9	Complied

**Transmitter Maximum Peak Output Power (continued)**

**Results: LE1M / SISO / Core 0**

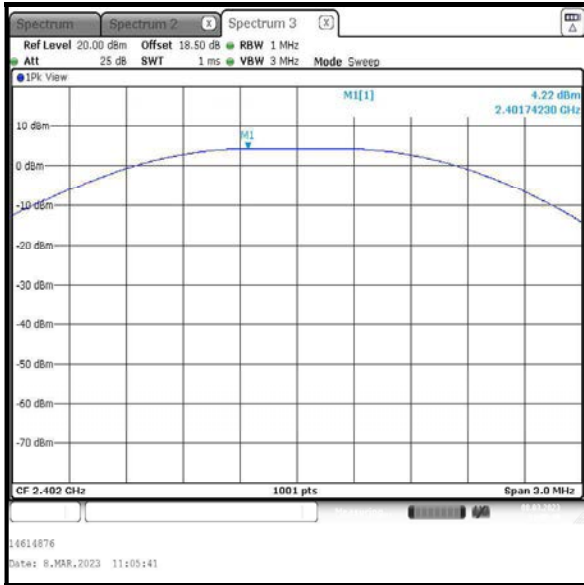

**Bottom Channel**

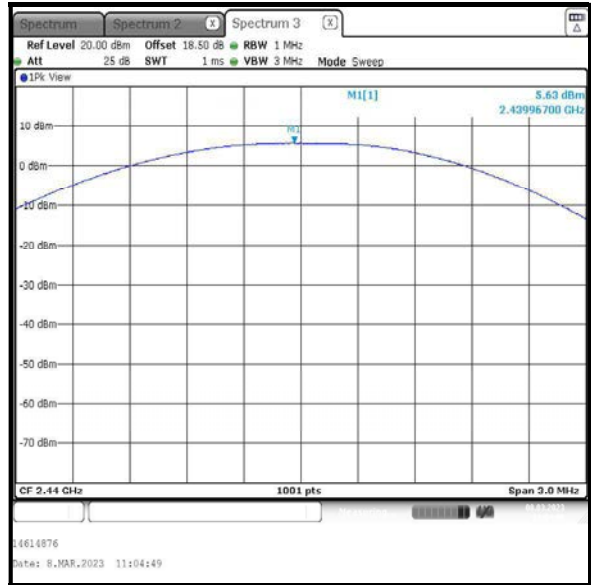

**Middle Channel**

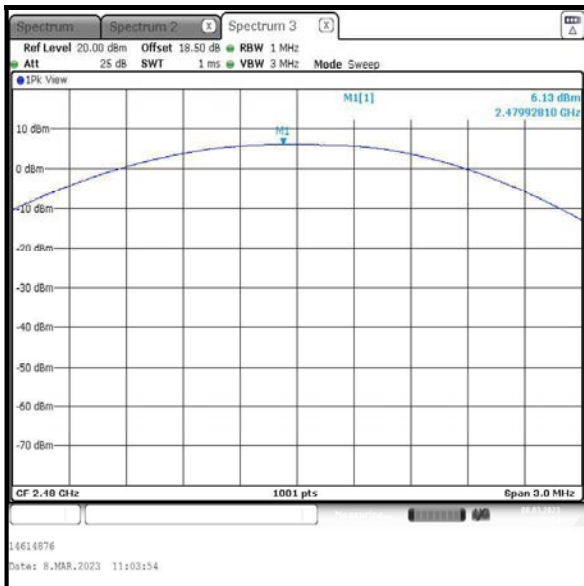

**Top Channel**

**Transmitter Maximum Peak Output Power (continued)****Results: LE2M / SISO / Core 0**

Channel	Conducted Peak Power (dBm)	Conducted Peak Power Limit (dBm)	Margin (dB)	Result
Bottom	4.3	30.0	25.7	Complied
Middle	5.2	30.0	24.8	Complied
Top	5.7	30.0	24.3	Complied

Channel	Conducted Peak Power (dBm)	Declared Antenna Gain (dBi)	EIRP (dBm)	EIRP Limit (dBm)	Margin (dB)	Result
Bottom	4.3	5.0	9.3	36.0	26.7	Complied
Middle	5.2	5.0	10.2	36.0	25.8	Complied
Top	5.7	5.0	10.7	36.0	25.3	Complied

**Transmitter Maximum Peak Output Power (continued)**

**Results: LE2M / SISO / Core 0**

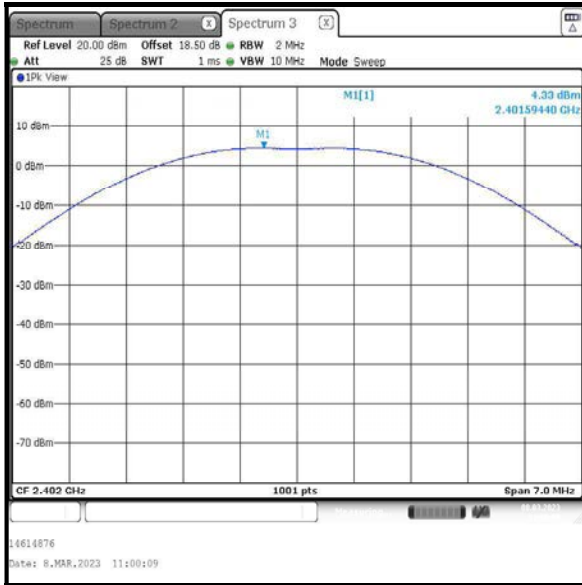

**Bottom Channel**

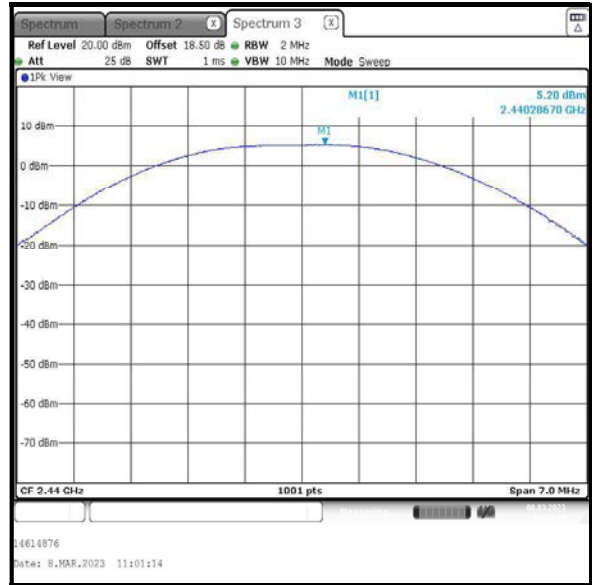

**Middle Channel**

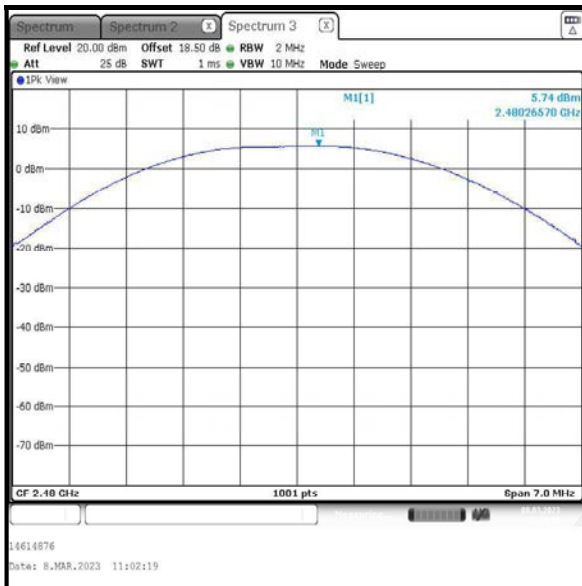

**Top Channel**



**Transmitter Maximum Peak Output Power (continued)****Results: LE1M / SISO / Core 2**

Channel	Conducted Peak Power (dBm)	Conducted Peak Power Limit (dBm)	Margin (dB)	Result
Bottom	4.3	30.0	25.7	Complied
Middle	4.2	30.0	25.8	Complied
Top	4.5	30.0	25.5	Complied

Channel	Conducted Peak Power (dBm)	Declared Antenna Gain (dBi)	EIRP (dBm)	EIRP Limit (dBm)	Margin (dB)	Result
Bottom	4.3	5.2	9.5	36.0	26.5	Complied
Middle	4.2	5.2	9.4	36.0	26.6	Complied
Top	4.5	5.2	9.7	36.0	26.3	Complied

**Transmitter Maximum Peak Output Power (continued)**

**Results: LE1M / SISO / Core 2**

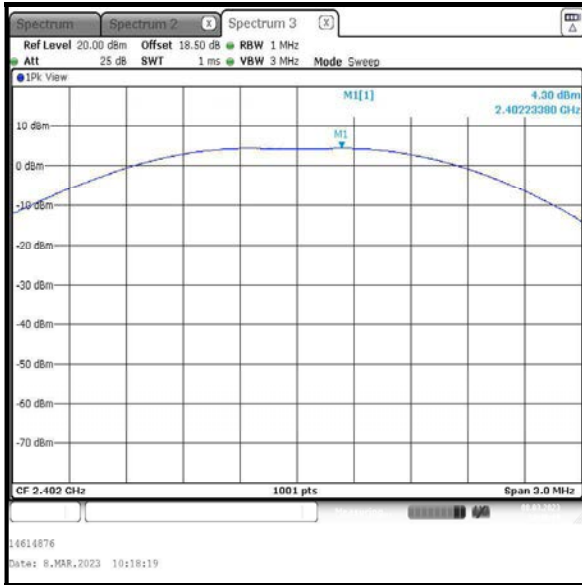

**Bottom Channel**

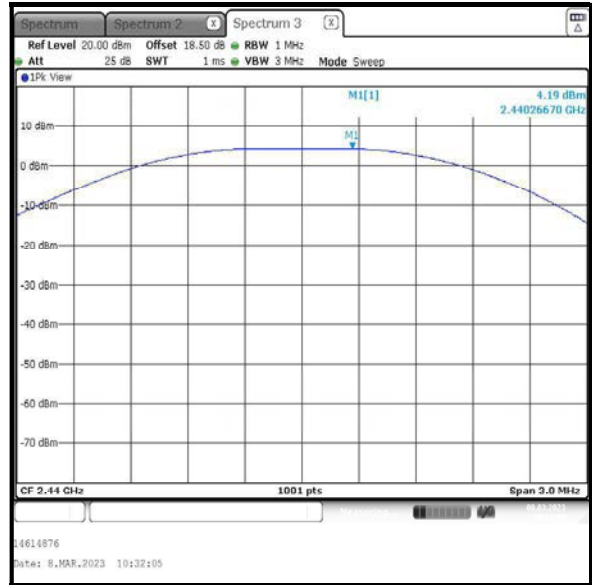

**Middle Channel**

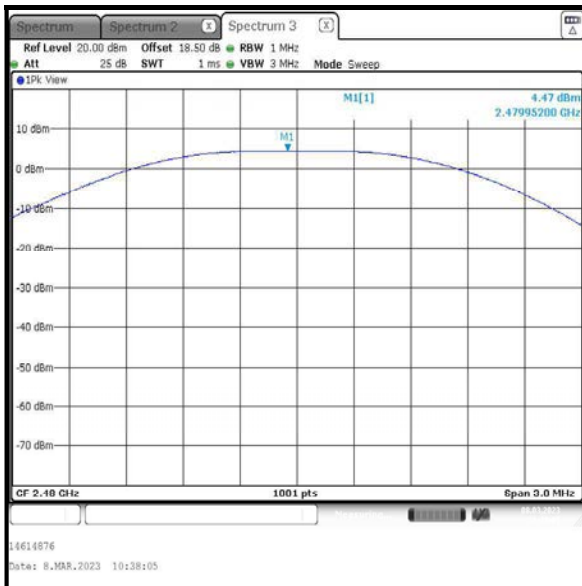

**Top Channel**

**Transmitter Maximum Peak Output Power (continued)****Results: LE2M / SISO / Core 2**

Channel	Conducted Peak Power (dBm)	Conducted Peak Power Limit (dBm)	Margin (dB)	Result
Bottom	4.6	30.0	25.4	Complied
Middle	4.3	30.0	25.7	Complied
Top	4.5	30.0	25.5	Complied

Channel	Conducted Peak Power (dBm)	Declared Antenna Gain (dBi)	EIRP (dBm)	EIRP Limit (dBm)	Margin (dB)	Result
Bottom	4.6	5.2	9.8	36.0	26.2	Complied
Middle	4.3	5.2	9.5	36.0	26.5	Complied
Top	4.5	5.2	9.7	36.0	26.3	Complied

**Transmitter Maximum Peak Output Power (continued)**

**Results: LE2M / SISO / Core 2**

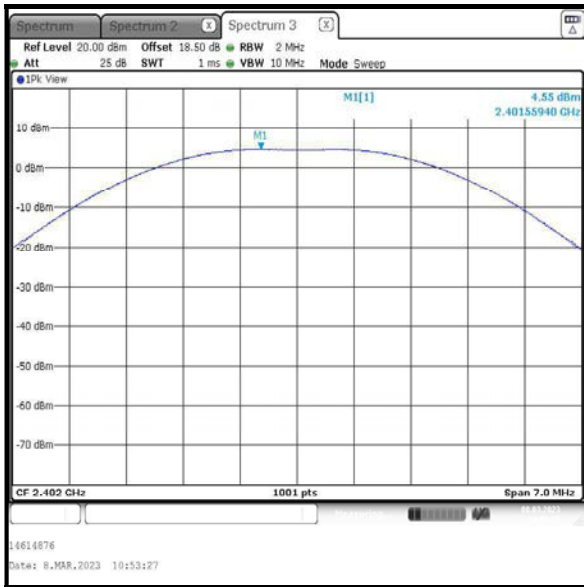

**Bottom Channel**

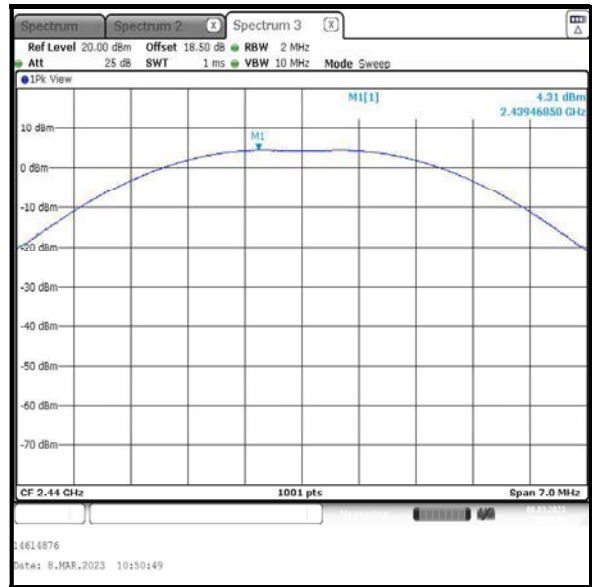

**Middle Channel**

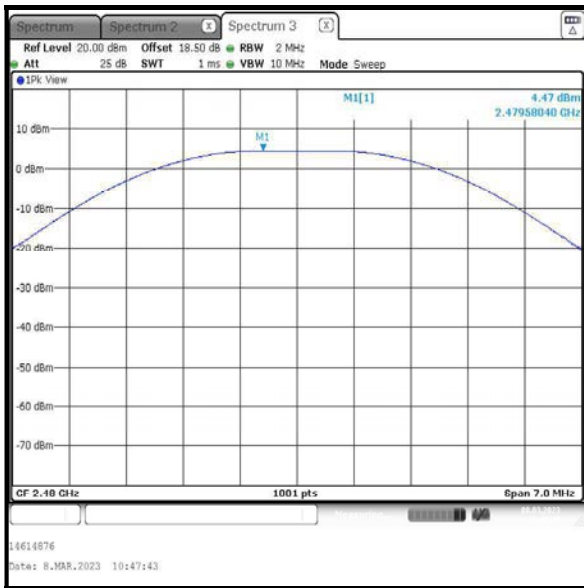

**Top Channel**

**Transmitter Maximum Peak Output Power (continued)****Results: LE1M / Beamforming**

Channel	Conducted Peak Power Core 0 (dBm)	Conducted Peak Power Core 1 (dBm)	Combined Conducted Peak Power (dBm)	Conducted Peak Power Limit (dBm)	Margin (dB)	Result
Bottom	3.2	3.9	6.6	28.1	21.5	Complied
Middle	4.5	4.5	7.5	28.1	20.6	Complied
Top	5.7	5.4	8.6	28.1	19.5	Complied

Channel	Conducted Peak Power (dBm)	Declared Antenna Gain (dBi)	EIRP (dBm)	EIRP Limit (dBm)	Margin (dB)	Result
Bottom	6.6	7.9	14.5	36.0	21.5	Complied
Middle	7.5	7.9	15.4	36.0	20.6	Complied
Top	8.6	7.9	16.5	36.0	19.5	Complied

**Transmitter Maximum Peak Output Power (continued)**

**Results: LE1M / Beamforming / Core 0**

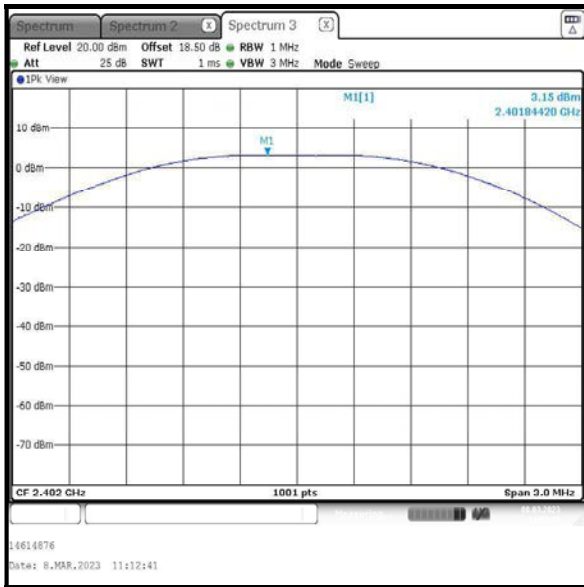

**Bottom Channel**

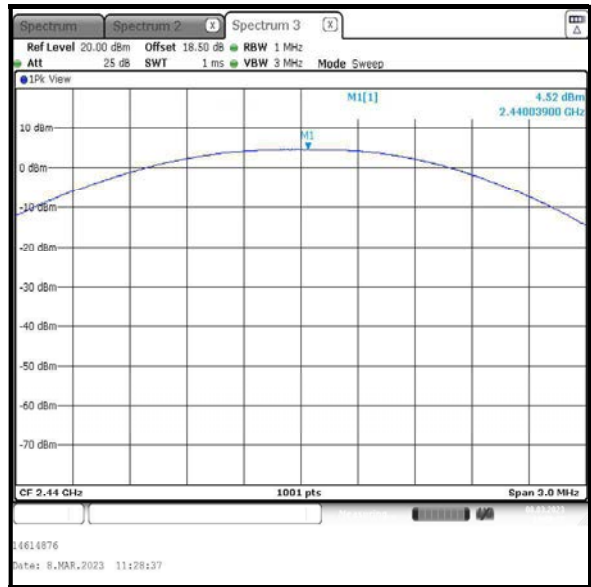

**Middle Channel**

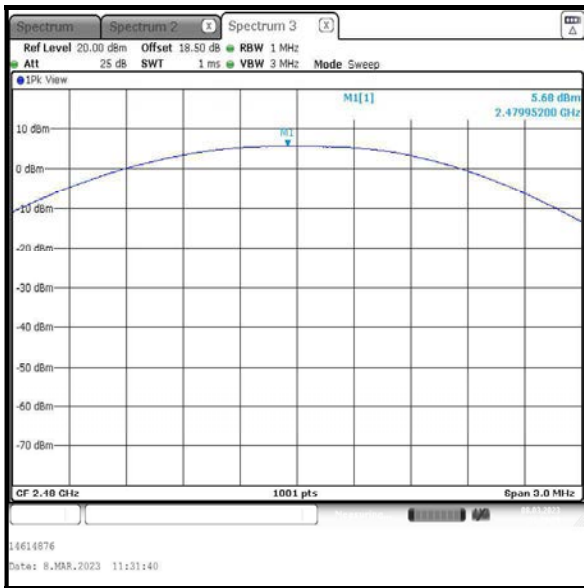

**Top Channel**

**Transmitter Maximum Peak Output Power (continued)**

**Results: LE1M / Beamforming / Core 1**

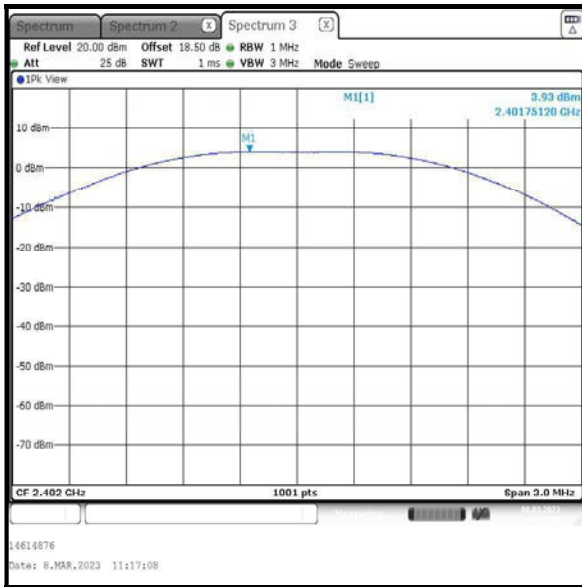

**Bottom Channel**

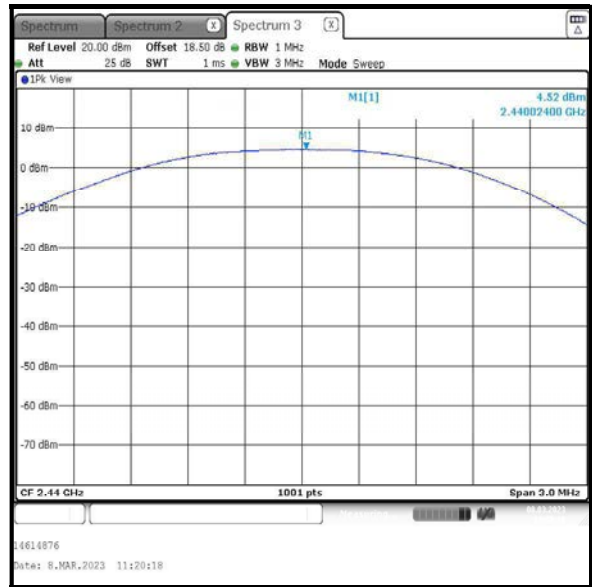

**Middle Channel**

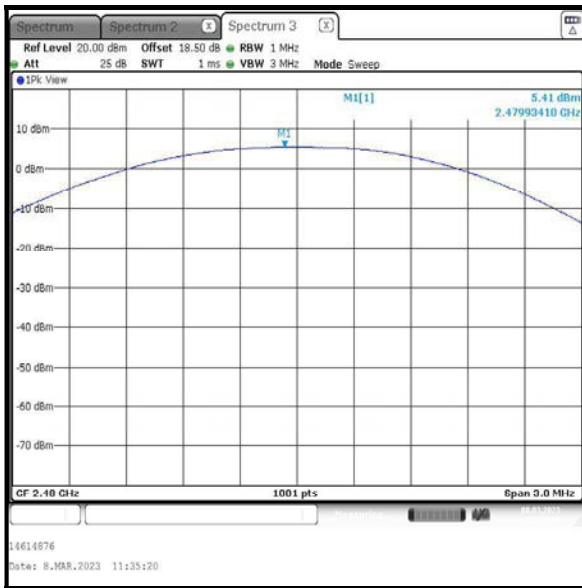

**Top Channel**

**Transmitter Maximum Peak Output Power (continued)****Results: LE2M / Beamforming**

Channel	Conducted Peak Power Core 0 (dBm)	Conducted Peak Power Core 1 (dBm)	Combined Conducted Peak Power (dBm)	Conducted Peak Power Limit (dBm)	Margin (dB)	Result
Bottom	3.2	4.2	6.7	28.1	21.4	Complied
Middle	4.6	4.5	7.6	28.1	20.5	Complied
Top	5.7	5.3	8.5	28.1	19.6	Complied

Channel	Conducted Peak Power (dBm)	Declared Antenna Gain (dBi)	EIRP (dBm)	EIRP Limit (dBm)	Margin (dB)	Result
Bottom	6.7	7.9	14.6	36.0	21.4	Complied
Middle	7.6	7.9	15.5	36.0	20.5	Complied
Top	8.5	7.9	16.4	36.0	19.6	Complied



**Transmitter Maximum Peak Output Power (continued)**

**Results: LE2M / Beamforming / Core 0**

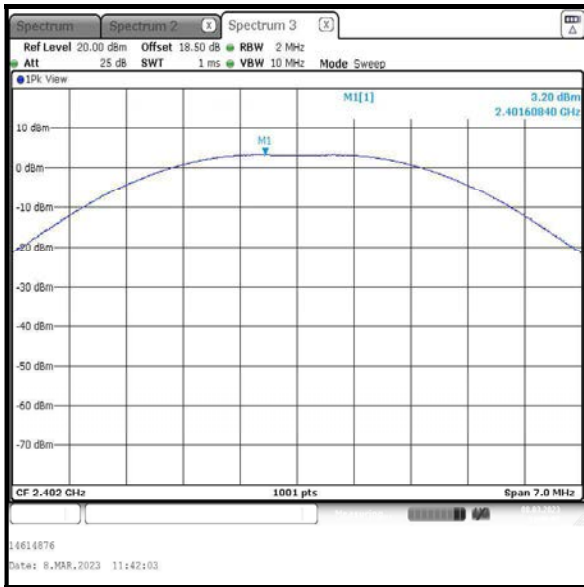

**Bottom Channel**

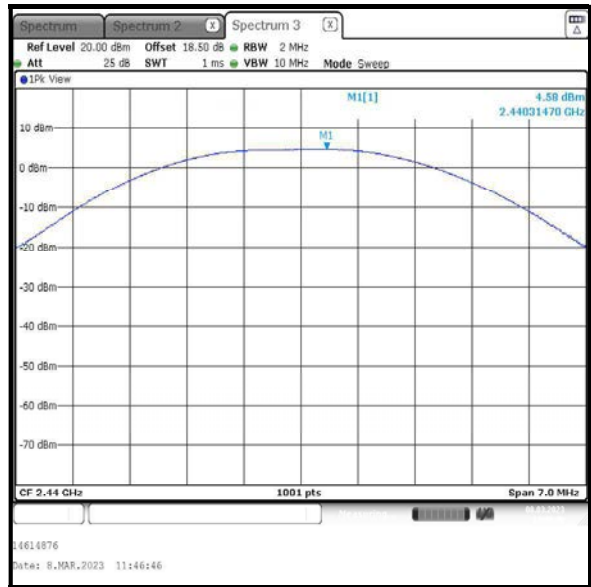

**Middle Channel**

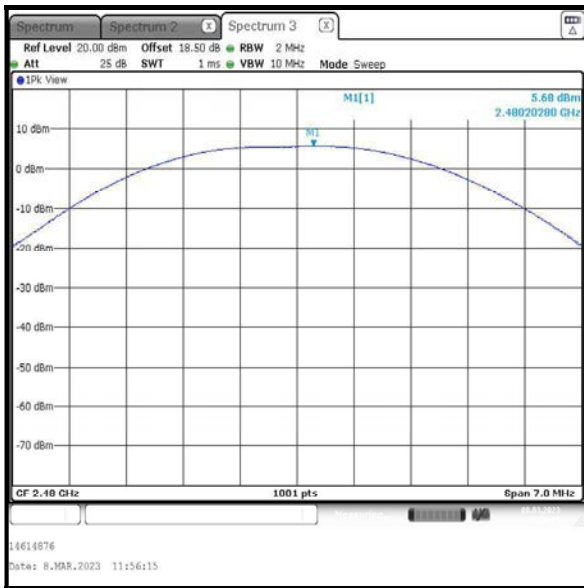

**Top Channel**

**Transmitter Maximum Peak Output Power (continued)**

**Results: LE2M / Beamforming / Core 1**

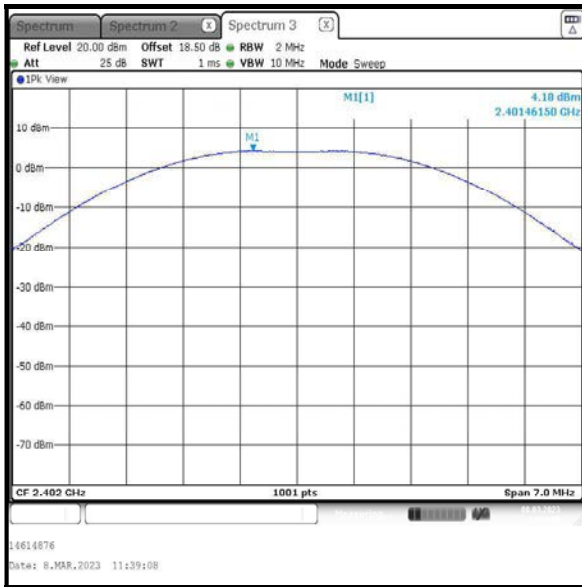

**Bottom Channel**

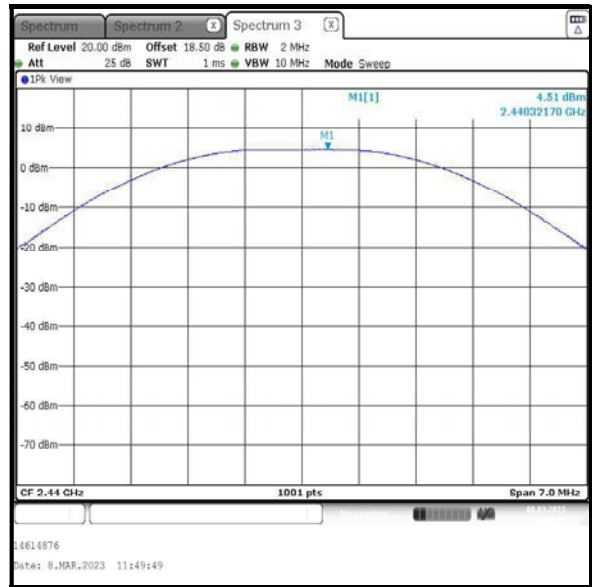

**Middle Channel**

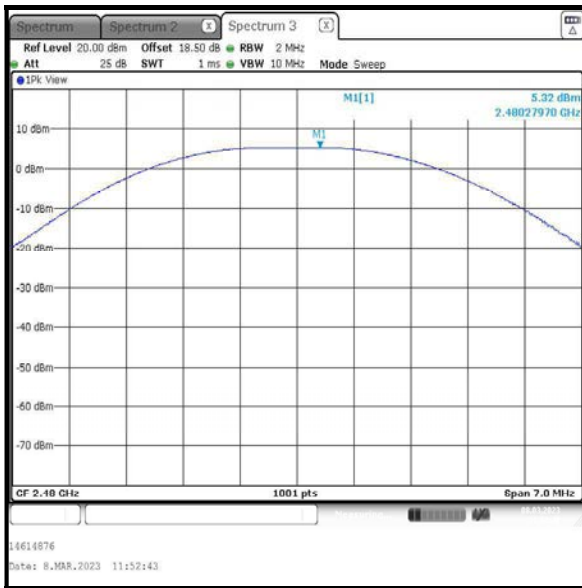

**Top Channel**

#### **4.4 Transmitter Power Spectral Density**

##### **Test Summary:**

<b>Test Engineer:</b>	Raghavendra Katti	<b>Test Date:</b>	08 March 2023
<b>Test Sample Serial Number:</b>	GW7L977HC0		

<b>FCC Reference:</b>	Part 15.247(e)
<b>ISED Canada Reference:</b>	RSS-247 5.2(b)
<b>Test Method Used:</b>	FCC KDB 558074 Section 8.4 referencing ANSI C63.10 Section 11.10.2

##### **Environmental Conditions:**

<b>Temperature (°C):</b>	20
<b>Relative Humidity (%):</b>	41

##### **Note(s):**

1. In accordance with ANSI C63.10 Section 11.10.1, PSD measurements are not required if the maximum conducted output power is less than the PSD limit of 8 dBm / 3 kHz. Measurements have been performed on Beamforming modes, Top channel only.
2. Transmitter Power Spectral Density tests were performed using a signal analyser in accordance with ANSI C63.10 Section 11.10.2.
3. The signal analyser resolution bandwidth was set to 3 kHz and video bandwidth 10 kHz. A Peak detector was used, sweep time was set to auto and the trace mode was Max Hold. The span was set to 1.5 times the measured DTS bandwidth. A marker was placed at the peak of the signal and the results recorded in the table below.
4. The signal analyser was connected to the RF port on the EUT using suitable attenuation and RF cable. An RF level offset was entered on the signal analyser to compensate for the loss of the attenuator and RF cable.

**Transmitter Power Spectral Density (continued)**

**Results: LE1M / Beamforming**

Channel	PSD Core 0 (dBm / 3 kHz)	PSD Core 1 (dBm / 3 kHz)	Combined PSD (dBm / 3 kHz)	Limit (dBm / 3 kHz)	Margin (dB)	Result
Top	-11.6	-11.2	-8.4	8.0	16.4	Complied

**Results: Core 0**

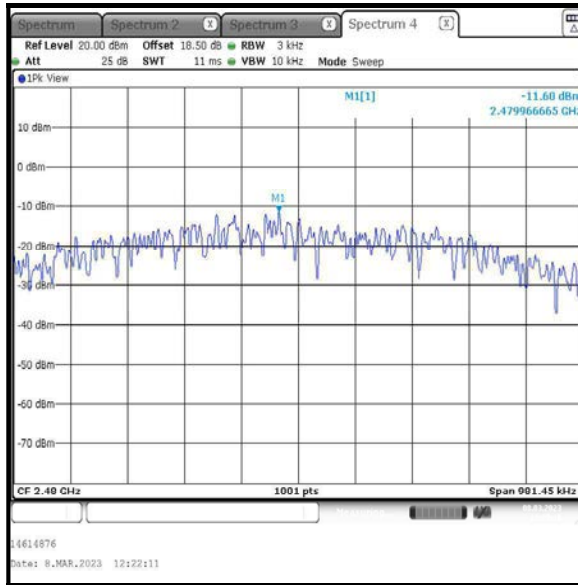

Top Channel

**Results: Core 1**

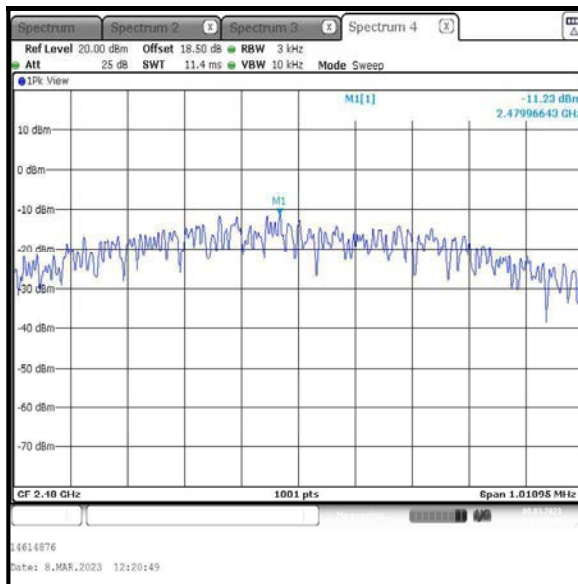

Top Channel

**Transmitter Power Spectral Density (continued)**

**Results: LE2M / Beamforming**

Channel	PSD Core 0 (dBm / 3 kHz)	PSD Core 1 (dBm / 3 kHz)	Combined PSD (dBm / 3 kHz)	Limit (dBm / 3 kHz)	Margin (dB)	Result
Top	-13.9	-13.2	-10.5	8.0	18.5	Complied

**Results: Core 0**

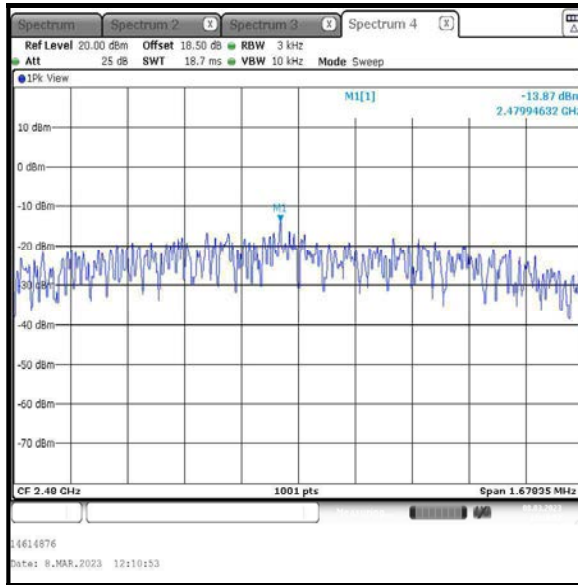

Top Channel

**Results: Core 1**

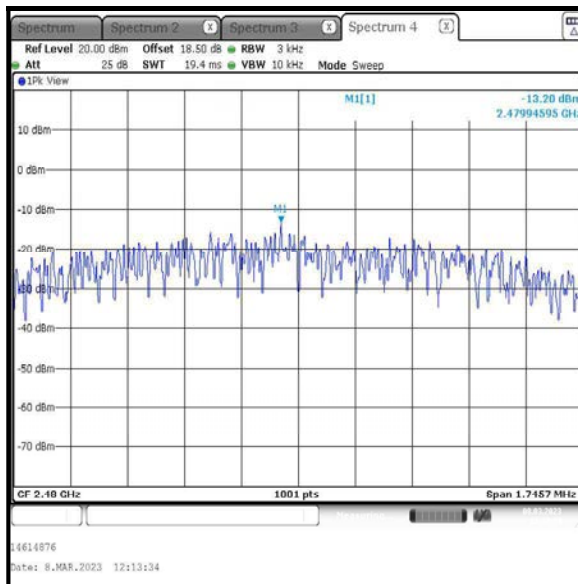

Top Channel

## **5 Radiated Test Results**

### **5.1 Transmitter Radiated Emissions <1 GHz**

#### **Test Summary:**

<b>Test Engineers:</b>	Rob English, Nick Steele & John Ferdinand	<b>Test Dates:</b>	20 December 2022 & 13 January 2023
<b>Test Sample Serial Number:</b>	FQP20QF2CT		

<b>FCC Reference:</b>	Parts 15.247(d) & 15.209(a)
<b>ISED Canada Reference:</b>	RSS-Gen 6.13 & 8.9 / RSS-247 5.5
<b>Test Method Used:</b>	ANSI C63.10 Sections 6.3, 6.4 and 6.5
<b>Frequency Range</b>	9 kHz to 1000 MHz

#### **Environmental Conditions:**

<b>Temperature (°C):</b>	22 to 24
<b>Relative Humidity (%):</b>	39 to 43

#### **Note(s):**

1. The final measured value, for the given emission, in the table below incorporates the calibrated antenna factor and cable loss.
2. The preliminary scans showed similar emission levels below 1 GHz, for each channel of operation. Therefore final radiated emissions measurements were performed with the EUT set to the middle channel only.
3. All emissions shown on the pre-scans were investigated and found to be ambient, or > 20 dB below the appropriate limit or below the noise floor of the measurement system. Therefore the highest peak noise floor reading of the measuring receiver was recorded in the table below.
4. Measurements below 30 MHz were performed in a semi-anechoic chamber (Asset Number K0001) at 3 metres. The EUT was placed at a height of 80 cm above the reference ground plane in the centre of the chamber turntable. The limit was extrapolated to 3 metres in accordance with ANSI C63.10 clause 6.4.3 using the method described in clause 6.4.4.2. ANSI C63.10 clause 5.2 states an alternative test site that can demonstrate equivalence to an open area test site may be used for measurements below 30 MHz. Therefore, measurements were performed in a semi-anechoic chamber. The correlation data between semi-anechoic chamber and an open field test site is available upon request.
5. Measurements from 30 MHz to 1 GHz were performed in a semi-anechoic chamber (Asset Number K0017) at a distance of 3 metres. The EUT was placed at a height of 80 cm above the reference ground plane in the centre of the chamber turntable. Maximum emission levels were determined by height searching the measurement antenna over the range 1 metre to 4 metres.
6. Pre-scans were performed and markers placed on the highest measured levels. The test receiver was configured as follows: For 9 kHz to 150 kHz, the resolution bandwidth was set to 300 Hz and video bandwidth 1 kHz. A peak detector was used and trace mode was Max Hold. For 150 kHz to 30 MHz, the resolution bandwidth was set to 10 kHz and video bandwidth 30 kHz, trace mode was Max Hold. For 30 MHz to 1 GHz, the resolution bandwidth was set to 120 kHz and video bandwidth 500 kHz. A peak detector was used, sweep time was set to auto and trace mode was Max Hold.

**Transmitter Radiated Emissions (continued)**

**Results: Peak / Middle Channel / LE1M / Beamforming / Core 0 + Core 1**

Frequency (MHz)	Antenna Polarity	Level (dB $\mu$ V/m)	Limit (dB $\mu$ V/m)	Margin (dB)	Result
961.427	Vertical	32.2	54.0	21.8	Complied

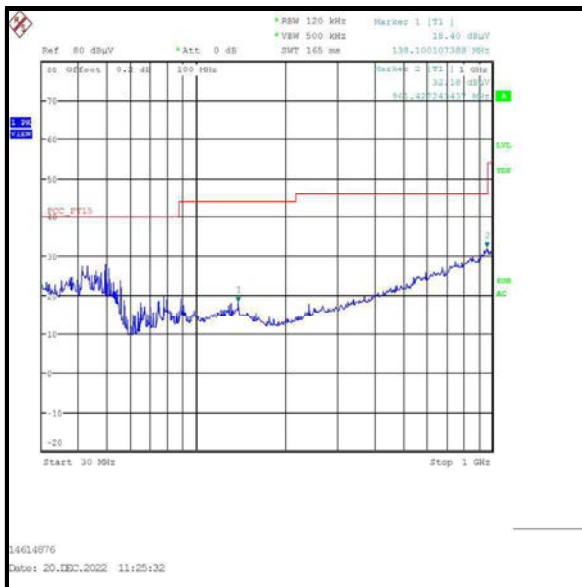
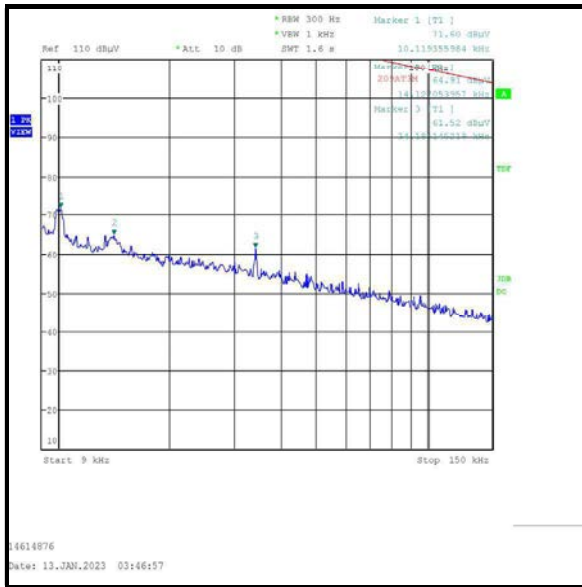

## **5.2 Transmitter Radiated Emissions >1 GHz**

### **Test Summary:**

<b>Test Engineers:</b>	John Ferdinand, Nick Steele & Vi Van	<b>Test Dates:</b>	19 December 2022 to 15 January 2023
<b>Test Sample Serial Numbers:</b>	FQP20QF2CT & C2QY43Q3QM		

<b>FCC Reference:</b>	Parts 15.247(d) & 15.209(a)
<b>ISED Canada Reference:</b>	RSS-Gen 6.13 & 8.9 / RSS-247 5.5
<b>Test Method Used:</b>	FCC KDB 558074 Sections 8.1 c)3), 8.5 & 8.6 referencing ANSI C63.10 Sections 6.3, 6.6, 11.11 & 11.12
<b>Frequency Range</b>	1 GHz to 25 GHz

### **Environmental Conditions:**

<b>Temperature (°C):</b>	22 to 23
<b>Relative Humidity (%):</b>	35 to 42

### **Note(s):**

1. The final measured value, for the given emission, in the table below incorporates the calibrated antenna factor and cable loss.
2. All other emissions shown on the pre-scans were investigated and found to be ambient, or > 20 dB below the appropriate limit or below the noise floor of the measurement system.
3. The emission shown on the 1 GHz to 3 GHz plot at approximately 2440 MHz is the EUT fundamental.
4. In accordance with ANSI C63.10 Section 6.6.4.3, Note 1, if the peak measured value complies with the average limit, it is unnecessary to perform an average measurement.
5. Pre-scans above 1 GHz were performed in a fully anechoic chamber (Asset Number K0001/K0017) at a distance of 3 metres. The EUT was placed at a height of 1.5 metres above the test chamber floor in the centre of the chamber turntable. All measurement antennas were placed at a fixed height of 1.5 metres above the test chamber floor, in line with the EUT.
6. Final measurements above 1 GHz were performed in a semi-anechoic chamber (Asset Number K0017) at a distance of 3 metres. The EUT was placed at a height of 1.5 m above the reference ground plane in the centre of the chamber turntable. Maximum emission levels were determined by height searching the measurement antenna over the range 1 metre to 4 metres.
7. Pre-scans were performed and a marker placed on the highest measured level of the appropriate plot. The test receiver resolution bandwidth was set to 1 MHz and video bandwidth 3 MHz. The sweep time was set to auto. Peak and average measurements were performed with their own appropriate detectors during the pre-scan measurements.
8. Final measurements were performed on the marker frequencies and the results entered into the table below. The test receiver resolution bandwidth was set to 1 MHz and video bandwidth 3 MHz. The sweep time was set to auto, with and span wide enough to see the whole emission.



**Transmitter Radiated Emissions (continued)****Results: Bottom Channel / LE1M / Beamforming / Core 0 + Core 1**

Frequency (MHz)	Antenna Polarity	Peak Level (dB $\mu$ V/m)	Average Limit (dB $\mu$ V/m)	Margin (dB)	Result
4803.038	Vertical	48.7	54.0	5.3	Complied

**Results: Middle Channel / LE1M / Beamforming / Core 0 + Core 1**

Frequency (MHz)	Antenna Polarity	Peak Level (dB $\mu$ V/m)	Average Limit (dB $\mu$ V/m)	Margin (dB)	Result
4879.567	Vertical	48.8	54.0	5.2	Complied

**Results: Top Channel / LE1M / Beamforming / Core 0 + Core 1**

Frequency (MHz)	Antenna Polarity	Peak Level (dB $\mu$ V/m)	Average Limit (dB $\mu$ V/m)	Margin (dB)	Result
4959.295	Vertical	49.1	54.0	4.9	Complied

**Transmitter Radiated Emissions (continued)**

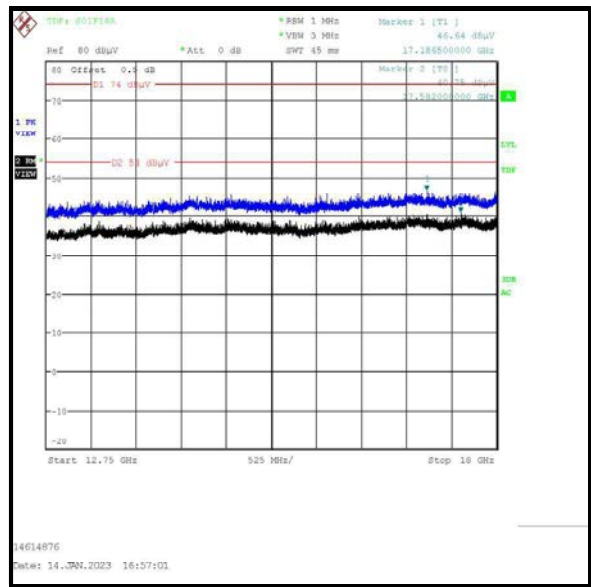
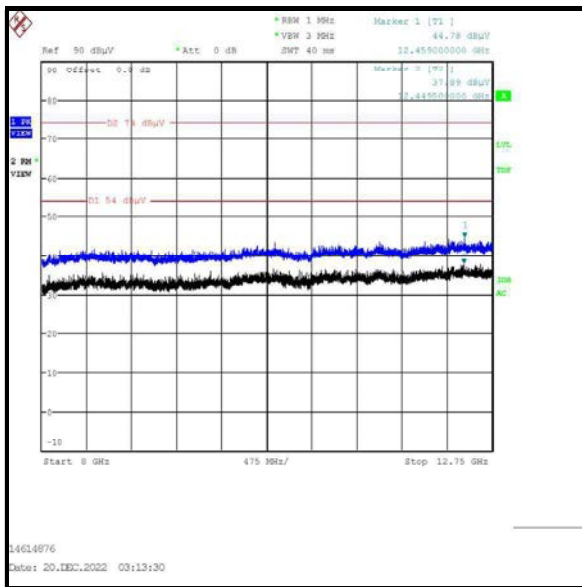
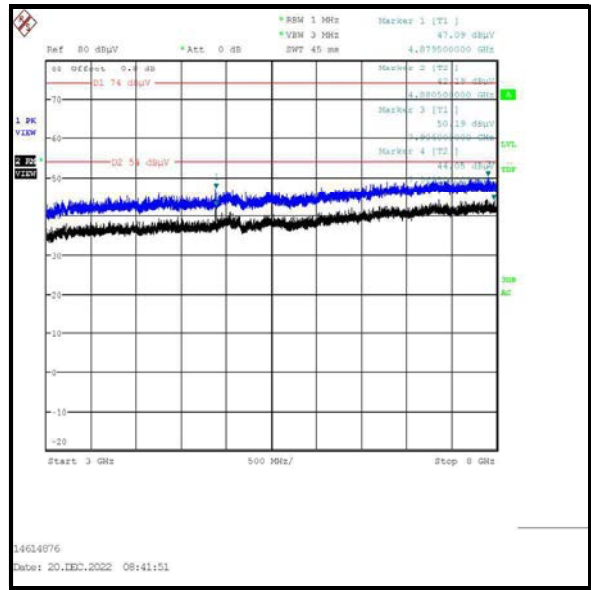
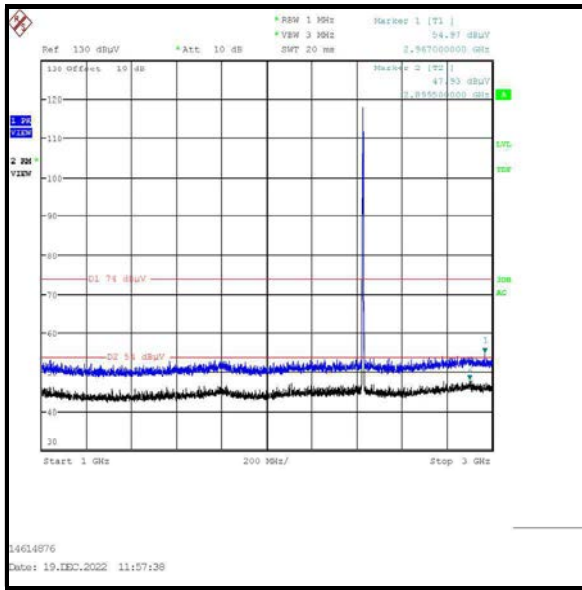

**Transmitter Radiated Emissions (continued)**

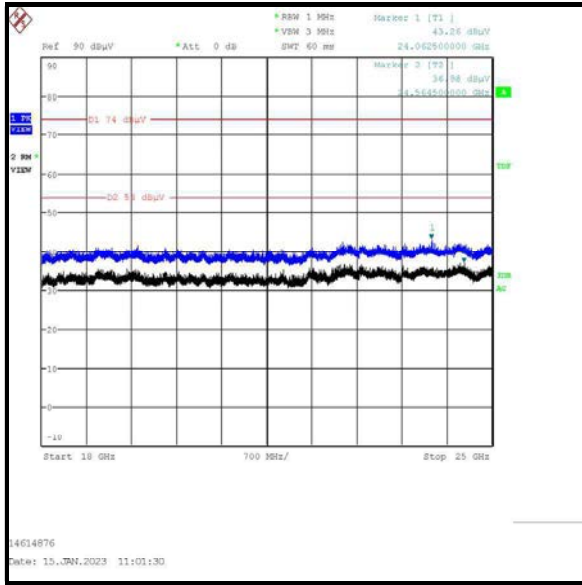

*Note: The above plots are pre-scans and for indication purposes only. For final measurements, see accompanying tables.*

### **5.3 Transmitter Band Edge Radiated Emissions**

#### **Test Summary:**

<b>Test Engineers:</b>	John Ferdinand & Andrew Harding	<b>Test Dates:</b>	15 November 2022 to 24 November 2022
<b>Test Sample Serial Number:</b>	FQP20QF2CT		

<b>FCC Reference:</b>	Parts 15.247(d) & 15.209(a)
<b>ISED Canada Reference:</b>	RSS-Gen 6.13 / RSS-247 5.5
<b>Test Method Used:</b>	KDB 558074 Section 8.7 referencing ANSI C63.10 Sections 11.11, 11.12 & 11.13

#### **Environmental Conditions:**

<b>Temperature (°C):</b>	21 to 25
<b>Relative Humidity (%):</b>	38 to 51

#### **Note(s):**

1. The final measured value, for the given emission, in the table below incorporates the calibrated antenna factor and cable loss.
2. As the lower band edge is adjacent to a non-restricted band, only peak measurements are required. In accordance with ANSI C63.10 Section 11.11.1, the test method in Section 11.11.3 was followed: the test receiver resolution bandwidth was set to 100 kHz and video bandwidth 300 kHz. A peak detector was used, sweep time was set to auto and trace mode was Max Hold. The test receiver was left to sweep for a sufficient length of time in order to maximise the carrier level and out-of-band emissions. A marker and corresponding reference level line were placed on the peak of the carrier. As the maximum peak conducted output power was measured using a peak detector in accordance with ANSI C63.10 Section 11.9.1.1 an out-of-band limit line was placed 20 dB (ANSI C63.10 Section 11.11.1(a)) below the peak level. A marker was placed on the band edge spot frequencies. Marker frequency and levels were recorded.
3. As the upper band edge is adjacent to a restricted band, both peak and average measurements were recorded by placing a marker at the edge of the band. For peak measurements the test receiver resolution bandwidth was set to 1 MHz and the video bandwidth 3 MHz. A peak detector was used, sweep time was set to auto and trace mode was Max Hold. For average measurements the test receiver resolution bandwidth was set to 1 MHz and the video bandwidth 3 MHz. An RMS detector was used, sweep time was set to auto and trace mode was trace averaging over 300 sweeps. A marker was placed on the band edge spot frequencies and a second marker placed on the highest emission level in the adjacent restricted band of operation (where a higher level emission was present). Marker frequencies and levels were recorded.
4. There is a restricted band 10 MHz below the lower band edge. The test receiver was set up as follows: the RBW set to 1 MHz, the VBW set to 3 MHz, with the sweep time set to auto couple. Peak and average measurements were performed with peak and RMS detectors respectively. Markers were placed on the highest point on each trace.
5. \* -20 dBc limit.

**Transmitter Band Edge Radiated Emissions (continued)****Results: LE1M / SISO / Core 0**

Frequency (MHz)	Antenna Polarity	Peak Level (dB $\mu$ V/m)	Limit (dB $\mu$ V/m)	Margin (dB)	Result
2400.0	Horizontal	48.2	91.8*	43.6	Complied
2483.5	Horizontal	53.0	74.0	21.0	Complied
2484.0	Horizontal	54.2	74.0	19.8	Complied

Frequency (MHz)	Antenna Polarity	Average Level (dB $\mu$ V/m)	Limit (dB $\mu$ V/m)	Margin (dB)	Result
2483.5	Horizontal	42.9	54.0	11.1	Complied
2483.600	Horizontal	43.1	54.0	10.9	Complied

**Results: 2310 MHz to 2390 MHz Restricted Band / Peak**

Frequency (MHz)	Antenna Polarity	Level (dB $\mu$ V/m)	Limit (dB $\mu$ V/m)	Margin (dB)	Result
2387.840	Horizontal	53.4	74.0	20.6	Complied

**Results: 2310 MHz to 2390 MHz Restricted Band / Average**

Frequency (MHz)	Antenna Polarity	Level (dB $\mu$ V/m)	Limit (dB $\mu$ V/m)	Margin (dB)	Result
2385.360	Horizontal	41.4	54.0	12.6	Complied

**Transmitter Band Edge Radiated Emissions (continued)**

**Results: LE1M / SISO / Core 0**

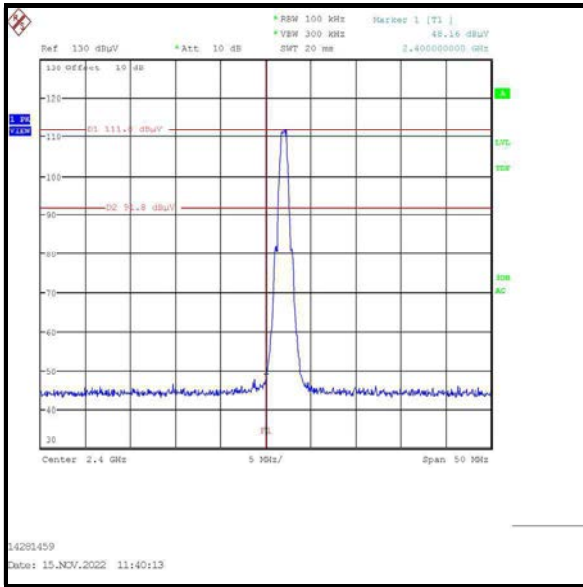

**Lower Band Edge**

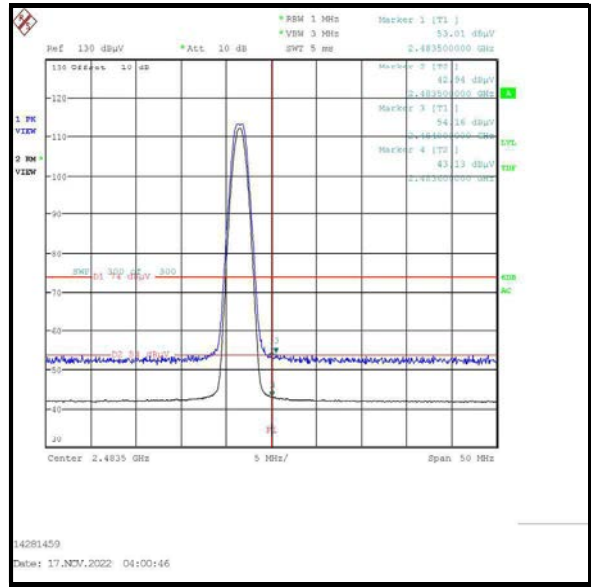

**Upper Band Edge**

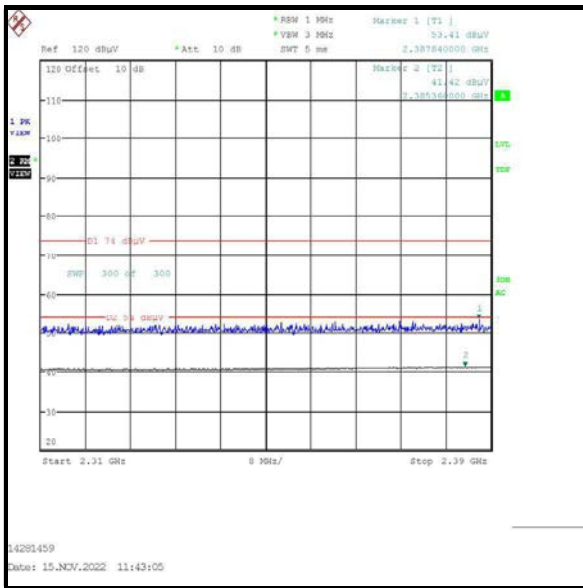

**2310 MHz to 2390 MHz Restricted Band**

**Transmitter Band Edge Radiated Emissions (continued)****Results: LE2M / SISO / Core 0**

Frequency (MHz)	Antenna Polarity	Peak Level (dB $\mu$ V/m)	Limit (dB $\mu$ V/m)	Margin (dB)	Result
2400.0	Horizontal	77.9	90.0*	12.1	Complied
2483.5	Horizontal	59.9	74.0	14.1	Complied

Frequency (MHz)	Antenna Polarity	Average Level (dB $\mu$ V/m)	Limit (dB $\mu$ V/m)	Margin (dB)	Result
2483.5	Horizontal	50.4	54.0	3.6	Complied

**Results: 2310 MHz to 2390 MHz Restricted Band / Peak**

Frequency (MHz)	Antenna Polarity	Level (dB $\mu$ V/m)	Limit (dB $\mu$ V/m)	Margin (dB)	Result
2357.680	Horizontal	54.3	74.0	19.7	Complied

**Results: 2310 MHz to 2390 MHz Restricted Band / Average**

Frequency (MHz)	Antenna Polarity	Level (dB $\mu$ V/m)	Limit (dB $\mu$ V/m)	Margin (dB)	Result
2390.000	Horizontal	41.5	54.0	12.5	Complied

**Transmitter Band Edge Radiated Emissions (continued)**

**Results: LE2M / SISO / Core 0**

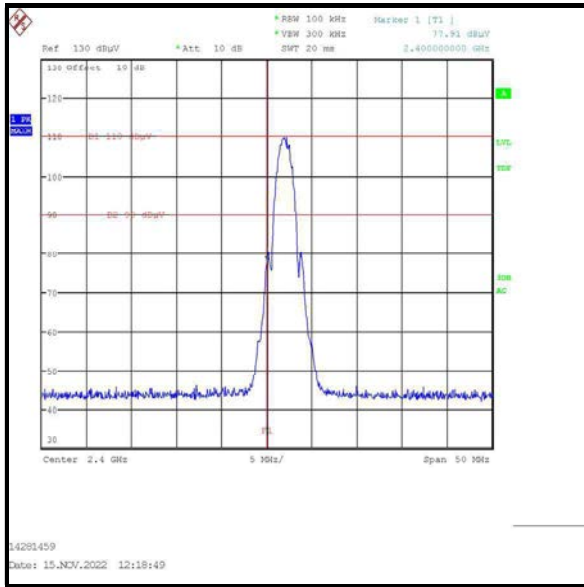

**Lower Band Edge**

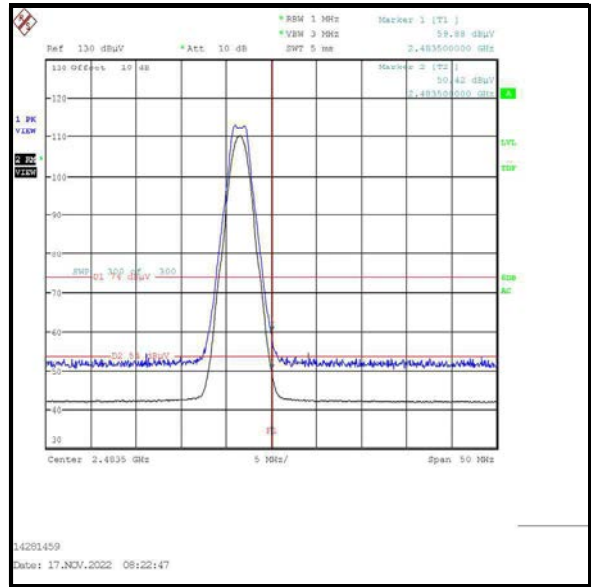

**Upper Band Edge**

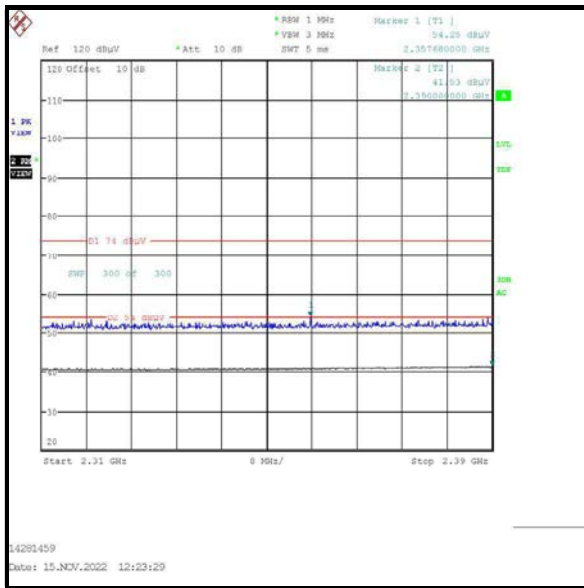

**2310 MHz to 2390 MHz Restricted Band**



**Transmitter Band Edge Radiated Emissions (continued)****Results: LE1M / SISO / Core 1**

Frequency (MHz)	Antenna Polarity	Peak Level (dB $\mu$ V/m)	Limit (dB $\mu$ V/m)	Margin (dB)	Result
2400.0	Horizontal	54.5	91.9*	37.4	Complied
2483.5	Horizontal	53.4	74.0	20.6	Complied
2493.800	Horizontal	54.5	74.0	19.5	Complied

Frequency (MHz)	Antenna Polarity	Average Level (dB $\mu$ V/m)	Limit (dB $\mu$ V/m)	Margin (dB)	Result
2483.5	Horizontal	43.0	54.0	11.0	Complied

**Results: 2310 MHz to 2390 MHz Restricted Band / Peak**

Frequency (MHz)	Antenna Polarity	Level (dB $\mu$ V/m)	Limit (dB $\mu$ V/m)	Margin (dB)	Result
2378.640	Horizontal	53.5	74.0	20.5	Complied

**Results: 2310 MHz to 2390 MHz Restricted Band / Average**

Frequency (MHz)	Antenna Polarity	Level (dB $\mu$ V/m)	Limit (dB $\mu$ V/m)	Margin (dB)	Result
2388.960	Horizontal	41.4	54.0	12.6	Complied

**Transmitter Band Edge Radiated Emissions (continued)**

**Results: LE1M / SISO / Core 1**

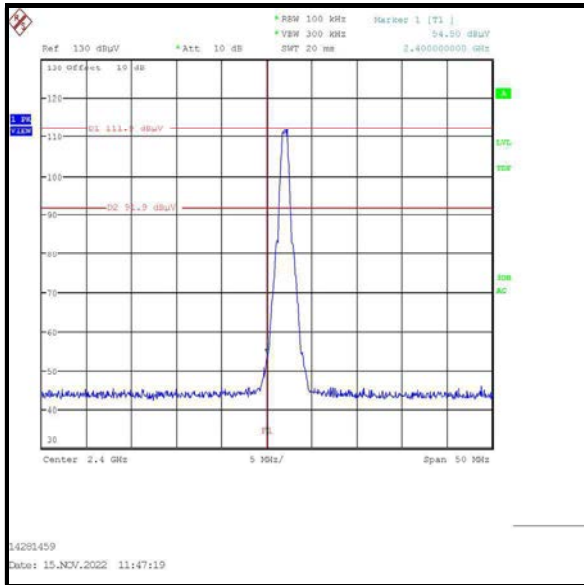

**Lower Band Edge**

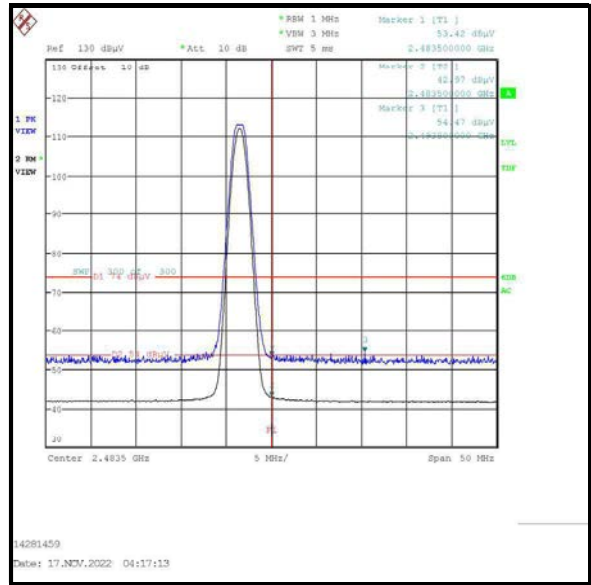

**Upper Band Edge**

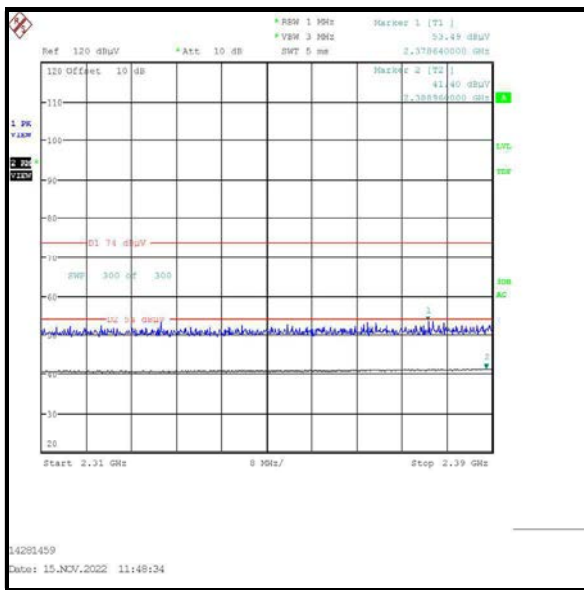

**2310 MHz to 2390 MHz Restricted Band**

**Transmitter Band Edge Radiated Emissions (continued)****Results: LE2M / SISO / Core 1**

Frequency (MHz)	Antenna Polarity	Peak Level (dB $\mu$ V/m)	Limit (dB $\mu$ V/m)	Margin (dB)	Result
2400.0	Horizontal	80.2	89.9*	9.7	Complied
2483.5	Horizontal	60.1	74.0	13.9	Complied

Frequency (MHz)	Antenna Polarity	Average Level (dB $\mu$ V/m)	Limit (dB $\mu$ V/m)	Margin (dB)	Result
2483.5	Horizontal	51.2	54.0	2.8	Complied

**Results: 2310 MHz to 2390 MHz Restricted Band / Peak**

Frequency (MHz)	Antenna Polarity	Level (dB $\mu$ V/m)	Limit (dB $\mu$ V/m)	Margin (dB)	Result
2366.720	Horizontal	53.9	74.0	20.1	Complied

**Results: 2310 MHz to 2390 MHz Restricted Band / Average**

Frequency (MHz)	Antenna Polarity	Level (dB $\mu$ V/m)	Limit (dB $\mu$ V/m)	Margin (dB)	Result
2389.200	Horizontal	41.4	54.0	12.6	Complied

**Transmitter Band Edge Radiated Emissions (continued)**

**Results: LE2M / SISO / Core 1**

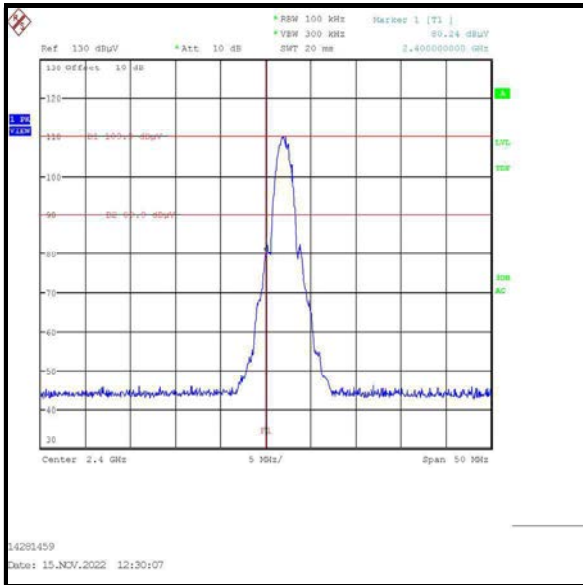

**Lower Band Edge**

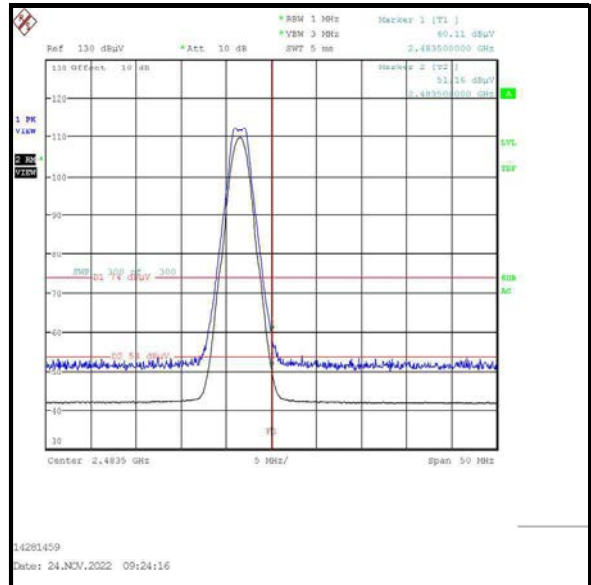

**Upper Band Edge**

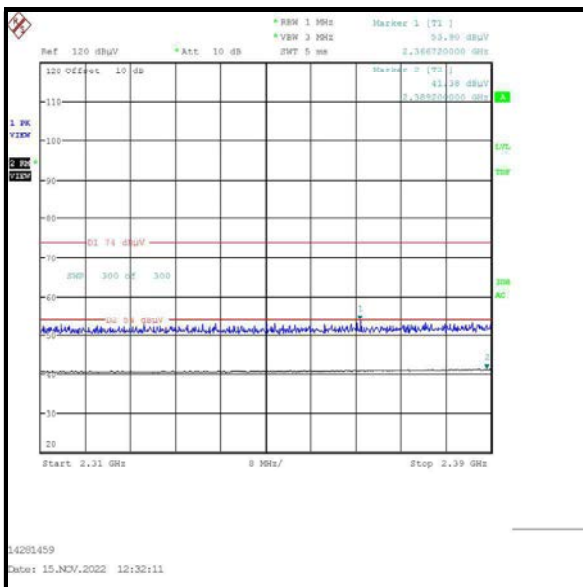

**2310 MHz to 2390 MHz Restricted Band**

**Transmitter Band Edge Radiated Emissions (continued)****Results: LE1M / SISO / Core 2**

Frequency (MHz)	Antenna Polarity	Peak Level (dB $\mu$ V/m)	Limit (dB $\mu$ V/m)	Margin (dB)	Result
2400.0	Horizontal	51.5	91.2*	39.7	Complied
2483.5	Horizontal	52.7	74.0	21.3	Complied
2496.600	Horizontal	54.2	74.0	19.8	Complied

Frequency (MHz)	Antenna Polarity	Average Level (dB $\mu$ V/m)	Limit (dB $\mu$ V/m)	Margin (dB)	Result
2483.5	Horizontal	42.9	54.0	11.1	Complied

**Results: 2310 MHz to 2390 MHz Restricted Band / Peak**

Frequency (MHz)	Antenna Polarity	Level (dB $\mu$ V/m)	Limit (dB $\mu$ V/m)	Margin (dB)	Result
2375.120	Horizontal	53.5	74.0	20.5	Complied

**Results: 2310 MHz to 2390 MHz Restricted Band / Average**

Frequency (MHz)	Antenna Polarity	Level (dB $\mu$ V/m)	Limit (dB $\mu$ V/m)	Margin (dB)	Result
2389.680	Horizontal	41.3	54.0	12.7	Complied

**Transmitter Band Edge Radiated Emissions (continued)**

**Results: LE1M / SISO / Core 2**

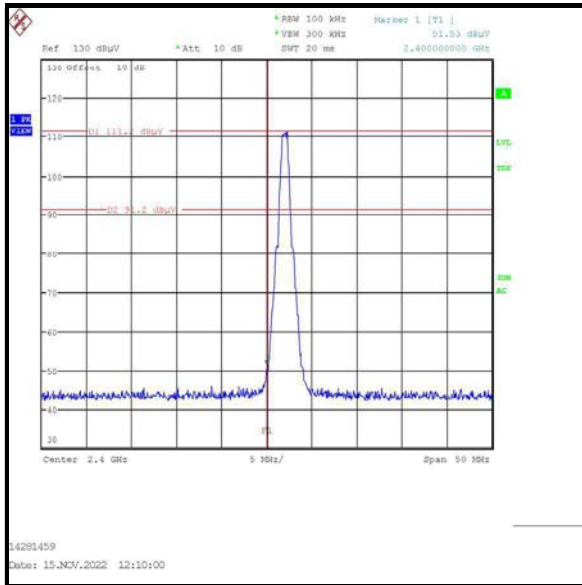

**Lower Band Edge**

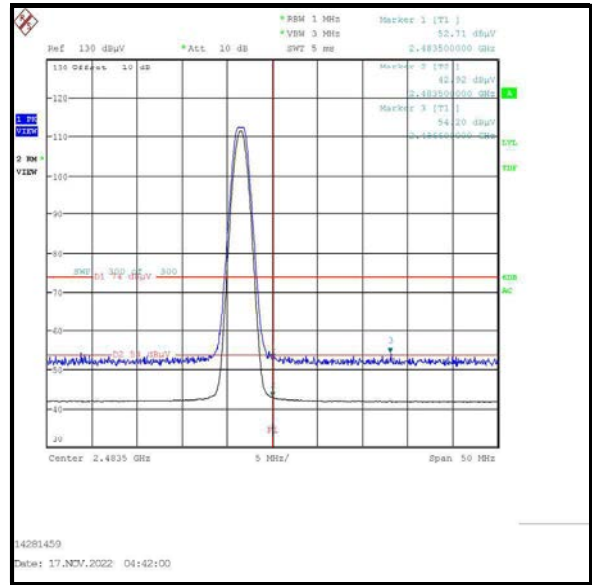

**Upper Band Edge**

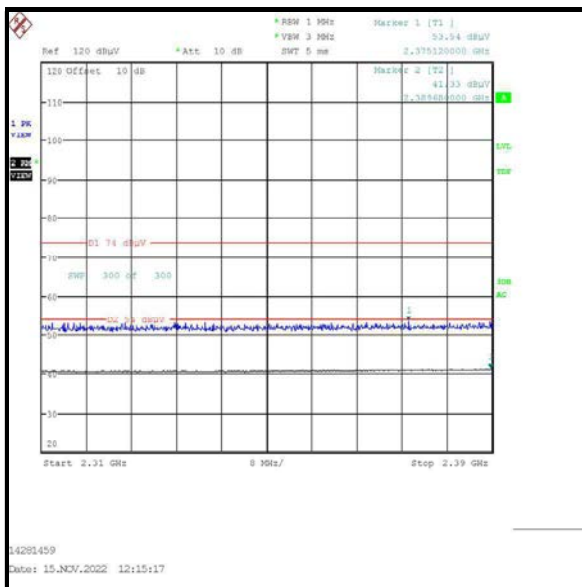

**2310 MHz to 2390 MHz Restricted Band**

**Transmitter Band Edge Radiated Emissions (continued)****Results: LE2M / SISO / Core 2**

Frequency (MHz)	Antenna Polarity	Peak Level (dB $\mu$ V/m)	Limit (dB $\mu$ V/m)	Margin (dB)	Result
2400.0	Horizontal	78.5	89.2*	10.7	Complied
2483.5	Horizontal	58.6	74.0	15.4	Complied

Frequency (MHz)	Antenna Polarity	Average Level (dB $\mu$ V/m)	Limit (dB $\mu$ V/m)	Margin (dB)	Result
2483.500	Horizontal	49.5	54.0	4.5	Complied

**Results: 2310 MHz to 2390 MHz Restricted Band / Peak**

Frequency (MHz)	Antenna Polarity	Level (dB $\mu$ V/m)	Limit (dB $\mu$ V/m)	Margin (dB)	Result
2364.800	Horizontal	53.7	74.0	20.3	Complied

**Results: 2310 MHz to 2390 MHz Restricted Band / Average**

Frequency (MHz)	Antenna Polarity	Level (dB $\mu$ V/m)	Limit (dB $\mu$ V/m)	Margin (dB)	Result
2389.680	Horizontal	41.4	54.0	12.6	Complied

**Transmitter Band Edge Radiated Emissions (continued)**

**Results: LE2M / SISO / Core 2**

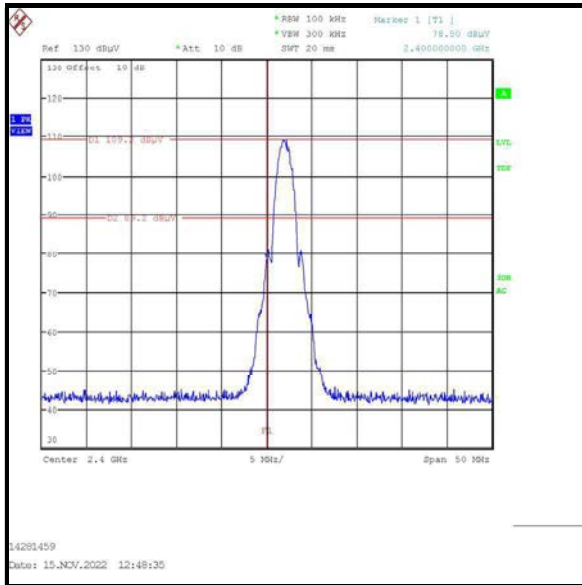

**Lower Band Edge**

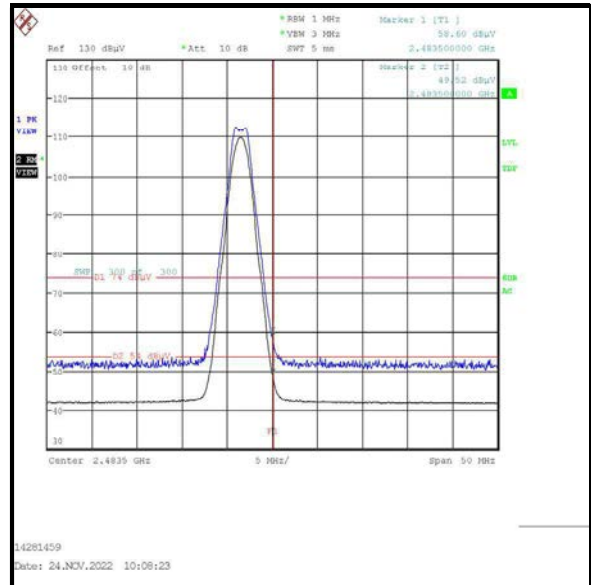

**Upper Band Edge**

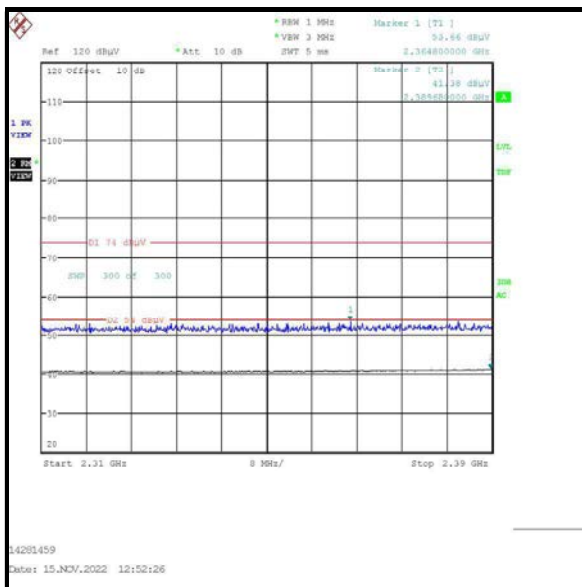

**2310 MHz to 2390 MHz Restricted Band**



**Transmitter Band Edge Radiated Emissions (continued)****Results: LE1M / Beamforming / Core 0 + Core 1**

Frequency (MHz)	Antenna Polarity	Peak Level (dB $\mu$ V/m)	Limit (dB $\mu$ V/m)	Margin (dB)	Result
2400.0	Horizontal	51.3	94.1*	42.8	Complied
2483.5	Horizontal	54.0	74.0	20.0	Complied
2491.800	Horizontal	54.4	74.0	19.6	Complied

Frequency (MHz)	Antenna Polarity	Average Level (dB $\mu$ V/m)	Limit (dB $\mu$ V/m)	Margin (dB)	Result
2483.5	Horizontal	43.0	54.0	11.0	Complied

**Results: 2310 MHz to 2390 MHz Restricted Band / Peak / LE1M**

Frequency (MHz)	Antenna Polarity	Level (dB $\mu$ V/m)	Limit (dB $\mu$ V/m)	Margin (dB)	Result
2385.680	Horizontal	54.0	74.0	20.0	Complied

**Results: 2310 MHz to 2390 MHz Restricted Band / Average / LE1M**

Frequency (MHz)	Antenna Polarity	Level (dB $\mu$ V/m)	Limit (dB $\mu$ V/m)	Margin (dB)	Result
2389.040	Horizontal	41.6	54.0	12.4	Complied

**Transmitter Band Edge Radiated Emissions (continued)**

**Results: LE1M / Beamforming / Core 0 + Core 1**

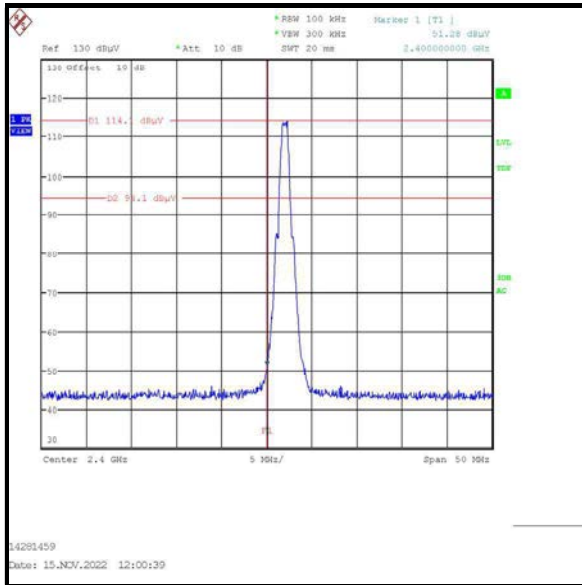

**Lower Band Edge**

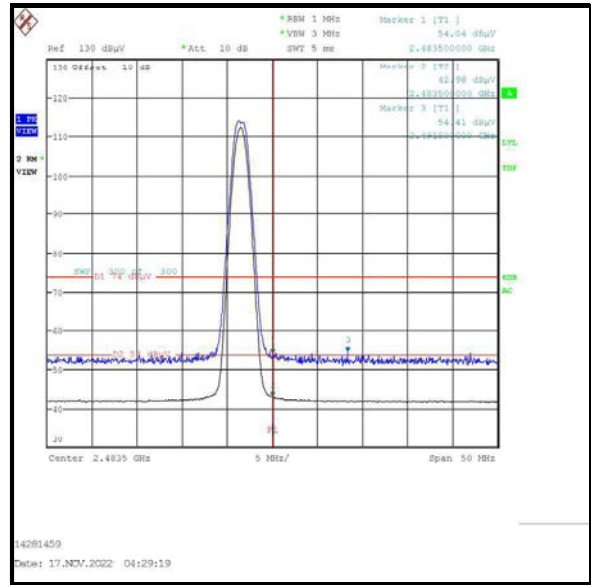

**Upper Band Edge**

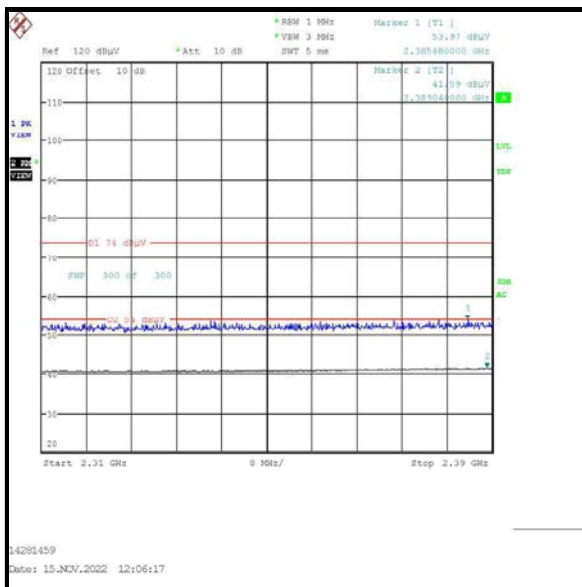

**2310 MHz to 2390 MHz Restricted Band**

**Transmitter Band Edge Radiated Emissions (continued)****Results: LE2M / Beamforming / Core 0 + Core 1**

Frequency (MHz)	Antenna Polarity	Peak Level (dB $\mu$ V/m)	Limit (dB $\mu$ V/m)	Margin (dB)	Result
2400.0	Horizontal	82.1	91.2*	9.1	Complied
2483.5	Horizontal	60.2	74.0	13.8	Complied

Frequency (MHz)	Antenna Polarity	Average Level (dB $\mu$ V/m)	Limit (dB $\mu$ V/m)	Margin (dB)	Result
2483.5	Horizontal	49.6	54.0	4.4	Complied

**Results: 2310 MHz to 2390 MHz Restricted Band / Peak**

Frequency (MHz)	Antenna Polarity	Level (dB $\mu$ V/m)	Limit (dB $\mu$ V/m)	Margin (dB)	Result
2366.640	Horizontal	53.6	74.0	20.4	Complied

**Results: 2310 MHz to 2390 MHz Restricted Band / Average**

Frequency (MHz)	Antenna Polarity	Level (dB $\mu$ V/m)	Limit (dB $\mu$ V/m)	Margin (dB)	Result
2387.600	Horizontal	41.6	54.0	12.4	Complied

**Transmitter Band Edge Radiated Emissions (continued)**

**Results: LE2M / Beamforming / Core 0 + Core 1**

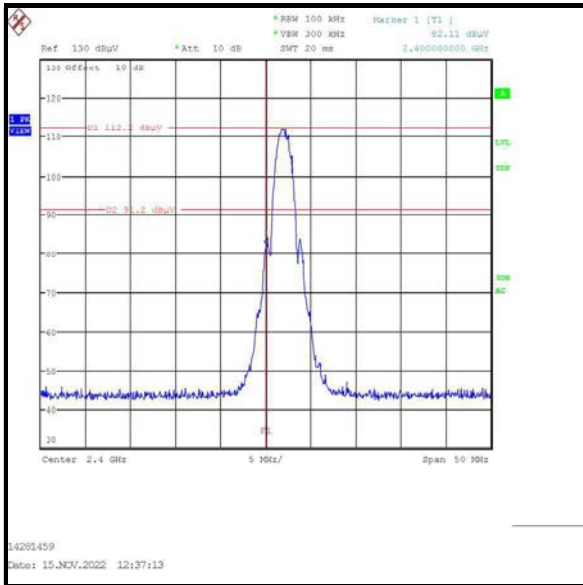

**Lower Band Edge**

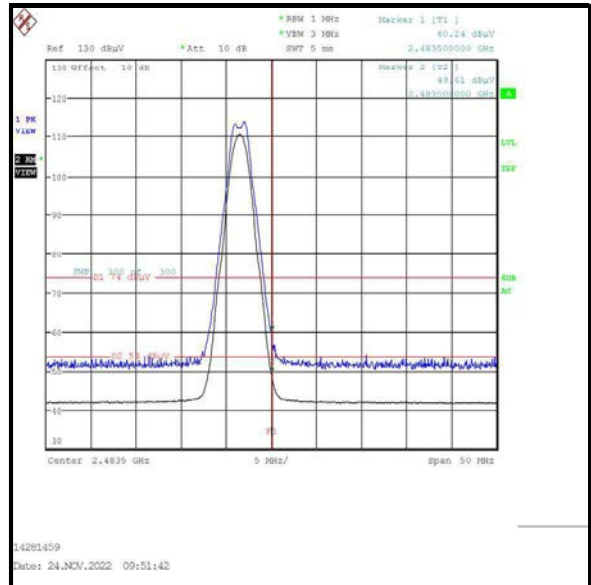

**Upper Band Edge**

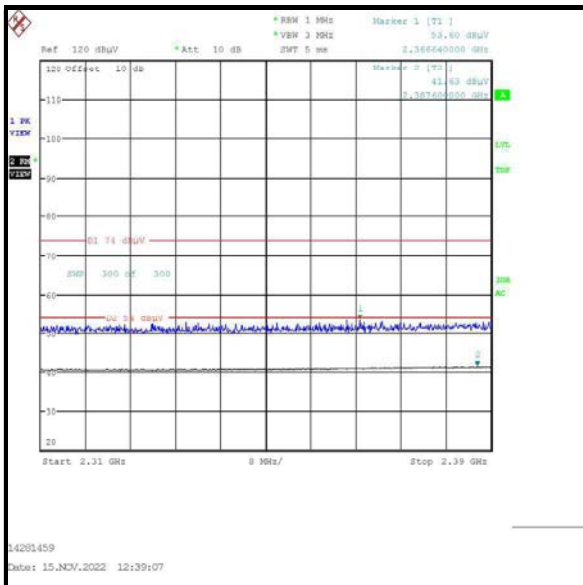

**2310 MHz to 2390 MHz Restricted Band**

**--- END OF REPORT ---**