

FCC and ISED Test Report

Apple Inc
Model: A2780

In accordance with FCC 47 CFR Part 15, ISED RSS-247, ISED RSS-248 and ISED RSS-GEN (2.4 GHz Bluetooth, 2.4 GHz WLAN, 5 GHz WLAN, 6 GHz WLAN and Narrowband)

Prepared for: Apple Inc
One Apple Park Way
Cupertino, California
95014, USA



Add value.
Inspire trust.

FCC ID: BCGA2780

IC: 579C-A2780

COMMERCIAL-IN-CONFIDENCE

Document 75955429-19 Issue 01

SIGNATURE

NAME	JOB TITLE	RESPONSIBLE FOR	ISSUE DATE
Steve Marshall	Senior Engineer	Authorised Signatory	21 November 2022

Signatures in this approval box have checked this document in line with the requirements of TÜV SÜD document control rules.

ENGINEERING STATEMENT

The measurements shown in this report were made in accordance with the procedures described on test pages. All reported testing was carried out on a sample equipment to demonstrate limited compliance with FCC 47 CFR Part 15, ISED RSS-247, ISED RSS-248 and ISED RSS-GEN. The sample tested was found to comply with the requirements defined in the applied rules.

RESPONSIBLE FOR	NAME	DATE	SIGNATURE
Report Generation	Hollie Marshall	21 November 2022	

FCC Accreditation
90987 Octagon House, Fareham Test Laboratory

ISED Accreditation
12669A Octagon House, Fareham Test Laboratory

EXECUTIVE SUMMARY

A sample of this product was tested and found to be compliant with FCC 47 CFR Part 15: 2020, ISED RSS-247: Issue 2 (2017-02), ISED RSS-248: Issue 1 (2021-11) and ISED RSS-GEN: Issue 5 (2018-04) + A2 (2021-02) for the tests detailed in section 1.3.



DISCLAIMER AND COPYRIGHT

This non-binding report has been prepared by TÜV SÜD with all reasonable skill and care. The document is confidential to the potential Client and TÜV SÜD. No part of this document may be reproduced without the prior written approval of TÜV SÜD. © 2022 TÜV SÜD. This report relates only to the actual item/items tested.

ACCREDITATION

Our UKAS Accreditation does not cover opinions and interpretations and any expressed are outside the scope of our UKAS Accreditation. Results of tests not covered by our UKAS Accreditation Schedule are marked NUA (Not UKAS Accredited).

TÜV SÜD
is a trading name of TÜV SÜD Ltd
Registered in Scotland at East Kilbride,
Glasgow G75 0QF, United Kingdom
Registered number: SC215164

TÜV SÜD Ltd is a
TÜV SÜD Group Company

Phone: +44 (0) 1489 558100
Fax: +44 (0) 1489 558101
www.tuvsud.com/en

TÜV SÜD
Octagon House
Concorde Way
Fareham
Hampshire PO15 5RL
United Kingdom



Contents

1	Report Summary	2
1.1	Report Modification Record.....	2
1.2	Introduction.....	2
1.3	Brief Summary of Results	3
1.4	Product Information	4
1.5	Deviations from the Standard.....	4
1.6	EUT Modification Record	4
1.7	Test Location	4
2	Test Details	5
2.1	Radiated Spurious Emissions (Simultaneous Transmission)	5
3	Measurement Uncertainty	43



1 Report Summary

1.1 Report Modification Record

Alterations and additions to this report will be issued to the holders of each copy in the form of a complete document.

Issue	Description of Change	Date of Issue
1	First Issue	21-November-2022

Table 1

1.2 Introduction

Applicant	Apple Inc
Manufacturer	Apple Inc
Model Number(s)	A2780
Serial Number(s)	FWC3JLYYHC
Hardware Version(s)	REV 1.0
Software Version(s)	22A31991j
Number of Samples Tested	1
Test Specification/Issue/Date	FCC 47 CFR Part 15: 2020 ISED RSS-247: Issue 2 (2017-02) ISED RSS-248: Issue 1 (2021-11) ISED RSS-GEN: Issue 5 (2018-04) + A2 (2021-02)
Order Number	0540246998
Start of Test	25-September-2022
Finish of Test	13-October-2022
Name of Engineer(s)	Ioan-Alexandru Bogatu and Nicolae Mihailiuc
Related Document(s)	ANSI C63.26: 2015 ANSI C63.10: 2013 ANSI C63.10: 2020 KDB 987594 D02 v01r01



1.3 Brief Summary of Results

A brief summary of the tests carried out in accordance with FCC 47 CFR Part 15, ISED RSS-247, ISED RSS-248 and ISED RSS-GEN is shown below.

Section	Specification Clause				Test Description	Result	Comments/Base Standard
	Part 15	RSS-247	RSS-248	RSS-GEN			
Configuration and Mode: CoTX - Bluetooth + 5 GHz WLAN							
2.1	15.209, 15.247(d) and 15.407(b)	5.5 and 6.2	-	8.9	Radiated Spurious Emissions (Simultaneous Transmission)	Pass	
Configuration and Mode: CoTX - 2.4 GHz WLAN + Narrowband							
2.1	15.209, 15.247(d) and 15.407(b)	5.5 and 6.2	-	8.9	Radiated Spurious Emissions (Simultaneous Transmission)	Pass	
Configuration and Mode: CoTX - 2.4 GHz Bluetooth + 6 GHz WLAN							
2.1	15.209, 15.247(d) and 15.407(b)	5.5	4.7	8.9	Radiated Spurious Emissions (Simultaneous Transmission)	Pass	

Table 2



1.4 Product Information

1.4.1 Technical Description

The equipment under test was an Apple laptop computer with Bluetooth® and IEEE 802.11 a/b/g/n/ac/ax Wi-Fi capabilities in the 2.4GHz, 5GHz and 6GHz bands.

1.5 Deviations from the Standard

No deviations from the applicable test standard were made during testing.

1.6 EUT Modification Record

The table below details modifications made to the EUT during the test programme.

The modifications incorporated during each test are recorded on the appropriate test pages.

Modification State	Description of Modification still fitted to EUT	Modification Fitted By	Date Modification Fitted
Model: A2780, Serial Number: FWC3JLYYHC			
0	As supplied by the customer	Not Applicable	Not Applicable

Table 3

1.7 Test Location

TÜV SÜD conducted the following tests at our Concorde Park Test Laboratory.

Test Name	Name of Engineer(s)	Accreditation
Configuration and Mode: CoTX - Bluetooth + 5 GHz WLAN		
Radiated Spurious Emissions (Simultaneous Transmission)	Ioan-Alexandru Bogatu and Nicolae Mihailiuc	UKAS
Configuration and Mode: CoTX - Bluetooth + 6 GHz WLAN		
Radiated Spurious Emissions (Simultaneous Transmission)	Ioan-Alexandru Bogatu	UKAS
Configuration and Mode: CoTX - 2.4 GHz WLAN + Narrowband		
Radiated Spurious Emissions (Simultaneous Transmission)	Ioan-Alexandru Bogatu	UKAS

Table 4

Office Address:

TÜV SÜD
 Concorde Park
 Concorde Way
 Fareham
 Hampshire
 PO15 5FG
 United Kingdom



2 Test Details

2.1 Radiated Spurious Emissions (Simultaneous Transmission)

2.1.1 Specification Reference

FCC 47 CFR Part 15, Clause 15.209, 15.247(d) and 15.407(b)
ISED RSS-247, Clause 5.5 and 6.2
ISED RSS-248, Clause 4.7
ISED RSS-GEN, Clause 8.9

2.1.2 Equipment Under Test and Modification State

A2780, S/N: FWC3JLYYHC - Modification State 0

2.1.3 Date of Test

25-September-2022 to 13-October-2022

2.1.4 Test Method

CoTX - 2.4 GHz WLAN + Narrowband and CoTX - Bluetooth + 5 GHz WLAN

This test was performed in accordance with ANSI C63.10, clause 6.3, 6.5 and 6.6.

The EUT was placed on the non-conducting platform in a manner typical of a normal installation.

Ports on the EUT were terminated with loads as described in ANSI C63.4 clause 6.2.4 for each type of port on the EUT.

For frequencies > 1 GHz, plots for average measurements were taken in accordance with ANSI C63.10, clause 4.1.4.2.5 to characterize the EUT. Where emissions were detected, final average measurements were taken in accordance with ANSI C63.10, clause 4.1.4.2.2, 11.11, 11.12, 12.7.2 or 12.7.3 depending on the nature of the emission measured.

The plots shown are the characterisation of the EUT. The limits on the plots represent the most stringent case for restricted bands, (74/54 dBuV/m) when compared to non-restricted band limits. The limits shown have been used as a threshold to determine where further measurements are necessary. Where results are within 10 dB of the limits shown on the plots, further investigation was carried out and reported in results tables.

The following conversion can be applied to convert from dB μ V/m to μ V/m:
 $10^{(\text{Field Strength in dB}\mu\text{V/m}/20)}$.

At a measurement distance of 1 meter the limit line was increased by $20 \cdot \text{LOG}(3/1) = 9.54$ dB.



CoTX – 2.4 GHz Bluetooth + 6 GHz WLAN

Testing was performed in accordance with KDB 987594 D02 and ANSI C63.10, clause 6.3, 6.5 and 6.6.

The EUT was placed on the non-conducting platform in a manner typical of a normal installation. Ports on the EUT were terminated with loads as described in ANSI C63.4 clause 6.2.4 for each type of port on the EUT.

For frequencies > 1 GHz, plots for average measurements were taken in accordance with ANSI C63.10, clause 4.1.4.2.5 to characterize the EUT. Where emissions were detected, final average measurements were taken in accordance with ANSI C63.10, clause 4.1.4.2.2, 11.11, 11.12, 12.7.2 or 12.7.3 depending on the nature of the emission measured.

The plots shown are the characterisation of the EUT. The limits on the plots represent the most stringent case for restricted bands, (74/54 dBuV/m) when compared to non-restricted band limits. The limits shown have been used as a threshold to determine where further measurements are necessary. Where results are within 10 dB of the limits shown on the plots, further investigation was carried out and reported in results tables.

The following conversion can be applied to convert from dBuV/m to uV/m:
 $10^{(\text{Field Strength in dBuV/m}/20)}$

At a measurement distance of 1 meter the limit line was increased by $20 \cdot \text{LOG}(3/1) = 9.54$ dB.

2.1.5 Test Setup Diagram

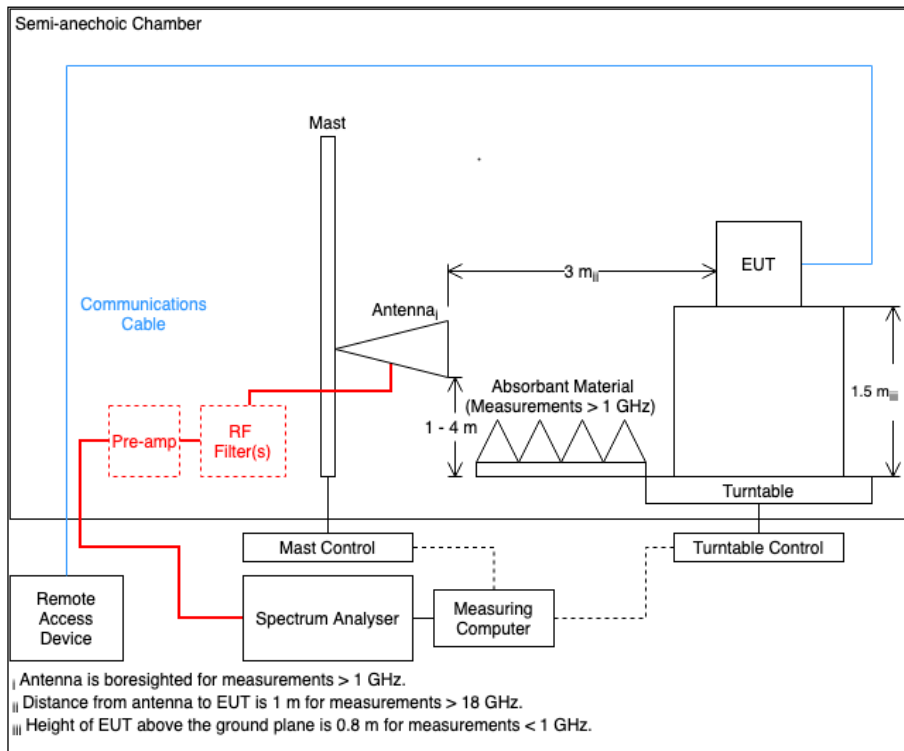

Figure 1

2.1.6 Environmental Conditions

Ambient Temperature 21.2 - 23.0 °C
Relative Humidity 43.0 - 51.2 %



2.1.7 Test Results

CoTX - Bluetooth + 5 GHz WLAN

Frequency (MHz)	Level (dBuV/m)	Limit (dBuV/m)	Margin (dB)	Detector	Angle (°)	Height (cm)	Polarisation
279.994	27.12	46.00	-18.88	Q-Peak	92	106	Horizontal
280.000	24.55	46.00	-21.45	Q-Peak	4	162	Vertical
15565.305	32.18	54.00	-21.82	RMS	171	103	Vertical

Table 5 - U-NII-1 – 5200 MHz (CH40), VHT20, CDD, Core 0 + Core 1 and 2402 MHz (CH0), 2DH5, ePA, Core 0 + Core 1, 30 MHz to 40 GHz

No other emissions found within 10 dB of the limit.

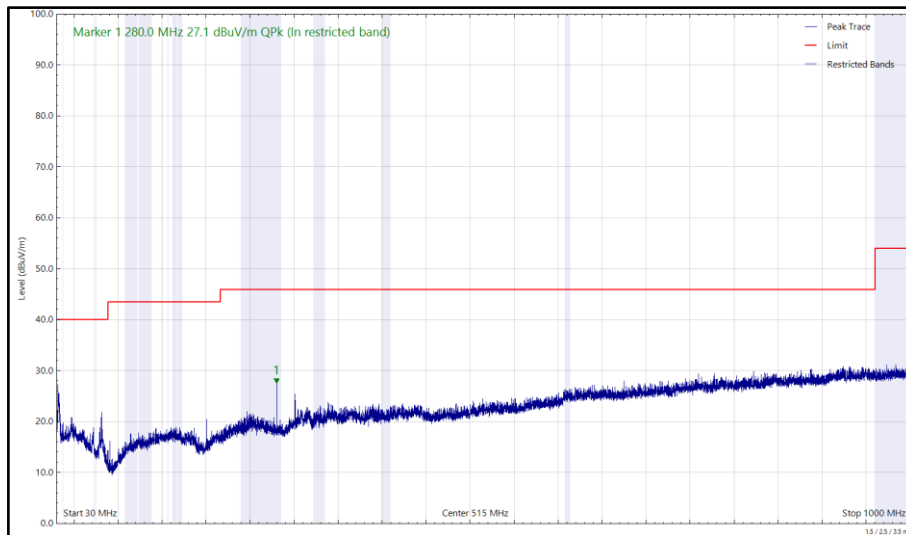

Figure 2 - U-NII-1 – 5200 MHz (CH40), VHT20, CDD, Core 0 + Core 1 and 2402 MHz (CH0), 2DH5, ePA, Core 0 + Core 1, 30 MHz to 1 GHz, Horizontal (Peak)

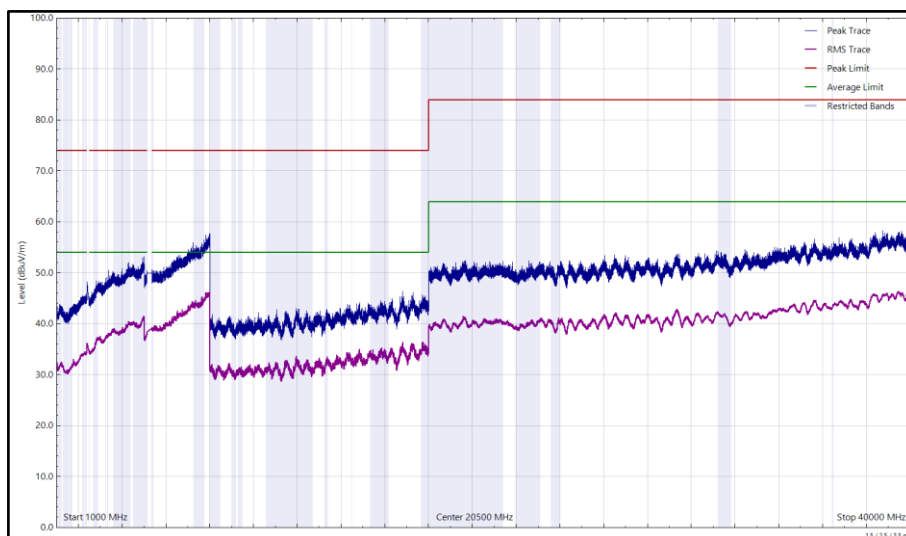

Figure 3 - U-NII-1 – 5200 MHz (CH40), VHT20, CDD, Core 0 + Core 1 and 2402 MHz (CH0), 2DH5, ePA, Core 0 + Core 1, 1 GHz to 40 GHz, Horizontal

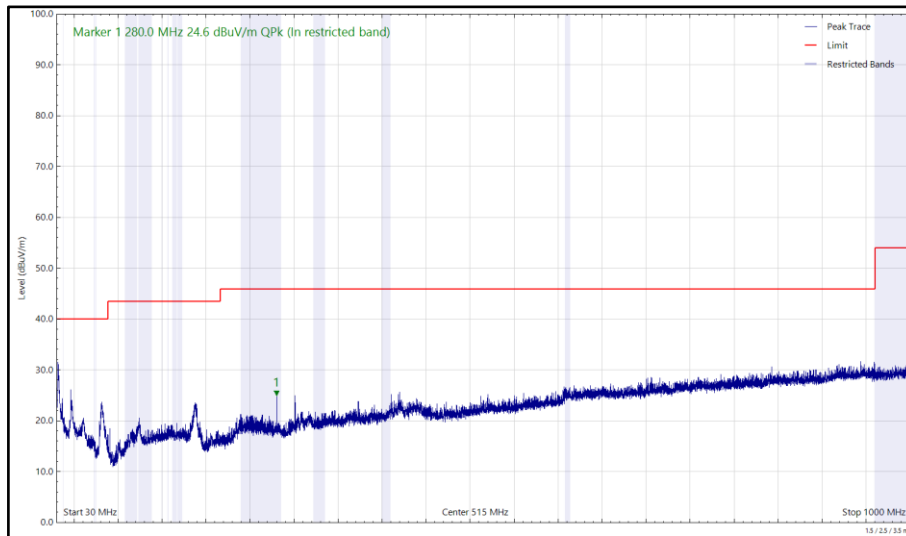

Figure 4 - U-NII-1 - 5200 MHz (CH40), VHT20, CDD, Core 0 + Core 1 and 2402 MHz (CH0), 2DH5, ePA, Core 0 + Core 1, 30 MHz to 1 GHz, Vertical (Peak)

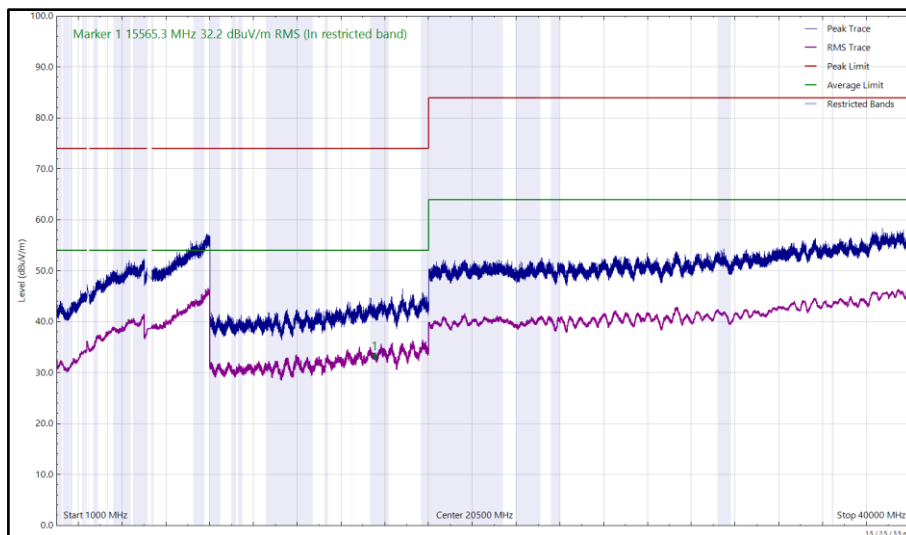

Figure 5 - U-NII-1 – 5200 MHz (CH40), VHT20, CDD, Core 0 + Core 1 and 2402 MHz (CH0), 2DH5, ePA, Core 0 + Core 1, 1 GHz to 40 GHz, Vertical



Frequency (MHz)	Level (dBuV/m)	Limit (dBuV/m)	Margin (dB)	Detector	Angle (°)	Height (cm)	Polarisation
279.986	24.92	46.00	-21.08	Q-Peak	359	172	Vertical
279.990	26.71	46.00	-19.29	Q-Peak	84	119	Horizontal

Table 6 - U-NII-2C – 5680 MHz (CH136), VHT20, CDD, Core 0 + Core 1 and 2480 MHz (CH78), 2DH5, ePA, Core 0 + Core 1, 30 MHz to 40 GHz

No other emissions found within 10 dB of the limit.

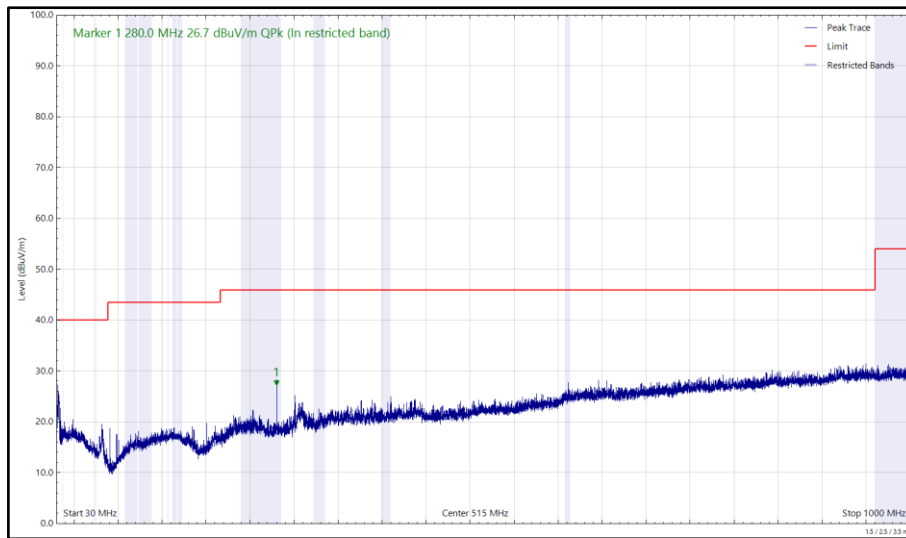

Figure 6 - U-NII-2C - 5680 MHz (CH136), VHT20, CDD, Core 0 + Core 1 and 2480 MHz (CH78), 2DH5, ePA, Core 0 + Core 1, 30 MHz to 1 GHz, Horizontal (Peak)

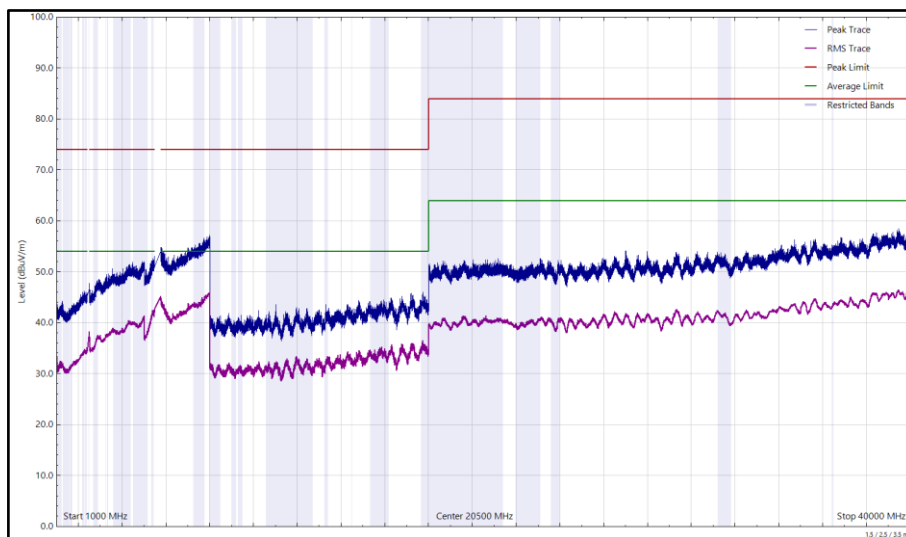

Figure 7 - U-NII-2C - 5680 MHz (CH136), VHT20, CDD, Core 0 + Core 1 and 2480 MHz (CH78), 2DH5, ePA, Core 0 + Core 1, 1 GHz to 40 GHz, Horizontal

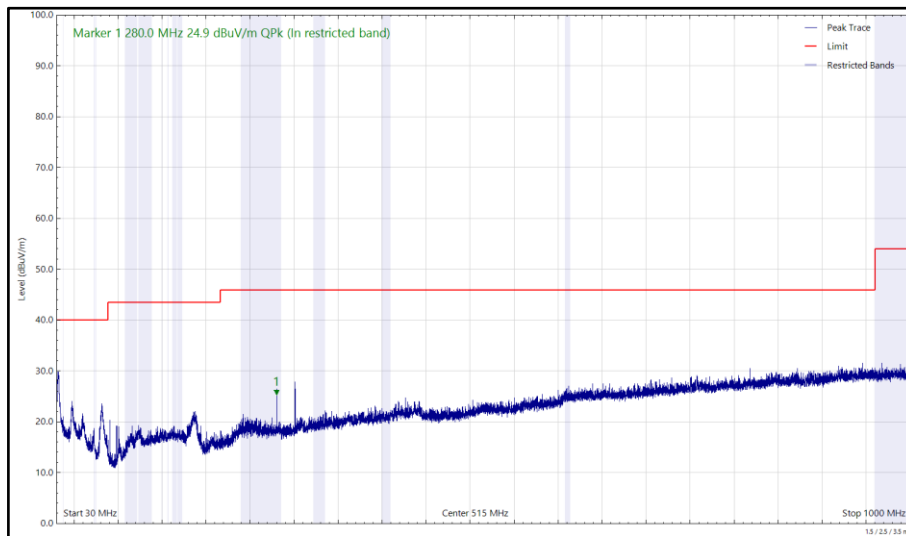

Figure 8 - U-NII-2C – 5680 MHz (CH136), VHT20, CDD, Core 0 + Core 1 and 2480 MHz (CH78), 2DH5, ePA, Core 0 + Core 1, 30 MHz to 1 GHz, Vertical (Peak)

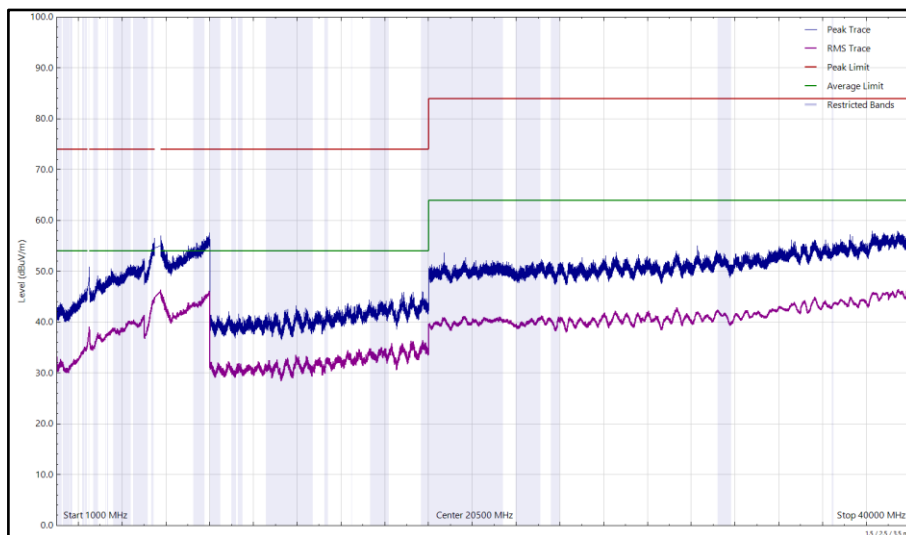

Figure 9 - U-NII-2C - 5680 MHz (CH136), VHT20, CDD, Core 0 + Core 1 and 2480 MHz (CH78), 2DH5, ePA, Core 0 + Core 1, 1 GHz to 40 GHz, Vertical



Frequency (MHz)	Level (dBuV/m)	Limit (dBuV/m)	Margin (dB)	Detector	Angle (°)	Height (cm)	Polarisation
279.992	26.77	46.00	-19.23	Q-Peak	73	100	Horizontal
280.005	25.04	46.00	-20.96	Q-Peak	350	153	Vertical

Table 7 - U-NII-1 – 5200 MHz (CH40), VHT20, CDD, Core 0 + Core 1 and 2480 MHz (CH78), 2DH5, ePA, Core 0 + Core 1, 30 MHz to 40 GHz

No other emissions found within 10 dB of the limit.

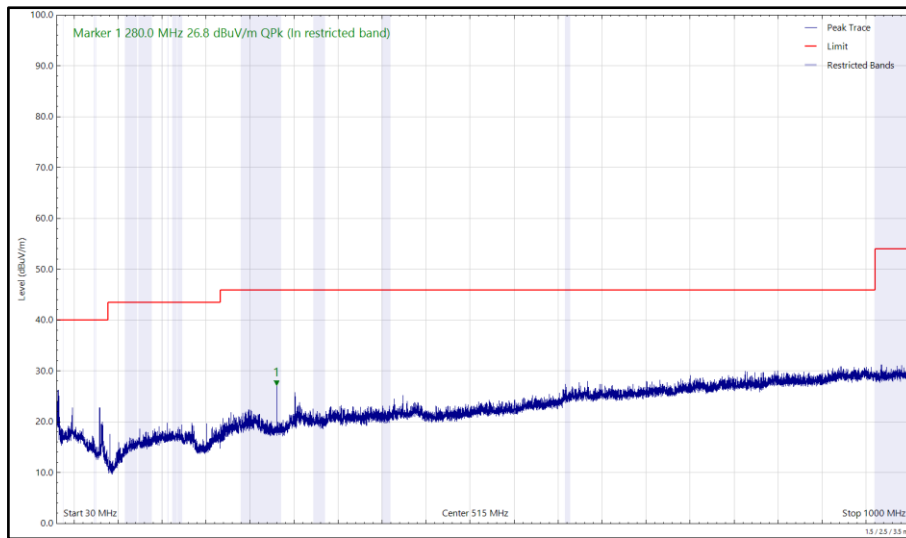

Figure 10 - U-NII-1 - 5200 MHz (CH40), VHT20, CDD, Core 0 + Core 1 and 2480 MHz (CH78), 2DH5, ePA, Core 0 + Core 1, 30 MHz to 1 GHz, Horizontal (Peak)

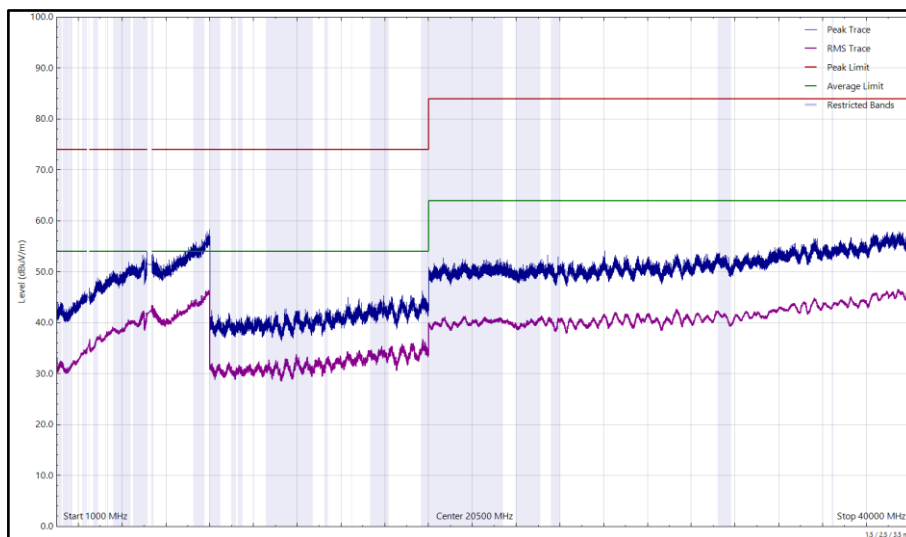

Figure 11 - U-NII-1 - 5200 MHz (CH40), VHT20, CDD, Core 0 + Core 1 and 2480 MHz (CH78), 2DH5, ePA, Core 0 + Core 1, 1 GHz to 40 GHz, Horizontal

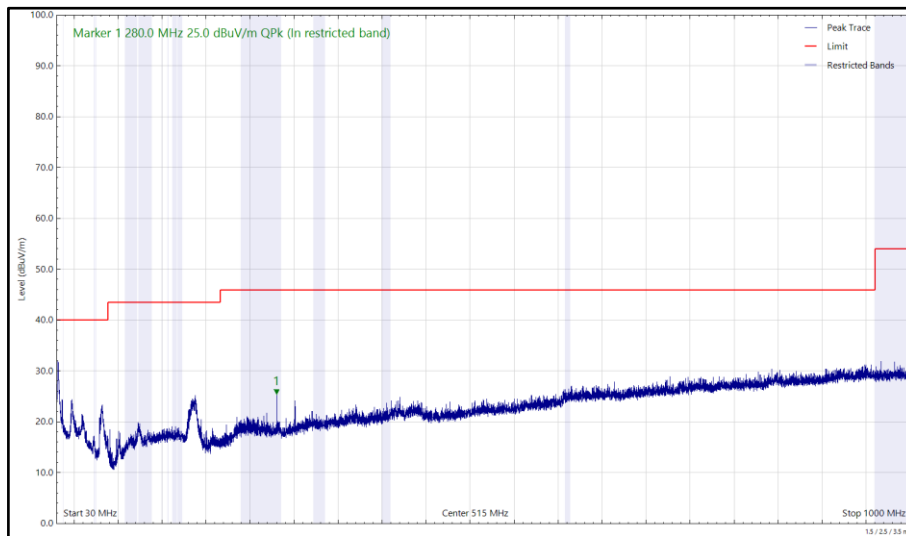

Figure 12 - U-NII-1 - 5200 MHz (CH40), VHT20, CDD, Core 0 + Core 1 and 2480 MHz (CH78), 2DH5, ePA, Core 0 + Core 1, 30 MHz to 1 GHz, Vertical (Peak)

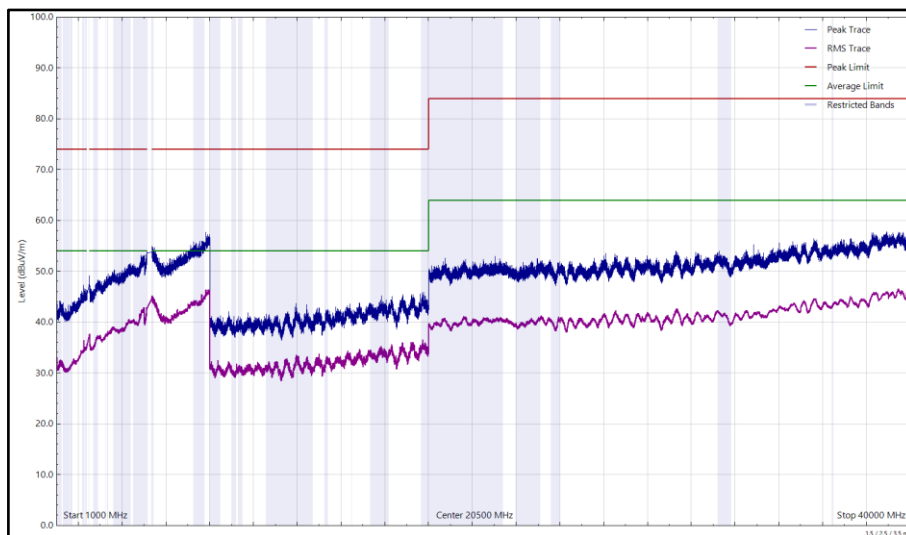

Figure 13 - U-NII-1 - 5200 MHz (CH40), VHT20, CDD, Core 0 + Core 1 and 2480 MHz (CH78), 2DH5, ePA, Core 0 + Core 1, 1 GHz to 40 GHz, Vertical



Frequency (MHz)	Level (dBuV/m)	Limit (dBuV/m)	Margin (dB)	Detector	Angle (°)	Height (cm)	Polarisation
279.993	26.51	46.00	-19.49	Q-Peak	63	112	Horizontal
280.000	24.78	46.00	-21.22	Q-Peak	350	187	Vertical

Table 8 - U-NII-2C - 5680 MHz (CH136), VHT20, CDD, Core 0 + Core 1 and 2402 MHz (CH0), 2DH5, ePA, Core 0 + Core 1, 30 MHz to 40 GHz

No other emissions found within 10 dB of the limit.

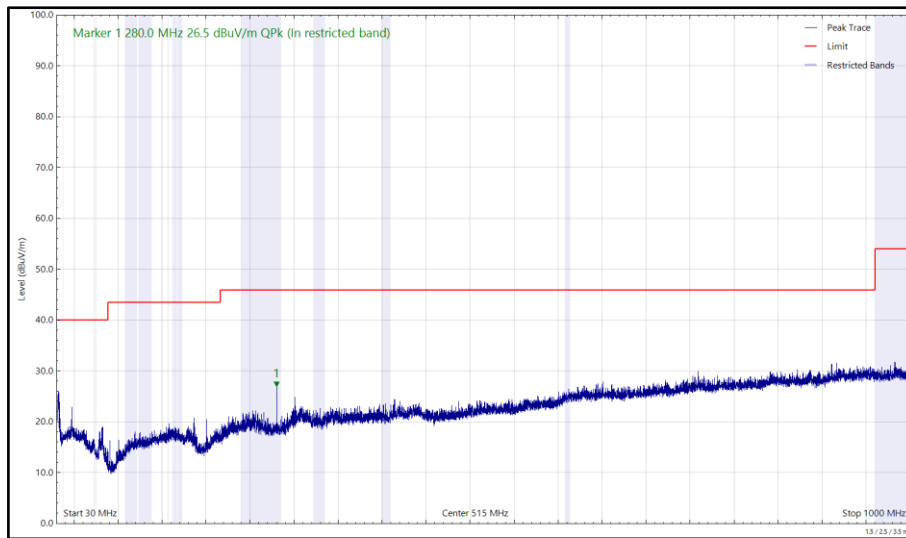

Figure 14 - U-NII-2C - 5680 MHz (CH136), VHT20, CDD, Core 0 + Core 1 and 2402 MHz (CH0), 2DH5, ePA, Core 0 + Core 1, 30 MHz to 1 GHz, Horizontal (Peak)

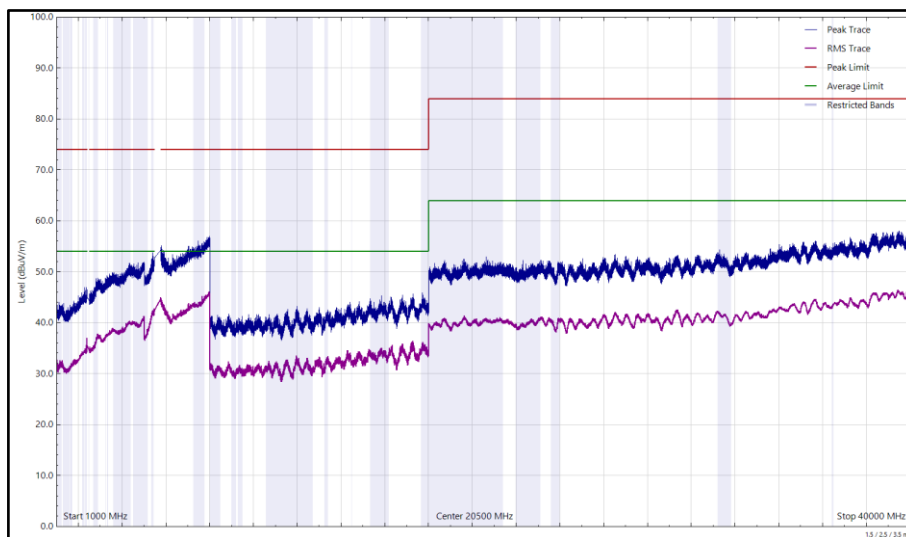

Figure 15 - U-NII-2C - 5680 MHz (CH136), VHT20, CDD, Core 0 + Core 1 and 2402 MHz (CH0), 2DH5, ePA, Core 0 + Core 1, 1 GHz to 40 GHz, Horizontal

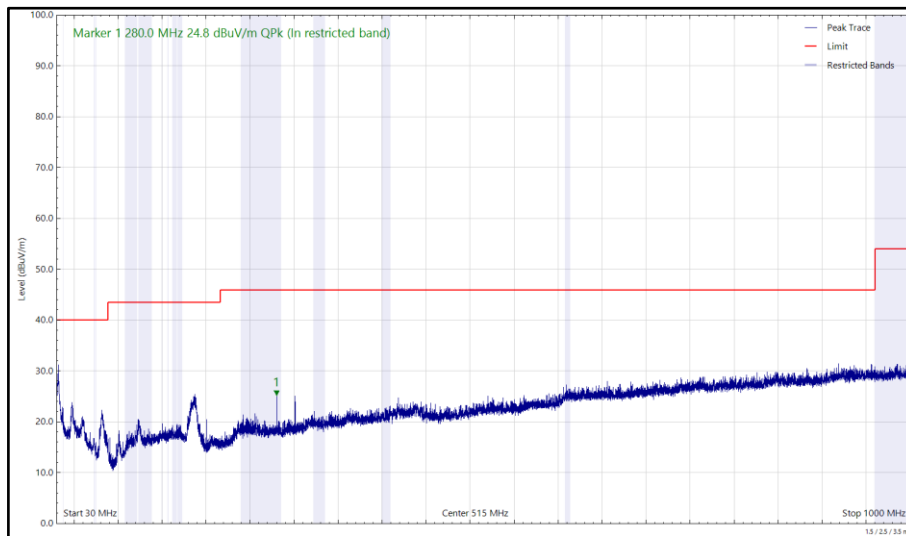

Figure 16 - U-NII-2C - 5680 MHz (CH136), VHT20, CDD, Core 0 + Core 1 and 2402 MHz (CH0), 2DH5, ePA, Core 0 + Core 1, 30 MHz to 1 GHz, Vertical (Peak)

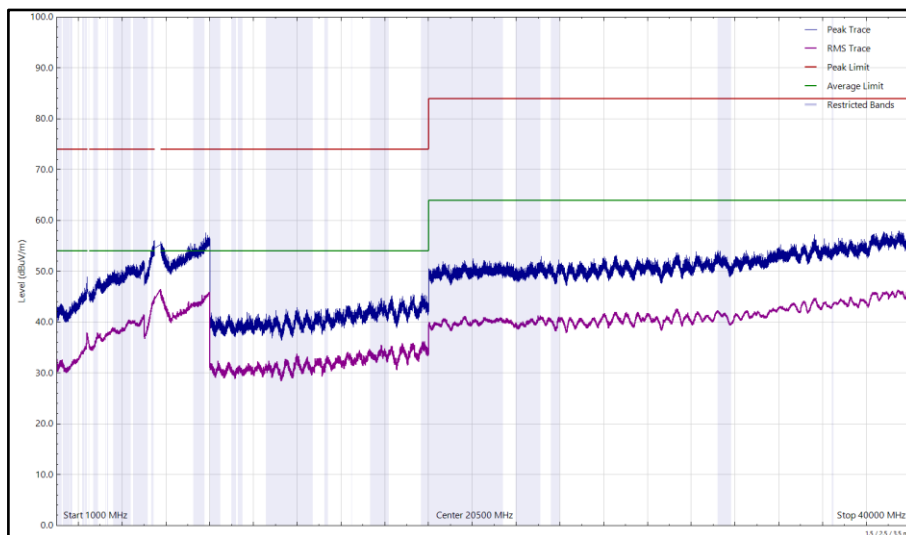

Figure 17 - U-NII-2C – 5680 MHz (CH136), VHT20, CDD, Core 0 + Core 1 and 2402 MHz (CH0), 2DH5, ePA, Core 0 + Core 1, 1 GHz to 40 GHz, Vertical

FCC 47 CFR Part 15, ISED RSS-247 and ISED RSS-GEN

The least stringent limit from the applicable rule parts was used to determine compliance for Radiated Emissions testing of multiple transmission sources.

The least stringent applicable limit was:

Clause	Limit
Part 15.247 (d) / RSS-247 Clause 5.5	-20 dBc
Part 15.407 (b) / RSS-247 Clause 6.2	-27 dBm (EIRP) / 68 dB μ V/m at 3m.
Part 15.209 / RSS-GEN Clause 8.9	Peak: 74 dB μ V/m at 3m, Average 54 dB μ V/m at 3m

Table 9



CoTX – 2.4 GHz Bluetooth + 6 GHz WLAN

Frequency (MHz)	Level (dBuV/m)	Limit (dBuV/m)	Margin (dB)	Detector	Angle (°)	Height (cm)	Polarisation
279.991	25.90	46.00	-20.10	Q-Peak	81	123	Horizontal
280.015	24.03	46.00	-21.97	Q-Peak	350	174	Vertical

Table 10 - U-NII-5 - 5955 MHz (CH1), HE20, SU, CDD, Core 0 + Core 1 and 2402 MHz (CH0), 2-DH5, ePA, Core 0 + Core 1, 30 MHz to 40 GHz

No other emissions found within 10 dB of the limit.

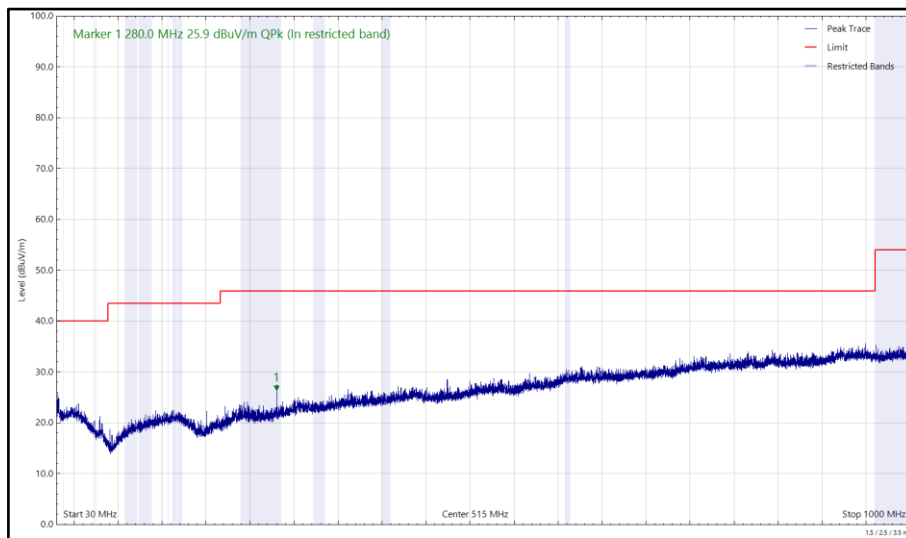

Figure 18 - U-NII-5 - 5955 MHz (CH1), HE20, SU, CDD, Core 0 + Core 1 and 2402 MHz (CH0), 2-DH5, ePA, Core 0 + Core 1, 30 MHz to 1 GHz, Horizontal (Peak)

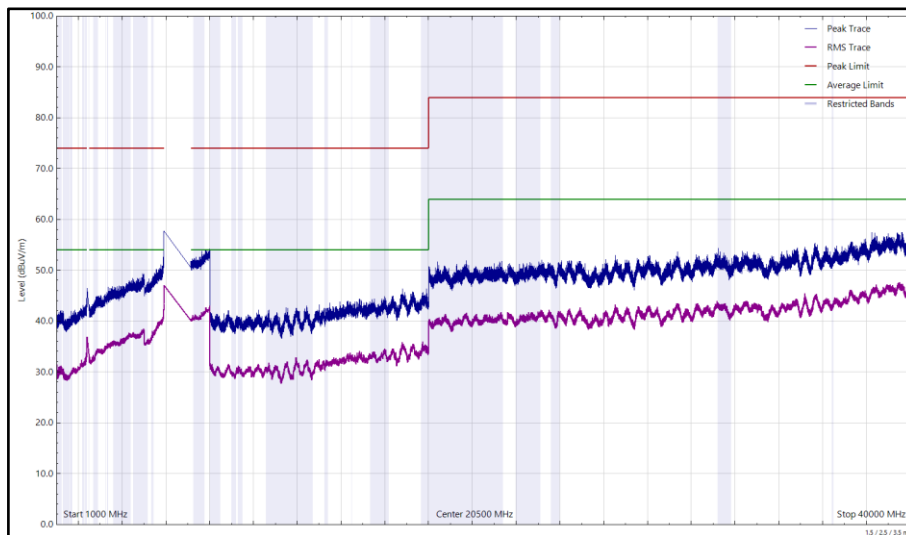

Figure 19 - U-NII-5 - 5955 MHz (CH1), HE20, SU, CDD, Core 0 + Core 1 and 2402 MHz (CH0), 2-DH5, ePA, Core 0 + Core 1, 1 GHz to 40 GHz, Horizontal

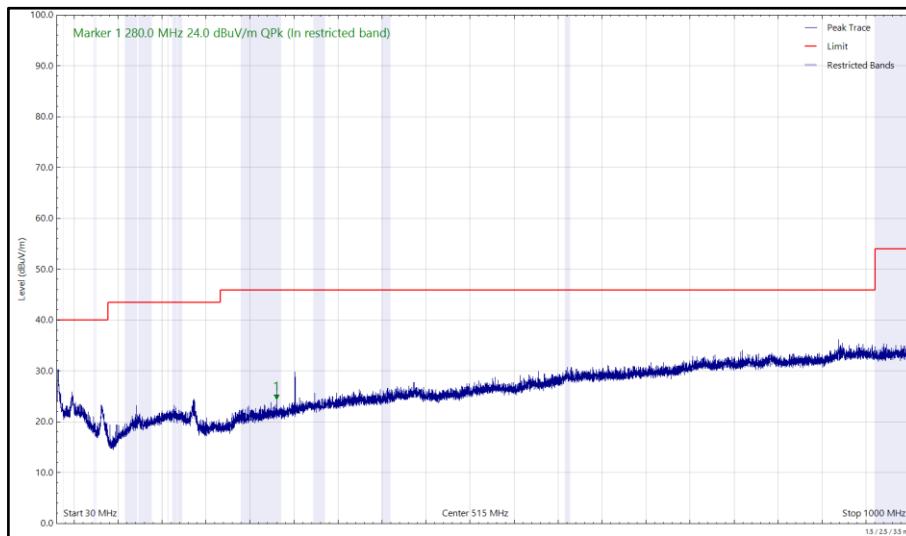

Figure 20 - U-NII-5 - 5955 MHz (CH1), HE20, SU, CDD, Core 0 + Core 1 and 2402 MHz (CH0), 2-DH5, ePA, Core 0 + Core 1, 30 MHz to 1 GHz, Vertical (Peak)

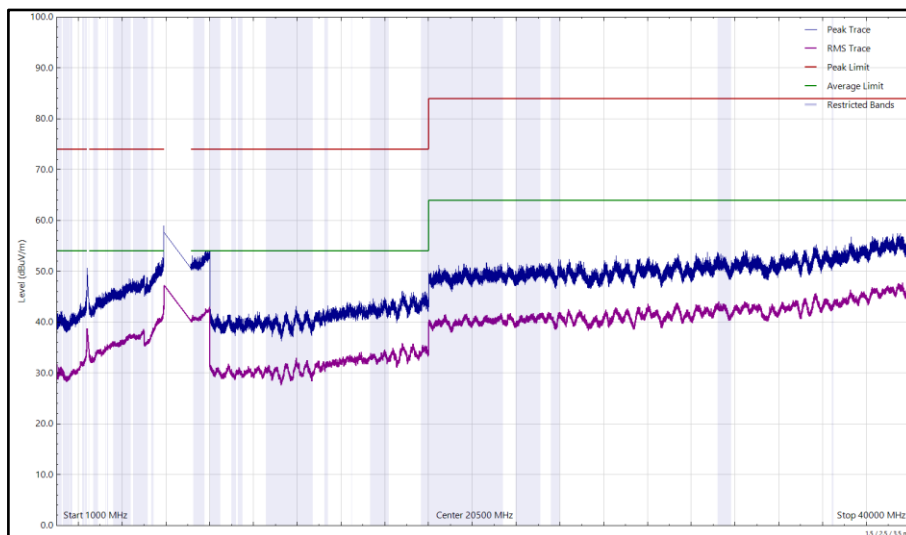

Figure 21 - U-NII-5 - 5955 MHz (CH1), HE20, SU, CDD, Core 0 + Core 1 and 2402 MHz (CH0), 2-DH5, ePA, Core 0 + Core 1, 1 GHz to 40 GHz, Vertical



Frequency (MHz)	Level (dBuV/m)	Limit (dBuV/m)	Margin (dB)	Detector	Angle (°)	Height (cm)	Polarisation
279.990	24.35	46.00	-21.65	Q-Peak	354	168	Vertical
280.004	26.29	46.00	-19.71	Q-Peak	79	111	Horizontal
5337.153	57.81	74.00	-16.19	Peak	355	273	Vertical

Table 11 - U-NII-8 - 7115 MHz (CH233), HE20, SU, CDD, Core 0 + Core 1 and 2402 MHz (CH0), 2-DH5, ePA, Core 0 + Core 1, 30 MHz to 40 GHz

No other emissions found within 10 dB of the limit.

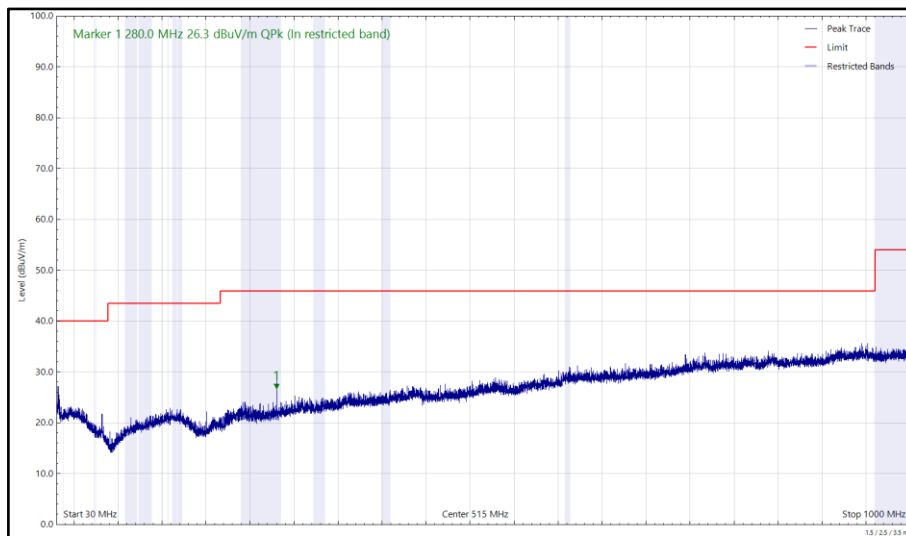

Figure 22 - U-NII-8 - 7115 MHz (CH233), HE20, SU, CDD, Core 0 + Core 1 and 2402 MHz (CH0), 2-DH5, ePA, Core 0 + Core 1, 30 MHz to 1 GHz, Horizontal (Peak)

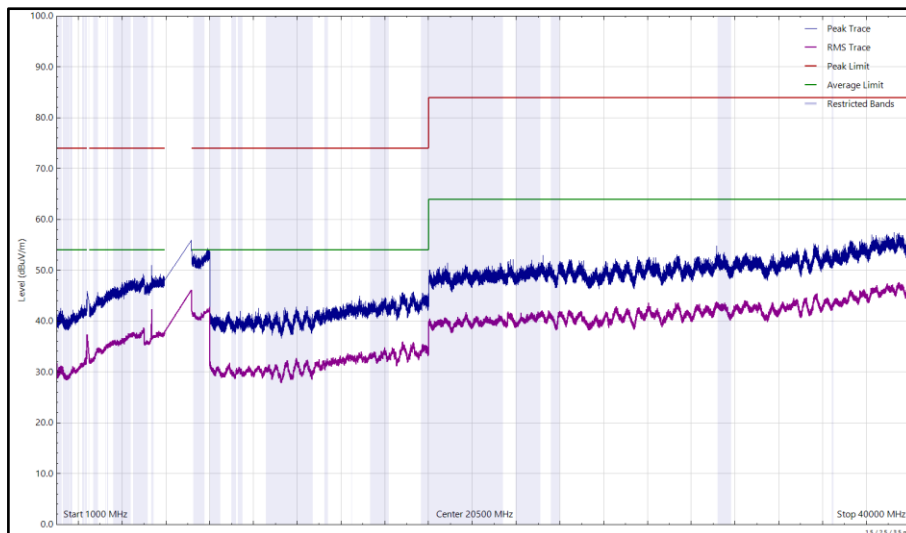

Figure 23 - U-NII-8 - 7115 MHz (CH233), HE20, SU, CDD, Core 0 + Core 1 and 2402 MHz (CH0), 2-DH5, ePA, Core 0 + Core 1, 1 GHz to 40 GHz, Horizontal

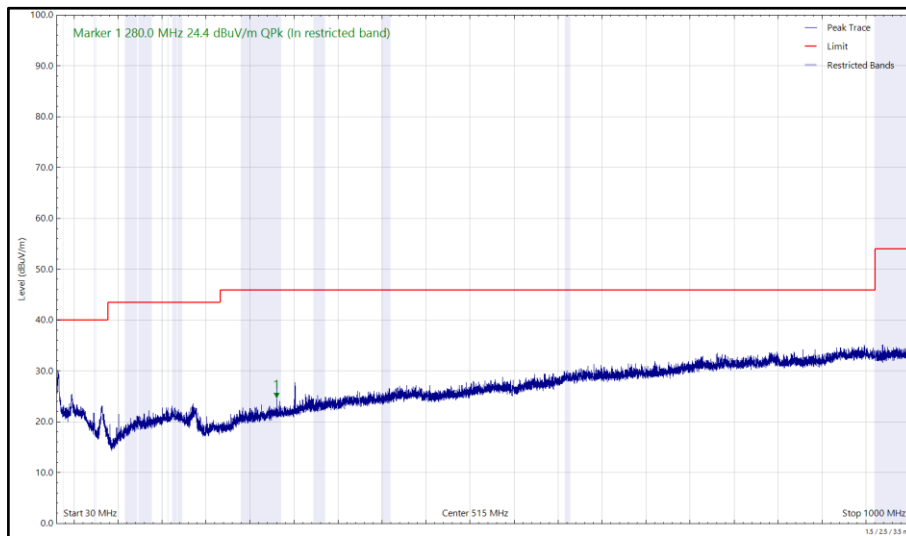

Figure 24 - U-NII-8 - 7115 MHz (CH233), HE20, SU, CDD, Core 0 + Core 1 and 2402 MHz (CH0), 2-DH5, ePA, Core 0 + Core 1, 30 MHz to 1 GHz, Vertical (Peak)

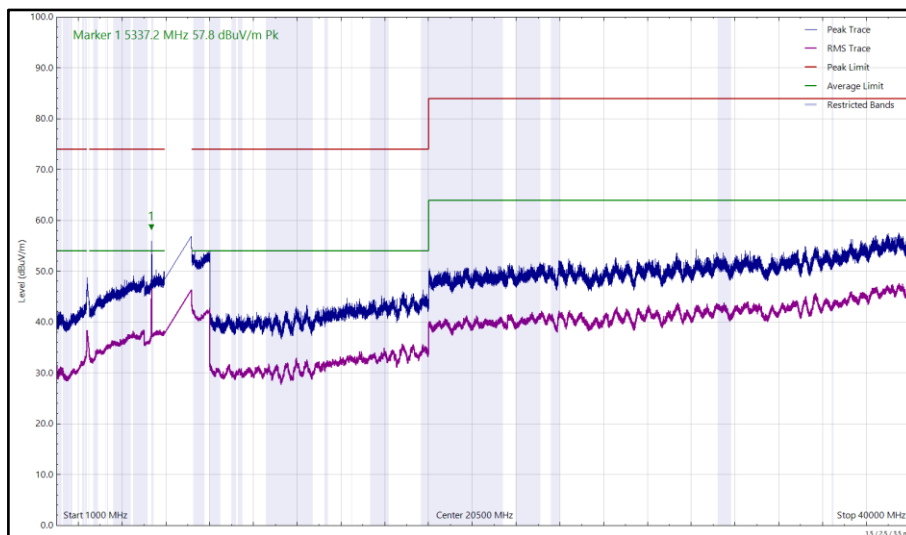

Figure 25 - U-NII-8 - 7115 MHz (CH233), HE20, SU, CDD, Core 0 + Core 1 and 2402 MHz (CH0), 2-DH5, ePA, Core 0 + Core 1, 1 GHz to 40 GHz, Vertical



Frequency (MHz)	Level (dBuV/m)	Limit (dBuV/m)	Margin (dB)	Detector	Angle (°)	Height (cm)	Polarisation
280.001	26.10	46.00	-19.90	Q-Peak	83	119	Horizontal
280.025	22.97	46.00	-23.03	Q-Peak	360	146	Vertical

Table 12 - U-NII-5 – 5955 MHz (CH1), HE20, SU, CDD, Core 0 + Core 1 and 2480 MHz MHz (CH78), 2-DH5, ePA, Core 0 + Core 1, 30 MHz to 40 GHz

No other emissions found within 10 dB of the limit.

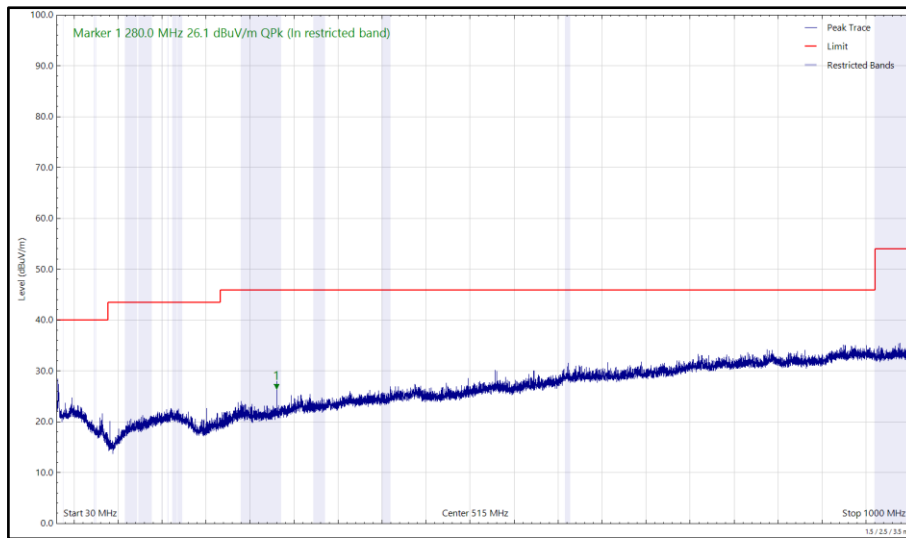

Figure 26 - U-NII-5 - 5955 MHz (CH1), HE20, SU, CDD, Core 0 + Core 1 and 2480 MHz MHz (CH78), 2-DH5, ePA, Core 0 + Core 1, 30 MHz to 1 GHz, Horizontal (Peak)

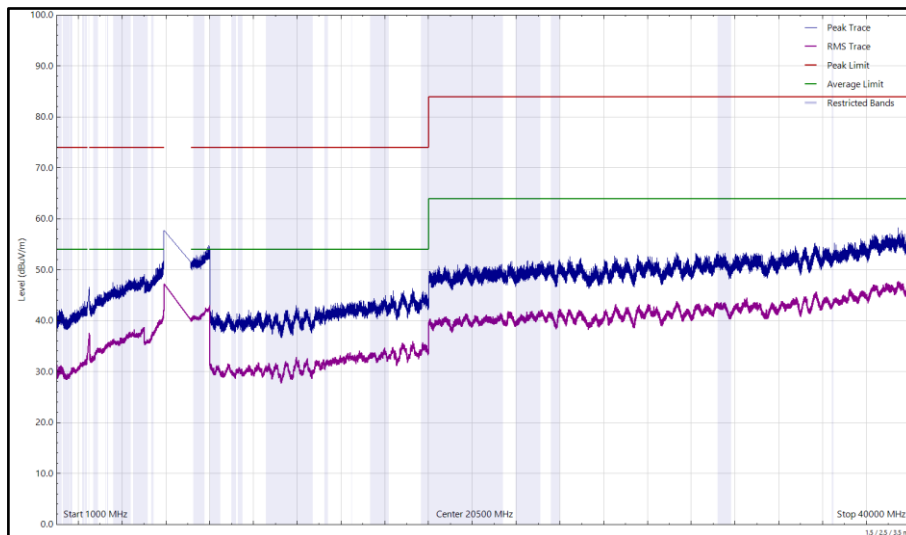

Figure 27 - U-NII-5 - 5955 MHz (CH1), HE20, SU, CDD, Core 0 + Core 1 and 2480 MHz MHz (CH78), 2-DH5, ePA, Core 0 + Core 1, 1 GHz to 40 GHz, Horizontal

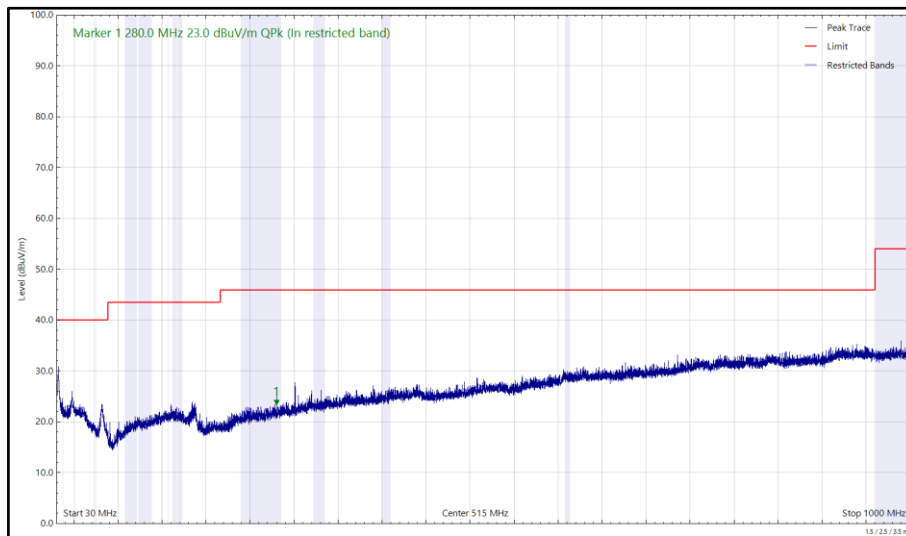

Figure 28 - U-NII-5 - 5955 MHz (CH1), HE20, SU, CDD, Core 0 + Core 1 and 2480 MHz (CH78), 2-DH5, ePA, Core 0 + Core 1, 30 MHz to 1 GHz, Vertical (Peak)

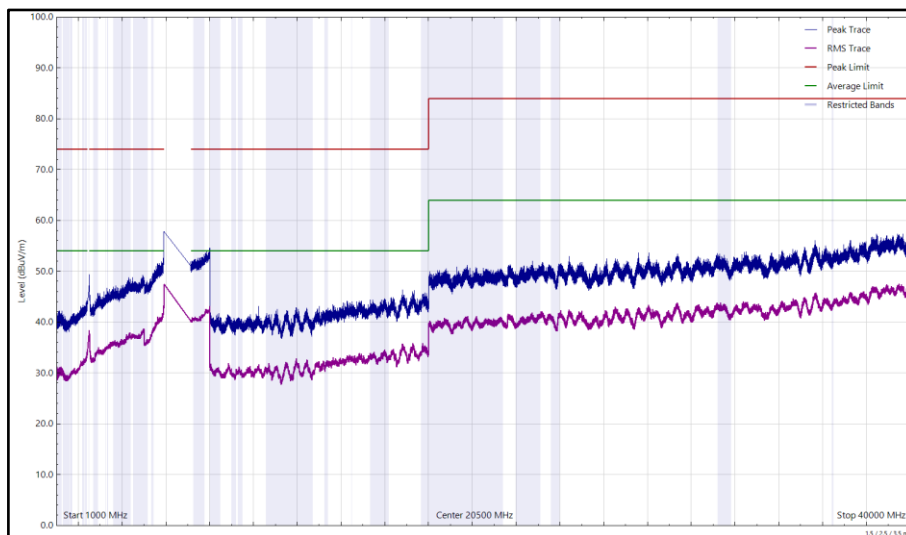

Figure 29 - U-NII-5 - 5955 MHz (CH1), HE20, SU, CDD, Core 0 + Core 1 and 2480 MHz (CH78), 2-DH5, ePA, Core 0 + Core 1, 1 GHz to 40 GHz, Vertical



Frequency (MHz)	Level (dBuV/m)	Limit (dBuV/m)	Margin (dB)	Detector	Angle (°)	Height (cm)	Polarisation
279.995	25.66	46.00	-20.34	Q-Peak	58	101	Horizontal
280.011	24.19	46.00	-21.81	Q-Peak	359	160	Vertical
5334.678	57.73	74.00	-16.27	Peak	352	289	Vertical

Table 13 - U-NII-8 - 7115 MHz (CH233), HE20, SU, CDD, Core 0 + Core 1 and 2480 MHz (CH78), 2-DH5, ePA, Core 0 + Core 1, 30 MHz to 40 GHz

No other emissions found within 10 dB of the limit.

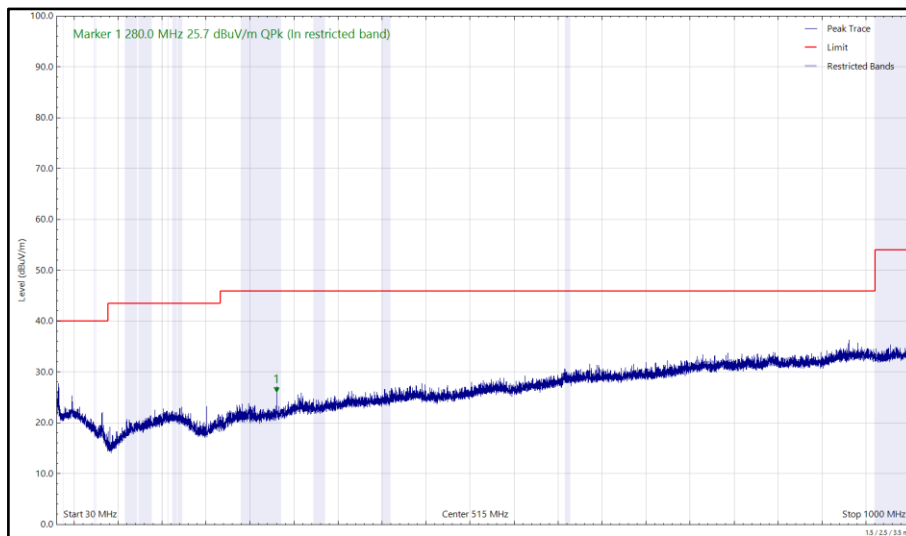

Figure 30 - U-NII-8 - 7115 MHz (CH233), HE20, SU, CDD, Core 0 + Core 1 and 2480 MHz (CH78), 2-DH5, ePA, Core 0 + Core 1, 30 MHz to 1 GHz, Horizontal (Peak)

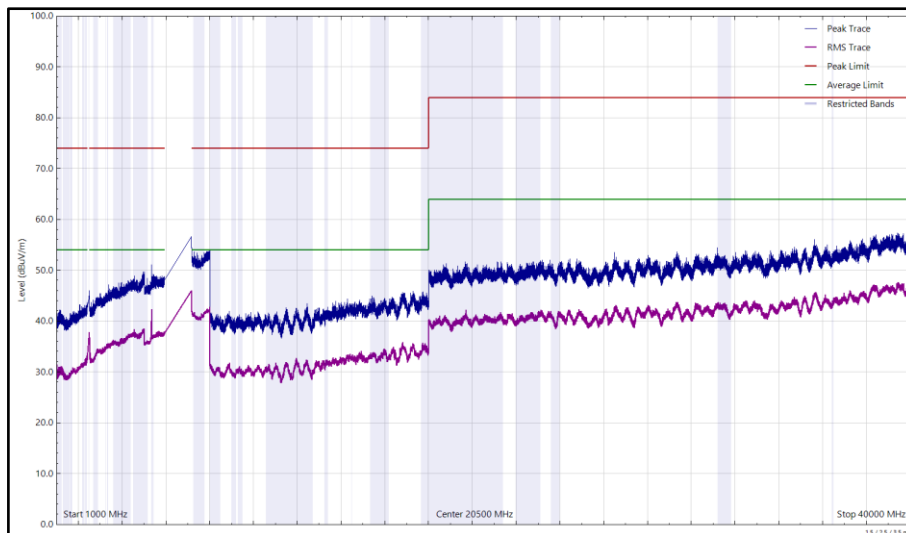

Figure 31 - U-NII-8 - 7115 MHz (CH233), HE20, SU, CDD, Core 0 + Core 1 and 2480 MHz (CH78), 2-DH5, ePA, Core 0 + Core 1, 1 GHz to 40 GHz, Horizontal

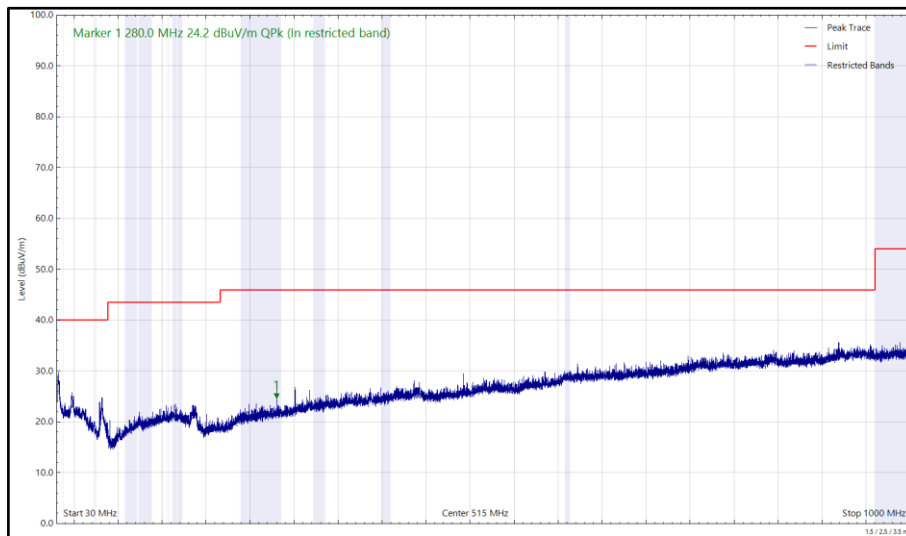

Figure 32 - U-NII-8 - 7115 MHz (CH233), HE20, SU, CDD, Core 0 + Core 1 and 2480 MHz (CH78), 2-DH5, ePA, Core 0 + Core 1, 30 MHz to 1 GHz, Vertical (Peak)

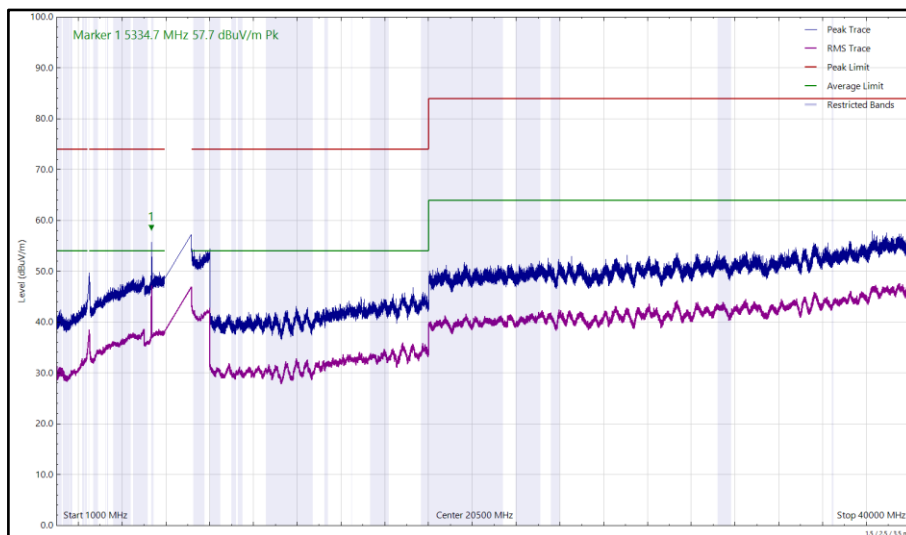

Figure 33 - U-NII-8 - 7115 MHz (CH233), HE20, SU, CDD, Core 0 + Core 1 and 2480 MHz (CH78), 2-DH5, ePA, Core 0 + Core 1, 1 GHz to 40 GHz, Vertical



FCC 47 CFR Part 15, ISED RSS-247, ISED RSS-248 and ISED RSS-GEN

The least stringent limit from the applicable rule parts was used to determine compliance for Radiated Emissions testing of multiple transmission sources.

The least stringent applicable limit was

:

Clause	Limit
Part 15.247 (d) / RSS-247 Clause 5.5	-20 dBc
Part 15.407 (b) / RSS-248 Clause 4.7.2.	Peak: -7 dBm/MHz e.i.r.p, Average: -27 dBm/MHz e.i.r.p
Part 15.209 / RSS-GEN Clause 8.9	Peak: 74 dB μ V/m at 3m, Average 54 dB μ V/m at 3m

Table 14



CoTX - 2.4 GHz WLAN + Narrowband

Frequency (MHz)	Level (dBuV/m)	Limit (dBuV/m)	Margin (dB)	Detector	Angle (°)	Height (cm)	Polarisation
280.003	24.33	46.00	-21.67	Q-Peak	352	174	Vertical
280.006	25.93	46.00	-20.07	Q-Peak	87	123	Horizontal

Table 15 - 2412 MHz (CH1), HT20, Core 0 and 5162 MHz, HDR4, ePA, Core 1, 30 MHz to 40 GHz

No other emissions found within 10 dB of the limit.

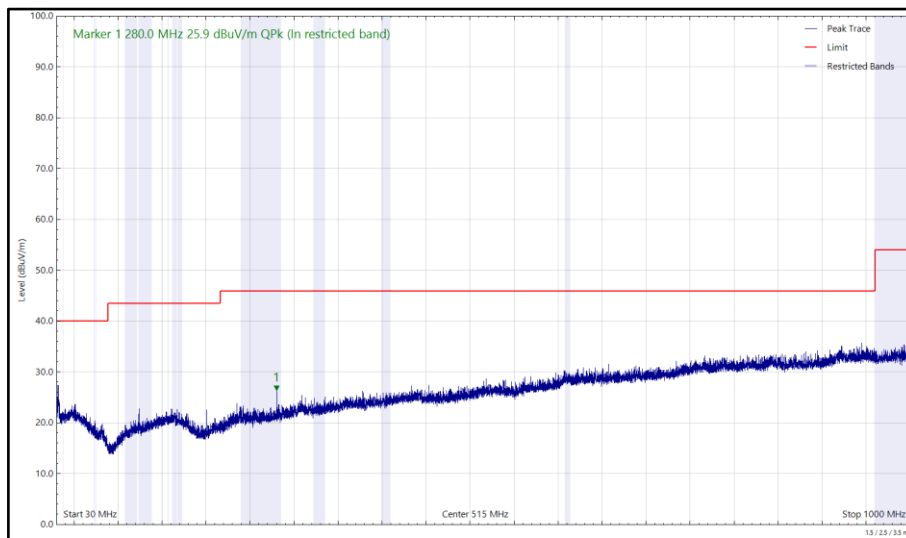

Figure 34 - 2412 MHz z (CH1), HT20, Core 0 and 5162 MHz, HDR4, ePA, Core 1, 30 MHz to 1 GHz, Horizontal (Peak)

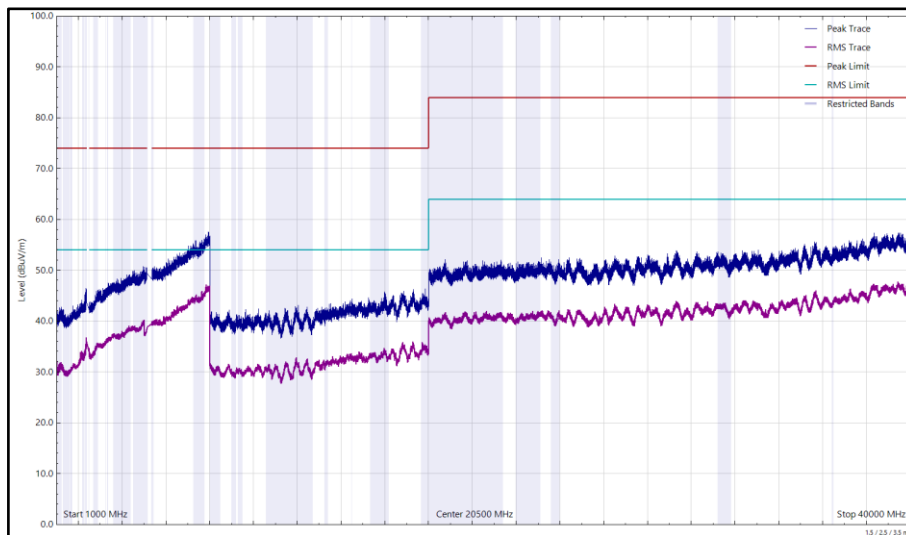

Figure 35 - 2412 MHz (CH1), HT20, Core 0 and 5162 MHz, HDR4, ePA, Core 1, 1 GHz to 40 GHz, Horizontal

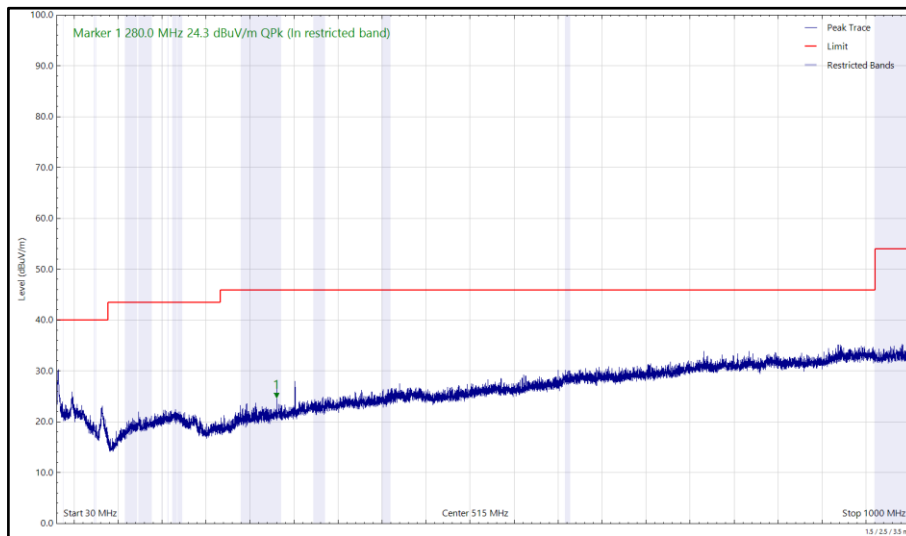

Figure 36 - 2412 MHz (CH1), HT20, Core 0 and 5162 MHz, HDR4, ePA, Core 1, 30 MHz to 1 GHz, Vertical (Peak)

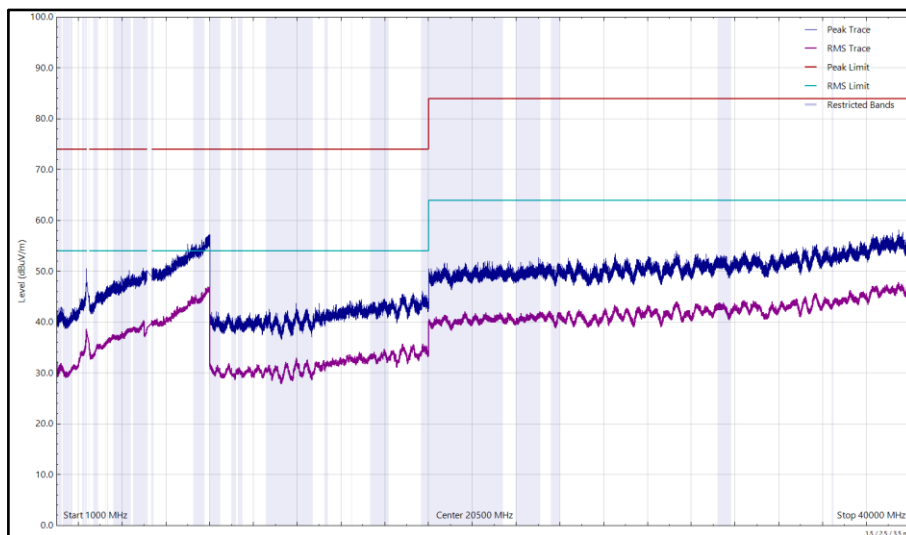

Figure 37 - 2412 MHz (CH1), HT20, Core 0 and 5162 MHz, HDR4, ePA, Core 1, 1 GHz to 40 GHz, Vertical



Frequency (MHz)	Level (dBuV/m)	Limit (dBuV/m)	Margin (dB)	Detector	Angle (°)	Height (cm)	Polarisation
279.997	24.14	46.00	-21.86	Q-Peak	278	153	Horizontal
280.012	24.05	46.00	-21.95	Q-Peak	354	179	Vertical

Table 16 - 2472 MHz (CH13), HT20, Core 0 and 5162 MHz, HDR4, ePA, Core 1, 30 MHz to 40 GHz

No other emissions found within 10 dB of the limit.

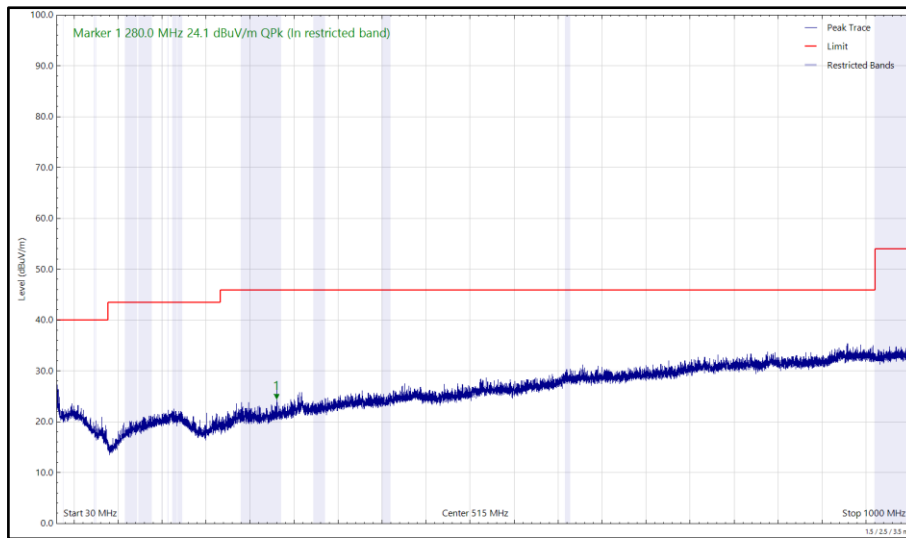

Figure 38 - 2472 MHz (CH13), HT20, Core 0 and 5162 MHz, HDR4, ePA, Core 1, 30 MHz to 1 GHz, Horizontal (Peak)

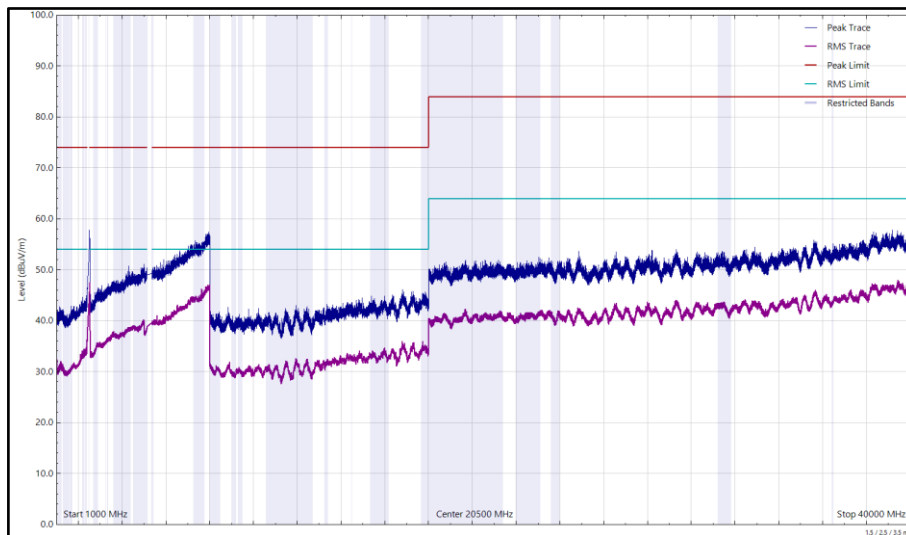

Figure 39 - 2472 MHz (CH13), HT20, Core 0 and 5162 MHz, HDR4, ePA, Core 1, 1 GHz to 40 GHz, Horizontal

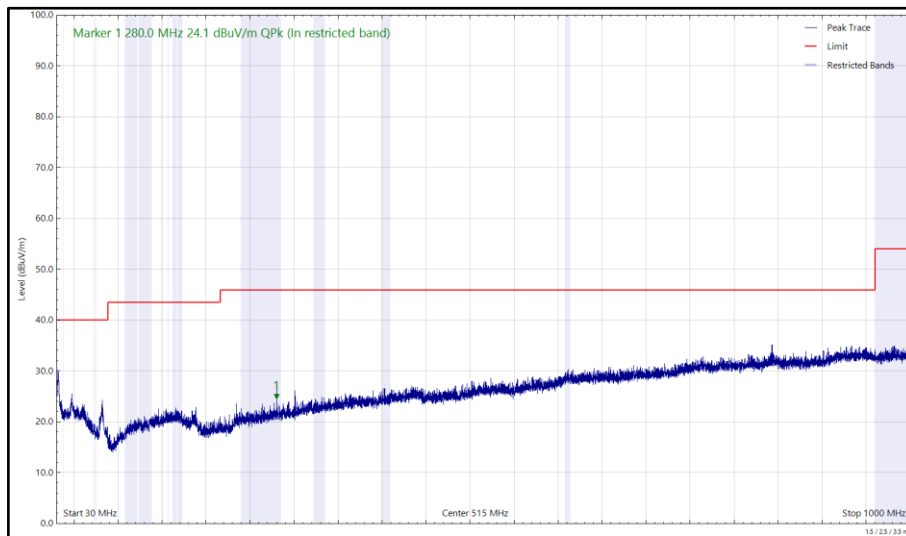

Figure 40 - 2472 MHz (CH13), HT20, Core 0 and 5162 MHz, HDR4, ePA, Core 1, 30 MHz to 1 GHz, Vertical (Peak)

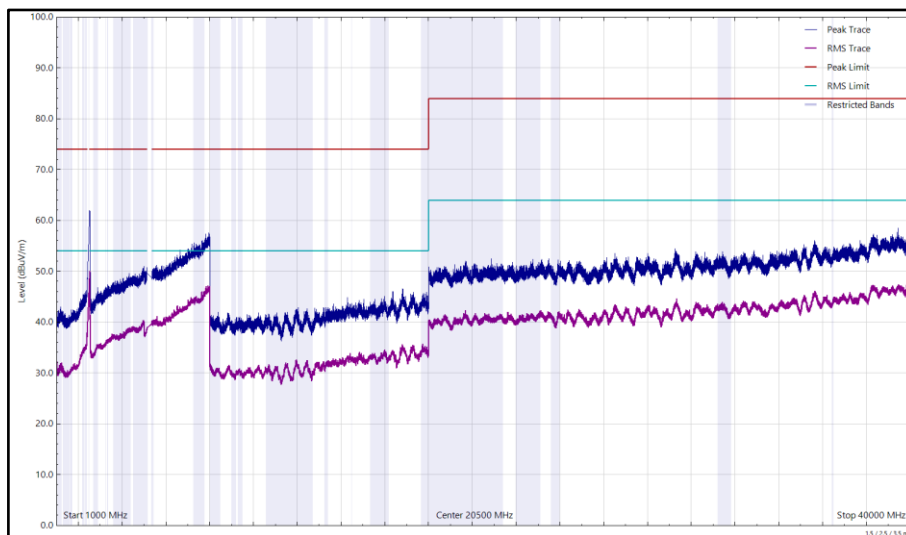

Figure 41 - 2472 MHz (CH13), HT20, Core 0 and 5162 MHz, HDR4, ePA, Core 1, 1 GHz to 40 GHz, Vertical



Frequency (MHz)	Level (dBuV/m)	Limit (dBuV/m)	Margin (dB)	Detector	Angle (°)	Height (cm)	Polarisation
279.995	25.04	46.00	-20.96	Q-Peak	281	113	Horizontal
279.999	24.29	46.00	-21.71	Q-Peak	0	166	Vertical
5426.443	38.56	54.00	-15.44	RMS	249	446	Horizontal
5426.563	44.62	54.00	-9.38	RMS	360	285	Vertical

Table 17 - 2412 MHz (CH1), HT20, Core 0 and 5844 MHz, HDR4, ePA, Core 1, 30 MHz to 40 GHz

No other emissions found within 10 dB of the limit.

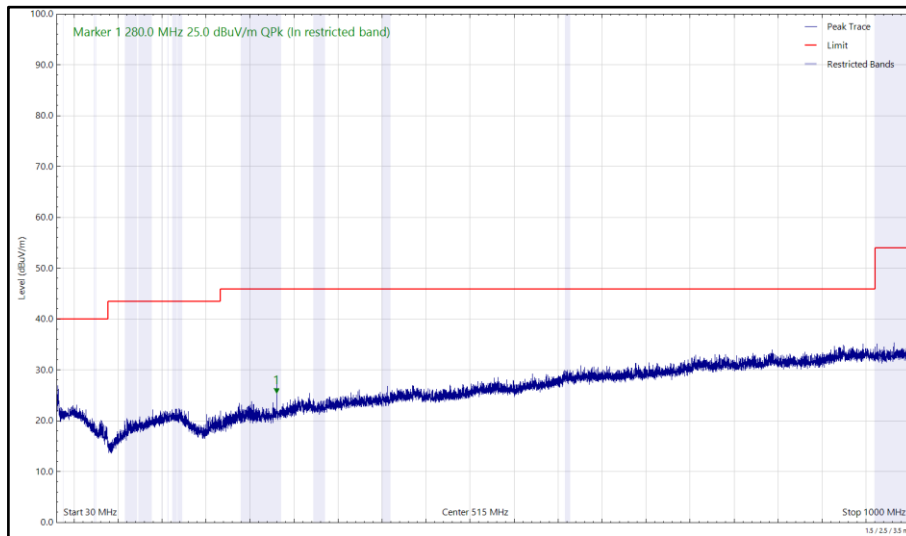

Figure 42 - 2412 MHz (CH1), HT20, Core 0 and 5844 MHz, HDR4, ePA, Core 1, 30 MHz to 1 GHz, Horizontal (Peak)

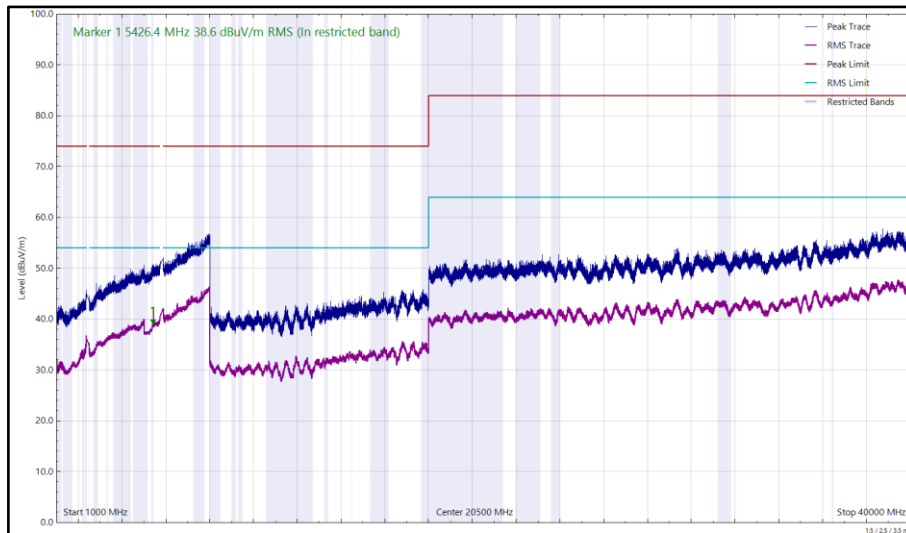

Figure 43 - 2412 MHz (CH1), HT20, Core 0 and 5844 MHz, HDR4, ePA, Core 1, 1 GHz to 40 GHz, Horizontal

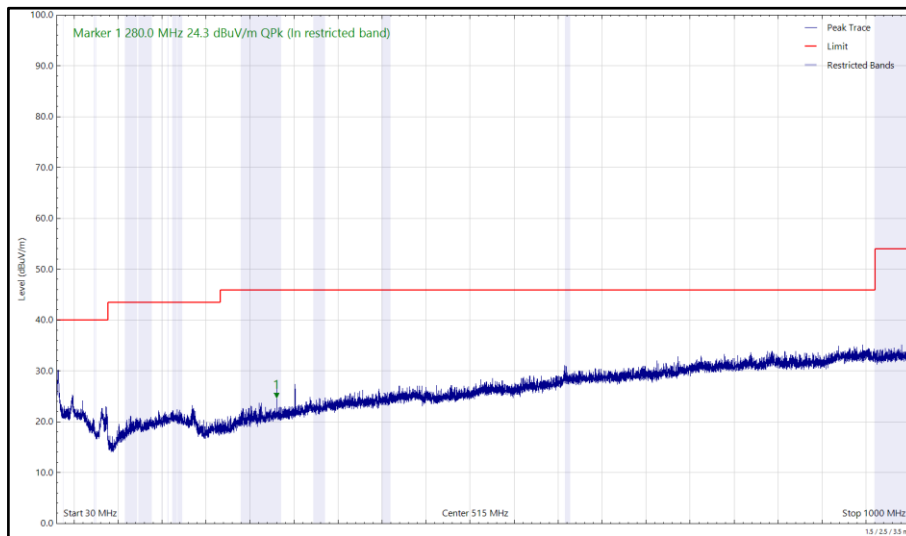

Figure 44 - 2412 MHz (CH1), HT20, Core 0 and 5844 MHz, HDR4, ePA, Core 1, 30 MHz to 1 GHz, Vertical (Peak)

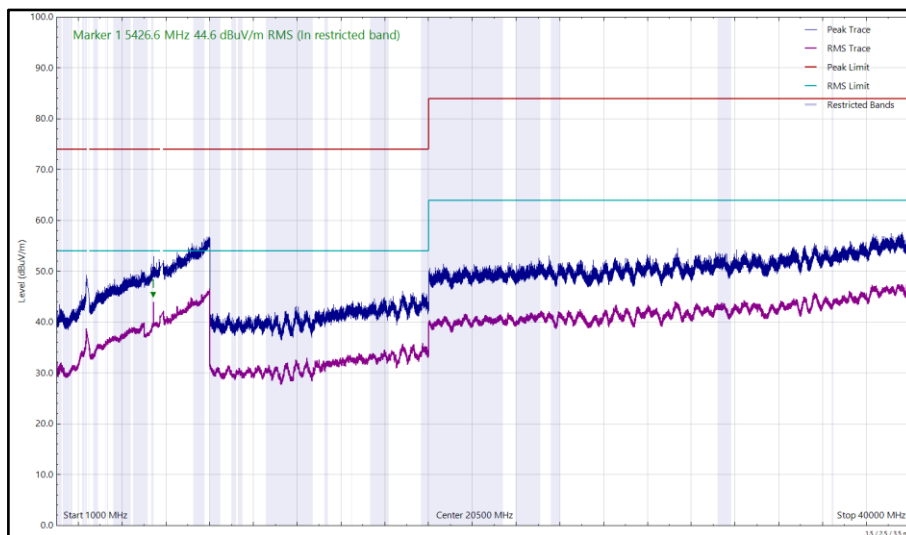

Figure 45 - 2412 MHz (CH1), HT20, Core 0 and 5844 MHz, HDR4, ePA, Core 1, 1 GHz to 40 GHz, Vertical



Frequency (MHz)	Level (dBuV/m)	Limit (dBuV/m)	Margin (dB)	Detector	Angle (°)	Height (cm)	Polarisation
279.976	22.89	46.00	-23.11	Q-Peak	5	147	Vertical
279.984	24.39	46.00	-21.61	Q-Peak	270	114	Horizontal
5426.225	38.15	54.00	-15.85	RMS	216	218	Horizontal
5426.505	44.68	54.00	-9.32	RMS	3	285	Vertical

Table 18 - 2472 MHz (CH13), HT20, Core 0 and 5844 MHz, HDR4, ePA, Core 1, 30 MHz to 40 GHz

No other emissions found within 10 dB of the limit.

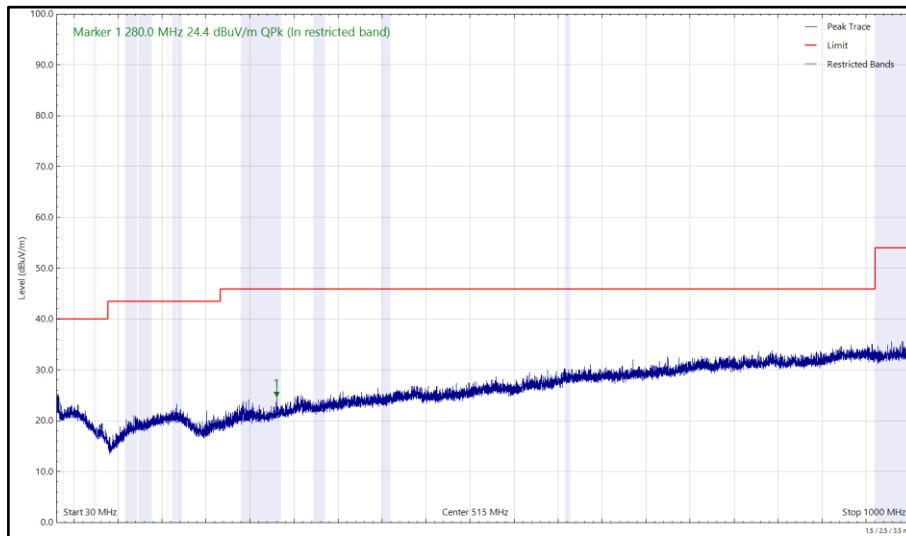

Figure 46 - 2472 MHz (CH13), HT20, Core 0 and 5844 MHz, HDR4, ePA, Core 1, 30 MHz to 1 GHz, Horizontal (Peak)

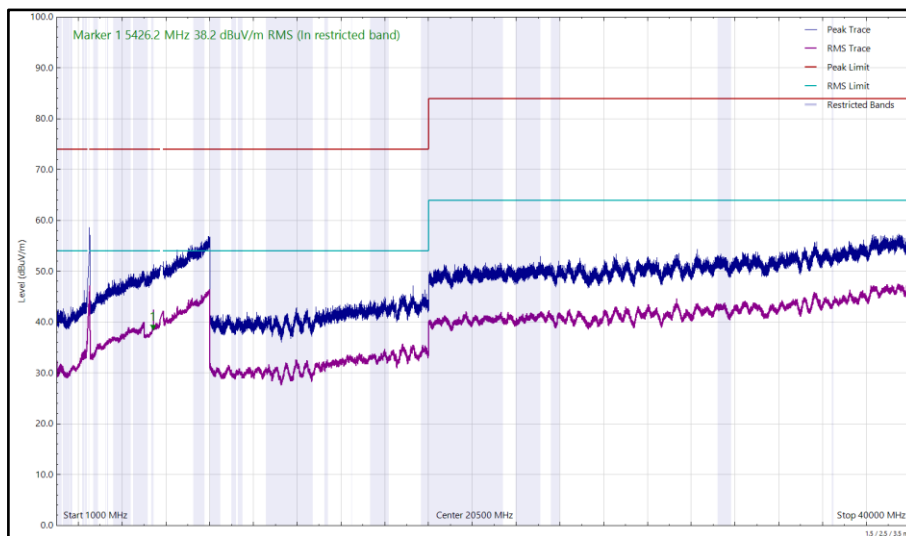

Figure 47 - 2472 MHz (CH13), HT20, Core 0 and 5844 MHz, HDR4, ePA, Core 1, 1 GHz to 40 GHz, Horizontal

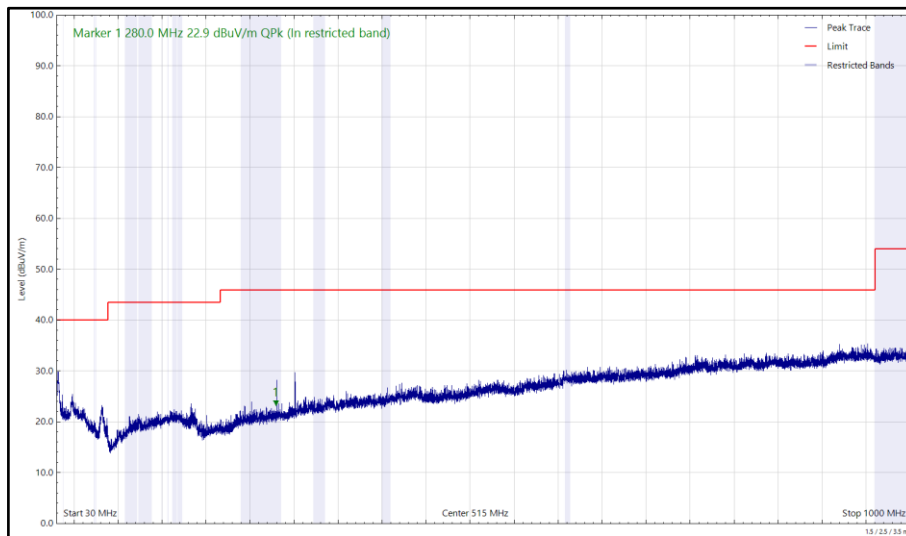

Figure 48 - 2472 MHz (CH13), HT20, Core 0 and 5844 MHz, HDR4, ePA, Core 1, 30 MHz to 1 GHz, Vertical (Peak)

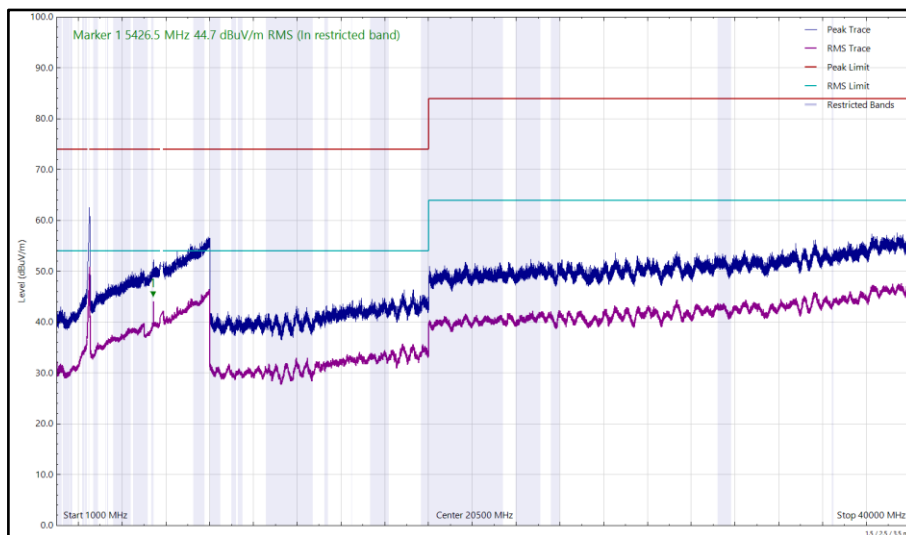

Figure 49 - 2472 MHz (CH13), HT20, Core 0 and 5844 MHz, HDR4, ePA, Core 1, 1 GHz to 40 GHz, Vertical



Frequency (MHz)	Level (dBuV/m)	Limit (dBuV/m)	Margin (dB)	Detector	Angle (°)	Height (cm)	Polarisation
279.996	23.69	46.00	-22.31	Q-Peak	353	195	Vertical
280.012	24.70	46.00	-21.30	Q-Peak	46	109	Horizontal

Table 19 - 2412 MHz (CH1), HT20, Core 1 and 5162 MHz, HDR4, ePA, Core 0, 30 MHz to 40 GHz

No other emissions found within 10 dB of the limit.

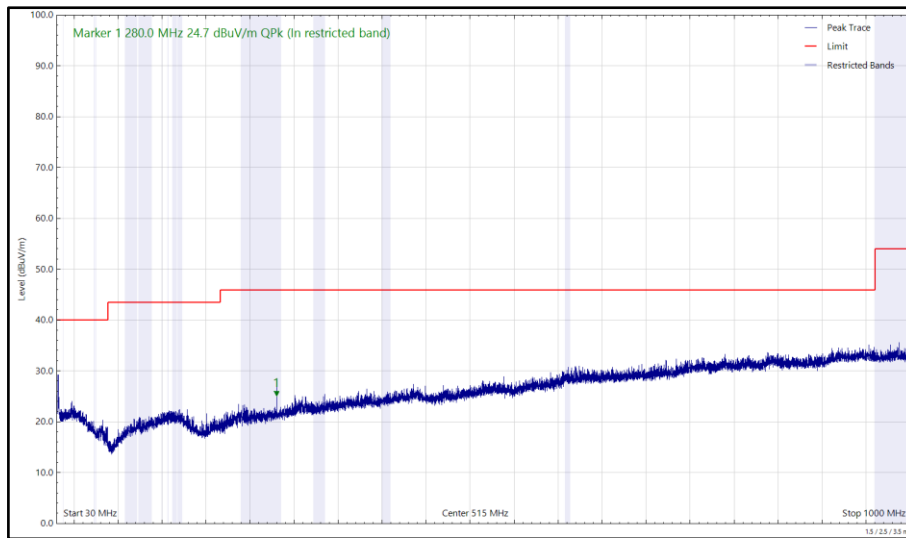

Figure 50 - 2412 MHz (CH1), HT20, Core 1 and 5162 MHz, HDR4, ePA, Core 0, 30 MHz to 1 GHz, Horizontal (Peak)

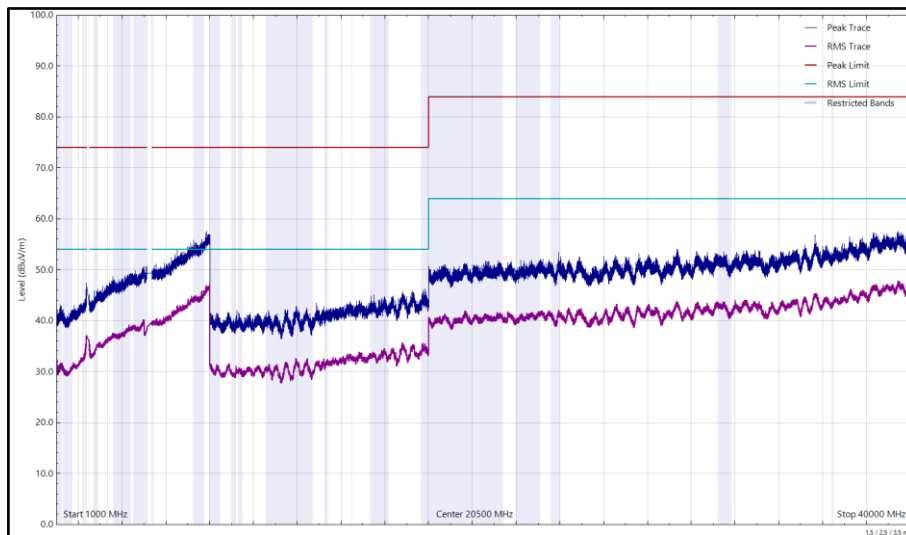

Figure 51 - 2412 MHz (CH1), HT20, Core 1 and 5162 MHz, HDR4, ePA, Core 0, 1 GHz to 40 GHz, Horizontal

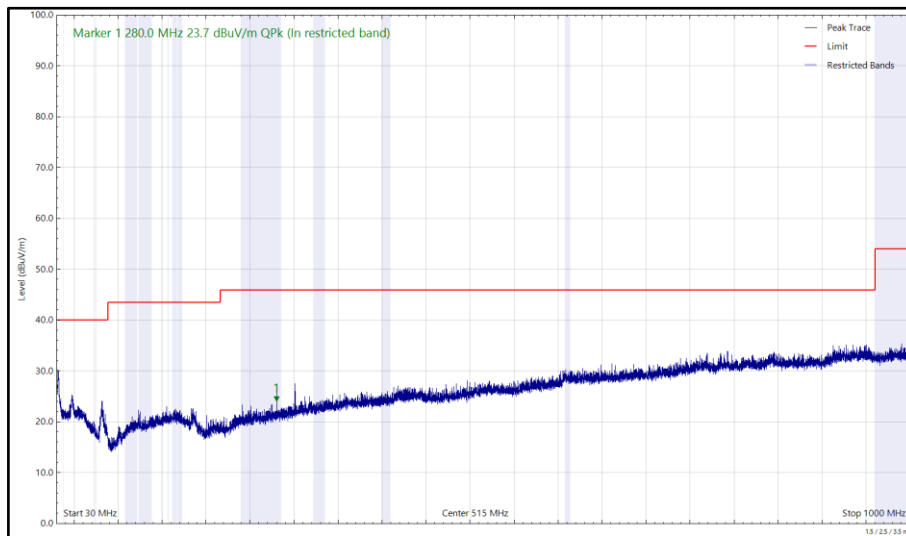

Figure 52 - 2412 MHz (CH1), HT20, Core 1 and 5162 MHz, HDR4, ePA, Core 0, 30 MHz to 1 GHz, Vertical (Peak)

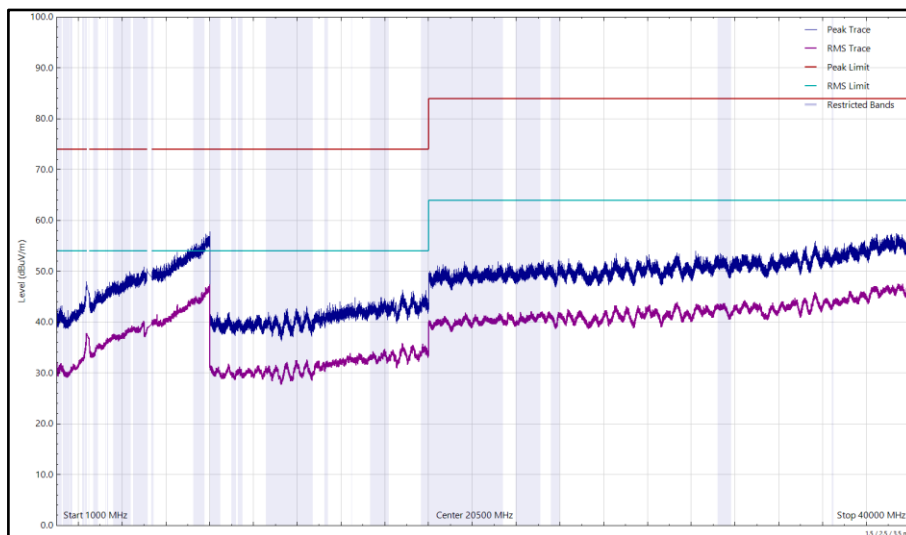

Figure 53 - 2412 MHz (CH1), HT20, Core 1 and 5162 MHz, HDR4, ePA, Core 0, 1 GHz to 40 GHz, Vertical



Frequency (MHz)	Level (dBuV/m)	Limit (dBuV/m)	Margin (dB)	Detector	Angle (°)	Height (cm)	Polarisation
279.982	23.79	46.00	-22.21	Q-Peak	354	156	Vertical

Table 20 - 2472 MHz (CH13), HT20, Core 1 and 5162 MHz, HDR4, ePA, Core 0, 30 MHz to 40 GHz

No other emissions found within 10 dB of the limit.

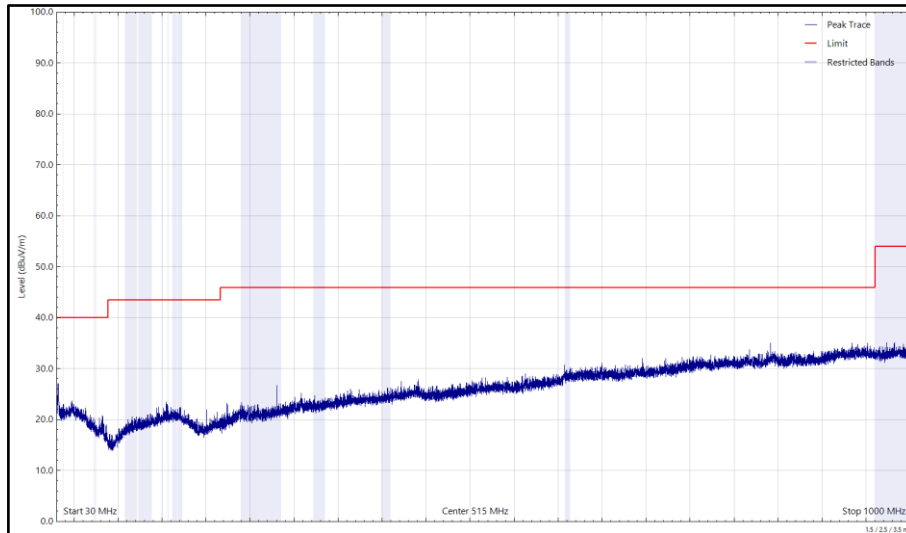

Figure 54 - 2472 MHz (CH13), HT20, Core 1 and 5162 MHz, HDR4, ePA, Core 0, 30 MHz to 1 GHz, Horizontal (Peak)

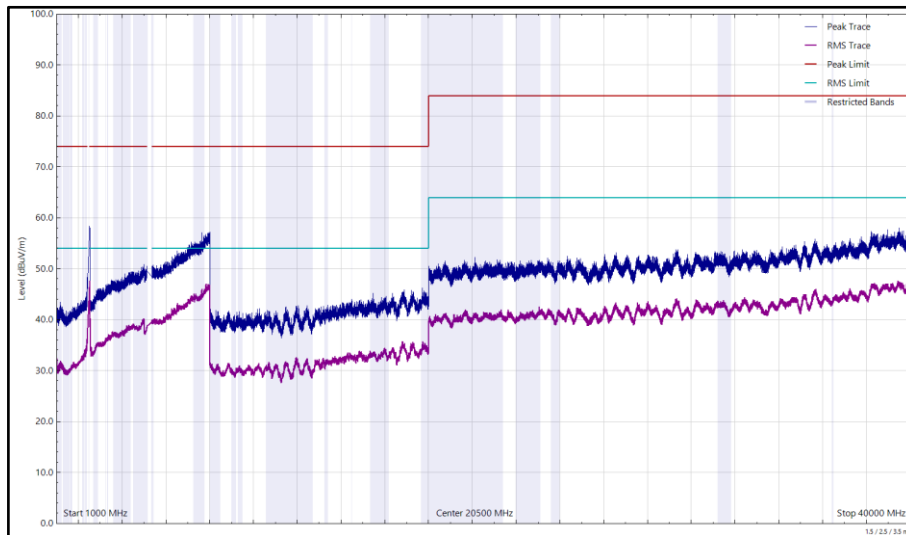

Figure 55 - 2472 MHz (CH13), HT20, Core 1 and 5162 MHz, HDR4, ePA, Core 0, 1 GHz to 40 GHz, Horizontal

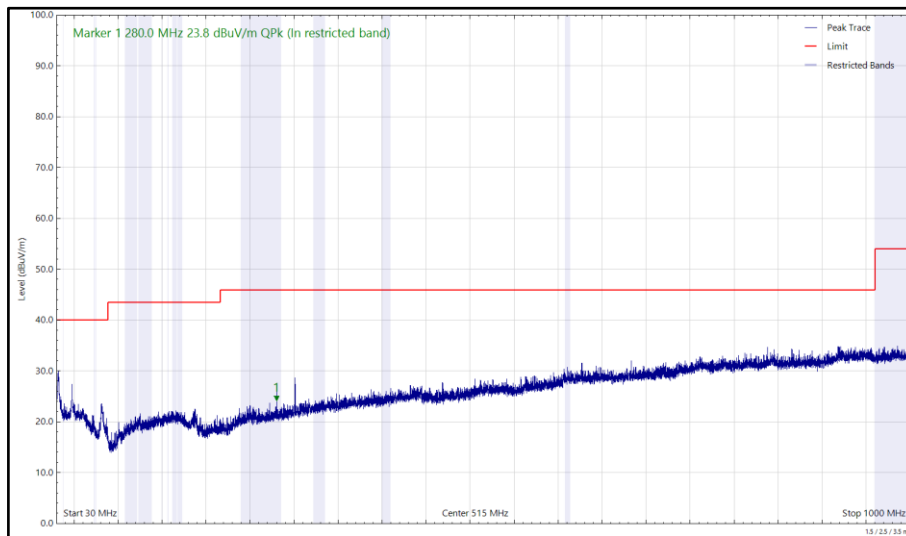

Figure 56 - 2472 MHz (CH13), HT20, Core 1 and 5162 MHz, HDR4, ePA, Core 0, 30 MHz to 1 GHz, Vertical (Peak)

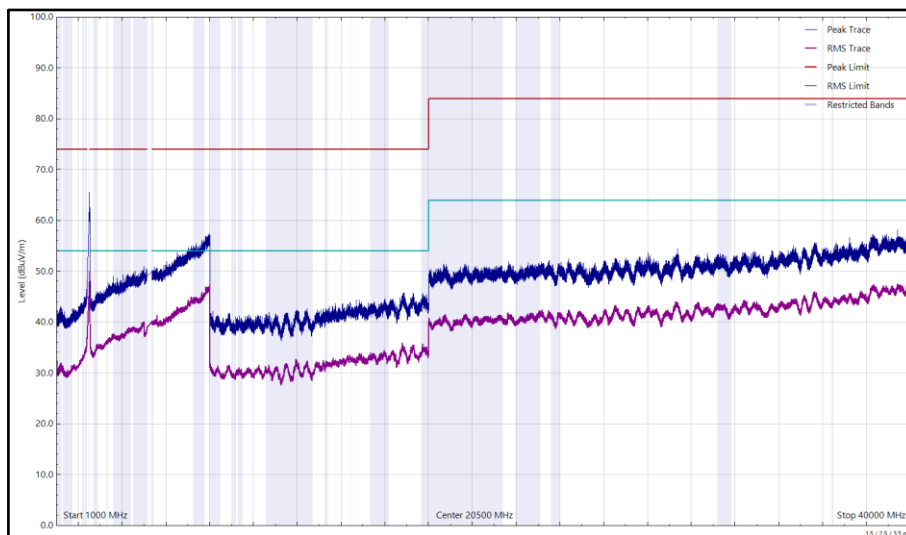

Figure 57 - 2472 MHz (CH13), HT20, Core 1 and 5162 MHz, HDR4, ePA, Core 0, 1 GHz to 40 GHz, Vertical



Frequency (MHz)	Level (dBuV/m)	Limit (dBuV/m)	Margin (dB)	Detector	Angle (°)	Height (cm)	Polarisation
5426.549	43.62	54.00	-10.38	RMS	0	284	Vertical

Table 21 - 2412 MHz (CH1), HT20, Core 1 and 5844 MHz, HDR4, ePA, Core 0, 30 MHz to 40 GHz

No other emissions found within 10 dB of the limit.

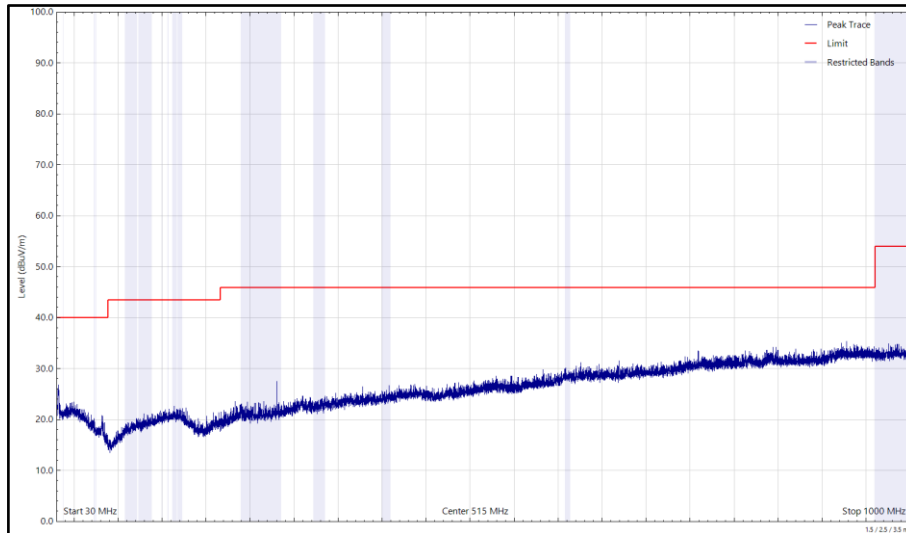

Figure 58 - 2412 MHz (CH1), HT20, Core 1 and 5844 MHz, HDR4, ePA, Core 0, 30 MHz to 1 GHz, Horizontal (Peak)

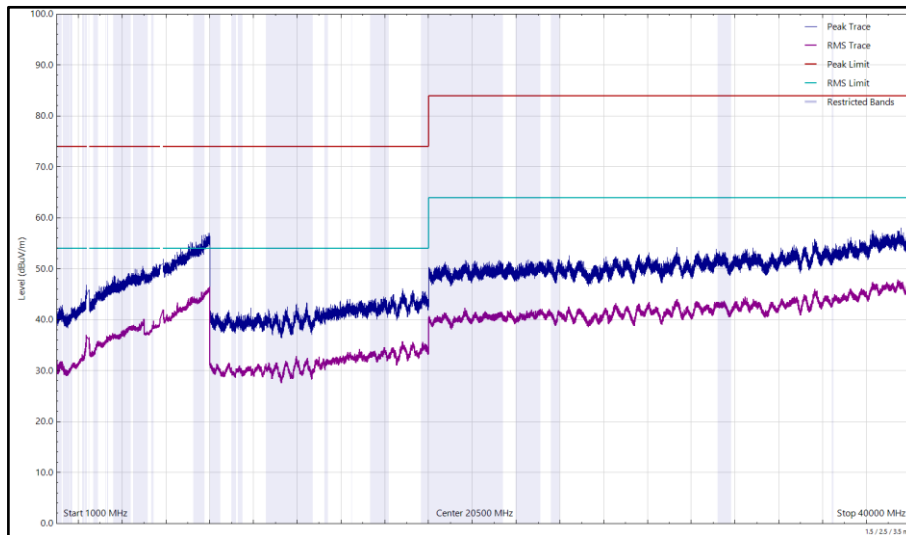

Figure 59 - 2412 MHz (CH1), HT20, Core 1 and 5844 MHz, HDR4, ePA, Core 0, 1 GHz to 40 GHz, Horizontal

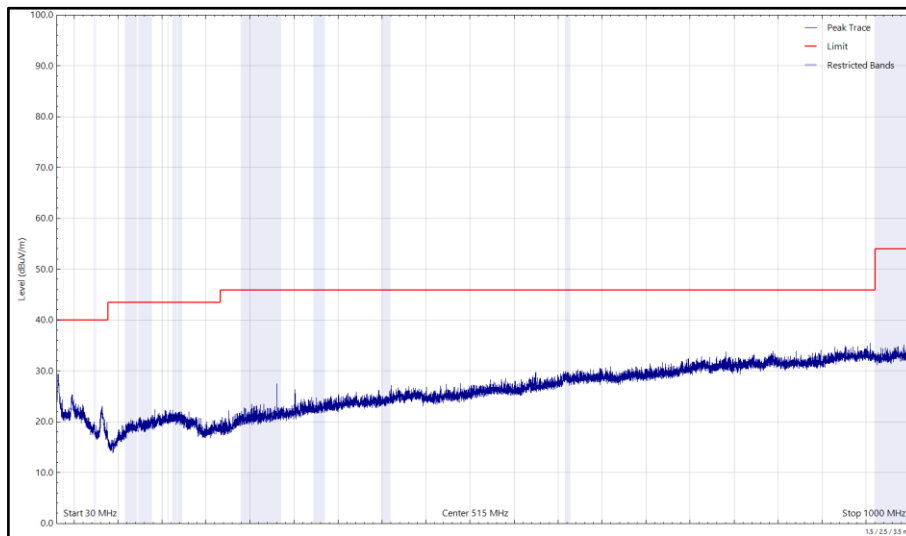

Figure 60 - 2412 MHz (CH1), HT20, Core 1 and 5844 MHz, HDR4, ePA, Core 0, 30 MHz to 1 GHz, Vertical (Peak)

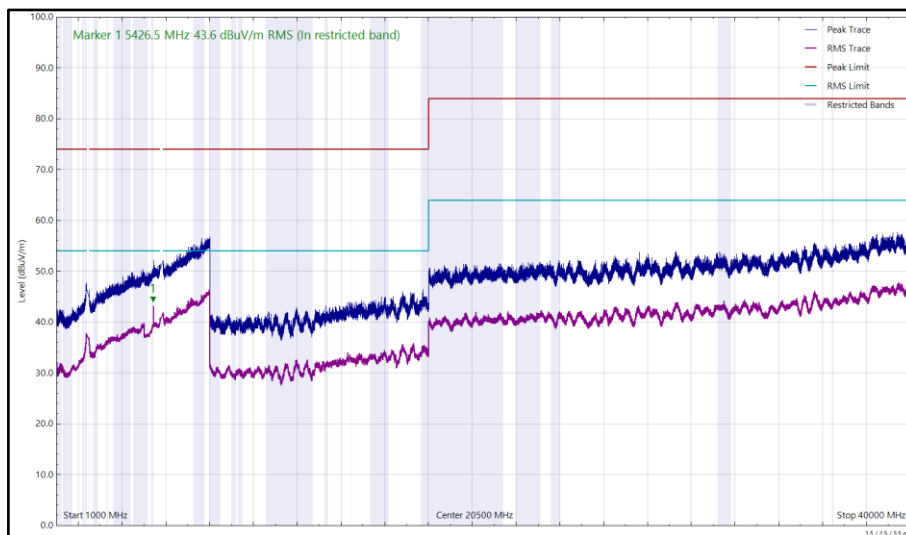

Figure 61 - 2412 MHz (CH1), HT20, Core 1 and 5844 MHz, HDR4, ePA, Core 0, 1 GHz to 40 GHz, Vertical



Frequency (MHz)	Level (dBuV/m)	Limit (dBuV/m)	Margin (dB)	Detector	Angle (°)	Height (cm)	Polarisation
5426.521	44.18	54.00	-9.82	RMS	351	286	Vertical

Table 22 - 2472 MHz (CH13), HT20, Core 1 and 5844 MHz, HDR4, ePA, Core 0, 30 MHz to 40 GHz

No other emissions found within 10 dB of the limit.

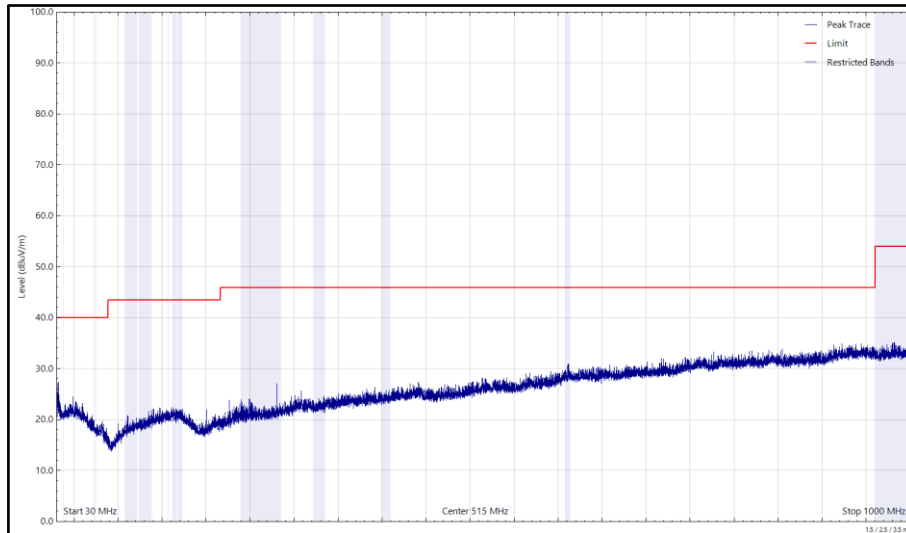

Figure 62 - 2472 MHz (CH13), HT20, Core 1 and 5844 MHz, HDR4, ePA, Core 0, 30 MHz to 1 GHz, Horizontal (Peak)

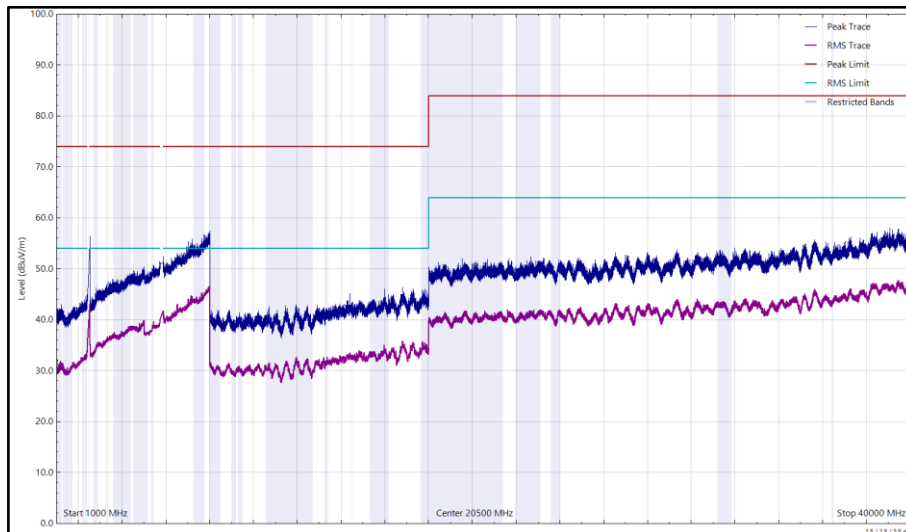

Figure 63 - 2472 MHz (CH13), HT20, Core 1 and 5844 MHz, HDR4, ePA, Core 0, 1 GHz to 40 GHz, Horizontal

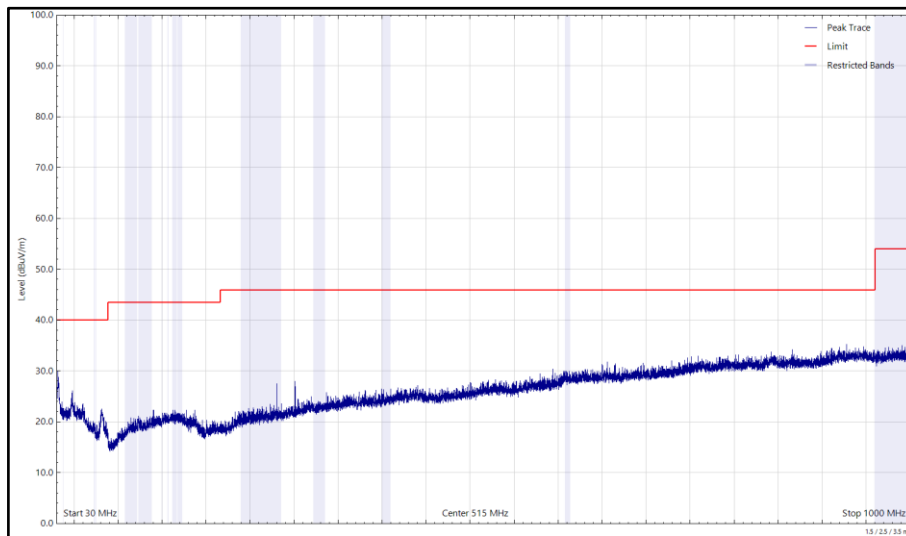

Figure 64 - 2472 MHz (CH13), HT20, Core 1 and 5844 MHz, HDR4, ePA, Core 0, 30 MHz to 1 GHz, Vertical (Peak)

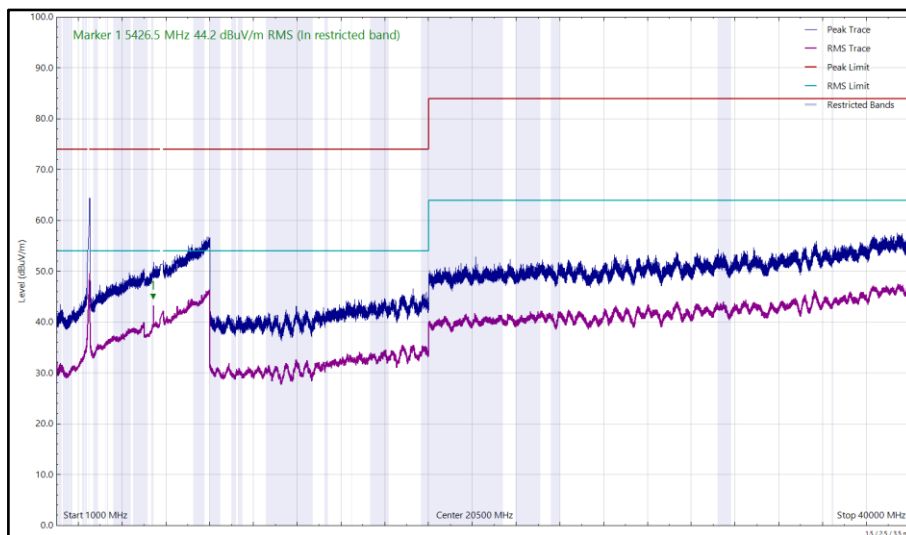

Figure 65 - 2472 MHz (CH13), HT20, Core 1 and 5844 MHz, HDR4, ePA, Core 0, 1 GHz to 40 GHz, Vertical



FCC 47 CFR Part 15, ISED RSS-247 and ISED RSS-GEN

The least stringent limit from the applicable rule parts was used to determine compliance for Radiated Emissions testing of multiple transmission sources.

The least stringent applicable limit was:

Clause	Limit
Part 15.247 (d) / RSS-247 Clause 5.5	-30 dBc
Part 15.407 (b) / RSS-247 Clause 6.2	-27 dBm (EIRP) / 68 dBµV/m at 3m.
Part 15.209 / RSS-GEN Clause 8.9	Peak: 74 dBµV/m at 3m, Average 54 dBµV/m at 3m

Table 23

2.1.8 Test Location and Test Equipment Used

This test was carried out in RF Chamber 16.

Instrument	Manufacturer	Type No	TE No	Calibration Period (months)	Calibration Expires
Emissions Software	TUD SUD	EmX V3.1.4	5125	-	Software
2 Meter Cable	Teledyne	PR90-088-2MTR	5196	12	11-Aug-2023
Cable (18GHz)	Junkosha	MWX221-04000NMSNMS/B	5262	12	04-Aug-2023
Cable (18 GHz)	Junkosha	MWX221-04000NMSNMS/B	5263	12	24-Jan-2023
Test Receiver	Rohde & Schwarz	ESW44	5914	12	21-Feb-2023
Cable (K Type 2m)	Junkosha	MWX241-01000KMSKMS/B	5935	12	14-May-2023
DRG Horn Antenna (7.5-18GHz)	Schwarzbeck	HWRD750	5940	12	29-May-2023
TRILOG Super Broadband Test Antenna	Schwarzbeck	VULB 9168	5943	24	03-Feb-2024
1500W (300V 12A) AC Power Supply	iTech	IT7324	5957	-	O/P Mon
3m Semi-Anechoic Chamber	Schaffner	RF Chamber 16	5972	36	24-May-2025
Mast & Turntable Controller	Maturo Gmbh	Mast & Turntable Controller	5973	-	TU
Tilt Antenna Mast	Maturo Gmbh	BAM4.5-P	5974	-	TU
Turntable	Maturo Gmbh	TT1.5SI	5975	-	TU
Cable (SMA to SMA 1m)	Junkosha	MWX221-01000AMSAMS/A	6018	12	06-Jun-2023
Cable (SMA to SMA 3m)	Junkosha	MWX221-03000AMSAMS/A	6021	12	06-Jun-2023
Horn Antenna (1-10 GHz)	Schwarzbeck	BBHA9120B	6142	12	26-Jun-2023



Instrument	Manufacturer	Type No	TE No	Calibration Period (months)	Calibration Expires
Digital Multimeter	Fluke	115	6146	12	16-Jun-2023
Humidity & Temperature meter	R.S Components	1364	6148	12	17-Jun-2023
Double Ridge Active Horn Antenna (18-40 GHz)	Com-Power	AHA-840	6188	24	02-Jun-2024
SAC Switch Unit	TUV SUD	SSU002	6190	12	08-Aug-2023
8GHz Highpass Filter	Wainwright	WHKX 7150 8000 18000 50SS	6196	12	15-Jul-2023
Pre Amp 8 - 18 GHz	Wright Technologies	APS06 0061	6200	0	19-Jul-2023
Attenuator 4dB	Pasternack	PE7074-4	6202	24	16-Jul-2024
Cable (SMA to SMA 20cm)	TUV SUD	MH-FH 8-18	6220	12	10-Aug-2023

Table 24

TU – Traceability Unscheduled
 O/P Mon – Output Monitored using calibrated equipment



3 Measurement Uncertainty

For a 95% confidence level, the measurement uncertainties for defined systems are:

Test Name	Measurement Uncertainty
Radiated Spurious Emissions (Simultaneous Transmission)	30 MHz to 1 GHz: ± 5.2 dB 1 GHz to 40 GHz: ± 6.3 dB

Table 25

Measurement Uncertainty Decision Rule – Accuracy Method

Determination of conformity with the specification limits is based on the decision rule according to IEC Guide 115:2007, Clause 4.4.3 and 4.5.1. (Procedure 2). The measurement results are directly compared with the test limit to determine conformance with the requirements of the standard.

Risk: The uncertainty of measurement about the measured result is negligible with regard to the final pass/fail decision. The measurement result can be directly compared with the test limit to determine conformance with the requirement (compare IEC Guide 115). The level of risk to falsely accept and falsely reject items is further described in ILAC-G8.