

FCC and ISED Test Report

Apple Inc
Model: A2779

In accordance with FCC 47 CFR Part 15, ISED RSS-247, ISED RSS-248 and ISED RSS-GEN (2.4 GHz Bluetooth, 2.4 GHz WLAN, 5 GHz WLAN, 6 GHz WLAN and Narrowband)

Prepared for: Apple Inc
One Apple Park Way
Cupertino, California
95014, USA



Add value.
Inspire trust.

FCC ID: BCGA2779

IC: 579C-A2779

COMMERCIAL-IN-CONFIDENCE

Document 75955428-10 Issue 01

SIGNATURE

NAME	JOB TITLE	RESPONSIBLE FOR	ISSUE DATE
Steve Marshall	Senior Engineer	Authorised Signatory	22 November 2022

Signatures in this approval box have checked this document in line with the requirements of TÜV SÜD document control rules.

ENGINEERING STATEMENT

The measurements shown in this report were made in accordance with the procedures described on test pages. All reported testing was carried out on a sample equipment to demonstrate limited compliance with FCC 47 CFR Part 15, ISED RSS-247, ISED RSS-248 and ISED RSS-GEN. The sample tested was found to comply with the requirements defined in the applied rules.

RESPONSIBLE FOR	NAME	DATE	SIGNATURE
Report Generation	Lauren Walters	22 November 2022	

FCC Accreditation
90987 Octagon House, Fareham Test Laboratory

ISED Accreditation
12669A Octagon House, Fareham Test Laboratory

EXECUTIVE SUMMARY

A sample of this product was tested and found to be compliant with FCC 47 CFR Part 15: 2020, ISED RSS-247: Issue 2 (2017-02), ISED RSS-248: Issue 1 (2021-11) and ISED RSS-GEN: Issue 5 (2018-04) + A2 (2021-02) for the tests detailed in section 1.3.



DISCLAIMER AND COPYRIGHT

This non-binding report has been prepared by TÜV SÜD with all reasonable skill and care. The document is confidential to the potential Client and TÜV SÜD. No part of this document may be reproduced without the prior written approval of TÜV SÜD. © 2022 TÜV SÜD. This report relates only to the actual item/items tested.

ACCREDITATION

Our UKAS Accreditation does not cover opinions and interpretations and any expressed are outside the scope of our UKAS Accreditation. Results of tests not covered by our UKAS Accreditation Schedule are marked NUA (Not UKAS Accredited).

TÜV SÜD
is a trading name of TÜV SÜD Ltd
Registered in Scotland at East Kilbride,
Glasgow G75 0QF, United Kingdom
Registered number: SC215164

TÜV SÜD Ltd is a
TÜV SÜD Group Company

Phone: +44 (0) 1489 558100
Fax: +44 (0) 1489 558101
www.tuvsud.com/en

TÜV SÜD
Octagon House
Concorde Way
Fareham
Hampshire PO15 5RL
United Kingdom



Contents

1	Report Summary	2
1.1	Report Modification Record.....	2
1.2	Introduction.....	2
1.3	Brief Summary of Results	3
1.4	Product Information	4
1.5	Deviations from the Standard.....	4
1.6	EUT Modification Record	4
1.7	Test Location	4
2	Test Details	5
2.1	Radiated Spurious Emissions (Simultaneous Transmission)	5
3	Measurement Uncertainty	45



1 Report Summary

1.1 Report Modification Record

Alterations and additions to this report will be issued to the holders of each copy in the form of a complete document.

Issue	Description of Change	Date of Issue
1	First Issue	22-November-2022

Table 1

1.2 Introduction

Applicant	Apple Inc
Manufacturer	Apple Inc
Model Number(s)	A2779
Serial Number(s)	JM67M9K770
Hardware Version(s)	REV 1.0
Software Version(s)	22A31991j
Number of Samples Tested	1
Test Specification/Issue/Date	FCC 47 CFR Part 15: 2020 ISED RSS-247: Issue 2 (2017-02) ISED RSS-248: Issue 1 (2021-11) ISED RSS-GEN: Issue 5 (2018-04) + A2 (2021-02)
Order Number	0540246998
Start of Test	10-August-2022
Finish of Test	02-November-2022
Name of Engineer(s)	Mohammad Malik, Elliot Callender, James Woods, Taha Shafique and Ioan-Alexandru Bogatu
Related Document(s)	ANSI C63.10: 2013 ANSI C63.10: 2020 KDB 987594 D02 v01r01



1.3 Brief Summary of Results

A brief summary of the tests carried out in accordance with FCC 47 CFR Part 15, ISED RSS-247, ISED RSS-248 and ISED RSS-GEN is shown below.

Section	Specification Clause				Test Description	Result	Comments/Base Standard
	Part 15	RSS-247		RSS-GEN			
Configuration and Mode: CoTX - Bluetooth + 5 GHz WLAN							
2.1	15.209, 15.247(d) and 15.407(b)	5.5 and 6.2	-	8.9	Radiated Spurious Emissions (Simultaneous Transmission)	Pass	
Configuration and Mode: CoTX - Bluetooth + 6 GHz WLAN							
2.1	15.209, 15.247(d) and 15.407(b)	5.5 and 6.2	-	8.9	Radiated Spurious Emissions (Simultaneous Transmission)	Pass	
Configuration and Mode: CoTX - 2.4 GHz WLAN + Narrowband							
2.1	15.209, 15.247(d) and 15.407(b)	5.5	4.7	8.9	Radiated Spurious Emissions (Simultaneous Transmission)	Pass	

Table 2



1.4 Product Information

1.4.1 Technical Description

The equipment under test was an Apple laptop computer with Bluetooth® and IEEE 802.11 a/b/g/n/ac/ax Wi-Fi capabilities in the 2.4GHz, 5GHz and 6GHz bands.

1.5 Deviations from the Standard

No deviations from the applicable test standard were made during testing.

1.6 EUT Modification Record

The table below details modifications made to the EUT during the test programme.

The modifications incorporated during each test are recorded on the appropriate test pages.

Modification State	Description of Modification still fitted to EUT	Modification Fitted By	Date Modification Fitted
Model: A2779, Serial Number: JM67M9K770			
0	As supplied by the customer	Not Applicable	Not Applicable

Table 3

1.7 Test Location

TÜV SÜD conducted the following tests at our Concorde Park Test Laboratory.

Test Name	Name of Engineer(s)	Accreditation
Configuration and Mode: CoTX - Bluetooth + 5 GHz WLAN		
Radiated Spurious Emissions (Simultaneous Transmission)	Mohammad Malik, Elliot Callender, James Woods, Taha Shafique	UKAS
Configuration and Mode: CoTX - Bluetooth + 6 GHz WLAN		
Radiated Spurious Emissions (Simultaneous Transmission)	Mohammad Malik, Ioan-Alexandru Bogatu, Taha Shafique	UKAS
Configuration and Mode: CoTX - 2.4 GHz WLAN + Narrowband		
Radiated Spurious Emissions (Simultaneous Transmission)	Ioan-Alexandru Bogatu and Taha Shafique	UKAS

Table 4

Office Address:

TÜV SÜD
 Concorde Park
 Concorde Way
 Fareham
 Hampshire
 PO15 5FG
 United Kingdom



2 Test Details

2.1 Radiated Spurious Emissions (Simultaneous Transmission)

2.1.1 Specification Reference

FCC 47 CFR Part 15, Clause 15.209, 15.247(d) and 15.407(b)
ISED RSS-247, Clause 5.5 and 6.2
ISED RSS-248, Clause 4.7
ISED RSS-GEN, Clause 8.9

2.1.2 Equipment Under Test and Modification State

A2779, S/N: JM67M9K770 - Modification State 0

2.1.3 Date of Test

10-August-2022 to 02-November-2022

2.1.4 Test Method

CoTX - 2.4 GHz WLAN + Narrowband and CoTX - Bluetooth + 5 GHz WLAN

This test was performed in accordance with ANSI C63.10, clause 6.3, 6.5 and 6.6.

The EUT was placed on the non-conducting platform in a manner typical of a normal installation. Ports on the EUT were terminated with loads as described in ANSI C63.4 clause 6.2.4 for each type of port on the EUT.

For frequencies > 1 GHz, plots for average measurements were taken in accordance with ANSI C63.10, clause 4.1.4.2.5 to characterize the EUT. Where emissions were detected, final average measurements were taken in accordance with ANSI C63.10, clause 4.1.4.2.2, 11.11, 11.12, 12.7.2 or 12.7.3 depending on the nature of the emission measured.

The plots shown are the characterisation of the EUT. The limits on the plots represent the most stringent case for restricted bands, (74/54 dBuV/m) when compared to non-restricted band limits. The limits shown have been used as a threshold to determine where further measurements are necessary. Where results are within 10 dB of the limits shown on the plots, further investigation was carried out and reported in results tables.

The following conversion can be applied to convert from dB μ V/m to μ V/m:
 $10^{(\text{Field Strength in dB}\mu\text{V/m}/20)}$.

At a measurement distance of 1 meter the limit line was increased by $20 \cdot \text{LOG}(3/1) = 9.54$ dB.

CoTX - Bluetooth + 6 GHz WLAN

Testing was performed in accordance with KDB 987594 D02 and ANSI C63.10, clause 6.3, 6.5 and 6.6

The EUT was placed on the non-conducting platform in a manner typical of a normal installation. Ports on the EUT were terminated with loads as described in ANSI C63.4 clause 6.2.4 for each type of port on the EUT.

For frequencies > 1 GHz, plots for average measurements were taken in accordance with ANSI C63.10, clause 4.1.4.2.5 to characterize the EUT. Where emissions were detected, final average measurements were taken in accordance with ANSI C63.10, clause 4.1.4.2.2, 11.11, 11.12, 12.7.2 or 12.7.3 depending on the nature of the emission measured.

The plots shown are the characterisation of the EUT. The limits on the plots represent the most stringent case for restricted bands, (74/54 dBuV/m) when compared to non-restricted band limits. The limits shown have been used as a threshold to determine where further measurements are necessary. Where results are within 10 dB of the limits shown on the plots, further investigation was carried out and reported in results tables.

The following conversion can be applied to convert from dBuV/m to uV/m:
 $10^{(Field\ Strength\ in\ dBuV/m/20)}$.

At a measurement distance of 1 meter the limit line was increased by $20 \cdot \log(3/1) = 9.54\ dB$.

2.1.5 Example Test Setup Diagram

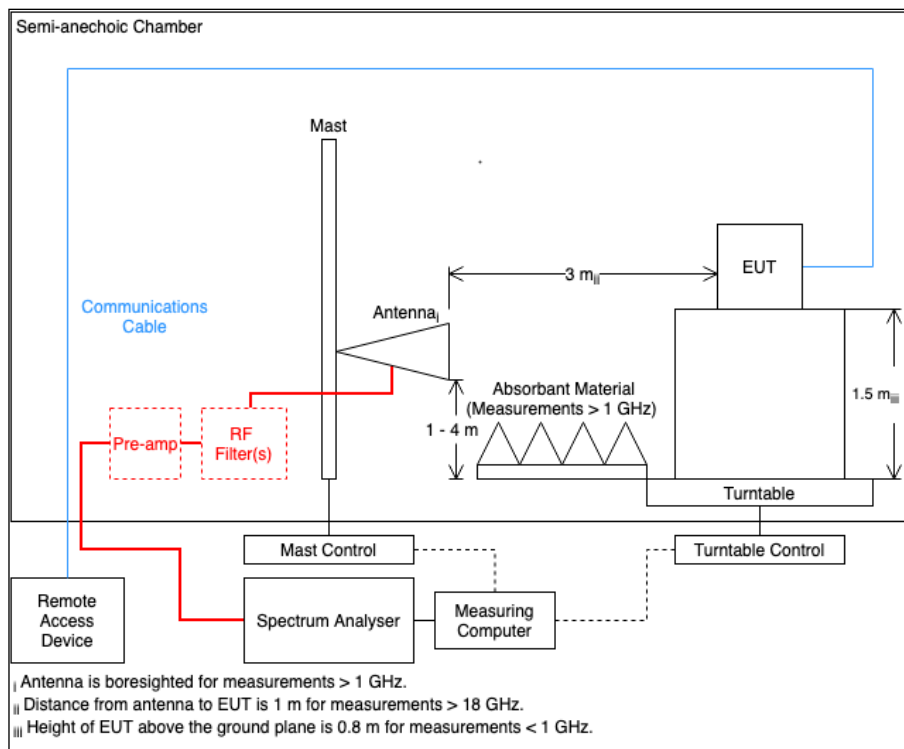

Figure 1

2.1.6 Environmental Conditions

Ambient Temperature 20.2 - 22.5 °C
 Relative Humidity 45.7 - 56.7 %



2.1.7 Test Results

CoTX - Bluetooth + 5 GHz WLAN

Frequency (MHz)	Level (dBuV/m)	Limit (dBuV/m)	Margin (dB)	Detector	Angle (°)	Height (cm)	Polarisation
2242.760	58.10	74.00	-15.90	Peak	139	388	Vertical
2335.399	54.33	74.00	-19.67	Peak	85	336	Horizontal
2348.618	67.44	74.00	-6.56	Peak	156	398	Vertical
2360.713	37.31	54.00	-16.69	RMS	138	391	Vertical
4803.394	35.72	54.00	-18.28	CISPR Avg	144	260	Vertical

Table 5 - U-NII-2C - 5680 MHz (CH136), VHT20, CDD, Core 0 + Core 1 and 2402 MHz (CH0), 2-DH5, ePA, Core 0 + Core 1, 30 MHz to 40 GHz

No other emissions found within 10 dB of the limit.

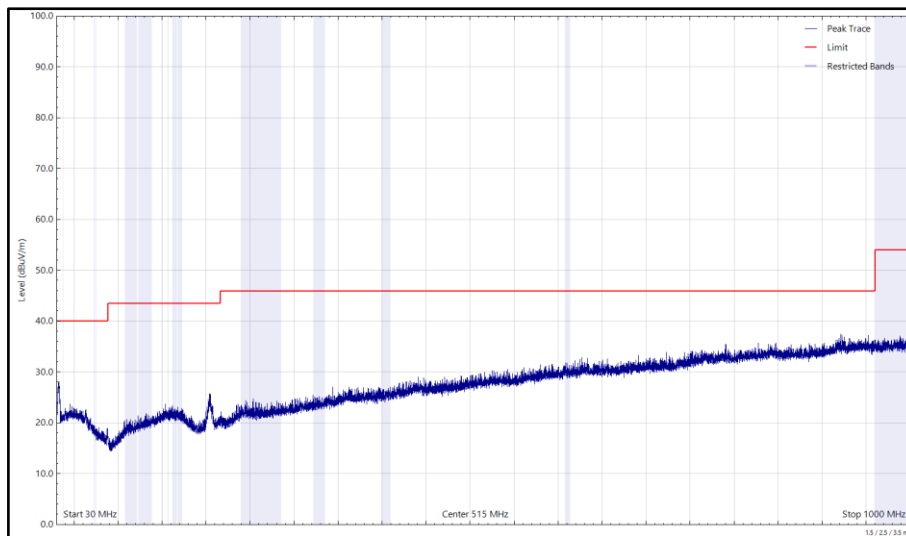

Figure 2 - U-NII-2C - 5680 MHz (CH136), VHT20, CDD, Core 0 + Core 1 and 2402 MHz (CH0), 2-DH5, ePA, Core 0 + Core 1, 30 MHz to 1 GHz, Horizontal (Peak)

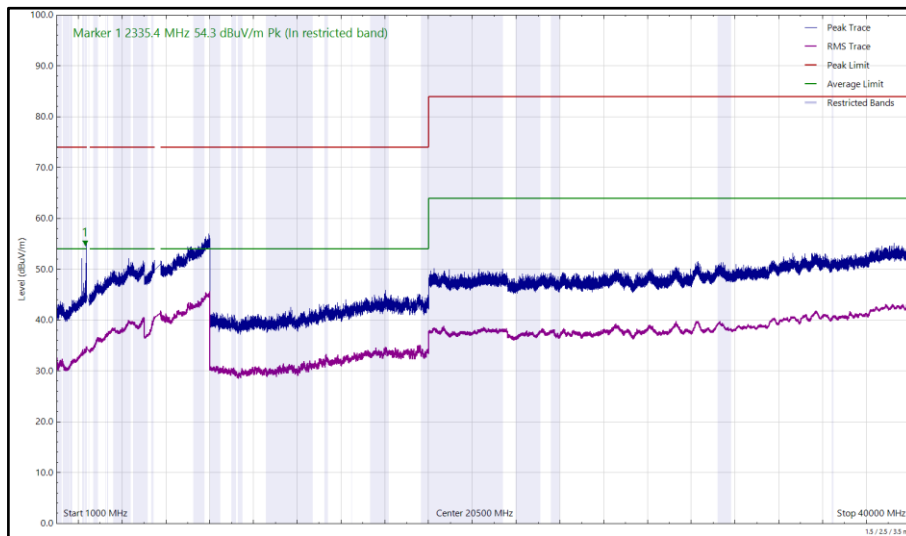

Figure 3 - U-NII-2C - 5680 MHz (CH136), VHT20, CDD, Core 0 + Core 1 and 2402 MHz (CH0), 2-DH5, ePA, Core 0 + Core 1, 1 GHz to 40 GHz, Horizontal

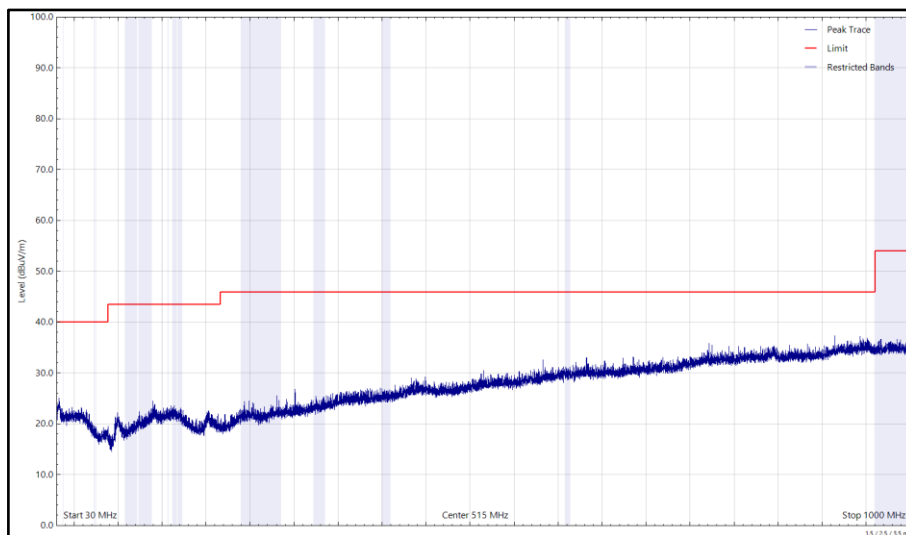

Figure 4 - U-NII-2C - 5680 MHz (CH136), VHT20, CDD, Core 0 + Core 1 and 2402 MHz (CH0), 2-DH5, ePA, Core 0 + Core 1, 30 MHz to 1 GHz, Vertical (Peak)

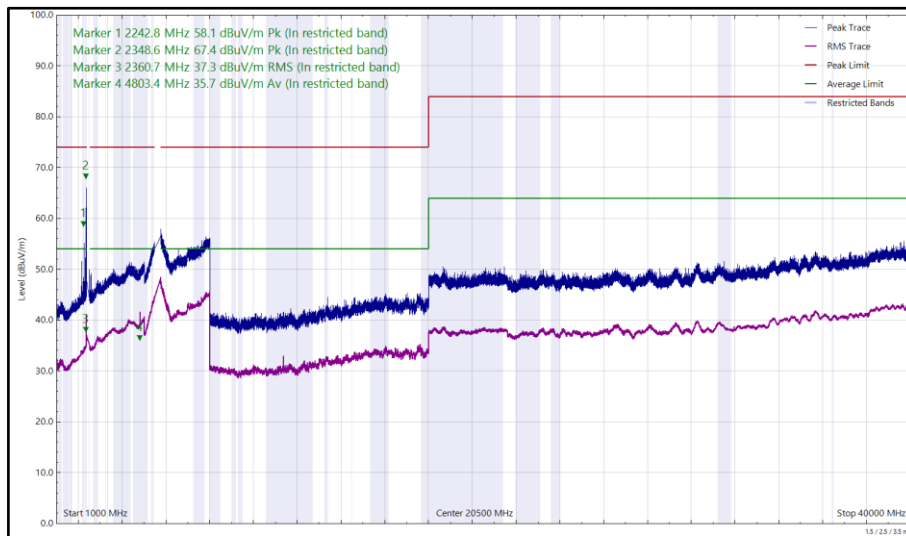

Figure 5 - U-NII-2C - 5680 MHz (CH136), VHT20, CDD, Core 0 + Core 1 and 2402 MHz (CH0), 2-DH5, ePA, Core 0 + Core 1, 1 GHz to 40 GHz, Vertical



Frequency (MHz)	Level (dBuV/m)	Limit (dBuV/m)	Margin (dB)	Detector	Angle (°)	Height (cm)	Polarisation
2335.015	57.54	74.00	-16.46	Peak	271	170	Vertical

Table 6 - U-NII-1 - 5200 MHz (CH40), VHT20, CDD, Core 0 + Core 1 and 2402 MHz (CH0), 2-DH5, ePA, Core 0 + Core 1, 30 MHz to 40 GHz

No other emissions found within 10 dB of the limit.

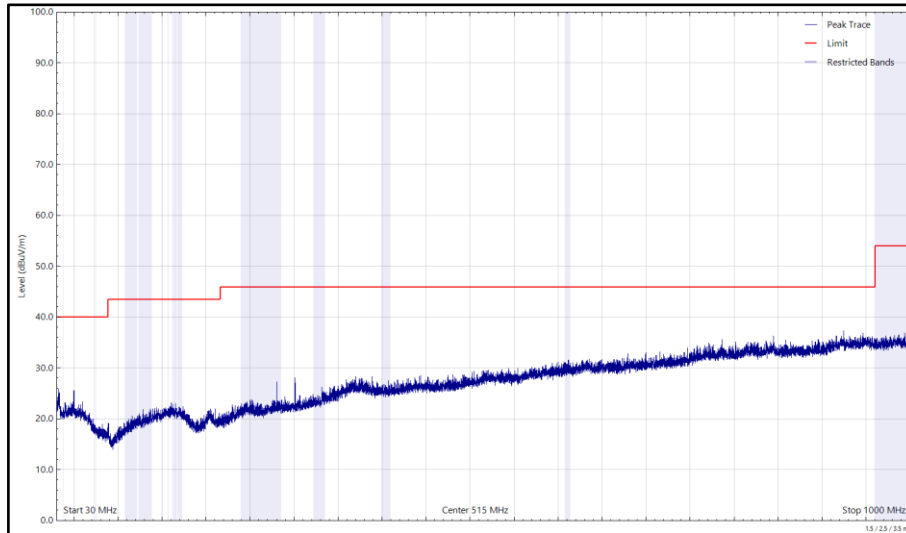

Figure 6 - U-NII-1 - 5200 MHz (CH40), VHT20, CDD, Core 0 + Core 1 and 2402 MHz (CH0), 2-DH5, ePA, Core 0 + Core 1, 30 MHz to 1 GHz, Horizontal (Peak)

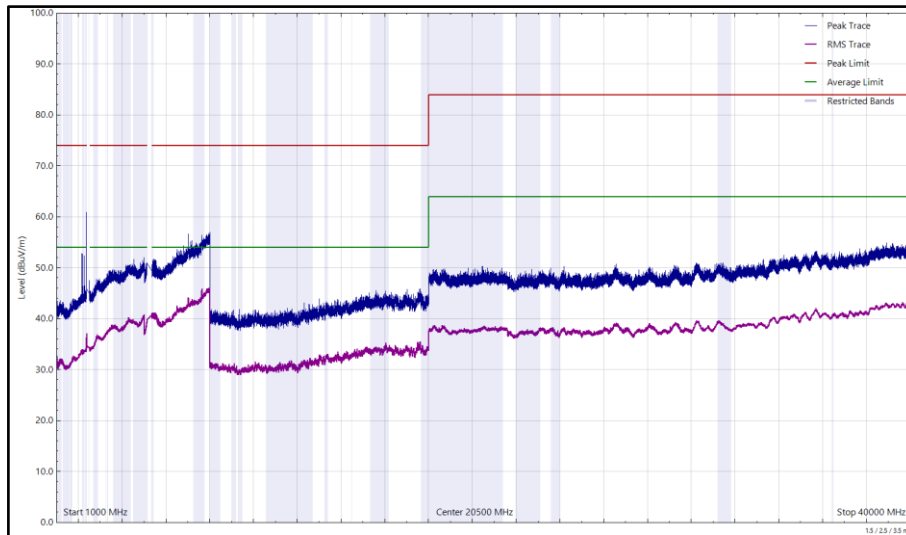

Figure 7 - U-NII-1 - 5200 MHz (CH40), VHT20, CDD, Core 0 + Core 1 and 2402 MHz (CH0), 2-DH5, ePA, Core 0 + Core 1, 1 GHz to 40 GHz, Horizontal

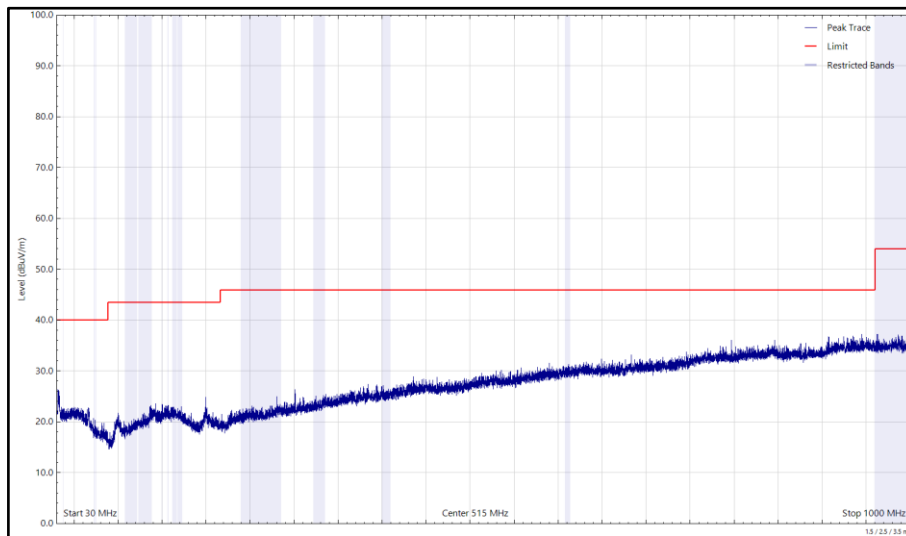

Figure 8 - U-NII-1 - 5200 MHz (CH40), VHT20, CDD, Core 0 + Core 1 and 2402 MHz (CH0), 2-DH5, ePA, Core 0 + Core 1, 30 MHz to 1 GHz, Vertical (Peak)

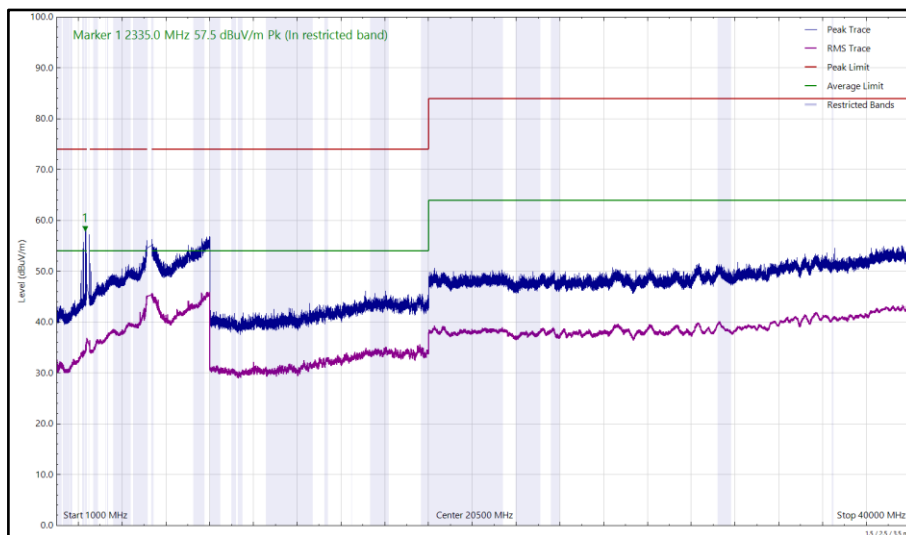

Figure 9 - U-NII-1 - 5200 MHz (CH40), VHT20, CDD, Core 0 + Core 1 and 2402 MHz (CH0), 2-DH5, ePA, Core 0 + Core 1, 1 GHz to 40 GHz, Vertical



Frequency (MHz)	Level (dBuV/m)	Limit (dBuV/m)	Margin (dB)	Detector	Angle (°)	Height (cm)	Polarisation
4959.585	54.75	74.00	-19.25	Peak	147	293	Vertical

Table 7 - U-NII-2C - 5680 MHz (CH136), VHT20, CDD, Core 0 + Core 1 and 2480 MHz (CH78), 2-DH5, ePA, Core 0 + Core 1, 30 MHz to 40 GHz

No other emissions found within 10 dB of the limit.

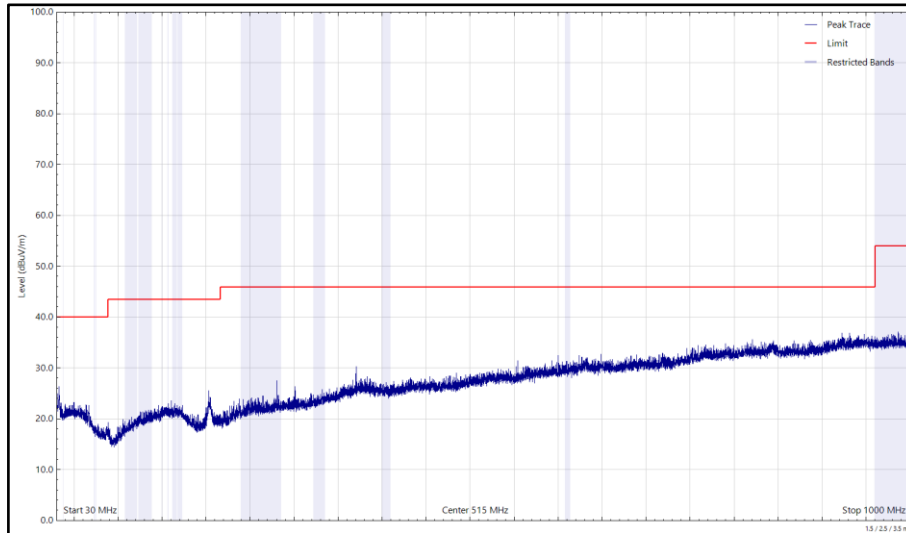

Figure 10 - U-NII-2C - 5680 MHz (CH136), VHT20, CDD, Core 0 + Core 1 and 2480 MHz (CH78), 2-DH5, ePA, Core 0 + Core 1, 30 MHz to 1 GHz, Horizontal (Peak)

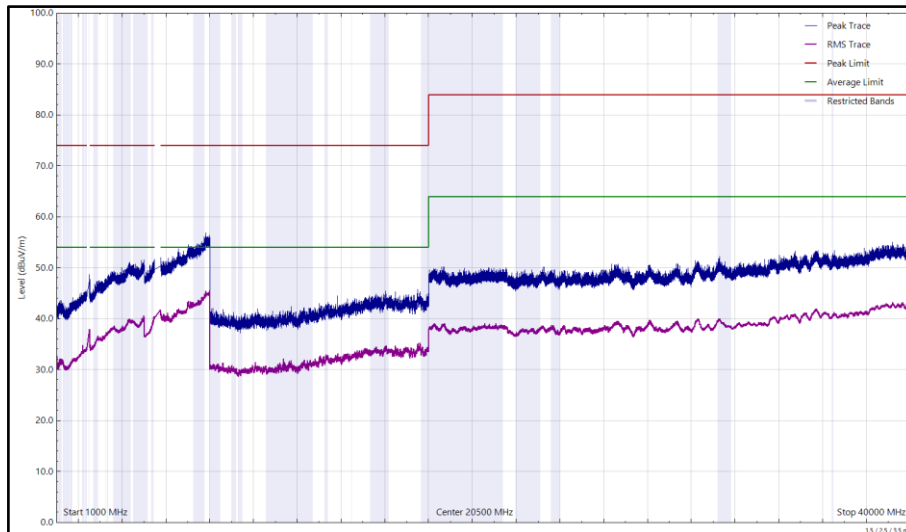

Figure 11 - U-NII-2C - 5680 MHz (CH136), VHT20, CDD, Core 0 + Core 1 and 2480 MHz (CH78), 2-DH5, ePA, Core 0 + Core 1, 1 GHz to 40 GHz, Horizontal

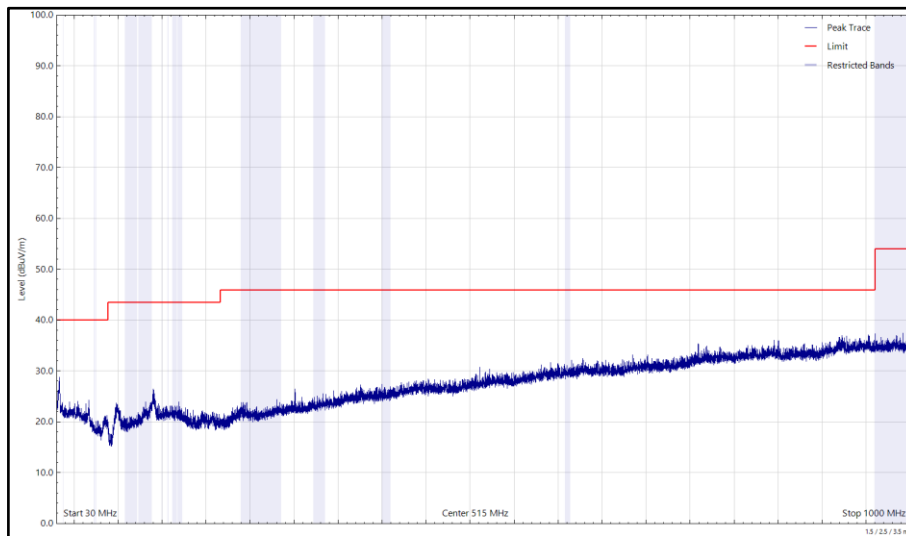

Figure 12 - U-NII-2C - 5680 MHz (CH136), VHT20, CDD, Core 0 + Core 1 and 2480 MHz (CH78), 2-DH5, ePA, Core 0 + Core 1, 30 MHz to 1 GHz, Vertical (Peak)

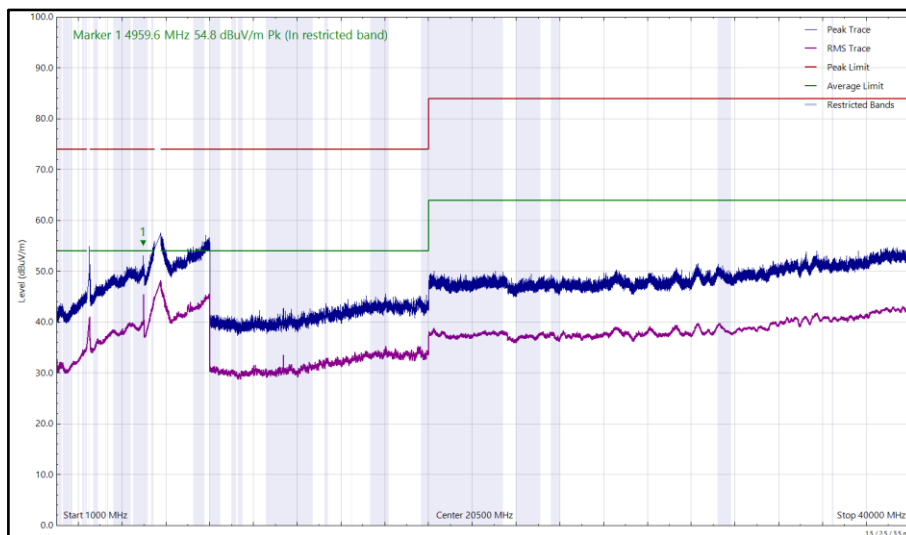

Figure 13 - U-NII-2C - 5680 MHz (CH136), VHT20, CDD, Core 0 + Core 1 and 2480 MHz (CH78), 2-DH5, ePA, Core 0 + Core 1, 1 GHz to 40 GHz, Vertical



Frequency (MHz)	Level (dBuV/m)	Limit (dBuV/m)	Margin (dB)	Detector	Angle (°)	Height (cm)	Polarisation
2241.319	34.46	54.00	-19.54	RMS	267	160	Vertical
2241.702	34.52	54.00	-19.48	RMS	80	336	Horizontal
4960.287	56.61	74.00	-17.39	Peak	152	276	Vertical

Table 8 - U-NII-1 - 5200 MHz (CH40), VHT20, CDD, Core 0 + Core 1 and 2480 MHz (CH78), 2-DH5, ePA, Core 0 + Core 1, 30 MHz to 40 GHz

No other emissions found within 10 dB of the limit.

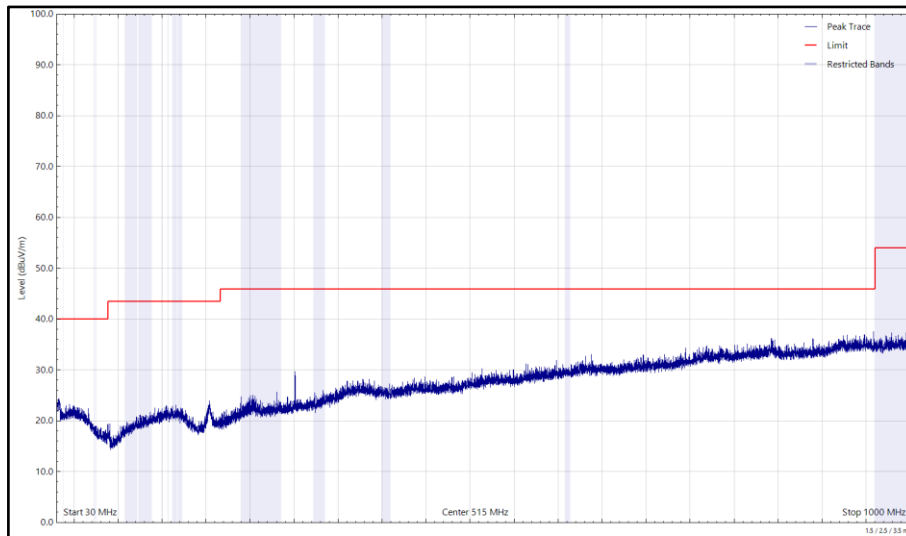

Figure 14 - U-NII-1 - 5200 MHz (CH40), VHT20, CDD, Core 0 + Core 1 and 2480 MHz (CH78), 2-DH5, ePA, Core 0 + Core 1, 30 MHz to 1 GHz, Horizontal (Peak)

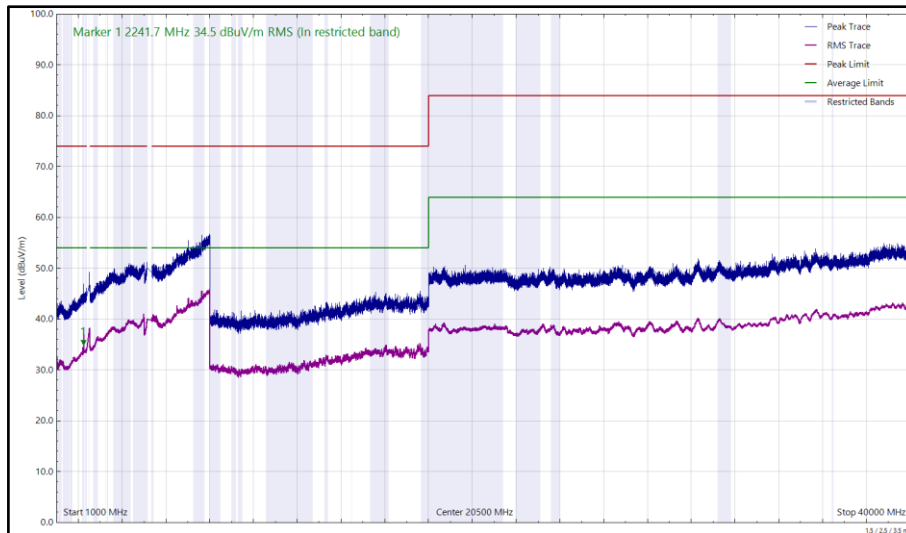

Figure 15 - U-NII-1 - 5200 MHz (CH40), VHT20, CDD, Core 0 + Core 1 and 2480 MHz (CH78), 2-DH5, ePA, Core 0 + Core 1, 1 GHz to 40 GHz, Horizontal

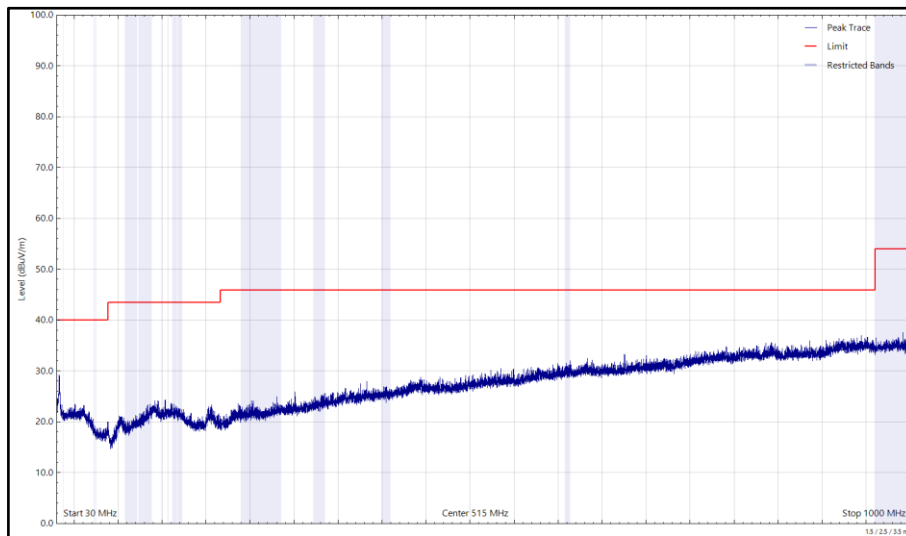

Figure 16 - U-NII-1 - 5200 MHz (CH40), VHT20, CDD, Core 0 + Core 1 and 2480 MHz (CH78), 2-DH5, ePA, Core 0 + Core 1, 30 MHz to 1 GHz, Vertical (Peak)

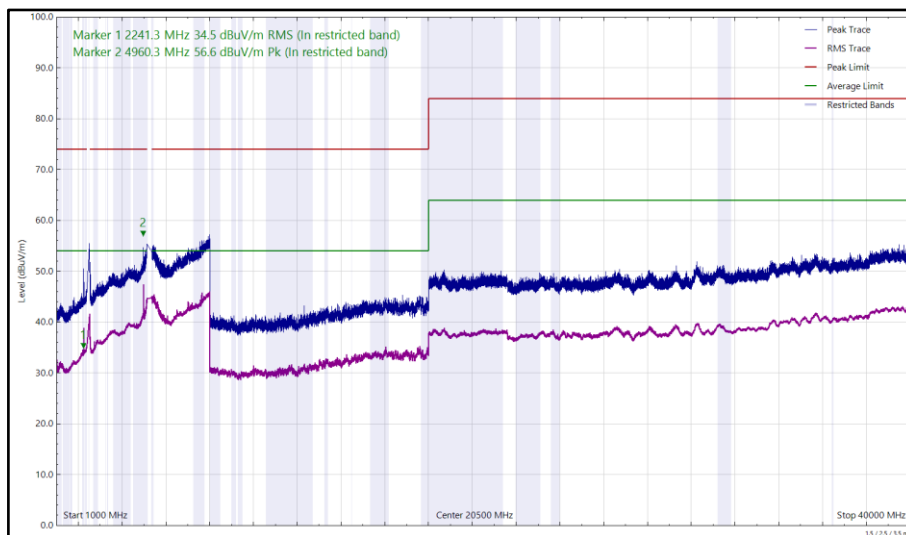

Figure 17 - U-NII-1 - 5200 MHz (CH40), VHT20, CDD, Core 0 + Core 1 and 2480 MHz (CH78), 2-DH5, ePA, Core 0 + Core 1, 1 GHz to 40 GHz, Vertical



FCC 47 CFR Part 15, ISED RSS-247 and ISED RSS-GEN

The least stringent limit from the applicable rule parts was used to determine compliance for Radiated Emissions testing of multiple transmission sources.

The least stringent applicable limit was:

Clause	Limit
Part 15.247 (d) / RSS-247 Clause 5.5	-20 dBc
Part 15.407 (b) / RSS-247 Clause 6.2	-27 dBm (EIRP) / 68 dB μ V/m at 3m.
Part 15.209 / RSS-GEN Clause 8.9	Peak: 74 dB μ V/m at 3m, Average 54 dB μ V/m at 3m

Table 9



CoTX - Bluetooth + 6 GHz WLAN

Frequency (MHz)	Level (dBuV/m)	Limit (dBuV/m)	Margin (dB)	Detector	Angle (°)	Height (cm)	Polarisation
*							

Table 10 - U-NII-5 - 5955 MHz (CH1), HE20, SU, CDD, Core 0 + Core 1 and 2402 MHz (CH0), 2-DH5, ePA, Core 0 + Core 1, 30 MHz to 40 GHz

*No emissions found within 10 dB of the limit.

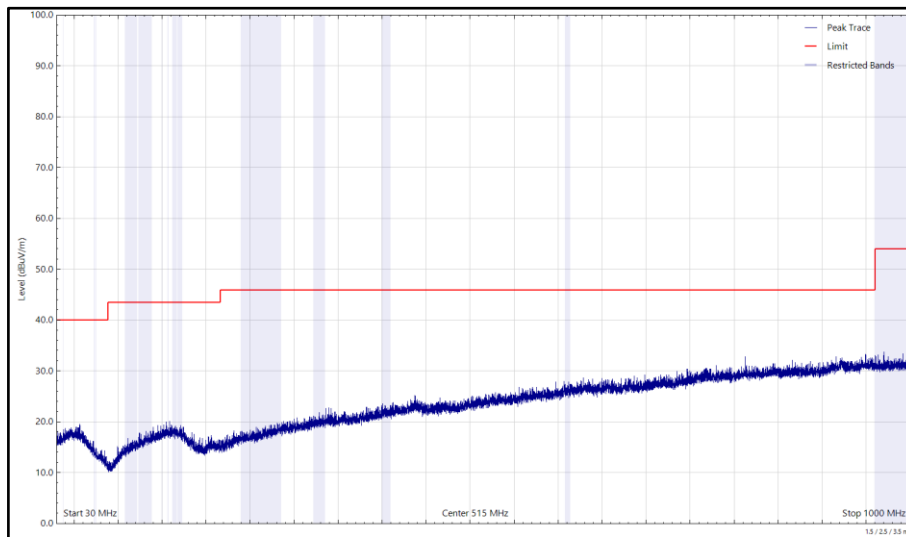

Figure 18 - U-NII-5 - 5955 MHz (CH1), HE20, SU, CDD, Core 0 + Core 1 and 2402 MHz (CH0), 2-DH5, ePA, Core 0 + Core 1, 30 MHz to 1 GHz, Horizontal (Peak)

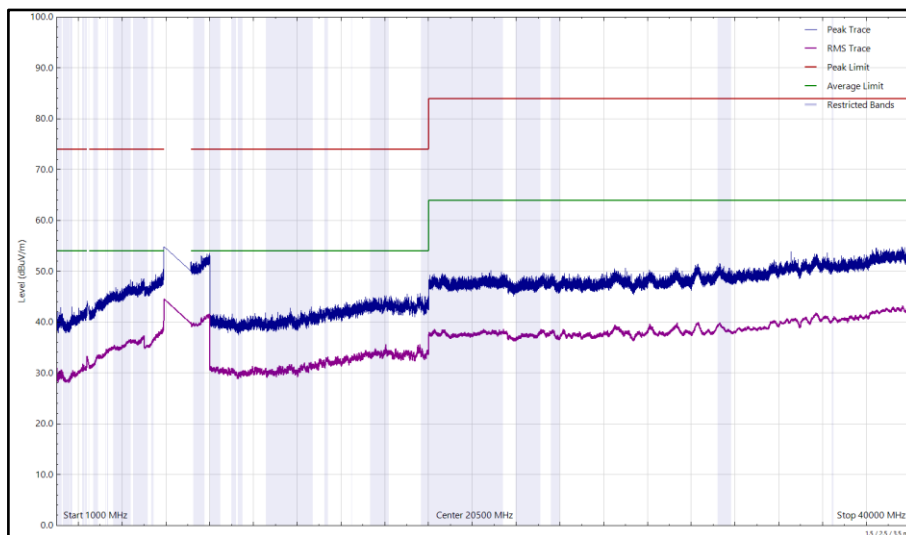

Figure 19 - U-NII-5 - 5955 MHz (CH1), HE20, SU, CDD, Core 0 + Core 1 and 2402 MHz (CH0), 2-DH5, ePA, Core 0 + Core 1, 1 GHz to 40 GHz, Horizontal

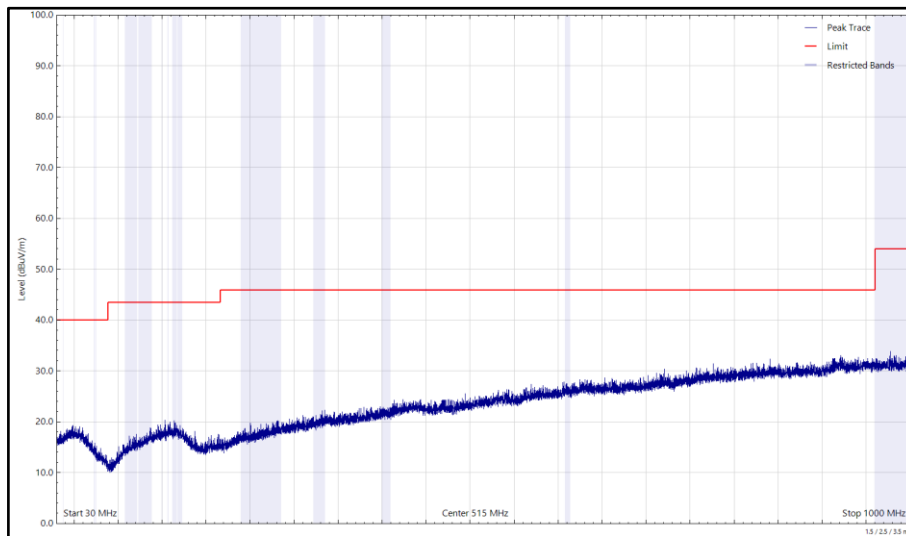

Figure 20 - U-NII-5 - 5955 MHz (CH1), HE20, SU, CDD, Core 0 + Core 1 and 2402 MHz (CH0), 2-DH5, ePA, Core 0 + Core 1, 30 MHz to 1 GHz, Vertical (Peak)

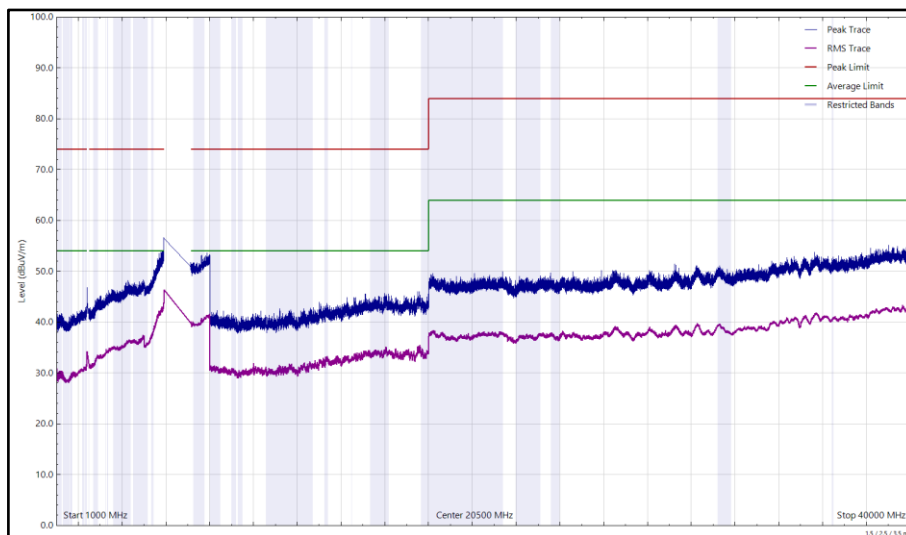

Figure 21 - U-NII-5 - 5955 MHz (CH1), HE20, SU, CDD, Core 0 + Core 1 and 2402 MHz (CH0), 2-DH5, ePA, Core 0 + Core 1, 1 GHz to 40 GHz, Vertical



Frequency (MHz)	Level (dBuV/m)	Limit (dBuV/m)	Margin (dB)	Detector	Angle (°)	Height (cm)	Polarisation
5336.574	56.30	74.00	-17.70	Peak	129	327	Vertical
5336.693	42.70	54.00	-11.30	CISPR Avg	129	342	Vertical
5337.600	35.90	54.00	-18.10	CISPR Avg	247	394	Horizontal

Table 11 - U-NII-8 - 7115 MHz (CH233), HE20, SU, CDD, Core 0 + Core 1 and 2402 MHz (CH0), 2-DH5, ePA, Core 0 + Core 1, 30 MHz to 40 GHz

No other emissions found within 10 dB of the limit.

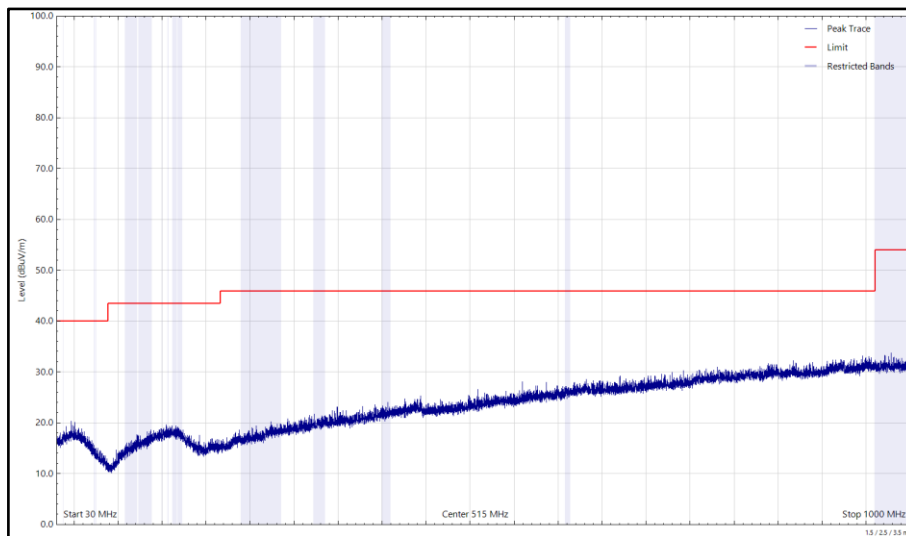

Figure 22 - U-NII-8 - 7115 MHz (CH233), HE20, SU, CDD, Core 0 + Core 1 and 2402 MHz (CH0), 2-DH5, ePA, Core 0 + Core 1, 30 MHz to 1 GHz, Horizontal (Peak)

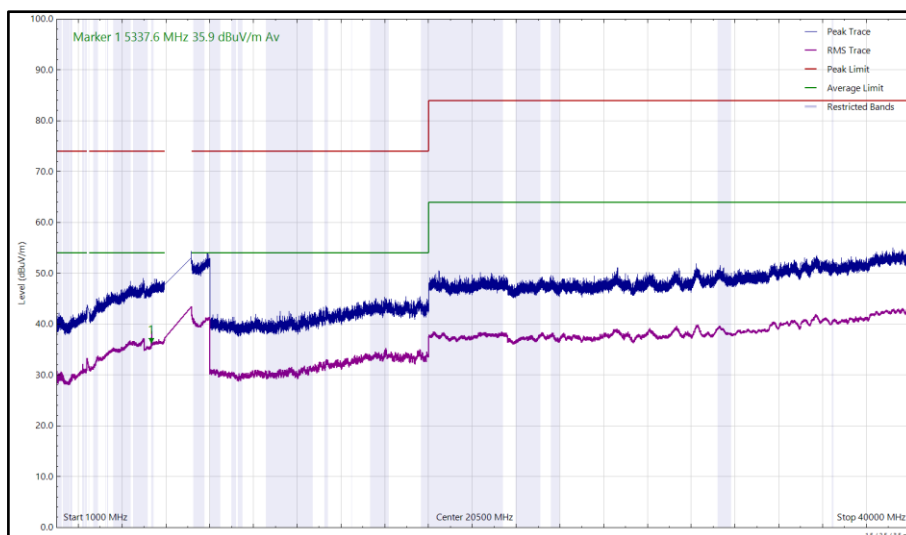

Figure 23 - U-NII-8 - 7115 MHz (CH233), HE20, SU, CDD, Core 0 + Core 1 and 2402 MHz (CH0), 2-DH5, ePA, Core 0 + Core 1, 1 GHz to 40 GHz, Horizontal

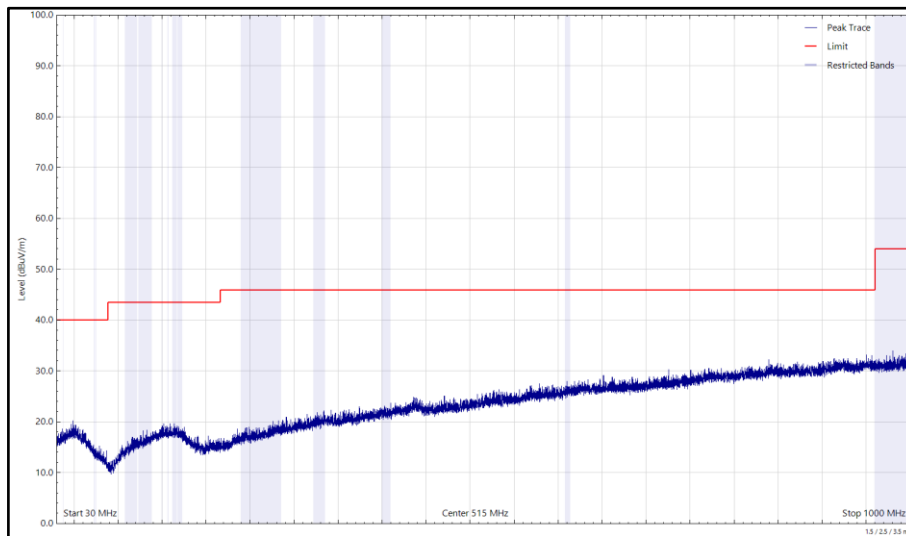

Figure 24 - U-NII-8 - 7115 MHz (CH233), HE20, SU, CDD, Core 0 + Core 1 and 2402 MHz (CH0), 2-DH5, ePA, Core 0 + Core 1, 30 MHz to 1 GHz, Vertical (Peak)

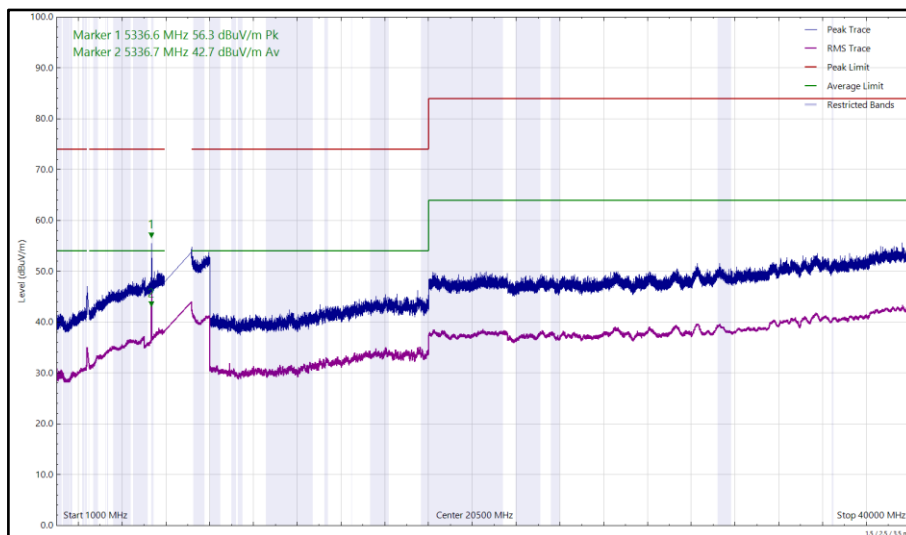

Figure 25 - U-NII-8 - 7115 MHz (CH233), HE20, SU, CDD, Core 0 + Core 1 and 2402 MHz (CH0), 2-DH5, ePA, Core 0 + Core 1, 1 GHz to 40 GHz, Vertical



Frequency (MHz)	Level (dBuV/m)	Limit (dBuV/m)	Margin (dB)	Detector	Angle (°)	Height (cm)	Polarisation
*							

Table 12 - U-NII-5 - 5955 MHz (CH1), HE20, SU, CDD, Core 0 + Core 1 and 2480 MHz (CH78), 2-DH5, ePA, Core 0 + Core 1, 30 MHz to 40 GHz

*No emissions found within 10 dB of the limit.

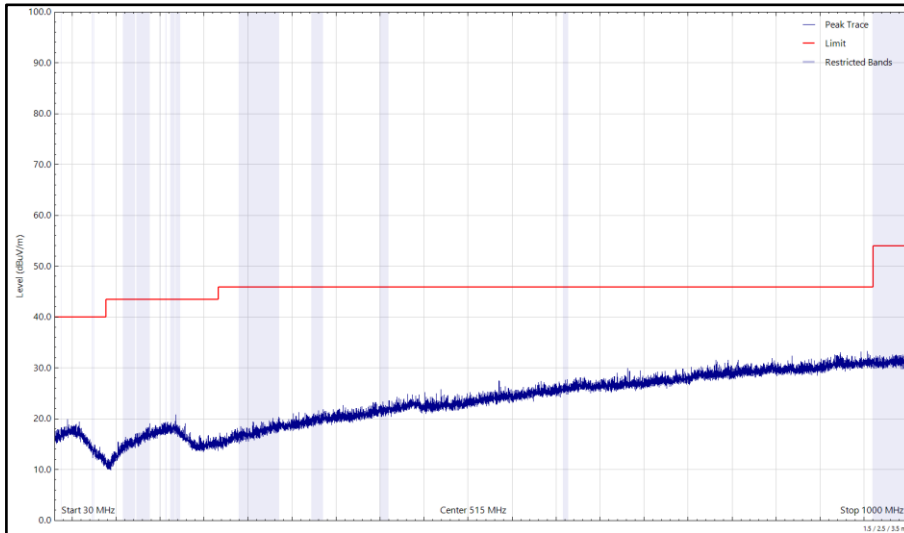

Figure 26 - U-NII-5 - 5955 MHz (CH1), HE20, SU, CDD, Core 0 + Core 1 and 2480 MHz (CH78), 2-DH5, ePA, Core 0 + Core 1, 30 MHz to 1 GHz, Horizontal (Peak)

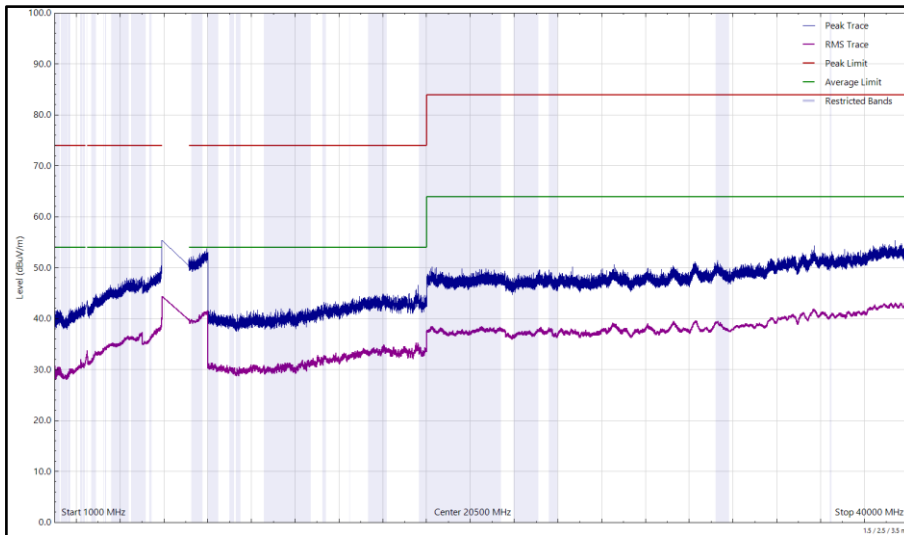

Figure 27 - U-NII-5 - 5955 MHz (CH1), HE20, SU, CDD, Core 0 + Core 1 and 2480 MHz (CH78), 2-DH5, ePA, Core 0 + Core 1, 1 GHz to 40 GHz, Horizontal

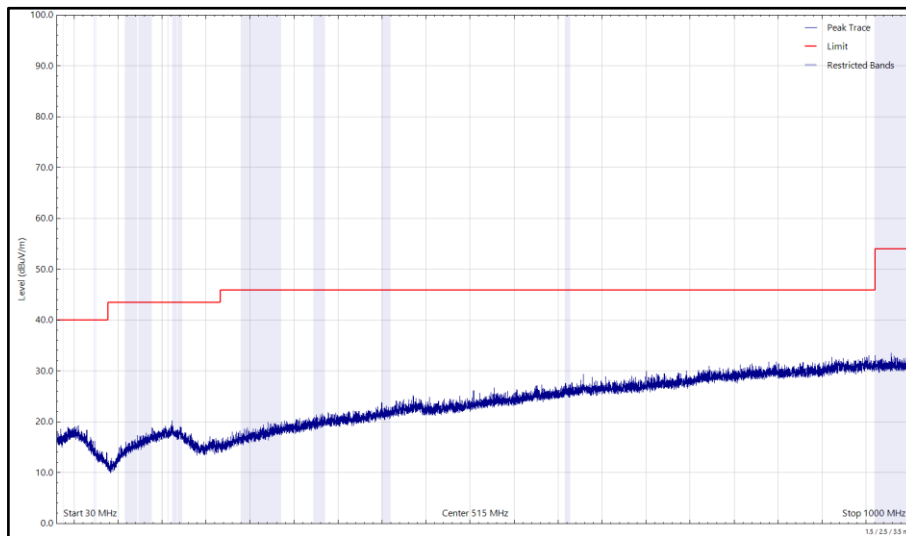

Figure 28 - U-NII-5 - 5955 MHz (CH1), HE20, SU, CDD, Core 0 + Core 1 and 2480 MHz (CH78), 2-DH5, ePA, Core 0 + Core 1, 30 MHz to 1 GHz, Vertical (Peak)

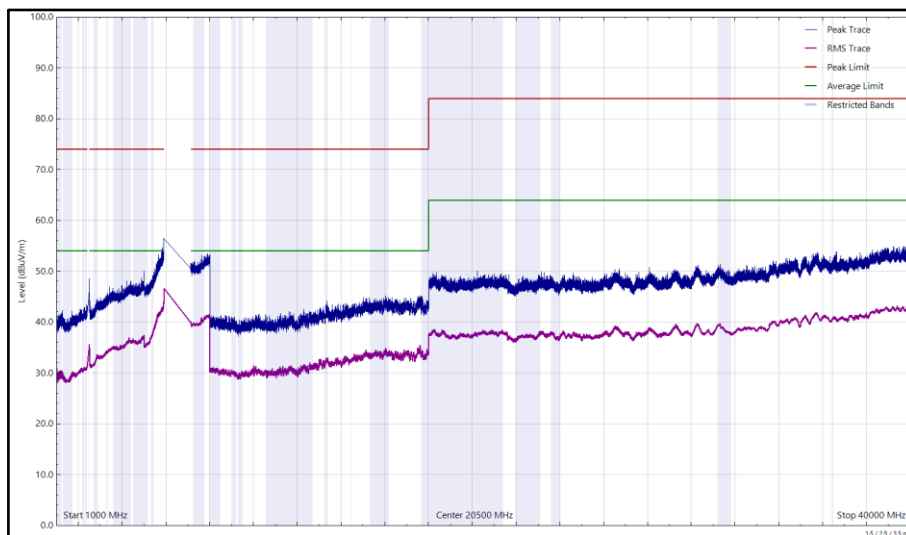

Figure 29 - U-NII-5 - 5955 MHz (CH1), HE20, SU, CDD, Core 0 + Core 1 and 2480 MHz (CH78), 2-DH5, ePA, Core 0 + Core 1, 1 GHz to 40 GHz, Vertical



Frequency (MHz)	Level (dBuV/m)	Limit (dBuV/m)	Margin (dB)	Detector	Angle (°)	Height (cm)	Polarisation
5333.638	54.57	74.00	-19.43	Peak	158	275	Vertical
5335.650	39.55	54.00	-14.45	CISPR Avg	158	104	Vertical

Table 13 - U-NII-8 - 7115 MHz (CH233), HE20, SU, CDD, Core 0 + Core 1 and 2480 MHz (CH78), 2-DH5, ePA, Core 0 + Core 1, 30 MHz to 40 GHz

No other emissions found within 10 dB of the limit.

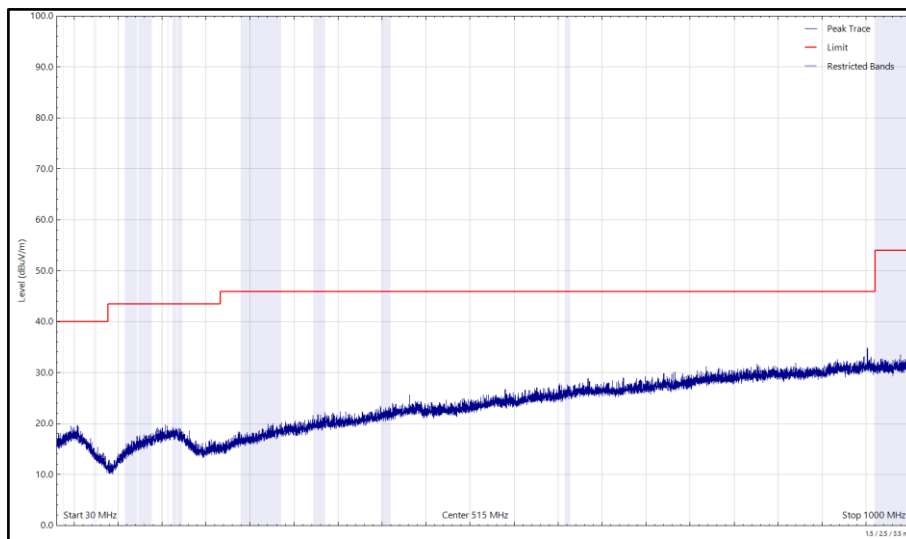

Figure 30 - U-NII-8 - 7115 MHz (CH233), HE20, SU, CDD, Core 0 + Core 1 and 2480 MHz (CH78), 2-DH5, ePA, Core 0 + Core 1, 30 MHz to 1 GHz, Horizontal (Peak)

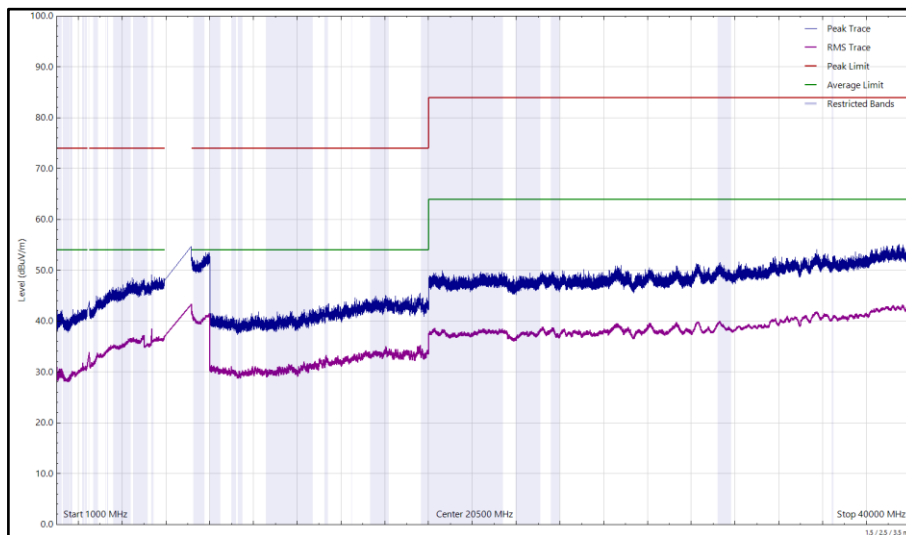

Figure 31 - U-NII-8 - 7115 MHz (CH233), HE20, SU, CDD, Core 0 + Core 1 and 2480 MHz (CH78), 2-DH5, ePA, Core 0 + Core 1, 1 GHz to 40 GHz, Horizontal

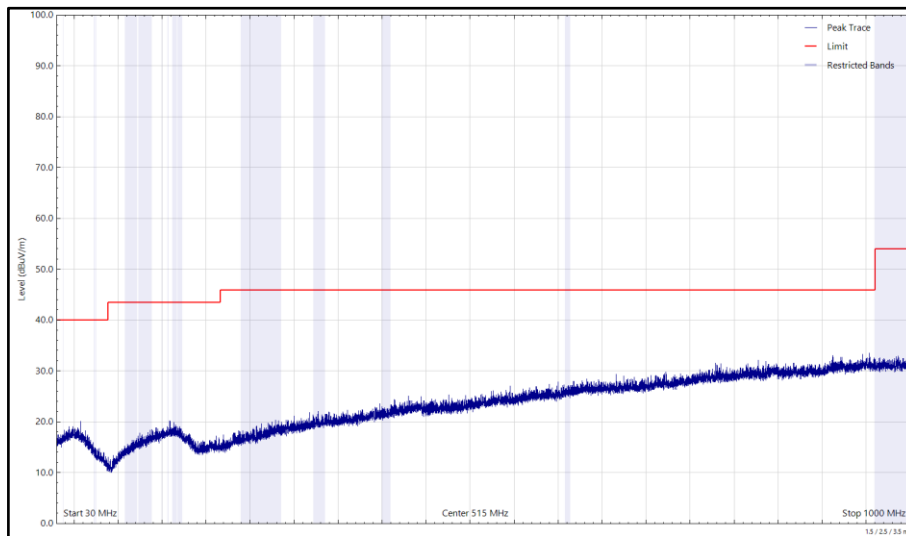

Figure 32 - U-NII-8 - 7115 MHz (CH233), HE20, SU, CDD, Core 0 + Core 1 and 2480 MHz (CH78), 2-DH5, ePA, Core 0 + Core 1, 30 MHz to 1 GHz, Vertical (Peak)

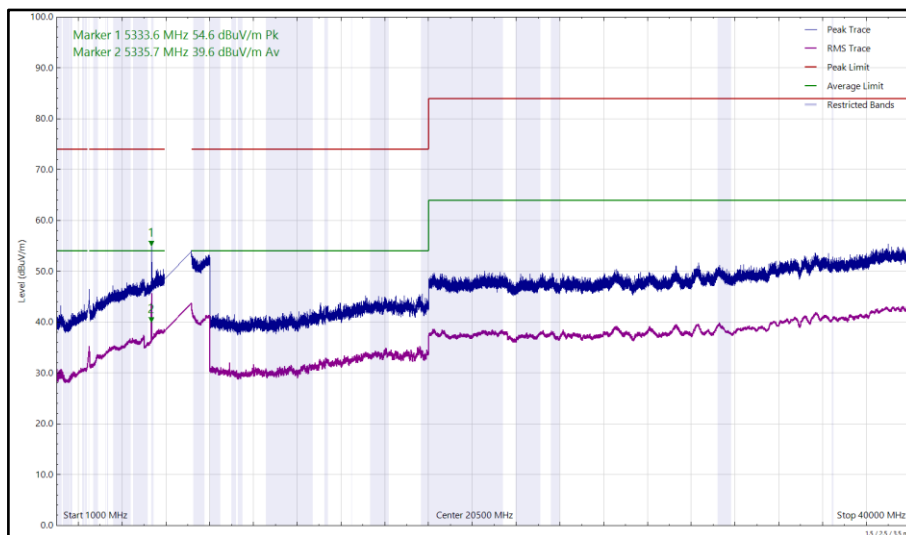

Figure 33 - U-NII-8 - 7115 MHz (CH233), HE20, SU, CDD, Core 0 + Core 1 and 2480 MHz (CH78), 2-DH5, ePA, Core 0 + Core 1, 1 GHz to 40 GHz, Vertical



FCC 47 CFR Part 15, ISED RSS-247, ISED RSS-248 and ISED RSS-GEN

The least stringent limit from the applicable rule parts was used to determine compliance for Radiated Emissions testing of multiple transmission sources.

The least stringent applicable limit was:

Clause	Limit
Part 15.247 (d) / RSS-247 Clause 5.5	-20 dBc
Part 15.407 (b) / RSS-248 Clause 4.7.2	Peak: -7 dBm/MHz e.i.r.p, Average: -27 dBm/MHz e.i.r.p
Part 15.209 / RSS-GEN Clause 8.9	Peak: 74 dB μ V/m at 3m, Average 54 dB μ V/m at 3m

Table 14



CoTX - 2.4 GHz WLAN + Narrowband

Frequency (MHz)	Level (dBuV/m)	Limit (dBuV/m)	Margin (dB)	Detector	Angle (°)	Height (cm)	Polarisation
280.005	26.82	46.00	-19.18	Q-Peak	120	110	Horizontal
1736.435	30.21	54.00	-23.79	RMS	242	380	Vertical
1744.856	30.22	54.00	-23.78	RMS	297	317	Horizontal

Table 15 - 2412 MHz (CH1), HT20, Core 0 and 5162 MHz, HDR4, ePA, Core 1, 30 MHz to 40 GHz

No other emissions found within 10 dB of the limit.

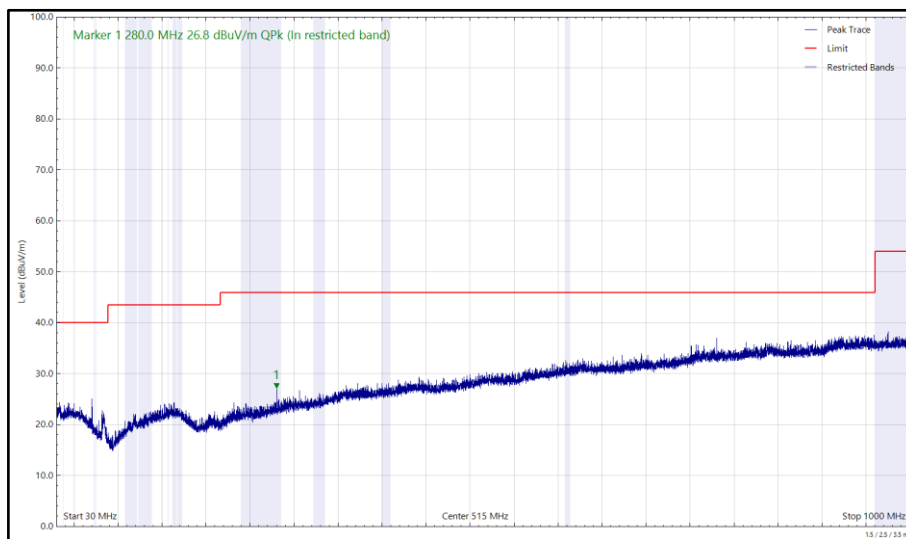

Figure 34 - 2412 MHz (CH1), HT20, Core 0 and 5162 MHz, HDR4, ePA, Core 1, 30 MHz to 1 GHz, Horizontal (Peak)

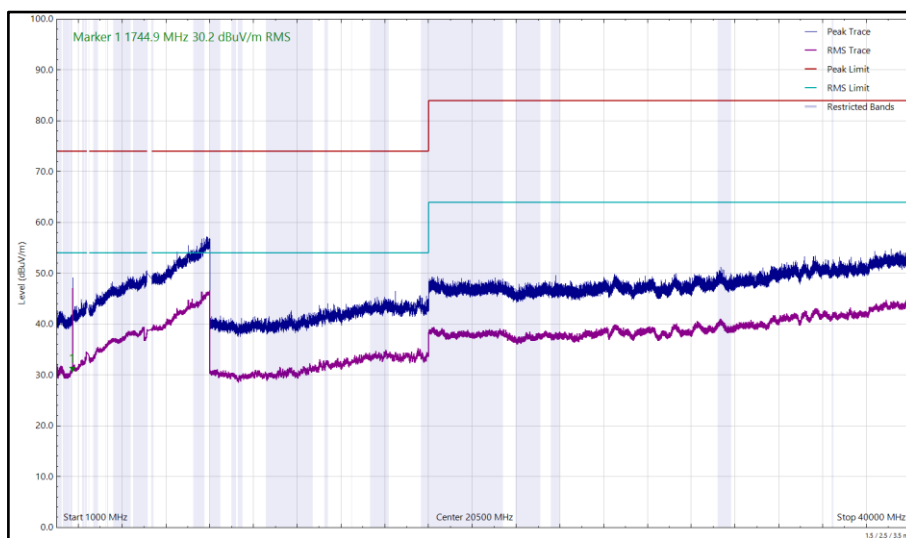

Figure 35 - 2412 MHz (CH1), HT20, Core 0 and 5162 MHz, HDR4, ePA, Core 1, 1 GHz to 40 GHz, Horizontal

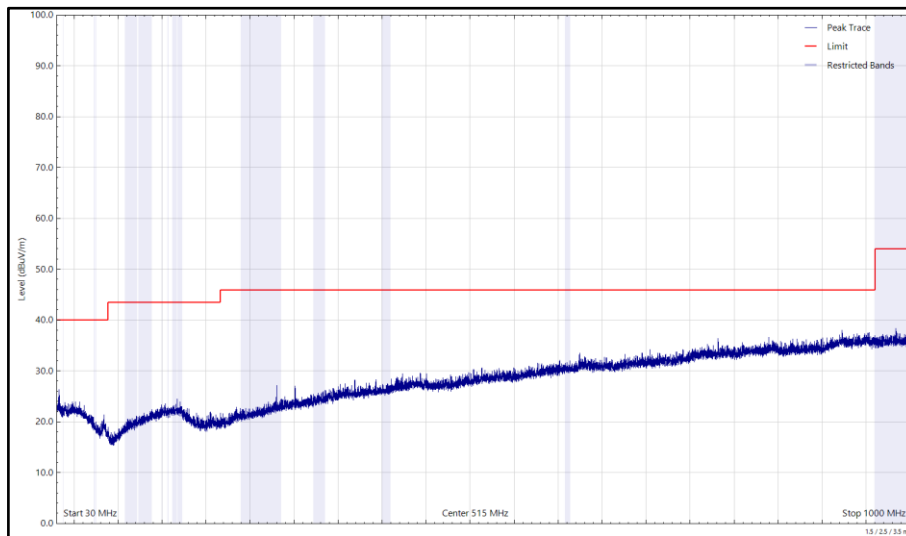

Figure 36 - 2412 MHz (CH1), HT20, Core 0 and 5162 MHz, HDR4, ePA, Core 1, 30 MHz to 1 GHz, Vertical (Peak)

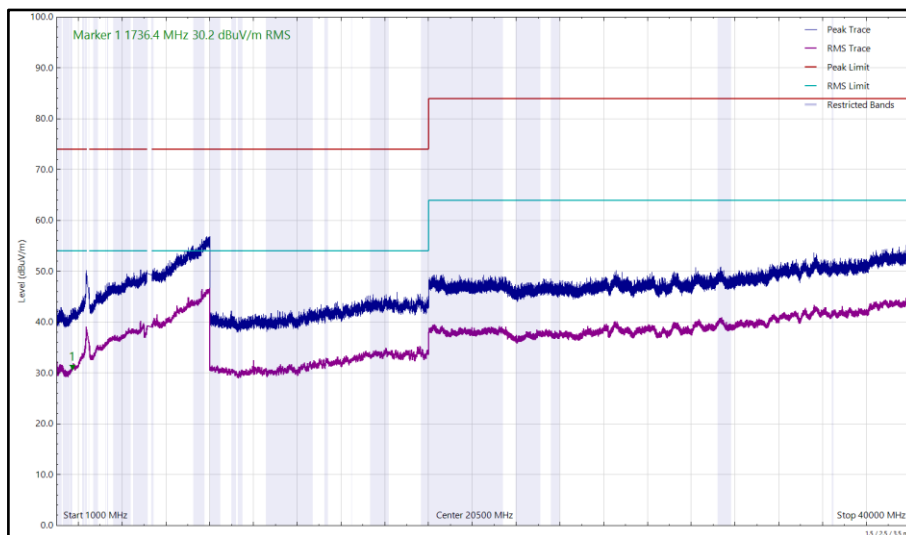

Figure 37 - 2412 MHz (CH1), HT20, Core 0 and 5162 MHz, HDR4, ePA, Core 1, 1 GHz to 40 GHz, Vertical



Frequency (MHz)	Level (dBuV/m)	Limit (dBuV/m)	Margin (dB)	Detector	Angle (°)	Height (cm)	Polarisation
164.769	13.49	43.50	-30.01	Q-Peak	360	100	Vertical
279.985	25.85	46.00	-20.15	Q-Peak	121	107	Horizontal

Table 16 - 2472 MHz (CH13), HT20, Core 0 and 5162 MHz, HDR4, ePA, Core 1, 30 MHz to 40 GHz

No other emissions found within 10 dB of the limit.

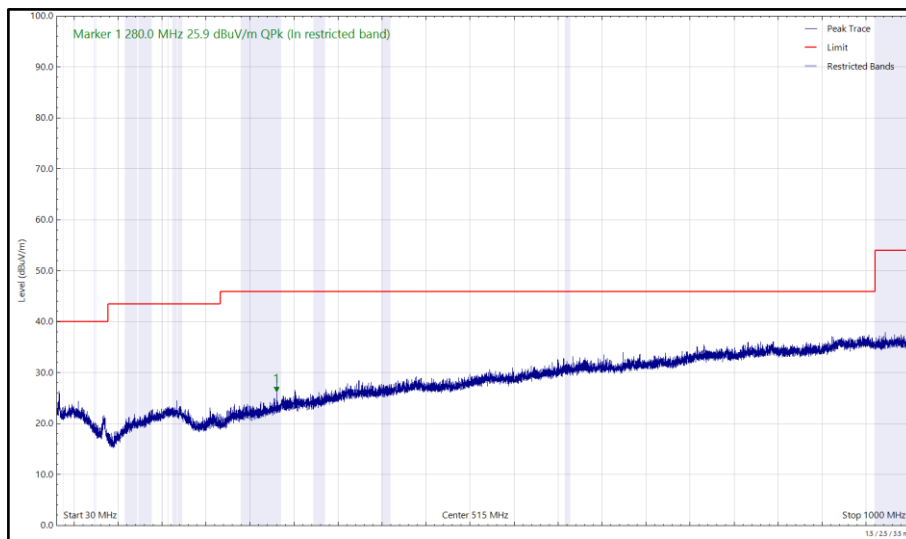

Figure 38 - 2472 MHz (CH13), HT20, Core 0 and 5162 MHz, HDR4, ePA, Core 1, 30 MHz to 1 GHz, Horizontal (Peak)

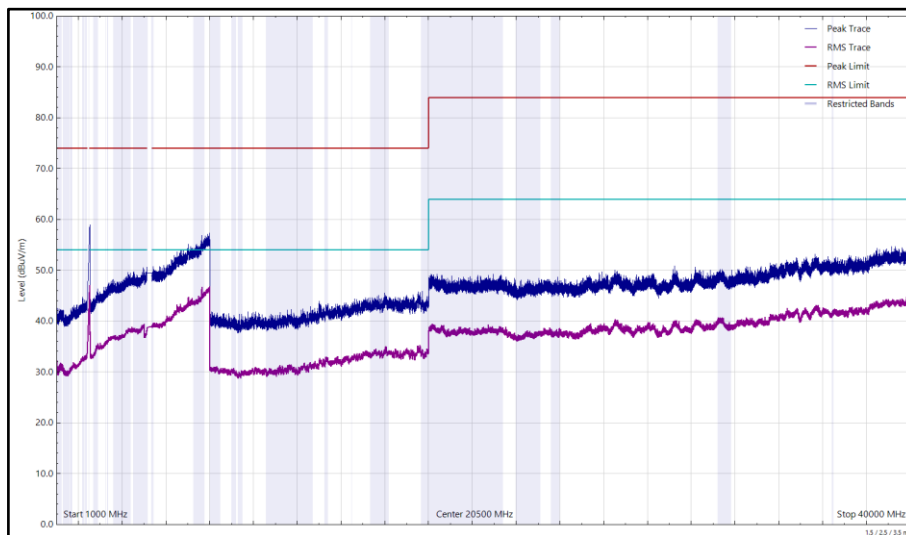

Figure 39 - 2472 MHz (CH13), HT20, Core 0 and 5162 MHz, HDR4, ePA, Core 1, 1 GHz to 40 GHz, Horizontal

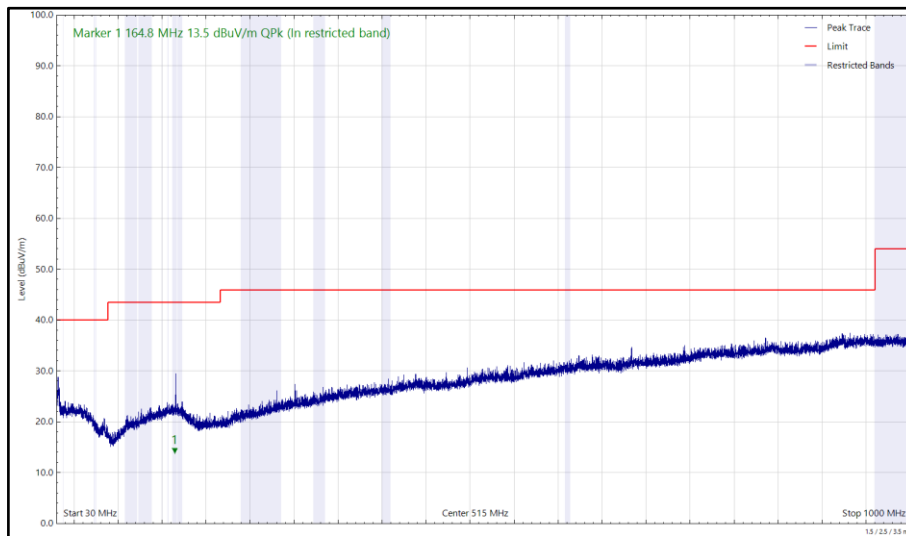

Figure 40 - 2472 MHz (CH13), HT20, Core 0 and 5162 MHz, HDR4, ePA, Core 1, 30 MHz to 1 GHz, Vertical (Peak)

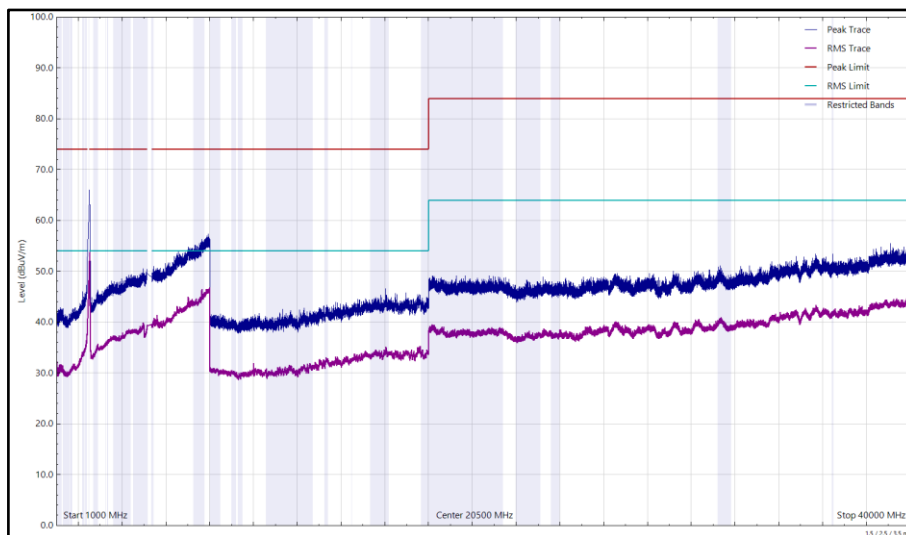

Figure 41 - 2472 MHz (CH13), HT20, Core 0 and 5162 MHz, HDR4, ePA, Core 1, 1 GHz to 40 GHz, Vertical



Frequency (MHz)	Level (dBuV/m)	Limit (dBuV/m)	Margin (dB)	Detector	Angle (°)	Height (cm)	Polarisation
279.976	24.98	46.00	-21.02	Q-Peak	111	117	Horizontal
5426.430	41.85	54.00	-12.15	RMS	158	269	Vertical

Table 17 - 2412 MHz (CH1), HT20, Core 0 and 5844 MHz, HDR4, ePA, Core 1, 30 MHz to 40 GHz

No other emissions found within 10 dB of the limit.

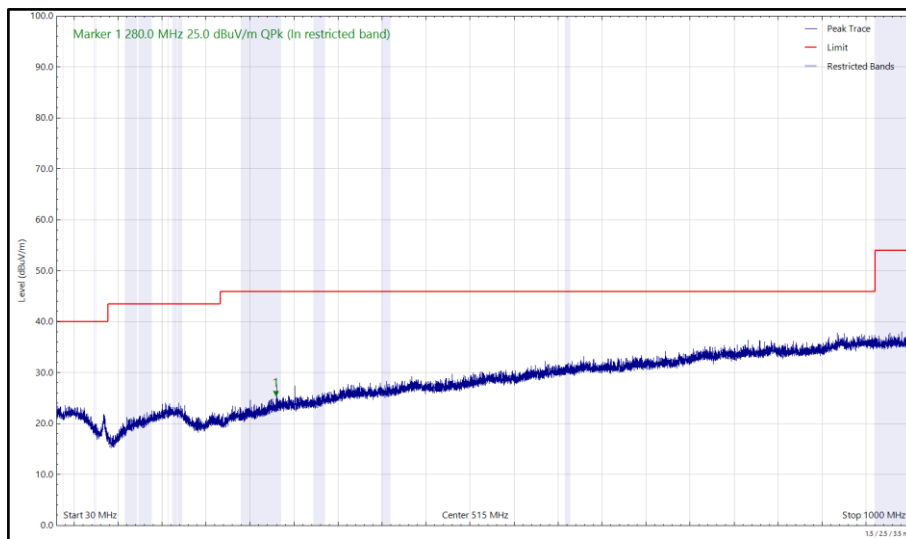

Figure 42 - 2412 MHz (CH1), HT20, Core 0 and 5844 MHz, HDR4, ePA, Core 1, 30 MHz to 1 GHz, Horizontal (Peak)

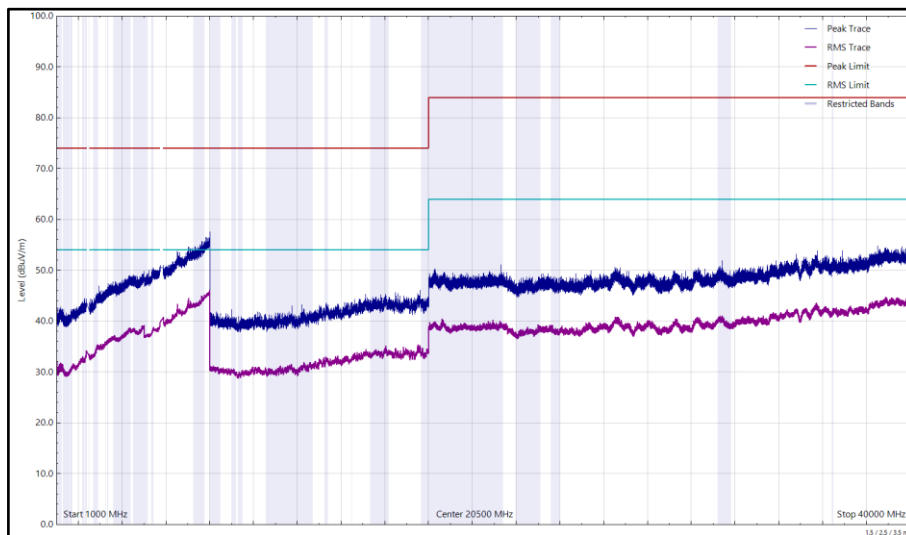

Figure 43 - 2412 MHz (CH1), HT20, Core 0 and 5844 MHz, HDR4, ePA, Core 1, 1 GHz to 40 GHz, Horizontal

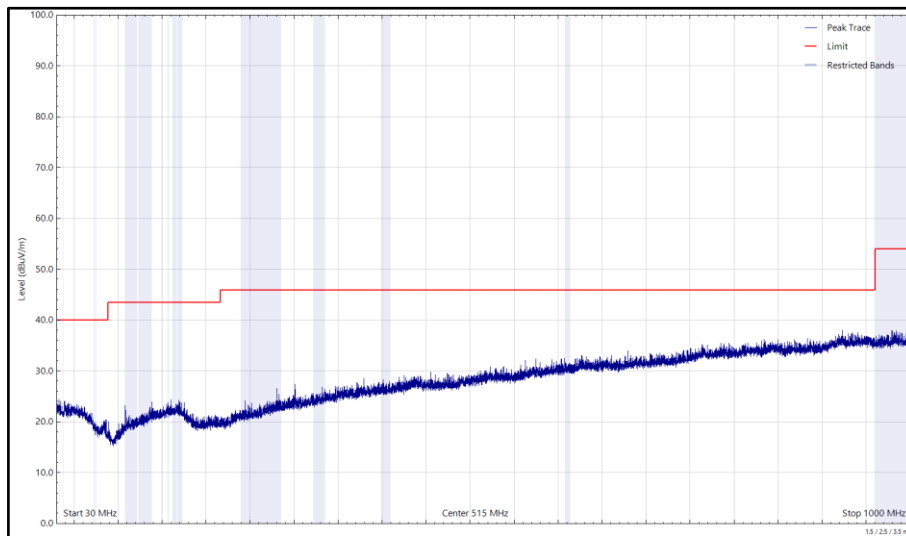

Figure 44 - 2412 MHz (CH1), HT20, Core 0 and 5844 MHz, HDR4, ePA, Core 1, 30 MHz to 1 GHz, Vertical (Peak)

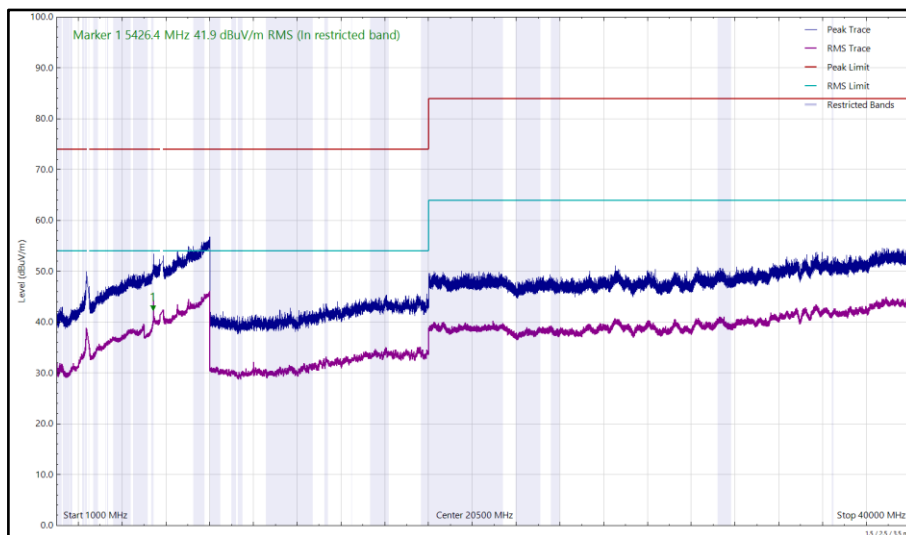

Figure 45 - 2412 MHz (CH1), HT20, Core 0 and 5844 MHz, HDR4, ePA, Core 1, 1 GHz to 40 GHz, Vertical



Frequency (MHz)	Level (dBuV/m)	Limit (dBuV/m)	Margin (dB)	Detector	Angle (°)	Height (cm)	Polarisation
280.001	26.39	46.00	-19.61	Q-Peak	135	108	Horizontal
280.008	24.42	46.00	-21.58	Q-Peak	350	155	Vertical
5426.594	43.88	54.00	-10.12	RMS	131	332	Vertical

Table 18 - 2472 MHz (CH13), HT20, Core 0 and 5844 MHz, HDR4, ePA, Core 1, 30 MHz to 40 GHz

No other emissions found within 10 dB of the limit.

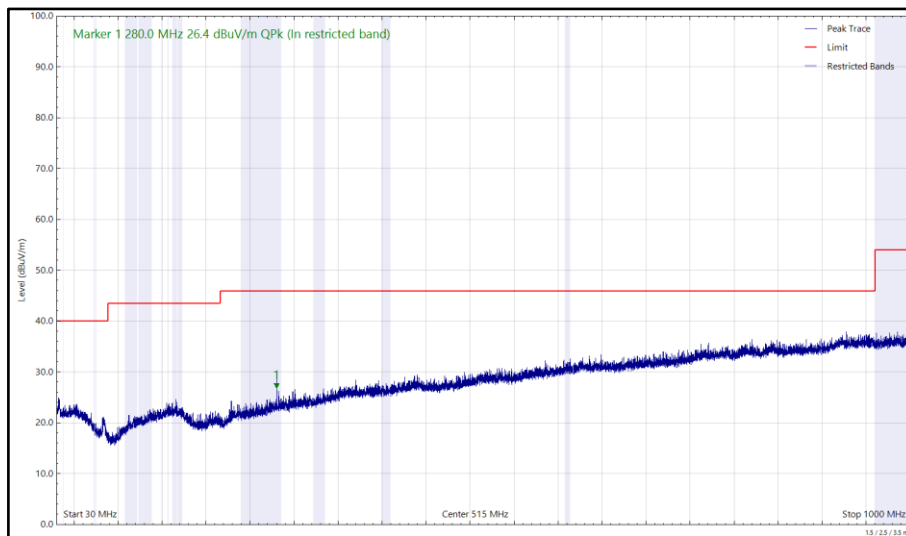

Figure 46 - 2472 MHz (CH13), HT20, Core 0 and 5844 MHz, HDR4, ePA, Core 1, 30 MHz to 1 GHz, Horizontal (Peak)

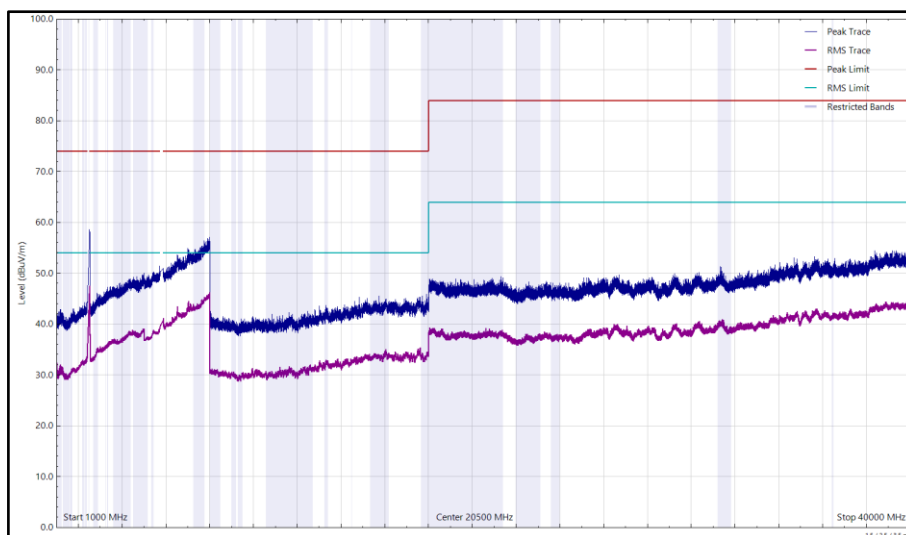

Figure 47 - 2472 MHz (CH13), HT20, Core 0 and 5844 MHz, HDR4, ePA, Core 1, 1 GHz to 40 GHz, Horizontal

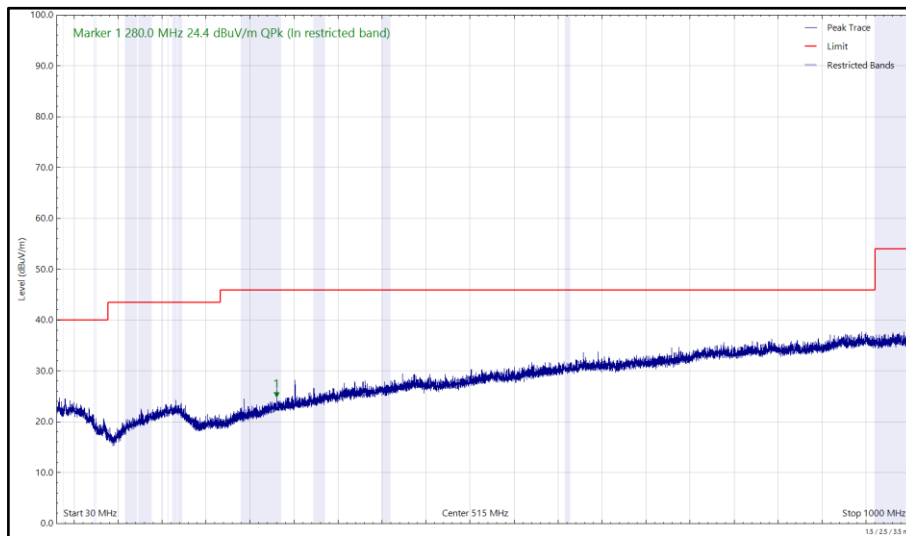

Figure 48 - 2472 MHz (CH13), HT20, Core 0 and 5844 MHz, HDR4, ePA, Core 1, 30 MHz to 1 GHz, Vertical (Peak)

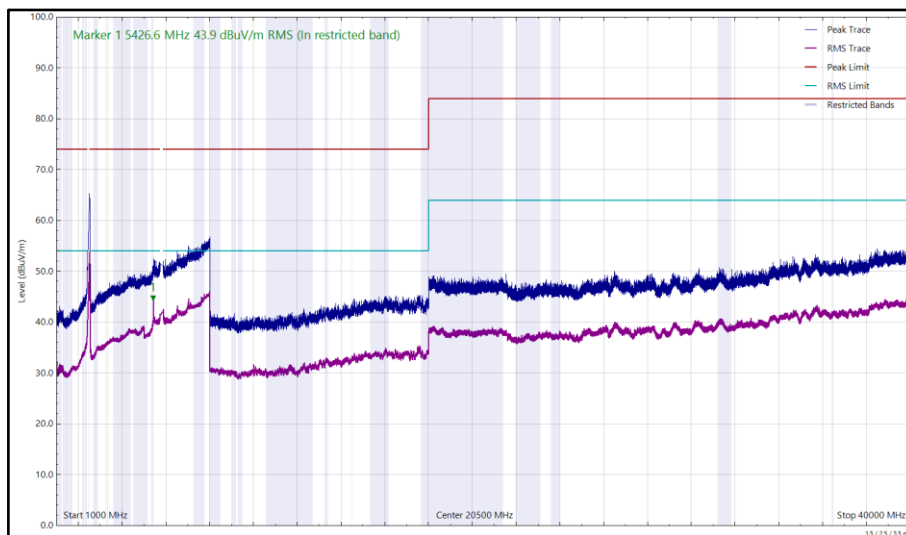

Figure 49 - 2472 MHz (CH13), HT20, Core 0 and 5844 MHz, HDR4, ePA, Core 1, 1 GHz to 40 GHz, Vertical



Frequency (MHz)	Level (dBuV/m)	Limit (dBuV/m)	Margin (dB)	Detector	Angle (°)	Height (cm)	Polarisation
1736.251	30.26	54.00	-23.74	RMS	242	150	Horizontal

Table 19 - 2412 MHz (CH1), HT20, Core 1 and 5162 MHz, HDR4, ePA, Core 0, 30 MHz to 40 GHz

No other emissions found within 10 dB of the limit.

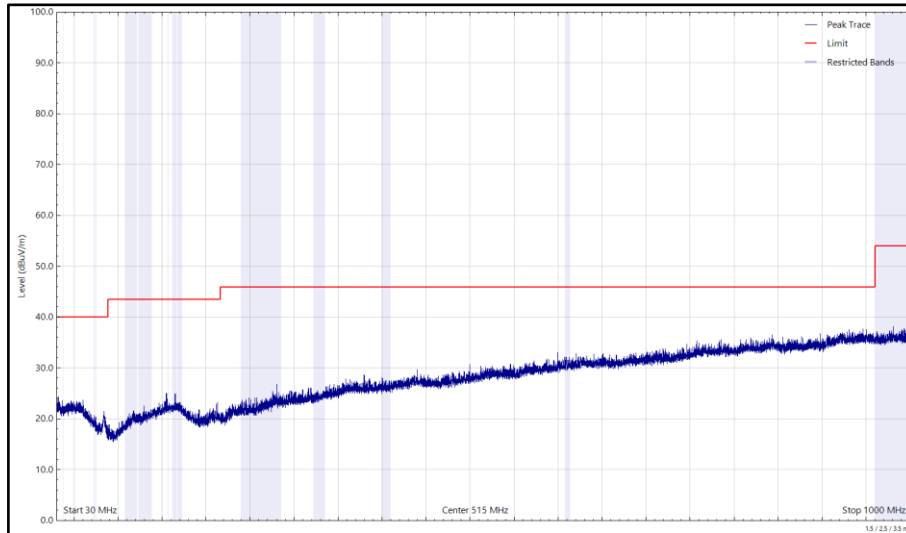

Figure 50 - 2412 MHz (CH1), HT20, Core 1 and 5162 MHz, HDR4, ePA, Core 0, 30 MHz to 1 GHz, Horizontal (Peak)

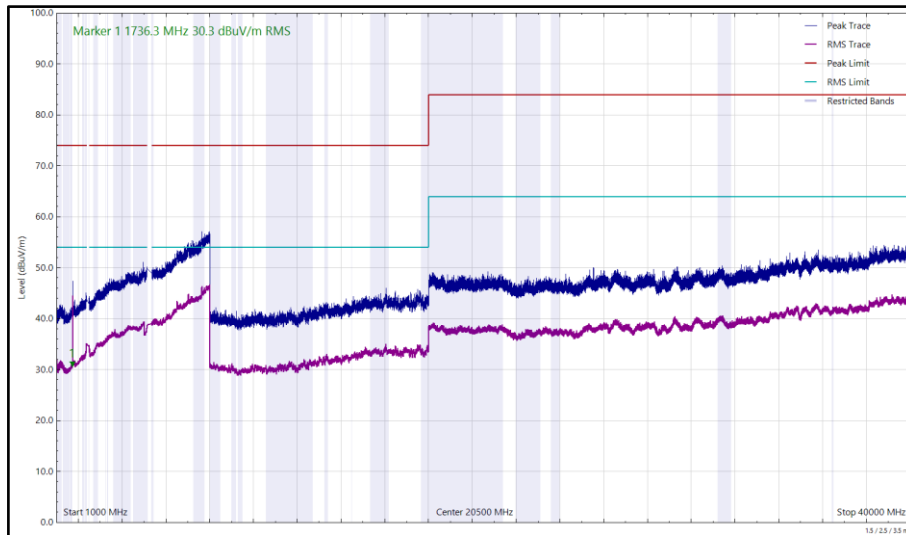

Figure 51 - 2412 MHz (CH1), HT20, Core 1 and 5162 MHz, HDR4, ePA, Core 0, 1 GHz to 40 GHz, Horizontal

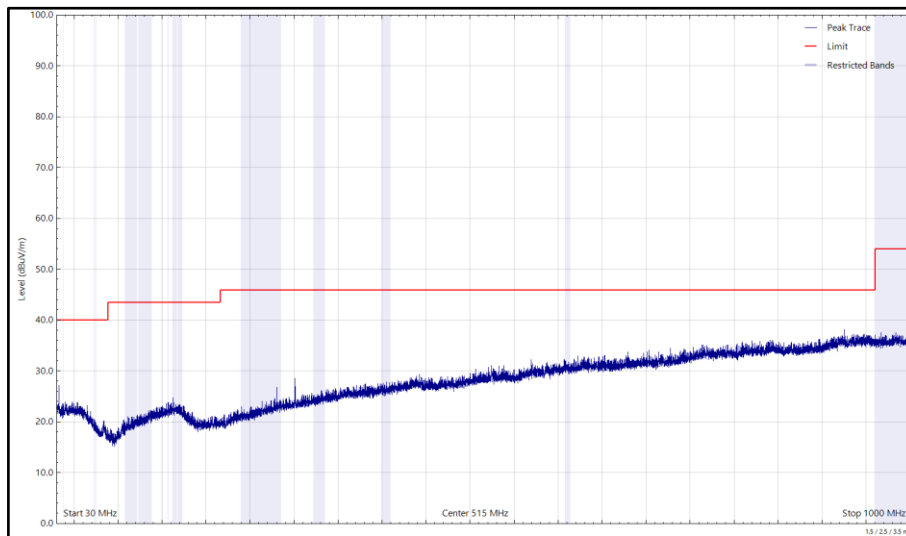

Figure 52 - 2412 MHz (CH1), HT20, Core 1 and 5162 MHz, HDR4, ePA, Core 0, 30 MHz to 1 GHz, Vertical (Peak)

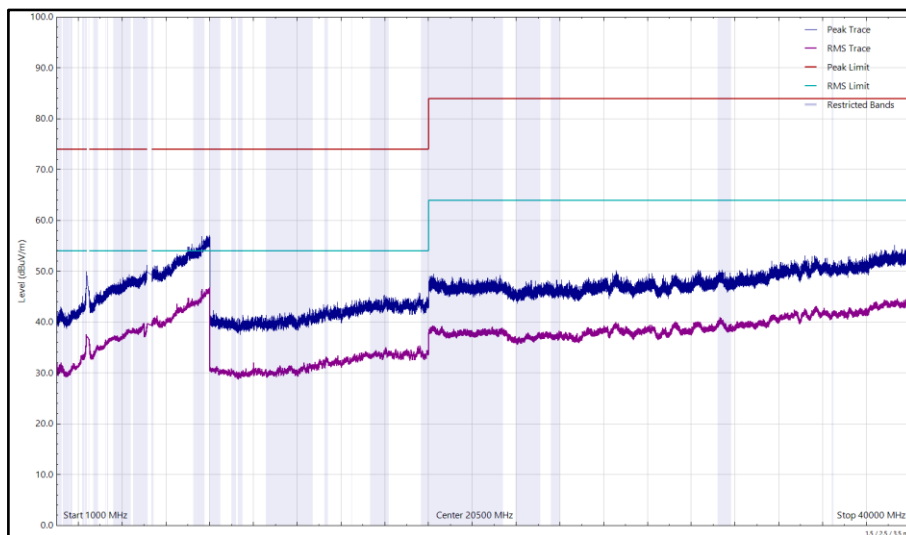

Figure 53 - 2412 MHz (CH1), HT20, Core 1 and 5162 MHz, HDR4, ePA, Core 0, 1 GHz to 40 GHz, Vertical



Frequency (MHz)	Level (dBuV/m)	Limit (dBuV/m)	Margin (dB)	Detector	Angle (°)	Height (cm)	Polarisation
280.005	25.49	46.00	-20.51	Q-Peak	130	114	Horizontal

Table 20 - 2472 MHz (CH13), HT20, Core 1 and 5162 MHz, HDR4, ePA, Core 0, 30 MHz to 40 GHz

No other emissions found within 10 dB of the limit.

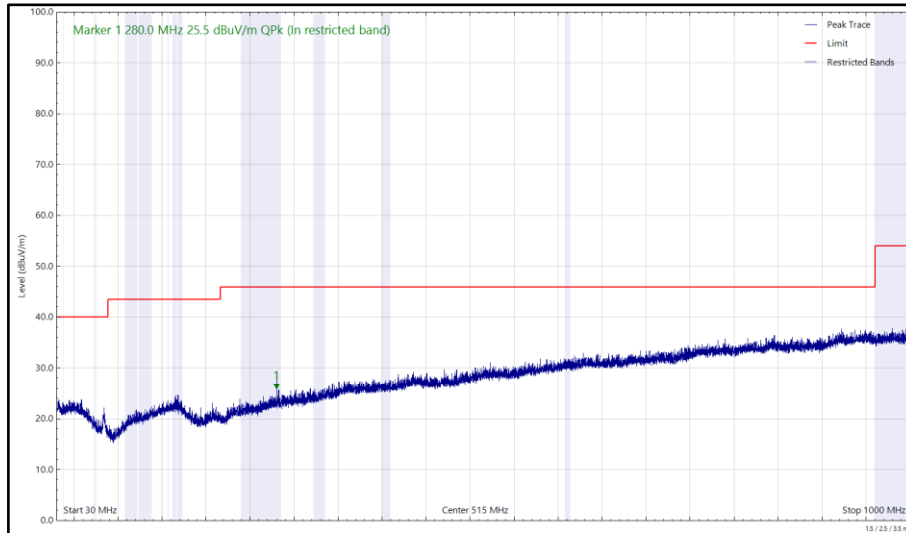

Figure 54 - 2472 MHz (CH13), HT20, Core 1 and 5162 MHz, HDR4, ePA, Core 0, 30 MHz to 1 GHz, Horizontal (Peak)

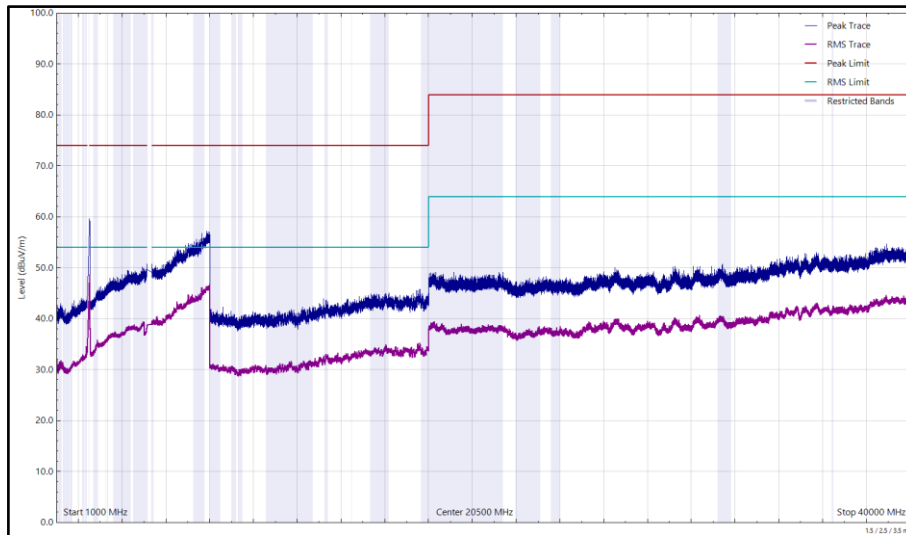

Figure 55 - 2472 MHz (CH13), HT20, Core 1 and 5162 MHz, HDR4, ePA, Core 0, 1 GHz to 40 GHz, Horizontal

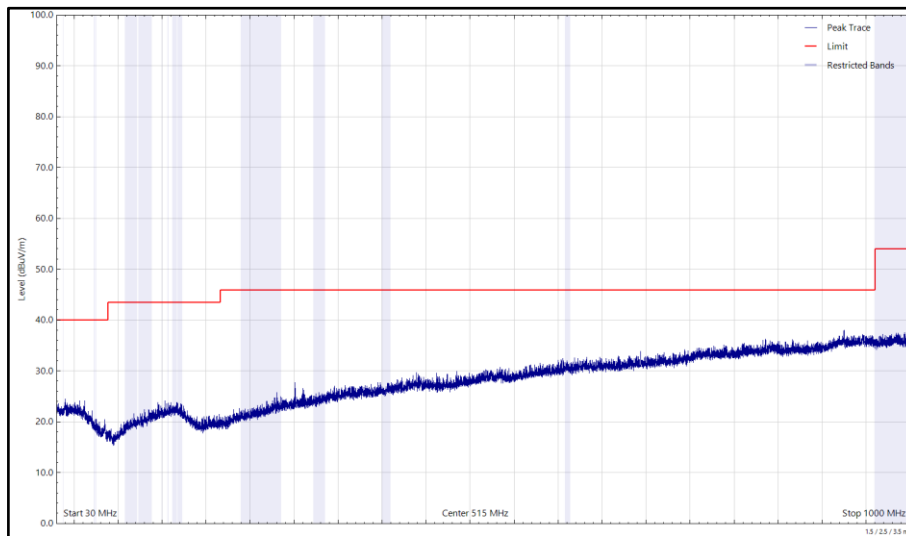

Figure 56 - 2472 MHz (CH13), HT20, Core 1 and 5162 MHz, HDR4, ePA, Core 0, 30 MHz to 1 GHz, Vertical (Peak)

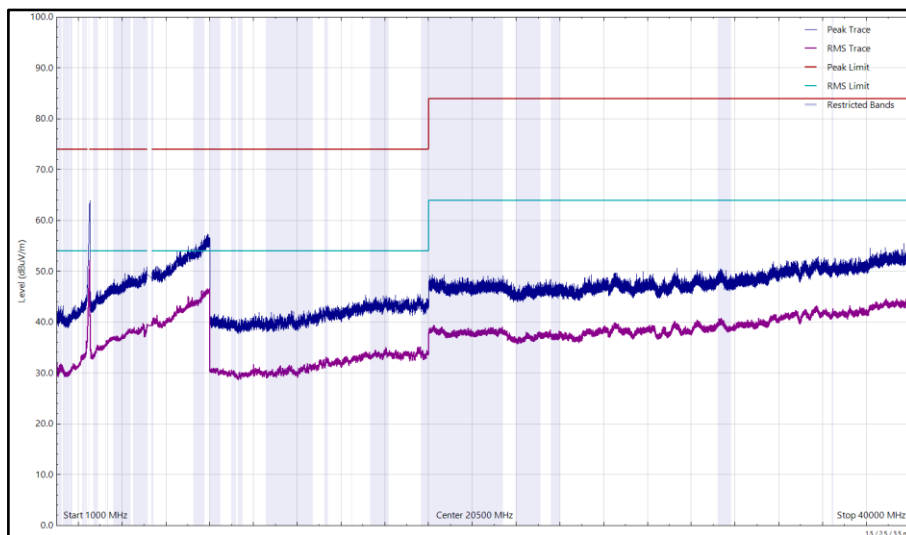

Figure 57 - 2472 MHz (CH13), HT20, Core 1 and 5162 MHz, HDR4, ePA, Core 0, 1 GHz to 40 GHz, Vertical



Frequency (MHz)	Level (dBuV/m)	Limit (dBuV/m)	Margin (dB)	Detector	Angle (°)	Height (cm)	Polarisation
280.006	26.16	46.00	-19.84	Q-Peak	134	102	Horizontal
5426.546	44.00	54.00	-10.00	RMS	120	324	Vertical

Table 21 - 2412 MHz (CH1), HT20, Core 1 and 5844 MHz, HDR4, ePA, Core 0, 30 MHz to 40 GHz

No other emissions found within 10 dB of the limit.

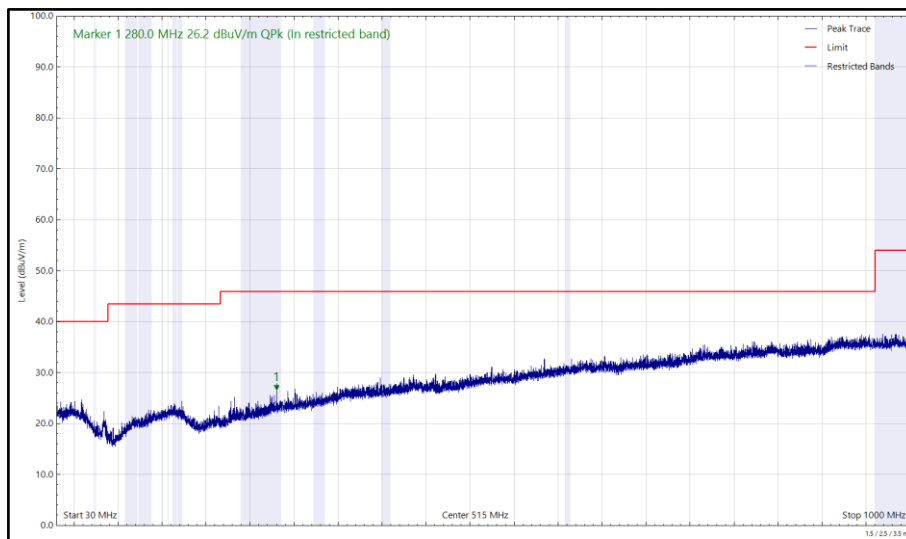

Figure 58 - 2412 MHz (CH1), HT20, Core 1 and 5844 MHz, HDR4, ePA, Core 0, 30 MHz to 1 GHz, Horizontal (Peak)

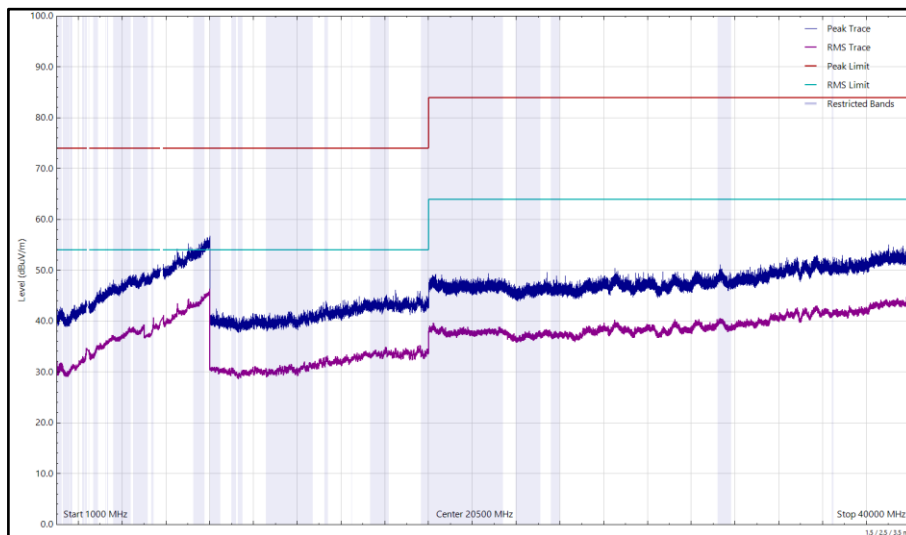

Figure 59 - 2412 MHz (CH1), HT20, Core 1 and 5844 MHz, HDR4, ePA, Core 0, 1 GHz to 40 GHz, Horizontal

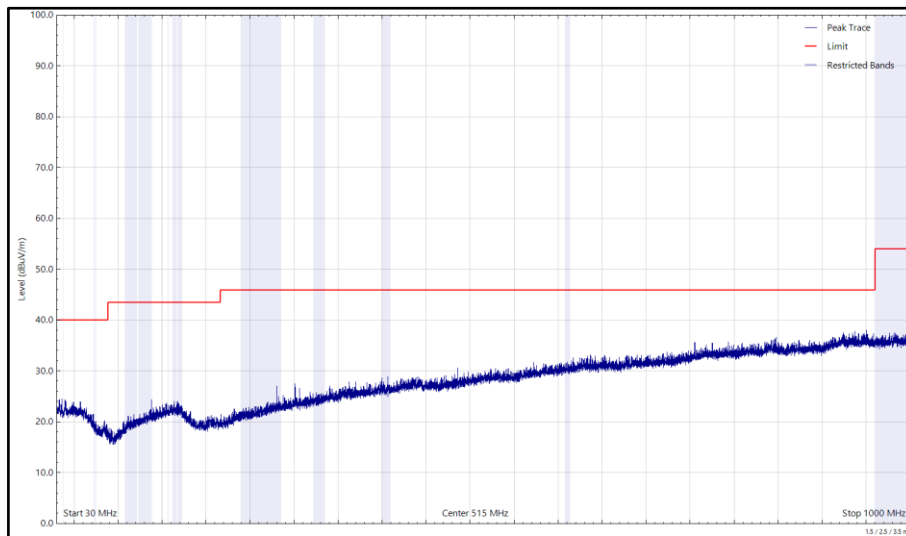

Figure 60 - 2412 MHz (CH1), HT20, Core 1 and 5844 MHz, HDR4, ePA, Core 0, 30 MHz to 1 GHz, Vertical (Peak)

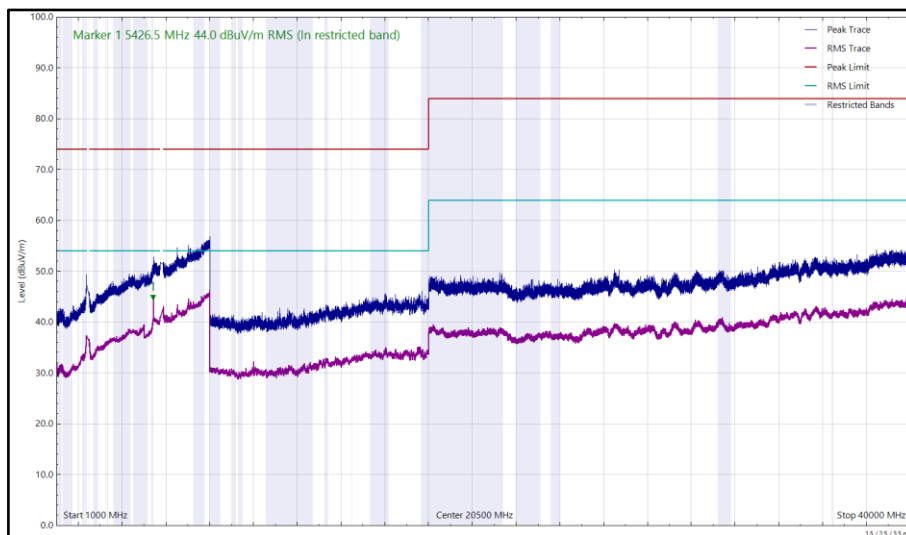

Figure 61 - 2412 MHz (CH1), HT20, Core 1 and 5844 MHz, HDR4, ePA, Core 0, 1 GHz to 40 GHz, Vertical



Frequency (MHz)	Level (dBuV/m)	Limit (dBuV/m)	Margin (dB)	Detector	Angle (°)	Height (cm)	Polarisation
279.977	21.28	46.00	-24.72	Q-Peak	4	138	Vertical
300.844	24.62	46.00	-21.38	Q-Peak	43	146	Vertical

Table 22 - 2472 MHz (CH13), HT20, Core 1 and 5844 MHz, HDR4, ePA, Core 0, 30 MHz to 40 GHz

No other emissions found within 10 dB of the limit.

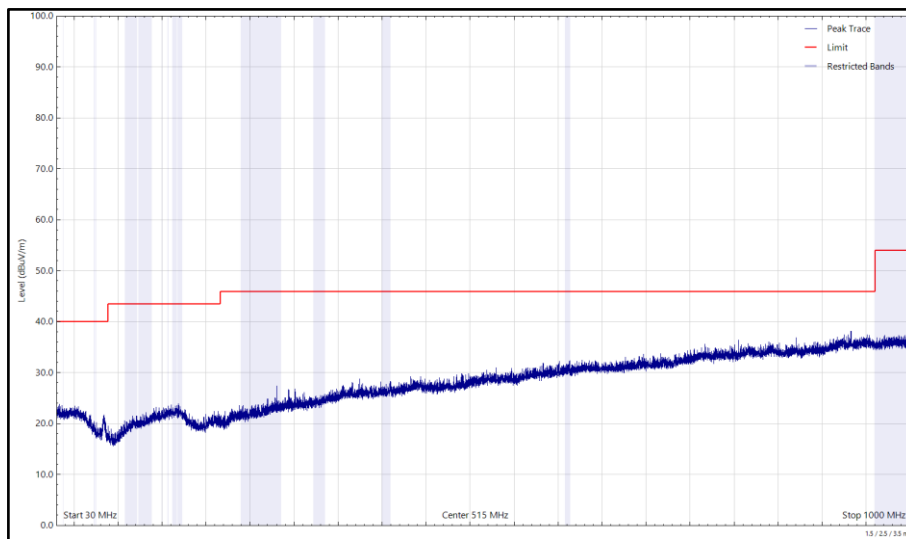

Figure 62 - 2472 MHz (CH13), HT20, Core 1 and 5844 MHz, HDR4, ePA, Core 0, 30 MHz to 1 GHz, Horizontal (Peak)

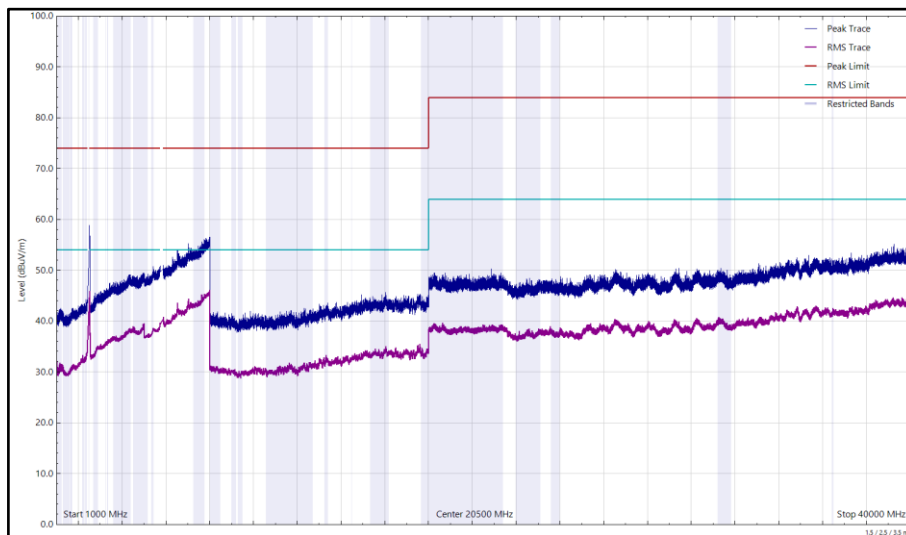

Figure 63 - 2472 MHz (CH13), HT20, Core 1 and 5844 MHz, HDR4, ePA, Core 0, 1 GHz to 40 GHz, Horizontal

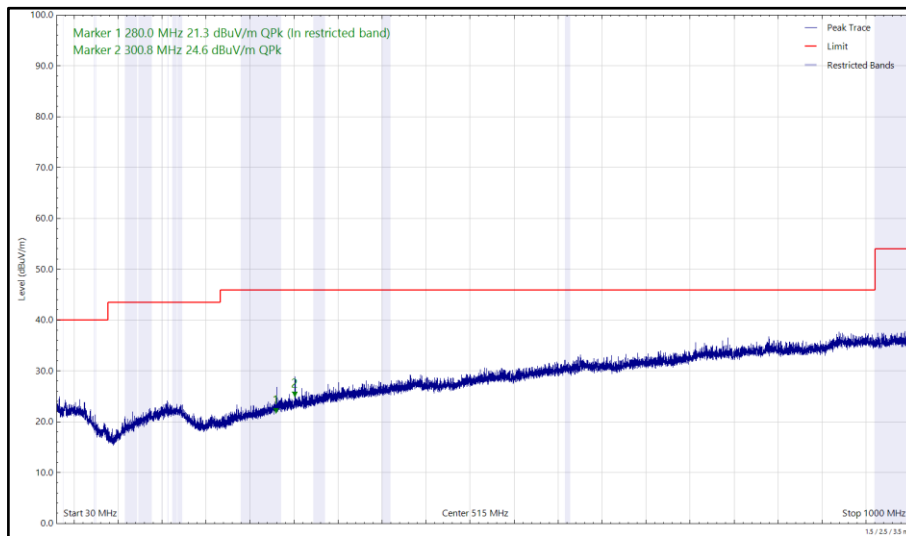

Figure 64 - 2472 MHz (CH13), HT20, Core 1 and 5844 MHz, HDR4, ePA, Core 0, 30 MHz to 1 GHz, Vertical (Peak)

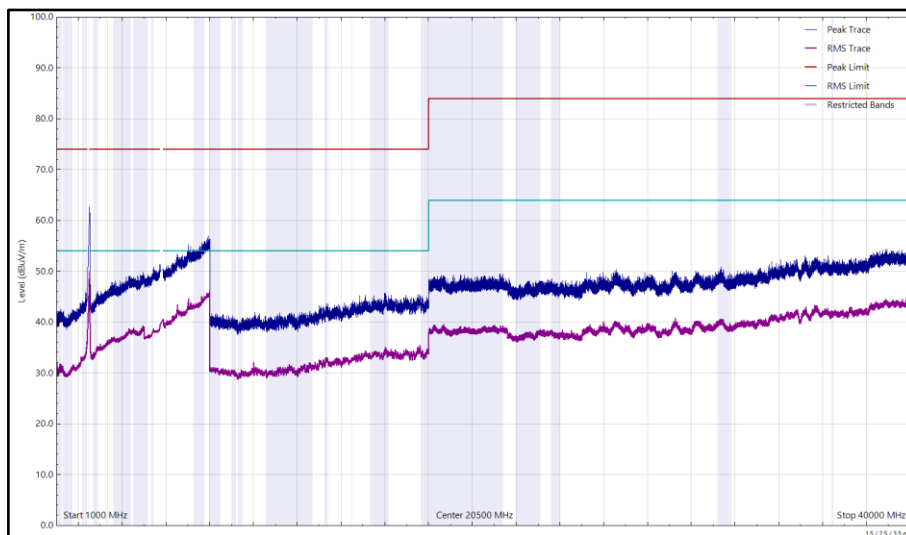

Figure 65 - 2472 MHz (CH13), HT20, Core 1 and 5844 MHz, HDR4, ePA, Core 0, 1 GHz to 40 GHz, Vertical



FCC 47 CFR Part 15, ISED RSS-247 and ISED RSS-GEN

The least stringent limit from the applicable rule parts was used to determine compliance for Radiated Emissions testing of multiple transmission sources.

The least stringent applicable limit was:

Clause	Limit
Part 15.247 (d) / RSS-247 Clause 5.5	-30 dBc
Part 15.407 (b) / RSS-247 Clause 6.2	-27 dBm (EIRP) / 68 dB μ V/m at 3m.
Part 15.209 / RSS-GEN Clause 8.9	Peak: 74 dB μ V/m at 3m, Average 54 dB μ V/m at 3m

Table 23



2.1.8 Test Location and Test Equipment Used

This test was carried out in RF Chamber 15.

Instrument	Manufacturer	Type No.	TE No.	Calibration Period (months)	Calibration Expiry Date
Emissions Software	TUV SUD	EmX V3.1.4	5125	-	Software
Pre Amp 1 - 26.5 GHz	Agilent Technologies	8449B	5445	12	12-May-2023
EMI Test Receiver	Rohde & Schwarz	ESW44	5911	12	24-Feb-2023
Cable (K Type 2m)	Junkosha	MWX241-01000KMSKMS/B	5937	12	14-May-2023
DRG Horn Antenna (7.5-18GHz)	Schwarzbeck	HWRD750	5939	12	29-May-2023
TRILOG Super Broadband Test Antenna	Schwarzbeck	VULB 9168	5944	24	03-Feb-2024
1500W (300V 12A) AC Power Supply	iTech	IT7324	5956	-	O/P Mon
5m Semi-Anechoic Chamber (Dual-Axis)	Albatross Projects	RF Chamber 15	5963	36	28-Apr-2025
Compact Antenna Mast	Maturo Gmbh	CAM4.0-P	5964	-	TU
Tilt Antenna Mast	Maturo Gmbh	BAM4.5-P	5967	-	TU
Mast & Turntable Controller	Maturo Gmbh	FCU3.0	5966	-	TU
Turntable	Maturo Gmbh	TT1.5SI	5968	-	TU
Cable (SMA 1m)	Junkosha	MWX221-01000AMSAMS/A	5996	12	06-Jun-2023
Cable (N to N 1m)	Junkosha	MWX221-01000NMSNMS/B	5999	12	05-Jun-2023
Cable (N to N 7m)	Junkosha	MWX221-07000NMSNMS/B	6005	12	05-Jun-2023
Cable (N to N 8m)	Junkosha	MWX221-08000NMSNMS/A	6006	12	05-Jun-2023
Cable (SMA to SMA 1m)	Junkosha	MWX221-01000AMSAMS/A	6007	12	06-Jun-2023
Cable (SMA to SMA 6.5m)	Junkosha	MWX221-06500AMSAMS/B	6014	12	07-Jun-2023
Cable (SMA to SMA 1m)	Junkosha	MWX221-01000AMSAMS/B	6019	12	07-Jun-2023
Horn Antenna (1-10 GHz)	Schwarzbeck	BBHA9120B	6140	12	21-Jun-2023
Digital Multimeter	Fluke	115	6147	12	16-Jun-2023
Humidity & Temperature meter	R.S Components	1364	6150	12	17-Jun-2023
Double Ridge Active Horn Antenna (18-40 GHz)	Com-Power	AHA-840	6188	24	02-Jun-2024
SAC Switch Unit	TUV SUD	SSU003	6191	12	15-Jul-2023
8GHz Highpass Filter	Wainwright	WHKX 7150 8000 18000 50SS	6194	12	15-Jul-2023



Instrument	Manufacturer	Type No.	TE No.	Calibration Period (months)	Calibration Expiry Date
Pre Amp 8 - 18 GHz	Wright Technologies	APS06 0061	6198	12	19-Jul-2023
Attenuator 4dB	Pasternack	PE7074-4	6203	24	16-Jul-2024
Cable (SMA to SMA 20cm)	TUV SUD	MH-FH 8-18	6214	12	25-Jul-2023

Table 24

TU - Traceability Unscheduled
O/P Mon – Output Monitored using calibrated equipment



3 Measurement Uncertainty

For a 95% confidence level, the measurement uncertainties for defined systems are:

Test Name	Measurement Uncertainty
Radiated Spurious Emissions (Simultaneous Transmission)	30 MHz to 1 GHz: ± 5.2 dB 1 GHz to 40 GHz: ± 6.3 dB

Table 25

Measurement Uncertainty Decision Rule – Accuracy Method

Determination of conformity with the specification limits is based on the decision rule according to IEC Guide 115:2007, Clause 4.4.3 and 4.5.1. (Procedure 2). The measurement results are directly compared with the test limit to determine conformance with the requirements of the standard.

Risk: The uncertainty of measurement about the measured result is negligible with regard to the final pass/fail decision. The measurement result can be directly compared with the test limit to determine conformance with the requirement (compare IEC Guide 115). The level of risk to falsely accept and falsely reject items is further described in ILAC-G8.