



Test Configuration			
Frequency Range:	2400-2483.5 MHz	Band:	2.4 GHz
Limit Clause(s):	15.247 (b)(3) RSS-247 5.4 d)	Test Method(s):	C63.10 11.9.1.2 11.9.1.3
Additional Reference(s):	-		

DUT Configuration			
Mode:	iPA $\pi/4$ DQPSK (8-DH5)	Duty Cycle (%):	78.5
Antenna Configuration:	SISO	DCCF (dB):	-
Active Port(s):	C (BT Core 2)	Peak Antenna Gain (dBi):	2.15

Test Frequency (MHz)	Maximum Conducted Output Power (dBm)					Limit (dBm)	Margin (dB)
	A	B	C	D	Σ		
2404	-	-	10.55	-	-	30.00	-19.45
2441	-	-	10.60	-	-	30.00	-19.40
2476	-	-	10.35	-	-	30.00	-19.65

Table 77 - FCC Maximum Conducted (peak) Output Power Results

Test Frequency (MHz)	Maximum Conducted Output Power (dBm)					Limit (dBm)	Margin (dB)	EIRP (dBm)	EIRP Limit (dBm)	EIRP Margin (dB)
	A	B	C	D	Σ					
2404	-	-	10.55	-	-	30.00	-19.45	12.70	36.00	-23.30
2441	-	-	10.60	-	-	30.00	-19.40	12.75	36.00	-23.25
2476	-	-	10.35	-	-	30.00	-19.65	12.50	36.00	-23.50

Table 78 - ISED Maximum Conducted (peak) Output Power Results



Test Configuration			
Frequency Range:	2400-2483.5 MHz	Band:	2.4 GHz
Limit Clause(s):	15.247 (b)(3) RSS-247 5.4 d)	Test Method(s):	C63.10 11.9.1.2 11.9.1.3
Additional Reference(s):	-		

DUT Configuration			
Mode:	iPA GFSK (LE 1M)	Duty Cycle (%):	60.4
Antenna Configuration:	SISO	DCCF (dB):	-
Active Port(s):	B (BT Core 1)	Peak Antenna Gain (dBi):	-0.21

Test Frequency (MHz)	Maximum Conducted Output Power (dBm)					Limit (dBm)	Margin (dB)
	A	B	C	D	Σ		
2402	-	9.89	-	-	-	30.00	-20.11
2440	-	9.76	-	-	-	30.00	-20.24
2480	-	10.11	-	-	-	30.00	-19.89

Table 79 - FCC Maximum Conducted (peak) Output Power Results

Test Frequency (MHz)	Maximum Conducted Output Power (dBm)					Limit (dBm)	Margin (dB)	EIRP (dBm)	EIRP Limit (dBm)	EIRP Margin (dB)
	A	B	C	D	Σ					
2402	-	9.89	-	-	-	30.00	-20.11	9.68	36.00	-26.32
2440	-	9.76	-	-	-	30.00	-20.24	9.55	36.00	-26.45
2480	-	10.11	-	-	-	30.00	-19.89	9.90	36.00	-26.10

Table 80 - ISED Maximum Conducted (peak) Output Power Results



Test Configuration			
Frequency Range:	2400-2483.5 MHz	Band:	2.4 GHz
Limit Clause(s):	15.247 (b)(3) RSS-247 5.4 d)	Test Method(s):	C63.10 11.9.1.2 11.9.1.3
Additional Reference(s):	-		

DUT Configuration			
Mode:	iPA GFSK (LE 2M)	Duty Cycle (%):	31.3
Antenna Configuration:	SISO	DCCF (dB):	-
Active Port(s):	B (BT Core 1)	Peak Antenna Gain (dBi):	-0.21

Test Frequency (MHz)	Maximum Conducted Output Power (dBm)					Limit (dBm)	Margin (dB)
	A	B	C	D	Σ		
2402	-	10.18	-	-	-	30.00	-19.82
2440	-	10.01	-	-	-	30.00	-19.99
2480	-	9.98	-	-	-	30.00	-20.02

Table 81 - FCC Maximum Conducted (peak) Output Power Results

Test Frequency (MHz)	Maximum Conducted Output Power (dBm)					Limit (dBm)	Margin (dB)	EIRP (dBm)	EIRP Limit (dBm)	EIRP Margin (dB)
	A	B	C	D	Σ					
2402	-	10.18	-	-	-	30.00	-19.82	9.97	36.00	-26.03
2440	-	10.01	-	-	-	30.00	-19.99	9.80	36.00	-26.20
2480	-	9.98	-	-	-	30.00	-20.02	9.77	36.00	-26.23

Table 82 - ISED Maximum Conducted (peak) Output Power Results



Test Configuration			
Frequency Range:	2400-2483.5 MHz	Band:	2.4 GHz
Limit Clause(s):	15.247 (b)(3) RSS-247 5.4 d)	Test Method(s):	C63.10 11.9.1.2 11.9.1.3
Additional Reference(s):	-		

DUT Configuration			
Mode:	iPA GFSK (LE 1M)	Duty Cycle (%):	60.4
Antenna Configuration:	SISO	DCCF (dB):	-
Active Port(s):	C (BT Core 2)	Peak Antenna Gain (dBi):	2.15

Test Frequency (MHz)	Maximum Conducted Output Power (dBm)					Limit (dBm)	Margin (dB)
	A	B	C	D	Σ		
2402	-	-	7.67	-	-	30.00	-22.33
2440	-	-	7.59	-	-	30.00	-22.41
2480	-	-	7.29	-	-	30.00	-22.71

Table 83 - FCC Maximum Conducted (peak) Output Power Results

Test Frequency (MHz)	Maximum Conducted Output Power (dBm)					Limit (dBm)	Margin (dB)	EIRP (dBm)	EIRP Limit (dBm)	EIRP Margin (dB)
	A	B	C	D	Σ					
2402	-	-	7.67	-	-	30.00	-22.33	9.82	36.00	-26.18
2440	-	-	7.59	-	-	30.00	-22.41	9.74	36.00	-26.26
2480	-	-	7.29	-	-	30.00	-22.71	9.44	36.00	-26.56

Table 84 - ISED Maximum Conducted (peak) Output Power Results



Test Configuration			
Frequency Range:	2400-2483.5 MHz	Band:	2.4 GHz
Limit Clause(s):	15.247 (b)(3) RSS-247 5.4 d)	Test Method(s):	C63.10 11.9.1.2 11.9.1.3
Additional Reference(s):	-		

DUT Configuration			
Mode:	iPA GFSK (LE 2M)	Duty Cycle (%):	31.3
Antenna Configuration:	SISO	DCCF (dB):	-
Active Port(s):	C (BT Core 2)	Peak Antenna Gain (dBi):	2.15

Test Frequency (MHz)	Maximum Conducted Output Power (dBm)					Limit (dBm)	Margin (dB)
	A	B	C	D	Σ		
2402	-	-	7.50	-	-	30.00	-22.50
2440	-	-	7.98	-	-	30.00	-22.02
2480	-	-	7.68	-	-	30.00	-22.32

Table 85 - FCC Maximum Conducted (peak) Output Power Results

Test Frequency (MHz)	Maximum Conducted Output Power (dBm)					Limit (dBm)	Margin (dB)	EIRP (dBm)	EIRP Limit (dBm)	EIRP Margin (dB)
	A	B	C	D	Σ					
2402	-	-	7.50	-	-	30.00	-22.50	9.65	36.00	-26.35
2440	-	-	7.98	-	-	30.00	-22.02	10.13	36.00	-25.87
2480	-	-	7.68	-	-	30.00	-22.32	9.83	36.00	-26.17

Table 86 - ISED Maximum Conducted (peak) Output Power Results



Test Configuration			
Frequency Range:	2400-2483.5 MHz	Band:	2.4 GHz
Limit Clause(s):	15.247 (b)(3) RSS-247 5.4 d)	Test Method(s):	C63.10 11.9.1.2 11.9.1.3
Additional Reference(s):	662911 D01 v02r01 F)2)d)(i), 662911 D01 v02r01 E)1)		

DUT Configuration			
Mode:	ePA $\pi/4$ DQPSK (4-DH5)	Duty Cycle (%):	78.1
Antenna Configuration:	Beamforming	DCCF (dB):	-
Active Port(s):	A+B (BT Core 0 + BT Core 1)	Peak Antenna Gain (dBi):	2.40

Test Frequency (MHz)	Maximum Conducted Output Power (dBm)					Limit (dBm)	Margin (dB)
	A	B	C	D	Σ		
2404	15.58	15.42	-	-	18.49	30.00	-11.51
2441	15.52	15.57	-	-	18.54	30.00	-11.46
2476	15.35	15.58	-	-	18.44	30.00	-11.56

Table 87 - FCC Maximum Conducted (peak) Output Power Results

Test Frequency (MHz)	Maximum Conducted Output Power (dBm)					Limit (dBm)	Margin (dB)	EIRP (dBm)	EIRP Limit (dBm)	EIRP Margin (dB)
	A	B	C	D	Σ					
2404	15.58	15.42	-	-	18.49	30.00	-11.51	20.89	36.00	-15.11
2441	15.52	15.57	-	-	18.54	30.00	-11.46	20.94	36.00	-15.06
2476	15.35	15.58	-	-	18.44	30.00	-11.56	20.85	36.00	-15.15

Table 88 - ISED Maximum Conducted (peak) Output Power Results



Test Configuration			
Frequency Range:	2400-2483.5 MHz	Band:	2.4 GHz
Limit Clause(s):	15.247 (b)(3) RSS-247 5.4 d)	Test Method(s):	C63.10 11.9.1.2 11.9.1.3
Additional Reference(s):	662911 D01 v02r01 F)2)d)(i), 662911 D01 v02r01 E)1)		

DUT Configuration			
Mode:	ePA $\pi/4$ DQPSK (8-DH5)	Duty Cycle (%):	78.2
Antenna Configuration:	Beamforming	DCCF (dB):	-
Active Port(s):	A+B (BT Core 0 + BT Core 1)	Peak Antenna Gain (dBi):	2.40

Test Frequency (MHz)	Maximum Conducted Output Power (dBm)					Limit (dBm)	Margin (dB)
	A	B	C	D	Σ		
2404	16.18	16.21	-	-	19.16	30.00	-10.84
2441	16.08	16.18	-	-	19.12	30.00	-10.88
2476	15.82	16.13	-	-	18.96	30.00	-11.04

Table 89 - FCC Maximum Conducted (peak) Output Power Results

Test Frequency (MHz)	Maximum Conducted Output Power (dBm)					Limit (dBm)	Margin (dB)	EIRP (dBm)	EIRP Limit (dBm)	EIRP Margin (dB)
	A	B	C	D	Σ					
2404	16.18	16.21	-	-	19.16	30.00	-10.84	21.57	36.00	-14.43
2441	16.08	16.18	-	-	19.12	30.00	-10.88	21.52	36.00	-14.48
2476	15.82	16.13	-	-	18.96	30.00	-11.04	21.36	36.00	-14.64

Table 90 - ISED Maximum Conducted (peak) Output Power Results



Test Configuration			
Frequency Range:	2400-2483.5 MHz	Band:	2.4 GHz
Limit Clause(s):	15.247 (b)(3) RSS-247 5.4 d)	Test Method(s):	C63.10 11.9.1.2 11.9.1.3
Additional Reference(s):	662911 D01 v02r01 F)2)d)(i), 662911 D01 v02r01 E)1)		

DUT Configuration			
Mode:	iPA $\pi/4$ DQPSK (4-DH5)	Duty Cycle (%):	78.4
Antenna Configuration:	Beamforming	DCCF (dB):	-
Active Port(s):	A+B (BT Core 0 + BT Core 1)	Peak Antenna Gain (dBi):	2.40

Test Frequency (MHz)	Maximum Conducted Output Power (dBm)					Limit (dBm)	Margin (dB)
	A	B	C	D	Σ		
2404	8.54	8.17	-	-	11.36	30.00	-18.64
2441	8.35	8.31	-	-	11.31	30.00	-18.69
2476	8.02	8.39	-	-	11.22	30.00	-18.78

Table 91 - FCC Maximum Conducted (peak) Output Power Results

Test Frequency (MHz)	Maximum Conducted Output Power (dBm)					Limit (dBm)	Margin (dB)	EIRP (dBm)	EIRP Limit (dBm)	EIRP Margin (dB)
	A	B	C	D	Σ					
2404	8.54	8.17	-	-	11.36	30.00	-18.64	13.76	36.00	-22.24
2441	8.35	8.31	-	-	11.31	30.00	-18.69	13.72	36.00	-22.28
2476	8.02	8.39	-	-	11.22	30.00	-18.78	13.62	36.00	-22.38

Table 92 - ISED Maximum Conducted (peak) Output Power Results



Test Configuration			
Frequency Range:	2400-2483.5 MHz	Band:	2.4 GHz
Limit Clause(s):	15.247 (b)(3) RSS-247 5.4 d)	Test Method(s):	C63.10 11.9.1.2 11.9.1.3
Additional Reference(s):	662911 D01 v02r01 F)2)d)(i), 662911 D01 v02r01 E)1)		

DUT Configuration			
Mode:	iPA $\pi/4$ DQPSK (8-DH5)	Duty Cycle (%):	78.1
Antenna Configuration:	Beamforming	DCCF (dB):	-
Active Port(s):	A+B (BT Core 0 + BT Core 1)	Peak Antenna Gain (dBi):	2.40

Test Frequency (MHz)	Maximum Conducted Output Power (dBm)					Limit (dBm)	Margin (dB)
	A	B	C	D	Σ		
2404	8.86	8.56	-	-	11.69	30.00	-18.31
2441	9.14	9.18	-	-	12.14	30.00	-17.86
2476	8.92	9.23	-	-	12.05	30.00	-17.95

Table 93 - FCC Maximum Conducted (peak) Output Power Results

Test Frequency (MHz)	Maximum Conducted Output Power (dBm)					Limit (dBm)	Margin (dB)	EIRP (dBm)	EIRP Limit (dBm)	EIRP Margin (dB)
	A	B	C	D	Σ					
2404	8.86	8.56	-	-	11.69	30.00	-18.31	14.10	36.00	-21.90
2441	9.14	9.18	-	-	12.14	30.00	-17.86	14.54	36.00	-21.46
2476	8.92	9.23	-	-	12.05	30.00	-17.95	14.46	36.00	-21.54

Table 94 - ISED Maximum Conducted (peak) Output Power Results

FCC 47 CFR Part 15, Limit Clause 15.247 (b)(3)

For systems using digital modulation in the 902–928 MHz, 2400–2483.5 MHz, and 5725–5850 MHz bands: 1 Watt.

ISED RSS-247, Limit Clause 5.4 (b)

For DTSS employing digital modulation techniques operating in the bands 902-928 MHz and 2400-2483.5 MHz, the maximum peak conducted output power shall not exceed 1 W. The e.i.r.p. shall not exceed 4 W, except as provided in section 5.4(e) of the specification.



2.3.7 Test Location and Test Equipment Used

This test was carried out in RF Laboratory 1.

Instrument	Manufacturer	Type No	TE No	Calibration Period (months)	Calibration Expires
Multimeter	Fluke	79 Series III	611	12	21-Dec-2022
Hygrometer	Rotronic	I-1000	3220	12	05-Nov-2022
Frequency Standard	Spectracom	SecureSync 1200-0408-0601	4393	6	01-Feb-2023
AC Programmable Power Supply	iTech	IT7324	5225	-	O/P Mon
MXA Signal Analyser	Keysight Technologies	N9020B	5528	24	21-Mar-2024
Signal Conditioning Unit	TUV SUD	SPECTRUM SCU001	5546	12	06-Apr-2023
USB Power Sensor	Boonton	RTP5008	5820	12	06-Apr-2023
USB Power Sensor	Boonton	RTP5008	5821	12	06-Apr-2023
USB Power Sensor	Boonton	RTP5008	5831	12	06-Apr-2023

Table 95

O/P Mon – Output Monitored using calibrated equipment



2.4 Spurious Radiated Emissions

2.4.1 Specification Reference

FCC 47 CFR Part 15C, Clause 15.247 (d) and 15.209
ISED RSS-247, Clause 3.3 and 5.5
ISED RSS-GEN, Clause 6.13 and 8.9

2.4.2 Equipment Under Test and Modification State

A2737, S/N: QQRXMCWXL5 - Modification State 0

2.4.3 Date of Test

10-July-2022 to 02-September-2022

2.4.4 Test Method

This test was performed in accordance with ANSI C63.10, clause 6.3, 6.5 and 6.6.

For frequencies > 1 GHz, plots for average measurements were taken in accordance with ANSI C63.10, clause 11.12.2.5.2.

Ports on the EUT were terminated with loads as described in ANSI C63.4 clause 6.2.4. For EUT's with multiple connectors of the same type, additional interconnecting cables were connected, and pre-scans performed to determine whether the level of the emissions were increased by >2 dB.

In the 30 MHz to 1 GHz range pre-scans were only performed on the mid channel only.

The plots shown are the characterisation of the EUT. The limits on the plots represent the most stringent case for restricted bands, (74/54 dBuV/m) when compared to 20 dBc outside restricted bands. The limits shown have been used as a threshold to determine where further measurements are necessary. Where results are within 10 dB of the limits shown on the plots, further investigation was carried out and reported in results tables.

The following conversion can be applied to convert from dB μ V/m to μ V/m:
 $10^{(\text{Field Strength in dB}\mu\text{V/m}/20)}$.

Above 18 GHz, the measurement distance was reduced to 1 m. The limit line was increased by $20 \cdot \text{LOG}(3/1) = 9.54$ dB.

At a measurement distance of 1 meter the limit line was increased by $20 \cdot \text{LOG}(3/1) = 9.54$ dB.

Where formal measurements have been necessary, the results have been presented in the emissions table.

2.4.5 Test Setup Diagram

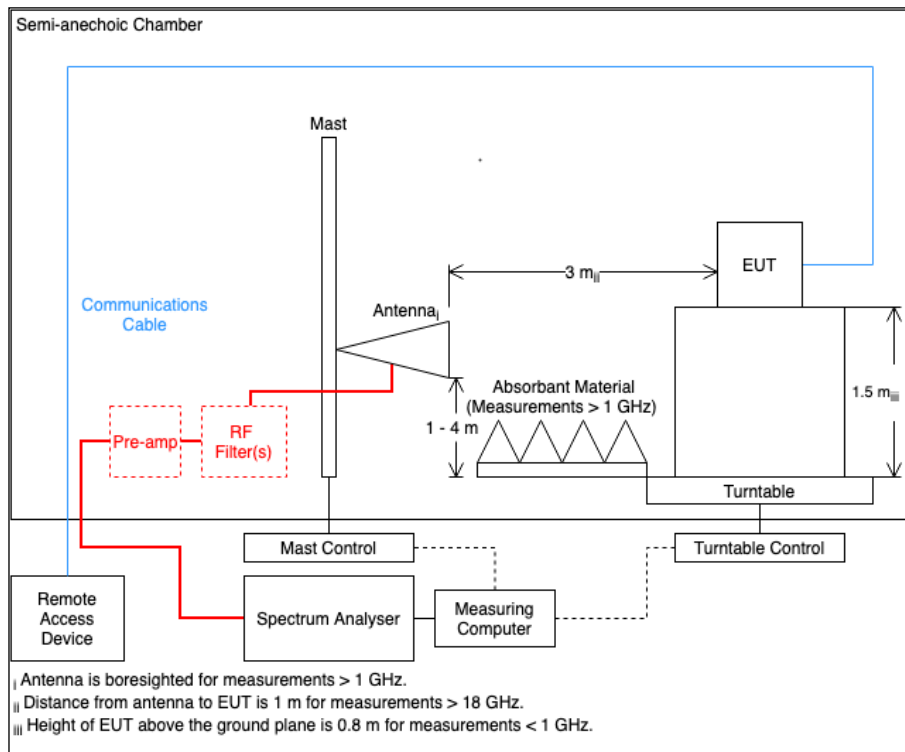

Figure 177

2.4.6 Environmental Conditions

Ambient Temperature 21.8 - 22.6 °C
Relative Humidity 41.2 - 49.7 %



2.4.7 Test Results

2.4 GHz Bluetooth - DTS

Frequency (MHz)	Level (dBuV/m)	Limit (dBuV/m)	Margin (dB)	Detector	Angle (°)	Height (cm)	Polarisation
*							

Table 96 - 2404 MHz (CH0), LE1M, iPA, Core 0, 1 GHz to 26 GHz

*No emissions found within 10 dB of the limit.

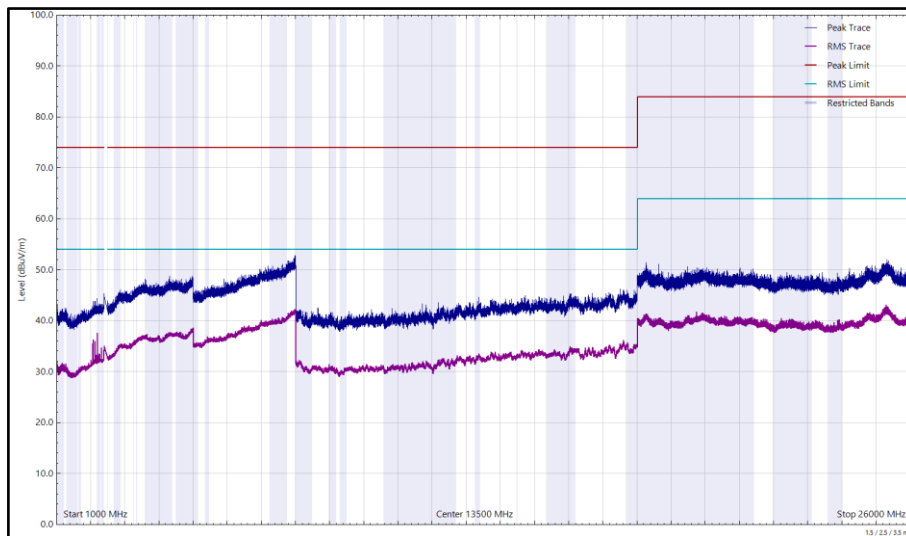

Figure 162 - 2404 MHz (CH0), LE1M, iPA, Core 0, 1 GHz to 26 GHz, Horizontal

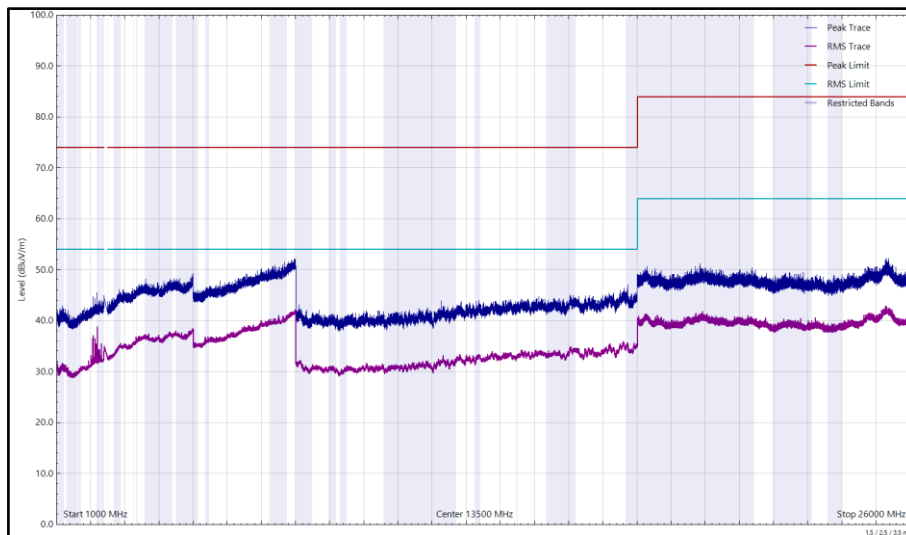

Figure 163 - 2404 MHz (CH0), LE1M, iPA, Core 0, 1 GHz to 26 GHz, Vertical



Frequency (MHz)	Level (dBuV/m)	Limit (dBuV/m)	Margin (dB)	Detector	Angle (°)	Height (cm)	Polarisation
*							

Table 97 - 2440 MHz (CH17), LE1M, iPA, Core 0, 30 MHz to 26 GHz

*No emissions found within 10 dB of the limit.

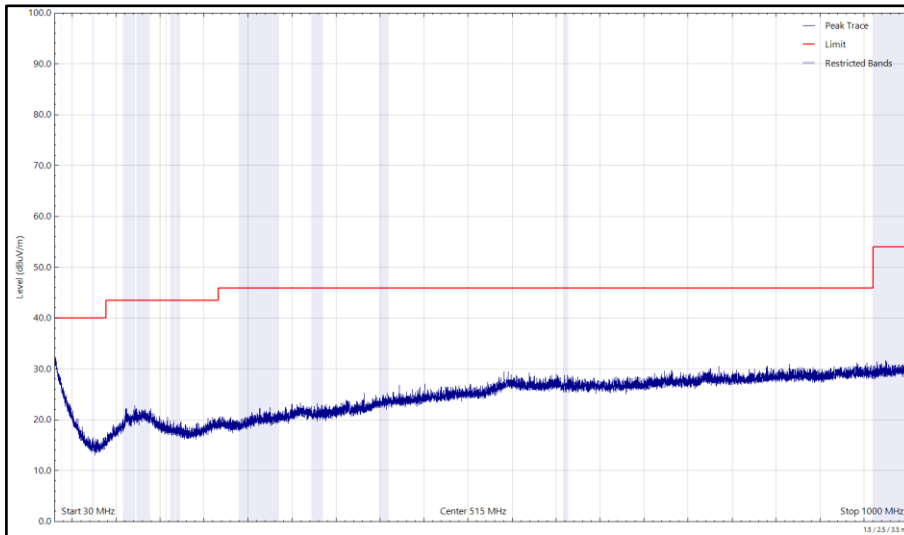

Figure 164 - 2440 MHz (CH17), LE1M, iPA, Core 0, 30 MHz to 1 GHz, Horizontal (Peak)

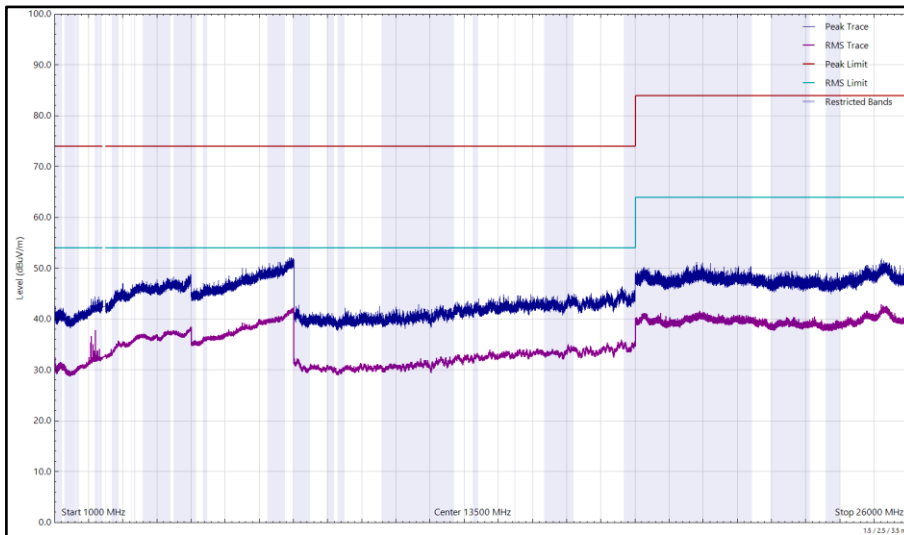

Figure 165 - 2440 MHz (CH17), LE1M, iPA, Core 0, 1 GHz to 26 GHz, Horizontal

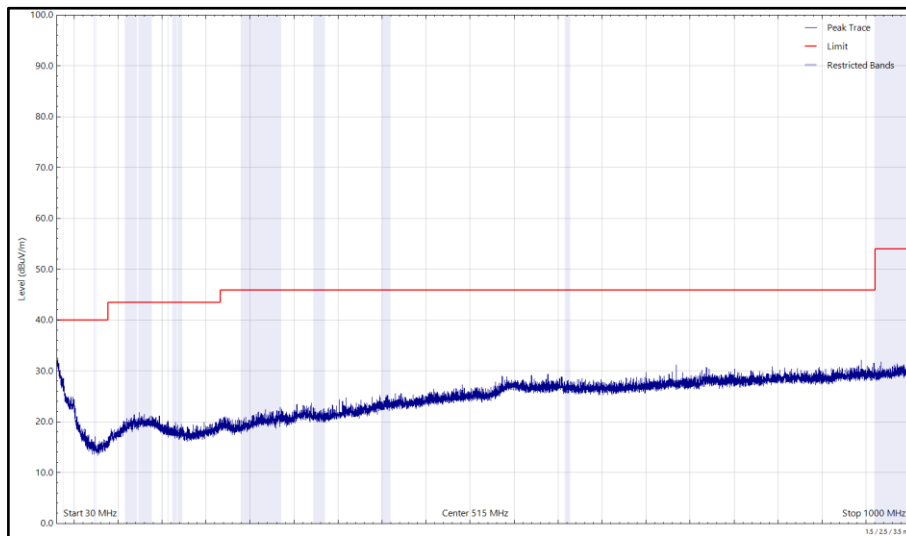

Figure 166 - 2440 MHz (CH17), LE1M, iPA, Core 0, 30 MHz to 1 GHz, Vertical (Peak)

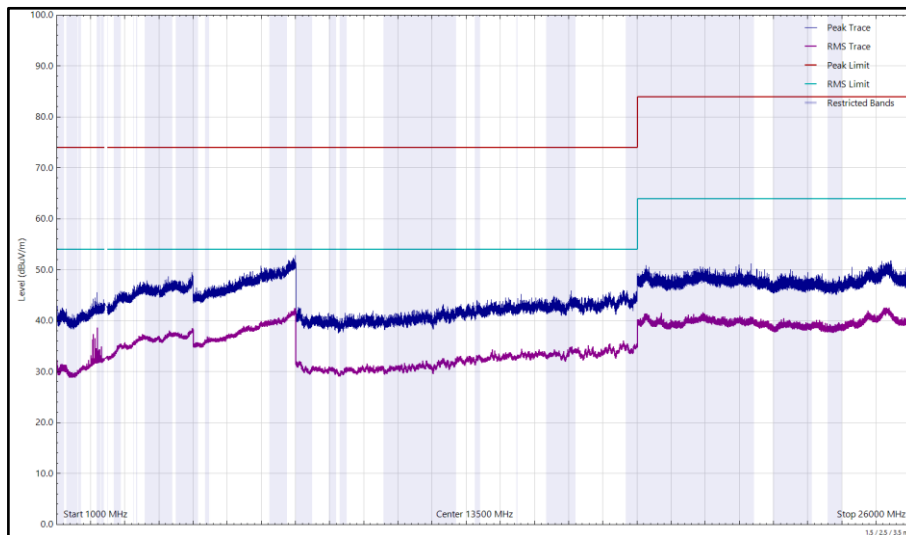

Figure 167 - 2440 MHz (CH17), LE1M, iPA, Core 0, 1 GHz to 26 GHz, Vertical



Frequency (MHz)	Level (dBuV/m)	Limit (dBuV/m)	Margin (dB)	Detector	Angle (°)	Height (cm)	Polarisation
*							

Table 98 - 2480 MHz (CH39), LE1M, iPA, Core 0, 1 GHz to 26 GHz

*No emissions found within 10 dB of the limit.

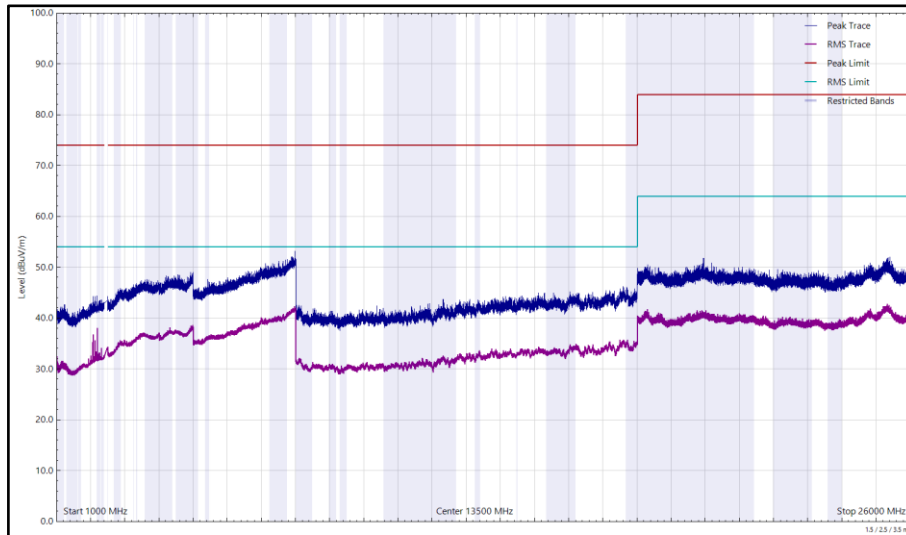

Figure 168 - 2480 MHz (CH39), LE1M, iPA, Core 0, 1 GHz to 26 GHz, Horizontal

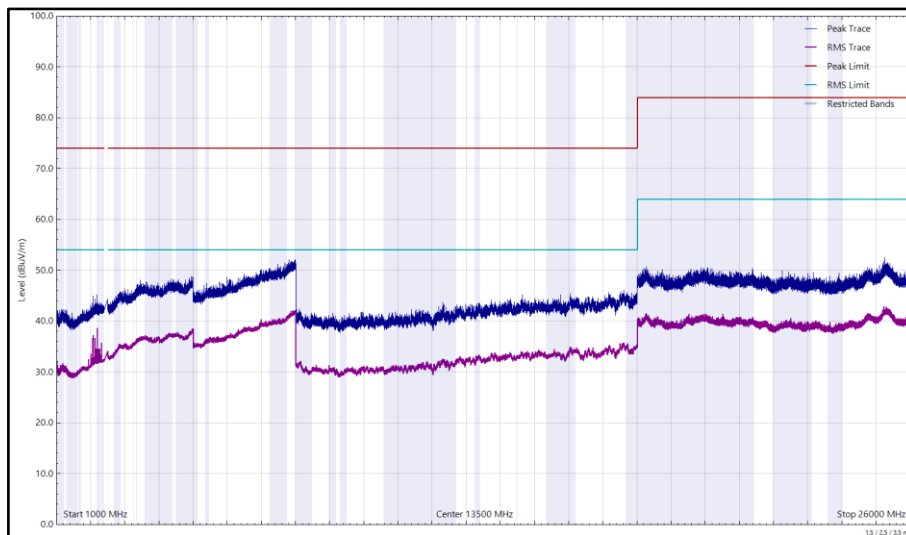

Figure 169 - 2480 MHz (CH39), LE1M, iPA, Core 0, 1 GHz to 26 GHz, Vertical



Frequency (MHz)	Level (dBuV/m)	Limit (dBuV/m)	Margin (dB)	Detector	Angle (°)	Height (cm)	Polarisation
*							

Table 99 - 2404 MHz (CH0), LE1M, ePA, Core 0, 1 GHz to 26 GHz

*No emissions found within 10 dB of the limit.

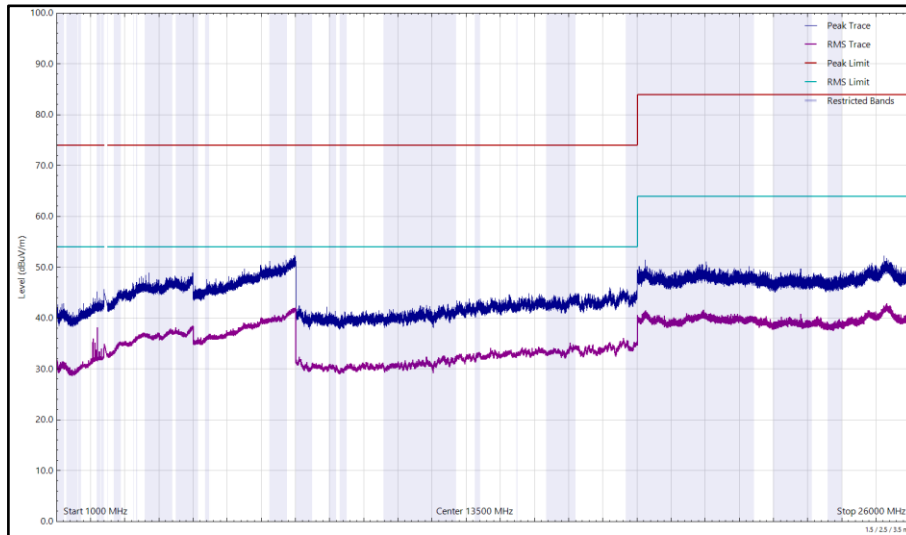

Figure 170 - 2404 MHz (CH0), LE1M, ePA, Core 0, 1 GHz to 26 GHz, Horizontal

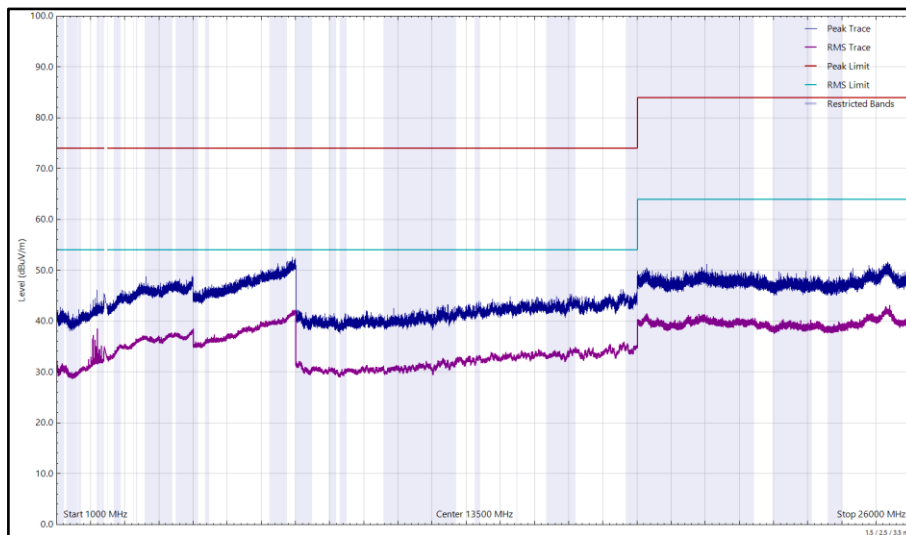

Figure 171 - 2404 MHz (CH0), LE1M, ePA, Core 0, 1 GHz to 26 GHz, Vertical



Frequency (MHz)	Level (dBuV/m)	Limit (dBuV/m)	Margin (dB)	Detector	Angle (°)	Height (cm)	Polarisation
*							

Table 100 - 2440 MHz (CH17), LE1M, ePA, Core 0, 30 MHz to 26 GHz

*No emissions found within 10 dB of the limit.

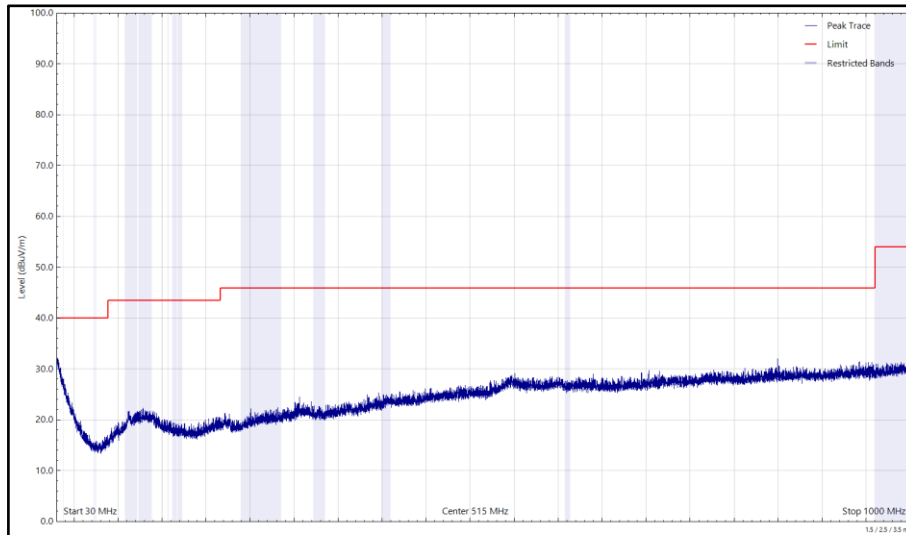

Figure 172 - 2440 MHz (CH17), LE1M, ePA, Core 0, 30 MHz to 1 GHz, Horizontal (Peak)

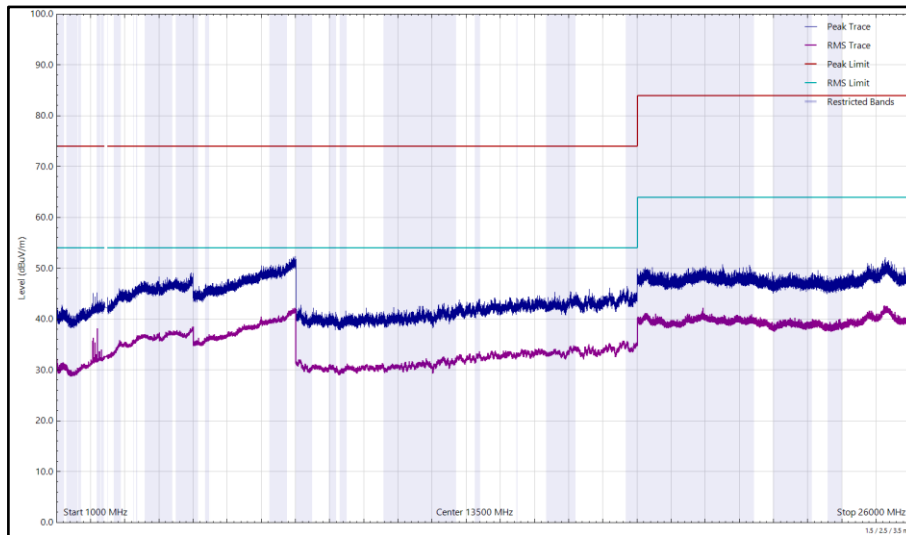

Figure 173 - 2440 MHz (CH17), LE1M, ePA, Core 0, 1 GHz to 26 GHz, Horizontal

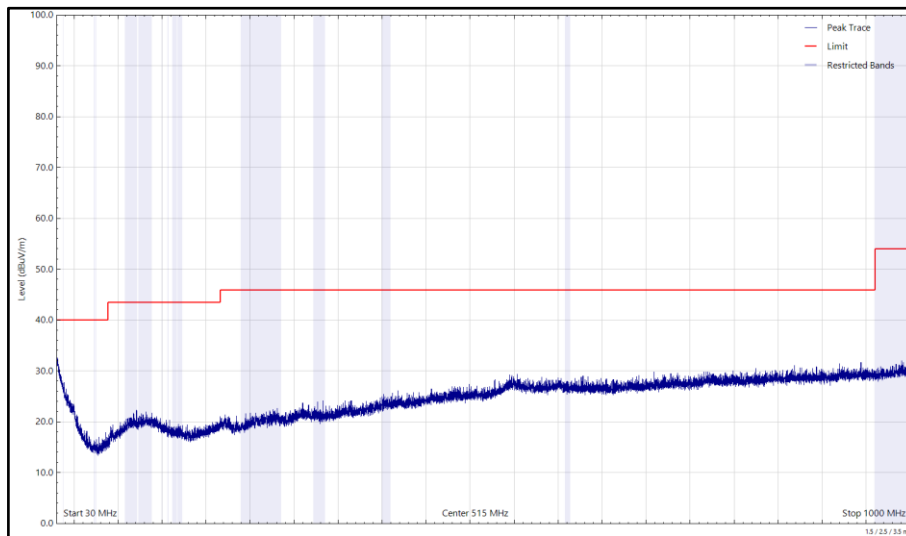

Figure 174 - 2440 MHz (CH17), LE1M, ePA, Core 0, 30 MHz to 1 GHz, Vertical (Peak)

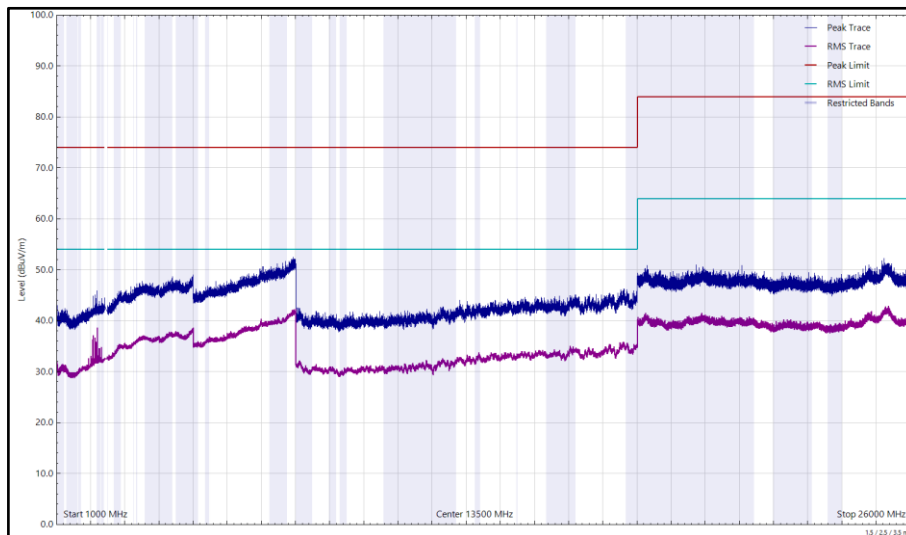

Figure 175 - 2440 MHz (CH17), LE1M, ePA, Core 0, 1 GHz to 26 GHz, Vertical



Frequency (MHz)	Level (dBuV/m)	Limit (dBuV/m)	Margin (dB)	Detector	Angle (°)	Height (cm)	Polarisation
*							

Table 101 - 2480 MHz (CH39), LE1M, ePA, Core 0, 1 GHz to 26 GHz

*No emissions found within 10 dB of the limit.

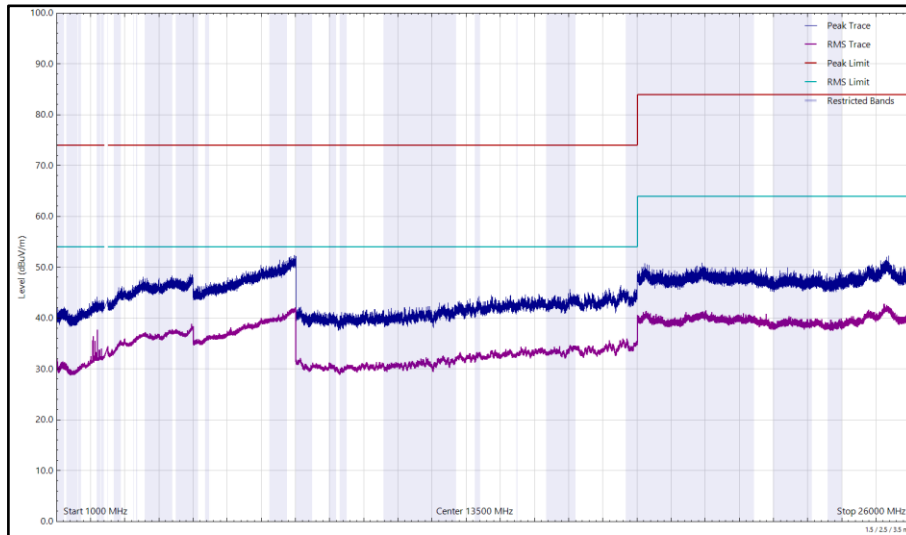

Figure 176 - 2480 MHz (CH39), LE1M, ePA, Core 0, 1 GHz to 26 GHz, Horizontal

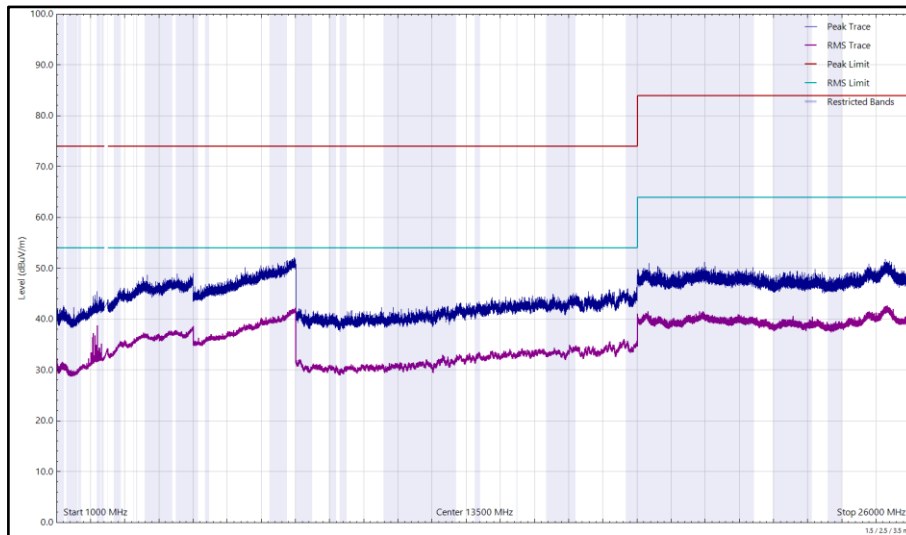

Figure 177 - 2480 MHz (CH39), LE1M, ePA, Core 0, 1 GHz to 26 GHz, Vertical



Frequency (MHz)	Level (dBuV/m)	Limit (dBuV/m)	Margin (dB)	Detector	Angle (°)	Height (cm)	Polarisation
*							

Table 102 - 2404 MHz (CH0), LE1M, iPA, Core 1, 1 GHz to 26 GHz

*No emissions found within 10 dB of the limit.

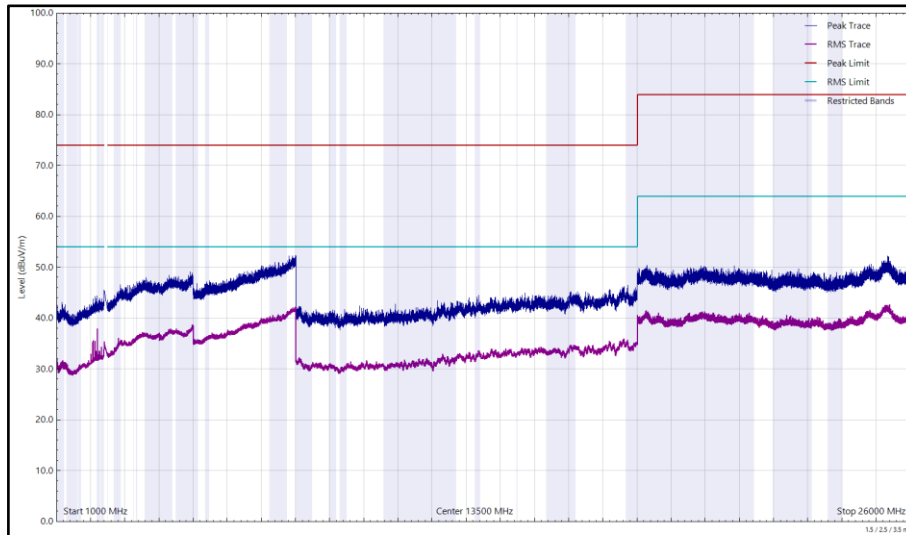

Figure 178 - 2404 MHz (CH0), LE1M, iPA, Core 1, 1 GHz to 26 GHz, Horizontal

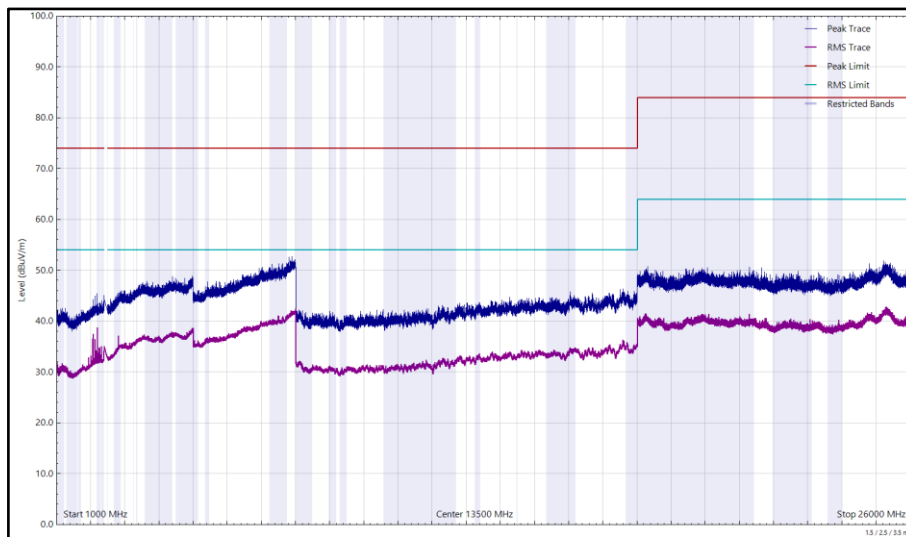

Figure 179 - 2404 MHz (CH0), LE1M, iPA, Core 1, 1 GHz to 26 GHz, Vertical



Frequency (MHz)	Level (dBuV/m)	Limit (dBuV/m)	Margin (dB)	Detector	Angle (°)	Height (cm)	Polarisation
*							

Table 103 - 2440 MHz (CH17), LE1M, iPA, Core 1, 30 MHz to 26 GHz

*No emissions found within 10 dB of the limit.

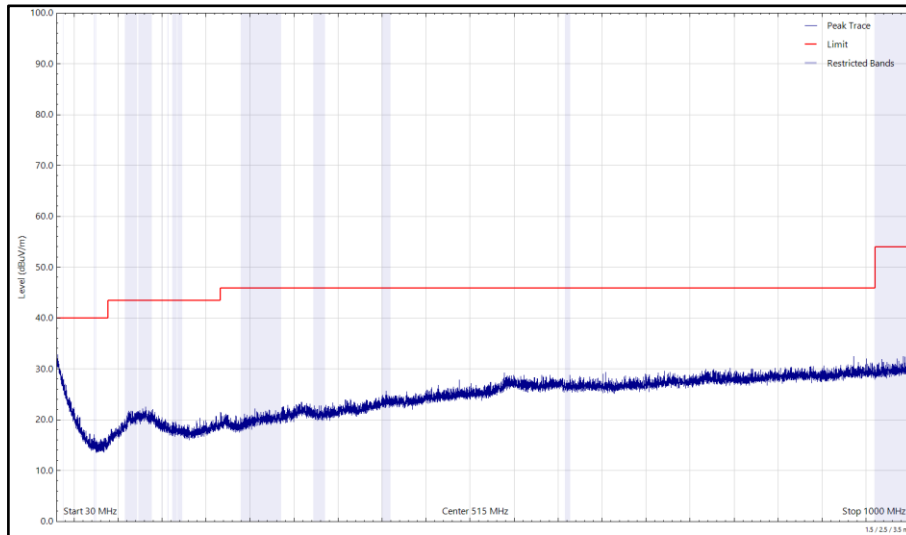

Figure 180 - 2440 MHz (CH17), LE1M, iPA, Core 1, 30 MHz to 1 GHz, Horizontal (Peak)

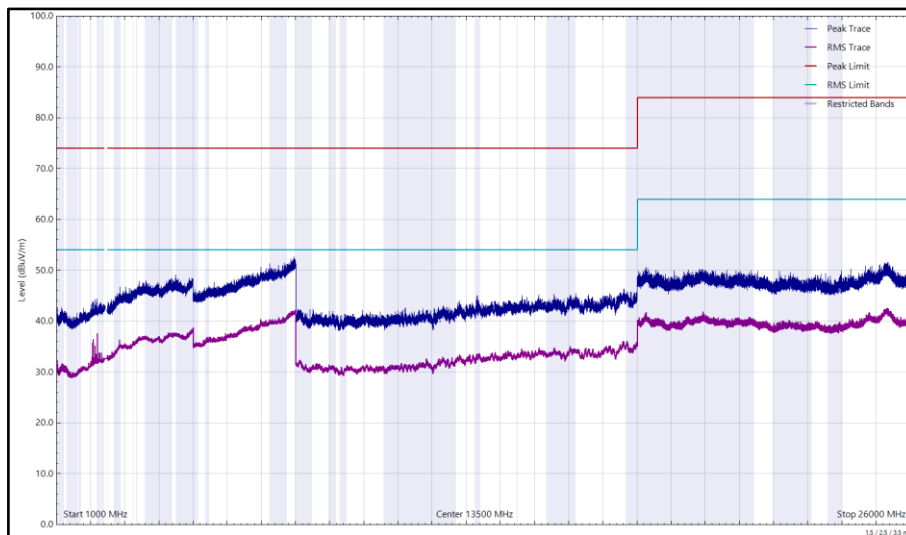

Figure 181 - 2440 MHz (CH17), LE1M, iPA, Core 1, 1 GHz to 26 GHz, Horizontal

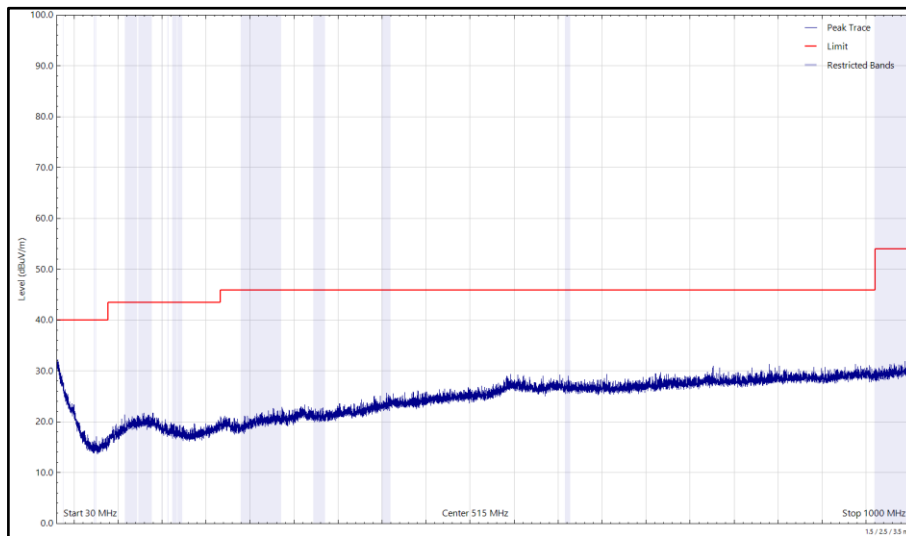

Figure 182 - 2440 MHz (CH17), LE1M, iPA, Core 1, 30 MHz to 1 GHz, Vertical (Peak)

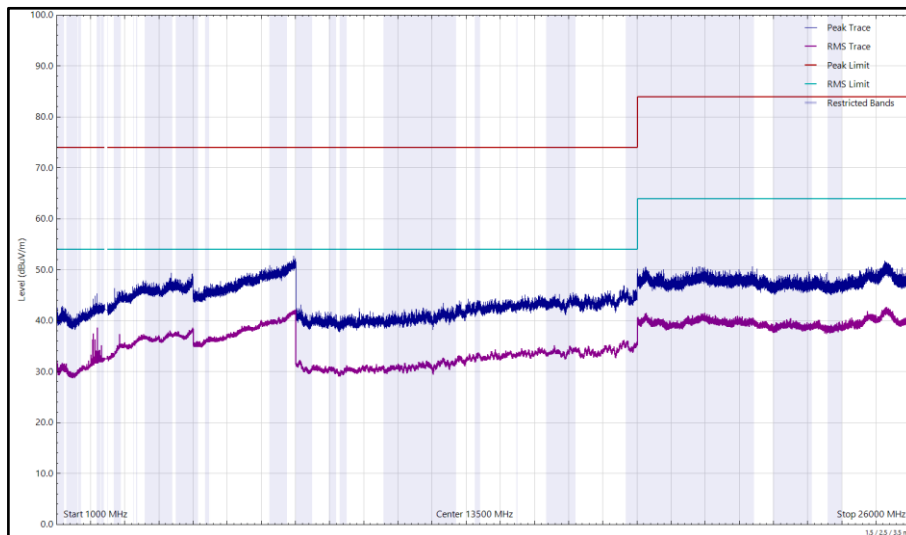

Figure 183 - 2440 MHz (CH17), LE1M, iPA, Core 1, 1 GHz to 26 GHz, Vertical



Frequency (MHz)	Level (dBuV/m)	Limit (dBuV/m)	Margin (dB)	Detector	Angle (°)	Height (cm)	Polarisation
*							

Table 104 - 2480 MHz (CH39), LE1M, iPA, Core 1, 1 GHz to 26 GHz

*No emissions found within 10 dB of the limit.

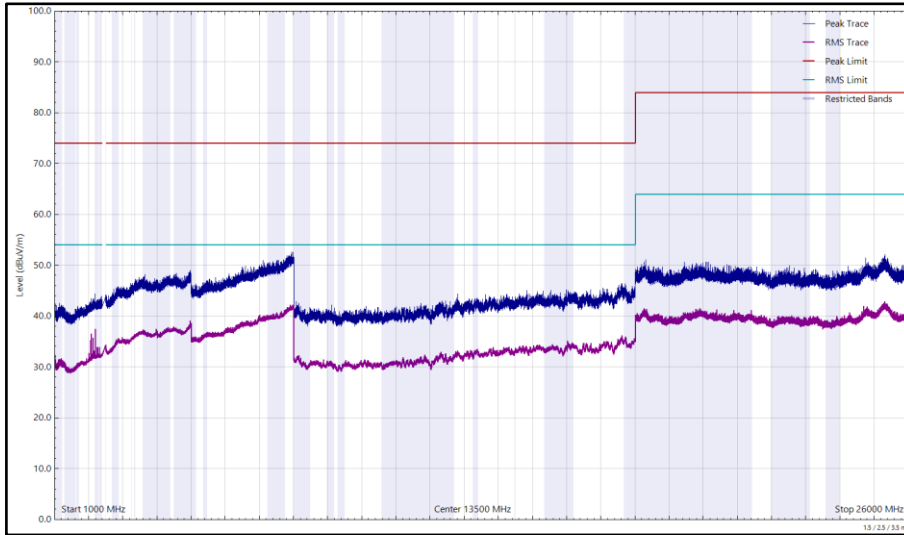

Figure 184 - 2480 MHz (CH39), LE1M, iPA, Core 1, 1 GHz to 26 GHz, Horizontal

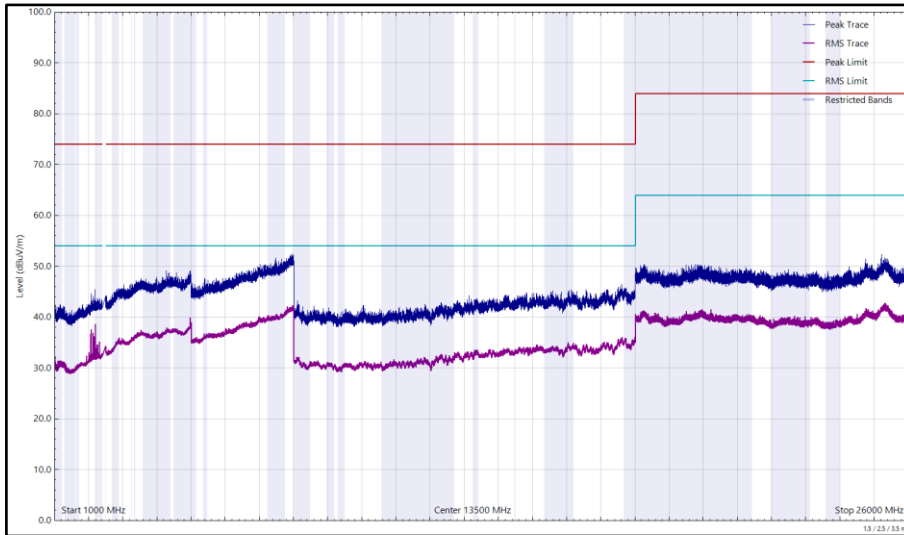

Figure 185 - 2480 MHz (CH39), LE1M, iPA, Core 1, 1 GHz to 26 GHz, Vertical



Frequency (MHz)	Level (dBuV/m)	Limit (dBuV/m)	Margin (dB)	Detector	Angle (°)	Height (cm)	Polarisation
*							

Table 105 - 2404 MHz (CH0), LE1M, ePA, Core 1, 1 GHz to 26 GHz

*No emissions found within 10 dB of the limit.

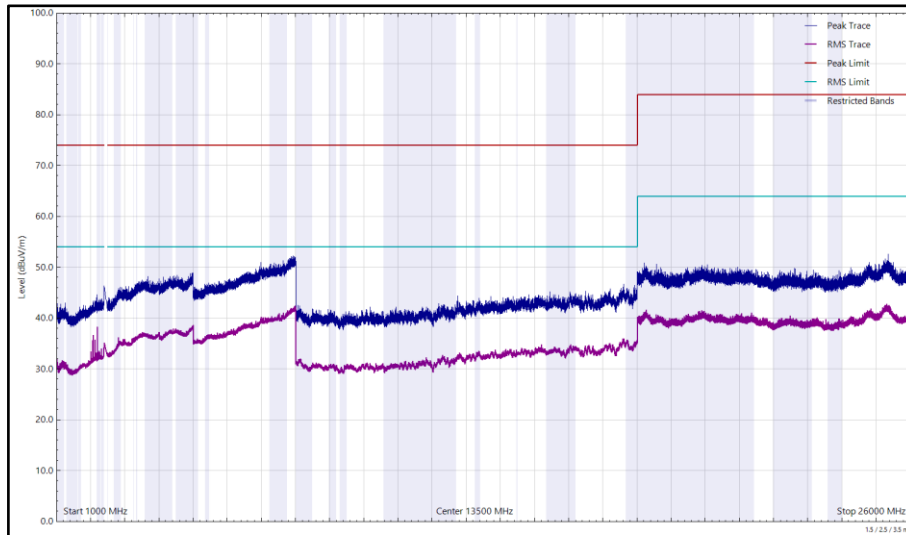

Figure 186 - 2404 MHz (CH0), LE1M, ePA, Core 1, 1 GHz to 26 GHz, Horizontal

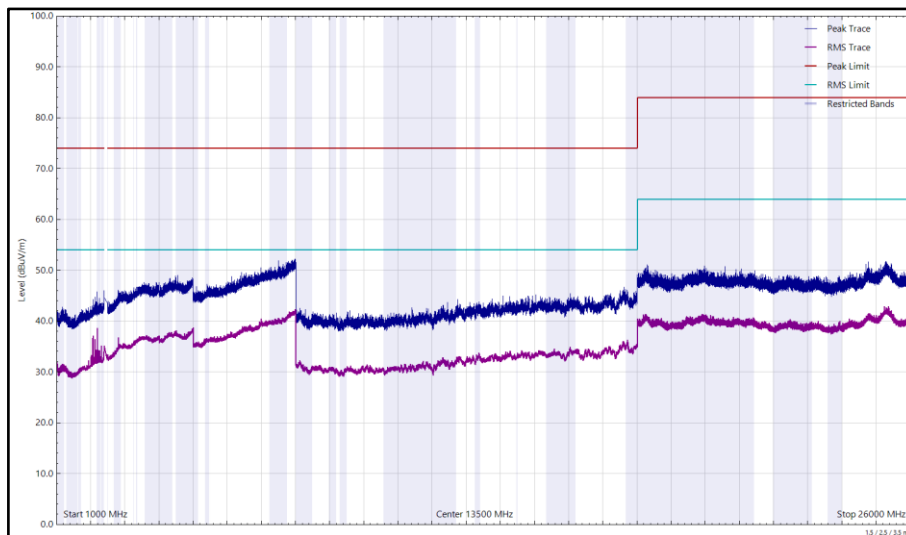

Figure 187 - 2404 MHz (CH0), LE1M, ePA, Core 1, 1 GHz to 26 GHz, Vertical



Frequency (MHz)	Level (dBuV/m)	Limit (dBuV/m)	Margin (dB)	Detector	Angle (°)	Height (cm)	Polarisation
*							

Table 106 - 2440 MHz (CH17), LE1M, ePA, Core 1, 30 MHz to 26 GHz

*No emissions found within 10 dB of the limit.

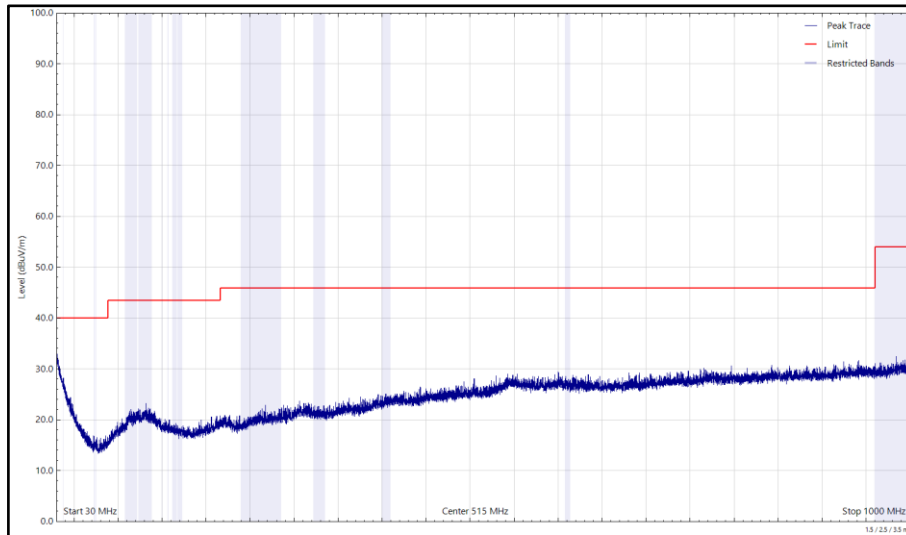

Figure 188 - 2440 MHz (CH17), LE1M, ePA, Core 1, 30 MHz to 1 GHz, Horizontal (Peak)

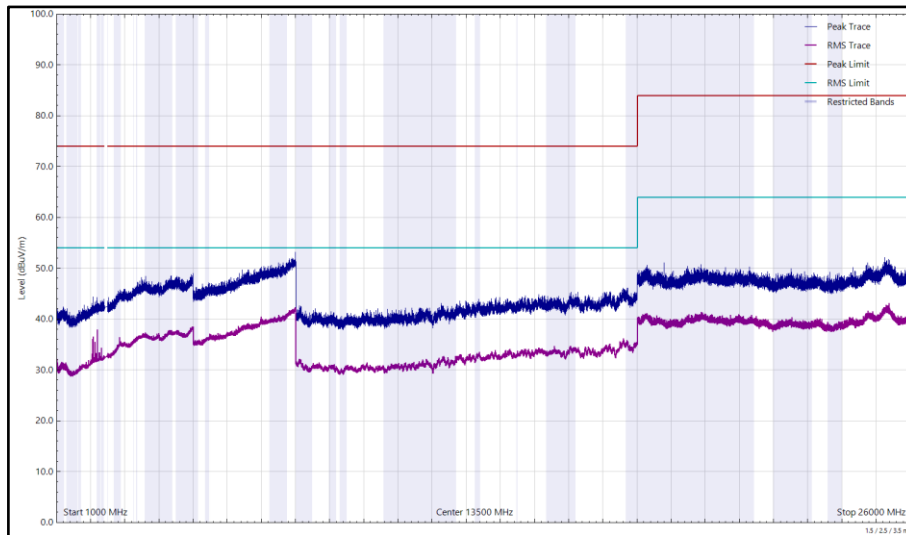

Figure 189 - 2440 MHz (CH17), LE1M, ePA, Core 1, 1 GHz to 26 GHz, Horizontal

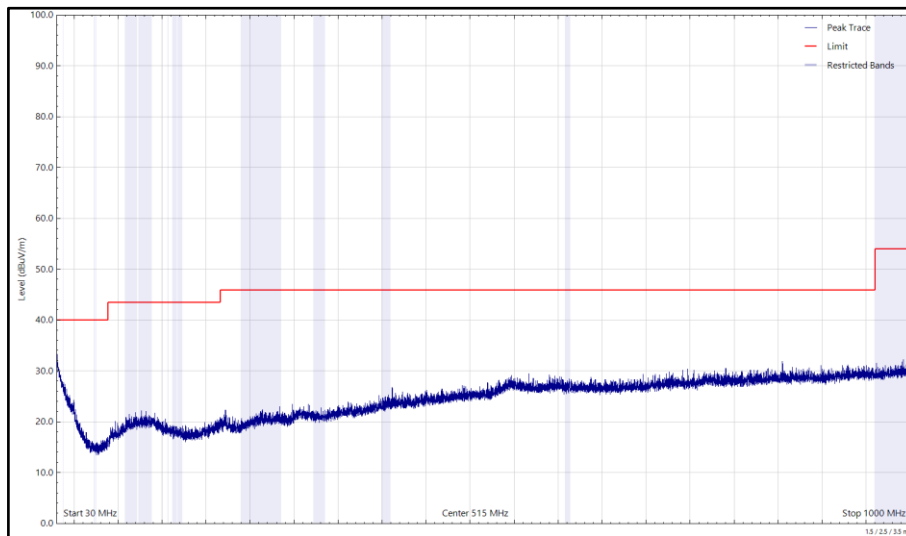

Figure 190 - 2440 MHz (CH17), LE1M, ePA, Core 1, 30 MHz to 1 GHz, Vertical (Peak)

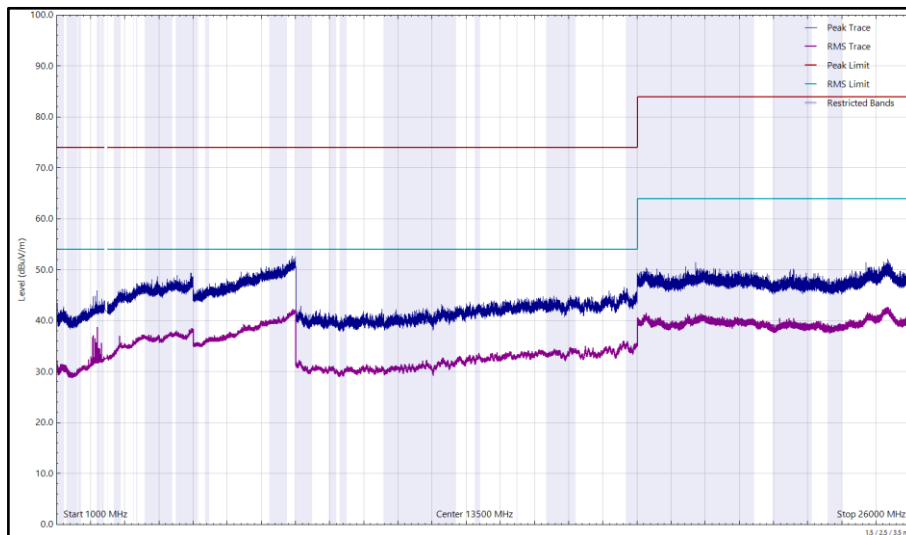

Figure 191 - 2440 MHz (CH17), LE1M, ePA, Core 1, 1 GHz to 26 GHz, Vertical



Frequency (MHz)	Level (dBuV/m)	Limit (dBuV/m)	Margin (dB)	Detector	Angle (°)	Height (cm)	Polarisation
*							

Table 107 - 2480 MHz (CH39), LE1M, ePA, Core 1, 1 GHz to 26 GHz

*No emissions found within 10 dB of the limit.

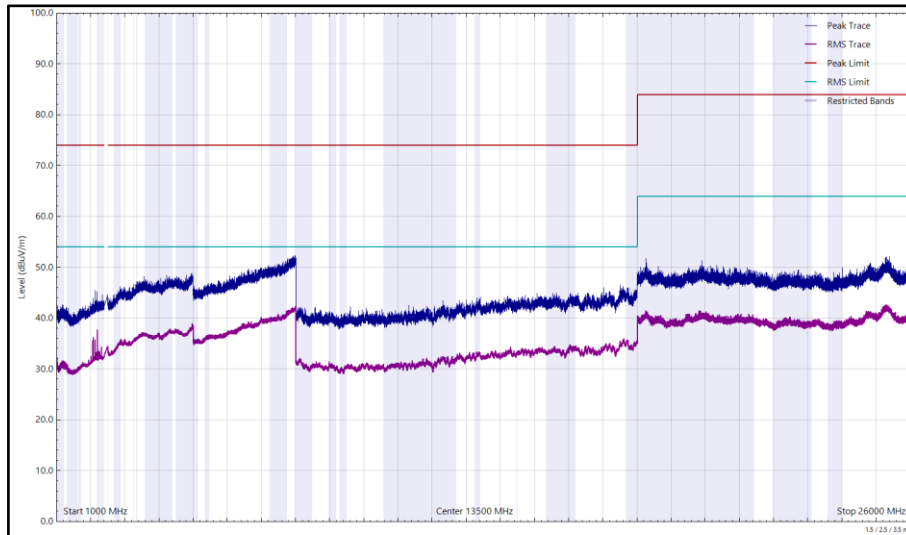

Figure 192 - 2480 MHz (CH39), LE1M, ePA, Core 1, 1 GHz to 26 GHz, Horizontal

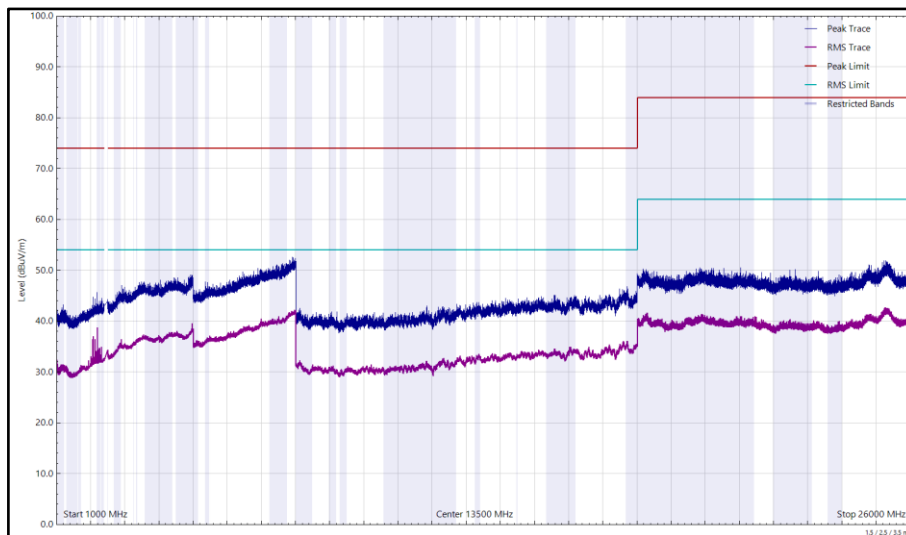

Figure 193 - 2480 MHz (CH39), LE1M, ePA, Core 1, 1 GHz to 26 GHz, Vertical



Frequency (MHz)	Level (dBuV/m)	Limit (dBuV/m)	Margin (dB)	Detector	Angle (°)	Height (cm)	Polarisation
*							

Table 108 - 2404 MHz (CH0), LE1M, iPA, Core 2, 1 GHz to 26 GHz

*No emissions found within 10 dB of the limit.

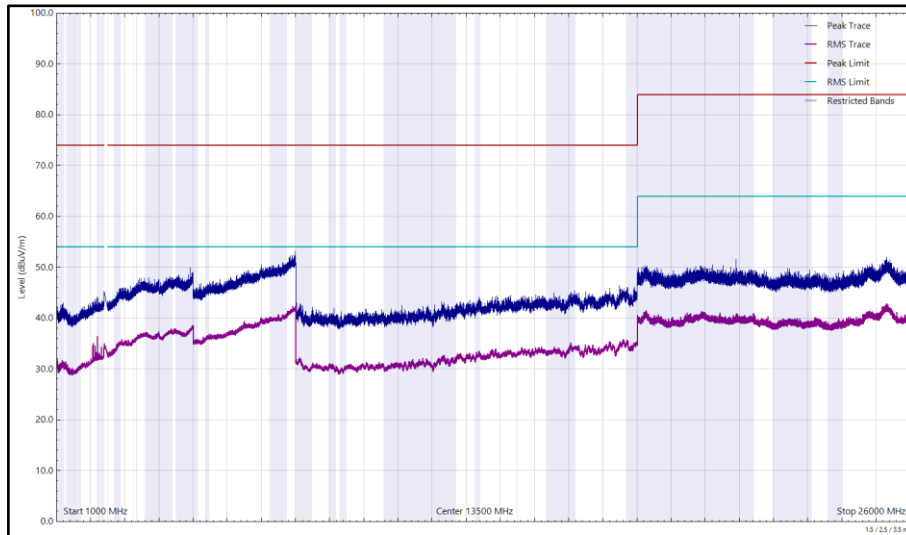

Figure 194 - 2404 MHz (CH0), LE1M, iPA, Core 2, 1 GHz to 26 GHz, Horizontal

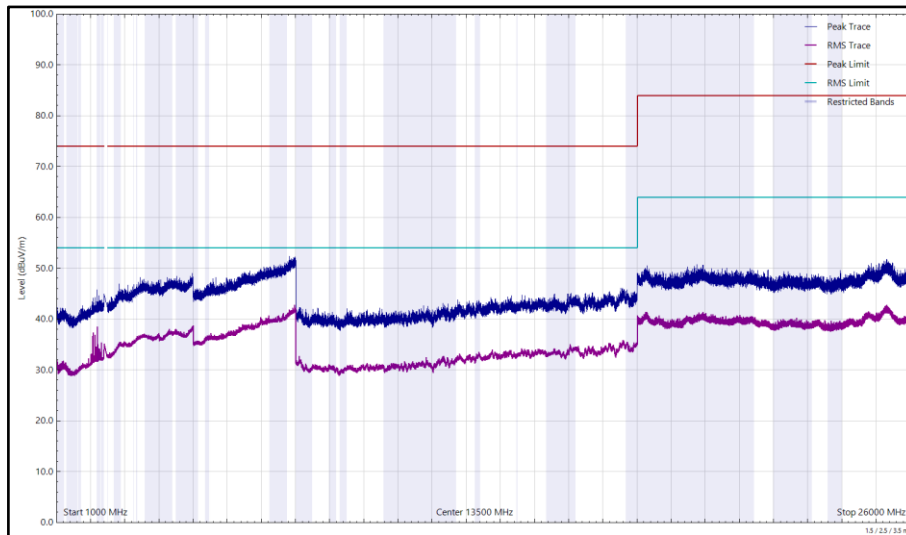

Figure 195 - 2404 MHz (CH0), LE1M, iPA, Core 2, 1 GHz to 26 GHz, Vertical



Frequency (MHz)	Level (dBuV/m)	Limit (dBuV/m)	Margin (dB)	Detector	Angle (°)	Height (cm)	Polarisation
*							

Table 109 - 2440 MHz (CH17), LE1M, iPA, Core 2, 30 MHz to 26 GHz

*No emissions found within 10 dB of the limit.

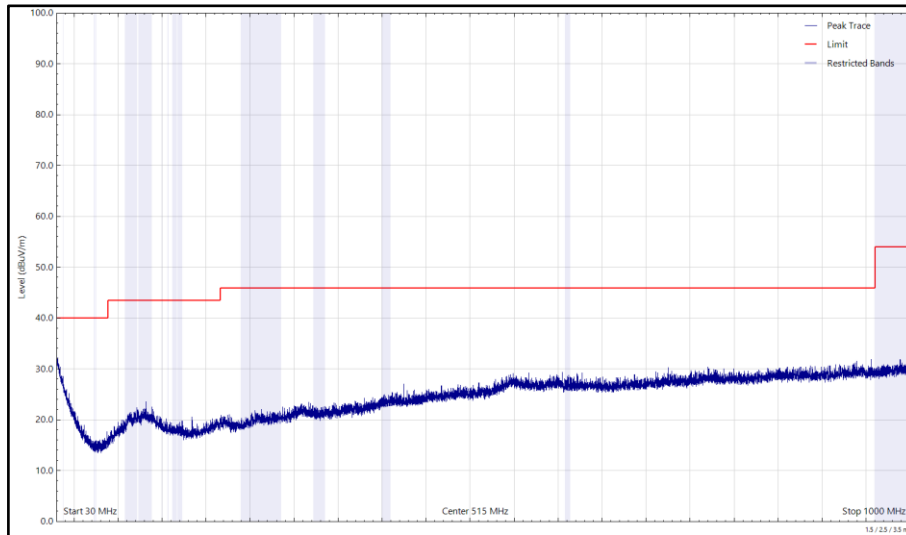

Figure 196 - 2440 MHz (CH17), LE1M, iPA, Core 2, 30 MHz to 1 GHz, Horizontal (Peak)

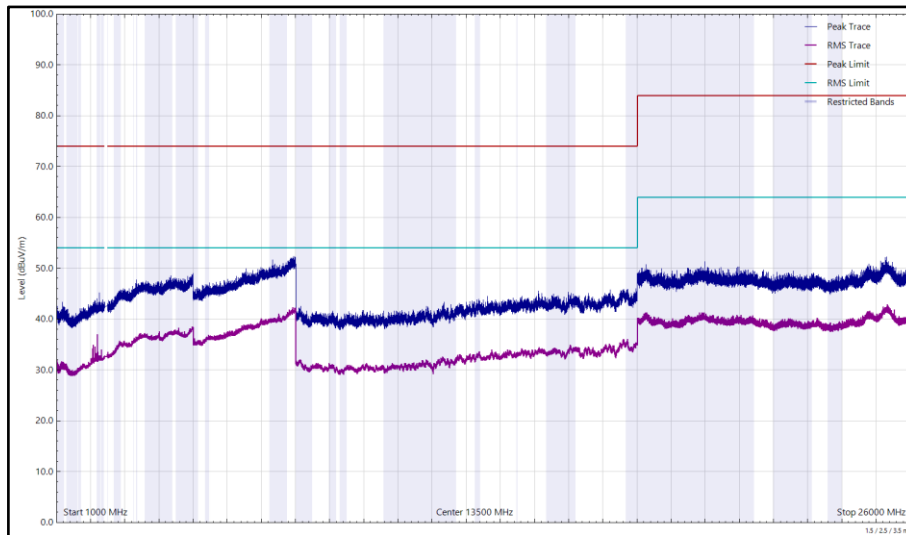

Figure 197 - 2440 MHz (CH17), LE1M, iPA, Core 2, 1 GHz to 26 GHz, Horizontal

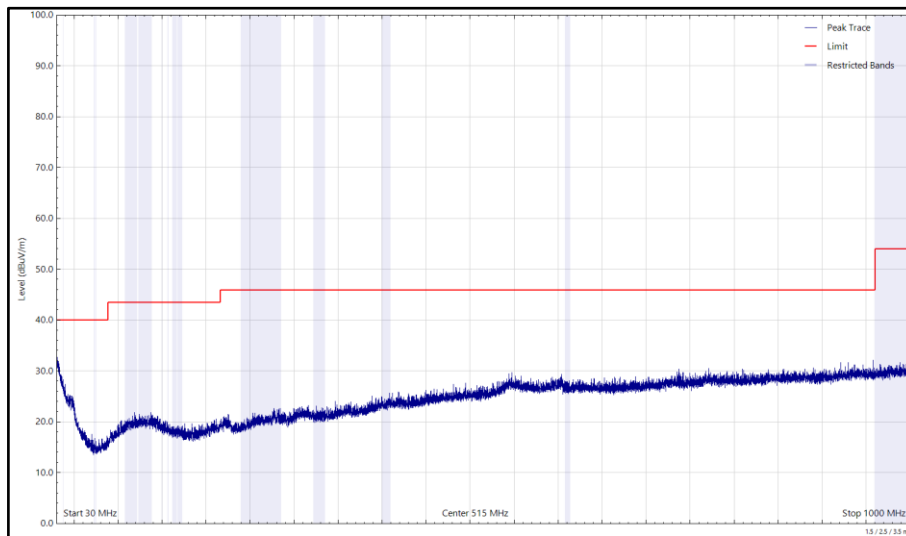

Figure 198 - 2440 MHz (CH17), LE1M, iPA, Core 2, 30 MHz to 1 GHz, Vertical (Peak)

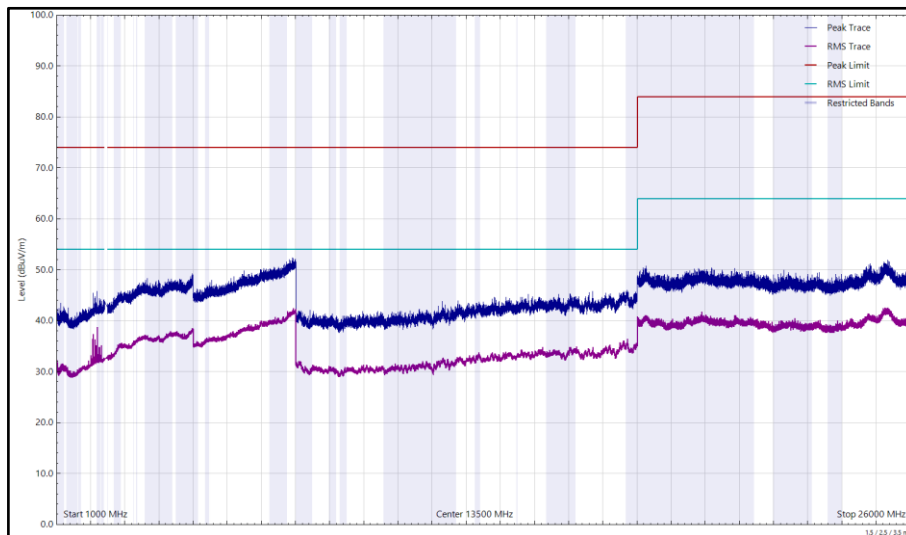

Figure 199 - 2440 MHz (CH17), LE1M, iPA, Core 2, 1 GHz to 26 GHz, Vertical



Frequency (MHz)	Level (dBuV/m)	Limit (dBuV/m)	Margin (dB)	Detector	Angle (°)	Height (cm)	Polarisation
*							

Table 110 - 2480 MHz (CH39), LE1M, iPA, Core 2, 1 GHz to 26 GHz

*No emissions found within 10 dB of the limit.

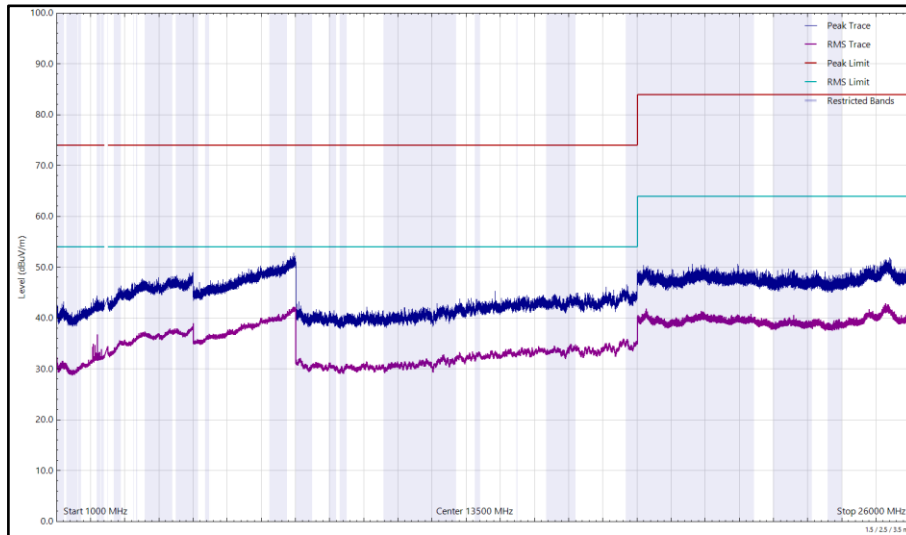

Figure 200 - 2480 MHz (CH39), LE1M, iPA, Core 2, 1 GHz to 26 GHz, Horizontal

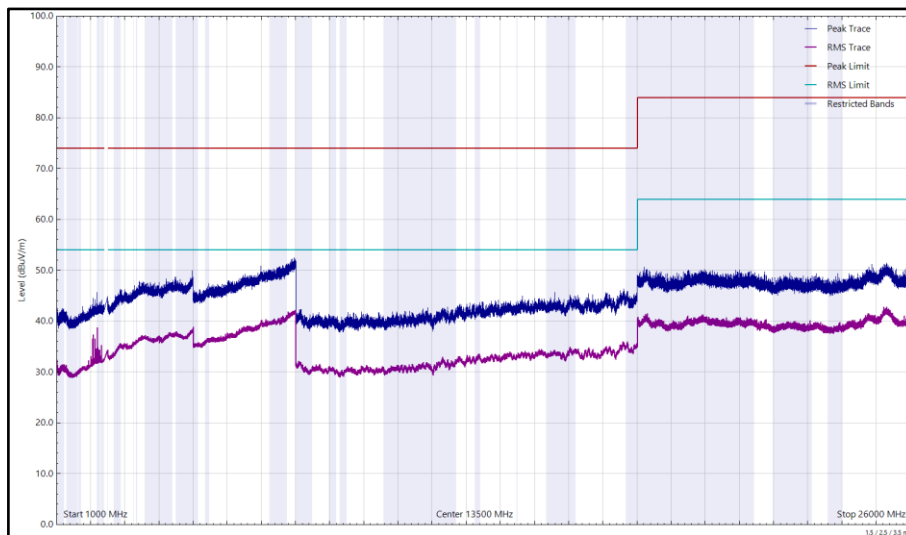

Figure 201 - 2480 MHz (CH39), LE1M, iPA, Core 2, 1 GHz to 26 GHz, Vertical



FCC 47 CFR Part 15, Limit Clause 15.247 (d)

In any 100 kHz bandwidth outside the frequency band in which the spread spectrum or digitally modulated intentional radiator is operating, the radio frequency power that is produced by the intentional radiator shall be at least 20 dB below that in the 100 kHz bandwidth within the band that contains the highest level of the desired power, based on either an RF conducted or a radiated measurement, provided the transmitter demonstrates compliance with the peak conducted power limits. If the transmitter complies with the conducted power limits based on the use of RMS averaging over a time interval, as permitted under paragraph (b)(3) of this section, the attenuation required under this paragraph shall be 30 dB instead of 20 dB.

Attenuation below the general limits specified in § 15.209(a) is not required. In addition, radiated emissions which fall in the restricted bands, as defined in § 15.205(a), must also comply with the radiated emission limits specified in 15.209(a)

ISED RSS-247, Limit Clause 5.5

In any 100 kHz bandwidth outside the frequency band in which the spread spectrum or digitally modulated device is operating, the RF power that is produced shall be at least 20 dB below that in the 100 kHz bandwidth within the band that contains the highest level of the desired power, based on either an RF conducted or a radiated measurement, provided that the transmitter demonstrates compliance with the peak conducted power limits. If the transmitter complies with the conducted power limits based on the use of root-mean-square averaging over a time interval, as permitted under Section 5.4(4), the attenuation required shall be 30 dB instead of 20 dB. Attenuation below the general field strength limits specified in RSS-Gen is not required.

In addition, radiated emissions which fall in the restricted bands, as defined in RSS-GEN, clause 8.10, must also comply with the radiated emission limits specified in RSS-GEN clause 8.9.



2.4.8 Test Location and Test Equipment Used

This test was carried out in RF Chamber 11 and RF Chamber 14.

Instrument	Manufacturer	Type No	TE No	Calibration Period (months)	Calibration Expires
Antenna with attenuator (Bilog, 30 MHz to 3 GHz)	Schaffner	CBL6143	287	24	14-Oct-2022
EMI Test Receiver	Rohde & Schwarz	ESW44	5084	12	17-May-2023
Screened Room (11)	Rainford	Rainford	5136	36	24-Nov-2024
Mast	Maturo	TAM 4.0-P	5158	-	TU
Mast and Turntable Controller	Maturo	Maturo NCD	5159	-	TU
Turntable	Maturo	TT 15WF	5160	-	TU
2m SMA Cable	Junkosha	MWX221-02000AMSAMS/A	5518	12	12-Apr-2023
8m N Type Cable	Junkosha	MWX221-08000NMSNMS/B	5522	12	24-Mar-2023
1200 MHz Low Pass Filter (02)	Mini-Circuits	VLF-1200+	5560	12	23-May-2023
EMI Test Receiver	Rohde & Schwarz	ESW44	5912	12	17-Feb-2023
Cable (K Type 2m)	Junkosha	MWX241-01000KMSKMS/B	5934	12	14-May-2023
DRG Horn Antenna (7.5-18GHz)	Schwarzbeck	HWRD750	5941	12	29-May-2023
TRILOG Super Broadband Test Antenna	Schwarzbeck	VULB 9168	5943	24	03-Feb-2024
1500W (300V 12A) AC Power Supply	iTech	IT7324	5955	-	O/P Mon
5m Semi-Anechoic Chamber (Dual-Axis)	Albatross Projects	RF Chamber 14	5958	36	26-Apr-2025
Compact Antenna Mast	Maturo Gmbh	CAM4.0-P	5959	-	TU
Mast & Turntable Controller	Maturo Gmbh	FCU3.0	5960	-	TU
Tilt Antenna Mast	Maturo Gmbh	BAM4.5-P	5961	-	TU
Turntable	Maturo Gmbh	TT1.5SI	5962	-	TU
Cable (sma to sma 1m)	Junkosha	MWX221-01000AMSAMS/A	5997	12	06-Jun-2023
Cable (SMA to SMA 4.5m)	Junkosha	MWX221-04500AMSAMS/A	6002	12	06-Jun-2023
Cable (SMA to SMA 6.5m)	Junkosha	MWX221-06500AMSAMS/B	6003	12	07-Jun-2023
Cable (SMA to SMA 1m)	Junkosha	MWX221-01000AMSAMS/A	6008	12	06-Jun-2023
Cable (N to N 8m)	Junkosha	MWX221-08000NMSNMS/A	6017	12	05-Jun-2023
Horn Antenna (1-10 GHz)	Schwarzbeck	BBHA9120B	6141	12	21-Jun-2023



Instrument	Manufacturer	Type No	TE No	Calibration Period (months)	Calibration Expires
SAC Switch Unit	TUV SUD	SSU001	6144	12	07-Jul-2023
Digital Multimeter	Fluke	115	6145	12	17-Jun-2023
Humidity & Temperature meter	R.S Components	1364	6150	12	17-Jun-2023
Double Ridge Active Horn Antenna (18-40 GHz)	Com-Power	AHA-840	6187	24	02-Jun-2024
8GHz Highpass Filter	Wainwright	WHKX 7150 8000 18000 50SS	6195	12	15-Jul-2023
Pre Amp 8 - 18 GHz	Wright Technologies	APS06 0061	6199	12	19-Jul-2023
Attenuator 4dB	Pasternack	PE7074-4	6202	24	16-Jul-2024
Cable (SMA to SMA 20cm)	TUV SUD	MH-FH 8-18	6215	12	25-Jul-2023

Table 111

TU - Traceability Unscheduled
 O/P Mon – Output Monitored Using Calibrated Test Equipment



2.5 Authorised Band Edges

2.5.1 Specification Reference

FCC 47 CFR Part 15C, Clause 15.247 (d)
ISED RSS-247, Clause 5.5

2.5.2 Equipment Under Test and Modification State

A2737, S/N: QQRXMCWXL5 - Modification State 0

2.5.3 Date of Test

24-May-2022 to 30-May-2022

2.5.4 Test Method

The test was performed in accordance with ANSI C63.10, clause 6.10.4.

2.5.5 Environmental Conditions

Ambient Temperature	22.0 - 24.6 °C
Relative Humidity	36.1 - 39.4 %



2.5.6 Test Results

2.4 GHz Bluetooth - DTS

ePA - LE1M

Modulation	Packet Type	Core	Tx Frequency (MHz)	Band Edge Frequency (MHz)	Level (dBc)
GFSK	DH1	1	2402	2400.0	-57.79

Table 112 - Authorised Band Edge Results

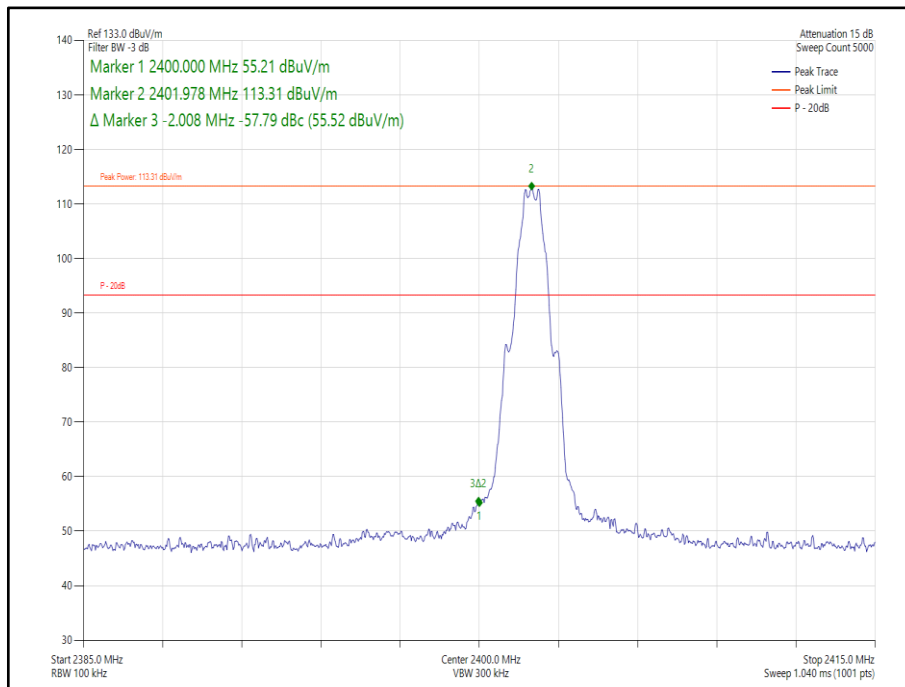

Figure 202 Core 1- GFSK/DH1- Core 1 -2402 MHz – Band Edge Frequency 2400.0 MHz



iPA - LE1M

Modulation	Packet Type	Core	Tx Frequency (MHz)	Band Edge Frequency (MHz)	Level (dBc)
GFSK	DH1	1	2402	2400.0	-55.30

Table 113 - Authorised Band Edge Results

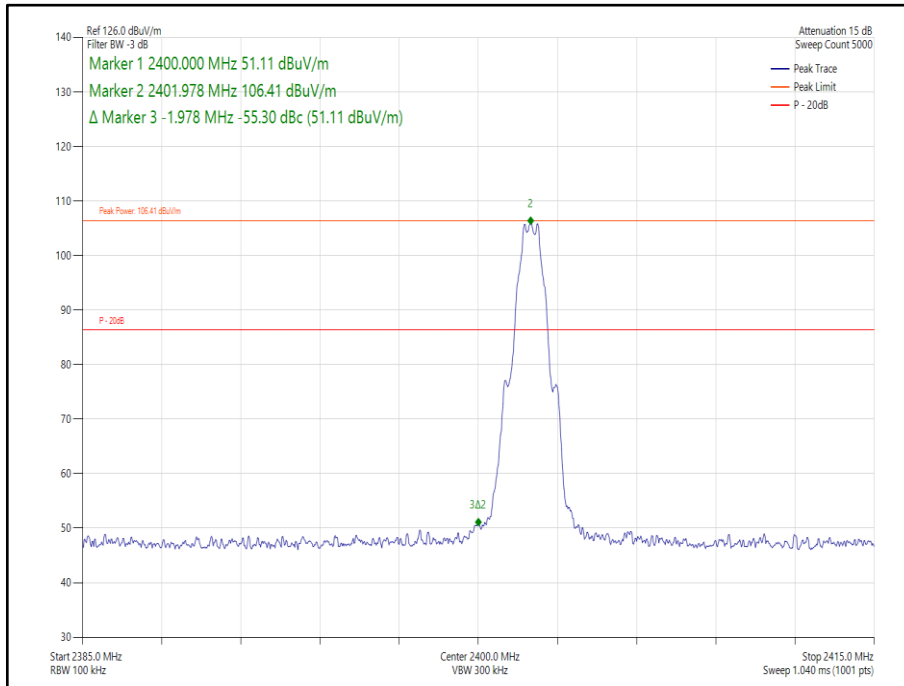

Figure 203 Core 1- GFSK/DH1- Core 1 - 2402 MHz – Band Edge Frequency 2400.0 MHz



iPA - LE1M

Modulation	Packet Type	Core	Tx Frequency (MHz)	Band Edge Frequency (MHz)	Level (dBc)
GFSK	DH1	2	2402	2400.0	-36.31

Table 114 - Authorised Band Edge Results

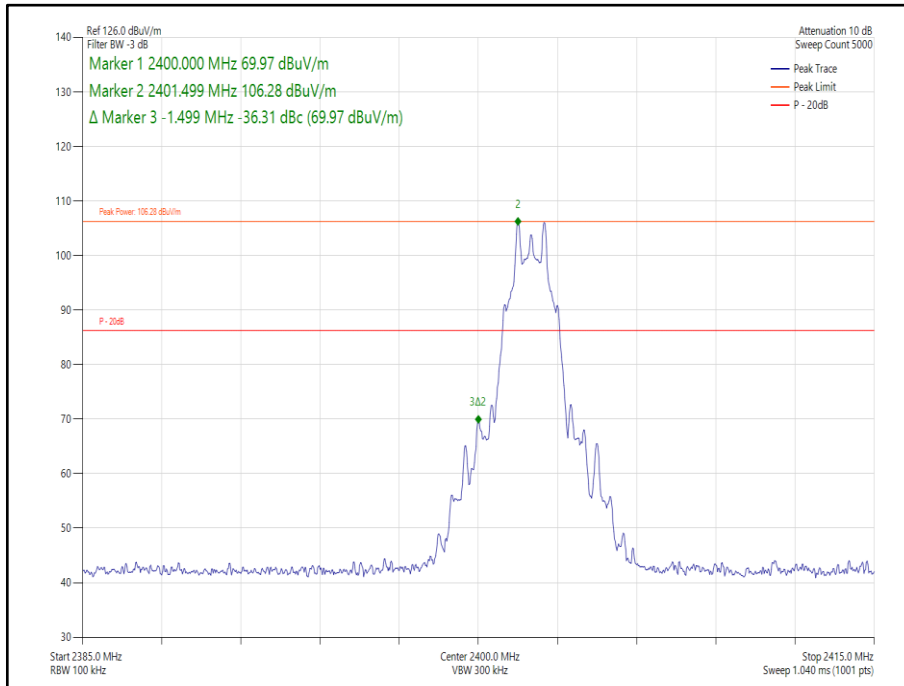

Figure 204 Core 2- GFSK/DH1- 2402 MHz – Band Edge Frequency 2400.0 MHz



ePA - LE1M

Modulation	Packet Type	Core	Tx Frequency (MHz)	Band Edge Frequency (MHz)	Level (dBc)
GFSK	DH1	0-1	2402	2400.0	-62.99

Table 115 - Authorised Band Edge Results

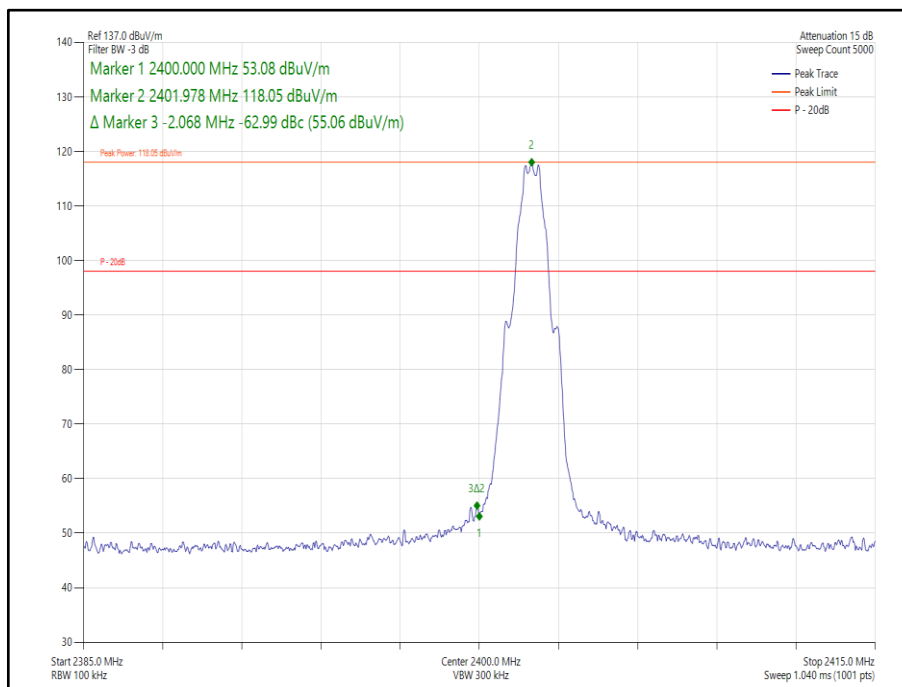

Figure 205 Core 0-1- GFSK/DH1- 2402 MHz – Band Edge Frequency 2400.0 MHz



iPA - LE1M

Modulation	Packet Type	Core	Tx Frequency (MHz)	Band Edge Frequency (MHz)	Level (dBc)
GFSK	DH1	0-1	2402	2400.0	-60.85

Table 116 - Authorised Band Edge Results

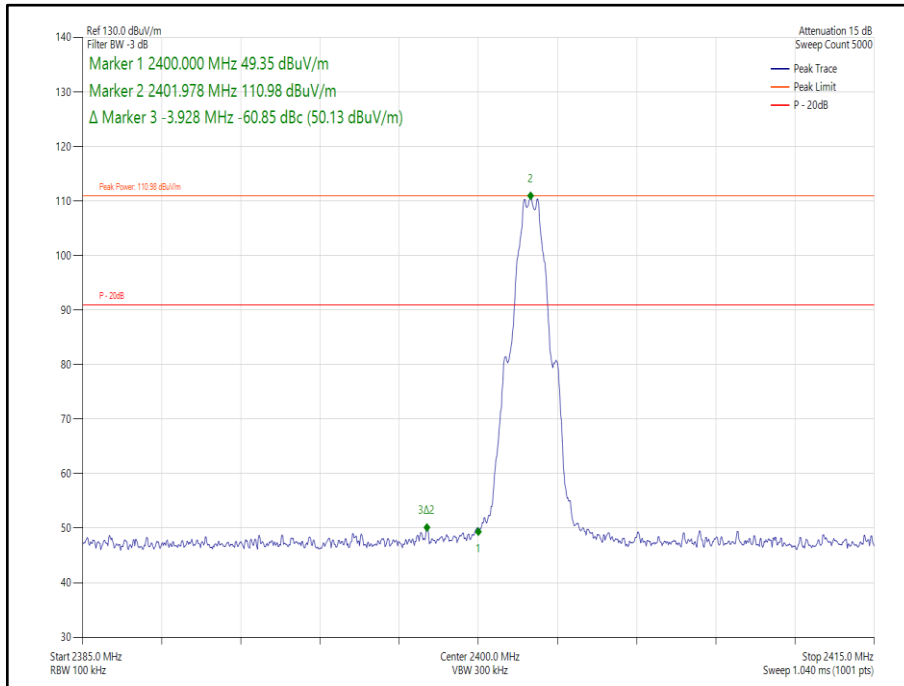

Figure 206 Core 0-1- GFSK/DH1- 2402 MHz – Band Edge Frequency 2400.0 MHz



ePA – LE2M

Modulation	Packet Type	Core	Tx Frequency (MHz)	Band Edge Frequency (MHz)	Level (dBc)
GFSK	DH1	1	2402	2400.0	-49.56

Table 117 - Authorised Band Edge Results

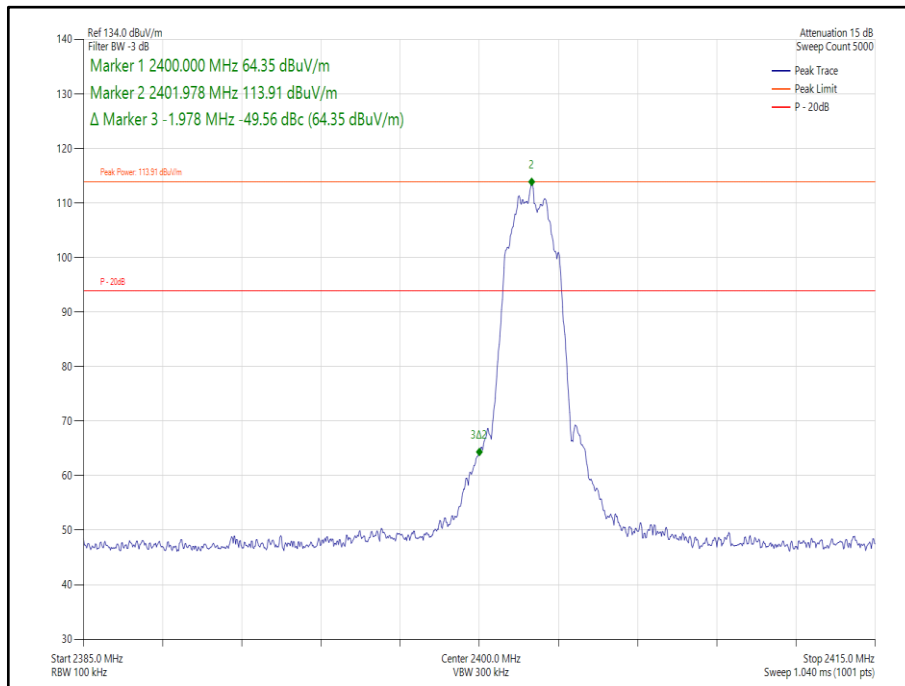

Figure 207 Core 1- GFSK/DH1- 2402 MHz – Band Edge Frequency 2400.0 MHz



iPA – LE2M

Modulation	Packet Type	Core	Tx Frequency (MHz)	Band Edge Frequency (MHz)	Level (dBc)
GFSK	DH1	1	2402	2400.0	-46.72

Table 118 - Authorised Band Edge Results

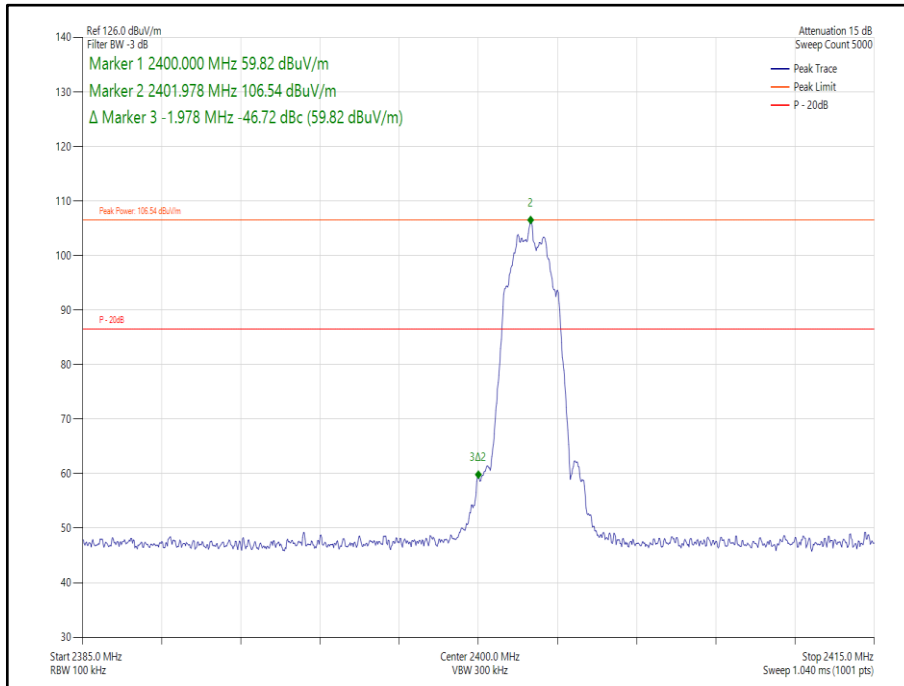

Figure 208 Core 1- GFSK/DH1- 2402 MHz – Band Edge Frequency 2400.0 MHz



iPA – LE2M

Modulation	Packet Type	Core	Tx Frequency (MHz)	Band Edge Frequency (MHz)	Level (dBc)
GFSK	DH1	2	2402	2400.0	-30.21

Table 119 - Authorised Band Edge Results

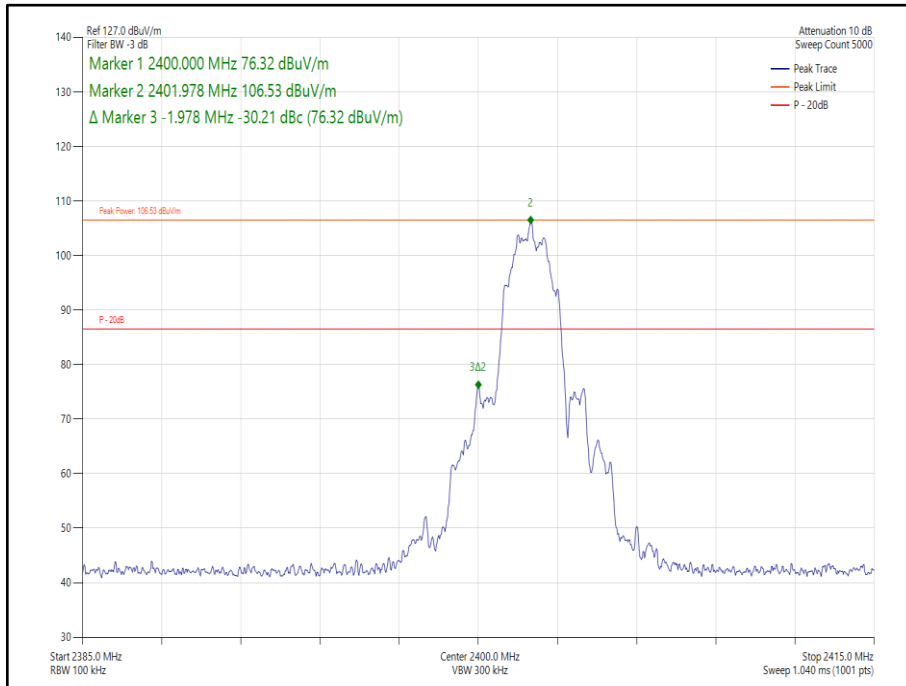

Figure 209 Core 2- GFSK/DH1- 2402 MHz – Band Edge Frequency 2400.0 MHz



ePA – LE2M

Modulation	Packet Type	Core	Tx Frequency (MHz)	Band Edge Frequency (MHz)	Level (dBc)
GFSK	DH1	0-1	2402	2400.0	-50.25

Table 120 - Authorised Band Edge Results

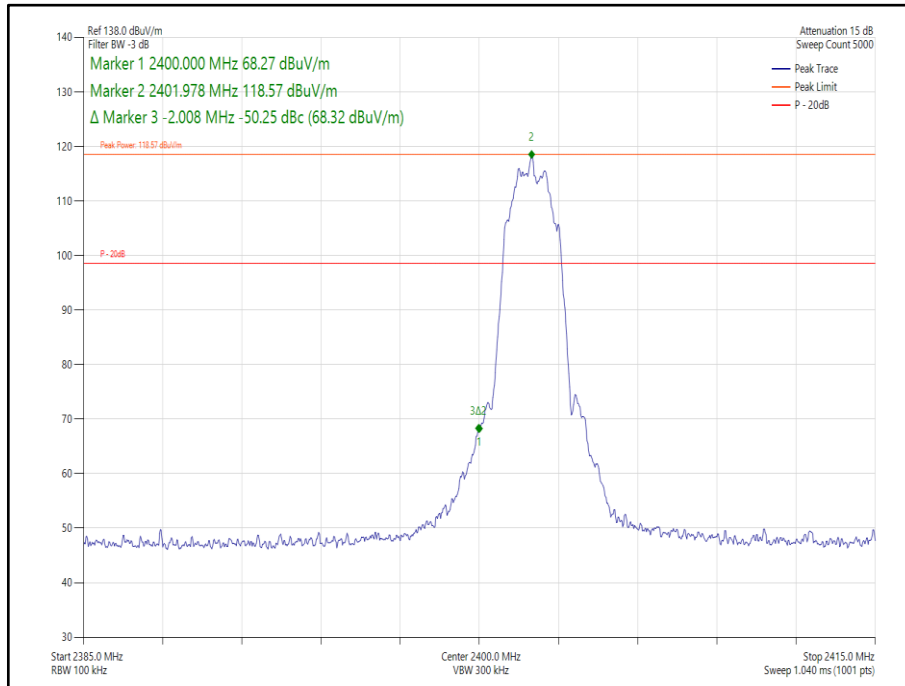

Figure 210 Core 0-1- GFSK/DH1- 2402 MHz – Band Edge Frequency 2400.0 MHz



iPA – LE2M

Modulation	Packet Type	Core	Tx Frequency (MHz)	Band Edge Frequency (MHz)	Level (dBc)
GFSK	DH1	0-1	2402	2400.0	-47.87

Table 121 - Authorised Band Edge Results

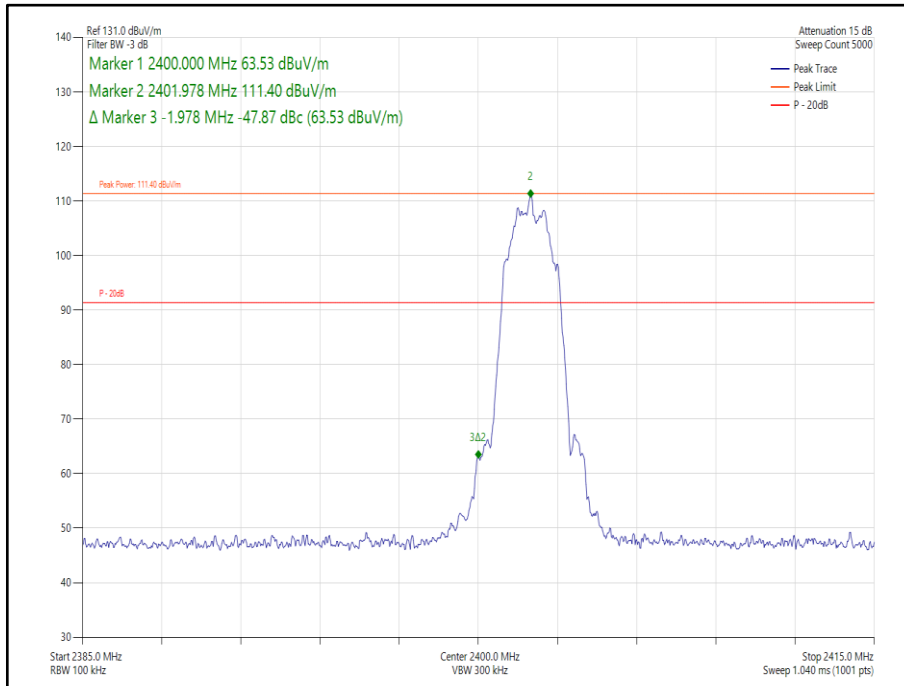

Figure 211 Core 0-1- GFSK/DH1- 2402 MHz – Band Edge Frequency 2400.0 MHz



ePA - HDR4

Modulation	Packet Type	Core	Tx Frequency (MHz)	Band Edge Frequency (MHz)	Level (dBc)
$\pi/4$ DQPSK	HDR4	1	2404	2400.0	-57.18

Table 122 - Authorised Band Edge Results

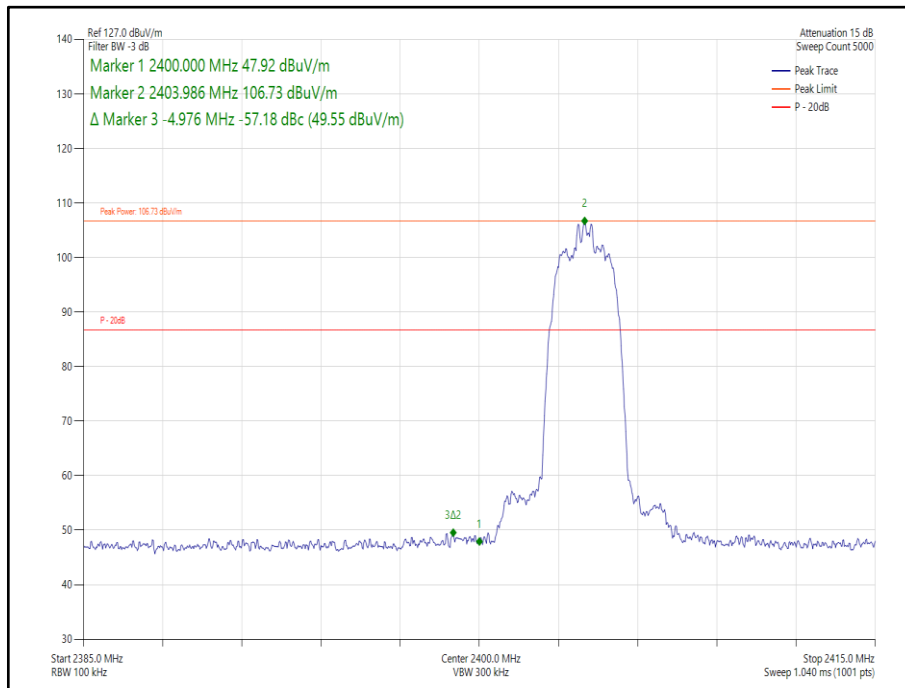

Figure 212 Core 1- GFSK/DH1- 2404 MHz – Band Edge Frequency 2400.0 MHz



iPA - HDR4

Modulation	Packet Type	Core	Tx Frequency (MHz)	Band Edge Frequency (MHz)	Level (dBc)
$\pi/4$ DQPSK	HDR4	1	2404	2400.0	-49.23

Table 123 - Authorised Band Edge Results

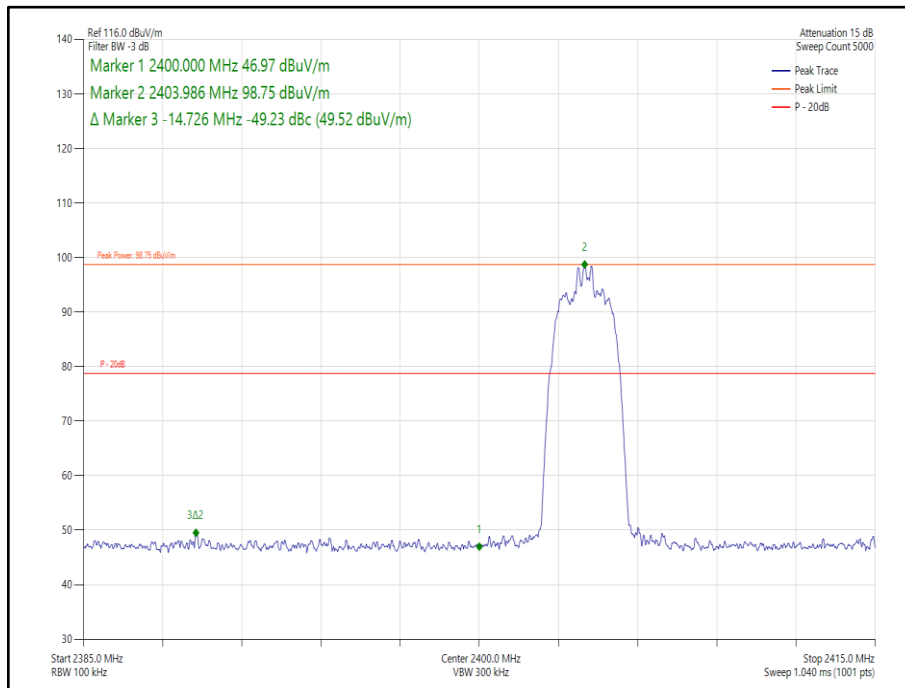

Figure 213 Core 1- GFSK/DH1- 2404 MHz – Band Edge Frequency 2400.0 MHz



iPA - HDR4

Modulation	Packet Type	Core	Tx Frequency (MHz)	Band Edge Frequency (MHz)	Level (dBc)
$\pi/4$ DQPSK	HDR4	2	2404	2400.0	-45.63

Table 124 - Authorised Band Edge Results

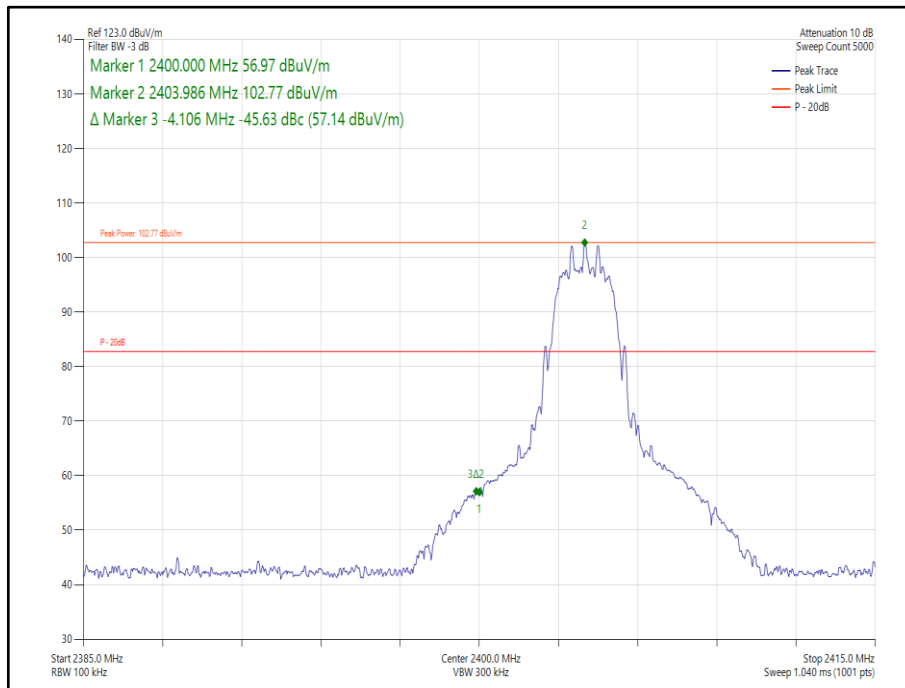

Figure 214 Core 2- GFSK/DH1- 2404 MHz – Band Edge Frequency 2400.0 MHz



ePA - HDR4

Modulation	Packet Type	Core	Tx Frequency (MHz)	Band Edge Frequency (MHz)	Level (dBc)
$\pi/4$ DQPSK	HDR4	0-1	2404	2400.0	-61.81

Table 125 - Authorised Band Edge Results

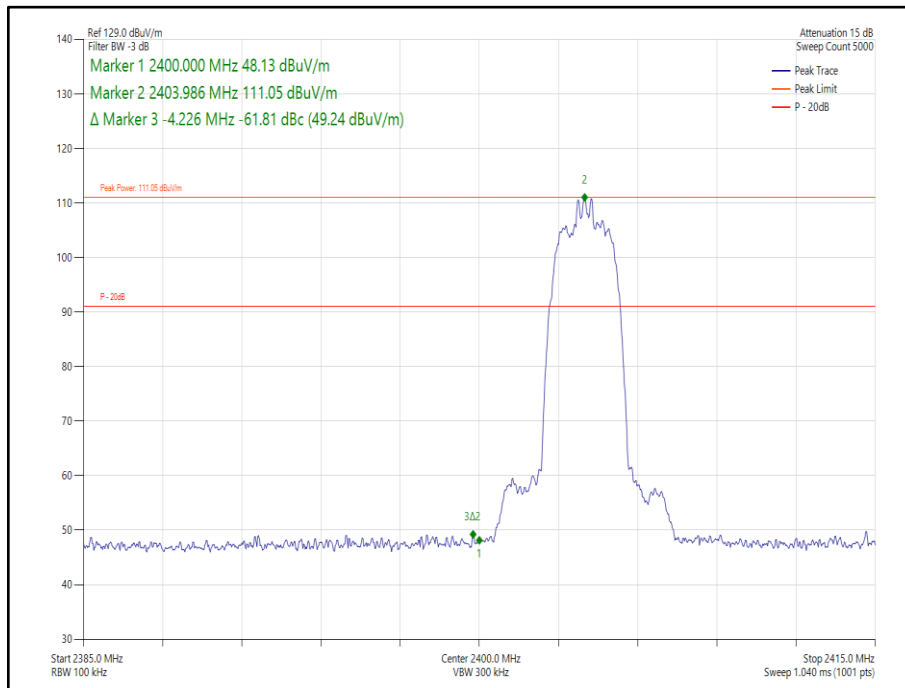

Figure 215 Core 0-1- GFSK/DH1- 2404 MHz – Band Edge Frequency 2400.0 MHz



iPA - HDR4

Modulation	Packet Type	Core	Tx Frequency (MHz)	Band Edge Frequency (MHz)	Level (dBc)
$\pi/4$ DQPSK	HDR4	0-1	2404	2400.0	-55.15

Table 126 - Authorised Band Edge Results

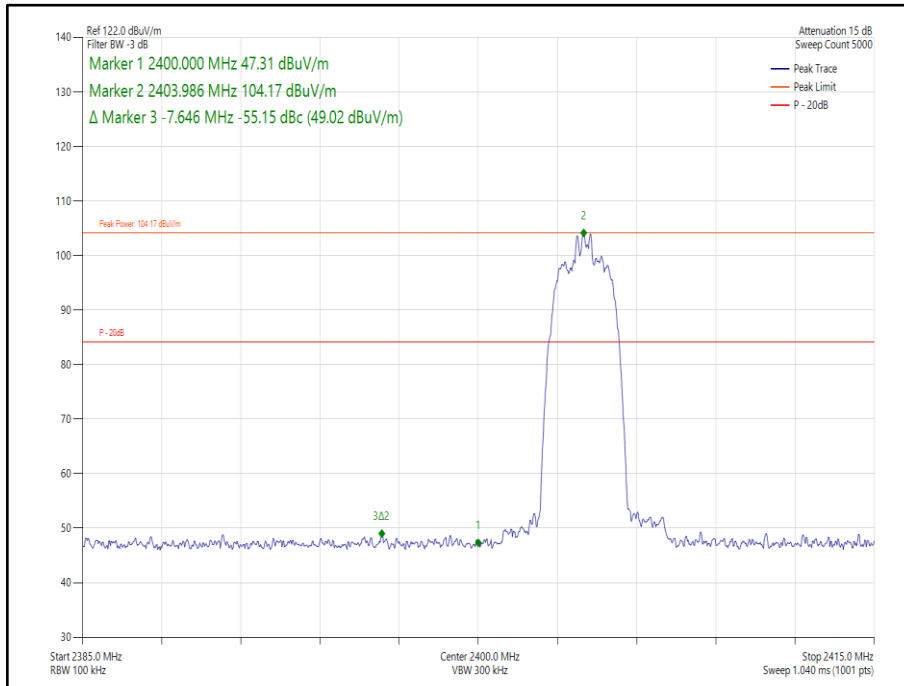

Figure 216 Core 0-1- GFSK/DH1- 2404 MHz – Band Edge Frequency 2400.0 MHz



ePA – HDR8

Modulation	Packet Type	Core	Tx Frequency (MHz)	Band Edge Frequency (MHz)	Level (dBc)
$\pi/4$ DQPSK	HDR8	1	2404	2400.0	-52.48

Table 127 - Authorised Band Edge Results

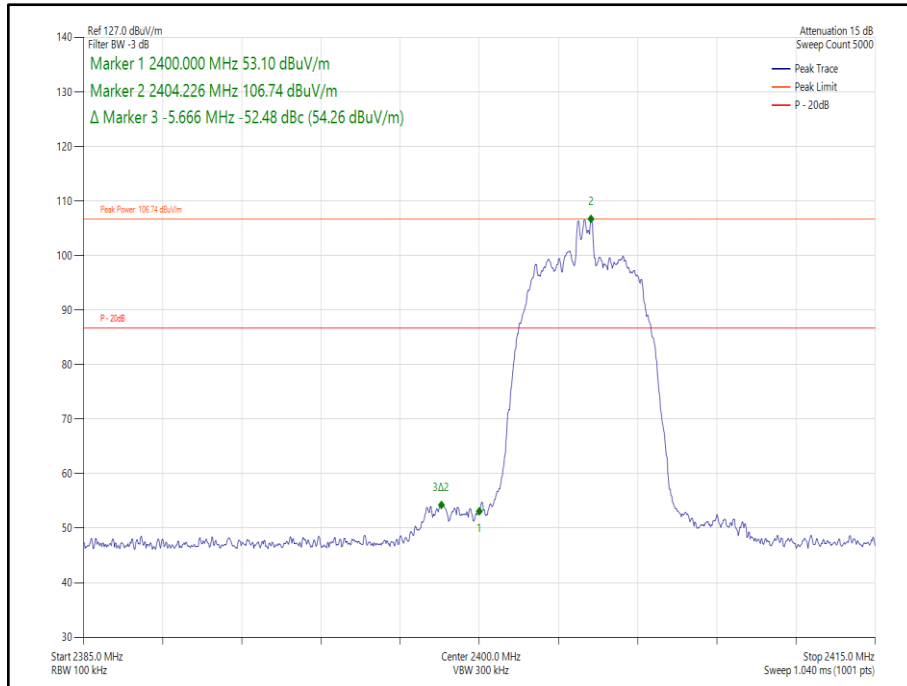

Figure 217 Core 1- GFSK/DH1- 2404 MHz – Band Edge Frequency 2400.0 MHz



iPA – HDR8

Modulation	Packet Type	Core	Tx Frequency (MHz)	Band Edge Frequency (MHz)	Level (dBc)
$\pi/4$ DQPSK	HDR8	1	2404	2400.0	-50.18

Table 128 - Authorised Band Edge Results

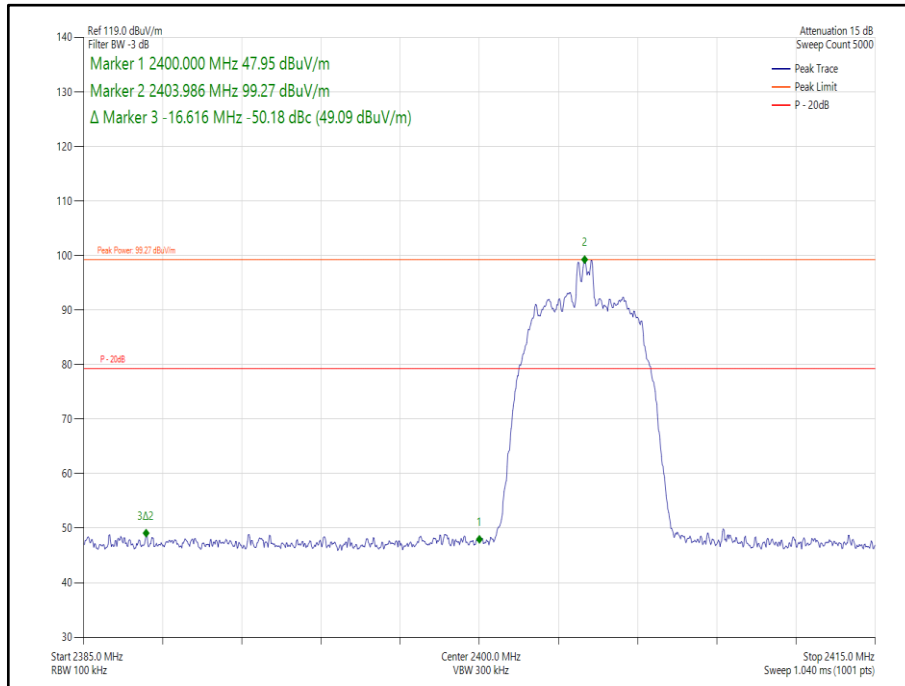

Figure 218 Core 1- GFSK/DH1- 2404 MHz – Band Edge Frequency 2400.0 MHz



iPA – HDR8

Modulation	Packet Type	Core	Tx Frequency (MHz)	Band Edge Frequency (MHz)	Level (dBc)
$\pi/4$ DQPSK	HDR8	2	2404	2400.0	-47.41

Table 129 - Authorised Band Edge Results

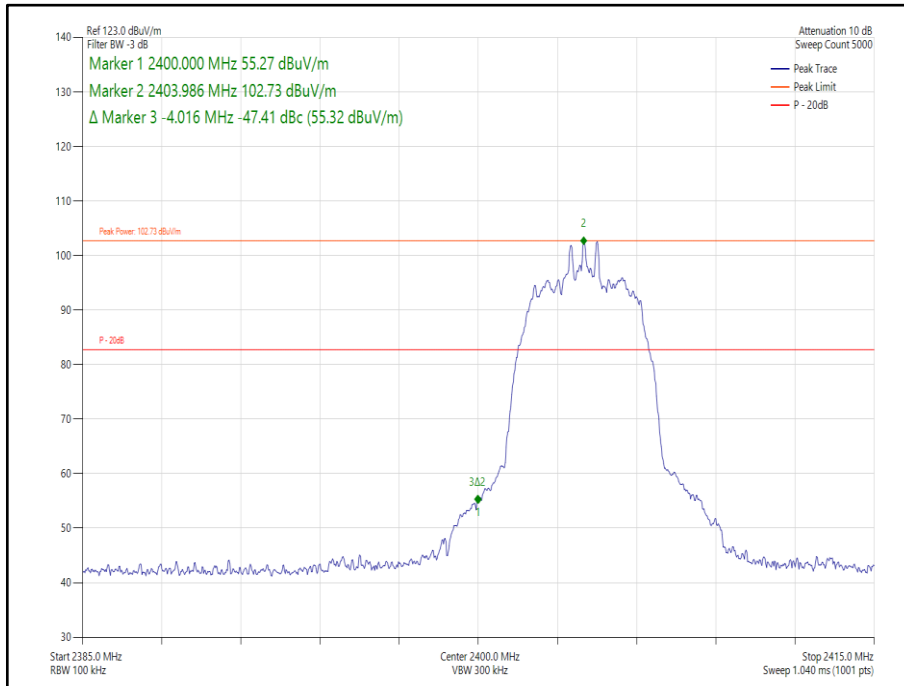

Figure 219 Core 2- GFSK/DH1- 2404 MHz – Band Edge Frequency 2400.0 MHz



ePA – HDR8

Modulation	Packet Type	Core	Tx Frequency (MHz)	Band Edge Frequency (MHz)	Level (dBc)
$\pi/4$ DQPSK	HDR8	0-1	2404	2400.0	-54.85

Table 130 - Authorised Band Edge Results

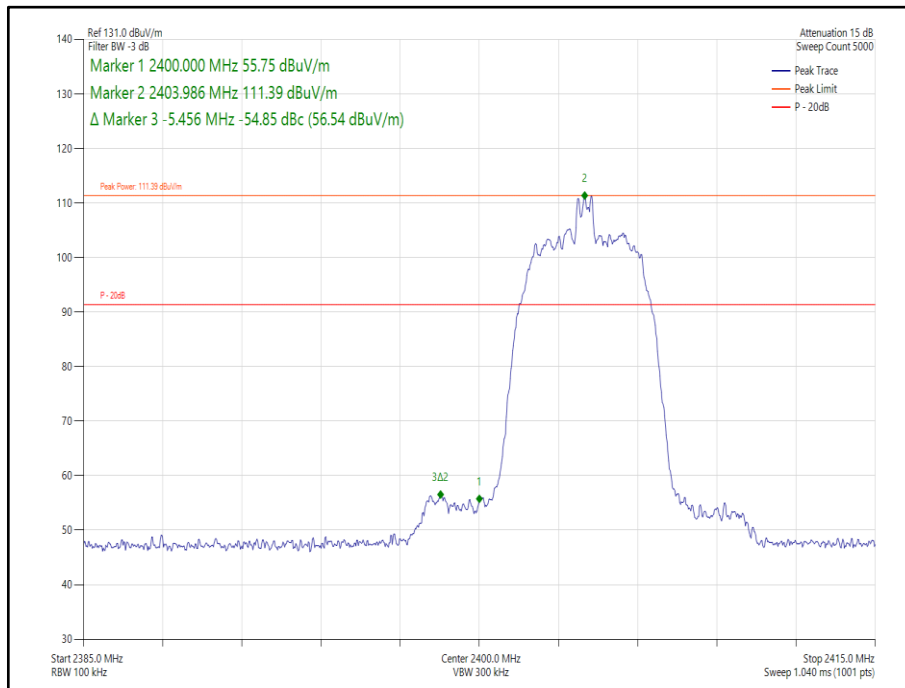

Figure 220 Core 0-1- GFSK/DH1- 2404 MHz – Band Edge Frequency 2400.0 MHz



iPA – HDR8

Modulation	Packet Type	Core	Tx Frequency (MHz)	Band Edge Frequency (MHz)	Level (dBc)
$\pi/4$ DQPSK	HDR8	0-1	2404	2400.0	-53.34

Table 131 - Authorised Band Edge Results

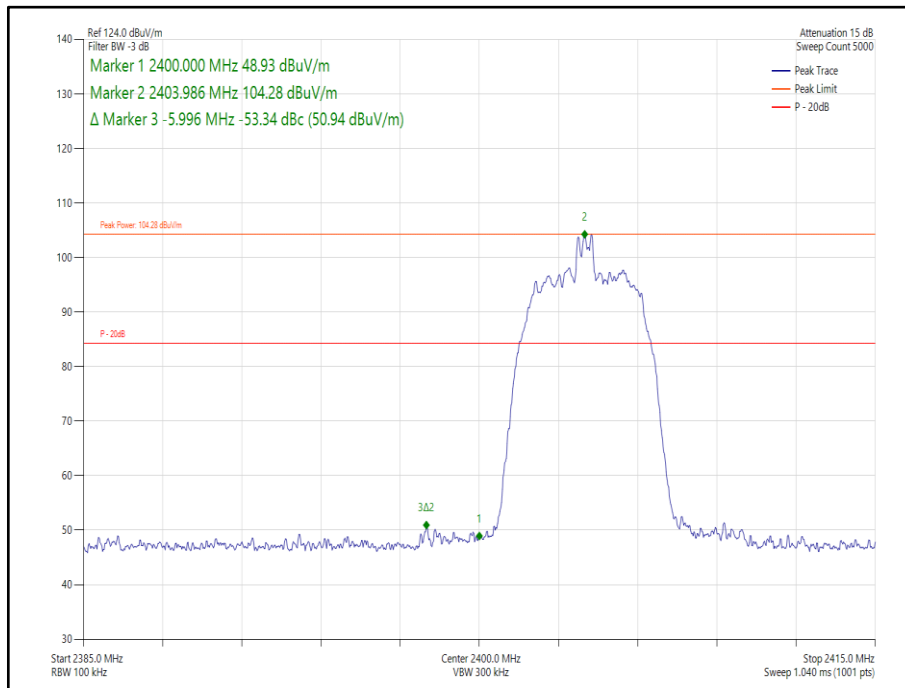

Figure 221 Core 0-1- GFSK/DH1- 2404 MHz – Band Edge Frequency 2400.0 MHz

FCC 47 CFR Part 15, Limit Clause 15.247 (d)

20 dB below the fundamental measured in a 100 kHz bandwidth using a peak detector. If the transmitter complies with the conducted power limits, based on the use of RMS averaging over a time interval, the attenuation required shall be 30 dB below the fundamental instead of 20 dB.

ISED RSS-247, Limit Clause 5.5

In any 100 kHz bandwidth outside the frequency band in which the spread spectrum or digitally modulated device is operating, the RF power that is produced shall be at least 20 dB below that in the 100 kHz bandwidth within the band that contains the highest level of the desired power, based on either an RF conducted or a radiated measurement, provided that the transmitter demonstrates compliance with the peak conducted power limits. If the transmitter complies with the conducted power limits based on the use of root-mean-square averaging over a time interval, as permitted under Section 5.4(4), the attenuation required shall be 30 dB instead of 20 dB. Attenuation below the general field strength limits specified in RSS-Gen is not required.



2.5.7 Test Location and Test Equipment Used

This test was carried out in EMC Chamber 5 and RF Chamber 11.

Instrument	Manufacturer	Type No.	TE No.	Calibration Period (months)	Calibration Expiry Date
Screened Room (5)	Rainford	Rainford	1545	36	15-Apr-2024
Turntable Controller	Inn-Co GmbH	CO 1000	1606	-	TU
Mast Controller	Maturo GmbH	NCD	4810	-	TU
Tilt Antenna Mast	Maturo GmbH	TAM 4.0-P	4811	-	TU
Antenna (DRG 1-10.5GHz)	Schwarzbeck	BBHA9120B	4848	12	28-May-2022
Antenna (DRG 1-10.5GHz)	Schwarzbeck	BBHA9120B	4848	12	28-May-2023
EMI Test Receiver	Rohde & Schwarz	ESW44	5084	12	17-May-2023
Emissions Software	TUV SUD	EmX V3.1.4 V.3.1.4	5125	-	Software
Screened Room (11)	Rainford	Rainford	5136	36	24-Nov-2024
Mast	Maturo	TAM 4.0-P	5158	-	TU
Mast and Turntable Controller	Maturo	Maturo NCD	5159	-	TU
Turntable	Maturo	TT 15WF	5160	-	TU
Antenna (DRG 1-10.5GHz)	Schwarzbeck	BBHA9120B	5215	12	28-May-2022
Antenna (DRG 1-10.5GHz)	Schwarzbeck	BBHA9120B	5215	12	28-May-2023
Cable (SMA to SMA, 2 m)	Junkosha	MWX221-02000AMSAMS/A	5517	12	12-Apr-2023
2m SMA Cable	Junkosha	MWX221-02000AMSAMS/A	5518	12	12-Apr-2023
Cable (N-Type to N-Type, 8 m)	Junkosha	MWX221-08000NMSNMS/B	5520	12	24-Mar-2023
8m N Type Cable	Junkosha	MWX221-08000NMSNMS/B	5522	12	24-Mar-2023
EMI Test Receiver	Rohde & Schwarz	ESW44	5527	12	28-Apr-2023
Thermo-Hygro-Barometer	PCE Instruments	PCE-THB 40	5604	12	22-Sep-2022
Thermo-Hygro-Barometer	PCE Instruments	PCE-THB 40	5605	12	23-Sep-2022

Table 132

TU - Traceability Unscheduled



2.6 Power Spectral Density

2.6.1 Specification Reference

FCC 47 CFR Part 15C, Clause 15.247 (e)
ISED RSS-247, Clause 5.2
ISED RSS-GEN, Clause 6.12

2.6.2 Equipment Under Test and Modification State

A2737, S/N: MW5QG9Q771 - Modification State 0

2.6.3 Date of Test

02-August-2022

2.6.4 Test Method

This test was performed in accordance with ANSI C63.10, clause 11.10.2.

MIMO output port summing was performed in accordance with KDB 662911 D01 E)2)b).

2.6.5 Environmental Conditions

Ambient Temperature	23.1 °C
Relative Humidity	57.1 %



2.6.6 Test Results

2.4 GHz Bluetooth - DTS

Test Configuration			
Frequency Range:	2400-2483.5 MHz	Band:	2.4 GHz
Limit Clause(s):	15.247 (e) RSS-247 5.2 b)	Test Method(s):	C63.10 11.10.2
Additional Reference(s):	-		

DUT Configuration			
Mode:	ePA $\pi/4$ DQPSK (4-DH5)	Duty Cycle (%):	78.4
Antenna Configuration:	SISO	DCCF (dB):	-
Active Port(s):	B (BT Core 1)	Peak Antenna Gain (dBi):	-

Test Frequency (MHz)	RBW (kHz)	PSD (dBm/RBW)					Limit (dBm/3 kHz)	Margin (dB)
		A	B	C	D	Σ		
2404	3.0	-	-4.20	-	-	-	8.00	-12.20
2441	3.0	-	-4.14	-	-	-	8.00	-12.14
2476	3.0	-	-3.92	-	-	-	8.00	-11.92

Table 133 - Maximum Power Spectral Density Results

Test Configuration			
Frequency Range:	2400-2483.5 MHz	Band:	2.4 GHz
Limit Clause(s):	15.247 (e) RSS-247 5.2 b)	Test Method(s):	C63.10 11.10.2
Additional Reference(s):	-		

DUT Configuration			
Mode:	ePA $\pi/4$ DQPSK (8-DH5)	Duty Cycle (%):	78.2
Antenna Configuration:	SISO	DCCF (dB):	-
Active Port(s):	B (BT Core 1)	Peak Antenna Gain (dBi):	-

Test Frequency (MHz)	RBW (kHz)	PSD (dBm/RBW)					Limit (dBm/3 kHz)	Margin (dB)
		A	B	C	D	Σ		
2404	3.0	-	-3.25	-	-	-	8.00	-11.25
2441	3.0	-	-3.34	-	-	-	8.00	-11.34
2476	3.0	-	-3.52	-	-	-	8.00	-11.52

Table 134 - Maximum Power Spectral Density Results



Test Configuration			
Frequency Range:	2400-2483.5 MHz	Band:	2.4 GHz
Limit Clause(s):	15.247 (e) RSS-247 5.2 b)	Test Method(s):	C63.10 11.10.2
Additional Reference(s):	-		

DUT Configuration			
Mode:	ePA GFSK (LE 1M)	Duty Cycle (%):	60.4
Antenna Configuration:	SISO	DCCF (dB):	-
Active Port(s):	B (BT Core 1)	Peak Antenna Gain (dBi):	-

Test Frequency (MHz)	RBW (kHz)	PSD (dBm/RBW)					Limit (dBm/3 kHz)	Margin (dB)
		A	B	C	D	Σ		
2402	3.0	-	-5.92	-	-	-	8.00	-13.92
2440	3.0	-	-6.10	-	-	-	8.00	-14.10
2480	3.0	-	-5.78	-	-	-	8.00	-13.78

Table 135 - Maximum Power Spectral Density Results

Test Configuration			
Frequency Range:	2400-2483.5 MHz	Band:	2.4 GHz
Limit Clause(s):	15.247 (e) RSS-247 5.2 b)	Test Method(s):	C63.10 11.10.2
Additional Reference(s):	-		

DUT Configuration			
Mode:	ePA GFSK (LE 2M)	Duty Cycle (%):	31.3
Antenna Configuration:	SISO	DCCF (dB):	-
Active Port(s):	B (BT Core 1)	Peak Antenna Gain (dBi):	-

Test Frequency (MHz)	RBW (kHz)	PSD (dBm/RBW)					Limit (dBm/3 kHz)	Margin (dB)
		A	B	C	D	Σ		
2402	3.0	-	-8.09	-	-	-	8.00	-16.09
2440	3.0	-	-8.25	-	-	-	8.00	-16.25
2480	3.0	-	-8.37	-	-	-	8.00	-16.37

Table 136 - Maximum Power Spectral Density Results



Test Configuration			
Frequency Range:	2400-2483.5 MHz	Band:	2.4 GHz
Limit Clause(s):	15.247 (e) RSS-247 5.2 b)	Test Method(s):	C63.10 11.10.2
Additional Reference(s):	-		

DUT Configuration			
Mode:	iPA $\pi/4$ DQPSK (4-DH5)	Duty Cycle (%):	78.4
Antenna Configuration:	SISO	DCCF (dB):	-
Active Port(s):	B (BT Core 1)	Peak Antenna Gain (dBi):	-

Test Frequency (MHz)	RBW (kHz)	PSD (dBm/RBW)					Limit (dBm/3 kHz)	Margin (dB)
		A	B	C	D	Σ		
2404	3.0	-	-10.76	-	-	-	8.00	-18.76
2441	3.0	-	-11.14	-	-	-	8.00	-19.14
2476	3.0	-	-10.99	-	-	-	8.00	-18.99

Table 137 - Maximum Power Spectral Density Results

Test Configuration			
Frequency Range:	2400-2483.5 MHz	Band:	2.4 GHz
Limit Clause(s):	15.247 (e) RSS-247 5.2 b)	Test Method(s):	C63.10 11.10.2
Additional Reference(s):	-		

DUT Configuration			
Mode:	iPA $\pi/4$ DQPSK (8-DH5)	Duty Cycle (%):	78.5
Antenna Configuration:	SISO	DCCF (dB):	-
Active Port(s):	B (BT Core 1)	Peak Antenna Gain (dBi):	-

Test Frequency (MHz)	RBW (kHz)	PSD (dBm/RBW)					Limit (dBm/3 kHz)	Margin (dB)
		A	B	C	D	Σ		
2404	3.0	-	-10.19	-	-	-	8.00	-18.19
2441	3.0	-	-10.33	-	-	-	8.00	-18.33
2476	3.0	-	-10.38	-	-	-	8.00	-18.38

Table 138 - Maximum Power Spectral Density Results



Test Configuration			
Frequency Range:	2400-2483.5 MHz	Band:	2.4 GHz
Limit Clause(s):	15.247 (e) RSS-247 5.2 b)	Test Method(s):	C63.10 11.10.2
Additional Reference(s):	-		

DUT Configuration			
Mode:	iPA $\pi/4$ DQPSK (4-DH5)	Duty Cycle (%):	78.4
Antenna Configuration:	SISO	DCCF (dB):	-
Active Port(s):	C (BT Core 2)	Peak Antenna Gain (dBi):	-

Test Frequency (MHz)	RBW (kHz)	PSD (dBm/RBW)					Limit (dBm/3 kHz)	Margin (dB)
		A	B	C	D	Σ		
2404	3.0	-	-	-9.50	-	-	8.00	-17.50
2441	3.0	-	-	-9.43	-	-	8.00	-17.43
2476	3.0	-	-	-9.12	-	-	8.00	-17.12

Table 139 - Maximum Power Spectral Density Results

Test Configuration			
Frequency Range:	2400-2483.5 MHz	Band:	2.4 GHz
Limit Clause(s):	15.247 (e) RSS-247 5.2 b)	Test Method(s):	C63.10 11.10.2
Additional Reference(s):	-		

DUT Configuration			
Mode:	iPA $\pi/4$ DQPSK (8-DH5)	Duty Cycle (%):	78.5
Antenna Configuration:	SISO	DCCF (dB):	-
Active Port(s):	C (BT Core 2)	Peak Antenna Gain (dBi):	-

Test Frequency (MHz)	RBW (kHz)	PSD (dBm/RBW)					Limit (dBm/3 kHz)	Margin (dB)
		A	B	C	D	Σ		
2404	3.0	-	-	-8.97	-	-	8.00	-16.97
2441	3.0	-	-	-8.76	-	-	8.00	-16.76
2476	3.0	-	-	-9.02	-	-	8.00	-17.02

Table 140 - Maximum Power Spectral Density Results



Test Configuration			
Frequency Range:	2400-2483.5 MHz	Band:	2.4 GHz
Limit Clause(s):	15.247 (e) RSS-247 5.2 b)	Test Method(s):	C63.10 11.10.2
Additional Reference(s):	-		

DUT Configuration			
Mode:	iPA GFSK (LE 1M)	Duty Cycle (%):	60.4
Antenna Configuration:	SISO	DCCF (dB):	-
Active Port(s):	B (BT Core 1)	Peak Antenna Gain (dBi):	-

Test Frequency (MHz)	RBW (kHz)	PSD (dBm/RBW)					Limit (dBm/3 kHz)	Margin (dB)
		A	B	C	D	Σ		
2402	3.0	-	-6.05	-	-	-	8.00	-14.05
2440	3.0	-	-6.16	-	-	-	8.00	-14.16
2480	3.0	-	-5.81	-	-	-	8.00	-13.81

Table 141 - Maximum Power Spectral Density Results

Test Configuration			
Frequency Range:	2400-2483.5 MHz	Band:	2.4 GHz
Limit Clause(s):	15.247 (e) RSS-247 5.2 b)	Test Method(s):	C63.10 11.10.2
Additional Reference(s):	-		

DUT Configuration			
Mode:	iPA GFSK (LE 2M)	Duty Cycle (%):	31.3
Antenna Configuration:	SISO	DCCF (dB):	-
Active Port(s):	B (BT Core 1)	Peak Antenna Gain (dBi):	-

Test Frequency (MHz)	RBW (kHz)	PSD (dBm/RBW)					Limit (dBm/3 kHz)	Margin (dB)
		A	B	C	D	Σ		
2402	3.0	-	-8.11	-	-	-	8.00	-16.11
2440	3.0	-	-8.30	-	-	-	8.00	-16.30
2480	3.0	-	-8.37	-	-	-	8.00	-16.37

Table 142 - Maximum Power Spectral Density Results



Test Configuration			
Frequency Range:	2400-2483.5 MHz	Band:	2.4 GHz
Limit Clause(s):	15.247 (e) RSS-247 5.2 b)	Test Method(s):	C63.10 11.10.2
Additional Reference(s):	-		

DUT Configuration			
Mode:	iPA GFSK (LE 1M)	Duty Cycle (%):	60.4
Antenna Configuration:	SISO	DCCF (dB):	-
Active Port(s):	C (BT Core 2)	Peak Antenna Gain (dBi):	-

Test Frequency (MHz)	RBW (kHz)	PSD (dBm/RBW)					Limit (dBm/3 kHz)	Margin (dB)
		A	B	C	D	Σ		
2402	3.0	-	-	-8.47	-	-	8.00	-16.47
2440	3.0	-	-	-8.46	-	-	8.00	-16.46
2480	3.0	-	-	-8.73	-	-	8.00	-16.73

Table 143 - Maximum Power Spectral Density Results

Test Configuration			
Frequency Range:	2400-2483.5 MHz	Band:	2.4 GHz
Limit Clause(s):	15.247 (e) RSS-247 5.2 b)	Test Method(s):	C63.10 11.10.2
Additional Reference(s):	-		

DUT Configuration			
Mode:	iPA GFSK (LE 2M)	Duty Cycle (%):	31.3
Antenna Configuration:	SISO	DCCF (dB):	-
Active Port(s):	C (BT Core 2)	Peak Antenna Gain (dBi):	-

Test Frequency (MHz)	RBW (kHz)	PSD (dBm/RBW)					Limit (dBm/3 kHz)	Margin (dB)
		A	B	C	D	Σ		
2402	3.0	-	-	-11.02	-	-	8.00	-19.02
2440	3.0	-	-	-10.54	-	-	8.00	-18.54
2480	3.0	-	-	-10.82	-	-	8.00	-18.82

Table 144 - Maximum Power Spectral Density Results



Test Configuration			
Frequency Range:	2400-2483.5 MHz	Band:	2.4 GHz
Limit Clause(s):	15.247 (e) RSS-247 5.2 b)	Test Method(s):	C63.10 11.10.2
Additional Reference(s):	662911 D01 v02r01 E)2)b)		

DUT Configuration			
Mode:	ePA $\pi/4$ DQPSK (4-DH5)	Duty Cycle (%):	78.1
Antenna Configuration:	Beamforming	DCCF (dB):	-
Active Port(s):	A+B (BT Core 0 + BT Core 1)	Peak Antenna Gain (dBi):	-

Test Frequency (MHz)	RBW (kHz)	PSD (dBm/RBW)					Limit (dBm/3 kHz)	Margin (dB)
		A	B	C	D	Σ		
2404	3.0	-3.82	-3.95	-	-	-0.87	8.00	-8.87
2441	3.0	-3.85	-3.83	-	-	-0.83	8.00	-8.83
2476	3.0	-3.93	-3.70	-	-	-0.80	8.00	-8.80

Table 145 - Maximum Power Spectral Density Results

Test Configuration			
Frequency Range:	2400-2483.5 MHz	Band:	2.4 GHz
Limit Clause(s):	15.247 (e) RSS-247 5.2 b)	Test Method(s):	C63.10 11.10.2
Additional Reference(s):	662911 D01 v02r01 E)2)b)		

DUT Configuration			
Mode:	ePA $\pi/4$ DQPSK (8-DH5)	Duty Cycle (%):	78.2
Antenna Configuration:	Beamforming	DCCF (dB):	-
Active Port(s):	A+B (BT Core 0 + BT Core 1)	Peak Antenna Gain (dBi):	-

Test Frequency (MHz)	RBW (kHz)	PSD (dBm/RBW)					Limit (dBm/3 kHz)	Margin (dB)
		A	B	C	D	Σ		
2404	3.0	-3.38	-3.37	-	-	-0.37	8.00	-8.37
2441	3.0	-3.49	-3.57	-	-	-0.52	8.00	-8.52
2476	3.0	-3.44	-3.26	-	-	-0.34	8.00	-8.34

Table 146 - Maximum Power Spectral Density Results



Test Configuration			
Frequency Range:	2400-2483.5 MHz	Band:	2.4 GHz
Limit Clause(s):	15.247 (e) RSS-247 5.2 b)	Test Method(s):	C63.10 11.10.2
Additional Reference(s):	662911 D01 v02r01 E)2)b)		

DUT Configuration			
Mode:	iPA $\pi/4$ DQPSK (4-DH5)	Duty Cycle (%):	78.4
Antenna Configuration:	Beamforming	DCCF (dB):	-
Active Port(s):	A+B (BT Core 0 + BT Core 1)	Peak Antenna Gain (dBi):	-

Test Frequency (MHz)	RBW (kHz)	PSD (dBm/RBW)					Limit (dBm/3 kHz)	Margin (dB)
		A	B	C	D	Σ		
2404	3.0	-10.78	-11.17	-	-	-7.96	8.00	-15.96
2441	3.0	-10.85	-11.02	-	-	-7.92	8.00	-15.92
2476	3.0	-11.09	-10.69	-	-	-7.88	8.00	-15.88

Table 147 - Maximum Power Spectral Density Results

Test Configuration			
Frequency Range:	2400-2483.5 MHz	Band:	2.4 GHz
Limit Clause(s):	15.247 (e) RSS-247 5.2 b)	Test Method(s):	C63.10 11.10.2
Additional Reference(s):	662911 D01 v02r01 E)2)b)		

DUT Configuration			
Mode:	iPA $\pi/4$ DQPSK (8-DH5)	Duty Cycle (%):	78.1
Antenna Configuration:	Beamforming	DCCF (dB):	-
Active Port(s):	A+B (BT Core 0 + BT Core 1)	Peak Antenna Gain (dBi):	-

Test Frequency (MHz)	RBW (kHz)	PSD (dBm/RBW)					Limit (dBm/3 kHz)	Margin (dB)
		A	B	C	D	Σ		
2404	3.0	-10.68	-11.11	-	-	-7.88	8.00	-15.88
2441	3.0	-10.25	-10.43	-	-	-7.33	8.00	-15.33
2476	3.0	-10.39	-10.14	-	-	-7.25	8.00	-15.25

Table 148 - Maximum Power Spectral Density Results



FCC 47 CFR Part 15, Limit Clause 15.247 (e)

The power spectral density conducted from the intentional radiator to the antenna shall not be greater than 8 dBm in any 3 kHz band during any time interval of continuous transmission.

ISED RSS-247, Limit Clause 5.2(b)

The transmitter power spectral density conducted from the transmitter to the antenna shall not be greater than 8 dBm in any 3 kHz band during any time interval of continuous transmission

2.6.7 Test Location and Test Equipment Used

This test was carried out in RF Laboratory 1.

Instrument	Manufacturer	Type No	TE No	Calibration Period (months)	Calibration Expires
Multimeter	Fluke	79 Series III	611	12	21-Dec-2022
Hygrometer	Rotronic	I-1000	3220	12	05-Nov-2022
Frequency Standard	Spectracom	SecureSync 1200-0408-0601	4393	6	01-Feb-2023
AC Programmable Power Supply	iTech	IT7324	5225	-	O/P Mon
MXA Signal Analyser	Keysight Technologies	N9020B	5528	24	21-Mar-2024
Signal Conditioning Unit	TUV SUD	SPECTRUM SCU001	5546	12	06-Apr-2023

Table 149

O/P Mon – Output Monitored using calibrated equipment



3 Measurement Uncertainty

For a 95% confidence level, the measurement uncertainties for defined systems are:

Test Name	Measurement Uncertainty
Restricted Band Edges	30 MHz to 1 GHz: ± 5.2 dB 1 GHz to 40 GHz: ± 6.3 dB
Emission Bandwidth	± 144.25 kHz
Maximum Conducted Output Power	± 1.38 dB
Spurious Radiated Emissions	30 MHz to 1 GHz: ± 5.2 dB 1 GHz to 40 GHz: ± 6.3 dB
Authorised Band Edges	30 MHz to 1 GHz: ± 5.2 dB 1 GHz to 40 GHz: ± 6.3 dB
Power Spectral Density	± 1.49 dB

Table 150

Measurement Uncertainty Decision Rule – Accuracy Method

Determination of conformity with the specification limits is based on the decision rule according to IEC Guide 115:2007, Clause 4.4.3 and 4.5.1. (Procedure 2). The measurement results are directly compared with the test limit to determine conformance with the requirements of the standard.

Risk: The uncertainty of measurement about the measured result is negligible with regard to the final pass/fail decision. The measurement result can be directly compared with the test limit to determine conformance with the requirement (compare IEC Guide 115). The level of risk to falsely accept and falsely reject items is further described in ILAC-G8.