

FCC and ISED Test Report

Apple Inc, Model: A2615

In accordance with FCC 47 CFR Part 15B,
ICES-003 and ISED RSS-GEN (ITE)

Prepared for: Apple Inc, One Apple Park Way, Cupertino,
California, 95014, USA

FCC ID: BCGA2615

IC: 579C-A2615

COMMERCIAL-IN-CONFIDENCE

Document 75952325-08 Issue 01



Add value.
Inspire trust.

SIGNATURE

NAME	JOB TITLE	RESPONSIBLE FOR	ISSUE DATE
Andy Lawson	Chief Engineer, EMC	Authorised Signatory	27 January 2022

Signatures in this approval box have checked this document in line with the requirements of TÜV SÜD document control rules.

ENGINEERING STATEMENT

The measurements shown in this report were made in accordance with the procedures described on test pages. All reported testing was carried out on a sample equipment to demonstrate limited compliance with FCC 47 CFR Part 15B, ICES-003 and ISED RSS-GEN. The sample tested was found to comply with the requirements defined in the applied rules.

RESPONSIBLE FOR	NAME	DATE	SIGNATURE
Testing	Connor Lee	27 January 2022	
Testing	Faisal Malyar	27 January 2022	
Testing	Taha Shafique	27 January 2022	
Testing	Danial Shafique	27 January 2022	
Testing	Jaiyanth Balendrarajah	27 January 2022	

FCC Accreditation

90987 Octagon House, Fareham Test Laboratory

ISED Accreditation

12669A Octagon House, Fareham Test Laboratory

EXECUTIVE SUMMARY

A sample of this product was tested and found to be compliant with FCC 47 CFR Part 15B: 2020, ICES-003: Issue 7: 2020 and ISED RSS-GEN: Issue 5 and A1 (2019-03) for the tests detailed in section 1.3.



DISCLAIMER AND COPYRIGHT

This non-binding report has been prepared by TÜV SÜD with all reasonable skill and care. The document is confidential to the potential Client and TÜV SÜD. No part of this document may be reproduced without the prior written approval of TÜV SÜD. © 2022 TÜV SÜD. This report relates only to the actual item/items tested.

ACCREDITATION

Our UKAS Accreditation does not cover opinions and interpretations and any expressed are outside the scope of our UKAS Accreditation. Results of tests not covered by our UKAS Accreditation Schedule are marked NUA (Not UKAS Accredited).

TÜV SÜD
is a trading name of TÜV SÜD Ltd
Registered in Scotland at East Kilbride,
Glasgow G75 0QF, United Kingdom
Registered number: SC215164

TÜV SÜD Ltd is a
TÜV SÜD Group Company

Phone: +44 (0) 1489 558100
Fax: +44 (0) 1489 558101
www.tuvsud.com/en

TÜV SÜD
Octagon House
Concorde Way
Fareham
Hampshire PO15 5RL
United Kingdom



Contents

1	Report Summary	2
1.1	Report Modification Record.....	2
1.2	Introduction.....	2
1.3	Brief Summary of Results	3
1.4	Product Information	4
1.5	Deviations from the Standard.....	4
1.6	EUT Modification Record	5
1.7	Test Location	5
2	Test Details	6
2.1	Conducted Disturbance at Mains Terminals	6
2.2	Radiated Disturbance.....	11
3	Incident Reports	18
4	Measurement Uncertainty	19



1 Report Summary

1.1 Report Modification Record

Alterations and additions to this report will be issued to the holders of each copy in the form of a complete document.

Issue	Description of Change	Date of Issue
1	First Issue	27 January 2022

Table 1

1.2 Introduction

Applicant	Apple Inc
Manufacturer	Apple Inc
Model Number(s)	A2615
Serial Number(s)	P1F4F29DL4 and F7F93XV4L7
Hardware Version(s)	REV1.0
Software Version(s)	21B30220I and 21D20
Number of Samples Tested	2
Test Specification/Issue/Date	FCC 47 CFR Part 15B: 2020 ICES-003: Issue 7: 2020 ISED RSS-GEN: Issue 5 and A1 (2019-03)
Order Number	0540220896
Date	25-May-2021
Date of Receipt of EUT	11- October -2021
Start of Test	11-October-2021
Finish of Test	10-December-2021
Name of Engineer(s)	Connor Lee, Faisal Malyar, Taha Shafique, Danial Shafique and Jaiyanth Balendrarajah
Related Document(s)	ANSI C63.4: 2014



1.3 Brief Summary of Results

A brief summary of the tests carried out in accordance with FCC 47 CFR Part 15B, ICES-003 and ISED RSS-GEN is shown below.

Section	Specification Clause			Test Description	Result	Comments/Base Standard
	Part 15B	ICES-003	RSS-GEN			
Configuration and Mode: 115 V AC Powered - Transmitters Idle						
2.1	15.107	3.1	8.8	Conducted Disturbance at Mains Terminals	Pass	ANSI C63.4: 2014
2.2	15.109	3.2	7.1	Radiated Disturbance	Pass	ANSI C63.4: 2014

Table 2



1.4 Product Information

1.4.1 Technical Description

The Equipment under test (EUT) was a desktop computer with Bluetooth, Bluetooth Low Energy and 802.11 a/b/g/n/ac/ax capabilities in the 2.4 GHz and 5 GHz bands.

1.4.2 EUT Port/Cable Identification

Port	Max Cable Length specified	Usage	Type	Screened
Configuration and Mode: 115 V AC Powered - Transmitters Idle				
AC Power Live.	2 Meters	Power	115 V AC Mains Power	No
AC Power Neutral.	2 Meters	Power	115 V AC Mains Power	No

Table 3

1.4.3 Test Configuration

Configuration	Description
115 V AC Powered	The EUT was powered from a 115 V 60 Hz AC power supply. A set of headphones was used to terminate the EUT's 3.5 mm audio jack port. A type -c to USB adapter with a mouse was used to terminate the type -c port. A keyboard was used to terminate the USB port. A switchbox was used to terminate the ethernet port. A monitor was used to terminate the HDMI port.

Table 4

1.4.4 Modes of Operation

Mode	Description
Transmitters Idle	The EUT's intentional transmitters were turned OFF from the internal settings of the EUT. During radiated emissions tests, the EUT was additionally configured to display video on the EUT screen, whilst playing audio through the headphones. The display was set to maximum brightness and sleep mode was disabled. A ping request was also established with the EUT using a support laptop.

Table 5

1.5 Deviations from the Standard

No deviations from the applicable test standard were made during testing.



1.6 EUT Modification Record

The table below details modifications made to the EUT during the test programme.

The modifications incorporated during each test are recorded on the appropriate test pages.

Modification State	Description of Modification still fitted to EUT	Modification Fitted By	Date Modification Fitted
Model: A2615, Serial Number: P1F4F29DL4			
0	As supplied by the customer	Not Applicable	Not Applicable
Model: A2615, Serial Number: F7F93XV4L7			
0	As supplied by the customer	Not Applicable	Not Applicable

Table 6

1.7 Test Location

TÜV SÜD conducted the following tests at our Fareham Test Laboratory.

Test Name	Name of Engineer(s)	Accreditation
Configuration and Mode: 115 V AC Powered - Transmitters Idle		
Conducted Disturbance at Mains Terminals	Connor Lee	UKAS
Radiated Disturbance	Faisal Malyar, Taha Shafique, Danial Shafique and Jaiyanth Balendrarajah	UKAS

Table 7

Office Address:

TÜV SÜD
Octagon House
Concorde Way
Fareham
Hampshire
PO15 5RL
United Kingdom



2 Test Details

2.1 Conducted Disturbance at Mains Terminals

2.1.1 Specification Reference

FCC 47 CFR Part 15B, Clause 15.107
ICES-003, Clause 3.1
ISED RSS-GEN, Clause 8.8

2.1.2 Equipment Under Test and Modification State

A2615, S/N: F7F93XV4L7 - Modification State 0

2.1.3 Date of Test

10-December-2021

2.1.4 Test Method

The EUT was setup according to ANSI C63.4, clause 5.2.

The EUT was placed on a non-conductive table 0.8 m above a reference ground plane. A vertical coupling plane was placed 0.4 m from the EUT boundary.

A Line Impedance Stabilisation Network (LISN) was directly bonded to the ground-plane. The EUT was located so that the distance between the boundary of the EUT and the closest surface of the LISN was 0.8 m.

Interconnecting cables that hanged closer than 0.4 m to the ground plane were folded back and forth in the centre forming a bundle 0.3 m to 0.4 m long.

Input and output cables were terminated with equipment or loads representative of real usage conditions.

The EUT was configured to give the highest level of emissions within reason of a typical installation as described by the manufacturer.

2.1.5 Example Calculation

Quasi-Peak level (dB μ V) = Receiver level (dB μ V) + Correction Factor (dB)
Margin (dB) = Quasi-Peak level (dB μ V) - Limit (dB μ V)

CISPR Average level (dB μ V) = Receiver level (dB μ V) + Correction Factor (dB)
Margin (dB) = CISPR Average level (dB μ V) - Limit (dB μ V)

2.1.6 Example Test Setup Diagram

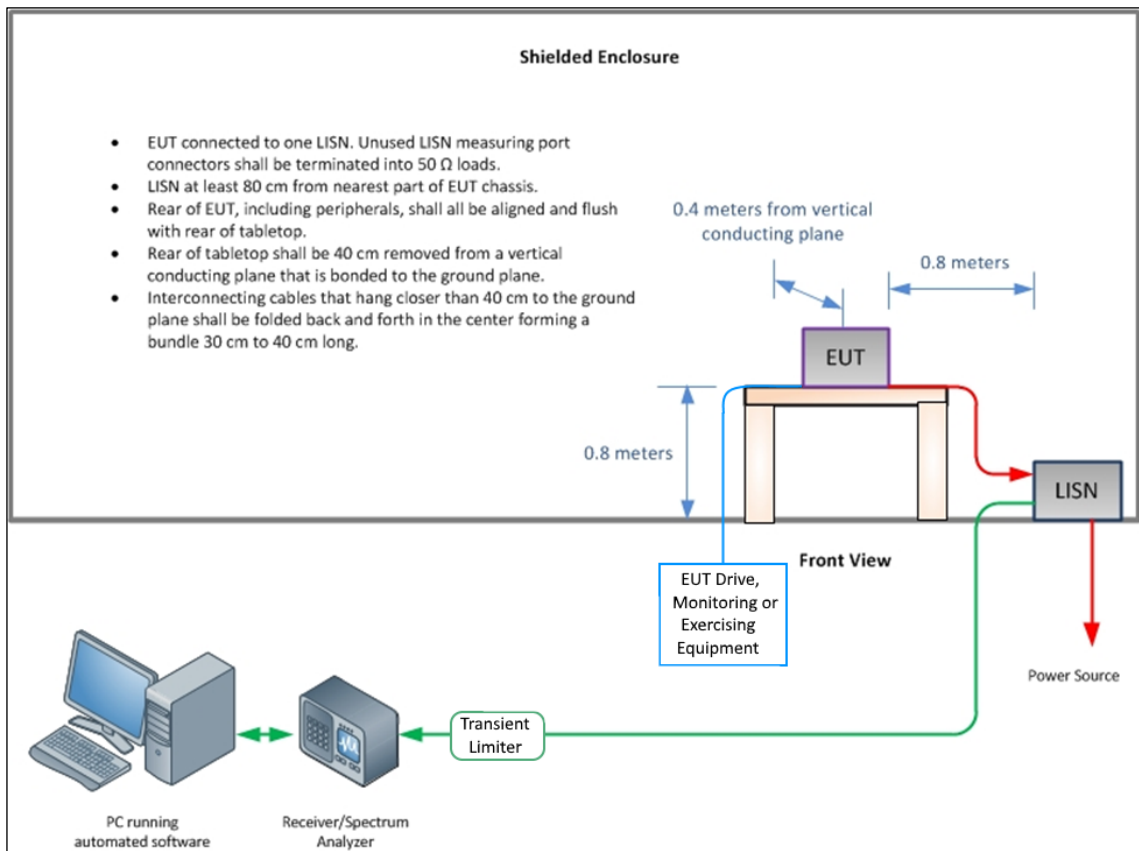

Figure 1 - Conducted Disturbance

2.1.7 Environmental Conditions

Ambient Temperature 20.3 °C
 Relative Humidity 32.6 %

2.1.8 Specification Limits

Required Specification Limits - Class B			
Line Under Test	Frequency Range (MHz)	Quasi-Peak Test Limit (dBμV)	CISPR Average Test Limit (dBμV)
AC Power Port	0.15 to 0.5	66 to 56 ⁽¹⁾	56 to 46 ⁽¹⁾
	0.5 to 5	56	46
	5 to 30	60	50

Supplementary information:
 Note 1. Decreases with the logarithm of the frequency.

Table 8



2.1.9 Test Results

Results for Configuration and Mode: 115 V AC Powered - Transmitters Idle.

This test was performed to the requirements of the Class B limits.

Performance assessment of the EUT made during this test: Pass.

Detailed results are shown below.

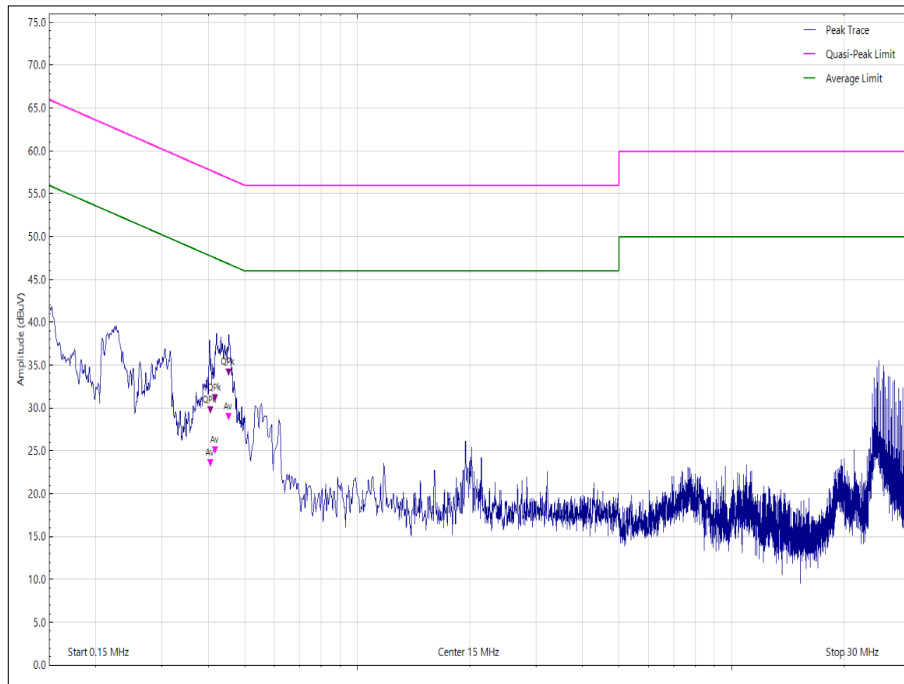

Figure 2 - Graphical Results - AC Power Live.

Frequency (MHz)	Level (dBuV)	Limit (dBuV)	Margin (dB)	Detector
0.405	29.1	57.7	-28.6	Q-Peak
0.405	23.0	47.7	-24.7	CISPR Avg
0.417	30.6	57.5	-26.9	Q-Peak
0.417	24.5	47.5	-23.0	CISPR Avg
0.452	33.6	56.8	-23.3	Q-Peak
0.452	28.3	46.8	-18.5	CISPR Avg

Table 9

No other final measurements were made as all other peak emissions seen above the measurement system noise floor during the pre-scan were greater than 6 dB below the CISPR Average test limit.

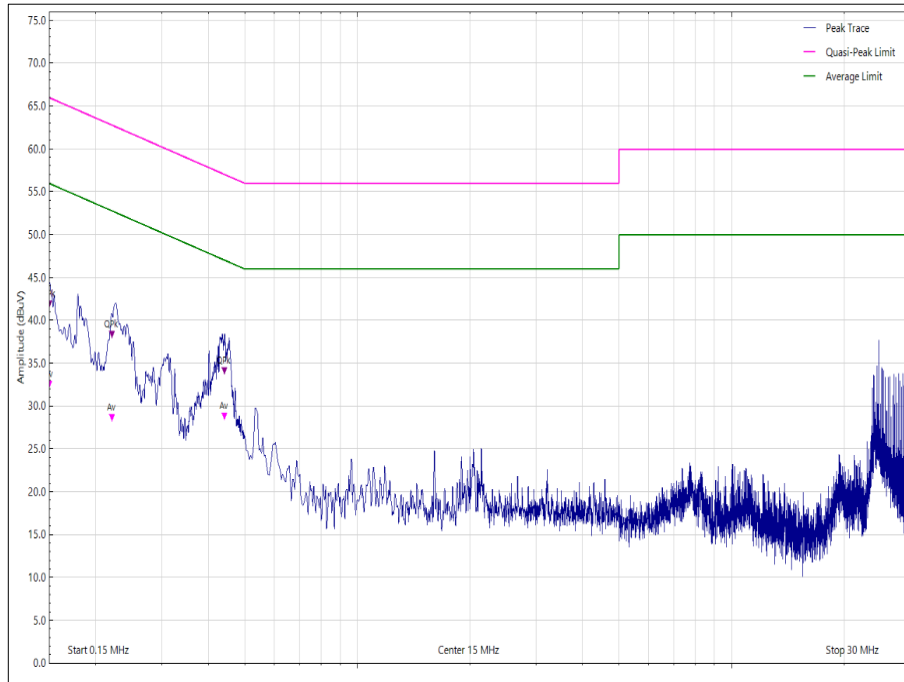

Figure 3 - Graphical Results - AC Power Neutral.

Frequency (MHz)	Level (dBuV)	Limit (dBuV)	Margin (dB)	Detector
0.150	41.3	66.0	-24.7	Q-Peak
0.150	31.9	56.0	-24.1	CISPR Avg
0.221	37.7	62.8	-25.1	Q-Peak
0.221	28.0	52.8	-24.8	CISPR Avg
0.441	33.5	57.1	-23.6	Q-Peak
0.441	28.2	47.1	-18.9	CISPR Avg

Table 10

No other final measurements were made as all other peak emissions seen above the measurement system noise floor during the pre-scan were greater than 6 dB below the CISPR Average test limit.



2.1.10 Test Location and Test Equipment Used

This test was carried out in EMC Chamber 12.

Instrument	Manufacturer	Type No	TE No	Calibration Period (months)	Calibration Expires
Screened Room (12)	MVG	EMC-3	5621	36	11-Aug-2023
Emissions Software	TUV SUD	EmX V2.1.11	5125	-	Software
Test Receiver	Rohde & Schwarz	ESU40	3506	12	18-Mar-2022
Transient Limiter	Hewlett Packard	11947A	2377	12	01-Mar-2022
Cable (K-Type to K-Type, 2 m)	Scott Cables	KPS-1501-2000-KPS	4526	6	06-Mar-2022
Cable (N-Type to N-Type, 8 m)	Teledyne	PR90-088-8MTR	5450	6	08-Mar-2022
LISN	Rohde & Schwarz	ESH3-Z5	1390	12	28-Jan-2022

Table 11



2.2 Radiated Disturbance

2.2.1 Specification Reference

FCC 47 CFR Part 15B, Clause 15.109
ICES-003, Clause 3.2
ISED RSS-GEN, Clause 7.1

2.2.2 Equipment Under Test and Modification State

A2615, S/N: P1F4F29DL4 - Modification State 0

2.2.3 Date of Test

11-October-2021 to 23-November-2021

2.2.4 Test Method

The EUT was set up on a non-conductive table 0.8 m above a reference ground plane.

within a semi-anechoic chamber on a remotely controlled turntable.

A pre-scan of the EUT emissions profile using a peak detector was made at a 3 m antenna distance whilst varying the antenna-to-EUT azimuth and polarisation.

For an EUT which could reasonable be used in multiple planes, pre-scans were performed with the EUT orientated in X, Y and Z planes with reference to the ground plane.

Using a list of the highest emissions detected during the pre-scan along with their bearing and associated antenna polarisation, the EUT was then formally measured using a Quasi-Peak, Peak or CISPR Average detector as appropriate.

The readings were maximised by adjusting the antenna height, polarisation and turntable azimuth, in accordance with the specification.

2.2.5 Example Calculation

Below 1 GHz:

$$\begin{aligned} \text{Quasi-Peak level (dB}\mu\text{V/m)} &= \text{Receiver level (dB}\mu\text{V)} + \text{Correction Factor (dB/m)} \\ \text{Margin (dB)} &= \text{Quasi-Peak level (dB}\mu\text{V/m)} - \text{Limit (dB}\mu\text{V/m)} \end{aligned}$$

Above 1 GHz:

$$\begin{aligned} \text{CISPR Average level (dB}\mu\text{V/m)} &= \text{Receiver level (dB}\mu\text{V)} + \text{Correction Factor (dB/m)} \\ \text{Margin (dB)} &= \text{CISPR Average level (dB}\mu\text{V/m)} - \text{Limit (dB}\mu\text{V/m)} \end{aligned}$$

$$\begin{aligned} \text{Peak level (dB}\mu\text{V/m)} &= \text{Receiver level (dB}\mu\text{V)} + \text{Correction Factor (dB/m)} \\ \text{Margin (dB)} &= \text{Peak level (dB}\mu\text{V/m)} - \text{Limit (dB}\mu\text{V/m)} \end{aligned}$$

2.2.6 Example Test Setup Diagram

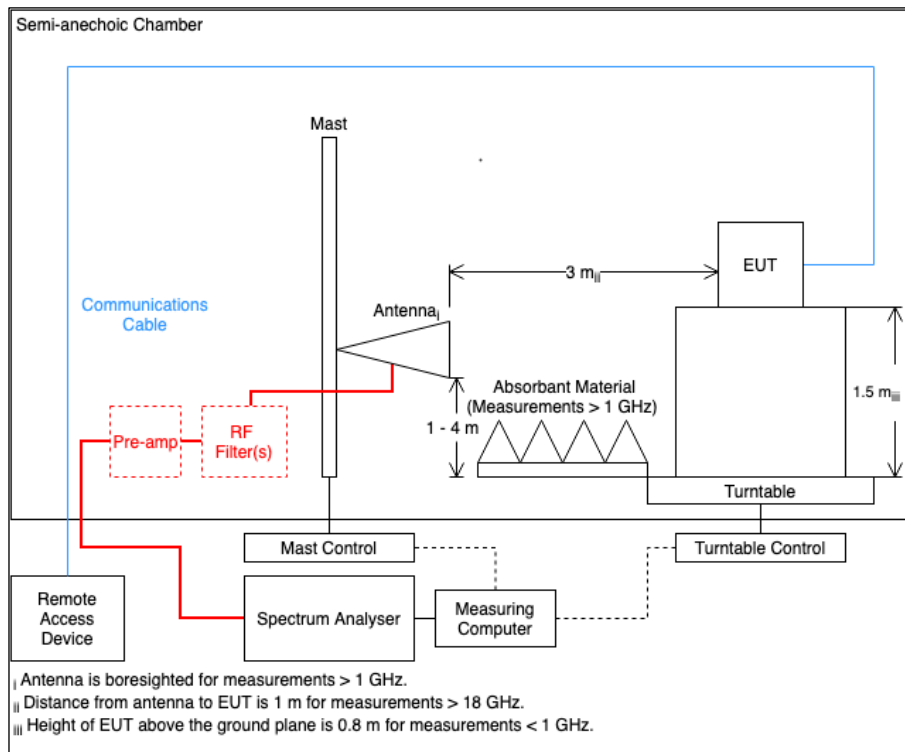

Figure 4

2.2.7 Environmental Conditions

Ambient Temperature 20.4 - 22.6 °C
 Relative Humidity 28.0 - 50.3 %

2.2.8 Specification Limits

Required Specification Limits, Field Strength - Class B Test Limit at a 3 m Measurement Distance		
Frequency Range (MHz)	Test Limit (µV/m)	Test Limit (dBµV/m)
30 to 88	100	40.0
88 to 216	150	43.5
216 to 960	200	46.0
Above 960	500	54.0

Supplementary information:
 Note 1. A Quasi-peak detector is to be used for measurements below 1 GHz.
 Note 2. A CISPR Average detector is to be used for measurements above 1 GHz.
 Note 3. The Peak test limit above 1 GHz is 20 dB higher than the CISPR Average test limit.

Table 12



2.2.9 Test Results

Results for Configuration and Mode: 115 V AC Powered - Transmitters Idle.

This test was performed to the requirements of the Class B limits.

Performance assessment of the EUT made during this test: Pass.

Detailed results are shown below.

Highest frequency generated or used within the EUT: 5825 MHz
 Which necessitates an upper frequency test limit of: 30 GHz

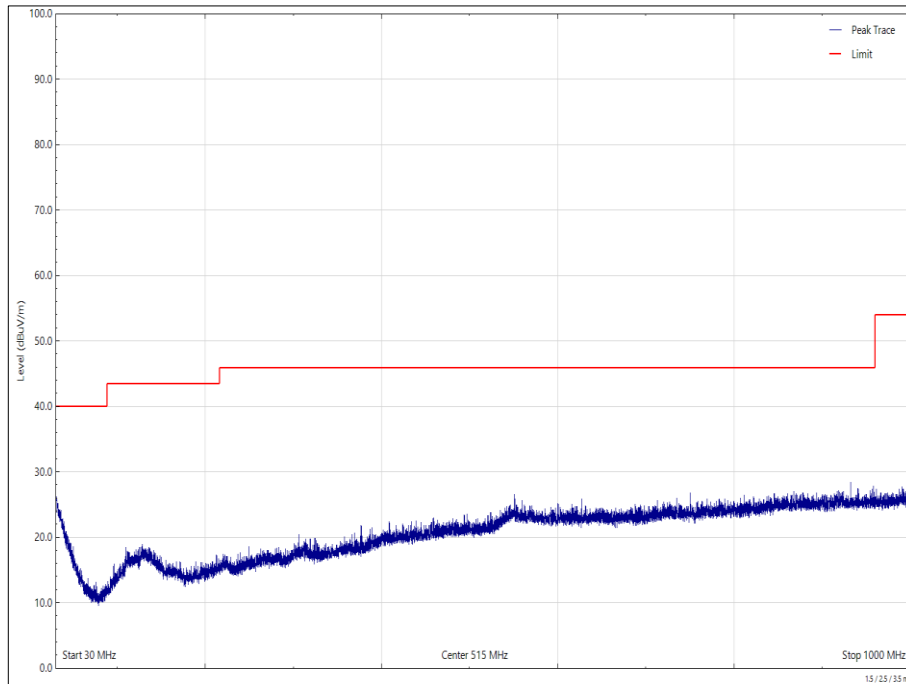

Figure 5 - 30 MHz to 1 GHz, Quasi-Peak, Horizontal

Frequency (MHz)	Level (dBµV/m)	Limit (dBµV/m)	Margin (dB)	Detector	Angle (°)	Height (cm)	Polarisation
*							

Table 13

*No final measurements were made as all peak emissions seen above the measurement system noise floor during the pre-scan were greater than 10 dB below the test limit.

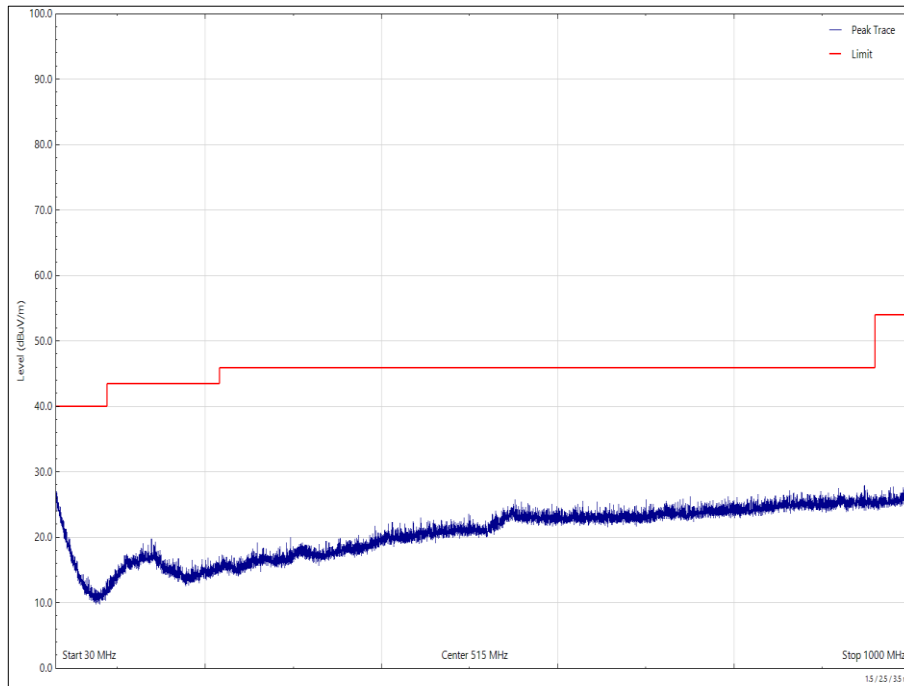

Figure 6 - 30 MHz to 1 GHz, Quasi-Peak, Vertical

Frequency (MHz)	Level (dBµV/m)	Limit (dBµV/m)	Margin (dB)	Detector	Angle (°)	Height (cm)	Polarisation
*							

Table 14

*No final measurements were made as all peak emissions seen above the measurement system noise floor during the pre-scan were greater than 10 dB below the test limit.

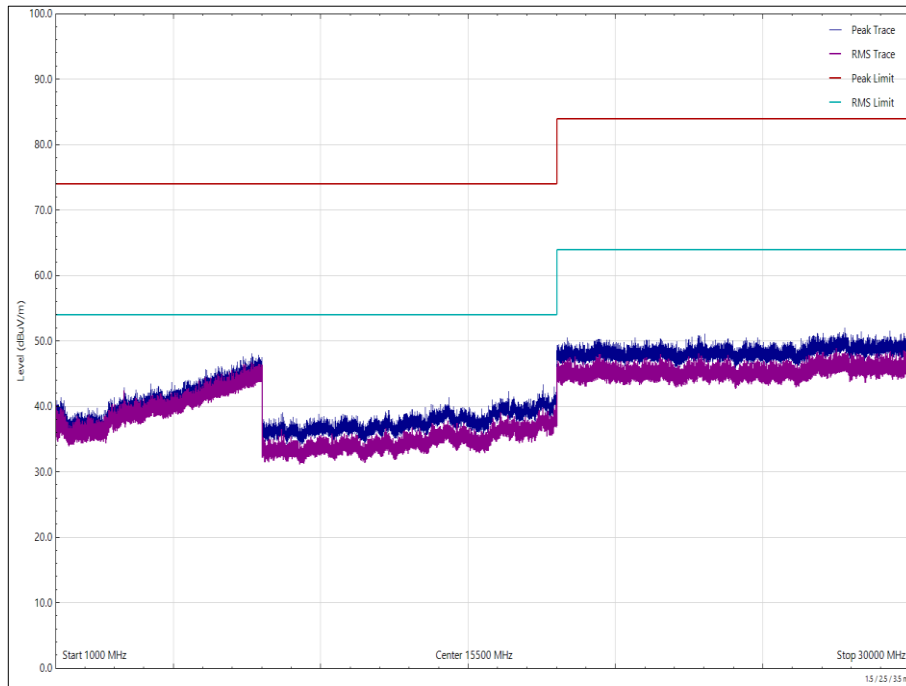

Figure 7 - 1 GHz to 30 GHz, Peak, Horizontal

Frequency (MHz)	Level (dBµV/m)	Limit (dBµV/m)	Margin (dB)	Detector	Angle (°)	Height (cm)	Polarisation
*							

Table 15

*No final measurements were made as all peak emissions seen above the measurement system noise floor during the pre-scan were greater than 10 dB below the test limit.

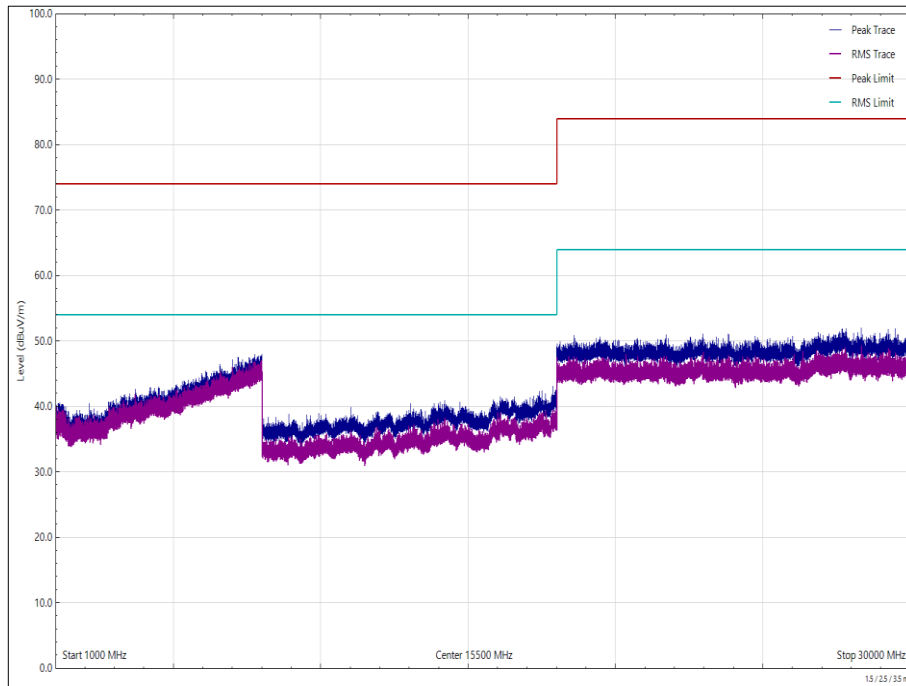

Figure 8 - 1 GHz to 30 GHz, Peak, Vertical

Frequency (MHz)	Level (dBµV/m)	Limit (dBµV/m)	Margin (dB)	Detector	Angle (°)	Height (cm)	Polarisation
*							

Table 16

*No final measurements were made as all peak emissions seen above the measurement system noise floor during the pre-scan were greater than 10 dB below the test limit.



2.2.10 Test Location and Test Equipment Used

This test was carried out in RF Chamber 11.

Instrument	Manufacturer	Type No	TE No	Calibration Period (months)	Calibration Expires
Screened Room (11)	Rainford	Rainford	5136	36	24-Nov-2024
Emissions Software	TUV SUD	EmX V2.1.11	5125	-	Software
EMI Test Receiver	Rohde & Schwarz	ESW44	5084	12	08-Mar-2022
Mast	Maturo	TAM 4.0-P	5158	-	TU
Mast and Turntable Controller	Maturo	Maturo NCD	5159	-	TU
Turntable	Maturo	TT 15WF	5160	-	TU
2m SMA Cable	Junkosha	MWX221-02000AMSAMS/A	5518	12	09-Apr-2022
8m N Type Cable	Junkosha	MWX221-08000NMSNMS/B	5522	12	24-Mar-2022
2m K Type Cable	Junkosha	MWX241-02000KMSKMS/A	5524	12	24-Mar-2022
Cable (K-Type to K-Type, 1 m)	Junkosha	MWX241-01000KMSKMS/A	5511	12	09-Apr-2022
Cable (18 GHz)	Rosenberger	LU7-071-1000	5102	12	20-Oct-2022
Pre Amp 1 - 26.5 GHz	Agilent Technologies	8449B	5445	12	06-May-2022
8 - 18 GHz Amplifier	Wright Technologies	APS06-0061	5595	12	24-Aug-2022
Pre-Amplifier (18 GHz to 40 GHz)	Phase One	PSO4-0087	1534	12	02-Aug-2022
1200 MHz Low Pass Filter (02)	Mini-Circuits	VLF-1200+	5560	12	24-May-2022
Antenna with attenuator (Bilog, 30 MHz to 3 GHz)	Schaffner	CBL6143	287	24	14-Oct-2022
Horn Antenna (1-10GHz)	Schwarzbeck	BBHA 9120 B	5215	12	1-Apr-2022
DRG Horn Antenna (7.5-18GHz)	Schwarzbeck	HWRD750	5216	12	01-Apr-2022
Antenna (DRG, 18 GHz to 40 GHz)	Link Microtek Ltd	AM180HA-K-TU2	230	24	27-Jul-2022

Table 17

TU - Traceability Unscheduled



3 Incident Reports

No incidents reports were raised.



4 Measurement Uncertainty

For a 95% confidence level, the measurement uncertainties for defined systems are:

Test Name	Measurement Uncertainty
Conducted Disturbance at Mains Terminals	150 kHz to 30 MHz, LISN, ± 3.7 dB
Radiated Disturbance	30 MHz to 1 GHz, Bilog Antenna, ± 5.2 dB 1 GHz to 40 GHz, Horn Antenna, ± 6.3 dB

Table 18

Worst case error for both Time and Frequency measurement 12 parts in 10^6 .

Measurement Uncertainty Decision Rule – Accuracy Method

Determination of conformity with the specification limits is based on the decision rule according to IEC Guide 115:2007, Clause 4.4.3 and 4.5.1. (Procedure 2). The measurement results are directly compared with the test limit to determine conformance with the requirements of the standard.

Risk: The uncertainty of measurement about the measured result is negligible with regard to the final pass/fail decision. The measurement result can be directly compared with the test limit to determine conformance with the requirement (compare IEC Guide 115). The level of risk to falsely accept and falsely reject items is further described in ILAC-G8.