

FCC and ISED Test Report

Apple Inc
Model: A2442

In accordance with FCC 47 Part 15
ISED RSS-247 and ISED RSS-GEN (2.4 GHz
Bluetooth, 2.4 GHz WLAN and 5 GHz WLAN)

Prepared for: Apple Inc
One Apple Park Way
Cupertino
California
95014
USA



Add value.
Inspire trust.

FCC ID: BCGA2442

IC: 579C-A2442

COMMERCIAL-IN-CONFIDENCE

Document 75952057-14 Issue 02

SIGNATURE			
NAME	JOB TITLE	RESPONSIBLE FOR	ISSUE DATE
Steve Marshall	Senior Engineer	Authorised Signatory	22 September 2021

Signatures in this approval box have checked this document in line with the requirements of TUV SUD document control rules.

ENGINEERING STATEMENT

The measurements shown in this report were made in accordance with the procedures described on test pages. All reported testing was carried out on a sample equipment to demonstrate limited compliance with FCC 47 CFR Parts 15, ISED RSS-247 and ISED RSS-GEN. The sample tested was found to comply with the requirements defined in the applied rules.

RESPONSIBLE FOR	NAME	DATE	SIGNATURE
Testing	Liang Tian	22 September 2021	
Testing	Mohammad Malik	22 September 2021	

FCC Accreditation

90987 Octagon House, Fareham Test Laboratory

ISED Accreditation

12669A Octagon House, Fareham Test Laboratory

EXECUTIVE SUMMARY

A sample of this product was tested and found to be compliant with FCC 47 CFR Part 15: 2020, ISED RSS-247: Issue 2 (2017-02) and ISED RSS-GEN: Issue 5 (04-2018) + A2 (02-2021) for the tests detailed in section 1.3.



DISCLAIMER AND COPYRIGHT

This non-binding report has been prepared by TÜV SÜD with all reasonable skill and care. The document is confidential to the potential Client and TÜV SÜD. No part of this document may be reproduced without the prior written approval of TÜV SÜD. © 2021 TÜV SÜD. This report relates only to the actual item/items tested.

ACCREDITATION

Our UKAS Accreditation does not cover opinions and interpretations and any expressed are outside the scope of our UKAS Accreditation. Results of tests not covered by our UKAS Accreditation Schedule are marked NUA (Not UKAS Accredited).

TÜV SÜD
is a trading name of TÜV SÜD Ltd
Registered in Scotland at East Kilbride,
Glasgow G75 0QF, United Kingdom
Registered number: SC215164

TÜV SÜD Ltd is a
TÜV SÜD Group Company

Phone: +44 (0) 1489 558100
Fax: +44 (0) 1489 558101
www.tuvsud.com/en

TÜV SÜD
Octagon House
Concorde Way
Fareham
Hampshire PO15 5RL
United Kingdom



Contents

1	Report Summary	2
1.1	Report Modification Record.....	2
1.2	Introduction.....	2
1.3	Brief Summary of Results	3
1.4	Product Information	4
1.5	Deviations from the Standard.....	4
1.6	EUT Modification Record	4
1.7	Test Location	4
2	Test Details	5
2.1	Radiated Spurious Emissions (Simultaneous Transmission)	5
3	Measurement Uncertainty	18



1 Report Summary

1.1 Report Modification Record

Alterations and additions to this report will be issued to the holders of each copy in the form of a complete document.

Issue	Description of Change	Date of Issue
1	First Issue	17 September 2021
2	Updated FCC ID and IC on Front Page	22-September-2021

Table 1

1.2 Introduction

Applicant	Apple Inc
Manufacturer	Apple Inc
Model Number(s)	A2442
Serial Number(s)	DNQHW6Y3WY
Hardware Version(s)	REV1.0
Software Version(s)	21A102280p
Number of Samples Tested	1
Test Specification/Issue/Date	FCC 47 CFR Part 15: 2020 ISED RSS-247: Issue 2 (2017-02) ISED RSS-GEN: Issue 5 (04-2018) + A2 (02-2021)
Order Number	0540218229
Date	22-April-2021
Date of Receipt of EUT	31-March-2021
Start of Test	24-July-2021
Finish of Test	10-August-2021
Name of Engineer(s)	Liang Tian and Mohammad Malik
Related Document(s)	ANSI C63.26: 2015 ANSI C63.10: 2013



1.3 Brief Summary of Results

A brief summary of the tests carried out in accordance with FCC 47 CFR Parts 15, ISED RSS-247 and ISED RSS-GEN is shown below.

Section	Specification Clause			Test Description	Result	Comments/Base Standard
	FCC Part 15	RSS-247	RSS-GEN			
Configuration and Mode: CoTx - 2.4 GHz WLAN, 5GHz WLAN and 2.4 GHz Bluetooth						
2.1	15.247 (d), 15.407 (b) and 15.209	5.5 and 6.2	8.9 and 8.10	Radiated Spurious Emissions (Simultaneous Transmission)	Pass	
Configuration and Mode: SDB - 2.4 GHz WLAN and 5 GHz WLAN						
2.1	15.247 (d), 15.407 (b) and 15.209	5.5 and 6.2	8.9 and 8.10	Radiated Spurious Emissions (Simultaneous Transmission)	Pass	

Table 2



1.4 Product Information

1.4.1 Technical Description

The Equipment under test (EUT) was a laptop computer with Bluetooth, Bluetooth Low Energy and 802.11 a/b/g/n/ac/ax capabilities in the 2.4 GHz and 5 GHz bands.

1.5 Deviations from the Standard

No deviations from the applicable test standard were made during testing.

1.6 EUT Modification Record

The table below details modifications made to the EUT during the test programme.

The modifications incorporated during each test are recorded on the appropriate test pages.

Modification State	Description of Modification still fitted to EUT	Modification Fitted By	Date Modification Fitted
Model: A2442, Serial Number: DNQHW6Y3WY			
0	As supplied by the customer	Not Applicable	Not Applicable

Table 3

1.7 Test Location

TÜV SÜD conducted the following tests at our Fareham Test Laboratory.

Test Name	Name of Engineer(s)	Accreditation
Configuration and Mode: CoTx - 2.4 GHz WLAN, 5GHz WLAN and 2.4 GHz Bluetooth		
Radiated Spurious Emissions (Simultaneous Transmission)	Liang Tian	UKAS
Configuration and Mode: SDB - 2.4 GHz WLAN and 5 GHz WLAN		
Radiated Spurious Emissions (Simultaneous Transmission)	Mohammad Malik and Liang Tian	UKAS

Table 4

Office Address:

TÜV SÜD
Octagon House
Concorde Way
Fareham
Hampshire
PO15 5RL
United Kingdom



2 Test Details

2.1 Radiated Spurious Emissions (Simultaneous Transmission)

2.1.1 Specification Reference

FCC 47 CFR Parts 15, Clause 15.247 (d), 15.407 (b) and 15.209
ISED RSS 247, Clause 5.5 and 6.2
ISED RSS GEN, Clause 8.9 and 8.10

2.1.2 Equipment Under Test and Modification State

A2442, S/N: DNQHW6Y3WY - Modification State 0

2.1.3 Date of Test

24-July-2021 to 10-August-2021

2.1.4 Test Method

This test was performed in accordance with ANSI C63.10, clause 6.3, 6.5 and 6.6.

The EUT was placed on the non-conducting platform in a manner typical of a normal installation.

Ports on the EUT were terminated with loads as described in ANSI C63.4 clause 6.2.4 for each type of port on the EUT.

For frequencies > 1 GHz, plots for average measurements were taken in accordance with ANSI C63.10, clause 4.1.4.2.5 to characterize the EUT. Where emissions were detected, final average measurements were taken in accordance with ANSI C63.10, clause 4.1.4.2.2, 11.11, 11.12, 12.7.2 or 12.7.3 depending on the nature of the emission measured.

The plots shown are the characterisation of the EUT. The limits on the plots represent the most stringent case for restricted bands, (74/54 dBuV/m) when compared to non-restricted band limits. The limits shown have been used as a threshold to determine where further measurements are necessary. Where results are within 10 dB of the limits shown on the plots, further investigation was carried out and reported in results tables.

The following conversion can be applied to convert from dB μ V/m to μ V/m:
 $10^{(\text{Field Strength in dB}\mu\text{V/m}/20)}$.

To determine the emission characteristic of the EUT above 18 GHz, the test antenna was swept over all faces of the EUT whilst observing a spectral display. The frequency of any emissions of interest was noted for formal measurement at the correct measurement distance of 1m. This procedure was repeated for all relevant transmit operating channels.

At a measurement distance of 1 meter the limit line was increased by $20 \cdot \text{LOG}(3/1) = 9.54$ dB.

2.1.5 Example Test Setup Diagram

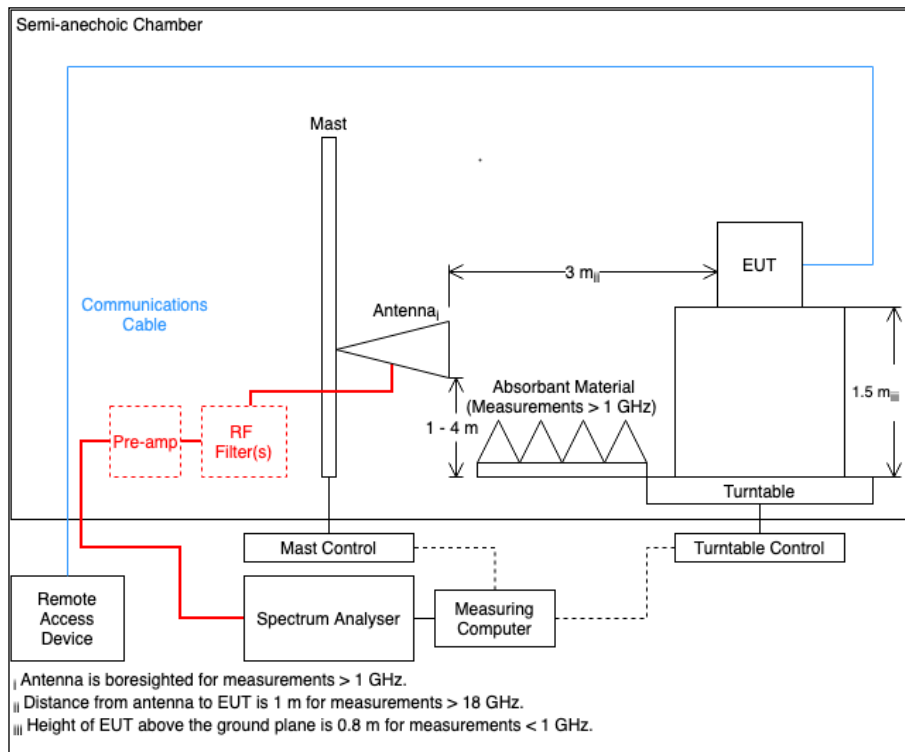

Figure 1

2.1.6 Environmental Conditions

Ambient Temperature 19.6 - 24.0 °C
 Relative Humidity 50.5 - 63.5 %



2.1.7 Test Results

CoTx - 2.4 GHz WLAN and 5GHz WLAN and 2.4 GHz Bluetooth

Frequency (MHz)	Level (dBuV/m)	Limit (dBuV/m)	Margin (dB)	Detector	Angle (°)	Height (cm)	Polarisation
*							

Table 5 - 2412 MHz (CH1), HT20, Core 0 + Core 1 and U-NII-1 – 5200 MHz (CH40), HT20, Core 0 + Core 1 and 2402 MHz (CH0), DH5, iPA, Core 2, 30 MHz to 40 GHz

*No emissions found within 6 dB of the limit.

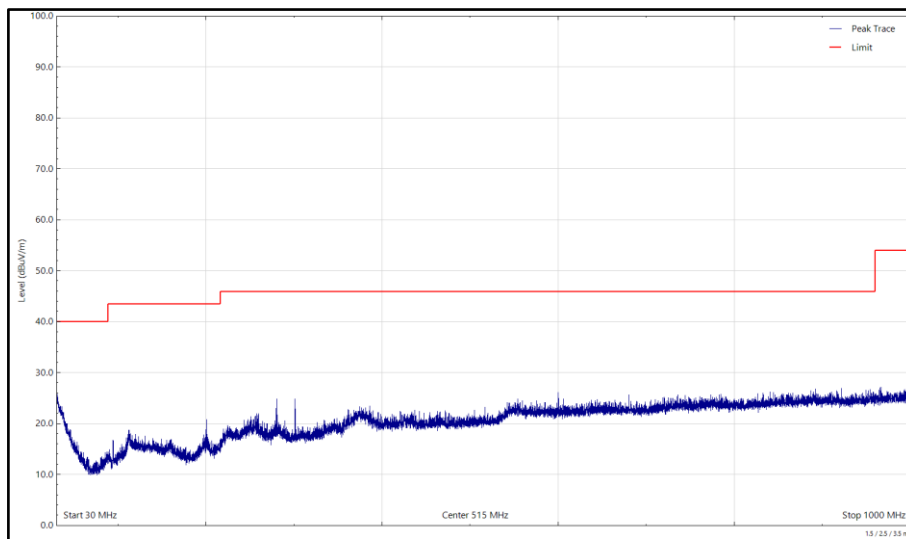

Figure 2 - 2412 MHz (CH1), HT20, Core 0 + Core 1 and U-NII-1 - 5200 MHz (CH40), HT20, Core 0 + Core 1 and 2402 MHz (CH0), DH5, iPA, Core 2, 30 MHz to 1 GHz, Horizontal (Peak)

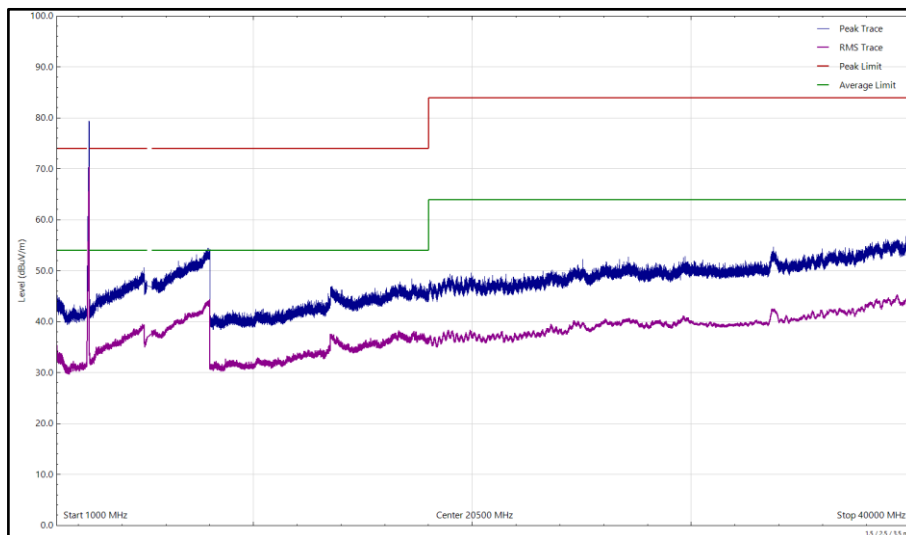

Figure 3 - 2412 MHz (CH1), HT20, Core 0 + Core 1 and U-NII-1 - 5200 MHz (CH40), HT20, Core 0 + Core 1 and 2402 MHz (CH0), DH5, iPA, Core 2, 1 GHz to 40 GHz, Horizontal

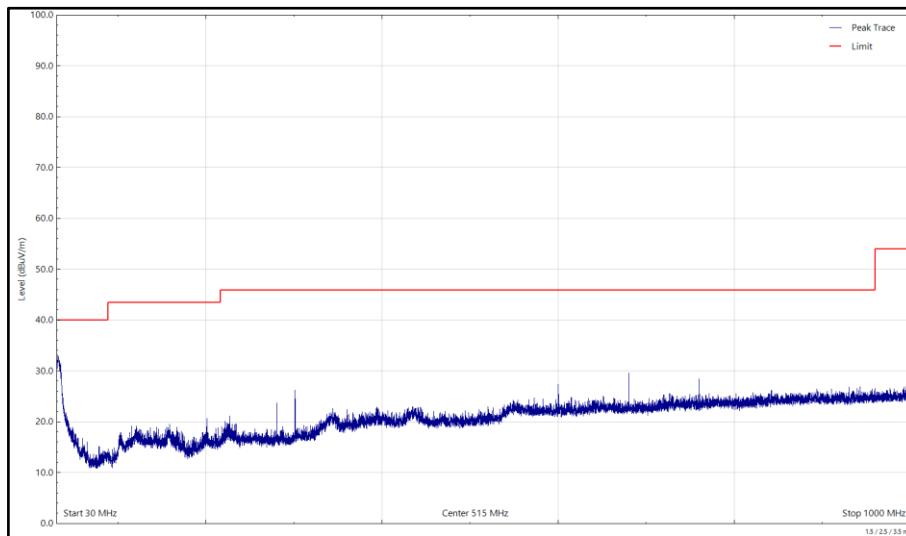

Figure 4 - 2412 MHz (CH1), HT20, Core 0 + Core 1 and U-NII-1 - 5200 MHz (CH40), HT20, Core 0 + Core 1 and 2402 MHz (CH0), DH5, iPA, Core 2, 30 MHz to 1 GHz, Vertical (Peak)

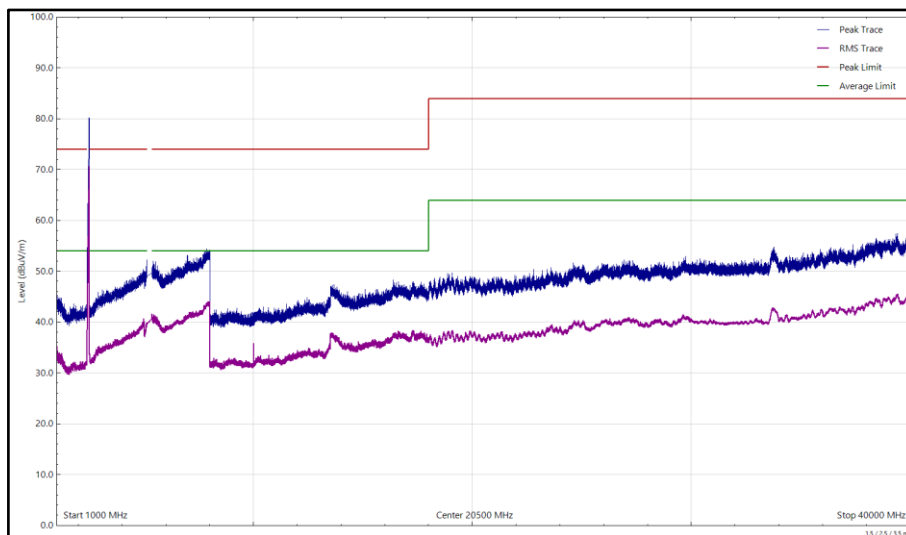

Figure 5 - 2412 MHz (CH1), HT20, Core 0 + Core 1 and U-NII-1 - 5200 MHz (CH40), HT20, Core 0 + Core 1 and 2402 MHz (CH0), DH5, iPA, Core 2, 1 GHz to 40 GHz, Vertical



Frequency (MHz)	Level (dBuV/m)	Limit (dBuV/m)	Margin (dB)	Detector	Angle (°)	Height (cm)	Polarisation
*							

Table 6 - 2472 MHz (CH13), HT20, Core 0 + Core 1 and U-NII-2C – 5680 MHz (CH136), HT20, Core 0 + Core 1 and 2480 MHz (CH78), DH5, iPA, Core 2, 30 MHz to 40 GHz

*No emissions found within 6 dB of the limit.

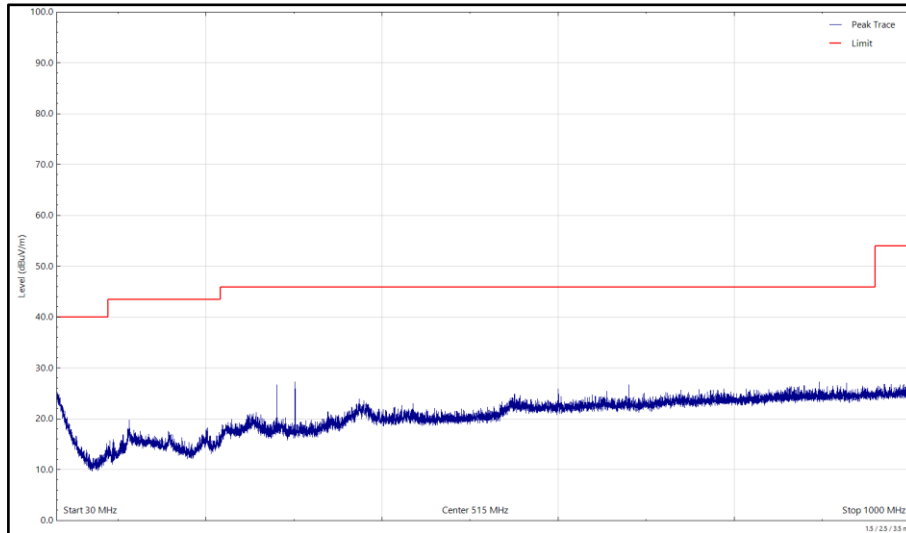

Figure 6 - 2472 MHz (CH13), HT20, Core 0 + Core 1 and U-NII-2C - 5680 MHz (CH136), HT20, Core 0 + Core 1 and 2480 MHz (CH78), DH5, iPA, Core 2, 30 MHz to 1 GHz, Horizontal (Peak)

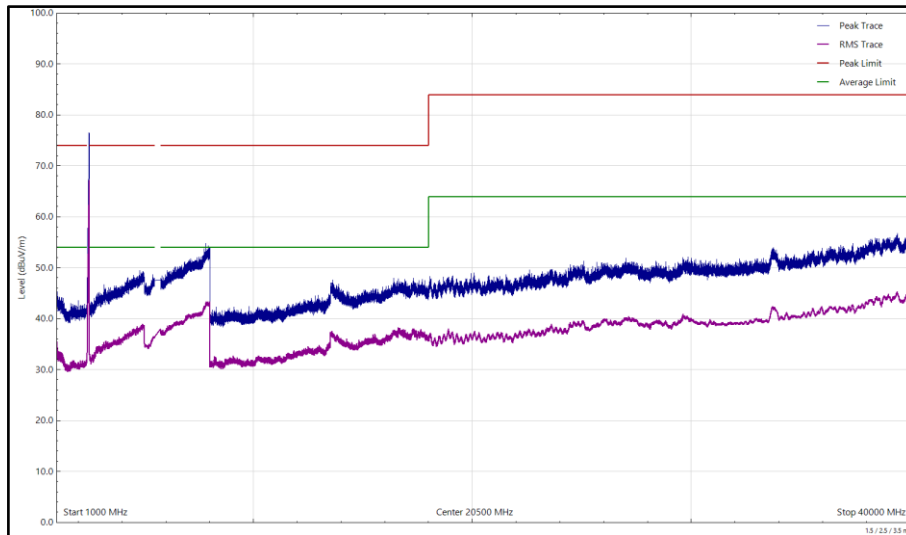

Figure 7 - 2472 MHz (CH13), HT20, Core 0 + Core 1 and U-NII-2C - 5680 MHz (CH136), HT20, Core 0 + Core 1 and 2480 MHz (CH78), DH5, iPA, Core 2, 1 GHz to 40 GHz, Horizontal

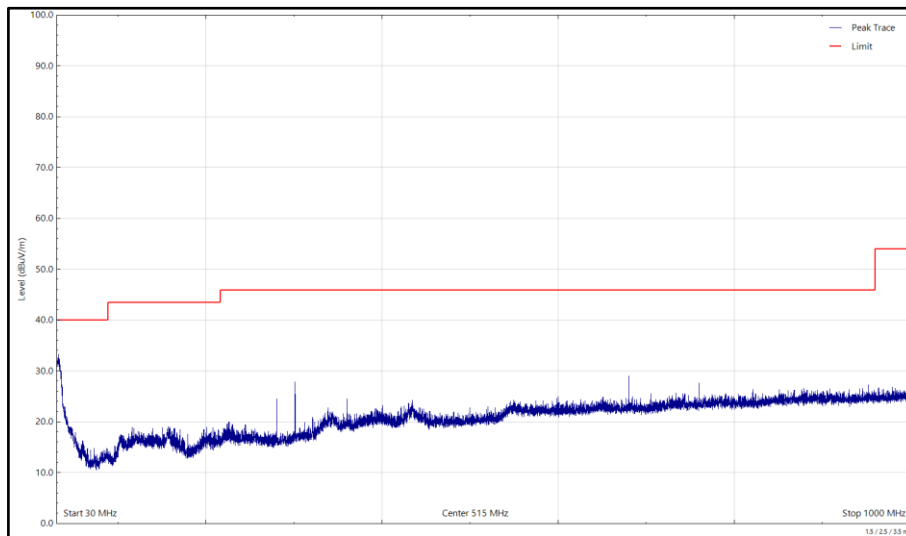

Figure 8 - 2472 MHz (CH13), HT20, Core 0 + Core 1 and U-NII-2C - 5680 MHz (CH136), HT20, Core 0 + Core 1 and 2480 MHz (CH78), DH5, iPA, Core 2, 30 MHz to 1 GHz, Vertical (Peak)

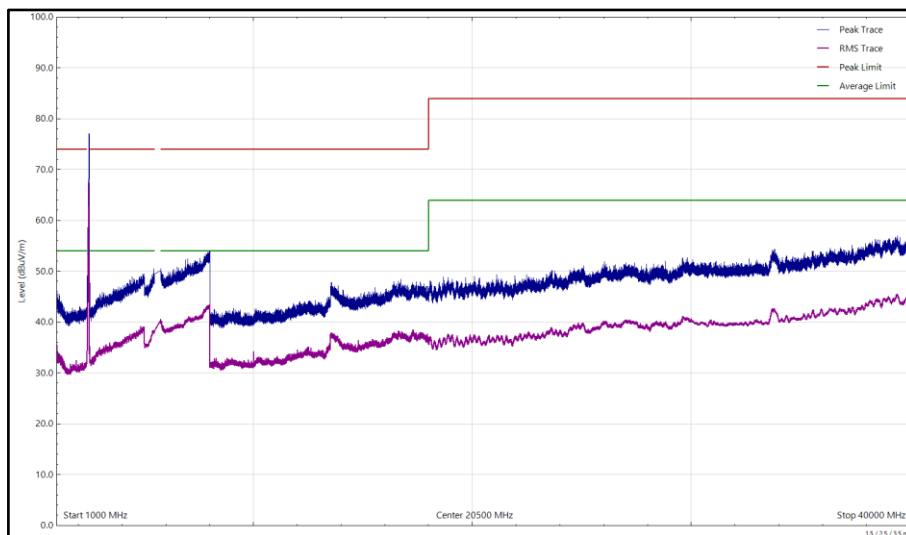

Figure 9 - 2472 MHz (CH13), HT20, Core 0 + Core 1 and U-NII-2C - 5680 MHz (CH136), HT20, Core 0 + Core 1 and 2480 MHz (CH78), DH5, iPA, Core 2, 1 GHz to 40 GHz, Vertical



SDB - 2.4 GHz WLAN and 5 GHz WLAN

Frequency (MHz)	Level (dBuV/m)	Limit (dBuV/m)	Margin (dB)	Detector	Angle (°)	Height (cm)	Polarisation
32.513	25.7	40.0	-14.3	Q-Peak	358	251	Vertical
2788.048	39.1	54.0	-14.9	RMS	347	334	Vertical
2789.966	34.8	54.0	-19.2	RMS	52	380	Horizontal
4822.137	40.2	54.0	-13.8	RMS	330	282	Vertical

Table 7 - 2412 MHz (CH1), HT20, CDD, Core 0 + Core 1 and U-NII-1 – 5200 MHz (CH40), HT20, CDD, Core 0 + Core 1, 30 MHz to 40 GHz

No other emissions found within 10 dB of the limit.

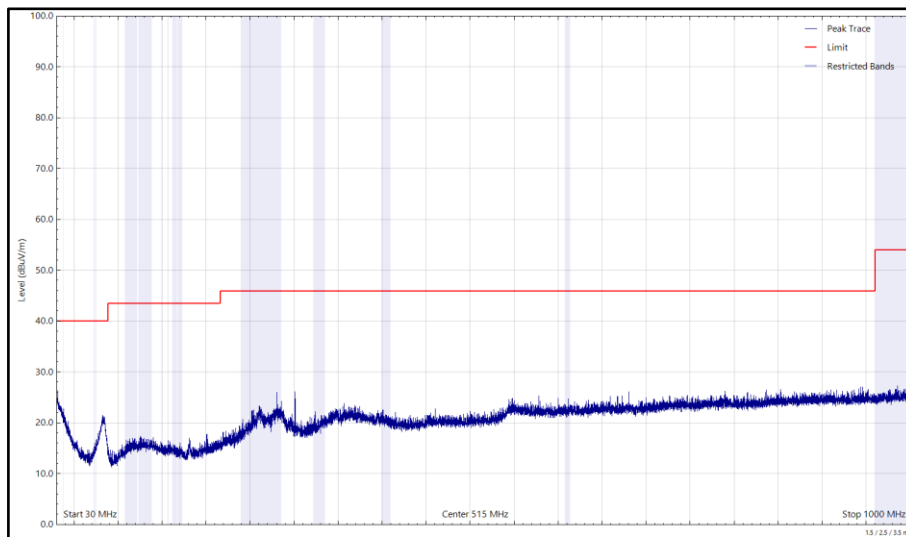

Figure 10 - 2412 MHz (CH1), HT20, CDD, Core 0 + Core 1 and U-NII-1 - 5200 MHz (CH40), HT20, CDD, Core 0 + Core 1, 30 MHz to 1 GHz, Horizontal (Peak)

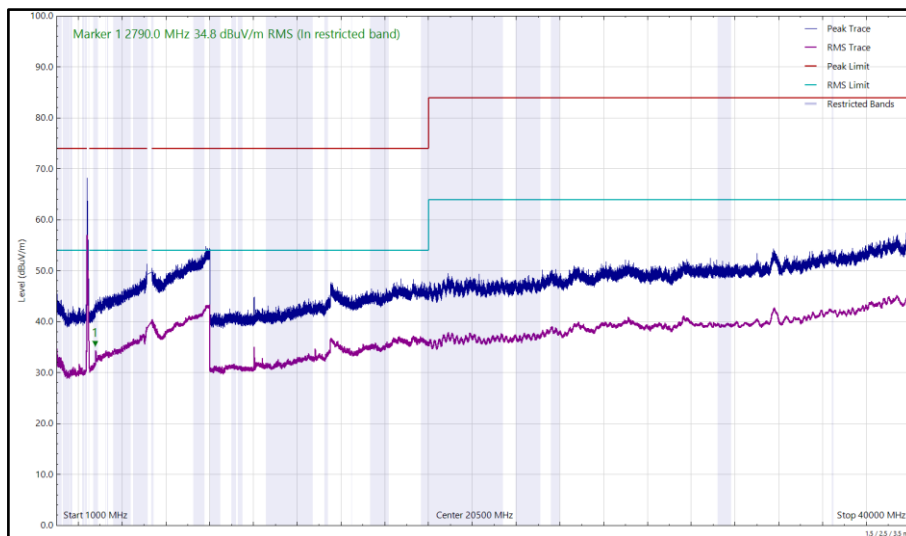

Figure 11 - 2412 MHz (CH1), HT20, CDD, Core 0 + Core 1 and U-NII-1 - 5200 MHz (CH40), HT20, CDD, Core 0 + Core 1, 1 GHz to 40 GHz, Horizontal

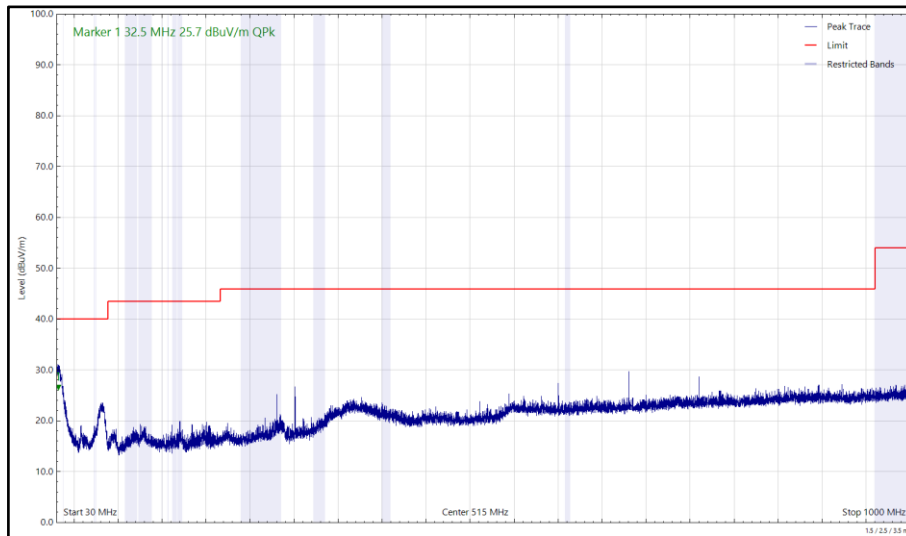

Figure 12 - 2412 MHz (CH1), HT20, CDD, Core 0 + Core 1 and U-NII-1 - 5200 MHz (CH40), HT20, CDD, Core 0 + Core 1, 30 MHz to 1 GHz, Vertical (Peak)

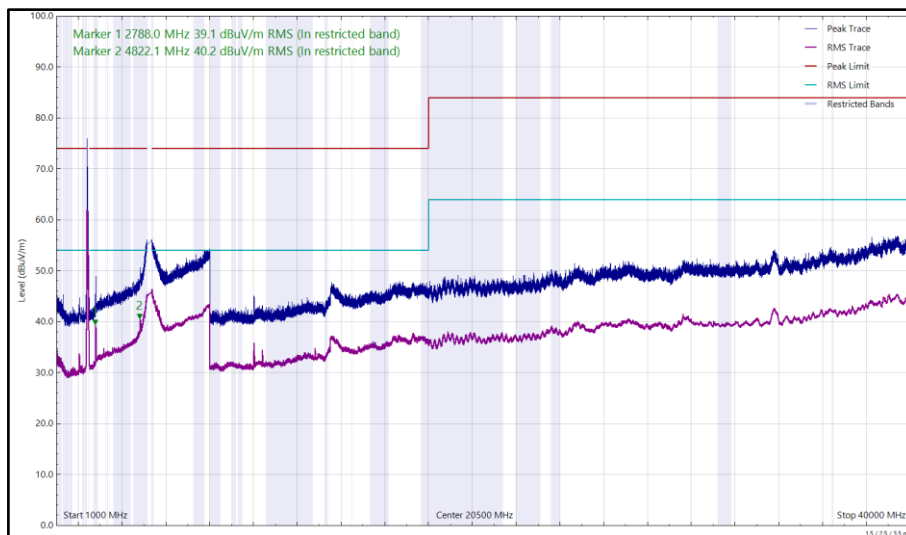

Figure 13 - 2412 MHz (CH1), HT20, CDD, Core 0 + Core 1 and U-NII-1 - 5200 MHz (CH40), HT20, CDD, Core 0 + Core 1, 1 GHz to 40 GHz, Vertical



Frequency (MHz)	Level (dBuV/m)	Limit (dBuV/m)	Margin (dB)	Detector	Angle (°)	Height (cm)	Polarisation
4944.402	38.9	54.0	-15.1	RMS	20	375	Vertical

Table 8 - 2472 MHz (CH13), HT20, CDD, Core 0 + Core 1 and U-NII-2C - 5680 MHz (CH136), HT20, CDD, Core 0 + Core 1, 30 MHz to 40 GHz

No other emissions found within 10 dB of the limit.

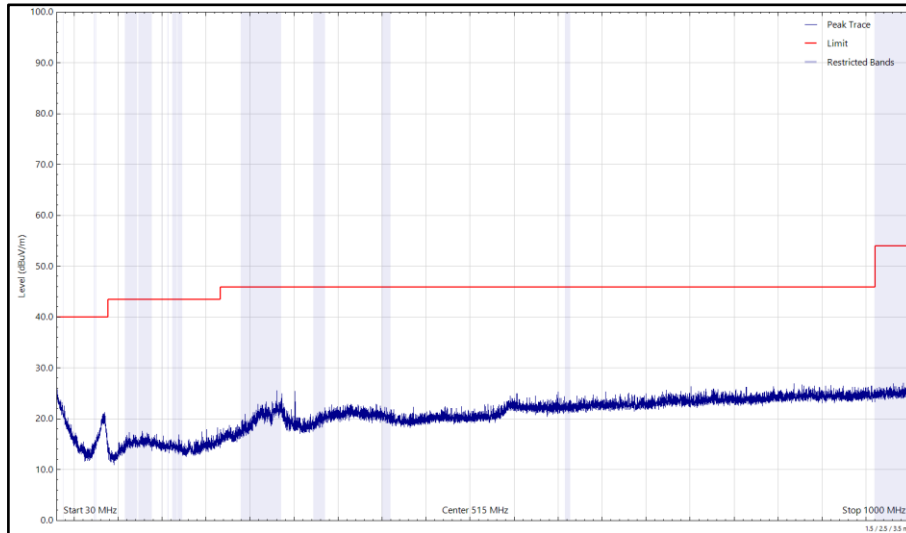

Figure 14 - 2472 MHz (CH13), HT20, CDD, Core 0 + Core 1 and U-NII-2C - 5680 MHz (CH136), HT20, CDD, Core 0 + Core 1, 30 MHz to 1 GHz, Horizontal (Peak)

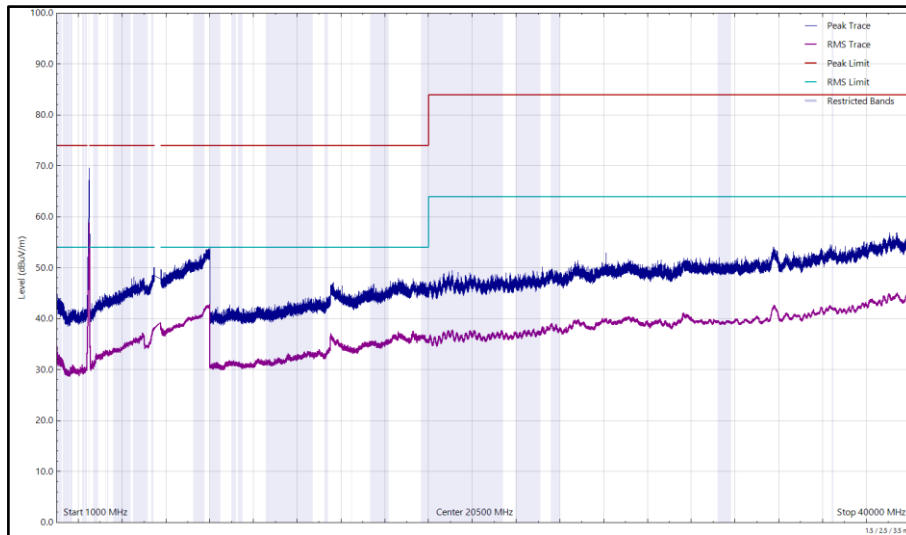

Figure 15 - 2472 MHz (CH13), HT20, CDD, Core 0 + Core 1 and U-NII-2C - 5680 MHz (CH136), HT20, CDD, Core 0 + Core 1, 1 GHz to 40 GHz, Horizontal

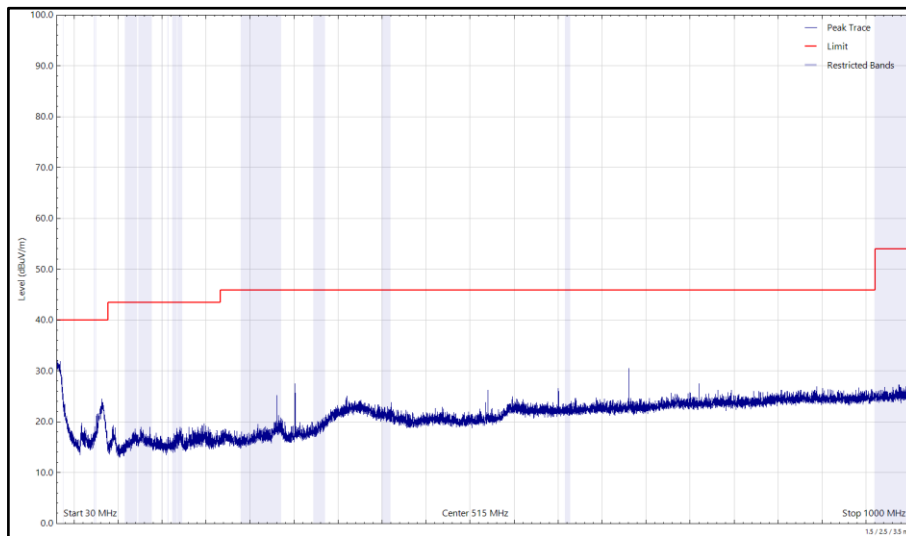

Figure 16 - 2472 MHz (CH13), HT20, CDD, Core 0 + Core 1 and U-NII-2C - 5680 MHz (CH136), HT20, CDD, Core 0 + Core 1, 30 MHz to 1 GHz, Vertical (Peak)

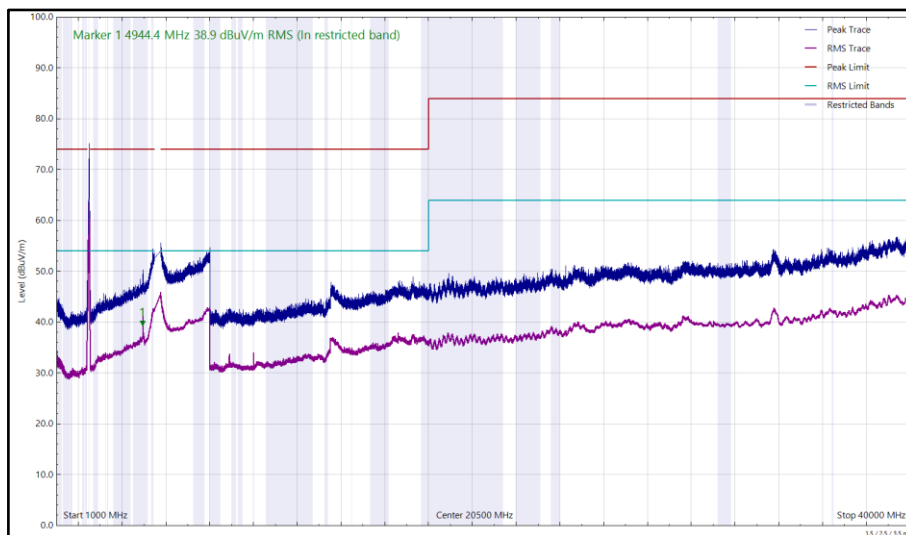

Figure 17 - 2472 MHz (CH13), HT20, CDD, Core 0 + Core 1 and U-NII-2C - 5680 MHz (CH136), HT20, CDD, Core 0 + Core 1, 1 GHz to 40 GHz, Vertical



The least stringent limit from the applicable rule parts was used to determine compliance for Radiated Emissions testing of multiple transmission sources.

FCC 47 CFR Parts 15.205, 15.247(d) and 15.407(b)

Clause	Limit
15.205	Within restricted bands of operation as listed in 15.209: 30-88 MHz: 40 dB μ V/m 88-216 MHz: 43.52 dB μ V/m 216-960 MHz: 46.02 dB μ V/m Above 960 MHz: 53.98 dB μ V/m
15.247(d)	Outside of restricted bands of operation as listed in 15.209: -20 dBc

Table 9 – FCC Emissions Limits

ISED RSS-247 Clause 5.5 and 6.2 and ISED RSS-GEN Clause 8.9

Clause	Limit
RSS-GEN Clause 8.9	Within restricted bands of operation as listed in RSS-GEN clause 8.10: 30-88 MHz: 40 dB μ V/m 88-216 MHz: 43.52 dB μ V/m 216-960 MHz: 46.02 dB μ V/m Above 960 MHz: 53.98 dB μ V/m
RSS-247 Clause 5.5	Outside of restricted bands of operation as listed in RSS-GEN clause 8.10: -20 dBc

Table 10 – ISED Emissions Limits



2.1.8 Test Location and Test Equipment Used

This test was carried out in EMC Chamber 5.

Instrument	Manufacturer	Type No	TE No	Calibration Period (months)	Calibration Expires
Double Ridge Guide)	Link Microtek Ltd	AM180HA-K-TU2	230	24	27-Jul-2022
18GHz - 40GHz Pre-Amplifier	Phase One	PSO4-0087	1534	12	18-Feb-2022
Screened Room (5)	Rainford	Rainford	1545	36	15-Apr-2024
Turntable Controller	Inn-Co GmbH	CO 1000	1606	-	TU
Programmable Power Supply	Iso-tech	IPS 2010	2437	-	O/P Mon
Antenna with permanent attenuator (Bilog)	Chase	CBL6143	2904	24	30-Sep-2021
Tilt Antenna Mast	Maturo GmbH	TAM 4.0-P	3916	-	TU
Mast Controller	Maturo GmbH	NCD	3917	-	TU
True RMS Multimeter	Fluke	179	4007	12	29-Oct-2021
Cable 1503 2M 2.92(P)m 2.92(P)m	Rhophase	KPS-1503A-2000-KPS	4293	12	16-Nov-2021
Double Ridge Broadband Horn Antenna	Schwarzbeck	BBHA 9120 B	4848	12	01-Apr-2022
4dB Attenuator	Pasternack	PE7047-4	4935	24	30-Sep-2021
8 - 18 GHz pre amp	Wright Technologies	PS06-0061/PS06-0060	4971	6	04-Nov-2021
Band Reject Filter - 2.425 GHz	Wainwright	WRCGV14-2390-2400-2450-2460-50SS	5067	12	02-Oct-2021
Band Reject Filter - 2.4585 GHz	Wainwright	WRCGV14-2423.5-2433.5-2483.5-2493.5-50SS	5069	12	12-Oct-2021
Band Reject Filter - 5.22 GHz	Wainwright	WRCJV12-5120-5150-5290-5320-50SS	5073	12	02-Oct-2021
Band Reject Filter - 5.690 GHz	Wainwright	WRCJV8-5635-5670-5710-5745-50SS	5081	12	02-Oct-2021
Cable (18 GHz)	Rosenberger	LU7-071-1000	5103	12	12-Oct-2021
Cable (18 GHz)	Rosenberger	LU7-071-2000	5107	12	09-Jul-2022
EmX Emissions Software	TUV SUD	V2.1.11 V.V2.1.11	5125	-	Software
3 GHz High pass filter	Wainwright	WHKX12-2580-3000-18000-80SS	5220	12	26-Mar-2022
Preamplifier (30dB 1GHz to 18GHz)	Schwarzbeck	BBV 9718 C	5261	12	08-Apr-2022
Antenna (DRG Horn 7.5-18GHz)	Schwarzbeck	HWRD750	5348	12	22-Sep-2021
Thermo-Hygro-Barometer	PCE Instruments	PCE-THB-40	5471	12	07-Apr-2022
1m K-Type Cable	Junkosha	MWX241-01000KMSKMS/A	5512	12	09-Apr-2022



2m -SMA Cable	Junkosha	MWX221-02000AMSAMS/A	5517	12	09-Apr-2022
1m -SMA Cable	Junkosha	MWX221-01000AMSAMS/A	5513	12	09-Apr-2022
1m -SMA Cable	Junkosha	MWX221-01000AMSAMS/A	5514	12	09-Apr-2022
2m SMA Cable	Junkosha	MWX221-02000AMSAMS/A	5517	12	09-Apr-2022
8m N-Type Cable	Junkosha	MWX221-08000NMSNMS/B	5520	12	24-Mar-2022
2 m K Type Cable	Junkosha	MWX241-02000KMSKMS/A	5523	12	09-Apr-2022
EMI Test Receiver	Rohde & Schwarz	ESW44	5527	12	15-Apr-2022
7 GHz High pass Filter	Wainwright	WHKX12-5850-6800-18000-80SS	5549	12	20-May-2022
1200 MHz Low Pass Filter (01)	Mini-Circuits	VLF-1200+	5559	12	24-May-2022
Thermo-Hygro-Barometer	PCE Instruments	PCE-THB 40	5605	12	08-Sep-2021
Preamplifier (30dB 18-40GHz)	Schwarzbeck	BBV 9721	5608	12	14-Oct-2021
Horn Antenna (15-40GHz)	Schwarzbeck	BBHA 9170	5609	12	14-Oct-2021

Table 11

TU - Traceability Unscheduled
 O/P Mon – Output Monitored using calibrated equipment



3 Measurement Uncertainty

For a 95% confidence level, the measurement uncertainties for defined systems are:

Test Name	Measurement Uncertainty
Radiated Spurious Emissions (Simultaneous Transmission)	30 MHz to 1 GHz: ± 5.2 dB 1 GHz to 40 GHz: ± 6.3 dB

Table 12

Measurement Uncertainty Decision Rule

Determination of conformity with the specification limits is based on the decision rule according to IEC Guide 115: 2007, clause 4.4.3 and 4.5.1.