

# FCC and ISED Test Report

Apple Inc  
Model: A2338

In accordance with FCC 47 CFR Part 15,  
ISED RSS-247 and ISED RSS-GEN (2.4 GHz  
WLAN, 5 GHz WLAN and 2.4 GHz Bluetooth)

Prepared for: Apple Inc  
One Apple Park Way  
Cupertino  
California  
95014  
USA



Add value.  
Inspire trust.

FCC ID: BGCA2338

IC: 579C-A2338

## COMMERCIAL-IN-CONFIDENCE

Document 75948987-14 Issue 01

### SIGNATURE

NAME	JOB TITLE	RESPONSIBLE FOR	ISSUE DATE
Steve Marshall	Senior Engineer	Authorised Signatory	06 October 2020

Signatures in this approval box have checked this document in line with the requirements of TÜV SÜD document control rules.

### ENGINEERING STATEMENT

The measurements shown in this report were made in accordance with the procedures described on test pages. All reported testing was carried out on a sample equipment to demonstrate limited compliance with FCC 47 CFR Parts 15, ISED RSS-247 and ISED RSS-GEN. The sample tested was found to comply with the requirements defined in the applied rules.

RESPONSIBLE FOR	NAME	DATE	SIGNATURE
Testing	Cristian Onaca	06 October 2020	

FCC Accreditation

90987 Octagon House, Fareham Test Laboratory

ISED Accreditation

12669A Octagon House, Fareham Test Laboratory

### EXECUTIVE SUMMARY

A sample of this product was tested and found to be compliant with FCC 47 CFR Parts 15: 2019, ISED RSS-247: Issue 2 (2017-02) and ISED RSS-GEN: Issue 5 (04-2018) + A1 (03-2019) for the tests detailed in section 1.3.



### DISCLAIMER AND COPYRIGHT

This non-binding report has been prepared by TÜV SÜD with all reasonable skill and care. The document is confidential to the potential Client and TÜV SÜD. No part of this document may be reproduced without the prior written approval of TÜV SÜD. © 2020 TÜV SÜD. This report relates only to the actual item/items tested.

### ACCREDITATION

Our UKAS Accreditation does not cover opinions and interpretations and any expressed are outside the scope of our UKAS Accreditation. Results of tests not covered by our UKAS Accreditation Schedule are marked NUA (Not UKAS Accredited).

TÜV SÜD  
is a trading name of TÜV SÜD Ltd  
Registered in Scotland at East Kilbride,  
Glasgow G75 0QF, United Kingdom  
Registered number: SC215164

TÜV SÜD Ltd is a  
TÜV SÜD Group Company

Phone: +44 (0) 1489 558100  
Fax: +44 (0) 1489 558101  
[www.tuv-sud.co.uk](http://www.tuv-sud.co.uk)

TÜV SÜD  
Octagon House  
Concorde Way  
Fareham  
Hampshire PO15 5RL  
United Kingdom



## Contents

<b>1</b>	<b>Report Summary .....</b>	<b>2</b>
1.1	Report Modification Record.....	2
1.2	Introduction.....	2
1.3	Brief Summary of Results .....	3
1.4	Product Information .....	4
1.5	Deviations from the Standard.....	4
1.6	EUT Modification Record .....	4
1.7	Test Location .....	4
<b>2</b>	<b>Test Details .....</b>	<b>5</b>
2.1	Radiated Spurious Emissions (Simultaneous Transmission) .....	5
<b>3</b>	<b>Measurement Uncertainty .....</b>	<b>27</b>



# 1 Report Summary

## 1.1 Report Modification Record

Alterations and additions to this report will be issued to the holders of each copy in the form of a complete document.

Issue	Description of Change	Date of Issue
1	First Issue	06-October-2020

**Table 1**

## 1.2 Introduction

Applicant	Apple Inc
Manufacturer	Apple Inc
Model Number(s)	A2338
Serial Number(s)	C02CX02PQC36
Hardware Version(s)	REV 1.0
Software Version(s)	20W112771j
Number of Samples Tested	1
Test Specification/Issue/Date	FCC 47 CFR Part 15: 2019 ISED RSS-247: Issue 2 (2017-02) ISED RSS-GEN: Issue 5 (04-2018) + A1 (03-2019)
Order Number	0540201117
Date	05-May-2020
Date of Receipt of EUT	30-August-2020
Start of Test	30-August-2020
Finish of Test	09-September-2020
Name of Engineer(s)	Cristian Onaca
Related Document(s)	ANSI C63.10: 2013



### 1.3 Brief Summary of Results

A brief summary of the tests carried out in accordance with FCC 47 CFR Parts 15, ISED RSS-247 and ISED RSS-GEN is shown below.

Section	Specification Clause			Test Description	Result	Comments/Base Standard
	FCC Part 15	RSS-247	RSS-GEN			
Configuration and Mode: SDB - 2.4 GHz WLAN and 5 GHz WLAN						
2.1	15.247 (d), 15.407 (b) and 15.209	5.5 and 6.2	8.9 and 8.10	Radiated Spurious Emissions (Simultaneous Transmission)	Pass	ANSI C63.10: 2013
Configuration and Mode: CoTX - 2.4 GHz WLAN, 5 GHz WLAN and 2.4 GHz Bluetooth						
2.1	15.247 (d), 15.407 (b) and 15.209	5.5 and 6.2	8.9 and 8.10	Radiated Spurious Emissions (Simultaneous Transmission)	Pass	ANSI C63.10: 2013

**Table 2**



## 1.4 Product Information

### 1.4.1 Technical Description

The Equipment Under Test (EUT) was a Laptop Computer with Bluetooth, Bluetooth Low Energy and 802.11 a/b/g/n/ac/ax capabilities in the 2.4 GHz and 5 GHz bands.

### 1.5 Deviations from the Standard

No deviations from the applicable test standard were made during testing.

### 1.6 EUT Modification Record

The table below details modifications made to the EUT during the test programme.

The modifications incorporated during each test are recorded on the appropriate test pages.

Modification State	Description of Modification still fitted to EUT	Modification Fitted By	Date Modification Fitted
Model: A2338, Serial Number: C02CX02PQC36			
0	As supplied by the customer	Not Applicable	Not Applicable

**Table 3**

### 1.7 Test Location

TÜV SÜD conducted the following tests at our Fareham Test Laboratory.

Test Name	Name of Engineer(s)	Accreditation
Configuration and Mode: SDB - 2.4 GHz WLAN and 5 GHz WLAN		
Radiated Spurious Emissions (Simultaneous Transmission)	Cristian Onaca	UKAS
Configuration and Mode: CoTX - 2.4 GHz WLAN , 5 GHz WLAN and 2.4 GHz Bluetooth		
Radiated Spurious Emissions (Simultaneous Transmission)	Cristian Onaca	UKAS

**Table 4**

Office Address:

Octagon House  
Concorde Way  
Segensworth North  
Fareham  
Hampshire  
PO15 5RL  
United Kingdom



## 2 Test Details

### 2.1 Radiated Spurious Emissions (Simultaneous Transmission)

#### 2.1.1 Specification Reference

FCC 47 CFR Parts 15, Clause 15.247 (d), 15.407 (b) and 15.209  
ISED RSS 247, Clause 5.5 and 6.2  
ISED RSS GEN, Clause 8.9 and 8.10

#### 2.1.2 Equipment Under Test and Modification State

A2338, S/N: C02CX02PQC36 - Modification State 0

#### 2.1.3 Date of Test

30-August-2020 to 09-September-2020

#### 2.1.4 Test Method

This test was performed in accordance with ANSI C63.10, clause 6.3, 6.4 and 6.6.

The EUT was placed on the non-conducting platform in a manner typical of a normal installation.

Ports on the EUT were terminated with loads as described in ANSI C63.4 clause 6.2.4 for each type of port on the EUT.

For frequencies > 1 GHz, plots for average measurements were taken in accordance with ANSI C63.10, clause 4.1.4.2.5 to characterize the EUT. Where emissions were detected, final average measurements were taken in accordance with ANSI C63.10, clause 4.1.4.2.2, 11.11, 11.12, 12.7.2 or 12.7.3 depending on the nature of the emission measured.

The plots shown are the characterisation of the EUT. The limits on the plots represent the most stringent case for restricted bands, (74/54 dBuV/m) when compared to non-restricted band limits. The limits shown have been used as a threshold to determine where further measurements are necessary. Where results are within 10 dB of the limits shown on the plots, further investigation was carried out and reported in results tables.

The following conversion can be applied to convert from dB $\mu$ V/m to  $\mu$ V/m:  
 $10^{(\text{Field Strength in dB}\mu\text{V/m}/20)}$ .

To determine the emission characteristic of the EUT above 18 GHz, the test antenna was swept over all faces of the EUT whilst observing a spectral display. The frequency of any emissions of interest was noted for formal measurement at the correct measurement distance of 1m. This procedure was repeated for all relevant transmit operating channels.

At a measurement distance of 1 meter the limit line was increased by  $20 \cdot \text{LOG}(3/1) = 9.54$  dB.

### 2.1.5 Example Test Setup Diagram

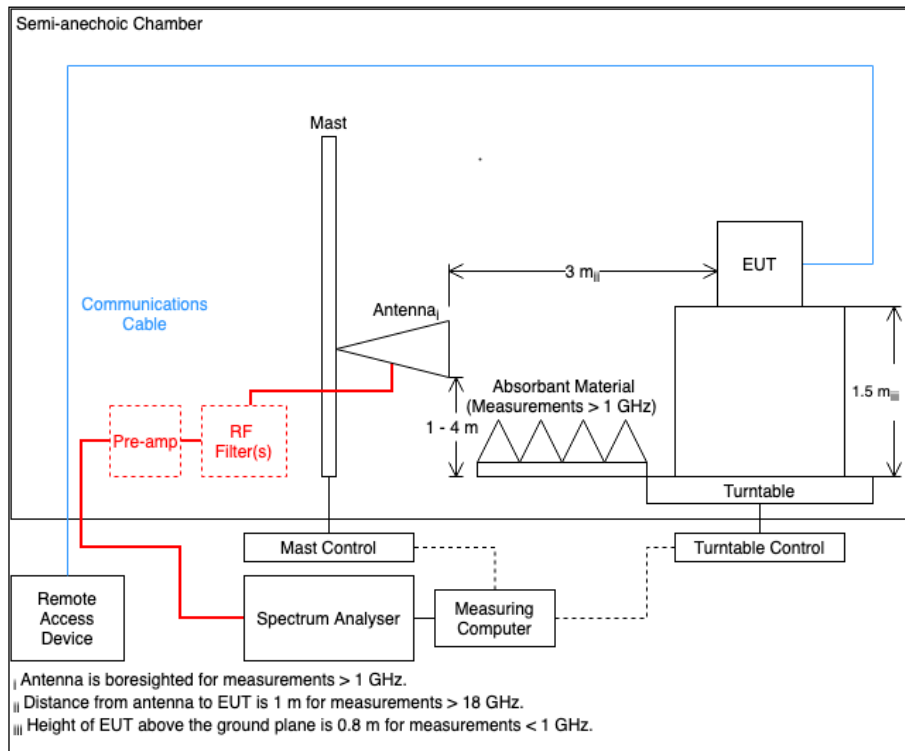

Figure 1

### 2.1.6 Environmental Conditions

Ambient Temperature 20.8 - 24.9 °C  
 Relative Humidity 37.3 - 55.3 %

### 2.1.7 Test Results

SDB - 2.4 GHz WLAN and 5 GHz WLAN

Frequency (MHz)	Level (dBuV/m)	Limit (dBuV/m)	Margin (dB)	Detector	Angle (°)	Height (cm)	Polarisation
4832.926	42.7	54.0	-11.3	rms	348	276	Vertical
4835.295	44.1	54.0	-9.9	rms	8	293	Vertical

**Table 5 - 2417 MHz (CH2), HT20, CDD, Core 0 + Core 1 and U-NII-1 - 5200 MHz (CH40), HT20, CDD, Core 0 + Core 1, 30 MHz to 40 GHz**

No other emissions found within 10 dB of the limit.

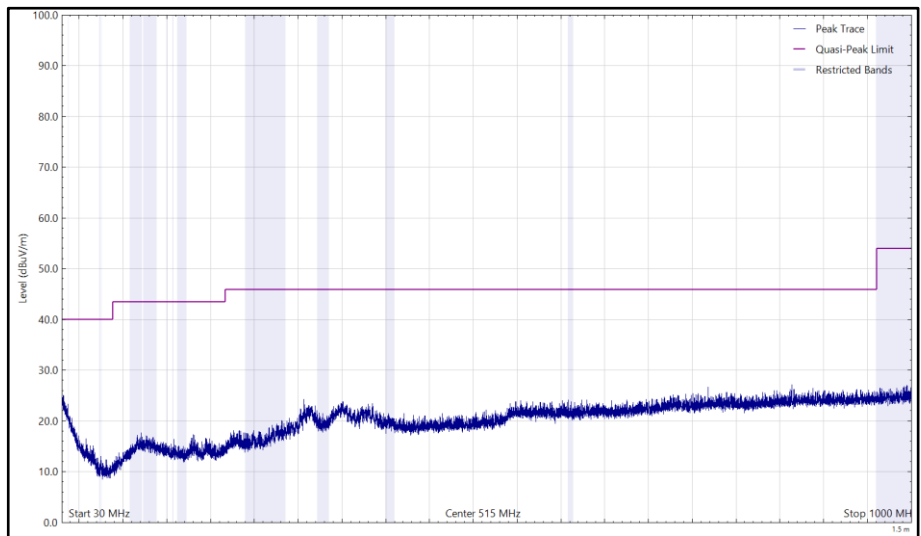

Figure 2 - 2417 MHz (CH2), HT20, CDD, Core 0 + Core 1 and U-NII-1 - 5200 MHz (CH40), HT20, CDD, Core 0 + Core 1, 30 MHz to 1 GHz, Horizontal (Peak)

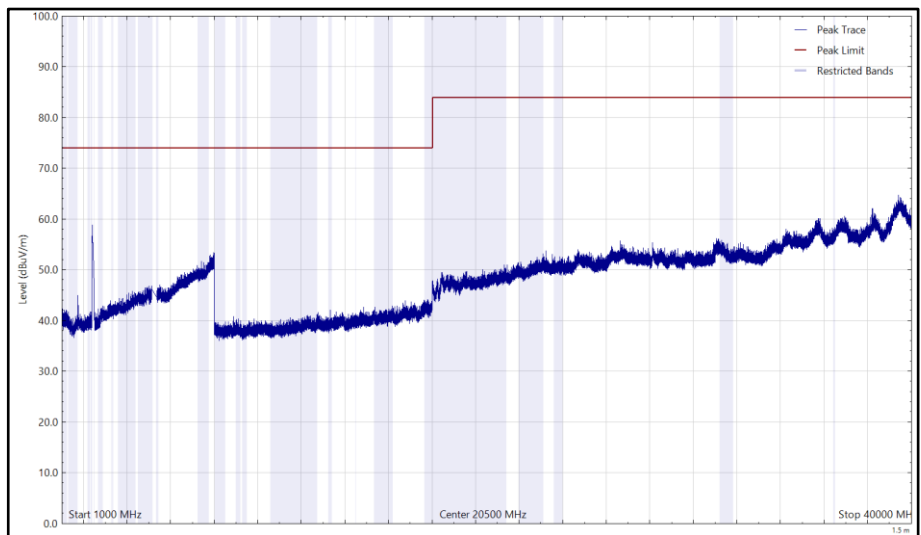
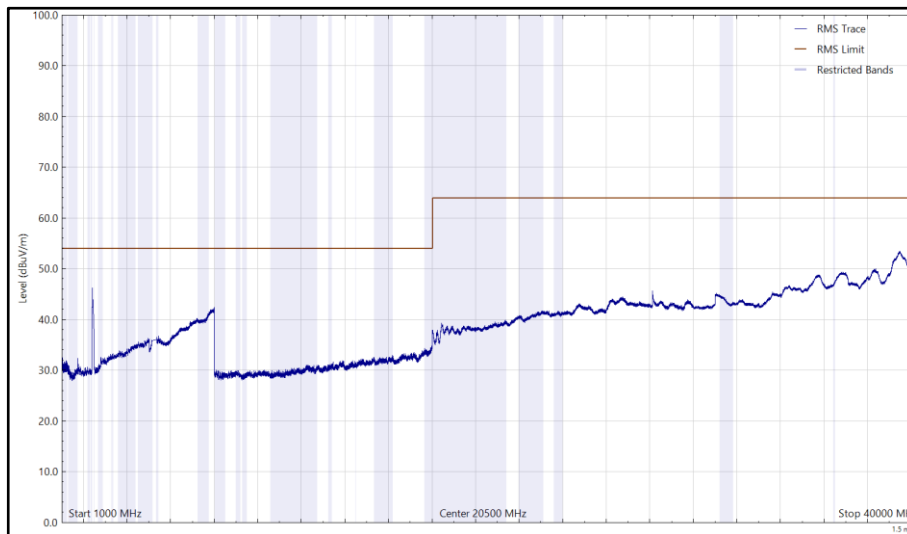
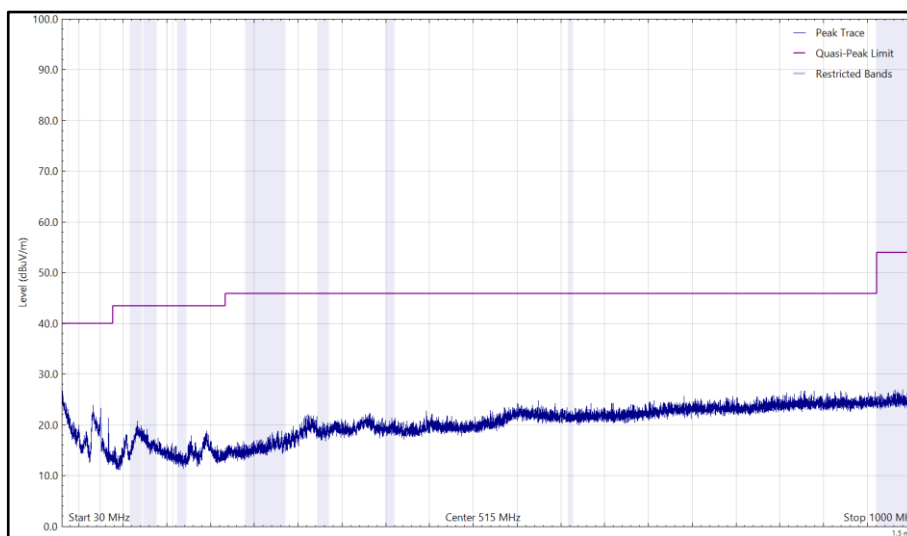

Figure 3 - 2417 MHz (CH2), HT20, CDD, Core 0 + Core 1 and U-NII-1 - 5200 MHz (CH40), HT20, CDD, Core 0 + Core 1, 1 GHz to 40 GHz, Horizontal (Peak)

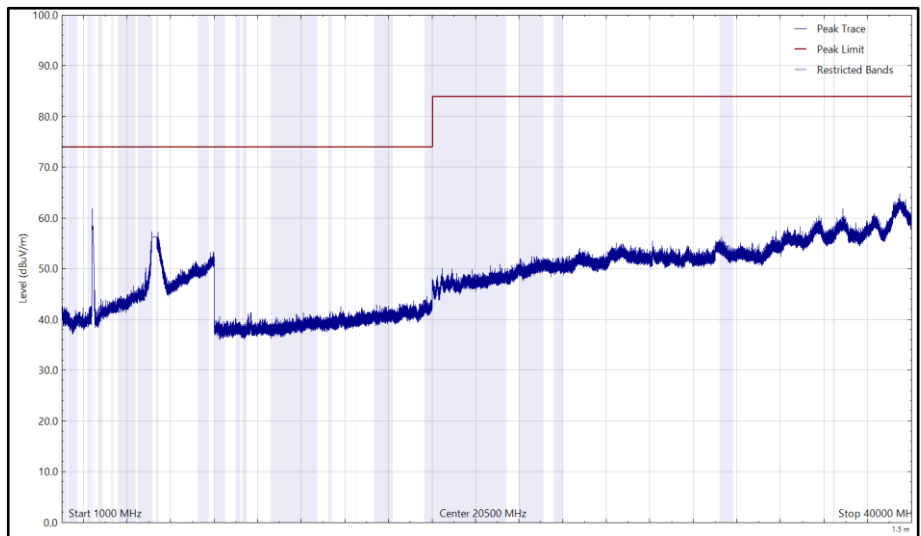



**Figure 4 - 2417 MHz (CH2), HT20, CDD, Core 0 + Core 1 and U-NII-1 - 5200 MHz (CH40), HT20, CDD, Core 0 + Core 1, 1 GHz to 40 GHz, Horizontal (rms)**



**Figure 5 - 2417 MHz (CH2), HT20, CDD, Core 0 + Core 1 and U-NII-1 - 5200 MHz (CH40), HT20, CDD, Core 0 + Core 1, 30 MHz to 1 GHz, Vertical (Peak)**



**Figure 6 - 2417 MHz (CH2), HT20, CDD, Core 0 + Core 1 and U-NII-1 - 5200 MHz (CH40), HT20, CDD, Core 0 + Core 1, 1 GHz to 40 GHz, Vertical (Peak)**

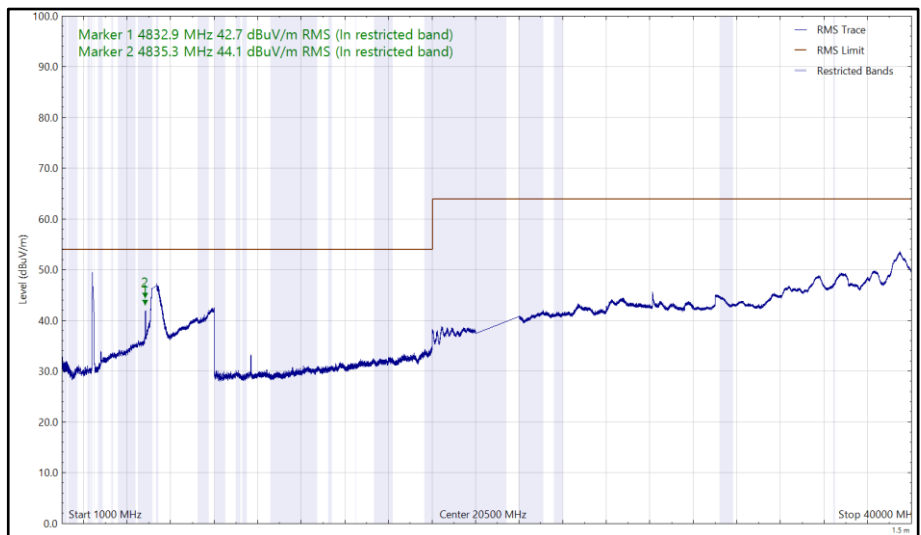

**Figure 7 - 2417 MHz (CH2), HT20, CDD, Core 0 + Core 1 and U-NII-1 - 5200 MHz (CH40), HT20, CDD, Core 0 + Core 1, 1 GHz to 40 GHz, Vertical (rms)**



Frequency (MHz)	Level (dBuV/m)	Limit (dBuV/m)	Margin (dB)	Detector	Angle (°)	Height (cm)	Polarisation
4900.047	56.7	74.0	-17.4	Peak	11	322	Vertical
4902.753	43.5	54.0	-10.5	rms	351	304	Vertical

**Table 6 - 2452 MHz (CH9), HT20, CDD, Core 0 + Core 1 and U-NII-2C - 5680 MHz (CH136), HT20, CDD, Core 0 + Core 1, 30 MHz to 40 GHz**

No other emissions found within 10 dB of the limit.

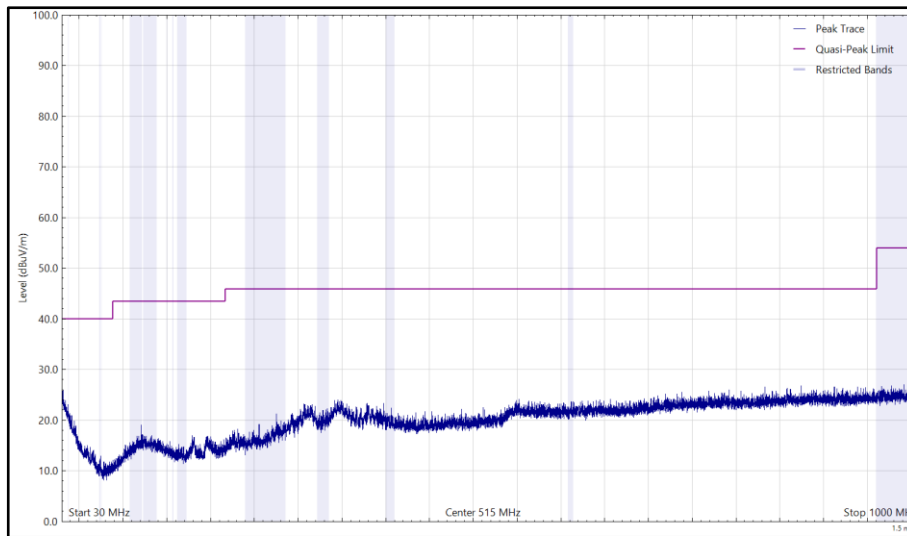

**Figure 8 - 2452 MHz (CH9), HT20, CDD, Core 0 + Core 1 and U-NII-2C - 5680 MHz (CH136), HT20, CDD, Core 0 + Core 1, 30 MHz to 1 GHz, Horizontal (Peak)**

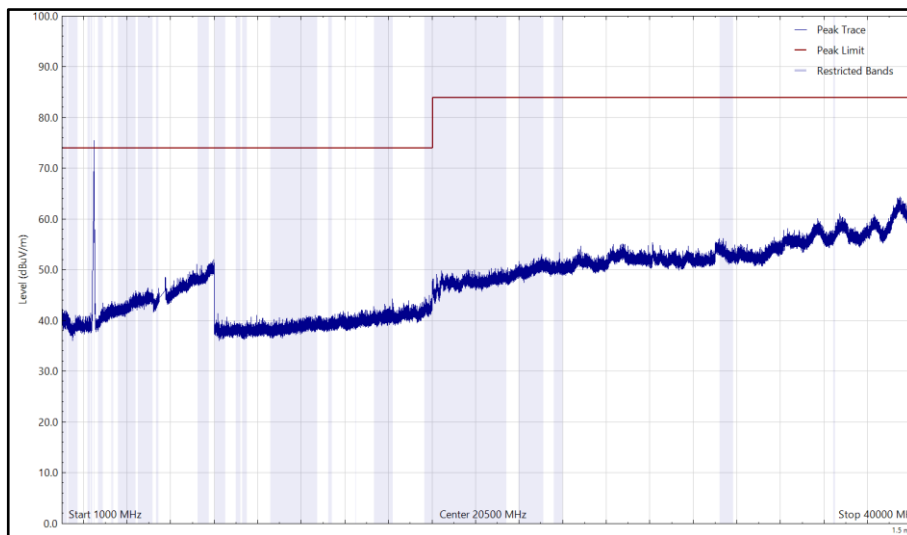

**Figure 9 - 2452 MHz (CH9), HT20, CDD, Core 0 + Core 1 and U-NII-2C - 5680 MHz (CH136), HT20, CDD, Core 0 + Core 1, 1 GHz to 40 GHz, Horizontal (Peak)**

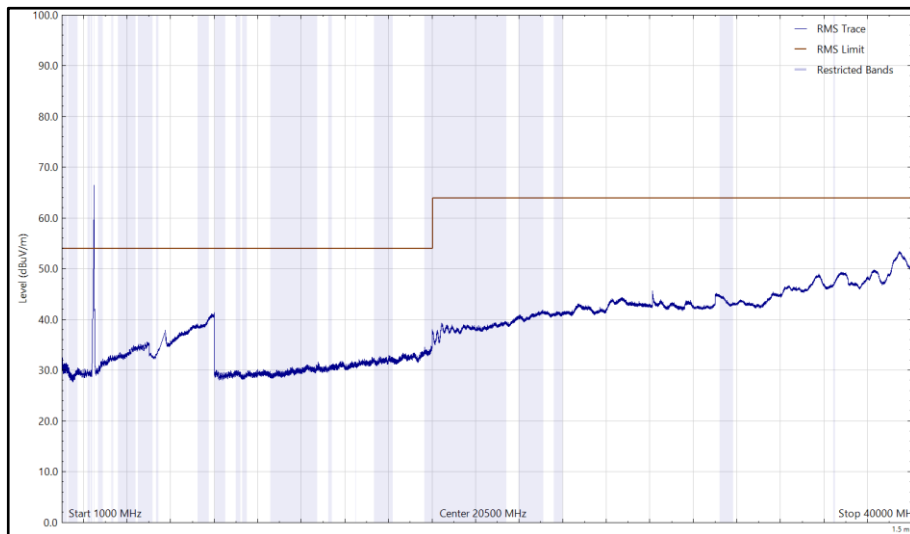

**Figure 10 - 2452 MHz (CH9), HT20, CDD, Core 0 + Core 1 and U-NII-2C - 5680 MHz (CH136), HT20, CDD, Core 0 + Core 1, 1 GHz to 40 GHz, Horizontal (rms)**

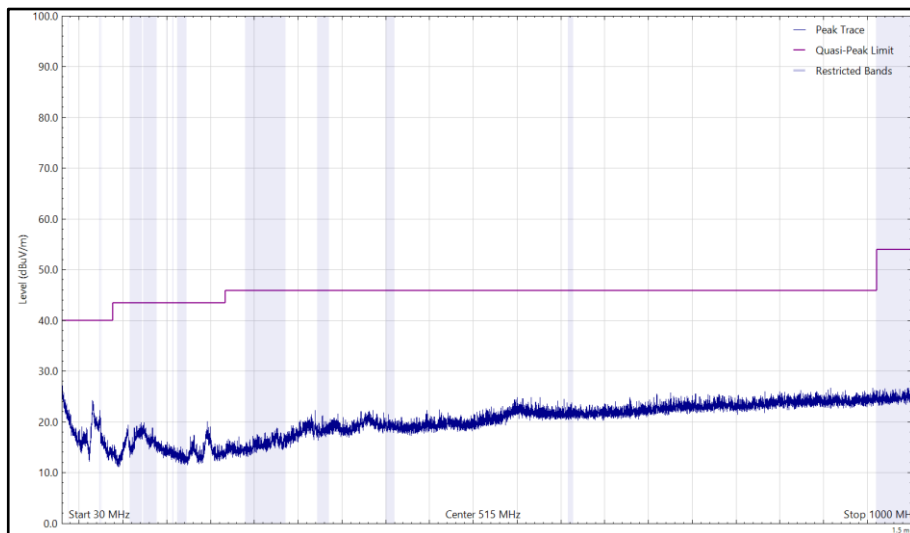

**Figure 11 - 2452 MHz (CH9), HT20, CDD, Core 0 + Core 1 and U-NII-2C - 5680 MHz (CH136), HT20, CDD, Core 0 + Core 1, 30 MHz to 1 GHz, Vertical (Peak)**

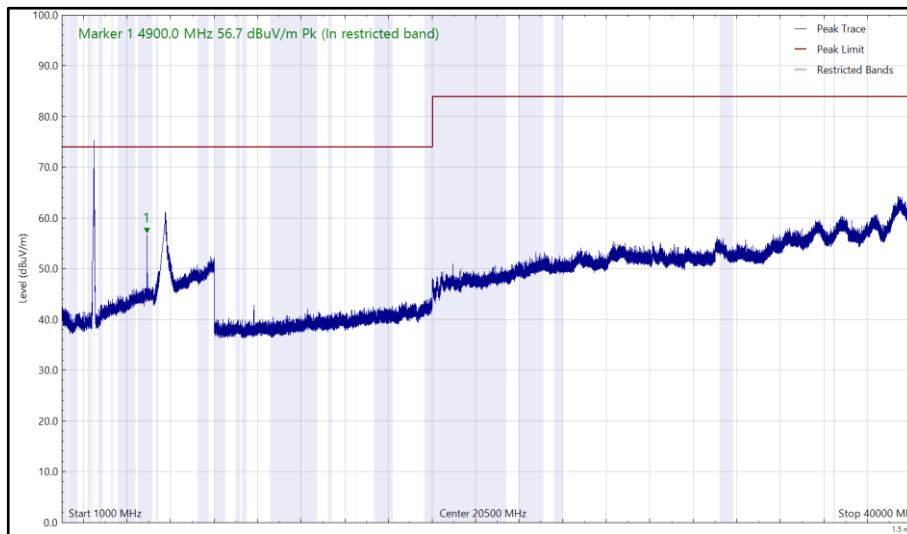

Figure 12 - 2452 MHz (CH9), HT20, CDD, Core 0 + Core 1 and U-NII-2C - 5680 MHz (CH136), HT20, CDD, Core 0 + Core 1, 1 GHz to 40 GHz, Vertical (Peak)

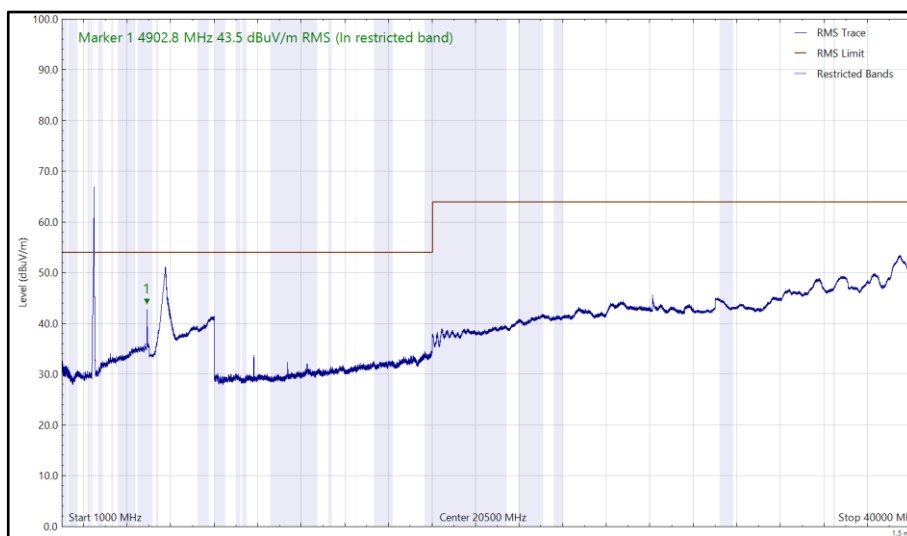

Figure 13 - 2452 MHz (CH9), HT20, CDD, Core 0 + Core 1 and U-NII-2C - 5680 MHz (CH136), HT20, CDD, Core 0 + Core 1, 1 GHz to 40 GHz, Vertical (rms)



CoTX - 2.4 GHz WLAN and 5 GHz WLAN and 2.4 GHz Bluetooth

Frequency (MHz)	Level (dBuV/m)	Limit (dBuV/m)	Margin (dB)	Detector	Angle (°)	Height (cm)	Polarisation
2539.503	66.6	74.0	-7.4	Peak	20	324	Vertical
2542.097	58.9	74.0	-15.1	Peak	303	400	Horizontal
4959.567	35.1	54.0	-18.9	CISPR Avg	359	100	Vertical

**Table 7 - 2417 MHz (CH2), HT20, CDD, Core 0 + Core 1 and 2480 MHz (CH78), DH5, ePA, Core 0, 30 MHz to 30 GHz**

No other emissions found within 10 dB of the limit.

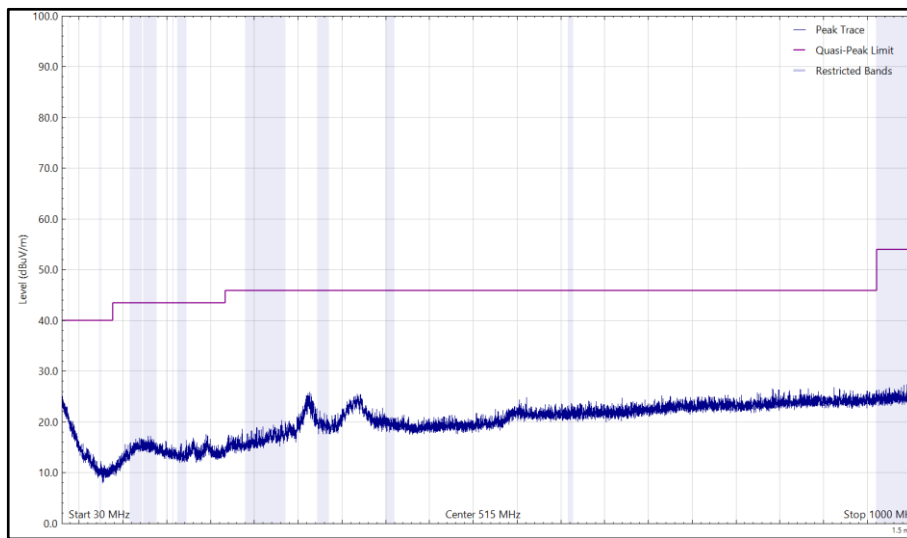

**Figure 14 - 2417 MHz (CH2), HT20, CDD, Core 0 + Core 1 and 2480 MHz (CH78), DH5, ePA, Core 0, 30 MHz to 1 GHz, Horizontal (Peak)**

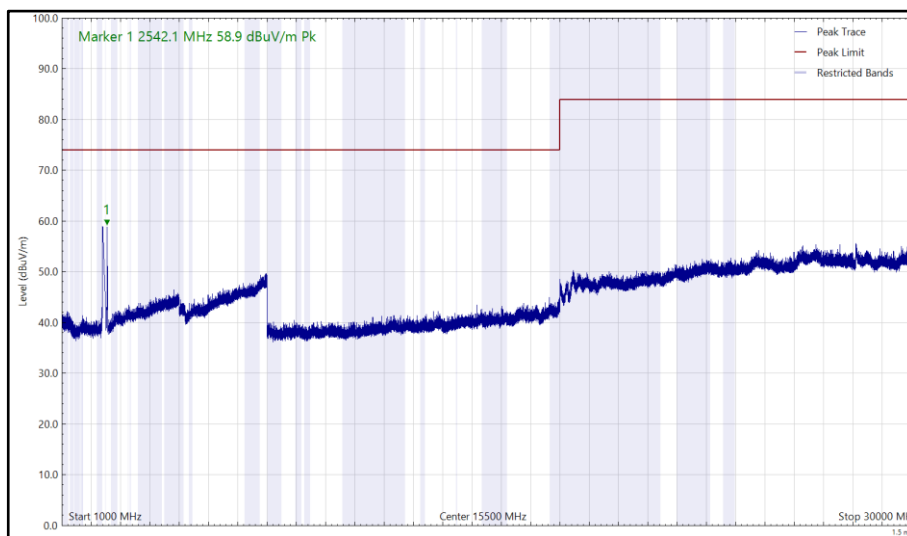

**Figure 15 - 2417 MHz (CH2), HT20, CDD, Core 0 + Core 1 and 2480 MHz (CH78), DH5, ePA, Core 0, 1 GHz to 30 GHz, Horizontal (Peak)**

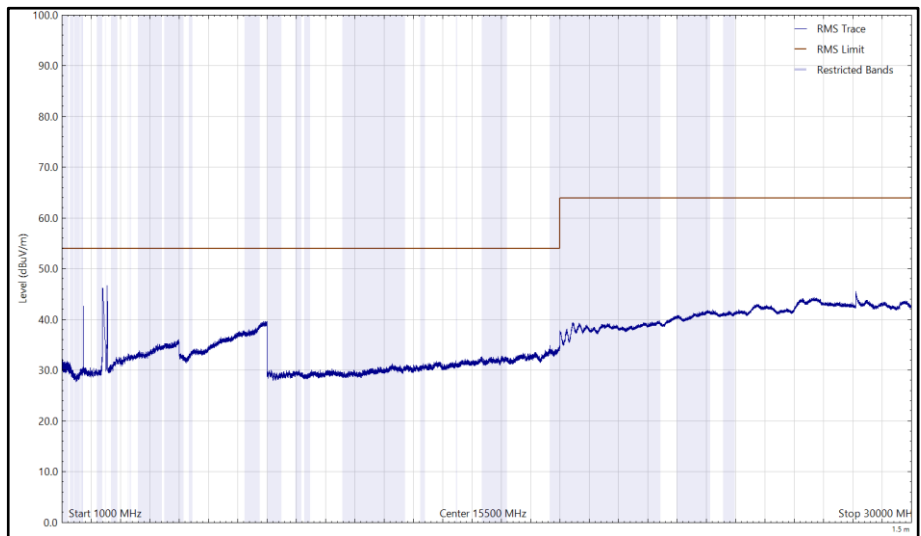

**Figure 16 - 2417 MHz (CH2), HT20, CDD, Core 0 + Core 1 and 2480 MHz (CH78), DH5, ePA, Core 0, 1 GHz to 30 GHz, Horizontal (rms)**

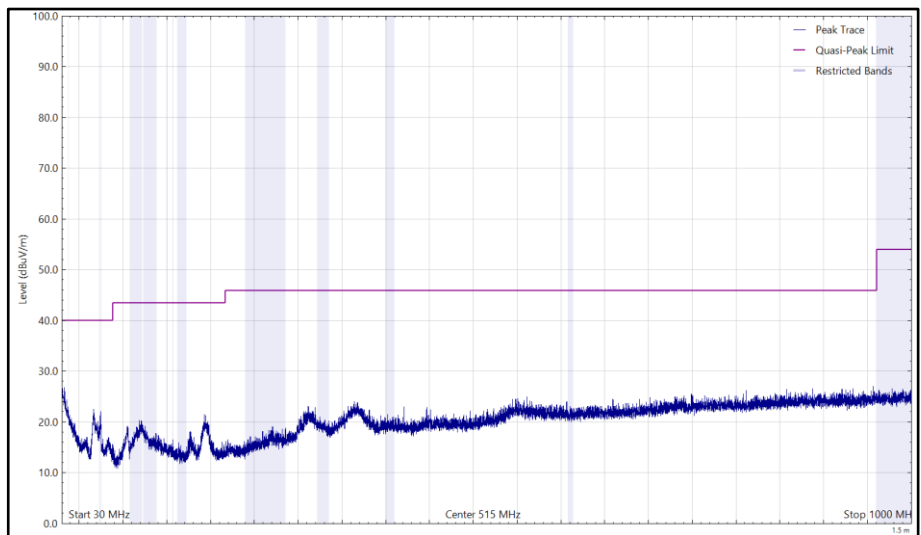

**Figure 17 - 2417 MHz (CH2), HT20, CDD, Core 0 + Core 1 and 2480 MHz (CH78), DH5, ePA, Core 0, 30 MHz to 1 GHz, Vertical (Peak)**

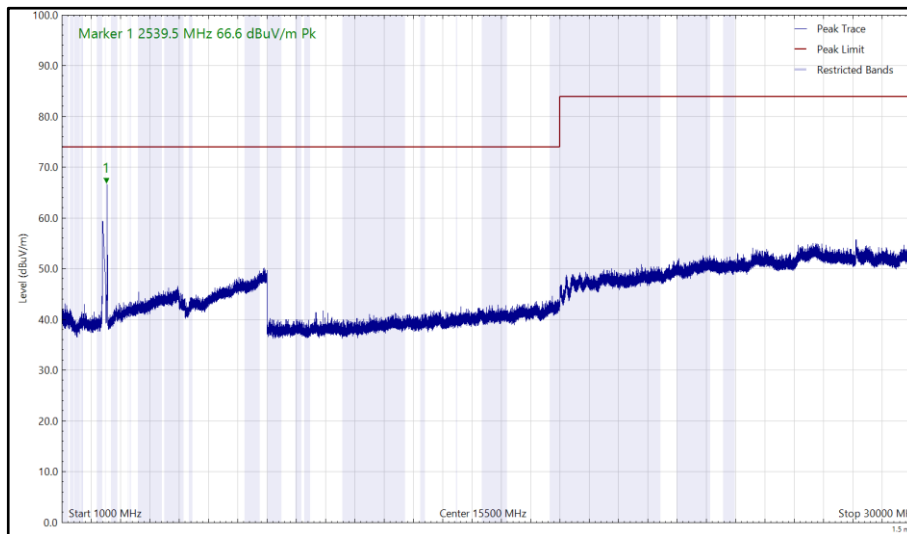

**Figure 18 - 2417 MHz (CH2), HT20, CDD, Core 0 + Core 1 and 2480 MHz (CH78), DH5, ePA, Core 0, 1 GHz to 30 GHz, Vertical (Peak)**

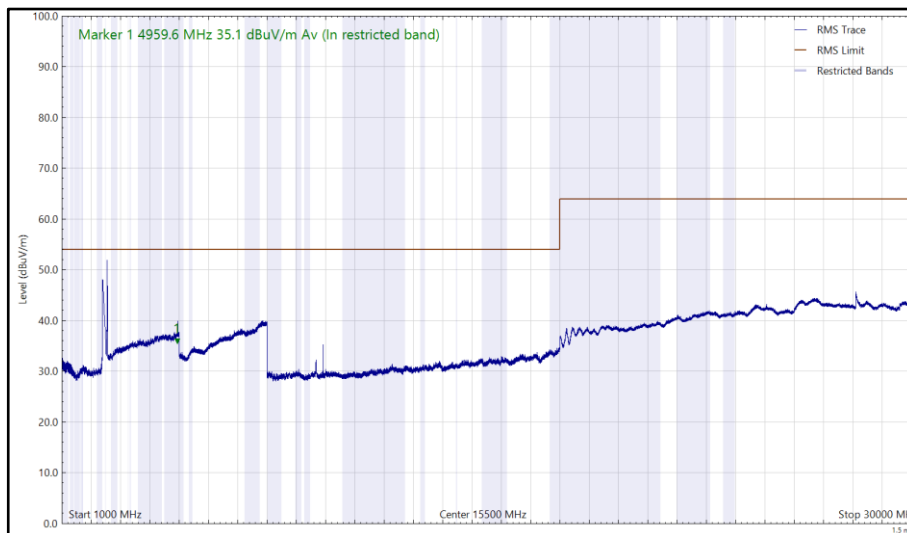

**Figure 19 - 2417 MHz (CH2), HT20, CDD, Core 0 + Core 1 and 2480 MHz (CH78), DH5, ePA, Core 0, 1 GHz to 30 GHz, Vertical (rms)**





Frequency (MHz)	Level (dBuV/m)	Limit (dBuV/m)	Margin (dB)	Detector	Angle (°)	Height (cm)	Polarisation
2352.471	38.4	54.0	-15.6	CISPR Avg	327	379	Horizontal
2354.726	65.3	74.0	-8.7	Peak	42	395	Vertical
4803.926	38.2	54.0	-15.8	CISPR Avg	346	106	Vertical

**Table 8 - 2452 MHz (CH9), HT20, CDD, Core 0 + Core 1 and 2402 MHz (CH0), DH5, ePA, Core 0, 30 MHz to 30 GHz**

No other emissions found within 10 dB of the limit.

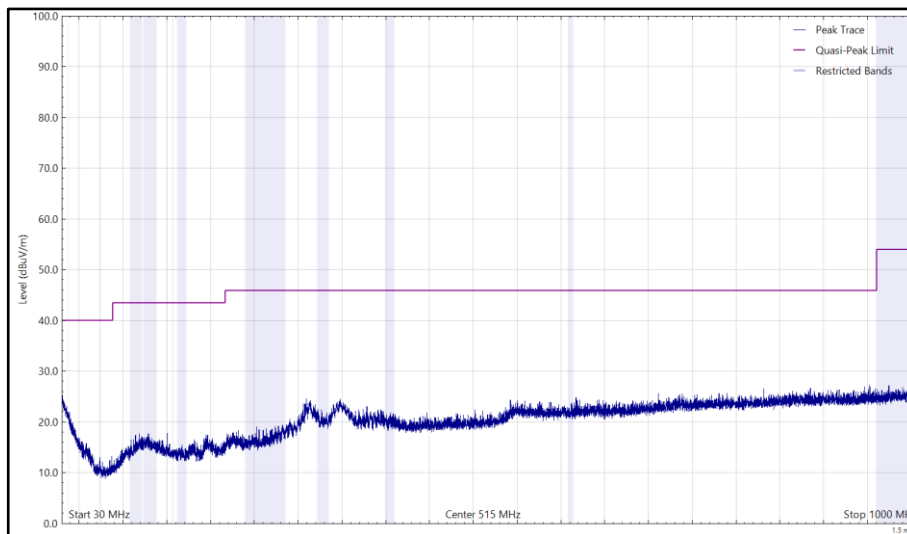

**Figure 20 - 2452 MHz (CH9), HT20, CDD, Core 0 + Core 1 and 2402 MHz (CH0), DH5, ePA, Core 0, 30 MHz to 1 GHz, Horizontal (Peak)**

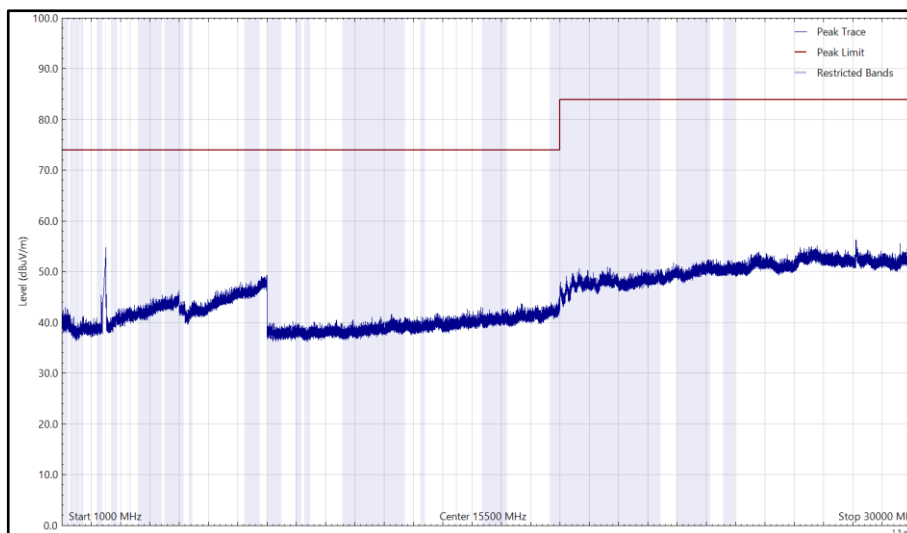

**Figure 21 - 2452 MHz (CH9), HT20, CDD, Core 0 + Core 1 and 2402 MHz (CH0), DH5, ePA, Core 0, 1 GHz to 30 GHz, Horizontal (Peak)**

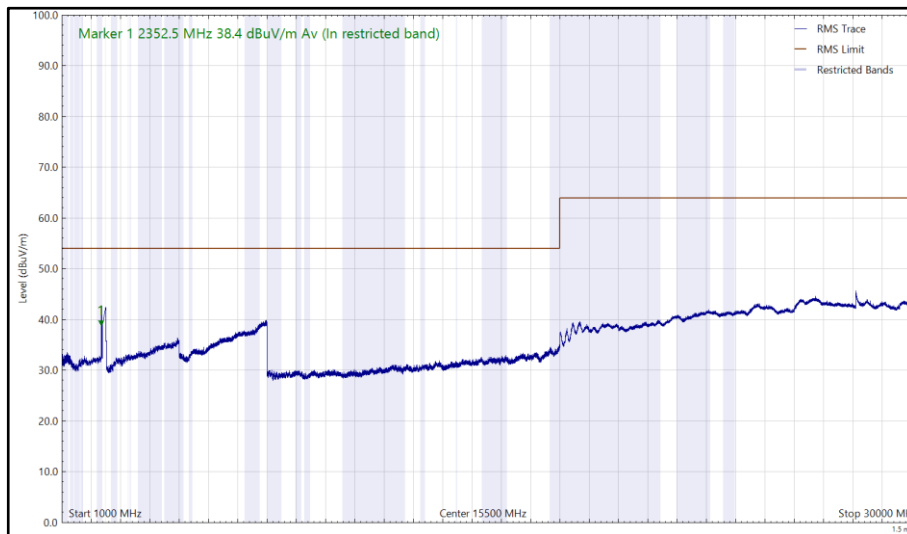

Figure 22 - 2452 MHz (CH9), HT20, CDD, Core 0 + Core 1 and 2402 MHz (CH0), DH5, ePA, Core 0, 1 GHz to 30 GHz, Horizontal (rms)

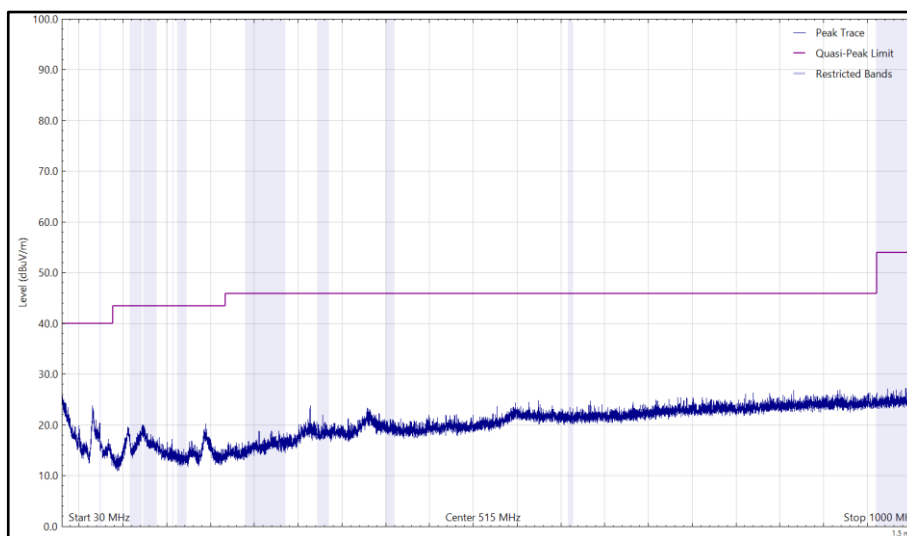

Figure 23 - 2452 MHz (CH9), HT20, CDD, Core 0 + Core 1 and 2402 MHz (CH0), DH5, ePA, Core 0, 30 MHz to 1 GHz, Vertical (Peak)

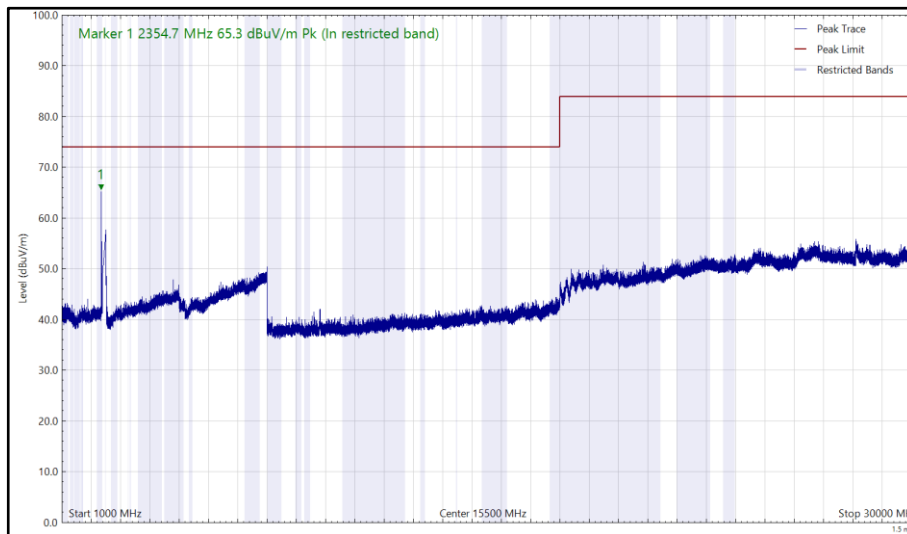

Figure 24 - 2452 MHz (CH9), HT20, CDD, Core 0 + Core 1 and 2402 MHz (CH0), DH5, ePA, Core 0, 1 GHz to 30 GHz, Vertical (Peak)

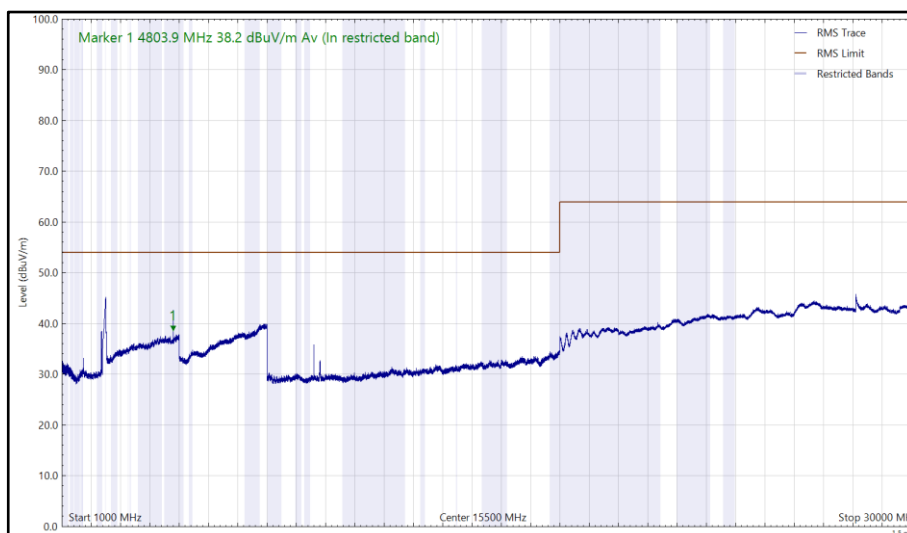

Figure 25 - 2452 MHz (CH9), HT20, CDD, Core 0 + Core 1 and 2402 MHz (CH0), DH5, ePA, Core 0, 1 GHz to 30 GHz, Vertical (rms)



Frequency (MHz)	Level (dBuV/m)	Limit (dBuV/m)	Margin (dB)	Detector	Angle (°)	Height (cm)	Polarisation
4959.717	45.5	54.0	-8.5	CISPR Avg	350	286	Vertical

**Table 9 - U-NII-1 - 5200 MHz (CH40), HT20, CDD, Core 0 + Core 1 and 2480 MHz (CH78), DH5, ePA, Core 0, 30 MHz to 40 GHz**

No other emissions found within 10 dB of the limit.

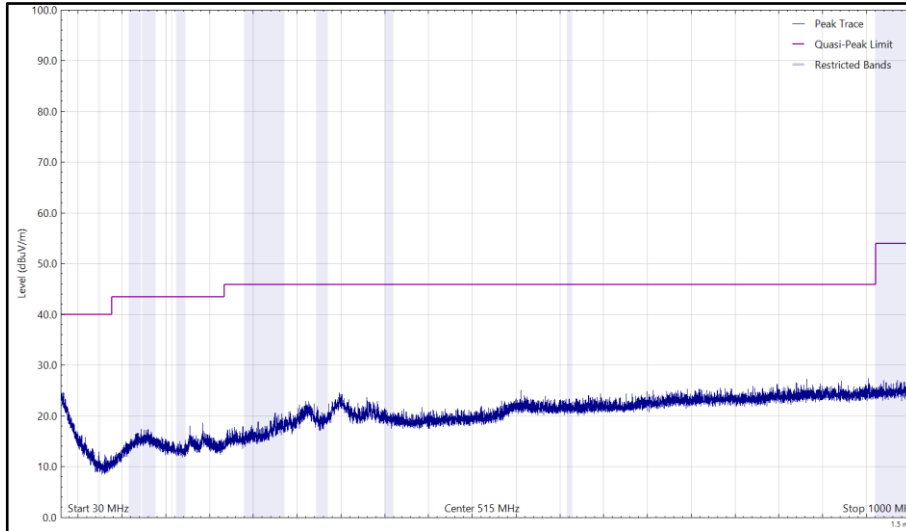

**Figure 26 - U-NII-1 - 5200 MHz (CH40), HT20, CDD, Core 0 + Core 1 and 2480 MHz (CH78), DH5, ePA, Core 0, 30 MHz to 1 GHz, Horizontal (Peak)**

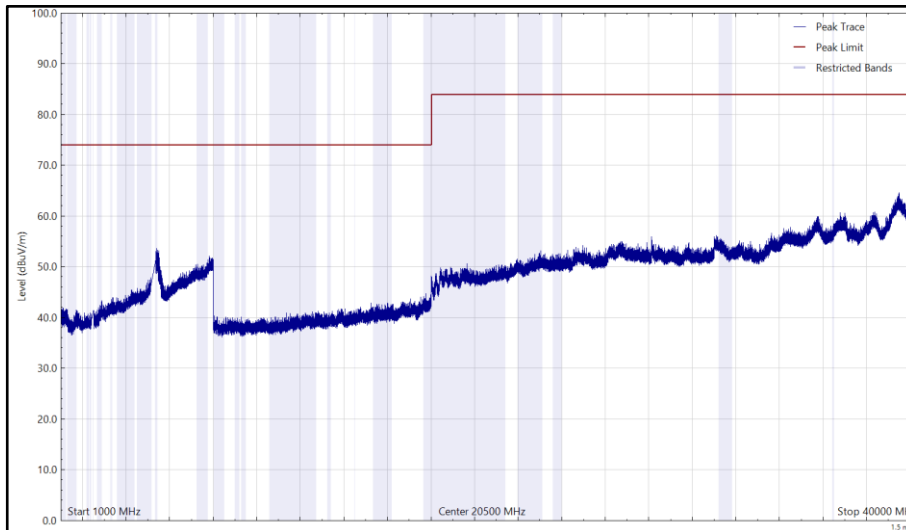

**Figure 27 - U-NII-1 - 5200 MHz (CH40), HT20, CDD, Core 0 + Core 1 and 2480 MHz (CH78), DH5, ePA, Core 0, 1 GHz to 40 GHz, Horizontal (Peak)**

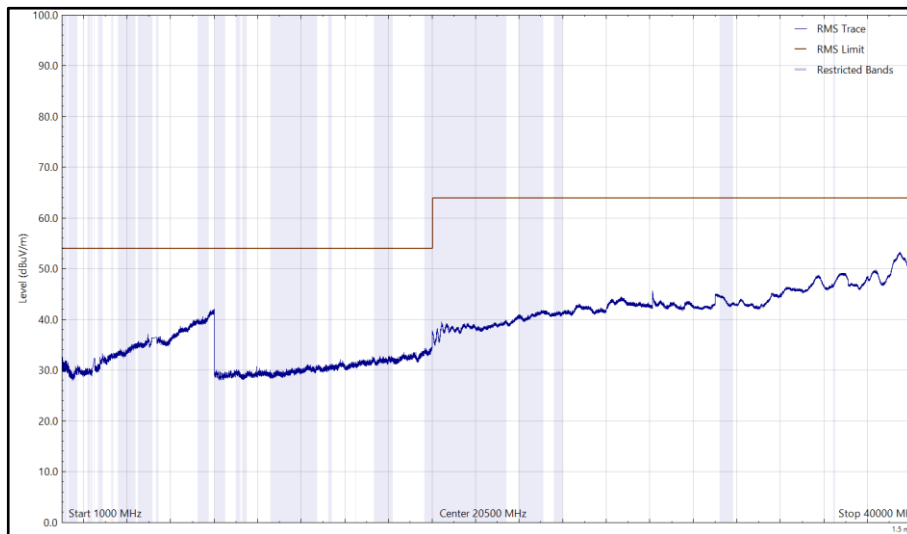

**Figure 28 - U-NII-1 - 5200 MHz (CH40), HT20, CDD, Core 0 + Core 1 and 2480 MHz (CH78), DH5, ePA, Core 0, 1 GHz to 40 GHz, Horizontal (rms)**

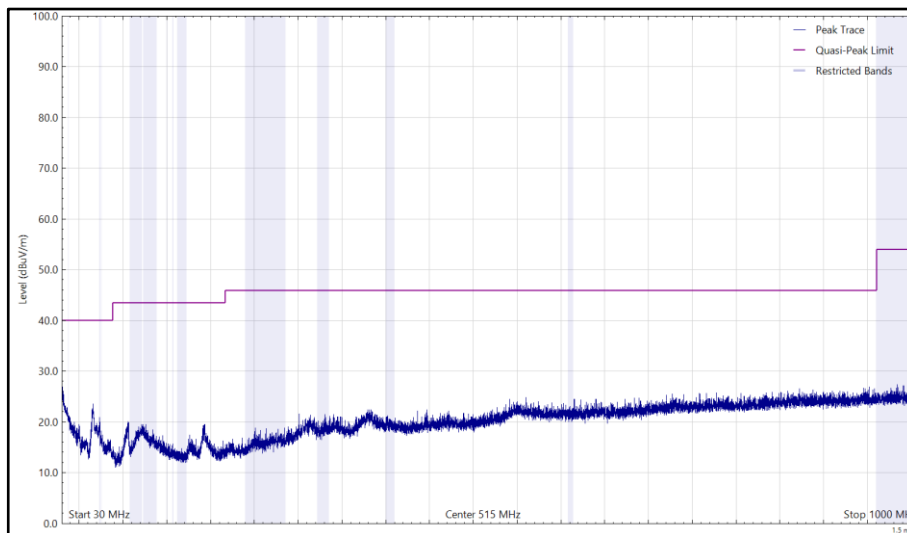

**Figure 29 - U-NII-1 - 5200 MHz (CH40), HT20, CDD, Core 0 + Core 1 and 2480 MHz (CH78), DH5, ePA, Core 0, 30 MHz to 1 GHz, Vertical (Peak)**

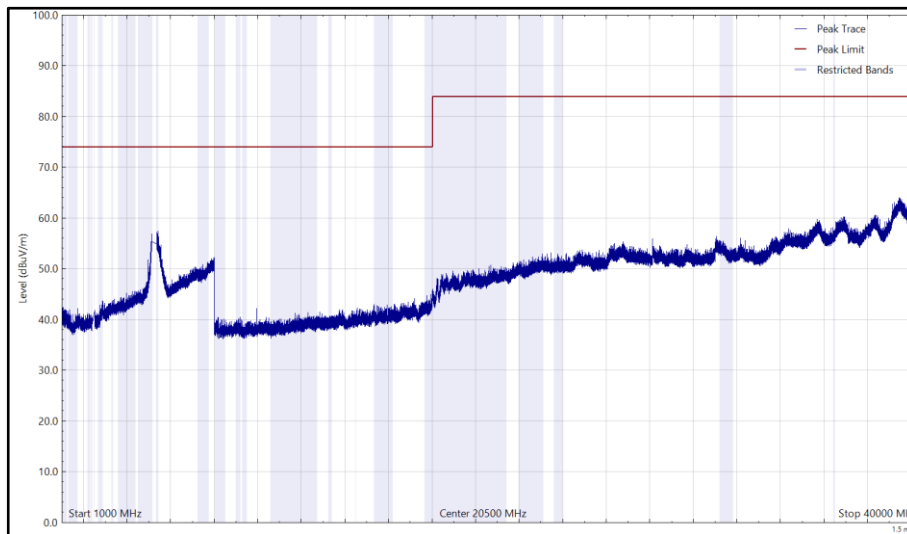

**Figure 30 - U-NII-1 - 5200 MHz (CH40), HT20, CDD, Core 0 + Core 1 and 2480 MHz (CH78), DH5, ePA, Core 0, 1 GHz to 40 GHz, Vertical (Peak)**

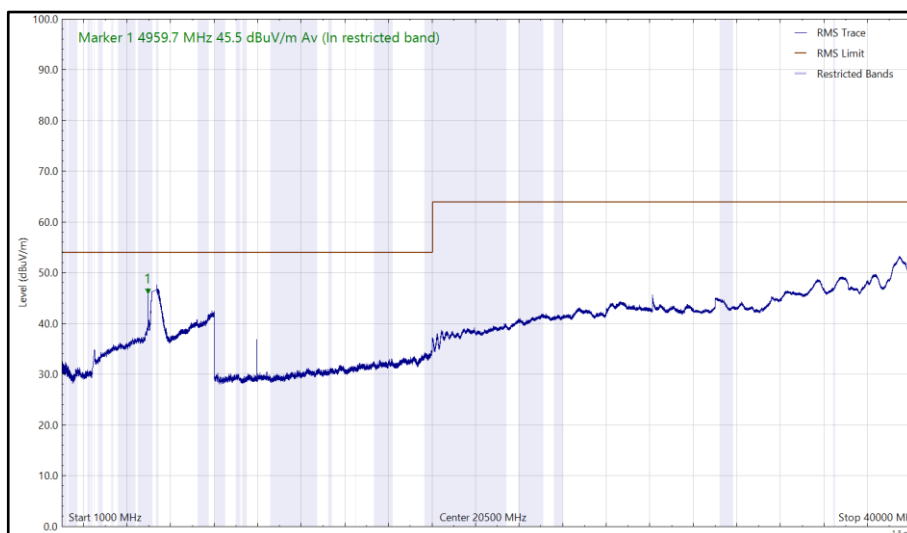

**Figure 31 - U-NII-1 - 5200 MHz (CH40), HT20, CDD, Core 0 + Core 1 and 2480 MHz (CH78), DH5, ePA, Core 0, 1 GHz to 40 GHz, Vertical (rms)**



Frequency (MHz)	Level (dBuV/m)	Limit (dBuV/m)	Margin (dB)	Detector	Angle (°)	Height (cm)	Polarisation
4803.636	43.9	54.0	-10.1	CISPR Avg	347	290	Vertical

**Table 10 - U-NII-2C - 5680 MHz (CH136), HT20, CDD, Core 0 + Core 1 and 2402 MHz (CH0), DH5, ePA, Core 0, 30 MHz to 40 GHz**

No other emissions found within 10 dB of the limit.

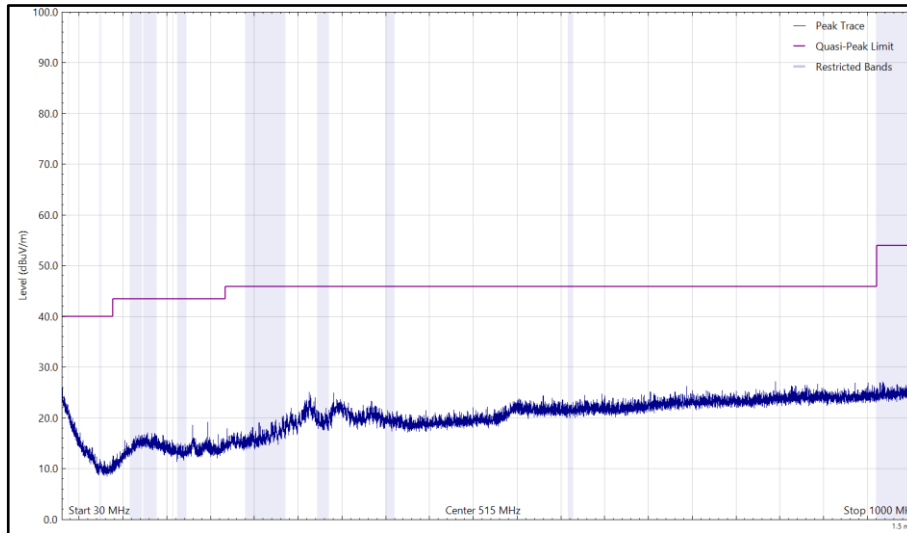

**Figure 32 - U-NII-2C - 5680 MHz (CH136), HT20, CDD, Core 0 + Core 1 and 2402 MHz (CH0), DH5, ePA, Core 0, 30 MHz to 1 GHz, Horizontal (Peak)**

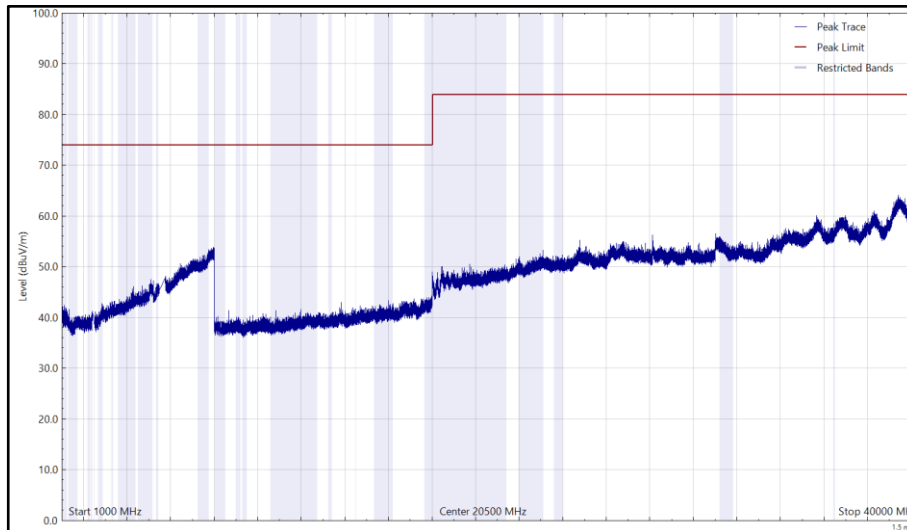

**Figure 33 - U-NII-2C - 5680 MHz (CH136), HT20, CDD, Core 0 + Core 1 and 2402 MHz (CH0), DH5, ePA, Core 0, 1 GHz to 40 GHz, Horizontal (Peak)**

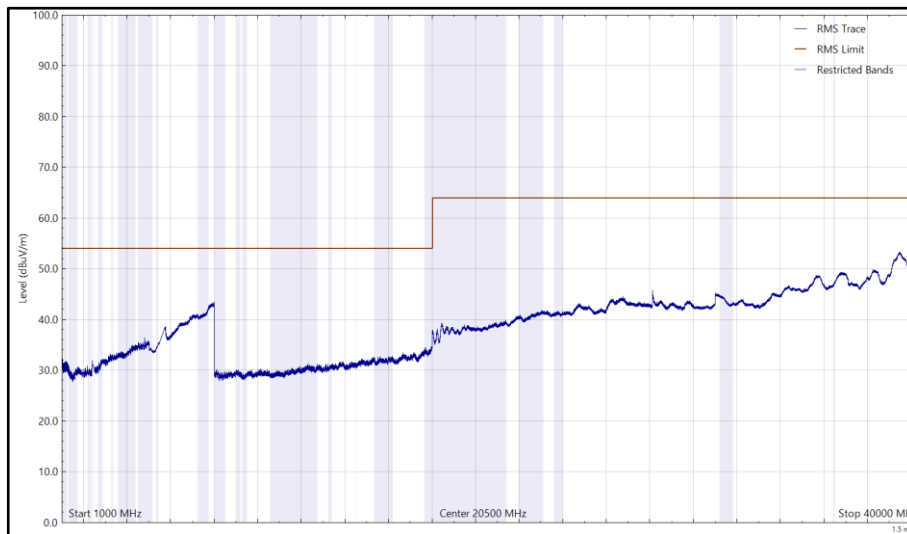

**Figure 34 - U-NII-2C - 5680 MHz (CH136), HT20, CDD, Core 0 + Core 1 and 2402 MHz (CH0), DH5, ePA, Core 0, 1 GHz to 40 GHz, Horizontal (rms)**

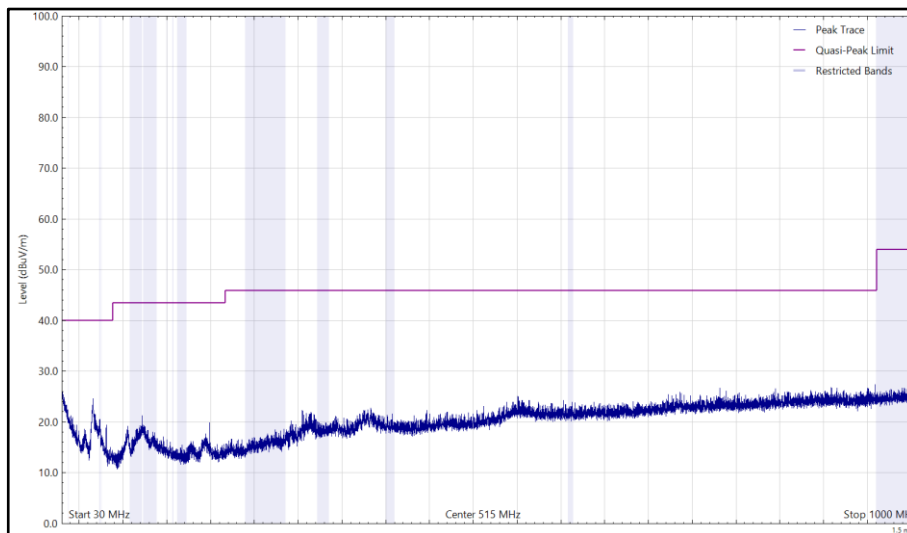

**Figure 35 - U-NII-2C - 5680 MHz (CH136), HT20, CDD, Core 0 + Core 1 and 2402 MHz (CH0), DH5, ePA, Core 0, 30 MHz to 1 GHz, Vertical (Peak)**



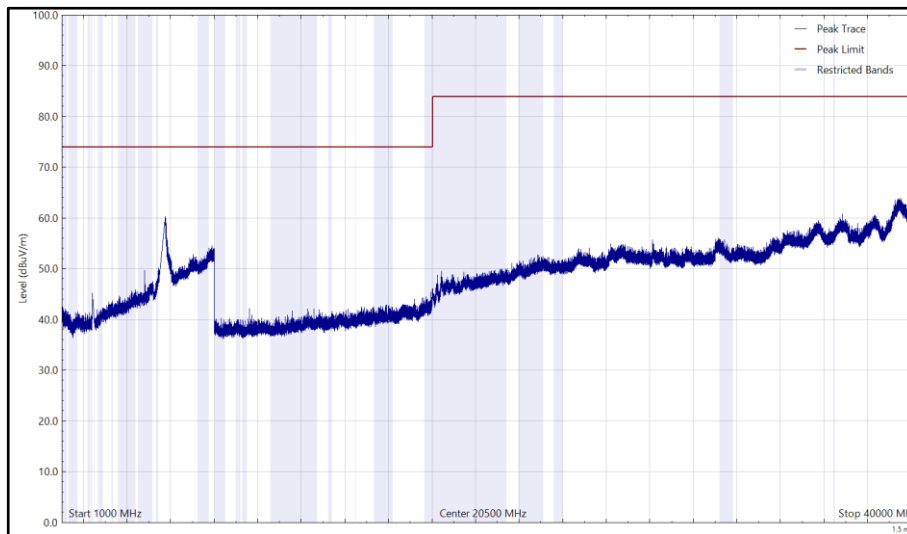

Figure 36 - U-NII-2C - 5680 MHz (CH136), HT20, CDD, Core 0 + Core 1 and 2402 MHz (CH0), DH5, ePA, Core 0, 1 GHz to 40 GHz, Vertical (Peak)

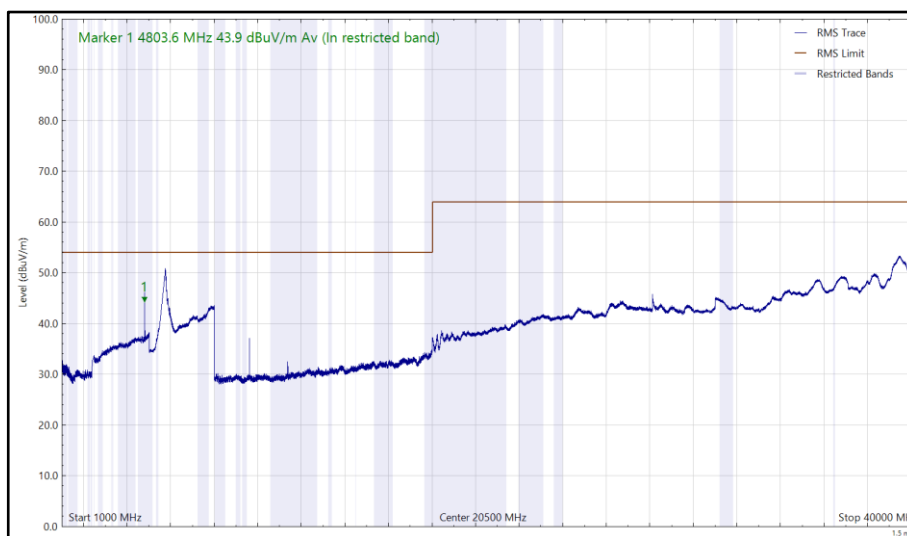

Figure 37 - U-NII-2C - 5680 MHz (CH136), HT20, CDD, Core 0 + Core 1 and 2402 MHz (CH0), DH5, ePA, Core 0, 1 GHz to 40 GHz, Vertical (rms)



Limit Clause

The least stringent limit from the applicable rule parts was used to determine compliance for Radiated Emissions testing of multiple transmission sources.

Specification and Clause	Limit
FCC Part 15.247 (d)	-20 dBc
FCC Part 15.407 (b)	-27 dBm (EIRP) / 68.2 dBµV/m at 3 m
FCC Part 15.209 (Within restricted bands listed in 15.205)	Peak: 74 dBµV/m at 3 m Average 54 dBµV/m at 3 m
ISED RSS-247, Clause 5.5	-20 dBc
ISED RSS-247, Clause 6.2	-27 dBm (EIRP) / 68.2 dBµV/m at 3 m
ISED RSS-GEN, Clause 8.9 (Within restricted bands listed in clause 8.8)	Peak: 74 dBµV/m at 3 m Average 54 dBµV/m at 3 m

**Table 11 - Limit Table**



### 2.1.8 Test Location and Test Equipment Used

This test was carried out in EMC Chamber 5.

Instrument	Manufacturer	Type No	TE No	Calibration Period (months)	Calibration Due
Screened Room (5)	Rainford	Rainford	1545	36	23-Jan-2021
Turntable Controller	Inn-Co GmbH	CO 1000	1606	-	TU
Multimeter	Iso-tech	IDM101	2417	12	11-Nov-2020
Antenna with permanent attenuator (Bilog)	Chase	CBL6143	2904	24	30-Sep-2021
Tilt Antenna Mast	Maturo GmbH	TAM 4.0-P	4811	-	TU
Double Ridge Broadband Horn Antenna	Schwarzbeck	BBHA 9120 B	4848	12	10-Mar-2021
Band Reject Filter - 2.425 GHz	Wainwright	WRCGV14-2390-2400-2450-2460-50SS	5067	12	01-Oct-2020
Band Reject Filter - 2.4585 GHz	Wainwright	WRCGV14-2423.5-2433.5-2483.5-2493.5-50SS	5069	12	01-Oct-2020
Band Reject Filter - 5.22 GHz	Wainwright	WRCJV12-5120-5150-5290-5320-50SS	5072	12	24-Sep-2020
Band Reject Filter - 5.690 GHz	Wainwright	WRCJV8-5635-5670-5710-5745-50SS	5080	12	25-Sep-2020
EmX Emissions Software	TUV SUD	EmX	5125	-	Software
DRG Horn Antenna (7.5-18GHz)	Schwarzbeck	HWRD750	5216	12	10-Mar-2021
Horn Antenna (15-40GHz)	Schwarzbeck	BBHA 9170	5217	12	12-Oct-2020
Preamplifier (30dB 1GHz to 18GHz)	Schwarzbeck	BBV 9718 C	5261	12	07-Apr-2021
1m -SMA Cable	Junkosha	MWX221-01000AMSAMS/A	5513	12	01-Apr-2021
1m -SMA Cable	Junkosha	MWX221-01000AMSAMS/A	5515	12	01-Apr-2021
2m SMA Cable	Junkosha	MWX221-02000AMSAMS/A	5517	12	01-Apr-2021
8m N-Type Cable	Junkosha	MWX221-08000NMSNMS/B	5520	12	24-Mar-2021
2 m K Type Cable	Junkosha	MWX241-02000KMSKMS/A	5523	12	03-Apr-2021
EMI Test Receiver	Rohde & Schwarz	ESW44	5527	12	06-Feb-2021
3 GHz High pass Filter	Wainwright	WHKX12-2580-3000-18000-80SS	5548	12	05-May-2021
7 GHz High Pass Filter	Wainwright	WHKX12-5850-6800-18000-80SS	5549	12	23-May-2021
8 - 18 GHz Amplifier	Wright Technologies	APS06-0061	5596	12	25-Aug-2021

Table 12

TU – Traceability ~Unscheduled



### 3 Measurement Uncertainty

For a 95% confidence level, the measurement uncertainties for defined systems are:

Test Name	Measurement Uncertainty
Radiated Spurious Emissions (Simultaneous Transmission)	30 MHz to 1 GHz: $\pm 5.2$ dB 1 GHz to 40 GHz: $\pm 6.3$ dB

**Table 13**

#### Measurement Uncertainty Decision Rule

Determination of conformity with the specification limits is based on the decision rule according to IEC Guide 115: 2007, clause 4.4.3 and 4.5.1.