

Report on the FCC and ISED Testing of the: Apple Inc. Model: A2159

In accordance with FCC 47 CFR Part 15B and ICES-003

Prepared for: Apple Inc.
One Apple Park Way
Cupertino
California 95014
USA



**Add value.
Inspire trust.**

FCC ID: BCGA2159

IC: 579C-A2159

COMMERCIAL-IN-CONFIDENCE

Document Number: 75945152-09 | Issue: 02

SIGNATURE

NAME	JOB TITLE	RESPONSIBLE FOR	ISSUE DATE
Andy Lawson	Senior EMC Engineer	Authorised Signatory	01 July 2019

Signatures in this approval box have checked this document in line with the requirements of TÜV SÜD document control rules.

ENGINEERING STATEMENT

The measurements shown in this report were made in accordance with the procedures described on test pages. All reported testing was carried out on a sample equipment to demonstrate limited compliance with FCC 47 CFR Part 15B and ICES-003. The sample tested was found to comply with the requirements defined in the applied rules.

SIGNATURE

NAME	JOB TITLE	RESPONSIBLE FOR	ISSUE DATE
Mohammad Malik	Shift Technician	Testing	01 July 2019

FCC Accreditation

90987 Octagon House, Fareham Test Laboratory

Industry Canada Accreditation

IC2932B-1 Octagon House, Fareham Test Laboratory

EXECUTIVE SUMMARY

A sample of this product was tested and found to be compliant with FCC 47 CFR Part 15B and ICES-003: 2017 and 2016.



DISCLAIMER AND COPYRIGHT

This non-binding report has been prepared by TÜV SÜD with all reasonable skill and care. The document is confidential to the potential Client and TÜV SÜD. No part of this document may be reproduced without the prior written approval of TÜV SÜD. © 2019 TÜV SÜD. This report relates only to the actual item/items tested.

ACCREDITATION

Our UKAS Accreditation does not cover opinions and interpretations and any expressed are outside the scope of our UKAS Accreditation. Results of tests not covered by our UKAS Accreditation Schedule are marked NUA (Not UKAS Accredited).

TÜV SÜD
is a trading name of TÜV SÜD Ltd
Registered in Scotland at East Kilbride,
Glasgow G75 0QF, United Kingdom
Registered number: SC215164

TÜV SÜD Ltd is a
TÜV SÜD Group Company

Phone: +44 (0) 1489 558100
Fax: +44 (0) 1489 558101
www.tuv-sud.co.uk

TÜV SÜD
Octagon House
Concorde Way
Fareham
Hampshire PO15 5RL
United Kingdom



Contents

1	Report Summary	2
1.1	Report Modification Record.....	2
1.2	Introduction.....	2
1.3	Brief Summary of Results	3
1.4	Product Information	4
1.5	Deviations from the Standard.....	4
1.6	EUT Modification Record	4
1.7	Test Location	5
2	Test Details	6
2.1	Conducted Disturbance at Mains Terminals	6
2.2	Radiated Disturbance.....	10
3	Measurement Uncertainty	19



1 Report Summary

1.1 Report Modification Record

Alterations and additions to this report will be issued to the holders of each copy in the form of a complete document.

Issue	Description of Change	Date of Issue
1	First Issue	01 May 2019
2	Removed Set-Up Photos	01 July 2019

Table 1

1.2 Introduction

Applicant	Apple Inc.
Manufacturer	Apple Inc.
Model Number(s)	A2159
Serial Number(s)	C02Y4006L59F
Hardware Version(s)	REV 1.0
Software Version(s)	18F65
Number of Samples Tested	1
Test Specification/Issue/Date	FCC 47 CFR Part 15B and ICES-003: 2017 and 2016
Order Number	0540175066
Date	21-February-2019
Date of Receipt of EUT	06-February-2019
Start of Test	03-March-2019
Finish of Test	05-March-2019
Name of Engineer(s)	Mohammad Malik
Related Document(s)	ANSI C63.4: 2014



1.3 Brief Summary of Results

A brief summary of the tests carried out in accordance with FCC 47 CFR Part 15B and ICES-003 is shown below.

Section	Specification Clause	Test Description	Result	Comments/Base Standard
Configuration and Mode: TX idle				
2.1	15.107 and 6.1	Conducted Disturbance at Mains Terminals	Pass	ANSI C63.4: 2014
2.2	15.109 and 6.2	Radiated Disturbance	Pass	ANSI C63.4: 2014

Table 2



1.4 Product Information

1.4.1 Technical Description

The Equipment Under Test (EUT) was a Laptop computer with Bluetooth, Bluetooth Low Energy and 802.11 a/b/g/n/ac capabilities in the 2.4 GHz and 5.0 GHz bands.

1.4.2 EUT Configuration and Rationale for Radiated Spurious Emissions

The EUT was powered and charging from 120V, 60Hz via its USB type C power adaptor.

The device's internal battery was discharged prior to testing.

The display setting on the device was set to maximum brightness, and the device was configured to ensure that the display remained active throughout testing.

The spare USB type C port on the device, was connected via ethernet to another Laptop computer located outside the test chamber that was used to remotely control the unit.

A set of wired Ear Pods were connected to the EUT

All transmitters were disabled during this testing.

1.5 Deviations from the Standard

No deviations from the applicable test standard were made during testing.

1.6 EUT Modification Record

The table below details modifications made to the EUT during the test programme. The modifications incorporated during each test are recorded on the appropriate test pages.

Modification State	Description of Modification still fitted to EUT	Modification Fitted By	Date Modification Fitted
Serial Number: C02Y4006L59F			
0	As supplied by the customer	Not Applicable	Not Applicable

Table 3



1.7 Test Location

TÜV SÜD conducted the following tests at our Fareham Test Laboratory.

Test Name	Name of Engineer(s)	Accreditation
Configuration and Mode: TX idle		
Conducted Disturbance at Mains Terminals	Mohammad Malik	UKAS
Radiated Disturbance	Mohammad Malik	UKAS

Table 4

Office Address:

Octagon House
Concorde Way
Segensworth North
Fareham
Hampshire
PO15 5RL
United Kingdom

2 Test Details

2.1 Conducted Disturbance at Mains Terminals

2.1.1 Specification Reference

FCC 47 CFR Part 15B and ICES-003, Clause 15.107 and 6.1

2.1.2 Equipment Under Test and Modification State

A2159, S/N: C02Y4006L59F - Modification State 0

2.1.3 Date of Test

03-March-2019

2.1.4 Test Method

The EUT was placed on a non-conductive table 0.8m above a reference ground plane and 0.4m away from a vertical coupling plane

All power was connected to the EUT through an Artificial Mains Network (AMN). Conducted disturbance voltage measurements on mains lines were made at the output of the AMN. The AMN was placed 0.8m from the boundary of the EUT and bonded to the reference ground plane.

2.1.5 Example Calculation

Quasi-Peak level (dB μ V) = Receiver level (dB μ V) + Correction Factor (dB)
Margin (dB) = Limit (dB μ V) – Quasi-Peak level (dB μ V)

CISPR Average level (dB μ V) = Receiver level (dB μ V) + Correction Factor (dB)
Margin (dB) = Limit (dB μ V) – CISPR Average level (dB μ V)

2.1.6 Test Setup Diagram

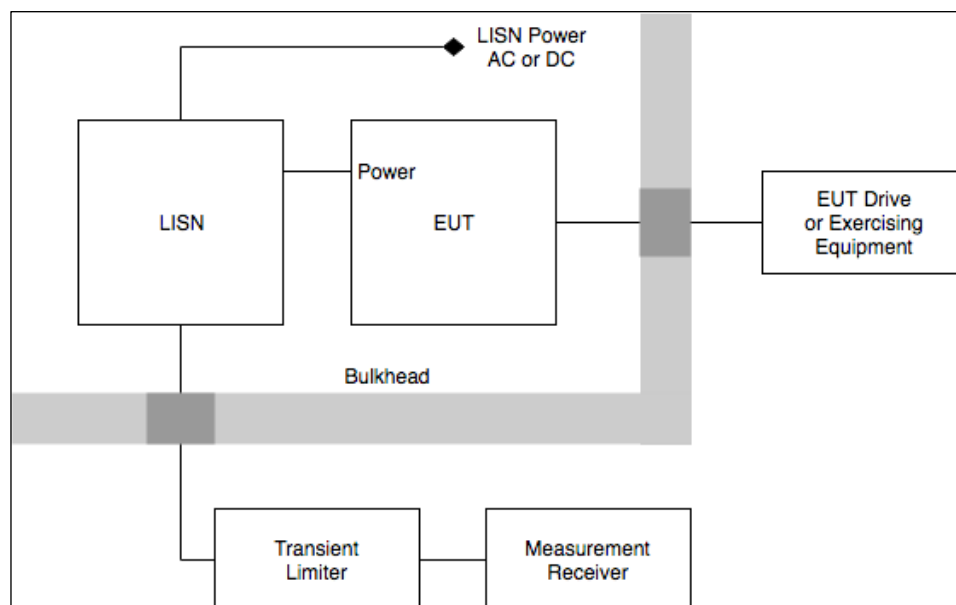

Figure 1 - Conducted Disturbance Test Setup



2.1.7 Environmental Conditions

Ambient Temperature 19.3 °C
 Relative Humidity 53.3 %

2.1.8 Test Results

Results for Configuration and Mode: Unintentional Transmissions

Performance assessment of the EUT made during this test: Pass.

Detailed results are shown below.

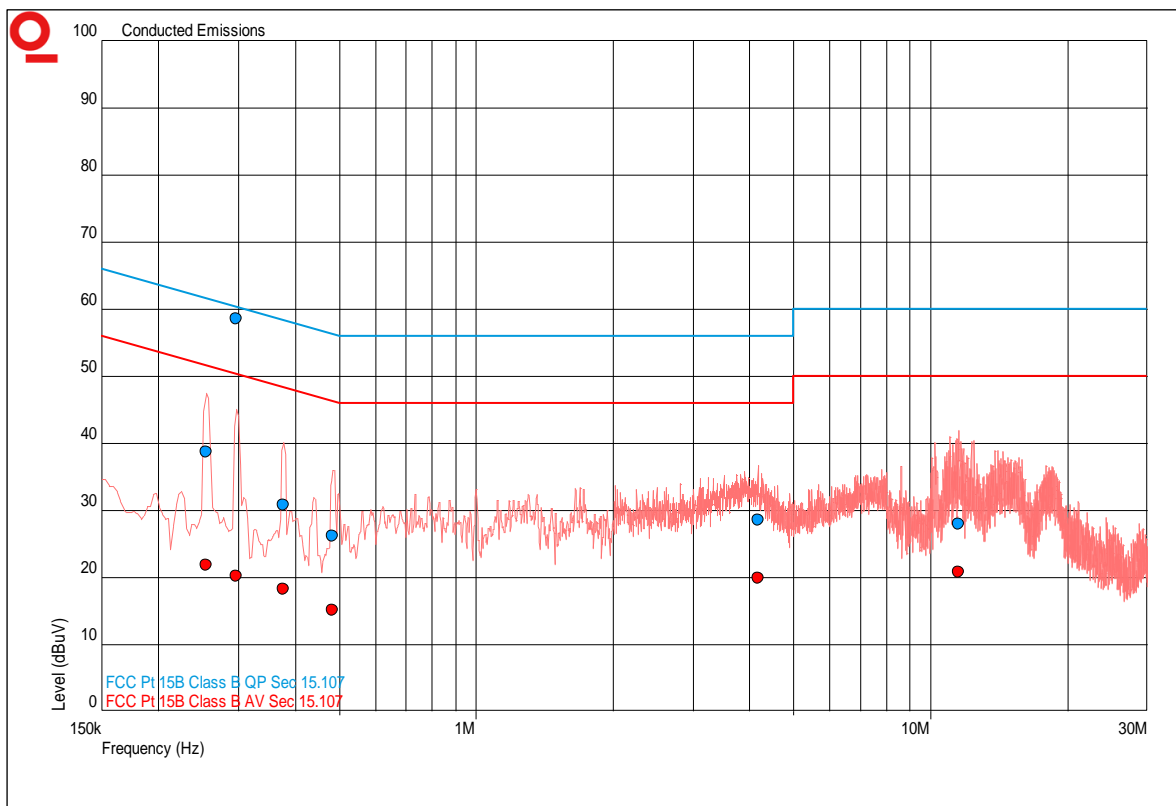

Figure 2 - Graphical Results – Live Line

Frequency (MHz)	QP Level (dBμV)	QP Limit (dBμV)	QP Margin (dB)	CISPR AV Level (dBμV)	CISPR AV Limit (dBμV)	CISPR AV Margin (dB)
0.254	38.7	61.6	22.9	21.9	51.6	29.8
0.296	58.6	60.3	1.8	20.2	50.3	30.2
0.377	30.8	58.3	27.6	18.3	48.3	30.0
0.484	26.3	56.3	30.0	15.1	46.3	31.2
4.168	28.6	56.0	27.4	19.9	46.0	26.1
11.514	28.0	60.0	32.0	20.8	50.0	29.2

Table 5

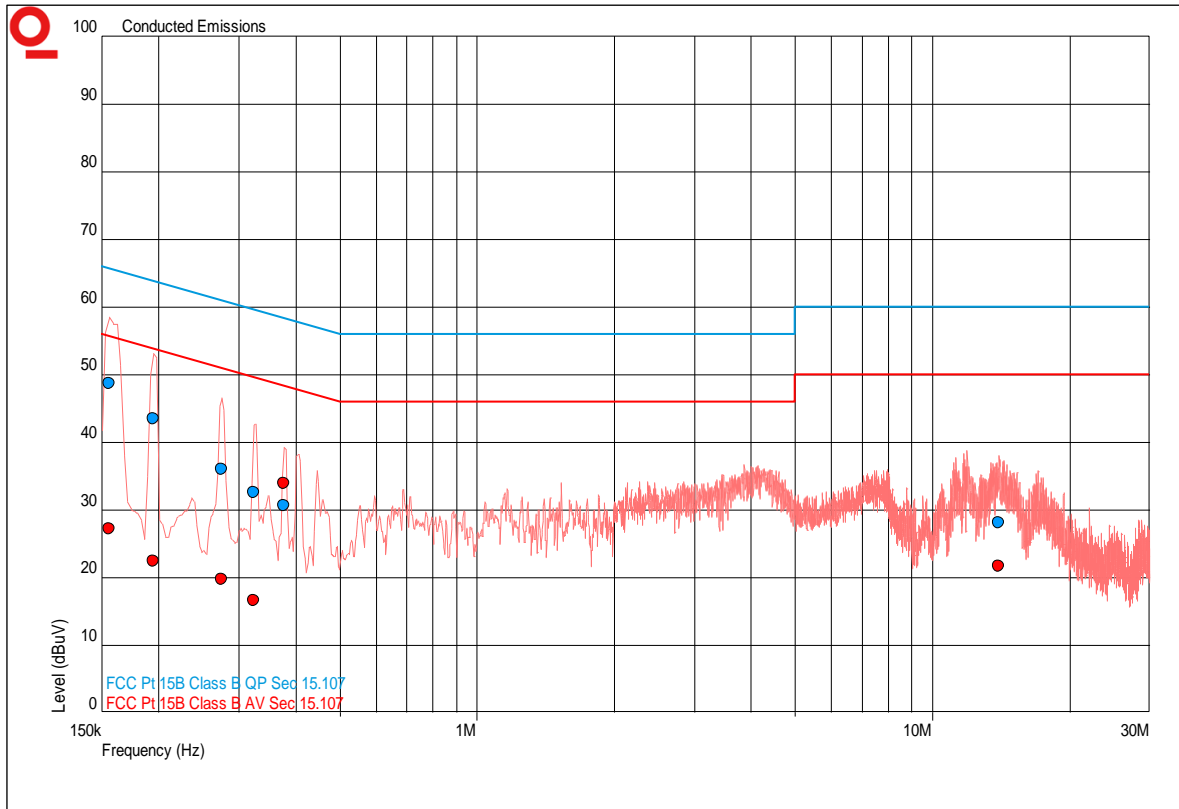

Figure 3 - Graphical Results – Neutral Line

Frequency (MHz)	QP Level (dBµV)	QP Limit (dBµV)	QP Margin (dB)	CISPR AV Level (dBµV)	CISPR AV Limit (dBµV)	CISPR AV Margin (dB)
0.156	48.7	65.7	17.0	27.2	55.7	28.5
0.195	43.6	63.8	20.3	22.5	53.8	31.4
0.275	36.1	61.0	24.8	19.8	51.0	31.1
0.323	32.6	59.6	27.1	16.7	49.6	32.9
0.377	30.6	58.3	27.7	33.9	48.3	14.5
13.968	28.1	60.0	31.9	21.8	50.0	28.2

Table 6



2.1.9 Test Location and Test Equipment Used

This test was carried out in EMC Chamber 5.

Instrument	Manufacturer	Type No	TE No	Calibration Period (months)	Calibration Due
Screened Room (5)	Rainford	Rainford	1545	36	23-Jan-2021
Compliance 5 Emissions	Teseq	V5.26.51	3275	-	Software
EMI Test Receiver	Rohde & Schwarz	ESU40	3506	12	17-Dec-2019
Transient Limiter	Hewlett Packard	11947A	15	12	26-Jul-2019
LISN	Rohde & Schwarz	ESH3-Z5	1390	12	20-Nov-2019
8m N-Type RF Cable	Teledyne	PR90-088-8MTR	5093	12	04-Oct-2019

Table 7



2.2 Radiated Disturbance

2.2.1 Specification Reference

FCC 47 CFR Part 15B and ICES-003, Clause 15.109 and 6.2

2.2.2 Equipment Under Test and Modification State

A2159, S/N: C02Y4006L59F - Modification State 0

2.2.3 Date of Test

03-March-2019 to 05-March-2019

2.2.4 Test Method

The EUT was set up in a semi-anechoic chamber on a remotely controlled turntable and placed on a non-conductive table 0.8m above a reference ground plane.

A pre-scan of the EUT emissions profile was made while varying the antenna-to-EUT azimuth, and antenna-to-EUT polarisation using a peak detector.

Measurements below 18GHz were taken at a 3m distance and measurements above 18GHz were taken at 1m distance.

Using the pre-scan list of the highest emissions detected, their bearing and associated antenna polarisation, the EUT was then formally measured using a Quasi-Peak, Peak, CISPR Average detector as appropriate.

The readings were maximized by adjusting the antenna height, polarisation and turntable azimuth, in accordance with the specification.

2.2.5 Example Calculation

Below 1GHz:

$$\begin{aligned} \text{Quasi-Peak level (dB}\mu\text{V/m)} &= \text{Receiver level (dB}\mu\text{V/m)} + \text{Correction Factor (dB)} \\ \text{Margin (dB)} &= \text{Limit (dB}\mu\text{V/m)} - \text{Quasi-Peak level (dB}\mu\text{V/m)} \end{aligned}$$

Above 1GHz:

$$\begin{aligned} \text{CISPR Average level (dB}\mu\text{V/m)} &= \text{Receiver level (dB}\mu\text{V/m)} + \text{Correction Factor (dB)} \\ \text{Margin (dB)} &= \text{Limit (dB}\mu\text{V/m)} - \text{CISPR Average level (dB}\mu\text{V/m)} \end{aligned}$$

$$\begin{aligned} \text{Peak level (dB}\mu\text{V/m)} &= \text{Receiver level (dB}\mu\text{V/m)} + \text{Correction Factor (dB)} \\ \text{Margin (dB)} &= \text{Limit (dB}\mu\text{V/m)} - \text{Peak level (dB}\mu\text{V/m)} \end{aligned}$$

2.2.6 Test Setup Diagram

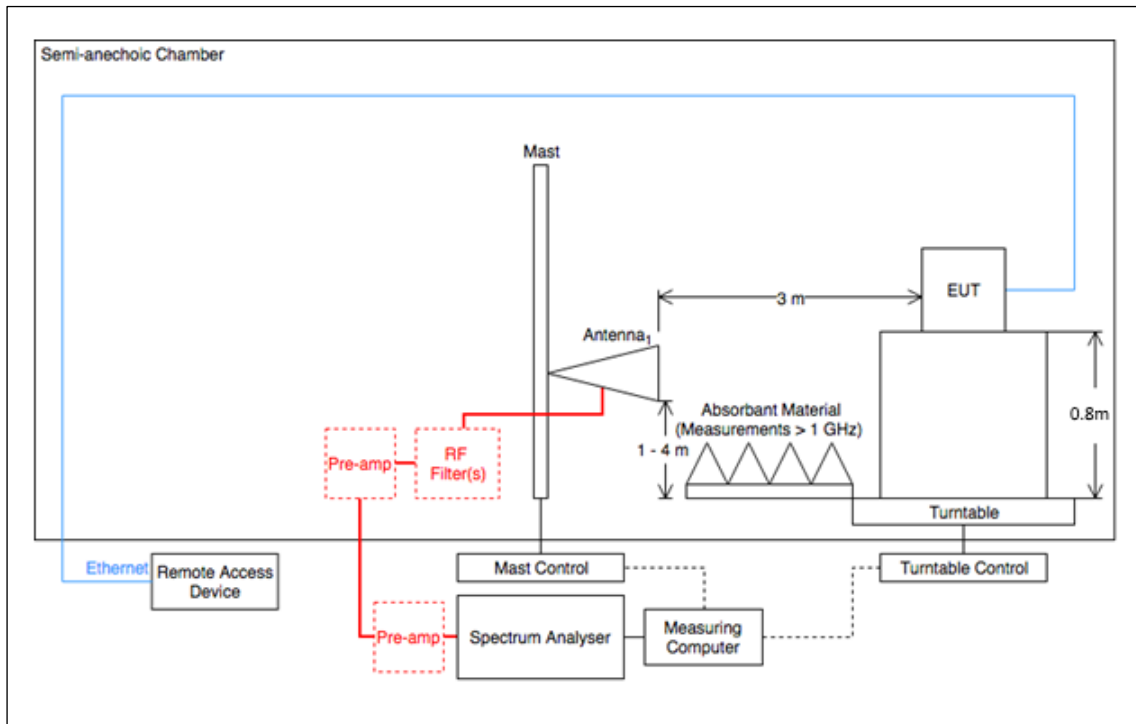

Figure 4 - Radiated Disturbance Test Setup

2.2.7 Environmental Conditions

Ambient Temperature 23.2 °C
Relative Humidity 43.0 %



2.2.8 Test Results

Results for Configuration and Mode: Unintentional Transmissions

Detailed results are shown below.

Highest frequency generated or used within the EUT: 5.9GHz
 Which necessitates an upper frequency test limit of: 30GHz

Frequency (MHz)	QP Level (dBµV/m)	QP Limit (dBµV/m)	QP Margin (dB)	Angle(Deg)	Height(m)	Polarity
*	-	-	-	-	-	-

Table 8 – 30 MHz to 1 GHz – Radiated Emissions Results

*No emissions were detected within 10 dB of the limit

Frequency (GHz)	Result (dBµV/m)		Limit (dBµV/m)		Margin (dB)	
	Peak	CISPR Average	Peak	CISPR Average	Peak	CISPR Average
*	-	-	-	-	-	-

Table 9 - 1GHz to 30GHz - Radiated Emissions Results

*No emissions were detected within 10 dB of the limit.

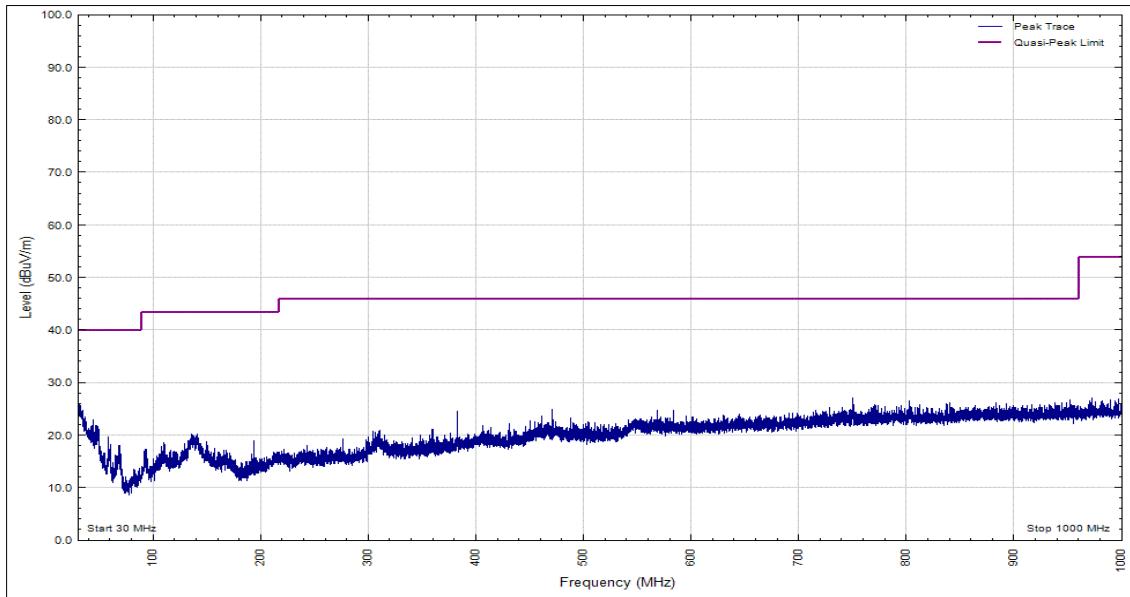

Figure 5 - Graphical Results - 30 MHz to 1 GHz – Vertical Polarity (Peak)

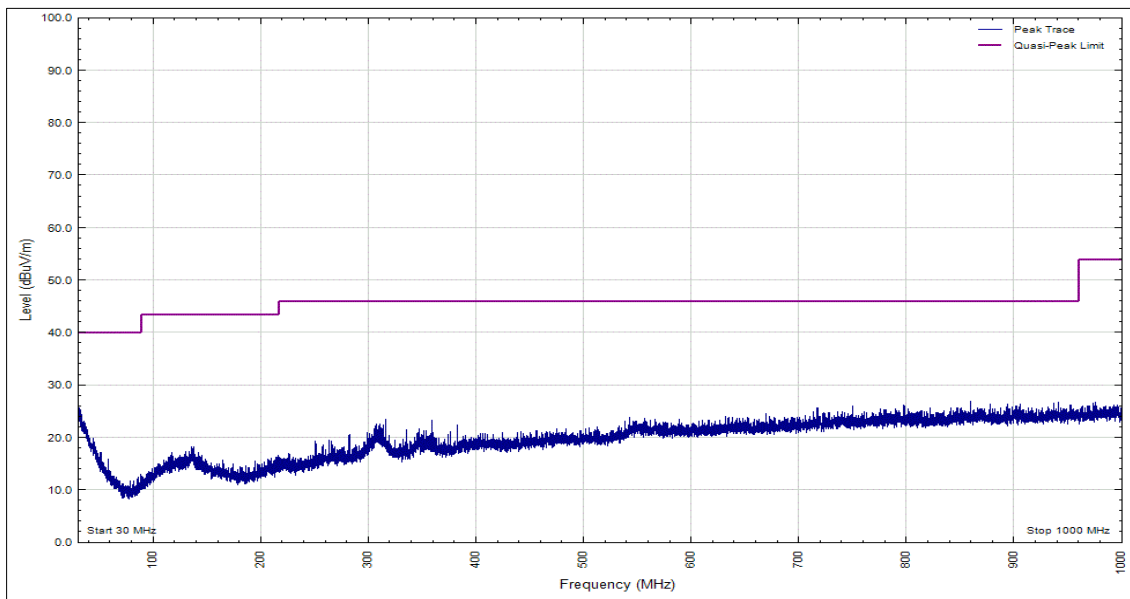

Figure 6 Graphical Results - 30 MHz to 1 GHz – Horizontal Polarity (Peak)

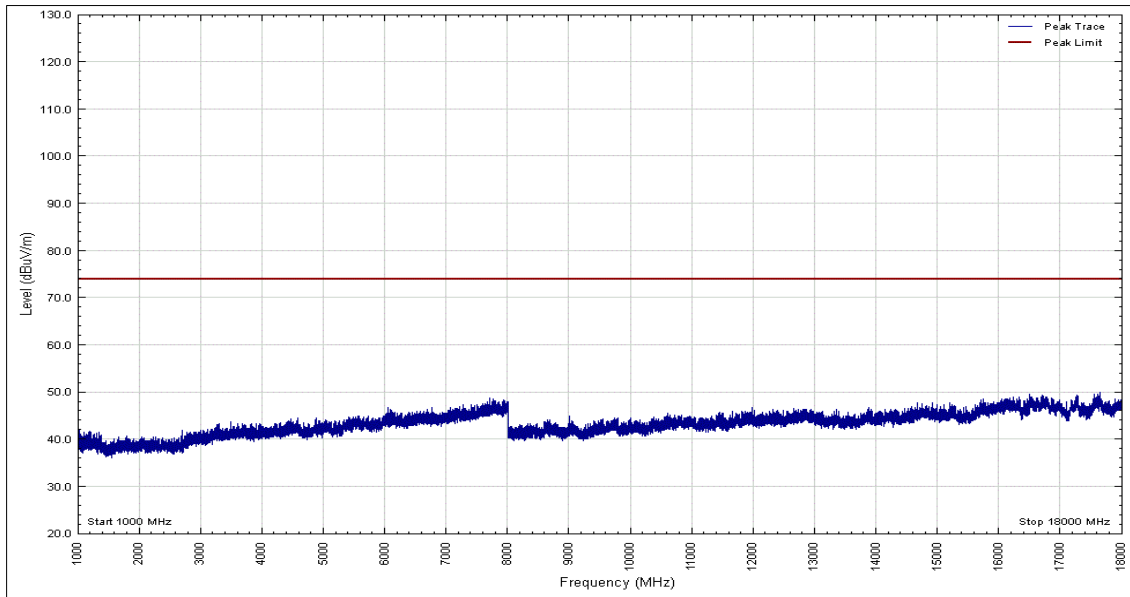

Figure 7 - Graphical Results - 1GHz to 18GHz, Horizontal Polarity (Peak)

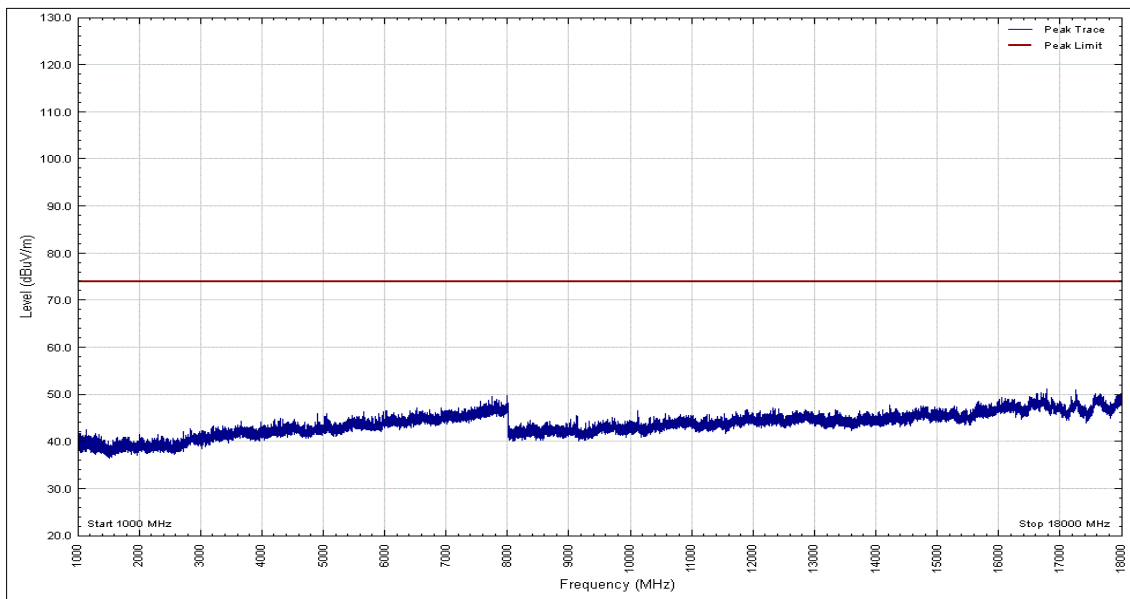

Figure 8 - Graphical Results - 1GHz to 18GHz, Vertical Polarity (Peak)

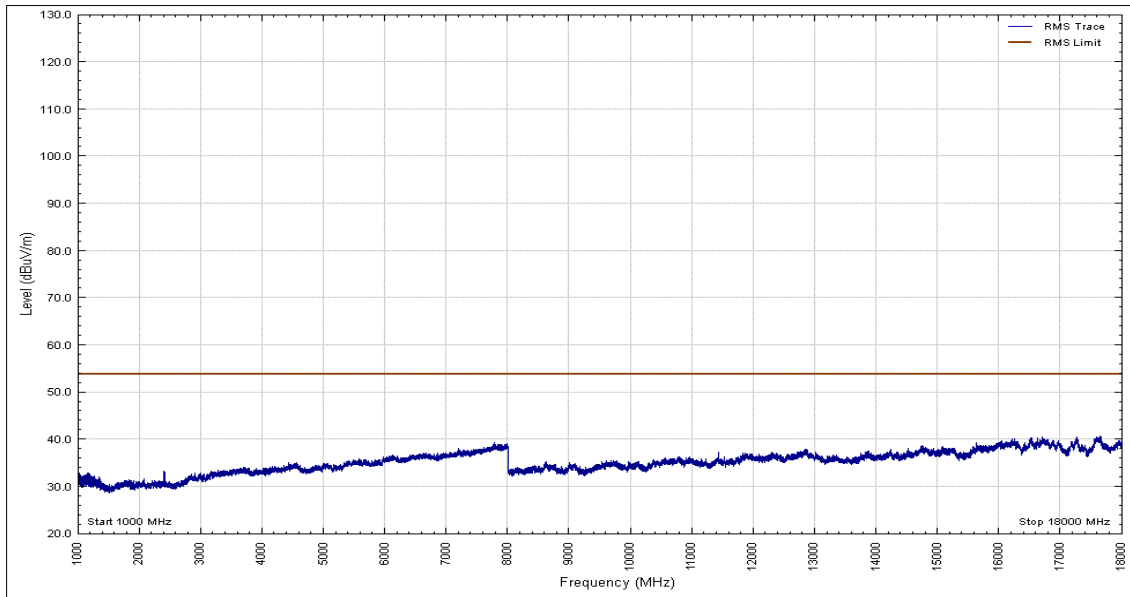

Figure 9 - Graphical Results - 1GHz to 18GHz, Horizontal Polarity (Average)

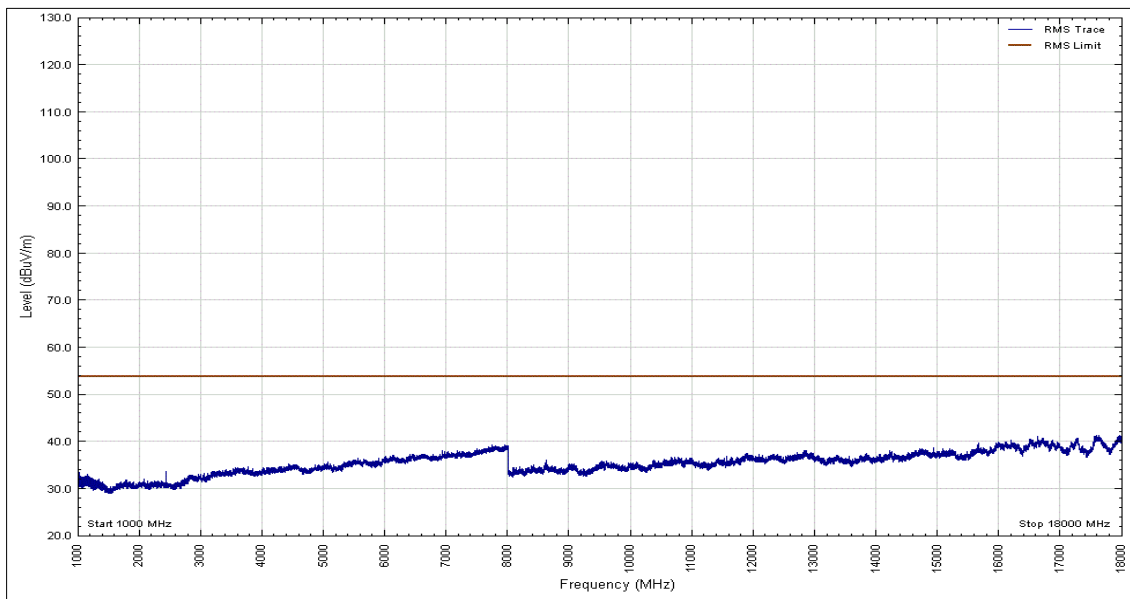

Figure 10 - Graphical Results - 1GHz to 18GHz, Vertical Polarity (Average)

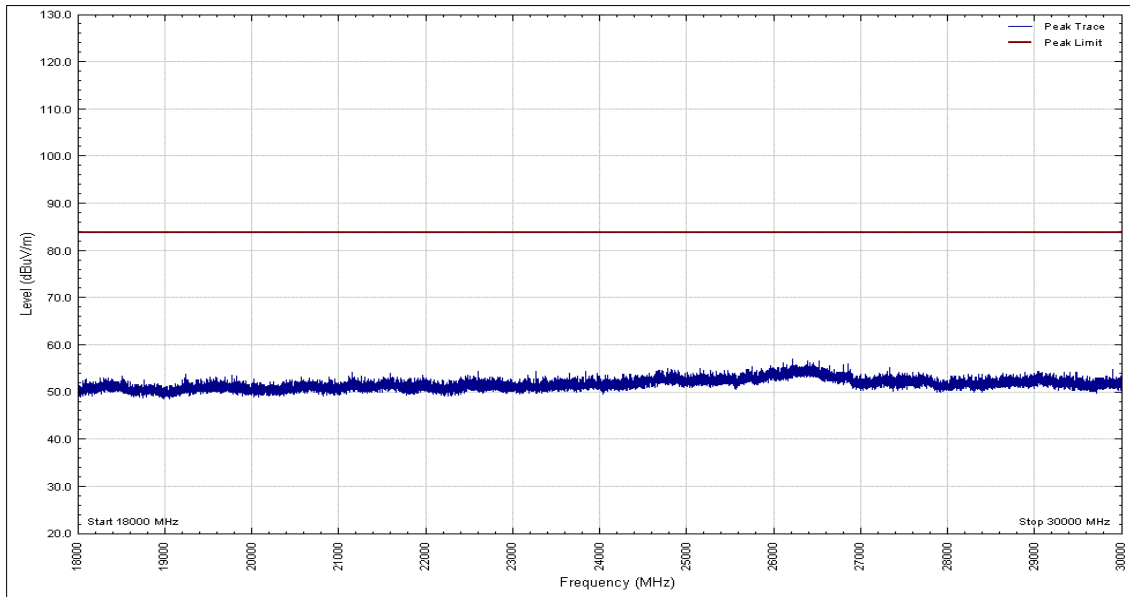

Figure 11 - Graphical Results - 18GHz to 30GHz, Horizontal Polarity (Peak)

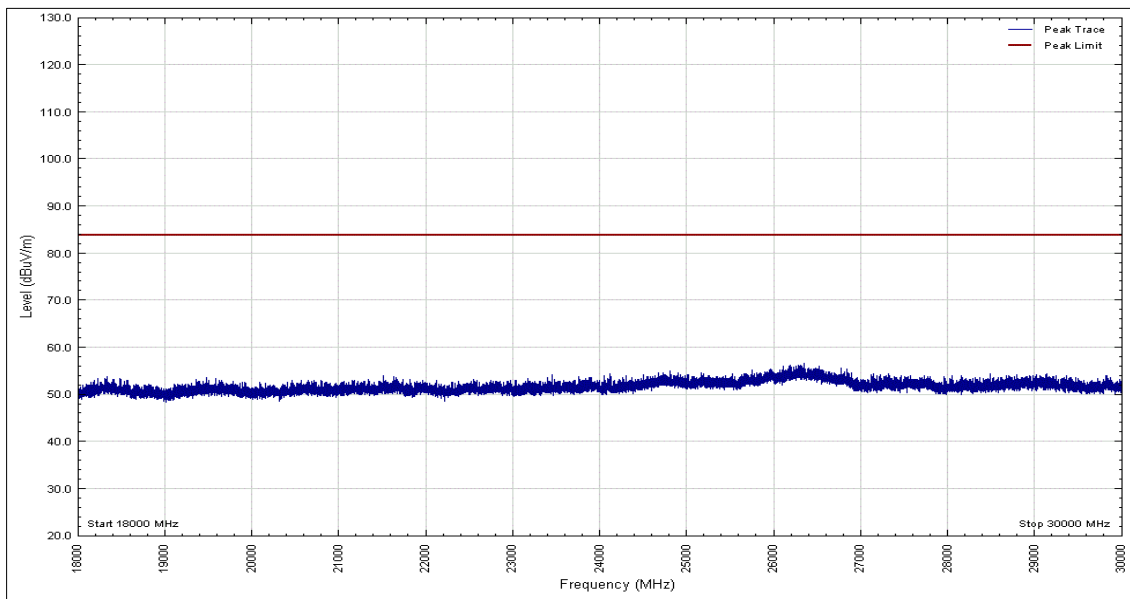

Figure 12 - Graphical Results - 18GHz to 30GHz, Vertical Polarity (Peak)

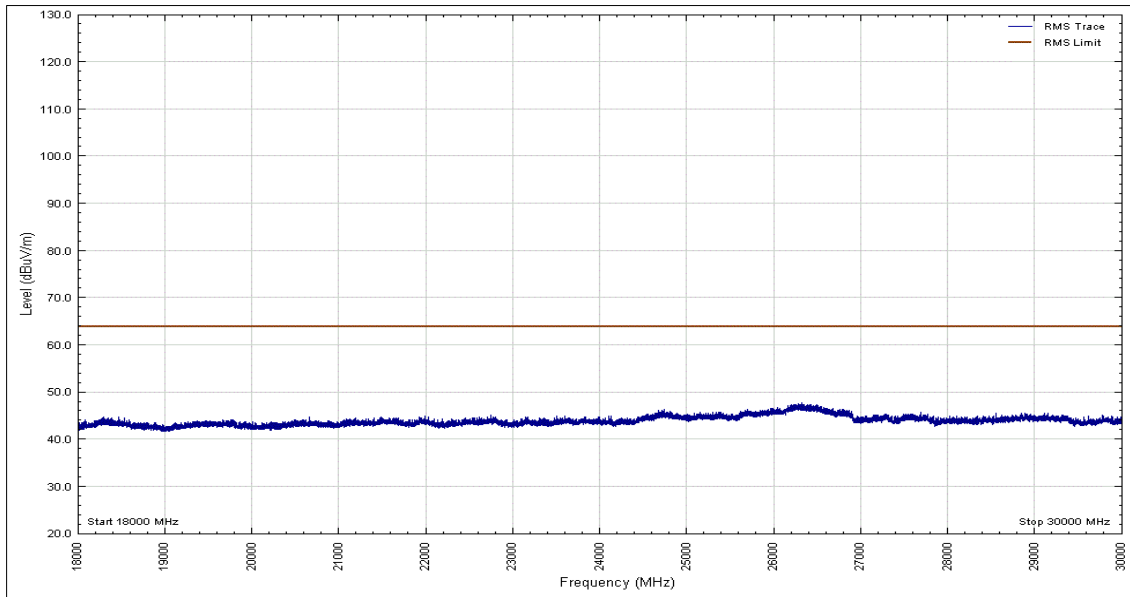

Figure 13 - Graphical Results - 18GHz to 30GHz, Horizontal Polarity (Average)

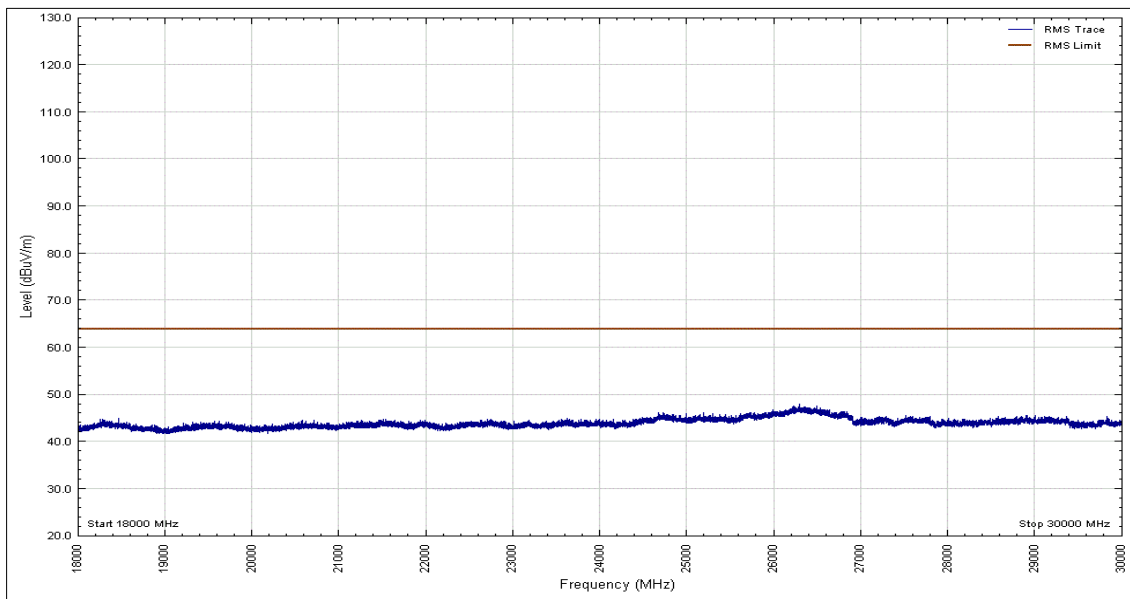

Figure 14 - G Graphical Results - 18GHz to 30GHz, Vertical Polarity (Average)



2.2.9 Test Location and Test Equipment Used

This test was carried out in RF Chamber 11.

Instrument	Manufacturer	Type No	TE No	Calibration Period (months)	Calibration Due
Screened Room (11)	Rainford	Rainford	5136	36	01-Nov-2021
EMI Test Receiver	Rohde & Schwarz	ESW44	5084	12	12-Sep-2019
EmX Test Software	TUV SUD	V1.4.4	5125	-	Software
Mast Controller	Maturo	Maturo NCD	5159	-	TU
Antenna with permanent attenuator (Bilog)	Schaffner	CBL6143	287	24	15-May-2020
Double Ridged Waveguide Horn Antenna	ETS-Lindgren	3117	4722	12	05-Mar-2020
Antenna 18-40GHz (Double Ridge Guide)	Link Microtek Ltd	AM180HA-K-TU2	230	24	02-May-2020
Pre-Amplifier, 1GHz to 8GHz	Wright Technologies	APS04-0085	4365	12	25-Oct-2019
Pre-Amplifier, 8GHz to 18GHz	Phase One	PS04-0086	1533	12	08-Feb-2020
Pre-Amplifier, 18GHz to 40GHz	Phase One	PS04-0087	1534	12	05-Feb-2020
Hygromer	Rotronic	Hygropalm	2404	12	26-Apr-2019
Cable 1503 2M 2.92(P)m 2.92(P)m	Rhophase	KPS-1503A-2000-KPS	4293	12	26-Oct-2019
Cable (Rx, Km-Km 2m)	Scott Cables	KPS-1501-2000-KPS	4526	6	26-Apr-2019
4dB Attenuator	Pasternack	PE7047-4	4935	24	28-Nov-2019
8m N-Type RF Cable	Teledyne	PR90-088-8MTR	5095	12	04-Oct-2019
Cable (18GHz)	Rosenberger	LU7-071-1000	5101	12	04-Oct-2019
Cable (18GHz)	Rosenberger	LU7-071-1000	5102	12	04-Oct-2019
Cable (18GHz)	Rosenberger	LU7-071-1000	5104	12	05-Oct-2019
Cable (18GHz)	Rosenberger	LU7-071-2000	5107	12	05-Oct-2019

Table 10

TU – Traceability Unscheduled



3 Measurement Uncertainty

For a 95% confidence level, the measurement uncertainties for defined systems are:

Test Name	Measurement Uncertainty
Radiated Disturbance	30 MHz to 1 GHz, Bilog Antenna, ± 5.2 dB 1 GHz to 40 GHz, Horn Antenna, ± 6.3 dB
Conducted Disturbance at Mains Terminals	150 kHz to 30 MHz, LISN, ± 3.7 dB

Table 11

Worst case error for both Time and Frequency measurement 12 parts in 106.
All measurement uncertainties have been calculated in accordance with CISPR guidelines.