



Element Materials Technology
 (formerly PCTEST)
 18855 Adams Court, Morgan Hill, CA 95037 USA
 Tel. 410.290.6652 / Fax 410.290.6654
<http://www.element.com>



MEASUREMENT REPORT
FCC PART 15.407 / ISED RSS-247 DFS

Applicant Name:

Apple Inc.
 One Apple Park Way
 Cupertino, CA 95014
 United States

Date of Testing:

2/20/2023 - 4/20/2023

Test Report Issue Date:

11/29/2023

Test Site/Location:

Element Materials Technology Morgan Hill, CA, USA

Test Report Serial No.:

1C2302130007-11.BCG

FCC ID:	BCGA2117
IC:	579C-A2117
APPLICANT:	Apple Inc.

Application Type:

Certification

Model/HVIN:

A2117

EUT Type:

Client Only Device, No Radar Detection Capability

Max. RF Output Power:

100.000 mW (20.00 dBm) Conducted
 (802.11n UNII Band 2A)

100.000 mW (20.00 dBm) Conducted
 (802.11n UNII Band 2C)

Frequency Range:

5250 – 5350 MHz (UNII-2A Band)

5470 – 5725 MHz (UNII-2C Band)

FCC Classification:

Unlicensed National Information Infrastructure (UNII)

FCC Rule Part(s):

Part 15 Subpart E (15.407)

ISED Specification:

RSS-247 Issue 3

Test Procedure(s):

KDB 905462 D02 v02

This equipment has been shown to be capable of compliance with the applicable technical standards as indicated in the measurement report and was tested in accordance with the measurement procedures specified in KDB 905462 D02 v02 Compliance Measurement Procedures for Unlicensed-National Information Infrastructure Devices Operating in the 5.25 – 5.35 GHz and 5.47 – 5.725 GHz Bands Incorporating Dynamic Frequency Selection. Test results reported herein relate only to the item(s) tested.

I attest to the accuracy of data. All measurements reported herein were performed by me or were made under my supervision and are correct to the best of my knowledge and belief. I assume full responsibility for the completeness of these measurements and vouch for the qualifications of all persons taking them.

RJ Ortanez
 Executive Vice President



FCC ID: BCGA2117 IC: 579C-A2117		MEASUREMENT REPORT (CERTIFICATION)	Approved by: Technical Manager
Test Report S/N: 1C2302130007-11.BCG	Test Dates: 2/20/2023 - 4/20/2023	EUT Type: Head Mounted Device	Page 1 of 38

V 10.5 12/15/2021

T A B L E O F C O N T E N T S

1.0	INTRODUCTION	3
1.1	SCOPE	3
1.2	ELEMENT MATERIALS TECHNOLOGY MORGAN HILL TEST LOCATION.....	3
1.3	TEST FACILITY / ACCREDITATIONS.....	3
2.0	PRODUCT INFORMATION	4
2.1	EQUIPMENT DESCRIPTION	4
2.2	DEVICE CAPABILITIES	5
2.3	ANTENNA DESCRIPTION	6
2.4	TEST SUPPORT EQUIPMENT	6
2.5	MASTER PARAMETERS	6
2.6	SOFTWARE AND FIRMWARE.....	6
2.7	EMI SUPPRESSION DEVICE(S)/MODIFICATIONS.....	6
3.0	DESCRIPTION OF TESTS.....	7
3.1	EVALUATION PROCEDURE	7
3.2	ENVIRONMENTAL CONDITIONS.....	7
4.0	ANTENNA REQUIREMENTS	8
5.0	MEASUREMENT UNCERTAINTY.....	9
6.0	TEST EQUIPMENT CALIBRATION DATA	10
7.0	DESCRIPTION OF DYNAMIC FREQUENCY SELECTION TEST	11
7.1	APPLICABILITY	11
	7.1.1 MASTER DEVICES:.....	12
	7.1.2 CLIENT DEVICES:.....	12
7.2	DFS DETECTION THRESHOLD VALUES	13
7.3	DFS RESPONSE REQUIREMENTS	14
7.4	PARAMETERS OF DFS TEST SIGNALS.....	15
7.5	SYSTEM OVERVIEW AND PROCEDURE	17
7.6	SYSTEM CALIBRATION:	18
8.0	EUT COMMUNICATION MODES.....	20
9.0	TEST RESULTS	24
9.1	SUMMARY	24
9.2	CHANNEL LOADING	26
	9.2.1 CHANNEL LOADING MODE 1:	26
	9.2.2 CHANNEL LOADING MODE 2:	27
	9.2.3 CHANNEL LOADING MODE 3:	28
	9.2.4 CHANNEL LOADING MODE 4:	29
9.3	CHANNEL MOVE/ CLOSING TRANSMISSION TIME.....	30
	9.3.1 CHANNEL MOVE/ CLOSING TRANSMISSION TIME MODE 1:	30
	9.3.2 CHANNEL MOVE/ CLOSING TRANSMISSION TIME MODE 2:	31
	9.3.3 CHANNEL MOVE/ CLOSING TRANSMISSION TIME MODE 3:	32
	9.3.4 CHANNEL MOVE/ CLOSING TRANSMISSION TIME MODE 4:	33
9.4	NON-OCCUPANCY PERIOD	34
	9.4.1 NON-OCCUPANCY PERIOD (30 MINUTES) MODE 1:.....	34
	9.4.2 NON-OCCUPANCY PERIOD (30 MINUTES) MODE 2:.....	35
	9.4.3 NON-OCCUPANCY PERIOD (30 MINUTES) MODE 3:.....	36
	9.4.4 NON-OCCUPANCY PERIOD (30 MINUTES) MODE 4.....	37
10.0	CONCLUSION.....	38

FCC ID: BCGA2117 IC: 579C-A2117		MEASUREMENT REPORT (CERTIFICATION)	Approved by: Technical Manager
Test Report S/N: 1C2302130007-11.BCG	Test Dates: 2/20/2023 - 4/20/2023	EUT Type: Head Mounted Device	Page 2 of 38

1.0 INTRODUCTION

1.1 Scope

This report has been prepared to demonstrate compliance with the requirements for Dynamic Frequency Selection (DFS) as stated in KDB 905462 D02 v02. As of July 20, 2007, all devices operating in the 5250 – 5350 MHz and/or the 5470 – 5725 MHz bands (excluding 5600-5650MHz for ISED Canada) must comply with the DFS requirements.

1.2 Element Materials Technology Morgan Hill Test Location

These measurement tests were conducted at the Element Materials Technology Morgan Hill facility located at 18855 Adams Court, Morgan Hill, CA 95037. The measurement facility is compliant with the test site requirements specified in ANSI C63.4-2014 and KDB 414788 D01 v01r01.

1.3 Test Facility / Accreditations

Measurements were performed at Element Materials Technology located in Morgan Hill, CA 95037, U.S.A.

- Element Materials Technology Morgan Hill is an ISO 17025-2017 accredited test facility under the American Association for Laboratory Accreditation (A2LA) with Certificate number 2041.02 for Specific Absorption Rate (SAR), Hearing Aid Compatibility (HAC) testing, where applicable, and Electromagnetic Compatibility (EMC) testing for FCC and Innovation, Science, and Economic Development Canada rules.
- Element Washington DC LLC TCB is a Telecommunication Certification Body (TCB) accredited to ISO/IEC 17065-2012 by A2LA (Certificate number 2041.03) in all scopes of FCC Rules and ISED Standards (RSS).
- Element Materials Technology Morgan Hill facility is a registered (22831) test laboratory with the site description on file with ISED.
- Element Washington DC LLC is a Recognized U.S. Certification Assessment Body (CAB # US0110) for ISED Canada as designated by NIST under the U.S. and Canada Mutual Recognition Agreements (MRAs).

FCC ID: BCGA2117 IC: 579C-A2117		MEASUREMENT REPORT (CERTIFICATION)	Approved by: Technical Manager
Test Report S/N: 1C2302130007-11.BCG	Test Dates: 2/20/2023 - 4/20/2023	EUT Type: Head Mounted Device	Page 3 of 38

V 10.5 12/15/2021

2.0 PRODUCT INFORMATION

2.1 Equipment Description

The Equipment Under Test (EUT) is the **Apple Head Mounted Device FCC ID: BCGA2117, IC: 579C-A2117**. The test data contained in this report pertains only to the emissions due to the EUT's UNII transmitter. As the EUT does not have radar detection capability it was evaluated as a Client Only Device. All test results reported herein are applicable to the sample selected for testing.

Mode of Operation:

Master Device	<input type="checkbox"/>
Client Device (No radar detection)	<input checked="" type="checkbox"/>
Client Device with Radar Detection	<input type="checkbox"/>

Test Device Serial No.: LK6Y91P90P

FCC ID: BCGA2117 IC: 579C-A2117		MEASUREMENT REPORT (CERTIFICATION)	Approved by: Technical Manager
Test Report S/N: 1C2302130007-11.BCG	Test Dates: 2/20/2023 - 4/20/2023	EUT Type: Head Mounted Device	Page 4 of 38

2.2 Device Capabilities

This device contains the following capabilities:

802.11b/g/n/ax WLAN, 802.11a/n/ac/ax UNII, Bluetooth (1x, EDR, LE1M, LE2M, HDR4, HDR8), NB UNII (1x, LE1M, LE2M, HDR4, HDR8, HDRp4, HDRp8)

This device supports BT Beamforming.

Channel puncturing function is not supported for this device.

Band 1		Band 2A		Band 2C		Band 3	
Ch.	Frequency (MHz)	Ch.	Frequency (MHz)	Ch.	Frequency (MHz)	Ch.	Frequency (MHz)
36	5180	52	5260	100	5500	149	5745
:	:	:	:	:	:	:	:
42	5210	56	5280	116	5580	157	5785
:	:	:	:	:	:	:	:
48	5240	64	5320	144	5720	165	5825

Table 2-1. 802.11a / 802.11n / 802.11ac / 802.11ax (20MHz) Frequency / Channel Operations

Band 1		Band 2A		Band 2C		Band 3	
Ch.	Frequency (MHz)	Ch.	Frequency (MHz)	Ch.	Frequency (MHz)	Ch.	Frequency (MHz)
38	5190	54	5270	102	5510	151	5755
:	:	:	:	:	:	:	:
46	5230	62	5310	110	5550	159	5795
				:	:		
				142	5710		

Table 2-2. 802.11n / 802.11ac / 802.11ax (40MHz BW) Frequency / Channel Operations

Band 1		Band 2A		Band 2C		Band 3	
Ch.	Frequency (MHz)	Ch.	Frequency (MHz)	Ch.	Frequency (MHz)	Ch.	Frequency (MHz)
42	5210	58	5290	106	5530	155	5775
				:	:		
				138	5690		

Table 2-3. 802.11ac / 802.11ax (80MHz BW) Frequency / Channel Operations

FCC ID: BCGA2117 IC: 579C-A2117		MEASUREMENT REPORT (CERTIFICATION)	Approved by: Technical Manager
Test Report S/N: 1C2302130007-11.BCG	Test Dates: 2/20/2023 - 4/20/2023	EUT Type: Head Mounted Device	Page 5 of 38

2.3 Antenna Description

Following antenna gains provided by manufacturer were used for the testing.

Frequency [GHz]	Antenna Gain (dBi)	
	Ant 1	Ant 2
5.150 – 5.250	3.3	2.5
5.250 – 5.350	3.4	2.3
5.470 – 5.725	2.6	1.8
5.725 – 5.850	1.2	2.3

Table 2-4. Highest Antenna Gain

2.4 Test Support Equipment

The following equipment was used in support of the DFS testing.

Device	Manufacturer	Model	Description	S/N:	FCC ID:
Master	Apple	Macbook Air	Controller	C02P52H6G085	QDS-BRCM1072
	Netgear	RAXE500	Access Point	6JX215GA10A5	PY320300508
Client	Apple	Apple TV	Controller	C0754033HHFP	BCGA1625
		Macbook Air	Controller	C02P52H6G085	QDS-BRCM1072
		AkitaD	EUT Cable	GPCGQ900057000011N	N/A
	Dell	U24177HJ	Monitor Display	0RXP1N-74261-71Q-0APL-A01	N/A

Table 2-5. Test Support Equipment List

2.5 Master Parameters

Parameters of Master:	
Minimum Antenna Gain	2.24 dBi
EIRP Level:	>23 dBm
Access Point Software Version	1.0.10.86

Table 2-6. Parameters of Master

2.6 Software and Firmware

The test was done with firmware version 20.94.1.18 installed on the EUT.

2.7 EMI Suppression Device(s)/Modifications

No EMI suppression device(s) were added and/or no modifications were made during testing.

FCC ID: BCGA2117 IC: 579C-A2117		MEASUREMENT REPORT (CERTIFICATION)	Approved by: Technical Manager
Test Report S/N: 1C2302130007-11.BCG	Test Dates: 2/20/2023 - 4/20/2023	EUT Type: Head Mounted Device	Page 6 of 38

3.0 DESCRIPTION OF TESTS

3.1 Evaluation Procedure

The measurement procedures described in KDB 905462 D02 v02 were used in the measurement of the EUT. Radiated test methodology was used for the DFS evaluation procedure of the EUT. No deviations to the test procedure and test methods occurred during the evaluation of the EUT.

Deviation from measurement procedure.....None

3.2 Environmental Conditions

The temperature is controlled within range of 15°C to 35°C. The relative humidity is controlled within range of 10% to 75%. The atmospheric pressure is monitored within the range 86-106kPa (860-1060mbar).

FCC ID: BCGA2117 IC: 579C-A2117	 MEASUREMENT REPORT (CERTIFICATION)	Approved by: Technical Manager
Test Report S/N: 1C2302130007-11.BCG	Test Dates: 2/20/2023 - 4/20/2023	EUT Type: Head Mounted Device
		Page 7 of 38

4.0 ANTENNA REQUIREMENTS

Excerpt from §15.203 of the FCC Rules/Regulations:

“An intentional radiator antenna shall be designed to ensure that no antenna other than that furnished by the responsible party can be used with the device. The use of a permanently attached antenna or of an antenna that uses a unique coupling to the intentional radiator shall be considered sufficient to comply with the provisions of this section.”

- The antennas of the EUT are **permanently attached**.
- There are no provisions for connection to an external antenna.

Conclusion:

The EUT complies with the requirement of §15.203.

FCC ID: BCGA2117 IC: 579C-A2117		MEASUREMENT REPORT (CERTIFICATION)	Approved by: Technical Manager
Test Report S/N: 1C2302130007-11.BCG	Test Dates: 2/20/2023 - 4/20/2023	EUT Type: Head Mounted Device	Page 8 of 38

5.0 MEASUREMENT UNCERTAINTY

The measurement uncertainties shown below were calculated in accordance with the requirements of ANSI C63.23-2012. All measurement uncertainty values are shown with a coverage factor of $k = 2$ to indicate a 95% level of confidence. The measurement uncertainty shown below meets or exceeds the U_{CISPR} measurement uncertainty values specified in CISPR 16-4-2 and, thus, can be compared directly to specified limits to determine compliance.

Parameter	Expanded Uncertainty
Time	$\pm 0.2\%$

FCC ID: BCGA2117 IC: 579C-A2117		MEASUREMENT REPORT (CERTIFICATION)	Approved by: Technical Manager
Test Report S/N: 1C2302130007-11.BCG	Test Dates: 2/20/2023 - 4/20/2023	EUT Type: Head Mounted Device	Page 9 of 38

V 10.5 12/15/2021

6.0 TEST EQUIPMENT CALIBRATION DATA

Test Equipment Calibration is traceable to the National Institute of Standards and Technology (NIST). Measurements antennas used during testing were calibrated in accordance to the requirements of ANSI C63.5-2017.

Manufacturer	Model	Description	Cal Date	Cal Interval	Cal Due	Serial #
Aeroflex	3025C	PXI RF Synthesizer	3/6/2023	Biennial	3/6/2025	1082329
Aeroflex	3035C	PXI RF Digitizer	3/6/2023	Biennial	3/6/2025	303570427
ETS-Lindgren	3117	Double Ridged Guide Horn Antenna (1-18GHz)	5/24/2022	Annual	5/24/2023	240049
ETS-Lindgren	3117	Double Ridged Guide Horn Antenna (1-18GHz)	3/30/2023	Annual	3/30/2024	218555
Rohde & Schwarz	FSVA40	Signal and Spectrum Analyzer	5/19/2022	Annual	5/19/2023	101098

Table 6-1. Test Equipment List

Note:

For equipment listed above that has a calibration date or calibration due date that falls within the test date range, care was taken to ensure that this equipment was used after the calibration date and before the calibration due date.

FCC ID: BCGA2117 IC: 579C-A2117		MEASUREMENT REPORT (CERTIFICATION)	Approved by: Technical Manager
Test Report S/N: 1C2302130007-11.BCG	Test Dates: 2/20/2023 - 4/20/2023	EUT Type: Head Mounted Device	Page 10 of 38

7.0 DESCRIPTION OF DYNAMIC FREQUENCY SELECTION TEST

7.1 Applicability

The following table from KDB 905462 D02 v02 lists the applicable requirements for the DFS testing. The device evaluated in this report is considered a client device without radar detection capability.

Requirement	Operational Mode		
	Master	Client Without Radar Detection	Client with Radar Detection
Non-Occupancy Period	Yes	Not required	Yes
DFS Detection Threshold	Yes	Not required	Yes
Channel Availability Check Time	Yes	Not required	Not required
U-NII Detection Bandwidth	Yes	Not required	Yes

Table 7-1. DFS Applicability

Requirement	Operational Mode		
	Master	Client Without Radar Detection	Client with Radar Detection
DFS Detection Threshold	Yes	Not required	Yes
Channel Closing Transmission Time	Yes	Yes	Yes
Channel Move Time	Yes	Yes	Yes
U-NII Detection Bandwidth	Yes	Not required	Yes

Table 7-2. DFS Applicability During Normal Operation

Additional requirements for devices with multiple bandwidth modes	Master Device or Client with Radar Detection	Client without Radar Detection
U-NII Detection Bandwidth and Statistical Performance Check	All BW modes must be tested	Not required
Channel Move Time and Channel Closing Transmission Time	Test using widest BW mode available	Test using the widest BW mode available for the link
All other tests	Any single BW mode	Not required
<p>Note: Frequencies selected for statistical performance check (Section 7.8.4) should include several frequencies within the radar detection bandwidth and frequencies near the edge of the radar detection bandwidth. For 802.11 devices it is suggested to select frequencies in each of the bonded 20 MHz channels and the channel center frequency.</p>		

Table 7-3. Additional Requirement for Devices with Multiple Bandwidth Modes

FCC ID: BCGA2117 IC: 579C-A2117		MEASUREMENT REPORT (CERTIFICATION)	Approved by: Technical Manager
Test Report S/N: 1C2302130007-11.BCG	Test Dates: 2/20/2023 - 4/20/2023	EUT Type: Head Mounted Device	Page 11 of 38



Per KDB 905462 D02 v02 the operational behavior and individual DFS requirements associated with these modes are as follows:

7.1.1 Master Devices:

- a) The Master Device will use DFS in order to detect Radar Waveforms with received signal strength above the DFS Detection Threshold in the 5250 – 5350 MHz and 5470 – 5725 MHz bands. DFS is not required in the 5150 – 5250 MHz or 5725 – 5850 MHz bands.
- b) Before initiating a network on a Channel, the Master Device will perform a Channel Availability Check for a specified time duration (Channel Availability Check Time) to ensure that there is no radar system operating on the Channel, using DFS described under subsection a) above.
- c) The Master Device initiates a U-NII network by transmitting control signals that will enable other U-NII devices to Associate with the Master Device.
- d) During normal operation, the Master Device will monitor the Channel (In-Service Monitoring) to ensure that there is no radar system operating on the Channel, using DFS described under a).
- e) If the Master Device has detected a Radar Waveform during In-Service Monitoring as described under d), the Operating Channel of the U-NII network is no longer an Available Channel. The Master Device will instruct all associated Client Device(s) to stop transmitting on this Channel within the Channel Move Time. The transmissions during the Channel Move Time will be limited to the Channel Closing Transmission Time.
- f) Once the Master Device has detected a Radar Waveform it will not utilize the Channel for the duration of the Non-Occupancy Period.
- g) If the Master Device delegates the In-Service Monitoring to a Client Device, then the combination will be tested to the requirements described under d) through f) above.

7.1.2 Client Devices:

- a) A Client Device will not transmit before having received appropriate control signals from a Master Device.
- b) A Client Device will stop all its transmissions whenever instructed by a Master Device to which it is associated and will meet the Channel Move Time and Channel Closing Transmission Time requirements. The Client Device will not resume any transmissions until it has again received control signals from a Master Device.
- c) If a Client Device is performing In-Service Monitoring and detects a Radar Waveform above the DFS Detection Threshold, it will inform the Master Device. This is equivalent to the Master Device detecting the Radar Waveform and d) through f) of section 5.1.1 apply.
- d) Irrespective of Client Device or Master Device detection the Channel Move Time and Channel Closing Transmission Time requirements remain the same.
- e) The client test frequency must be monitored to ensure no transmission of any type has occurred for 30 minutes. Note: If the client moves with the master, the device is considered compliant if nothing appears in the client non-occupancy period test. For devices that shutdown (rather than moving channels), no beacons should appear.

FCC ID: BCGA2117 IC: 579C-A2117		MEASUREMENT REPORT (CERTIFICATION)	Approved by: Technical Manager
Test Report S/N: 1C2302130007-11.BCG	Test Dates: 2/20/2023 - 4/20/2023	EUT Type: Head Mounted Device	Page 12 of 38

V 10.5 12/15/2021

7.2 DFS Detection Threshold Values

The DFS detection thresholds are defined for Master devices and Client Devices with In-service monitoring. These detection thresholds are listed in the following table.

Maximum Transmit Power	Value (See Notes 1, 2, and 3)
EIRP \geq 200 milliwatt	-64 dBm
EIRP < 200 milliwatt and power spectral density < 10 dBm/MHz	-62 dBm
EIRP < 200 milliwatt that do not meet the power spectral density requirement	-64 dBm
<p>Note 1: This is the level at the input of the receiver assuming a 0 dBi receive antenna.</p> <p>Note 2: Throughout these test procedures an additional 1 dB has been added to the amplitude of the test transmission waveforms to account for variations in measurement equipment. This will ensure that the test signal is at or above the detection threshold level to trigger a DFS response.</p> <p>Note 3: EIRP is based on the highest antenna gain. For MIMO devices refer to KDB Publication 662911 D01.</p>	

Table 7-4: Detection Thresholds for Master Devices and Client Devices with Radar Detection

FCC ID: BCGA2117 IC: 579C-A2117		MEASUREMENT REPORT (CERTIFICATION)	Approved by: Technical Manager
Test Report S/N: 1C2302130007-11.BCG	Test Dates: 2/20/2023 - 4/20/2023	EUT Type: Head Mounted Device	Page 13 of 38

7.3 DFS Response Requirements

DFS response requirements for Master and Client Devices are listed in the following table.

Parameter	Value
Non-occupancy period	Minimum 30 minutes
Channel Availability Check Time	60 seconds
Channel Move Time	10 seconds See Note1
Channel Closing Transmission Time	200 milliseconds + an aggregate of 60 milliseconds over remaining 10 second period. See Note 1 and 2.
U-NII Detection Bandwidth	Minimum 100% of the U- NII 99% transmission power bandwidth. See Note 3.
<p>Note 1: Channel Move Time and the Channel Closing Transmission Time should be performed with Radar Type 0. The measurement timing begins at the end of the Radar Type 0 burst</p> <p>Note 2: The Channel Closing Transmission Time is comprised of 200 milliseconds starting at the beginning of the Channel Move Time plus any additional intermittent control signals required to facilitate a Channel move (an aggregate of 60 milliseconds) during the remainder of the 10 second period. The aggregate duration of control signals will not count quiet periods in between transmissions.</p> <p>frequency step the minimum percentage of detection is 90 percent. Measurements are performed with no data traffic.</p>	

Table 7-5: DFS Response Requirements

FCC ID: BCGA2117 IC: 579C-A2117		MEASUREMENT REPORT (CERTIFICATION)	Approved by: Technical Manager
Test Report S/N: 1C2302130007-11.BCG	Test Dates: 2/20/2023 - 4/20/2023	EUT Type: Head Mounted Device	Page 14 of 38

7.4 Parameters of DFS Test Signals

As the EUT is a Client Device with no Radar Detection only one type radar pulse is required for the testing. Radar Pulse type 0 was used in the evaluation of the Client device for the purpose of measuring the Channel Move Time and the Channel Closing Transmission Time. Table 7-6 lists the parameters for the Short Pulse Radar Waveforms. A plot of the Radar Pulse Type 0 used for testing is included in Section 7.7 of this report.

Radar Type	Pulse Width (µsec)	PRI (µsec)	Number of Pulses	Minimum Percentage of Successful Detection	Minimum Number of Trials
0	1	1428	18	See Note 1	See Note 1
1	1	Test A: 15 unique PRI values randomly selected from the list of 23 PRI values in Table 5a	Roundup $\left\{ \frac{1}{360} \cdot \frac{19.10^6}{PRI_{\mu sec}} \right\}$	60%	30
		Test B: 15 unique PRI values randomly selected within the range of 518-3066 µsec, with a minimum increment of 1 µsec, excluding PRI values selected in Test A			
2	1-5	150-230	23-29	60%	30
3	6-10	200-500	16-18	60%	30
4	11-20	200-500	12-16	60%	30
Aggregate (Radar Types 1-4)				80%	120
Note 1: Short Pulse Radar Type 0 should be used for the detection bandwidth test, channel move time, and channel closing time tests.					

Table 7-6: Parameters for Short Pulse Radar Waveforms

Radar Type	Pulse Width (µsec)	Chirp Width (MHz)	PRI (µsec)	Number of Pulses per Burst	Number of Bursts	Minimum Percentage of Successful Detection	Minimum Number of Trials
5	50 - 100	5 - 20	1000 – 2000	1 - 3	8 - 20	80%	30

Table 7-7. Parameters for Long Pulse Radar Waveforms

FCC ID: BCGA2117 IC: 579C-A2117		MEASUREMENT REPORT (CERTIFICATION)		Approved by: Technical Manager
Test Report S/N: 1C2302130007-11.BCG	Test Dates: 2/20/2023 - 4/20/2023	EUT Type: Head Mounted Device		Page 15 of 38

Radar Type	Pulse Width (µsec)	PRI (µsec)	Pulses per Hop	Hopping Rate (kHz)	Hopping Sequence Length (msec)	Minimum Percentage of Successful Detection	Minimum Number of Trials
6	1	333	9	0.333	300	70%	30

Table 7-8. Parameters for Frequency Hopping Radar Waveforms

FCC ID: BCGA2117 IC: 579C-A2117		MEASUREMENT REPORT (CERTIFICATION)	Approved by: Technical Manager
Test Report S/N: 1C2302130007-11.BCG	Test Dates: 2/20/2023 - 4/20/2023	EUT Type: Head Mounted Device	Page 16 of 38

7.5 System Overview and Procedure

DFS Test Setup per KDB 905462 D02 V02:

Radiated DFS Test Setup	<input checked="" type="checkbox"/>
Conducted DFS Test Setup	<input type="checkbox"/>

KDB 905462 D02 v02 describes radiated test setup and conducted test setup. DFS testing was performed using radiated test setup, as seen in Figure 7-1 below. Two channels were selected in Band UNII-2C & UNII-2A, between 5250-5725 MHz, for testing.

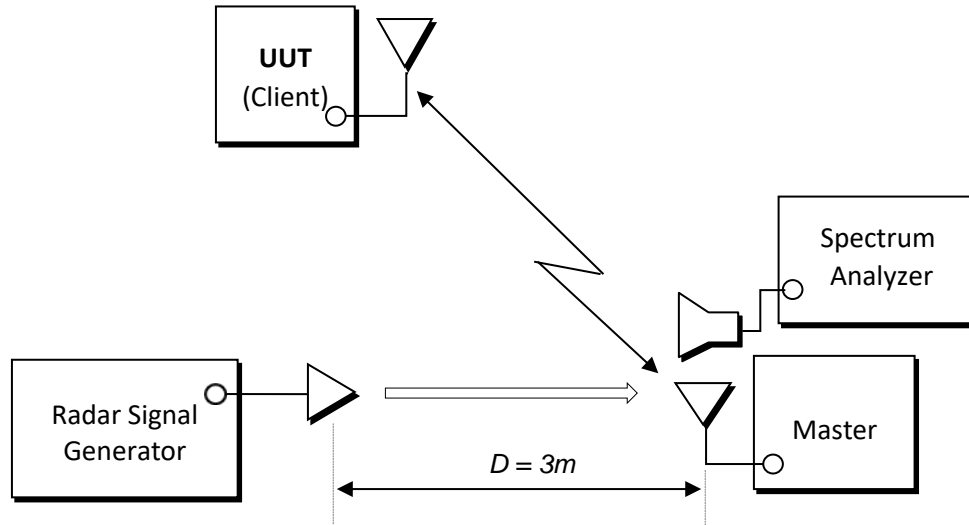



Figure 7-1. Radiated Test Setup for DFS

1. The “Aeroflex PXI DFS Radar Simulator and Analyzer Test Suite” is setup to provide a simulated radar pulse at the frequency that the Master and Client are operating. A Type 0 radar pulse was used.
2. The Client Device (EUT) is set up per the diagram in Figure 7-1 and communications between the Master device and the Client is established.
3. The FCC video test file is streamed from the Master to the Client to properly load the network.
4. The “Aeroflex PXI DFS Radar Simulator and Analyzer Test Suite” is set to record and display 12 seconds of time, starting from where the simulated radar is generated. This time domain plot captures any transmissions occurring up to and after 10 seconds. Aggregate time is computed to ensure compliance. (Note: the channel may be different since the Master and Client have changed channels due to the detection of the initial radar pulse.)
5. After the initial radar burst the channel is monitored for 30 minutes to ensure no transmissions or beacons occur. A second monitoring setup is used to verify that the Master and Client have both moved to different channels.

FCC ID: BCGA2117 IC: 579C-A2117		MEASUREMENT REPORT (CERTIFICATION)	Approved by: Technical Manager
Test Report S/N: 1C2302130007-11.BCG	Test Dates: 2/20/2023 - 4/20/2023	EUT Type: Head Mounted Device	Page 17 of 38

V 10.5 12/15/2021

7.6 System Calibration:

The following equipment setup was used to calibrate the Radar Waveform. A spectrum analyzer was used to establish the test signal level for each radar type. During this process, there were no transmissions by either the Master or Client Device. The spectrum analyzer was switched to the zero span (Time Domain) mode at the frequency of the Radar Waveform generator. Peak detection was utilized. The spectrum analyzer resolution bandwidth (RBW) and video bandwidth (VBW) were set to 3MHz.

The signal generator amplitude is adjusted so that the power level measured at the spectrum analyzer is equal to the DFS detection threshold -64 dBm . The required radiated threshold at the antenna port is $-64 \text{ dBm} + 0 \text{ dBi} + 1 \text{ dB} = -63 \text{ dBm}$ (Section 7.2).

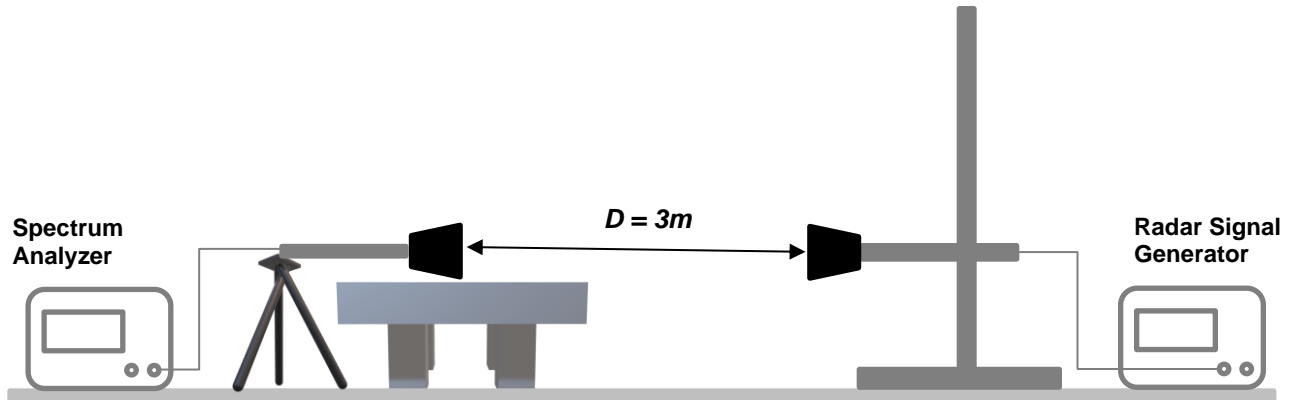



Figure 7-2. Radar Waveform Calibration

FCC ID: BCGA2117 IC: 579C-A2117		MEASUREMENT REPORT (CERTIFICATION)	Approved by: Technical Manager
Test Report S/N: 1C2302130007-11.BCG	Test Dates: 2/20/2023 - 4/20/2023	EUT Type: Head Mounted Device	Page 18 of 38

Radar Waveform Calibration Plot:

The radiated plots of the Radar Pulse Signals (Type 0) are given below after performing the system calibration as described in Section 7.6.

Short Pulse Radar Type 0:

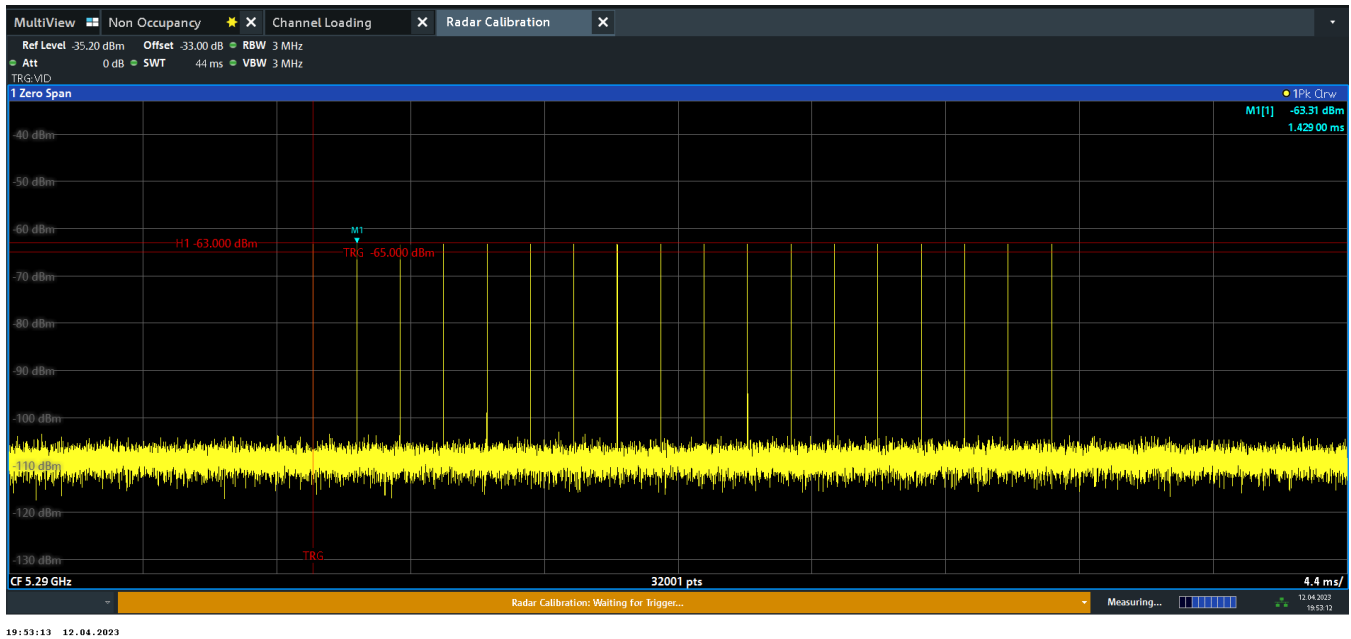

Figure 7-3. 5290MHz – Radar Pulse Type 0 (80MHz)

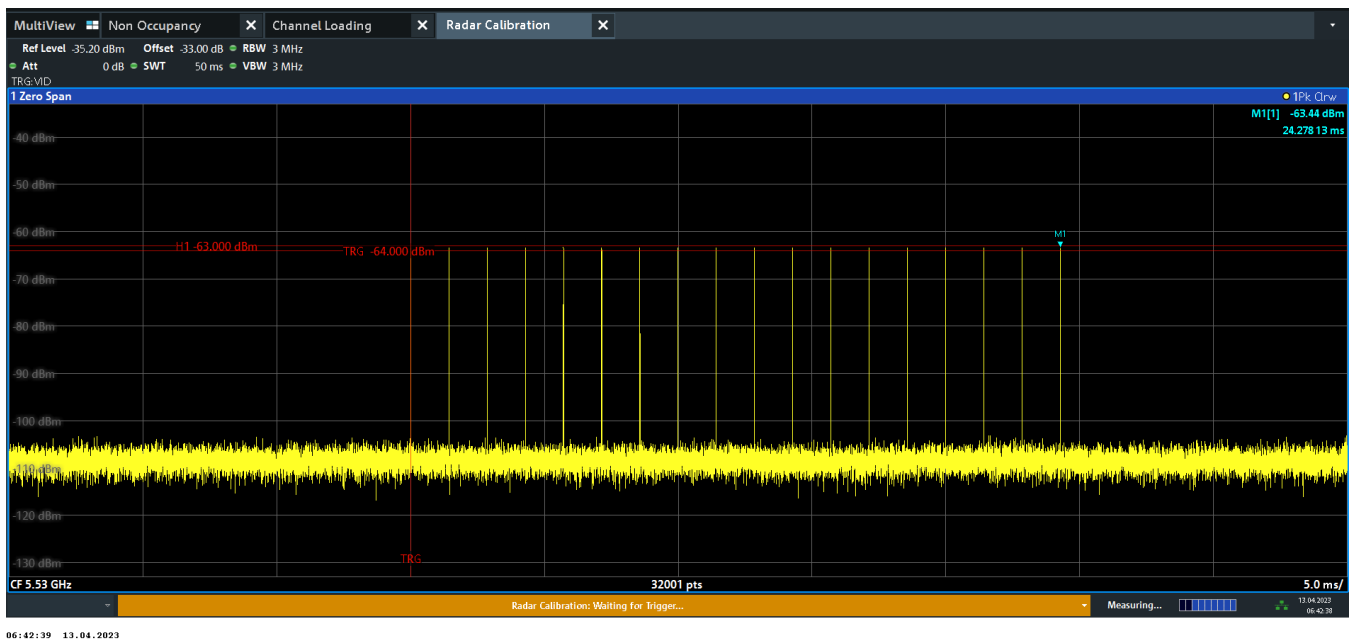



Figure 7-4. 5530MHz – Radar Pulse Type 0 (80MHz)

FCC ID: BCGA2117 IC: 579C-A2117		MEASUREMENT REPORT (CERTIFICATION)	Approved by: Technical Manager
Test Report S/N: 1C2302130007-11.BCG	Test Dates: 2/20/2023 - 4/20/2023	EUT Type: Head Mounted Device	Page 19 of 38

8.0 EUT COMMUNICATION MODES

The EUT was tested in 4 different test configurations,

Mode 1: Client Mode

Mode 2: Client to Client

Mode 3: Peer to Peer (EUT)

Mode 4: Peer to Peer (Apple TV)

Mode 1: Client Mode

Client is connected to Master (AP) via WLAN network and generates traffic using iPerf in a Server (Laptop). This Server is connected to the Master (AP) via WLAN. The Horn antenna is adjusted so that the WLAN traffic level, as displayed on the spectrum analyzer, is at lower amplitude than the radar detection threshold.

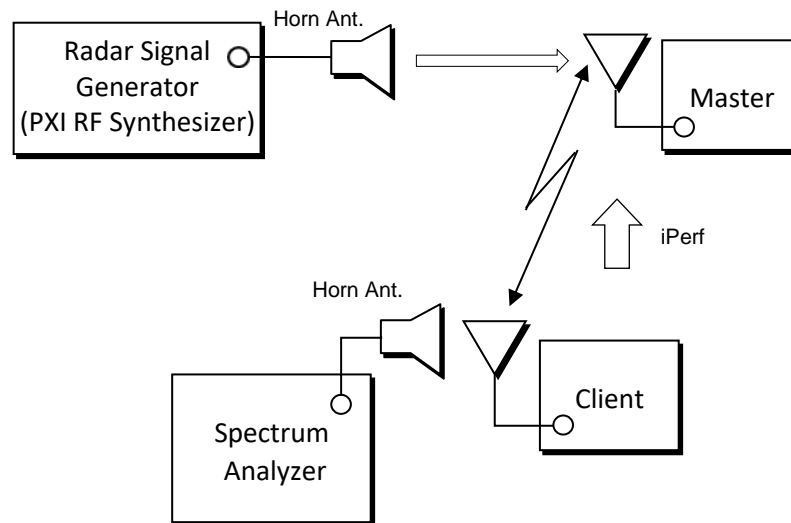

Figure 8-1. Test Setup (Mode 1)

FCC ID: BCGA2117 IC: 579C-A2117		MEASUREMENT REPORT (CERTIFICATION)	Approved by: Technical Manager
Test Report S/N: 1C2302130007-11.BCG	Test Dates: 2/20/2023 - 4/20/2023	EUT Type: Head Mounted Device	Page 20 of 38

V 10.5 12/15/2021

Mode 2: Client-to-Client Communications Mode

Client receives iPerf traffic from Server (Laptop) while linked to Master and streams the live display through Apple TV to Monitor display. The Horn antenna is adjusted so that the WLAN traffic level, as displayed on the spectrum analyzer, is at lower amplitude than the radar detection threshold.

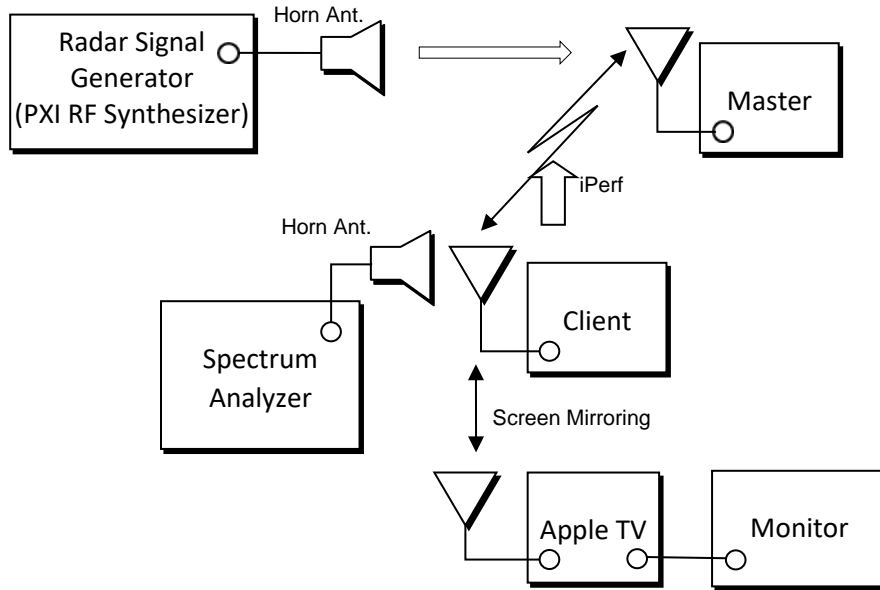



Figure 8-2. Test Setup (Mode 2)

FCC ID: BCGA2117 IC: 579C-A2117		MEASUREMENT REPORT (CERTIFICATION)	Approved by: Technical Manager
Test Report S/N: 1C2302130007-11.BCG	Test Dates: 2/20/2023 - 4/20/2023	EUT Type: Head Mounted Device	Page 21 of 38

Mode 3: Peer-to-Peer (EUT) Communications Mode

Generate and inject additional transmission:

1. Client and Apple TV must be linked to the Master.
2. Client begins mirroring live display via Apple TV.
3. Connect the Apple TV and Client to the support laptop and initiate additional transmission using iPerf.
4. After the additional transmission is injected, the Client must be disconnected to the Master.
5. Client stops and re-start mirroring screen.

Client mirrors live display through Apple TV to the Monitor display. The receive antenna/monitoring antenna is placed near the EUT. Additional data traffic was sent from the EUT (Client) to Apple TV (Server) using iPerf. The Horn antenna is adjusted so that the WLAN traffic level, as displayed on the spectrum analyzer, is at lower amplitude than the radar detection threshold.

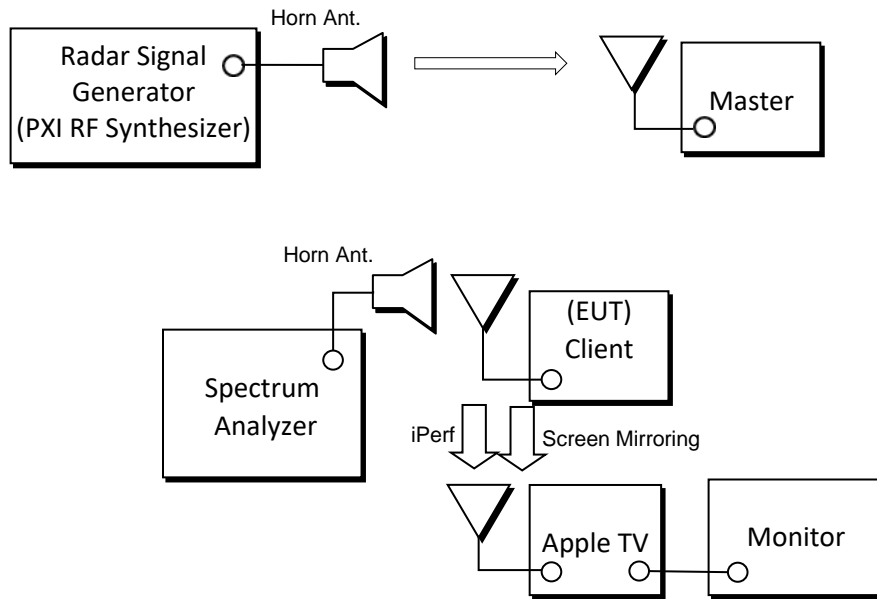

Figure 8-3. Test Setup (Mode 3)

FCC ID: BCGA2117 IC: 579C-A2117		MEASUREMENT REPORT (CERTIFICATION)	Approved by: Technical Manager
Test Report S/N: 1C2302130007-11.BCG	Test Dates: 2/20/2023 - 4/20/2023	EUT Type: Head Mounted Device	Page 22 of 38

Mode 4: Peer-to-Peer (Apple TV) Communications Mode

Generate and inject additional transmission:

1. Client and Apple TV must be linked to the Master.
2. Client begins mirroring live display via Apple TV.
3. Connect the Apple TV and Client to the support laptop and initiate additional transmission using iPerf.
4. After the additional transmission is injected, the Client must be disconnected to the Master.
5. Client stops and re-start mirroring screen.

Client mirrors live display through Apple TV to the Monitor display. The receive antenna/ monitoring antenna is placed near the Apple TV. Additional data traffic was sent from the Apple TV (Client) to the EUT (Server) using iPerf. The Horn antenna is adjusted so that the WLAN traffic level, as displayed on the spectrum analyzer, is at lower amplitude than the radar detection threshold.

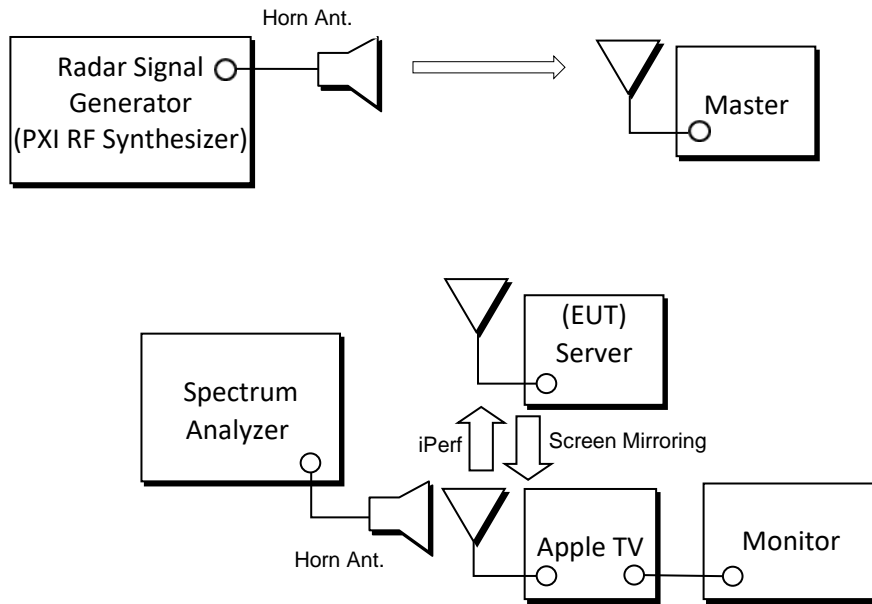

Figure 8-4. Test Setup (Mode 4)

In summary, for Modes 1 and Mode 2, Client is linked to the Master, and for Modes 3 and Mode 4, Client is not linked to the Master.

FCC ID: BCGA2117 IC: 579C-A2117		MEASUREMENT REPORT (CERTIFICATION)	Approved by: Technical Manager
Test Report S/N: 1C2302130007-11.BCG	Test Dates: 2/20/2023 - 4/20/2023	EUT Type: Head Mounted Device	Page 23 of 38

9.0 TEST RESULTS

9.1 Summary

Company Name: Apple Inc.
 FCC ID: BCGA2117
 IC: 579C-A2117
 FCC Classification: Unlicensed National Information Infrastructure (UNII)

	Mode	Parameter	Measured	Limit	Result
			80MHz Bandwidth		
5470 – 5725 MHz (excluding 5600-5650MHz for ISED Canada) UNII – 2C Band	1 Client Mode	Channel Move Time	0.932 s	10 seconds	Pass
		Channel Closing Transmission Time	< 200ms + 0.004 ms (aggregate)	200 ms + aggregate of 60ms over remaining 10 second period	Pass
		Non-Occupancy Period	Monitored for 30 minutes with no client transmission	30 Minutes	Pass
	2 Client to Client	Channel Move Time	0.889 s	10 seconds	Pass
		Channel Closing Transmission Time	< 200ms + 4.152 ms (aggregate)	200 ms + aggregate of 60ms over remaining 10 second period	Pass
		Non-Occupancy Period	Monitored for 30 minutes with no client transmission	30 Minutes	Pass
	3 Peer to Peer (EUT)	Channel Move Time	0.891 s	10 seconds	Pass
		Channel Closing Transmission Time	< 200ms + 4.226 ms (aggregate)	200 ms + aggregate of 60ms over remaining 10 second period	Pass
		Non-Occupancy Period	Monitored for 30 minutes with no client transmission	30 Minutes	Pass
	4 Peer to Peer (Apple TV)	Channel Move Time	0.806 s	10 seconds	Pass
		Channel Closing Transmission Time	< 200ms + 3.622 ms (aggregate)	200 ms + aggregate of 60ms over remaining 10 second period	Pass
		Non-Occupancy Period	Monitored for 30 minutes with no client transmission	30 Minutes	Pass

Table 9-1. Summary of Test Results

FCC ID: BCGA2117 IC: 579C-A2117		MEASUREMENT REPORT (CERTIFICATION)	Approved by: Technical Manager
Test Report S/N: 1C2302130007-11.BCG	Test Dates: 2/20/2023 - 4/20/2023	EUT Type: Head Mounted Device	Page 24 of 38

Notes:

- 1) The EUT was found to be compliant with the requirements for DFS as required for a Client Device per Part 15.407(h), RSS-247 and KDB 905462 D02 v02.
- 2) Automated test software was used to measure emissions and capture the corresponding plots necessary to show compliance. The list is given below,
 - DFS threshold count v1.1
 - DFS Radar Simulator and Analyzer v2.8 (Aeroflex Inc.)
 - iPerf Software

FCC ID: BCGA2117 IC: 579C-A2117	 MEASUREMENT REPORT (CERTIFICATION)	Approved by: Technical Manager
Test Report S/N: 1C2302130007-11.BCG	Test Dates: 2/20/2023 - 4/20/2023	EUT Type: Head Mounted Device
		Page 25 of 38

9.2 Channel Loading

9.2.1 Channel Loading Mode 1:

Channel Loading Notes:

Per KDB 905462 D02 v02, timing plots are required with calculations demonstrating a minimum channel loading of approximately 17% or greater. Channel loading can be estimated by setting the spectrum analyzer for zero span and approximate the transmission time.

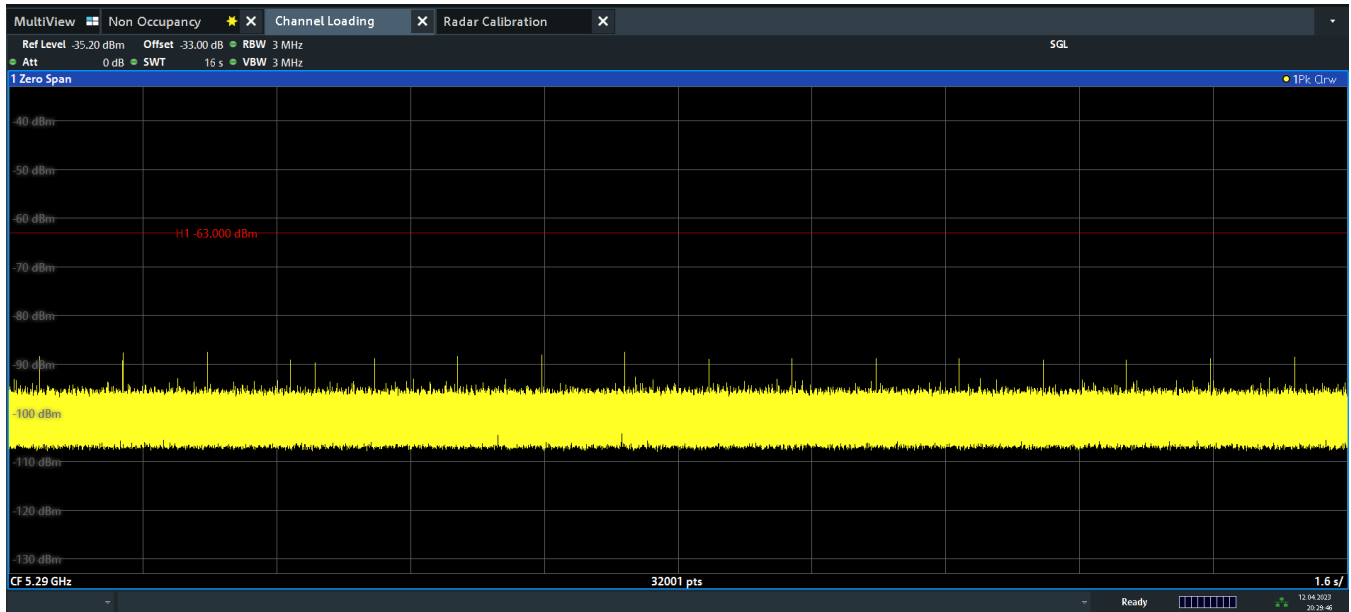

20:29:46 12.04.2023

Figure 9-1. 5290MHz - Channel Loading - Mode 1 (80MHz)

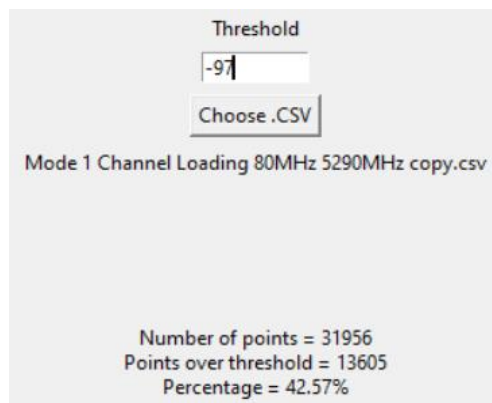

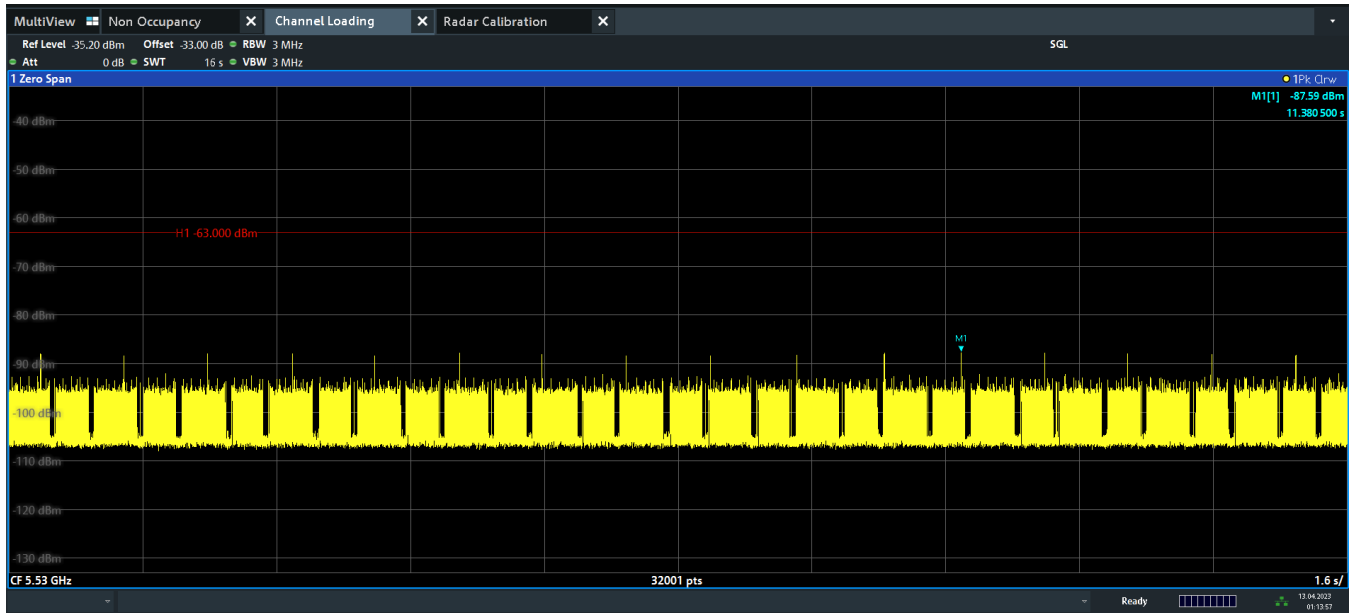

Figure 9-2. 5290MHz - Channel Loading Calculation - Mode 1 (80MHz)

FCC ID: BCGA2117 IC: 579C-A2117		MEASUREMENT REPORT (CERTIFICATION)	Approved by: Technical Manager
Test Report S/N: 1C2302130007-11.BCG	Test Dates: 2/20/2023 - 4/20/2023	EUT Type: Head Mounted Device	Page 26 of 38

V 10.5 12/15/2021

9.2.2 Channel Loading Mode 2:



01:13:58 13.04.2023

Figure 9-3. 5530MHz - Channel Loading - Mode 2 (80MHz)

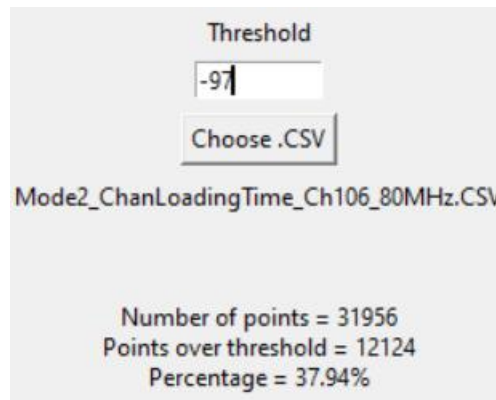



Figure 9-4. 5530MHz - Channel Loading Calculation - Mode 2 (80MHz)

FCC ID: BCGA2117 IC: 579C-A2117		MEASUREMENT REPORT (CERTIFICATION)	Approved by: Technical Manager
Test Report S/N: 1C2302130007-11.BCG	Test Dates: 2/20/2023 - 4/20/2023	EUT Type: Head Mounted Device	Page 27 of 38

V 10.5 12/15/2021

9.2.3 Channel Loading Mode 3:

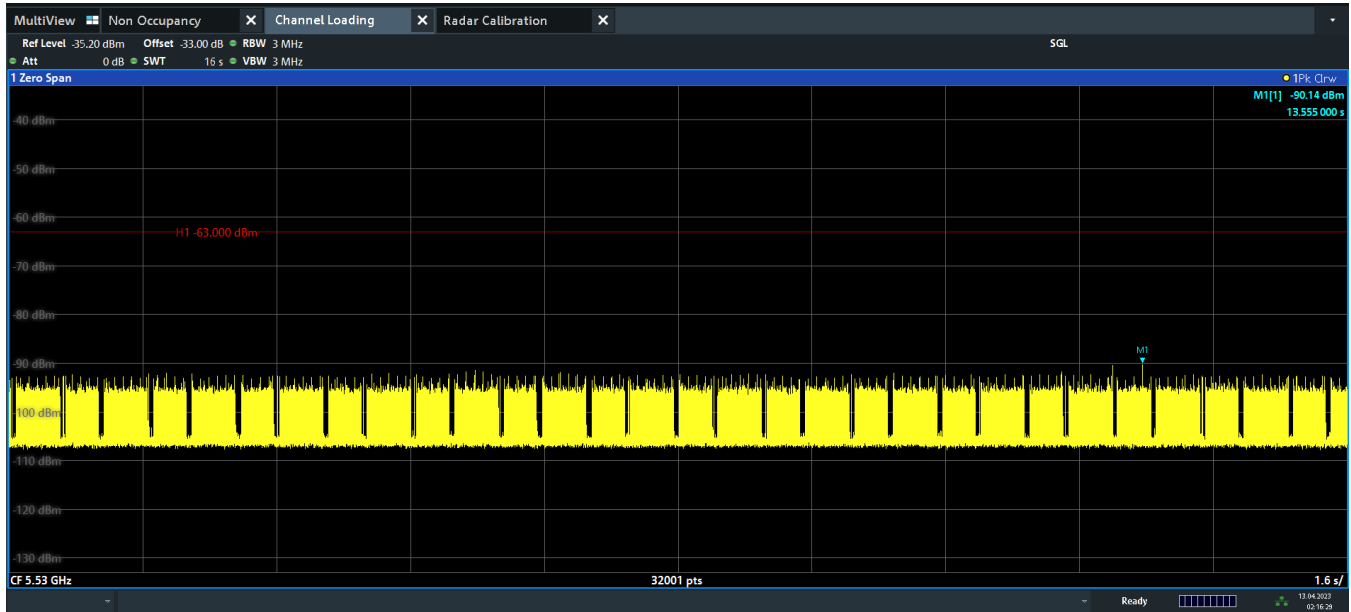

Figure 9-5. 5530MHz - Channel Loading - Mode 3 (80MHz)

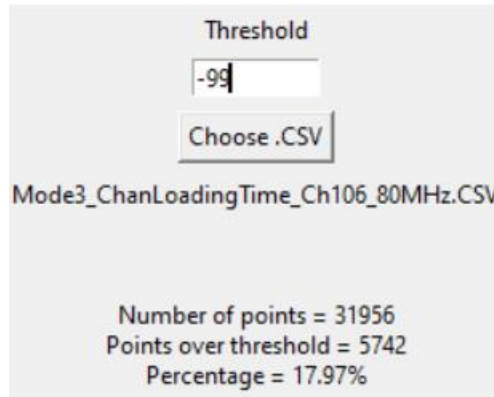



Figure 9-6. 5530MHz - Channel Loading Calculation - Mode 3 (80MHz)

FCC ID: BCGA2117 IC: 579C-A2117		MEASUREMENT REPORT (CERTIFICATION)	Approved by: Technical Manager
Test Report S/N: 1C2302130007-11.BCG	Test Dates: 2/20/2023 - 4/20/2023	EUT Type: Head Mounted Device	Page 28 of 38

9.2.4 Channel Loading Mode 4:

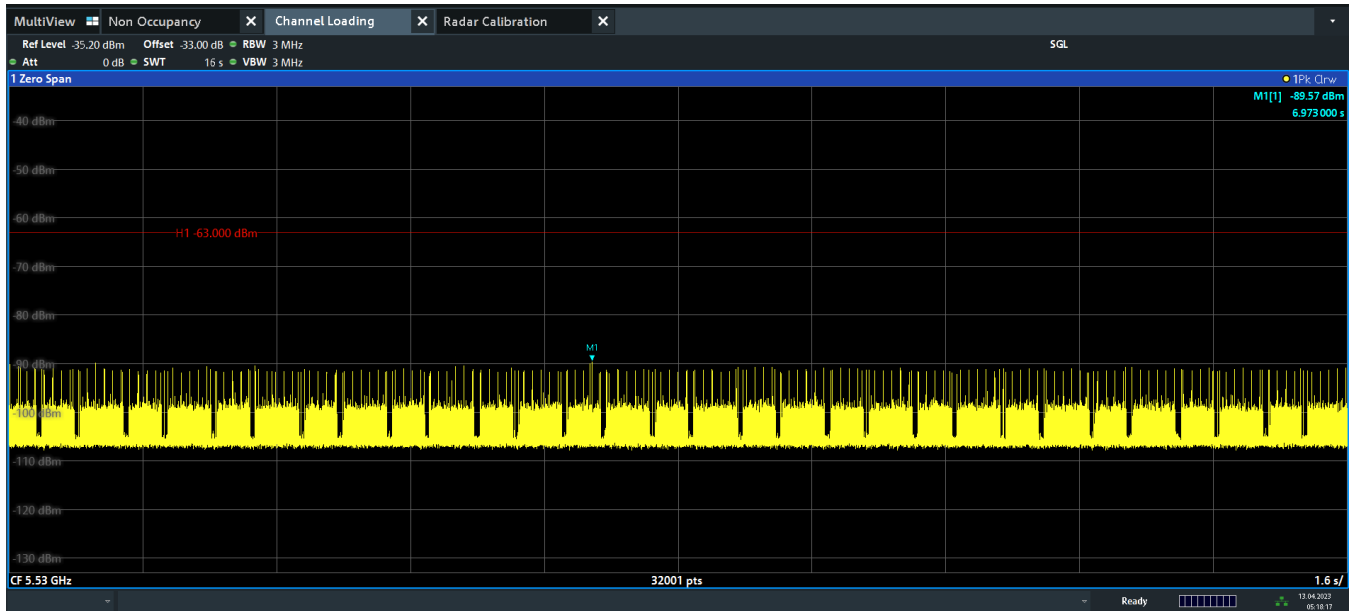

Figure 9-7. 5530MHz - Channel Loading - Mode 4 (80MHz)

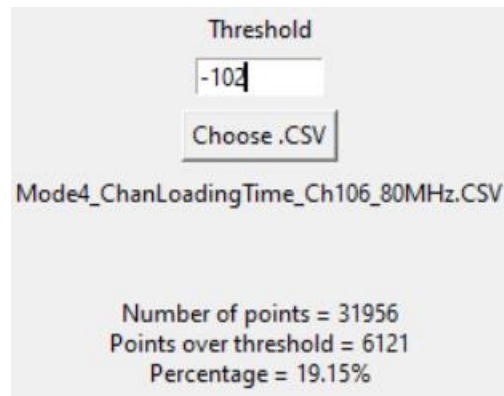



Figure 9-8. 5530MHz - Channel Loading Calculation - Mode 4 (80MHz)

FCC ID: BCGA2117 IC: 579C-A2117		MEASUREMENT REPORT (CERTIFICATION)	Approved by: Technical Manager
Test Report S/N: 1C2302130007-11.BCG	Test Dates: 2/20/2023 - 4/20/2023	EUT Type: Head Mounted Device	Page 29 of 38

9.3 Channel Move/ Closing Transmission Time

9.3.1 Channel Move/ Closing Transmission Time Mode 1:

Result

Parameter	Measured	Limit
	80MHz Bandwidth	
Channel Move Time	0.932 s	10 seconds
Channel Closing Transmission Time	< 200ms + 0.004 ms (aggregate)	200 ms + aggregate of 60ms over remaining 10 second period

Notes:

1. The pulses shown in the plots below have been determined to be from the Master AP.
2. Marker Info and Aggregate time results are shown on the right side of the plots below.

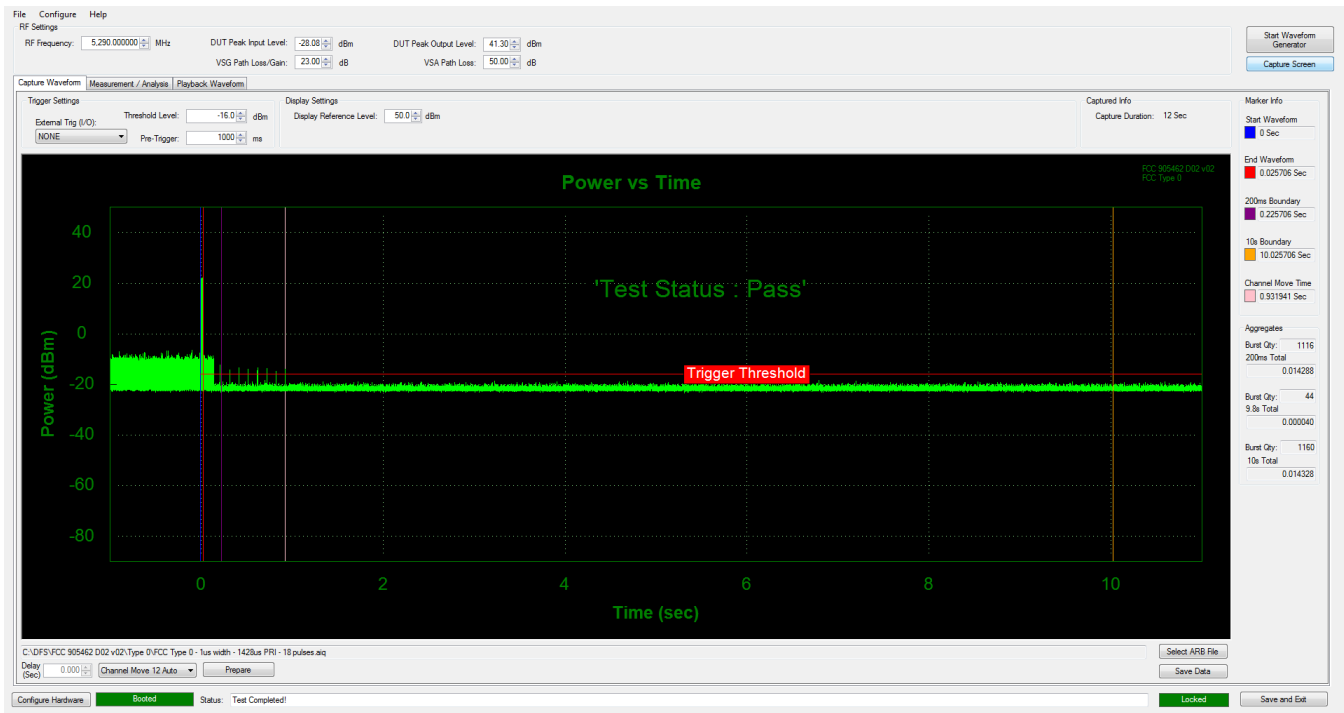



Figure 9-9. 5290MHz - Channel Move/ Closing Transmission Time - Mode 1 (80 MHz)

FCC ID: BCGA2117 IC: 579C-A2117		MEASUREMENT REPORT (CERTIFICATION)	Approved by: Technical Manager
Test Report S/N: 1C2302130007-11.BCG	Test Dates: 2/20/2023 - 4/20/2023	EUT Type: Head Mounted Device	Page 30 of 38

9.3.2 Channel Move/ Closing Transmission Time Mode 2:

Result:

Parameter	Measured	Limit
	80MHz Bandwidth	
Channel Move Time	0.889 s	10 seconds
Channel Closing Transmission Time	< 200ms + 4.152 ms (aggregate)	200 ms + aggregate of 60ms over remaining 10 second period

Notes:

1. The pulses shown in the plots below have been determined to be from the Master AP.
2. Marker Info and Aggregate time results are shown on the right side of the plots below.

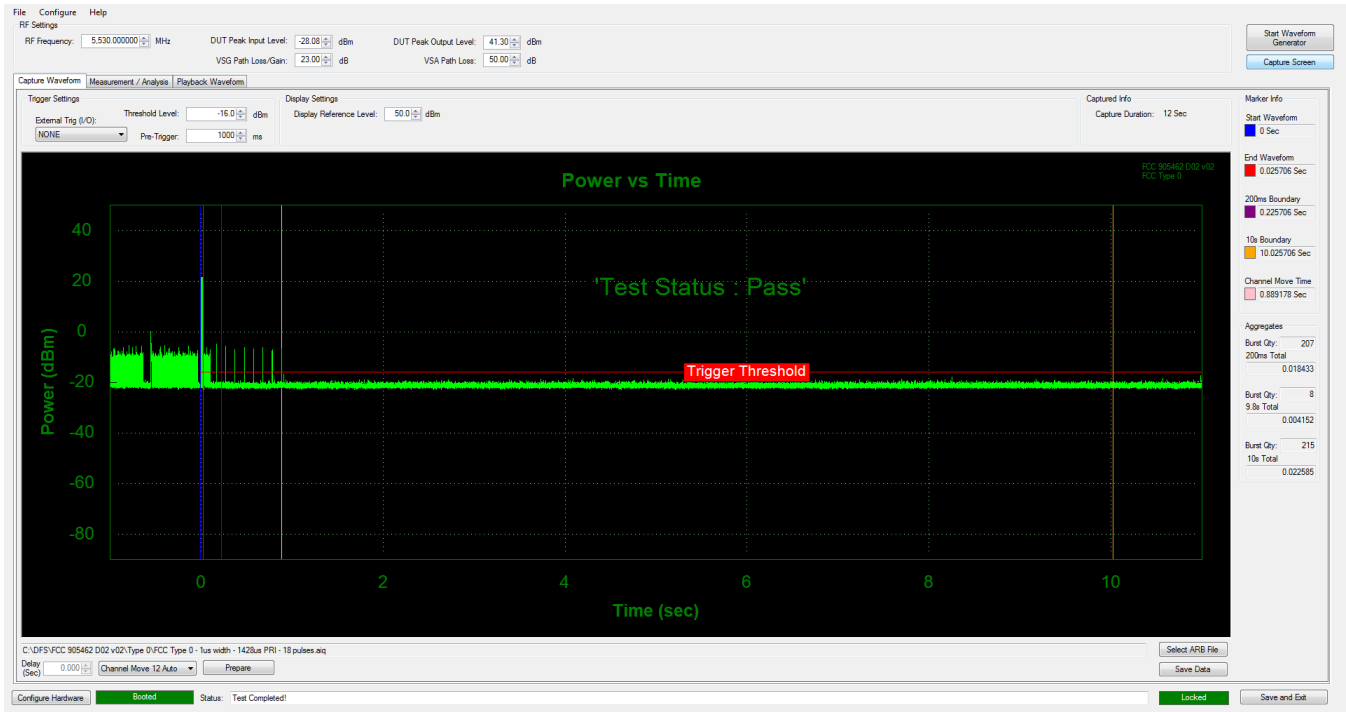

Figure 9-10. 5530MHz - Channel Move/ Closing Transmission Time - Mode 2 (80 MHz)

FCC ID: BCGA2117 IC: 579C-A2117		MEASUREMENT REPORT (CERTIFICATION)	Approved by: Technical Manager
Test Report S/N: 1C2302130007-11.BCG	Test Dates: 2/20/2023 - 4/20/2023	EUT Type: Head Mounted Device	Page 31 of 38

9.3.3 Channel Move/ Closing Transmission Time Mode 3:

Result:

Parameter	Measured	Limit
	80MHz Bandwidth	
Channel Move Time	0.891 s	10 seconds
Channel Closing Transmission Time	< 200ms + 4.226 ms (aggregate)	200 ms + aggregate of 60ms over remaining 10 second period

Notes:

1. The pulses shown in the plots below have been determined to be from the Master AP.
2. Marker Info and Aggregate time results are shown on the right side of the plots below.

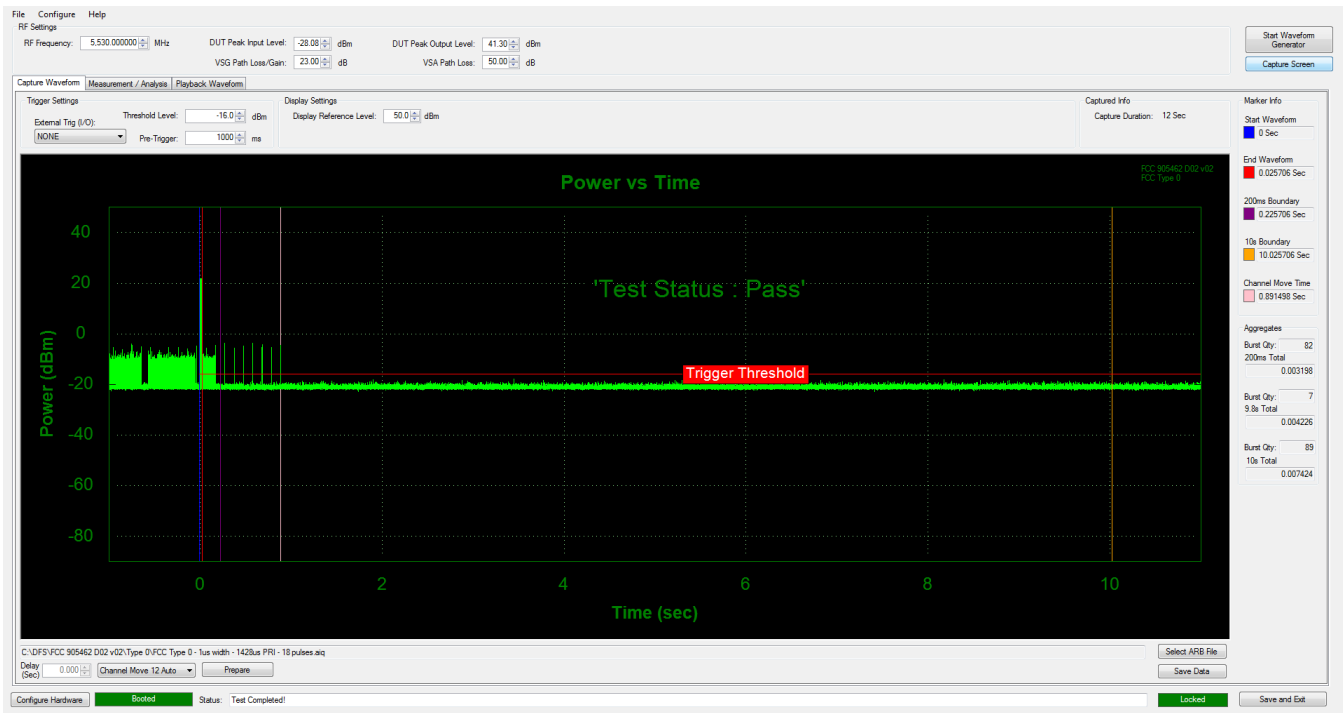



Figure 9-11. 5530MHz - Channel Move/ Closing Transmission Time - Mode 3 (80 MHz)

FCC ID: BCGA2117 IC: 579C-A2117		MEASUREMENT REPORT (CERTIFICATION)	Approved by: Technical Manager
Test Report S/N: 1C2302130007-11.BCG	Test Dates: 2/20/2023 - 4/20/2023	EUT Type: Head Mounted Device	Page 32 of 38

9.3.4 Channel Move/ Closing Transmission Time Mode 4:

Result:

Parameter	Measured	Limit
	80MHz Bandwidth	
Channel Move Time	0.806 s	10 seconds
Channel Closing Transmission Time	< 200ms + 3.622 ms (aggregate)	200 ms + aggregate of 60ms over remaining 10 second period

Notes:

1. The pulses shown in the plots below have been determined to be from the Master AP.
2. Marker Info and Aggregate time results are shown on the right side of the plots below.

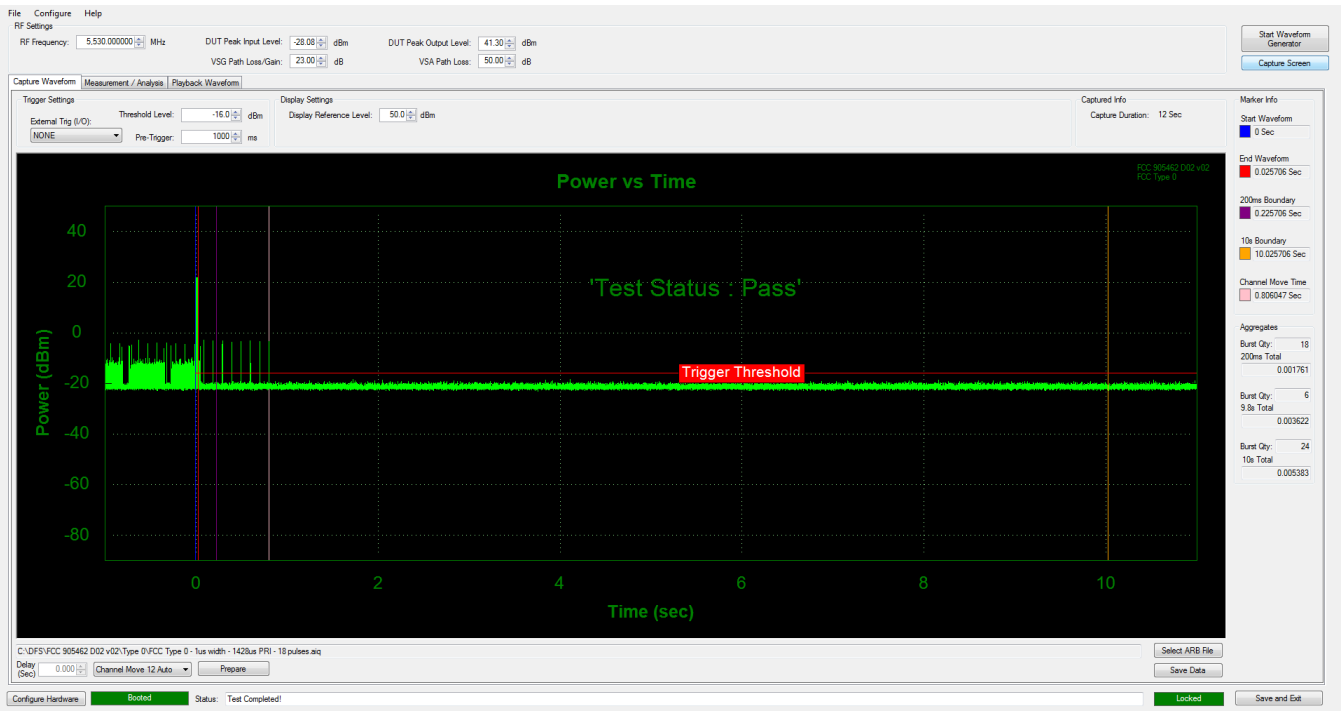

Figure 9-12. 5530MHz - Channel Move/ Closing Transmission Time - Mode 4 (80 MHz)

FCC ID: BCGA2117 IC: 579C-A2117		MEASUREMENT REPORT (CERTIFICATION)	Approved by: Technical Manager
Test Report S/N: 1C2302130007-11.BCG	Test Dates: 2/20/2023 - 4/20/2023	EUT Type: Head Mounted Device	Page 33 of 38

9.4 Non-Occupancy Period

9.4.1 Non-Occupancy Period (30 Minutes) Mode 1:

Notes:

1. No frequency transmission detected during the Non-Occupancy Period of 30 minutes monitoring.

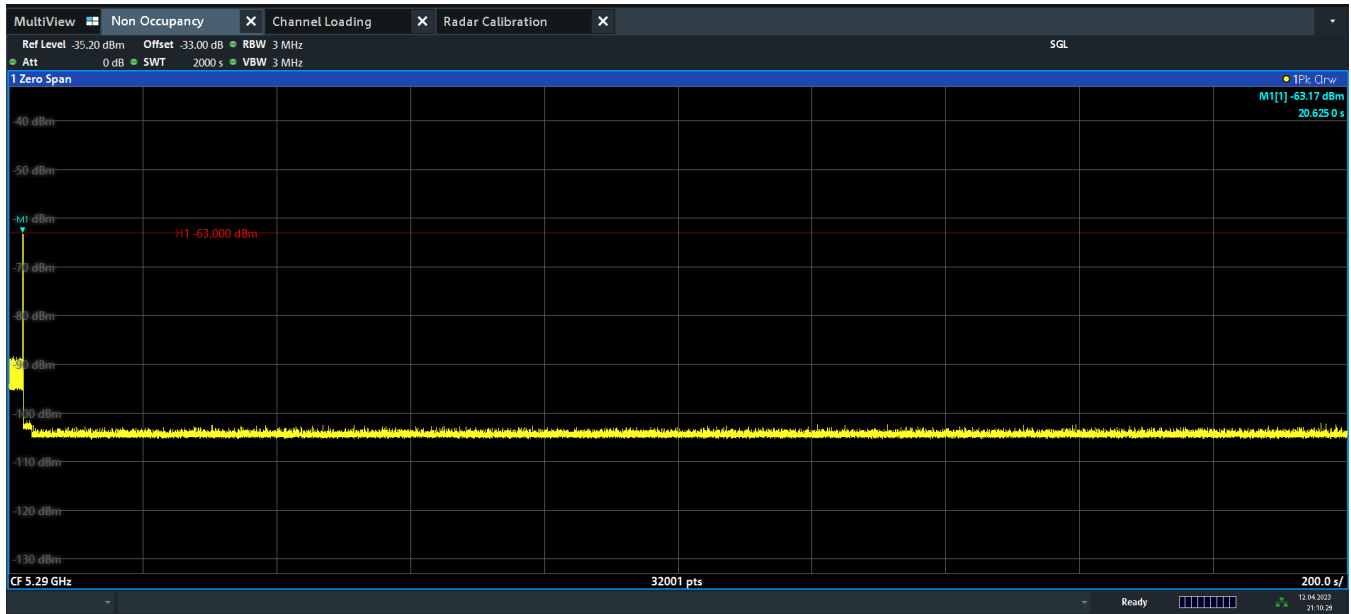



Figure 9-13. 5290MHz - Non-Occupancy Period (30 Minutes) - Mode 1 (80MHz)

FCC ID: BCGA2117 IC: 579C-A2117		MEASUREMENT REPORT (CERTIFICATION)	Approved by: Technical Manager
Test Report S/N: 1C2302130007-11.BCG	Test Dates: 2/20/2023 - 4/20/2023	EUT Type: Head Mounted Device	Page 34 of 38

9.4.2 Non-Occupancy Period (30 Minutes) Mode 2:

Notes:

1. No frequency transmission detected during the Non-Occupancy Period of 30 minutes monitoring.

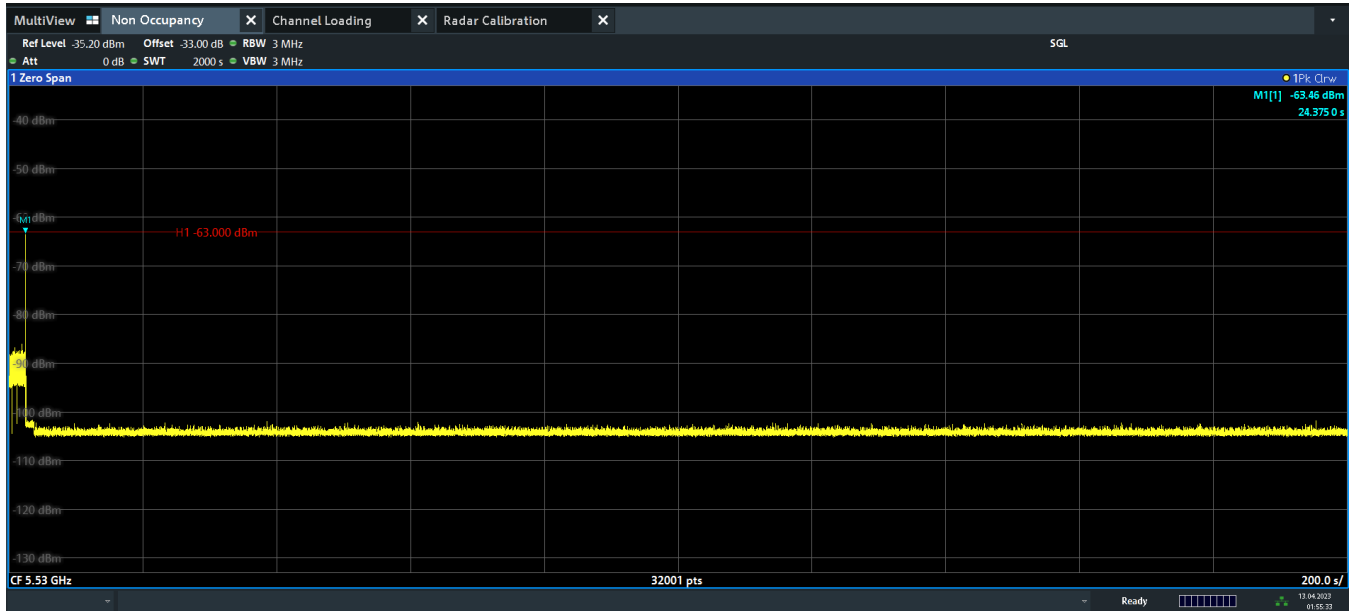

01:55:34 13.04.2023

Figure 9-14. 5530MHz - Non-Occupancy Period (30 Minutes) - Mode 2 (80MHz)

FCC ID: BCGA2117 IC: 579C-A2117		MEASUREMENT REPORT (CERTIFICATION)	Approved by: Technical Manager
Test Report S/N: 1C2302130007-11.BCG	Test Dates: 2/20/2023 - 4/20/2023	EUT Type: Head Mounted Device	Page 35 of 38

V 10.5 12/15/2021

9.4.3 Non-Occupancy Period (30 Minutes) Mode 3:

Notes:

1. No frequency transmission detected during the Non-Occupancy Period of 30 minutes monitoring.

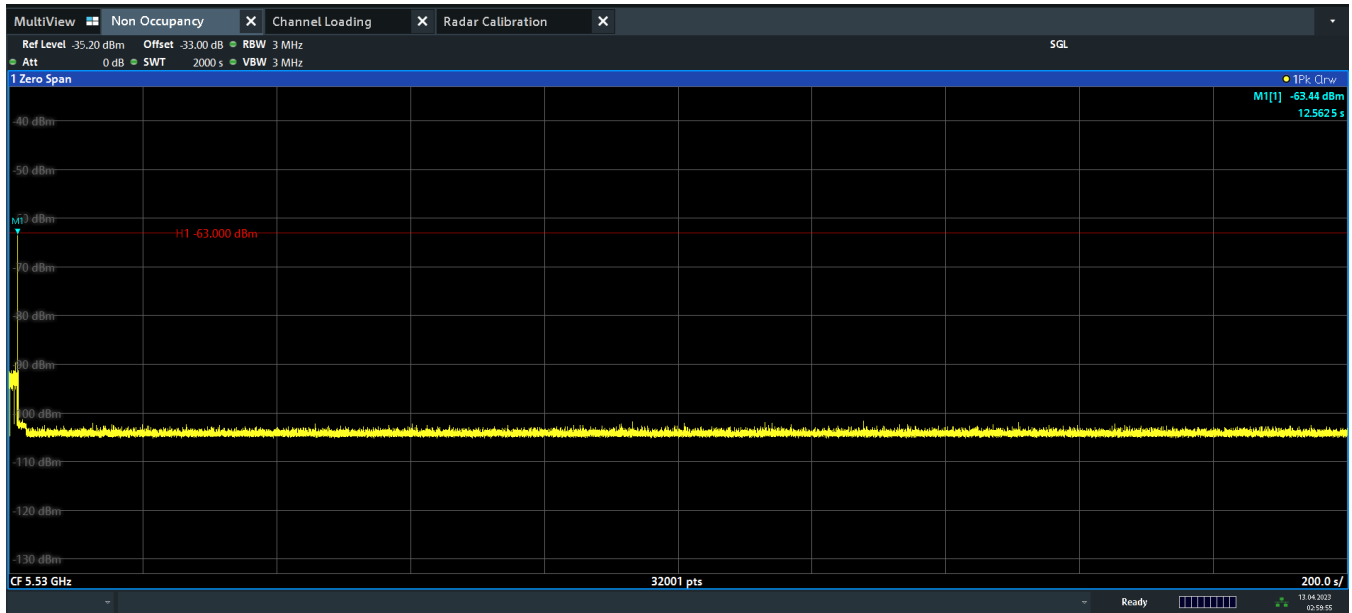

02:59:56 13.04.2023

Figure 9-15. 5530MHz - Non-Occupancy Period (30 Minutes) - Mode 3 (80MHz)

FCC ID: BCGA2117 IC: 579C-A2117	 MEASUREMENT REPORT (CERTIFICATION)	Approved by: Technical Manager
Test Report S/N: 1C2302130007-11.BCG	Test Dates: 2/20/2023 - 4/20/2023	EUT Type: Head Mounted Device
		Page 36 of 38

9.4.4 Non-Occupancy Period (30 Minutes) Mode 4

Notes:

1. No frequency transmission detected during the Non-Occupancy Period of 30 minutes monitoring.

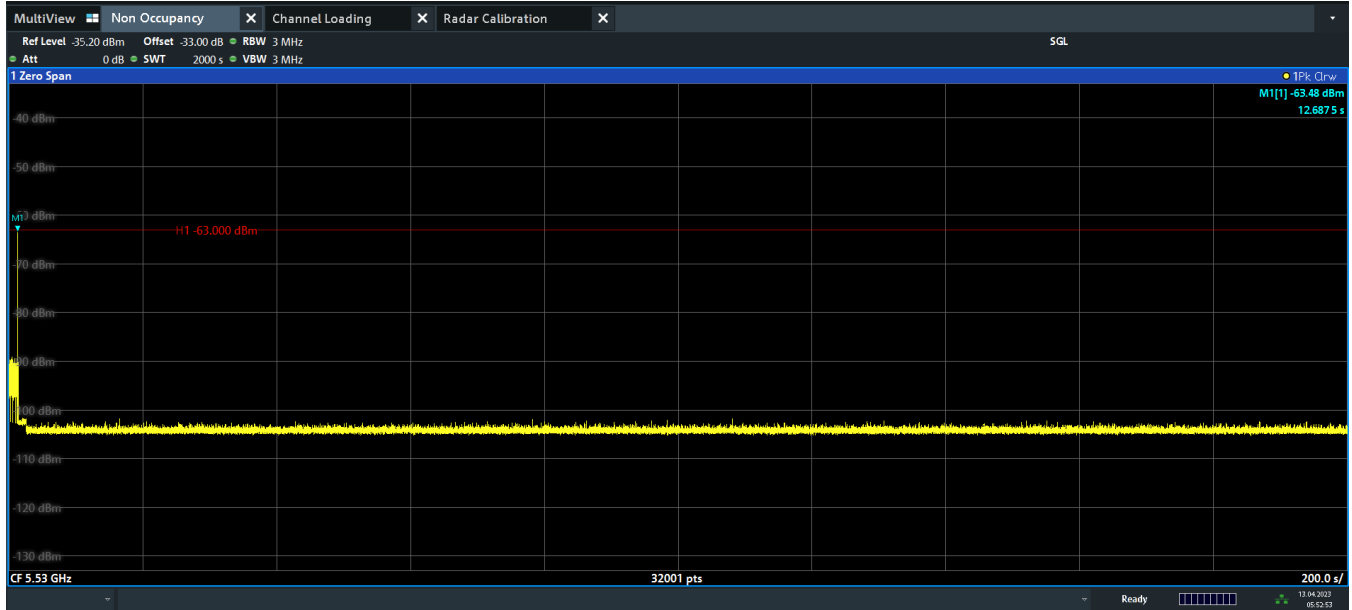

05:52:54 13.04.2023

Figure 9-16. 5530MHz - Non-Occupancy Period (30 Minutes) - Mode 4 (80MHz)

FCC ID: BCGA2117 IC: 579C-A2117	 MEASUREMENT REPORT (CERTIFICATION)	Approved by: Technical Manager
Test Report S/N: 1C2302130007-11.BCG		Test Dates: 2/20/2023 - 4/20/2023

10.0 CONCLUSION

The data collected relate only to the item(s) tested and show that the **Apple Head Mounted Device FCC ID: BCGA2117, IC: 579C-A2117** is in compliance with the DFS requirements for a Client Device without radar detection in accordance with Part 15.407 of the FCC Rules and RSS-247 of the Innovation, Science and Economic Development Canada Rules.

FCC ID: BCGA2117 IC: 579C-A2117	 MEASUREMENT REPORT (CERTIFICATION)	Approved by: Technical Manager
Test Report S/N: 1C2302130007-11.BCG	Test Dates: 2/20/2023 - 4/20/2023	EUT Type: Head Mounted Device
		Page 38 of 38

V 10.5 12/15/2021