



**FCC 47 CFR PART 15 SUBPART C
INDUSTRY CANADA RSS-247 ISSUE 1**

**BLUETOOTH LOW ENERGY
CERTIFICATION TEST REPORT**

FOR

PORTABLE COMPUTER

MODEL NUMBER: A1707

**FCC ID: BCGA1707
IC: 579C-A1707**

REPORT NUMBER: 16U23800-E2V1

ISSUE DATE: SEPTEMBER 28, 2016

Prepared for
**APPLE, INC.
1 INFINITE LOOP
CUPERTINO, CA 95014, U.S.A.**

Prepared by
**UL VERIFICATION SERVICES INC.
47173 BENICIA STREET
FREMONT, CA 94538, U.S.A.
TEL: (510) 771-1000
FAX: (510) 661-0888**



NVLAP LAB CODE 200065-0

Revision History

<u>Rev.</u>	<u>Issue Date</u>	<u>Revisions</u>	<u>Revised By</u>
V1	09/28/2016	Initial Issue	Chin Pang

TABLE OF CONTENTS

1. ATTESTATION OF TEST RESULTS	4
2. TEST METHODOLOGY	5
3. FACILITIES AND ACCREDITATION	5
4. CALIBRATION AND UNCERTAINTY	6
4.1. <i>MEASURING INSTRUMENT CALIBRATION</i>	<i>6</i>
4.2. <i>SAMPLE CALCULATION</i>	<i>6</i>
4.3. <i>MEASUREMENT UNCERTAINTY.....</i>	<i>6</i>
5. EQUIPMENT UNDER TEST	7
5.1. <i>DESCRIPTION OF EUT</i>	<i>7</i>
5.2. <i>MAXIMUM OUTPUT POWER.....</i>	<i>7</i>
5.3. <i>DESCRIPTION OF AVAILABLE ANTENNAS</i>	<i>7</i>
5.4. <i>SOFTWARE AND FIRMWARE.....</i>	<i>7</i>
5.5. <i>WORST-CASE CONFIGURATION AND MODE.....</i>	<i>8</i>
5.6. <i>DESCRIPTION OF TEST SETUP.....</i>	<i>9</i>
6. TEST AND MEASUREMENT EQUIPMENT	14
7. ANTENNA PORT TEST RESULTS	15
7.1. <i>MEASUREMENT METHODS</i>	<i>15</i>
7.2. <i>6 dB BANDWIDTH.....</i>	<i>18</i>
7.3. <i>99% BANDWIDTH.....</i>	<i>21</i>
7.4. <i>AVERAGE POWER.....</i>	<i>24</i>
7.5. <i>OUTPUT POWER.....</i>	<i>25</i>
7.6. <i>POWER SPECTRAL DENSITY</i>	<i>26</i>
7.7. <i>CONDUCTED SPURIOUS EMISSIONS.....</i>	<i>29</i>
8. RADIATED TEST RESULTS.....	33
8.1. <i>LIMITS AND PROCEDURE.....</i>	<i>33</i>
8.2. <i>TRANSMITTER ABOVE 1 GHz.....</i>	<i>34</i>
8.3. <i>WORST-CASE BELOW 1 GHz.....</i>	<i>44</i>
8.4. <i>WORST-CASE 18 to 26 GHz.....</i>	<i>46</i>
9. AC POWER LINE CONDUCTED EMISSIONS.....	48
10. SETUP PHOTOS	51

1. ATTESTATION OF TEST RESULTS

COMPANY NAME: APPLE, INC.
1 INFINITE LOOP
CUPERTINO, CA 95014, U.S.A.

EUT DESCRIPTION: PORTABLE COMPUTER

MODEL: A1707

SERIAL NUMBER: C02S3002H79V

DATE TESTED: AUGUST 18 – SEPTEMBER 07, 2016

APPLICABLE STANDARDS	
STANDARD	TEST RESULTS
CFR 47 Part 15 Subpart C	Pass
INDUSTRY CANADA RSS-247 Issue 1	Pass
INDUSTRY CANADA RSS-GEN Issue 4	Pass

UL Verification Services Inc. tested the above equipment in accordance with the requirements set forth in the above standards. All indications of Pass/Fail in this report are opinions expressed by UL Verification Services Inc. based on interpretations and/or observations of test results. Measurement Uncertainties were not taken into account and are published for informational purposes only. The test results show that the equipment tested is capable of demonstrating compliance with the requirements as documented in this report.

Note: The results documented in this report apply only to the tested sample, under the conditions and modes of operation as described herein. This document may not be altered or revised in any way unless done so by UL Verification Services Inc. and all revisions are duly noted in the revisions section. Any alteration of this document not carried out by UL Verification Services Inc. will constitute fraud and shall nullify the document. This report must not be used by the client to claim product certification, approval, or endorsement by NVLAP, NIST, any agency of the Federal Government, or any agency of any government.

Approved & Released For
UL Verification Services Inc. By:



CHIN PANG
SENIOR ENGINEER
UL VERIFICATION SERVICES INC.

Prepared By:



ERIC YU
EMC LAB ENGINEER
UL VERIFICATION SERVICES INC.

2. TEST METHODOLOGY

The tests documented in this report were performed in accordance with FCC CFR 47 Part 2, FCC CFR 47 Part 15, KDB 558074 D01 v03r05, ANSI C63.10-2013, RSS-GEN Issue 4, and RSS-247 Issue 1.

3. FACILITIES AND ACCREDITATION

The test sites and measurement facilities used to collect data are located at 47173 and 47266 Benicia Street, Fremont, California, USA. Line conducted emissions are measured only at the 47173 address. The following table identifies which facilities were utilized for radiated emission measurements documented in this report. Specific facilities are also identified in the test results sections.

47173 Benicia Street	47266 Benicia Street
<input type="checkbox"/> Chamber A	<input type="checkbox"/> Chamber D
<input type="checkbox"/> Chamber B	<input type="checkbox"/> Chamber E
<input type="checkbox"/> Chamber C	<input type="checkbox"/> Chamber F
	<input type="checkbox"/> Chamber G
	<input checked="" type="checkbox"/> Chamber H

The above test sites and facilities are covered under FCC Test Firm Registration # 208313. Chambers A through H are covered under Industry Canada company address code 2324B with site numbers 2324B -1 through 2324B-8, respectively.

UL Verification Services Inc. is accredited by NVLAP, Laboratory Code 200065-0. The full scope of accreditation can be viewed at <http://ts.nist.gov/standards/scopes/2000650.htm>.

4. CALIBRATION AND UNCERTAINTY

4.1. MEASURING INSTRUMENT CALIBRATION

The measuring equipment utilized to perform the tests documented in this report has been calibrated in accordance with the manufacturer's recommendations, and is traceable to recognized national standards.

4.2. SAMPLE CALCULATION

Where relevant, the following sample calculation is provided:

$$\begin{aligned} \text{Field Strength (dBuV/m)} &= \text{Measured Voltage (dBuV)} + \text{Antenna Factor (dB/m)} + \\ &\text{Cable Loss (dB)} - \text{Preamp Gain (dB)} \\ 36.5 \text{ dBuV} + 18.7 \text{ dB/m} + 0.6 \text{ dB} - 26.9 \text{ dB} &= 28.9 \text{ dBuV/m} \end{aligned}$$

4.3. MEASUREMENT UNCERTAINTY

Where relevant, the following measurement uncertainty levels have been estimated for tests performed on the apparatus:

PARAMETER	UNCERTAINTY
Conducted Disturbance, 9KHz to 0.15 MHz	3.84 dB
Conducted Disturbance, 0.15 to 30 MHz	3.65 dB
Radiated Disturbance, 9KHz to 30 MHz	3.15 dB
Radiated Disturbance, 30 to 1000 MHz	5.36 dB
Radiated Disturbance, 1000 to 18000 MHz	4.32 dB
Radiated Disturbance, 18000 to 26000 MHz	4.45 dB
Radiated Disturbance, 26000 to 40000 MHz	5.24 dB

Uncertainty figures are valid to a confidence level of 95%.

5. EQUIPMENT UNDER TEST

5.1. DESCRIPTION OF EUT

The EUT is a portable computer with Bluetooth and WLAN Radios (AC 80 MHz Beam Forming).

5.2. MAXIMUM OUTPUT POWER

The transmitter has a maximum peak conducted output power as follows:

Frequency Range (MHz)	Mode	Output Power (dBm)	Output Power (mW)
2402 - 2480	BLE	7.00	5.01

5.3. DESCRIPTION OF AVAILABLE ANTENNAS

Frequency Band (GHz)	Antenna Gain Chain 0 (dBi)
2.4	2.1

5.4. SOFTWARE AND FIRMWARE

The firmware installed in the EUT during testing was v234 c4096

5.5. WORST-CASE CONFIGURATION AND MODE

The worst-case mode and channel used for 30-1000 MHz radiated and power line conducted emissions was including headset, AC charger and the mode and channel with the highest output power.

For Above 1GHz, 18-26GHz, EUT was investigated with and without AC Charger. And the worst was determined to be EUT with AC Charger. Therefore, all final radiated testing was performed with AC Charger.

Worst-case data rates as provided by the client were:

BLE: 1 Mbps.

For simultaneous transmission of multiple channels from the same antenna in the 2.4GHz and 5GHz bands, tests were conducted for various configurations having the highest power. No noticeable new emission was found.

5.6. DESCRIPTION OF TEST SETUP

SUPPORT EQUIPMENT

Support Equipment List				
Description	Manufacturer	Model	Serial Number	FCC ID
AC/ DC Adapter	Apple Inc.	A1540	N/A	N/A

I/O CABLES (CONDUCTED TEST)

I/O Cable List						
Cable No	Port	# of identical ports	Connector Type	Cable Type	Cable Length (m)	Remarks
1	Antenna	2	SMA	Un-Shielded	0.2	To Spectrum Analyzer
2	DC	1	Lightning	Un-Shielded	2	N/A

I/O CABLES (ABOVE 1G RADIATED TEST)

I/O Cable List						
Cable No	Port	# of identical ports	Connector Type	Cable Type	Cable Length (m)	Remarks
1	DC	1	Lightning	Un-Shielded	2	N/A

I/O CABLES (BELOW 1G RADIATED AND AC POWER CONDUCTED TEST)

I/O Cable List						
Cable No	Port	# of identical ports	Connector Type	Cable Type	Cable Length (m)	Remarks
1	DC	1	Lightning	Un-Shielded	2	NA
2	Audio	1	Jack	Un-Shielded	0.5	NA

TEST SETUP- CONDUCTED PORT

The EUT was tested connected to spectrum analyzer via antenna port. Test software exercised the EUT.

SETUP DIAGRAM

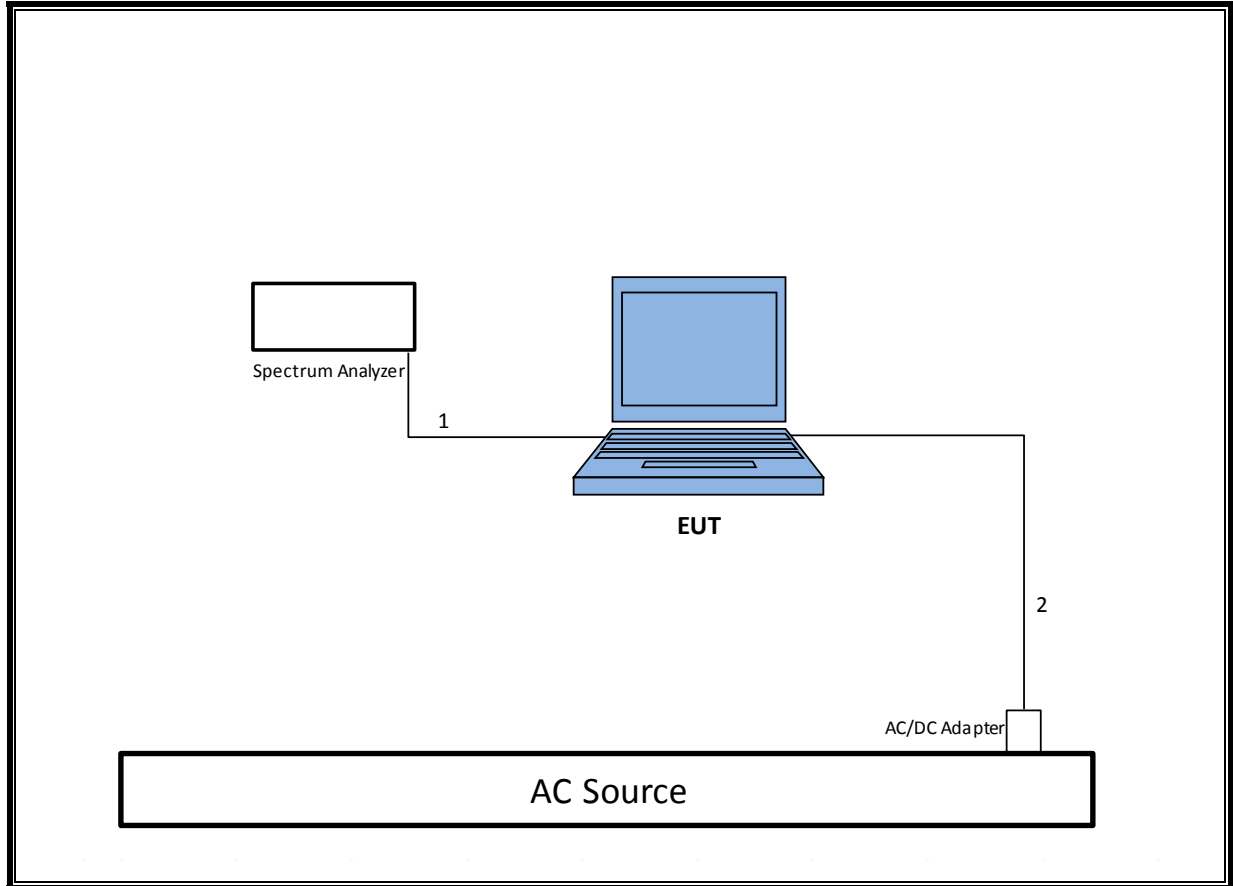

TEST SETUP- RADIATED- ABOVE 1 GHz

The EUT was powered by AC/DC adapter. Test software exercised the EUT.

SETUP DIAGRAM

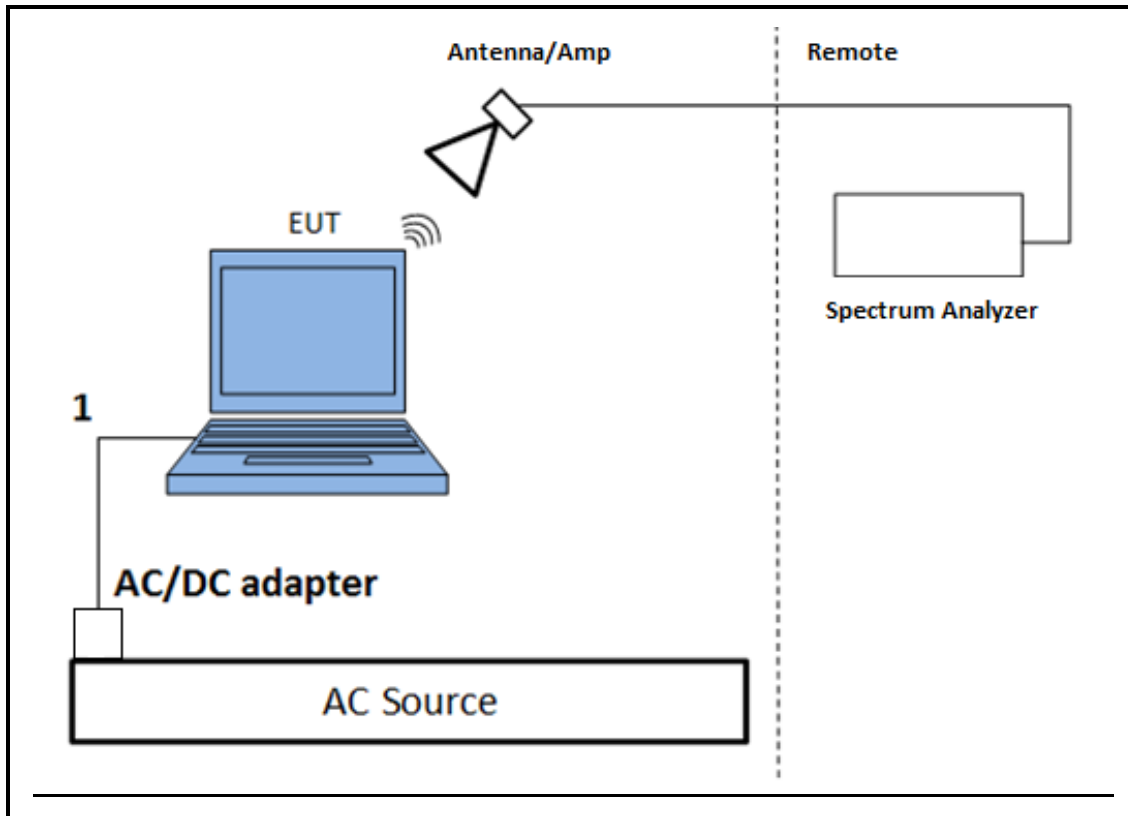

TEST SETUP- RADIATED- BELOW 1 GHz

The EUT was powered by AC/DC adapter and with earphone plugged in. Test software exercised the EUT.

SETUP DIAGRAM

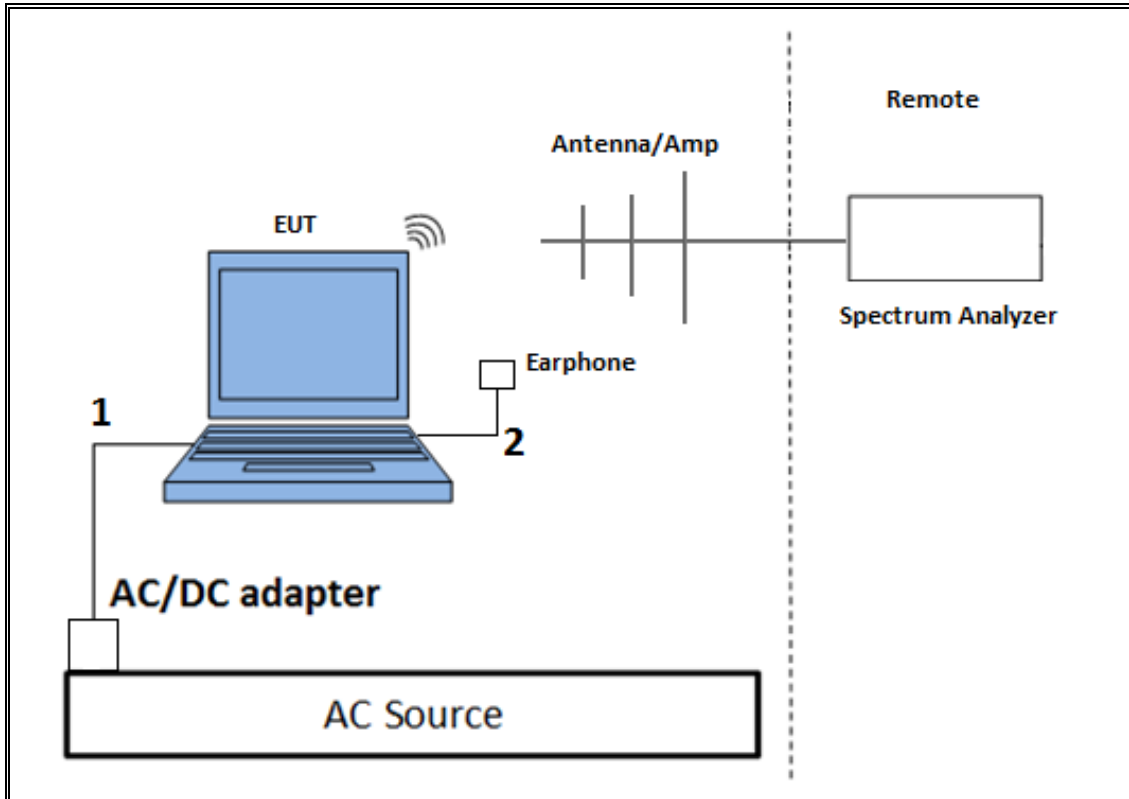

TEST SETUP- AC LINE CONDUCTED TESTS

The EUT was powered by AC/DC adapter and with earphone plugged in. Test software exercised the EUT.

SETUP DIAGRAM

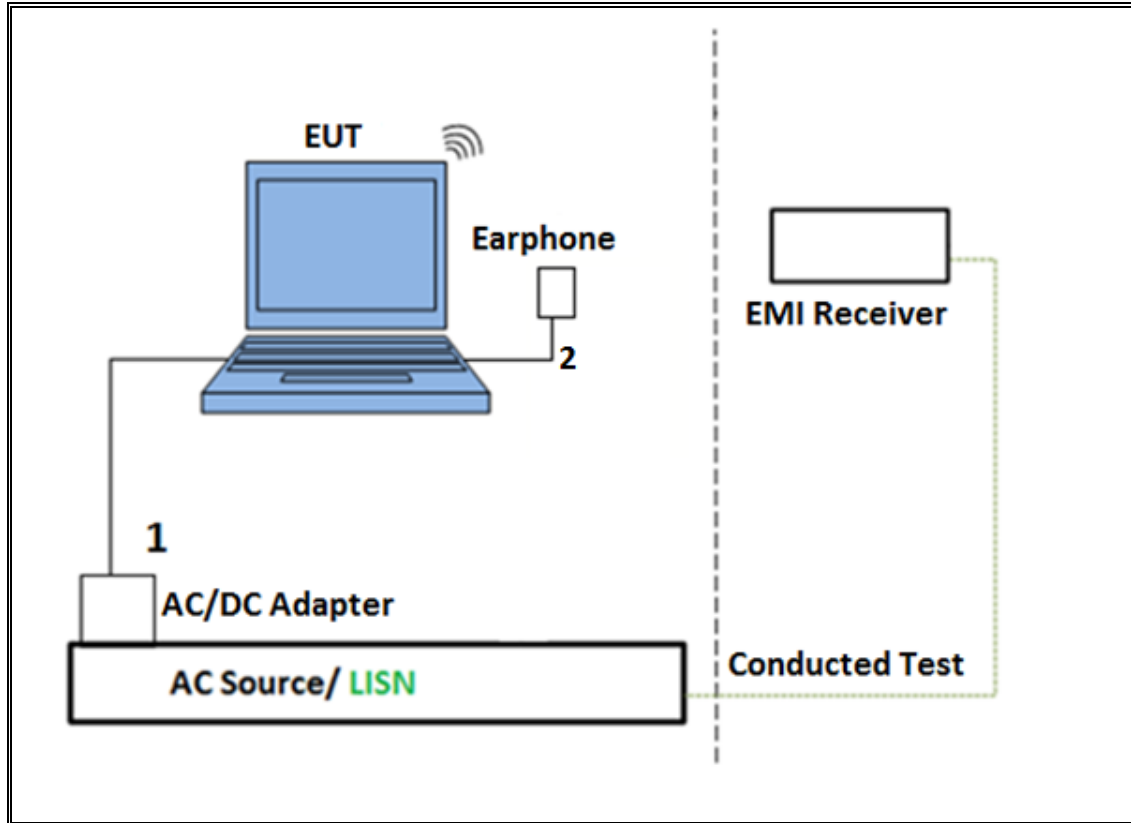

6. TEST AND MEASUREMENT EQUIPMENT

The following test and measurement equipment was utilized for the tests documented in this report:

Test Equipment List				
Description	Manufacturer	Model	T Number	Cal Due
Antenna, Horn 1-18GHz	ETS Lindgren	3117	T120	4/5/2017
Antenna, Broadband Hybrid, 30MHz to 2000MHz	Sunol Sciences	JB3	T122	1/29/2017
Amplifier, 10KHz to 1GHz, 32dB	Sonoma	310N	T173	6/17/2017
Spectrum Analyzer, PXA, 3Hz to 44GHz	Agilent	N9030A	T341	10/14/2016
Antenna, Horn 1-18GHz	ETS Lindgren	3117	T862	4/18/2017
Antenna, Broadband Hybrid, 30MHz to 2000MHz	Sunol Sciences	JB3	T899	5/26/2017
Amplifier, 1 - 18GHz	Miteq	AFS42-00101800-25-S-42	T491	5/31/2017
Amplifier, 10KHz to 1GHz, 32dB	Sonoma	310N	T834	6/17/2017
Spectrum Analyzer, PXA, 3Hz to 44GHz	Agilent	N9030A	T340	11/16/2016
Power Meter, P-series single channel	Agilent	N1911A	T1271	7/8/2017
Power Sensor, P - series, 50MHz to 18GHz, Wideband	Agilent	N1921A	T1228	6/20/2017
Antenna, Horn 18 to 26.5GHz	ARA	MWH-1826	T447	6/16/2017
Amplifier, 1 to 26.5GHz, 23.5dB Gain minimum	Keysight	8449B	T402	7/5/2017
AC Line Conducted				
EMI Test Receiver 9KHz-7GHz	Rohde & Schwarz	ESCI7	T1436	12/19/2016
LISN for Conducted Emissions CISPR-16	Fischer	50/250-25-2-01	T1310	6/8/2017
AC Source	Shaffner	NSG 1007	T134	9/11/2016
UL SOFTWARE				
* Radiated Software	UL	UL EMC	Ver 9.5, June 24, 2015	
* Conducted Software	UL	UL EMC	Ver 4.0, January 11, 2016	
* AC Line Conducted Software	UL	UL EMC	Ver 9.5, May 26, 2015	

Note: * indicates automation software version used in the compliance certification testing

7. ANTENNA PORT TEST RESULTS

7.1. MEASUREMENT METHODS

6 dB BW: KDB 558074 D01 v03r05, Section 8.1.

Output Power: KDB 558074 D01 v03r05, Section 9.1.2.

Power Spectral Density: KDB 558074 D01 v03r05, Section 10.2.

Out-of-band emissions in non-restricted bands: KDB 558074 D01 v03r05, Section 11.0.

Out-of-band emissions in restricted bands: KDB 558074 D01 v03r05, Section 12.1.

Band-edge: KDB 558074 D01 v03r05, Section 12.1.

DUTY CYCLE

LIMITS

None; for reporting purposes only.

PROCEDURE

KDB 558074 Zero-Span Spectrum Analyzer Method.

ON TIME AND DUTY CYCLE RESULTS

Mode	ON Time B (msec)	Period (msec)	Duty Cycle x (linear)	Duty Cycle (%)	Duty Cycle Correction Factor (dB)	1/B Minimum VBW (kHz)
BLE	0.532	1.250	0.426	42.57%	3.71	1.879

DUTY CYCLE PLOTS

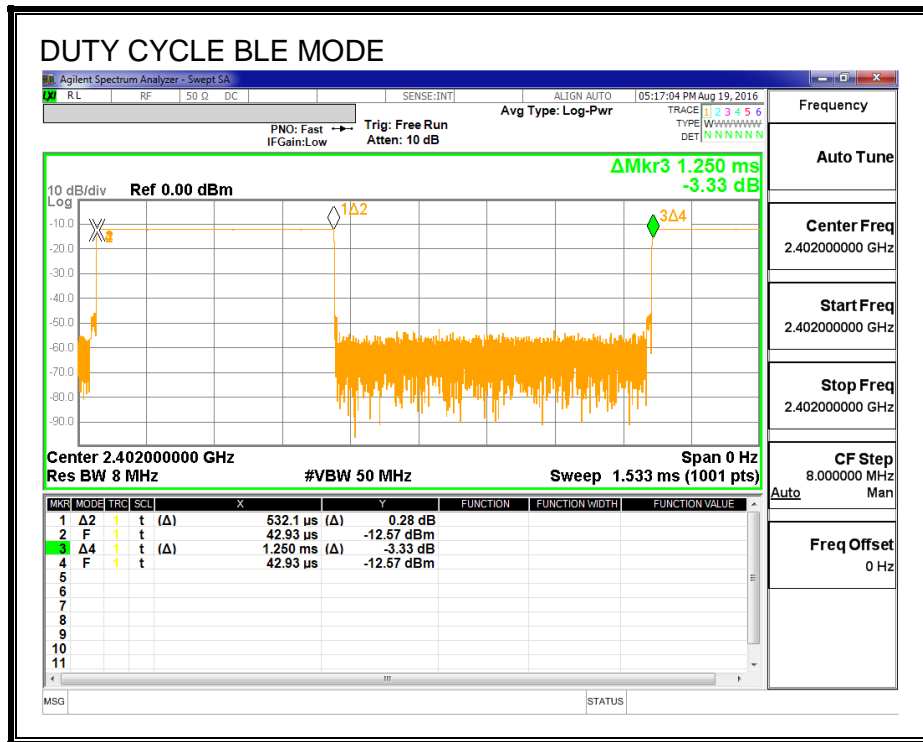

7.2. 6 dB BANDWIDTH

LIMITS

FCC §15.247 (a) (2)

IC RSS-247 (5.2) (1)

The minimum 6 dB bandwidth shall be at least 500 kHz.

RESULTS

Channel	Frequency (MHz)	6 dB Bandwidth (MHz)	Minimum Limit (MHz)
Low	2402	690.0	0.5
Middle	2440	698.0	0.5
High	2480	718.0	0.5

6 dB BANDWIDTH

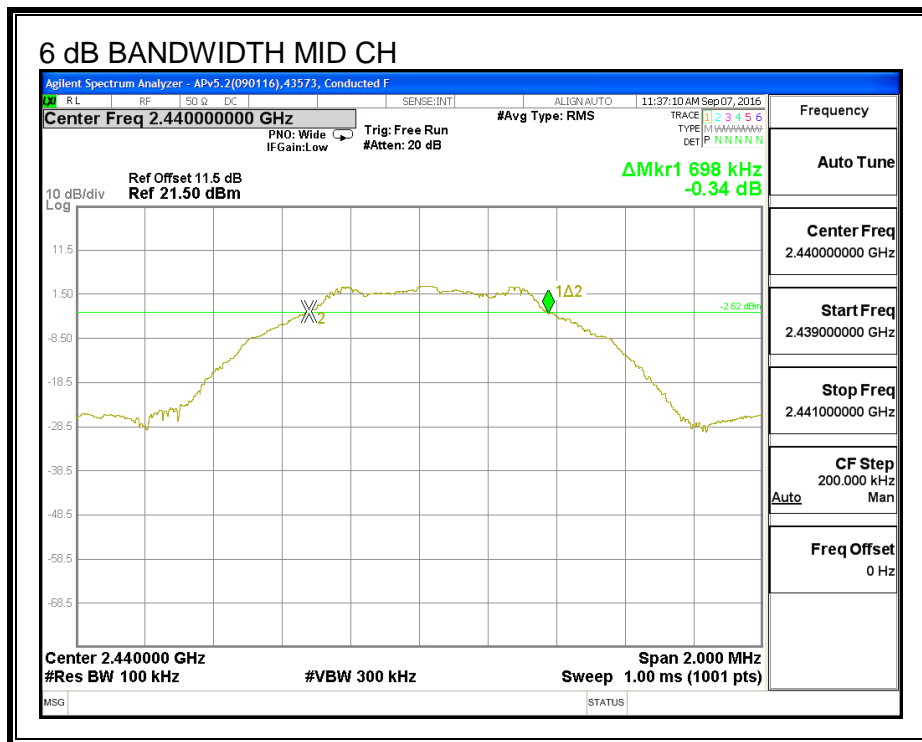
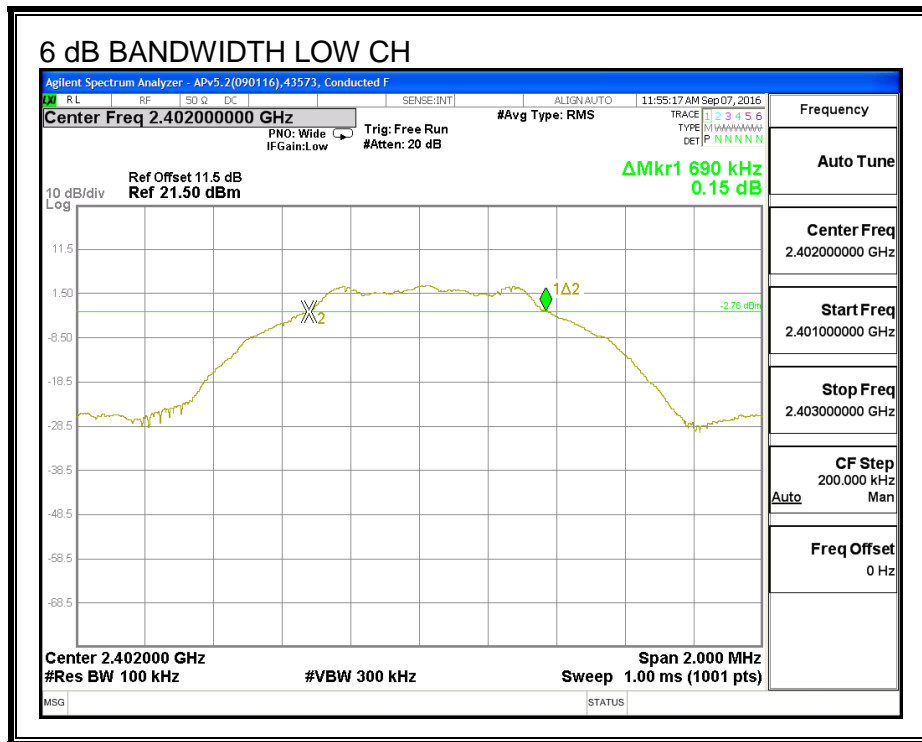

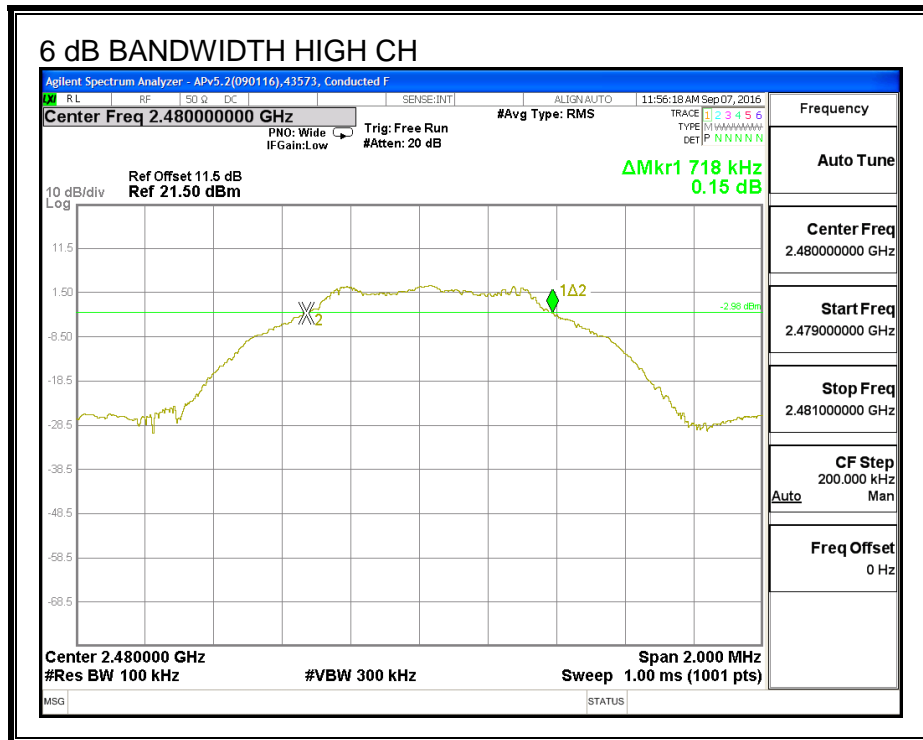

7.3. 99% BANDWIDTH

LIMITS

None; for reporting purposes only.

TEST PROCEDURE

The transmitter output is connected to the spectrum analyzer. The RBW is set to 1% to 3% of the 99 % bandwidth and to 1% of the span. The VBW is set to 3 times the RBW. The sweep time is coupled. The spectrum analyzer internal 99% bandwidth function is utilized.

RESULTS

Channel	Frequency (MHz)	99% Bandwidth (MHz)
Low	2402	1.0561
Middle	2440	1.0550
High	2480	1.0704

99% BANDWIDTH

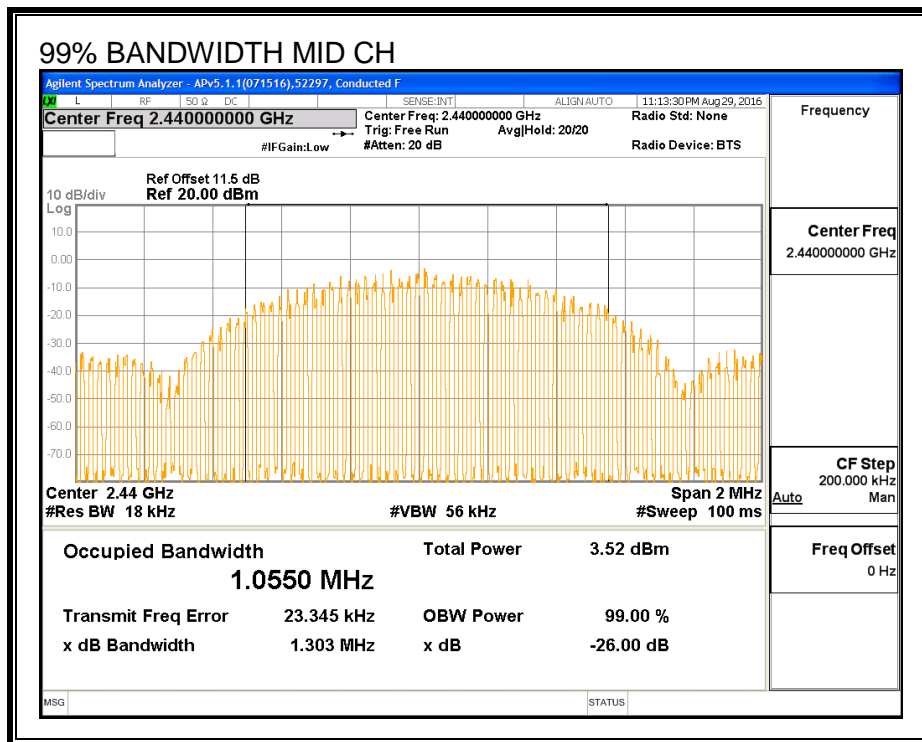
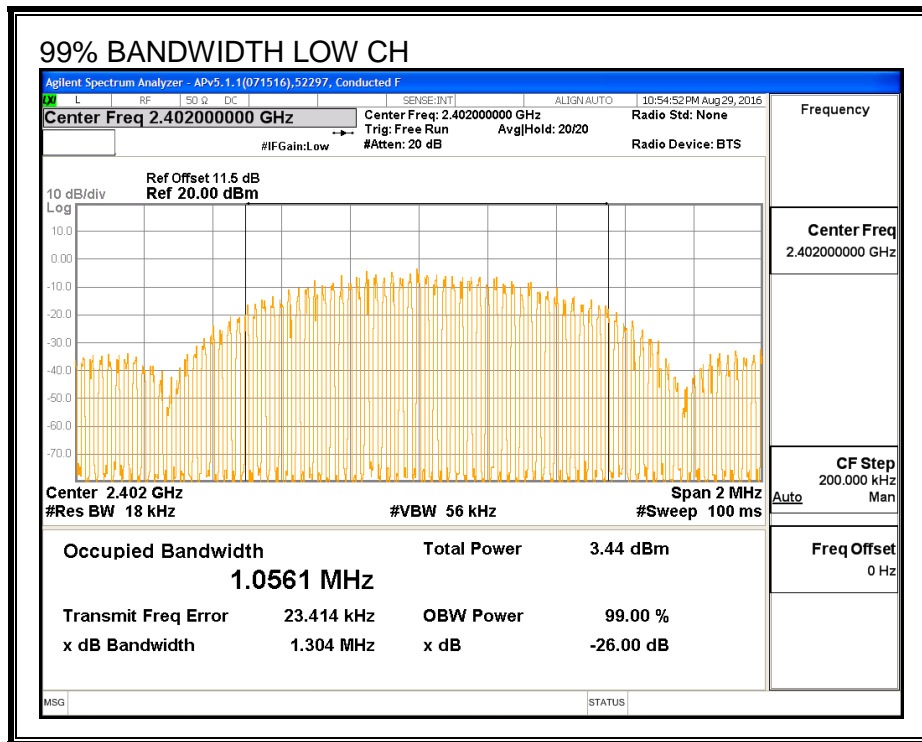

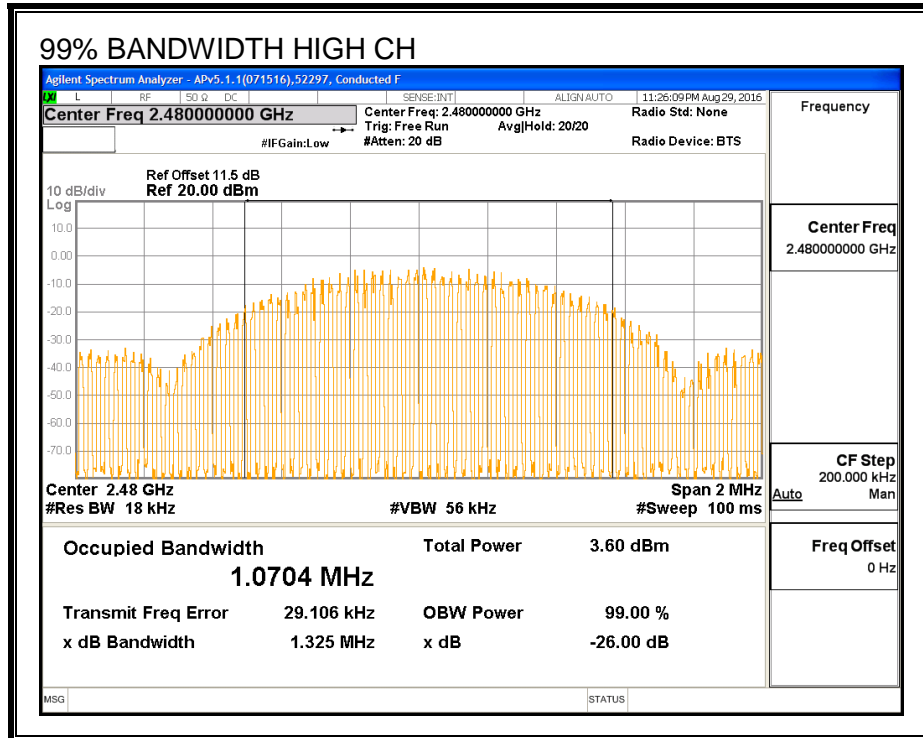

7.4. AVERAGE POWER

LIMITS

None; for reporting purposes only.

RESULTS

The cable assembly insertion loss of 11 dB (including 10 dB pad and 1 dB cable) was entered as an offset in the power meter to allow for direct reading of power.

ID:	44399	Date:	8/30/16
------------	-------	--------------	---------

Channel	Frequency (MHz)	AV power (dBm)
Low	2402	6.68
Middle	2440	6.87
High	2480	6.71

7.5. OUTPUT POWER

LIMITS

FCC §15.247 (b)

IC RSS-247 (5.4) (4)

The maximum antenna gain is less than or equal to 6 dBi, therefore the limit is 30 dBm.

RESULTS

ID:	44399	Date:	8/30/16
------------	-------	--------------	---------

Channel	Frequency (MHz)	Peak Power Reading (dBm)	Limit (dBm)	Margin (dB)
Low	2402	6.81	30	-23.190
Middle	2440	7.00	30	-23.000
High	2480	6.93	30	-23.070

7.6. POWER SPECTRAL DENSITY

LIMITS

FCC §15.247 (e)

IC RSS-247 (5.2) (2)

The power spectral density conducted from the transmitter to the antenna shall not be greater than 8 dBm in any 3 kHz band during any time interval of continuous transmission.

RESULTS

Channel	Frequency (MHz)	PSD (dBm)	Limit (dBm)	Margin (dB)
Low	2402	-7.82	8	-15.82
Middle	2440	-7.83	8	-15.83
High	2480	-7.73	8	-15.73

POWER SPECTRAL DENSITY

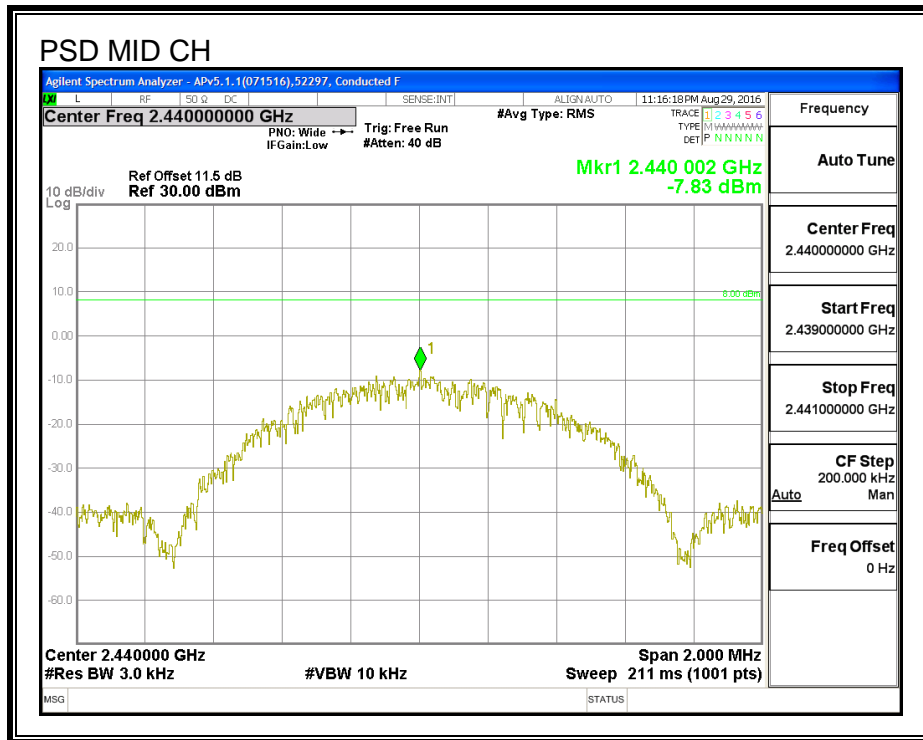
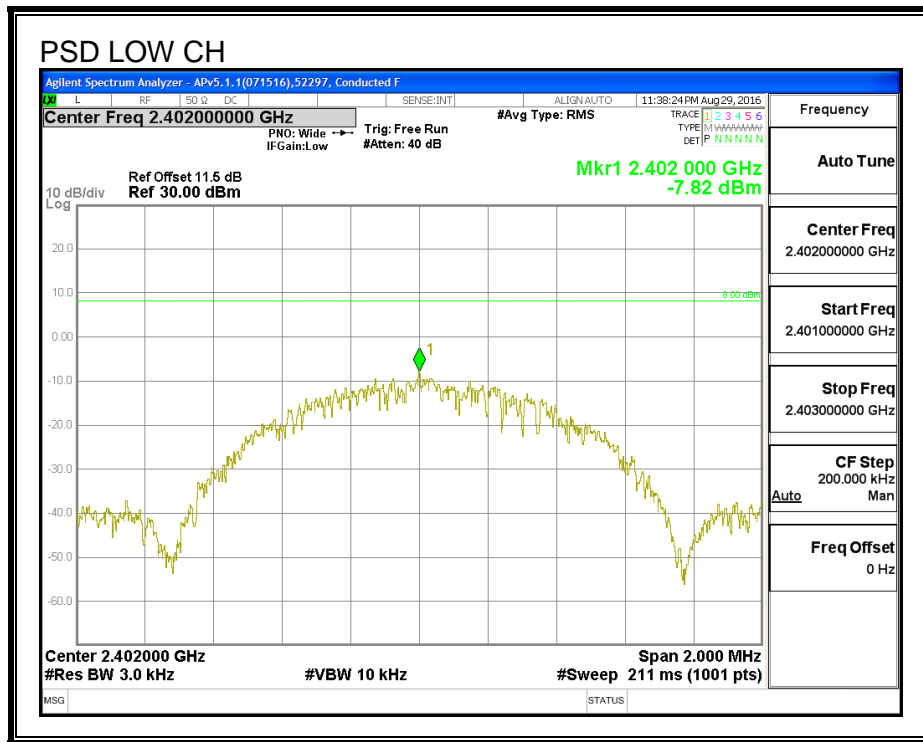

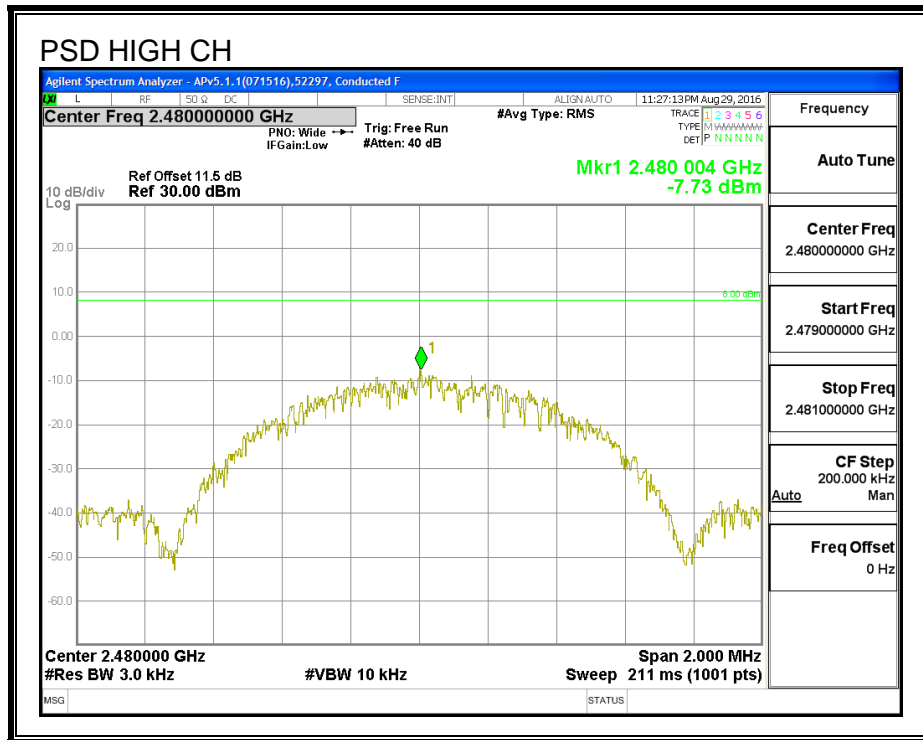

7.7. CONDUCTED SPURIOUS EMISSIONS

LIMITS

FCC §15.247 (d)

IC RSS-247 (5.5)

Output power was measured based on the use of a peak measurement, therefore the required attenuation is 20 dB.

RESULTS

SPURIOUS EMISSIONS, LOW CHANNEL

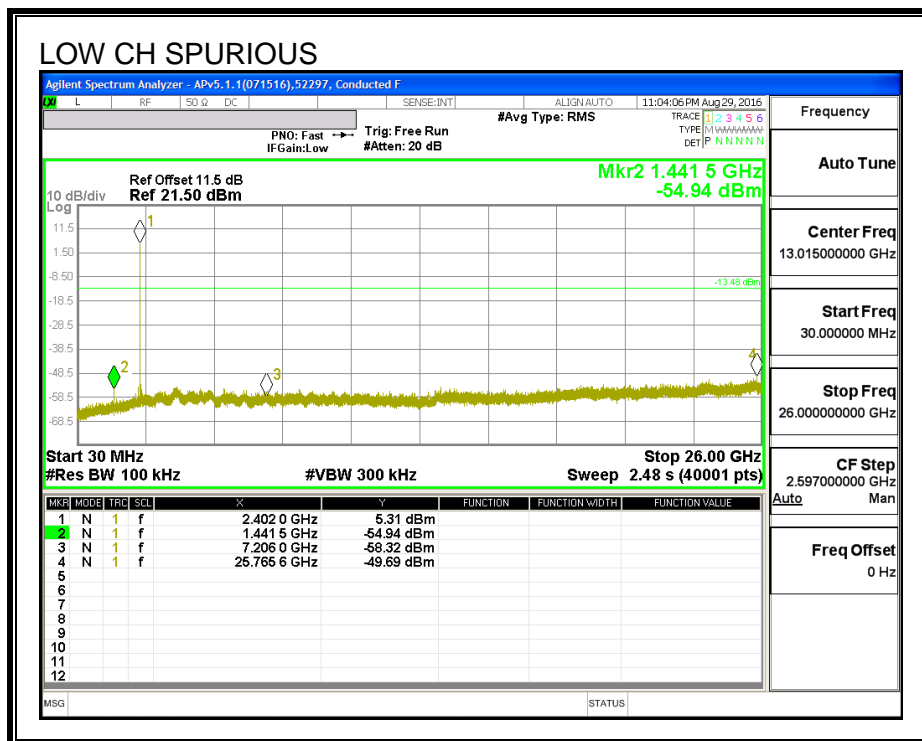
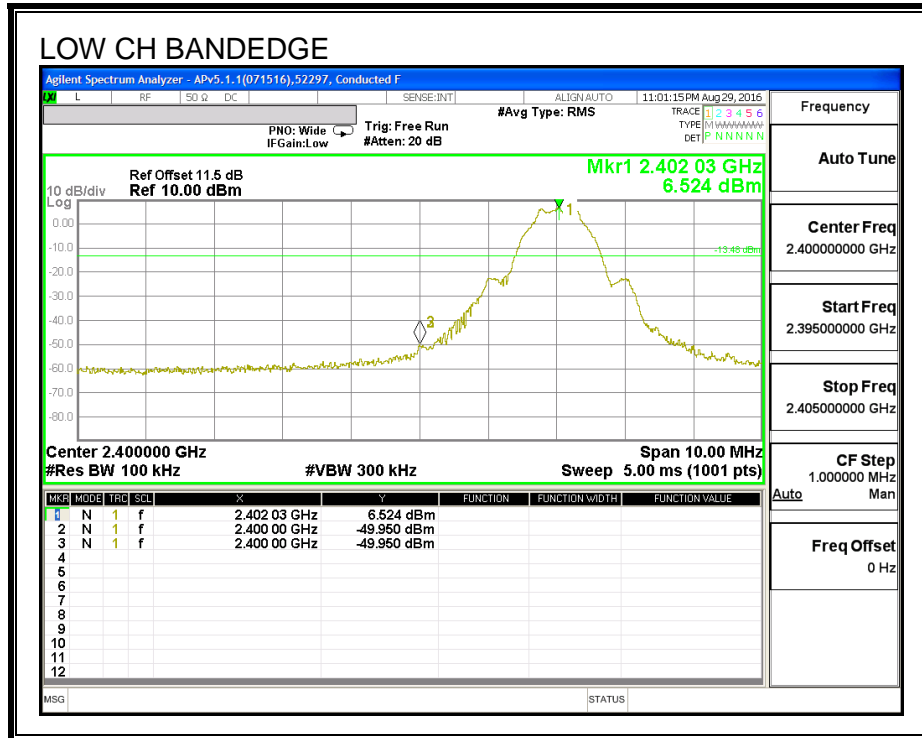

SPURIOUS EMISSIONS, MID CHANNEL

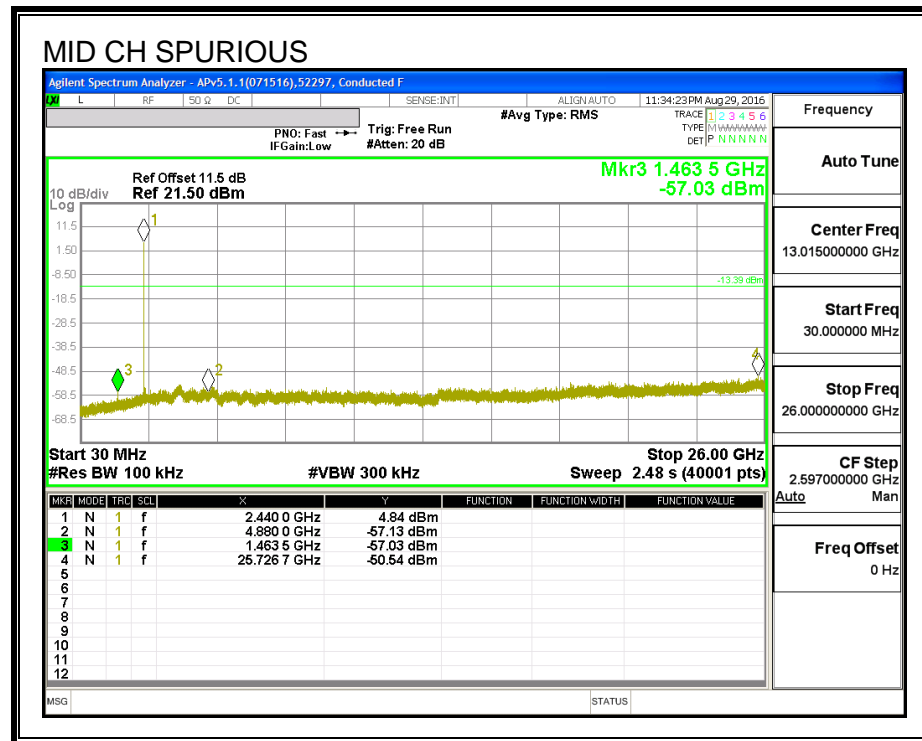
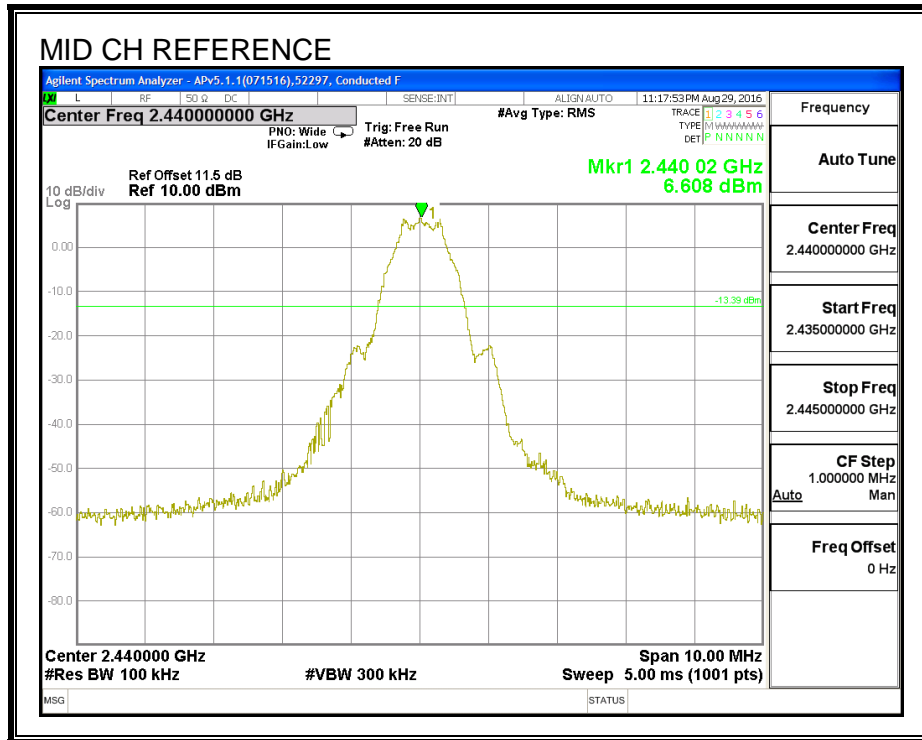

SPURIOUS EMISSIONS, HIGH CHANNEL

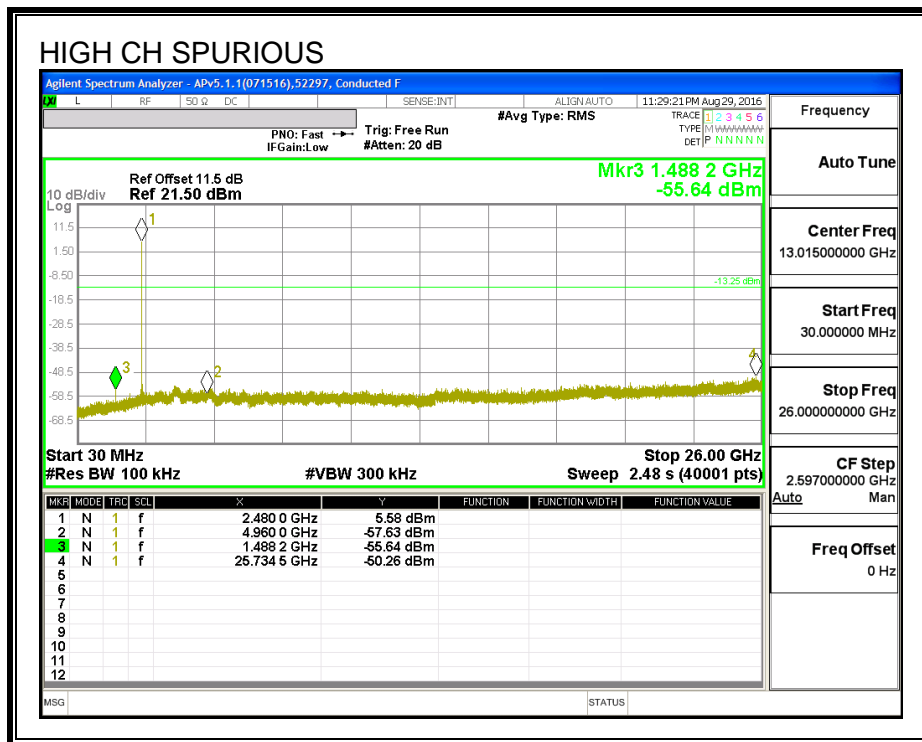
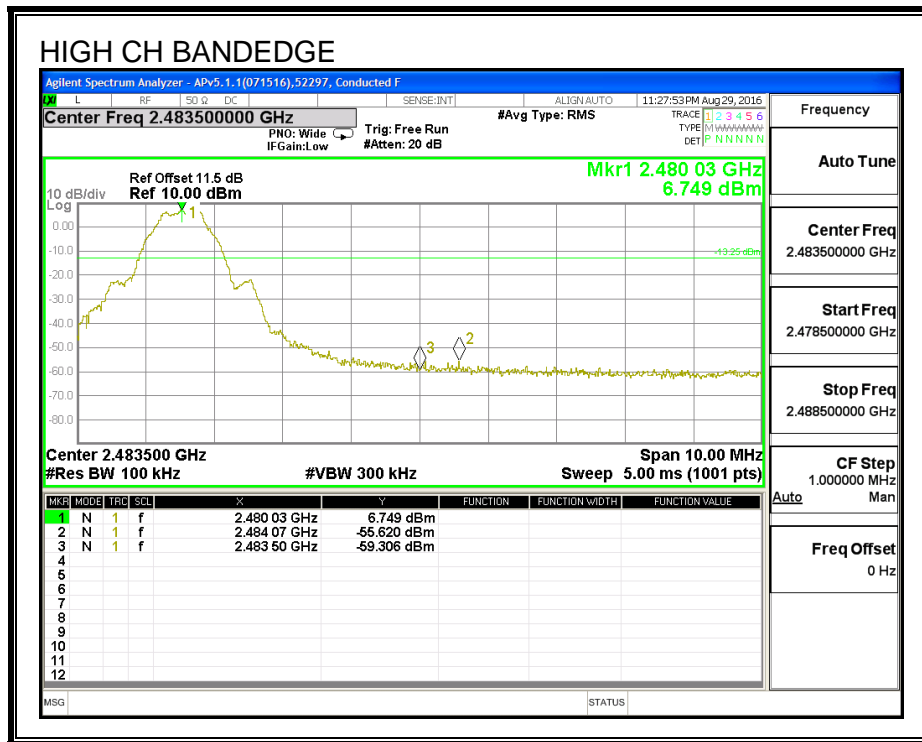

8. RADIATED TEST RESULTS

8.1. LIMITS AND PROCEDURE

LIMITS

FCC §15.205 and §15.209

IC RSS-GEN, Section 8.9 and 8.10.

Frequency Range (MHz)	Field Strength Limit (uV/m) at 3 m	Field Strength Limit (dBuV/m) at 3 m
30 - 88	100	40
88 - 216	150	43.5
216 - 960	200	46
Above 960	500	54

TEST PROCEDURE

The EUT is placed on a non-conducting table 80 cm above the ground plane for measurement below 1GHz; 1.5 m above the ground plane for measurement above 1GHz. The antenna to EUT distance is 3 meters. The EUT is configured in accordance with ANSI C63.10. The EUT is set to transmit in a continuous mode.

For measurements below 1 GHz the resolution bandwidth is set to 100 kHz for peak detection measurements or 120 kHz for quasi-peak detection measurements. Peak detection is used unless otherwise noted as quasi-peak.

For pre-scans above 1 GHz the resolution bandwidth is set to 1 MHz; the video bandwidth is set to 30 KHz for peak measurements.

For final measurements above 1 GHz the resolution bandwidth is set to 1 MHz; the video bandwidth is set to 3 MHz for peak measurements and as applicable for average measurements.

The spectrum from 30 MHz to 26 GHz is investigated with the transmitter set to the lowest, middle, and highest channels in the 2.4 GHz band.

The frequency range of interest is monitored at a fixed antenna height and EUT azimuth. The EUT is rotated through 360 degrees to maximize emissions received. The antenna is scanned from 1 to 4 meters above the ground plane to further maximize the emission. Measurements are made with the antenna polarized in both the vertical and the horizontal positions.

8.2. TRANSMITTER ABOVE 1 GHz

RESTRICTED BANDEDGE

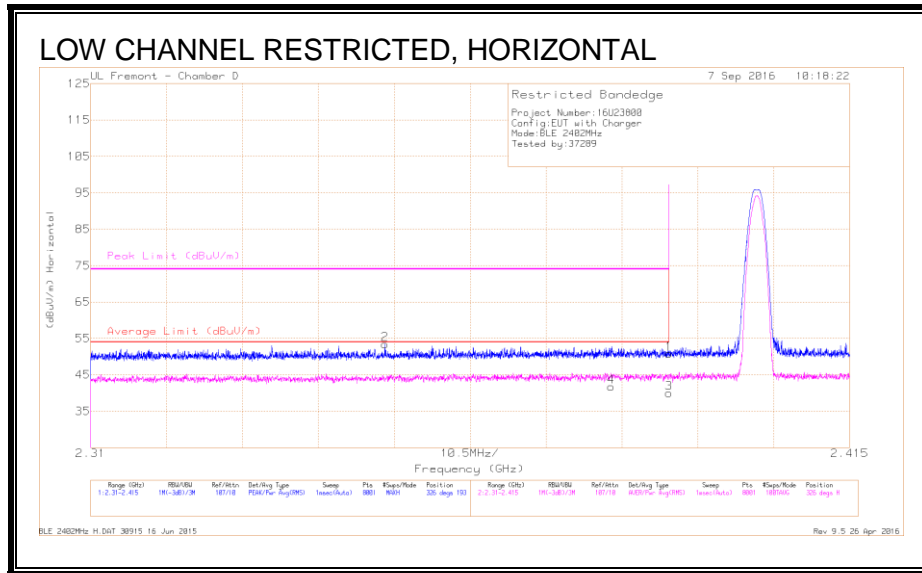

DATA

Marker	Frequency (GHz)	Meter Reading (dBuV)	Det	AF T712 (dB/m)	Amp/Cbl/Filtr/Pad (dB)	DC Corr (dB)	Corrected Reading (dBuV/m)	Average Limit (dBuV/m)	Margin (dB)	Peak Limit (dBuV/m)	PK Margin (dB)	Azimuth (Degrees)	Height (cm)	Polarization
2	* 2.351	42.33	Pk	31.8	-20.7	0	53.43	-	-	74	-20.57	326	193	H
4	* 2.382	30.36	RMS	32	-20.6	3.71	45.47	54	-8.53	-	-	326	193	H
1	* 2.39	39.29	Pk	32.1	-20.6	0	50.79	-	-	74	-23.21	326	193	H
3	* 2.39	28.51	RMS	32.1	-20.6	3.71	43.72	54	-10.28	-	-	326	193	H

* - indicates frequency in CFR47 Pt 15 / IC RSS-Restricted Band

Pk - Peak detector

RMS - RMS detection

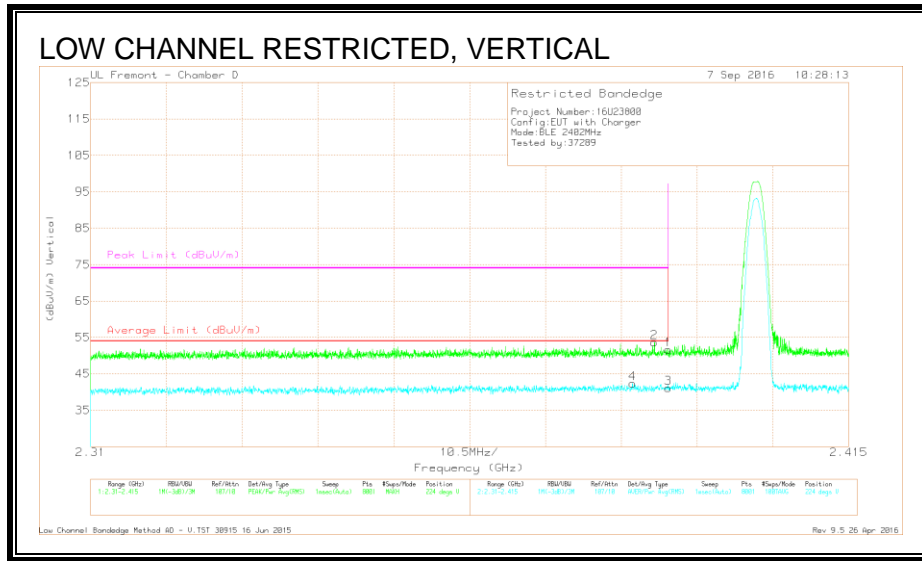

DATA

Marker	Frequency (GHz)	Meter Reading (dBuV)	Det	AF T712 (dB/m)	Amp/Cbl/Filtr/Pad (dB)	DC Corr (dB)	Corrected Reading (dBuV/m)	Average Limit (dBuV/m)	Margin (dB)	Peak Limit (dBuV/m)	PK Margin (dB)	Azimuth (Degrees)	Height (cm)	Polarity
4	* 2.385	30.81	RMS	32.1	-20.6	3.71	46.02	54	-7.98	-	-	224	244	V
2	* 2.388	42.09	Pk	32.1	-20.6	0	53.59	-	-	74	-20.41	224	244	V
1	* 2.39	40.11	Pk	32.1	-20.6	0	51.61	-	-	74	-22.39	224	244	V
3	* 2.39	29.64	RMS	32.1	-20.6	3.71	44.85	54	-9.15	-	-	224	244	V

* - indicates frequency in CFR47 Pt 15 / IC RSS-Restricted Band
 Pk - Peak detector
 RMS - RMS detection

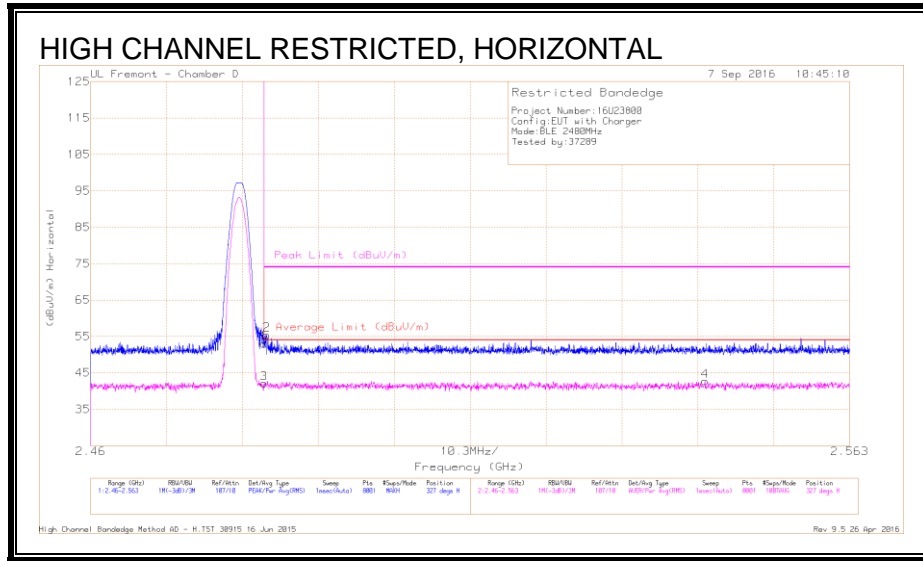

DATA

Marker	Frequency (GHz)	Meter Reading (dBuV)	Det	AF T712 (dB/m)	Amp/Cbl/FI tr/Pad (dB)	DC Corr (dB)	Corrected Reading (dBuV/m)	Average Limit (dBuV/m)	Margin (dB)	Peak Limit (dBuV/m)	PK Margin (dB)	Azimuth (Degs)	Height (cm)	Polarity
1	* 2.484	41.18	Pk	32.3	-20.5	0	52.98	-	-	74	-21.02	327	208	H
2	* 2.484	43.64	Pk	32.3	-20.5	0	55.44	-	-	74	-18.56	327	208	H
3	* 2.484	30.27	RMS	32.3	-20.5	3.71	45.78	54	-8.22	-	-	327	208	H
4	2.543	30.98	RMS	32.2	-20.5	3.71	46.39	54	-7.61	-	-	327	208	H

* - indicates frequency in CFR47 Pt 15 / IC RSS-Restricted Band
 Pk - Peak detector
 RMS - RMS detection

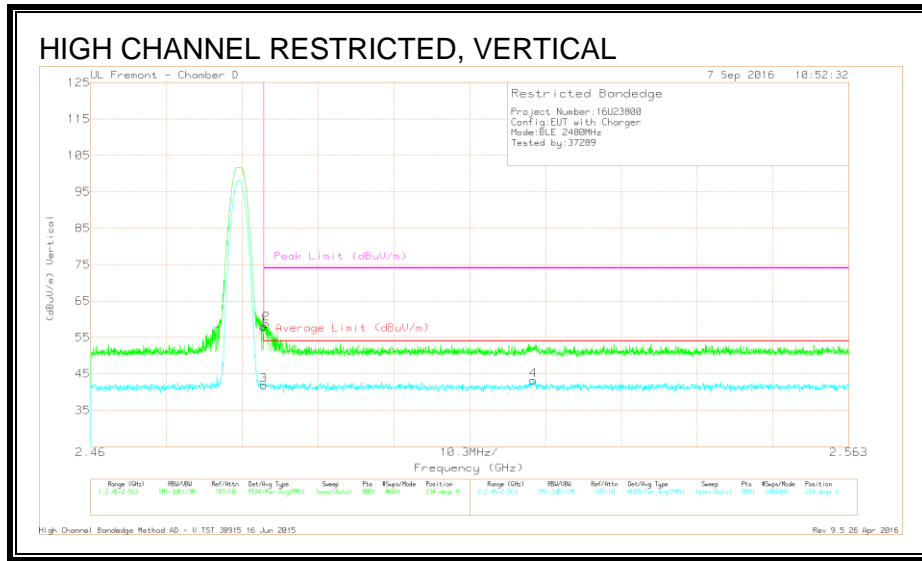

DATA

Marker	Frequency (GHz)	Meter Reading (dBuV)	Det	AF T712 (dB/m)	Amp /Cbl/ Fltr/P ad (dB)	DC Corr (dB)	Corrected Reading (dBuV/m)	Average Limit (dBuV/m)	Margin (dB)	Peak Limit (dBuV/m)	PK Margin (dB)	Azimuth (Degrees)	Height (cm)	Polarity
1	* 2.484	46.25	Pk	32.3	-20.5	0	58.05	-	-	74	-15.95	234	290	V
2	* 2.484	46.92	Pk	32.3	-20.5	0	58.72	-	-	74	-15.28	234	290	V
3	* 2.484	30.03	RMS	32.3	-20.5	3.71	45.54	54	-8.46	-	-	234	290	V
4	2.52	31.56	RMS	32.3	-20.6	3.71	46.97	54	-7.03	-	-	234	290	V

* - indicates frequency in CFR47 Pt 15 / IC RSS-Restricted Band
 Pk - Peak detector
 RMS - RMS detection

HARMONICS AND SPURIOUS EMISSIONS

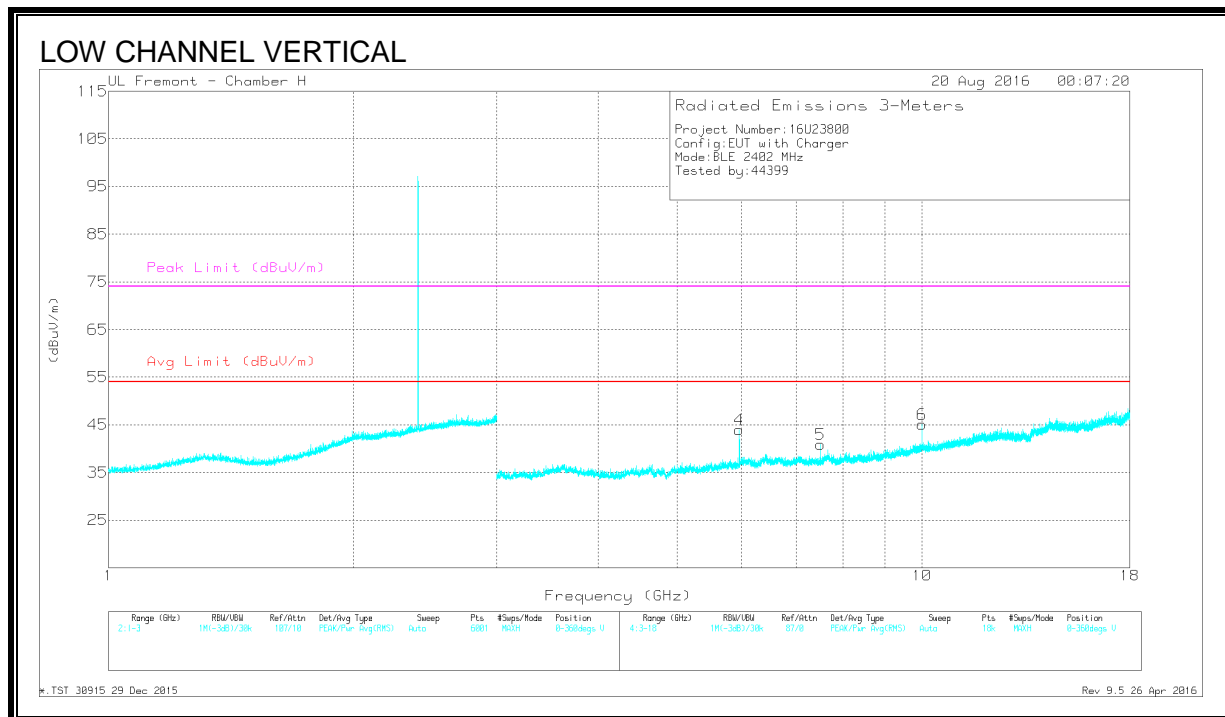
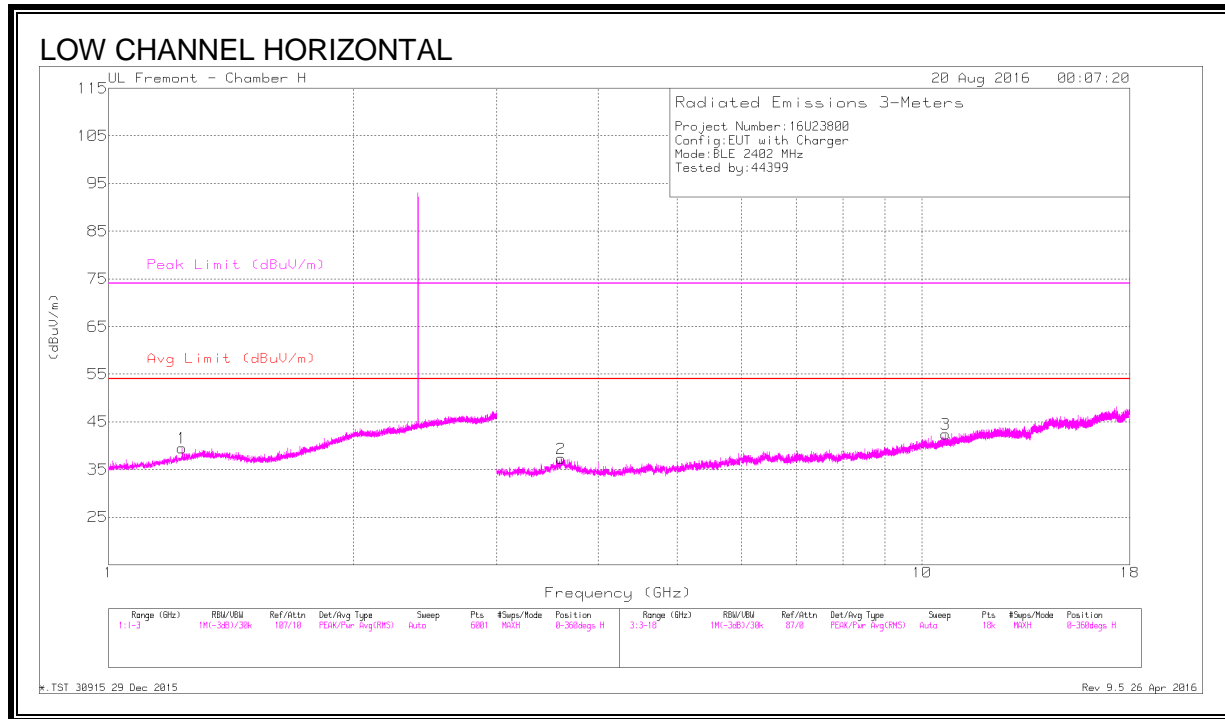

DATA

Markers	Frequency (GHz)	Meter Reading (dBuV)	Det	AF T120 (dB/m)	Amp/Cbl/ Filt/Pad (dB)	DC Corr (dB)	Corrected Reading (dBuV/m)	Avg Limit (dBuV/m)	Margin (dB)	Peak Limit (dBuV/m)	PK Margin (dB)	Azimuth (Degs)	Height (cm)	Polarity
1	* 1.231	38.2	PK2	29	-22.1	0	45.1	-	-	74	-28.9	98	114	H
	* 1.23	27.75	MAv1	29	-22.1	3.71	38.36	54	-15.64	-	-	98	114	H
2	* 3.602	43.3	PK2	34.9	-35.6	0	42.6	-	-	74	-31.4	163	213	H
	* 3.604	33.33	MAv1	34.9	-35.6	3.71	36.34	54	-17.66	-	-	163	213	H
3	* 10.691	38.52	PK2	38	-28.4	0	48.12	-	-	74	-25.88	269	140	H
	* 10.691	28.04	MAv1	38	-28.4	3.71	41.35	54	-12.65	-	-	269	140	H
5	* 7.5	45.61	PK2	35.8	-31.5	0	49.91	-	-	74	-24.09	211	224	V
	* 7.5	39.53	MAv1	35.8	-31.5	3.71	47.54	54	-6.46	-	-	211	224	V
4	5.963	30.93	MAv1	35.3	-33.1	3.71	36.84	-	-	-	-	32	373	V
	5.964	41.69	PK2	35.3	-33.1	0	43.89	-	-	-	-	32	373	V
6	10	40.93	PK2	37.6	-28.2	0	50.33	-	-	-	-	274	100	V
	10	32.49	MAv1	37.6	-28.2	3.71	45.6	-	-	-	-	274	100	V

* - indicates frequency in CFR47 Pt 15 / IC RSS-Restricted Band
 PK2 - KDB558074 Method: Maximum Peak
 MAv1 - KDB558074 Option 1 Maximum RMS Average

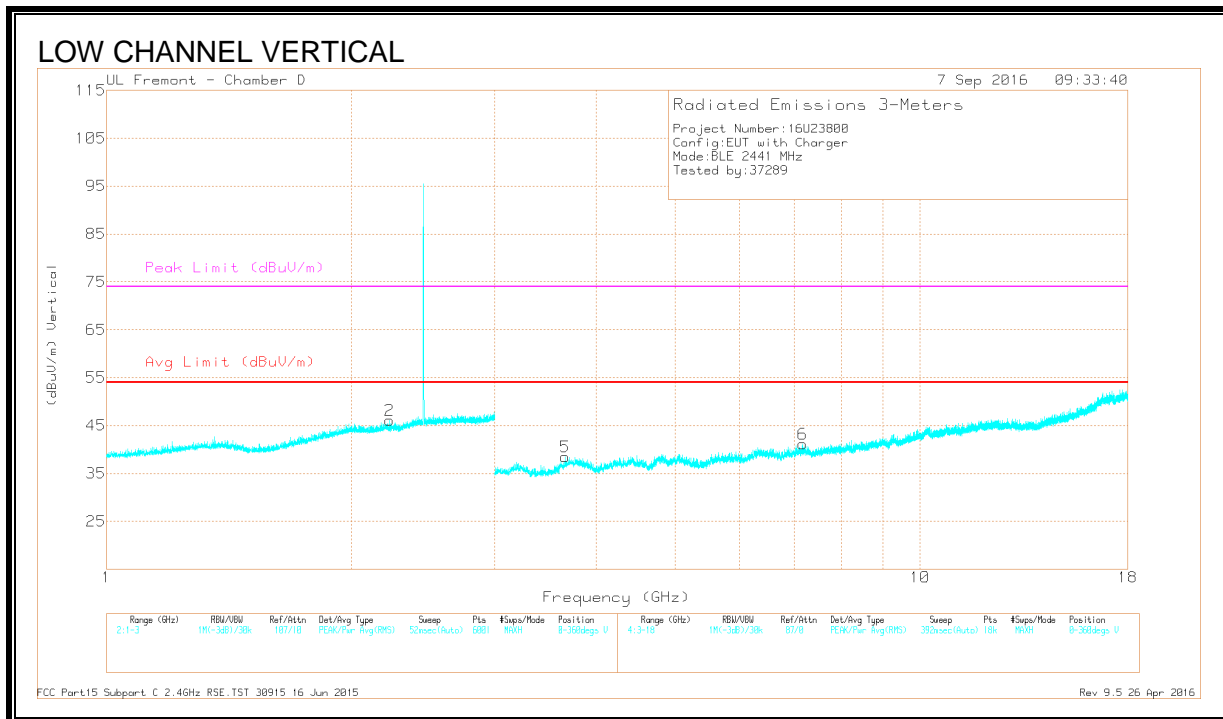
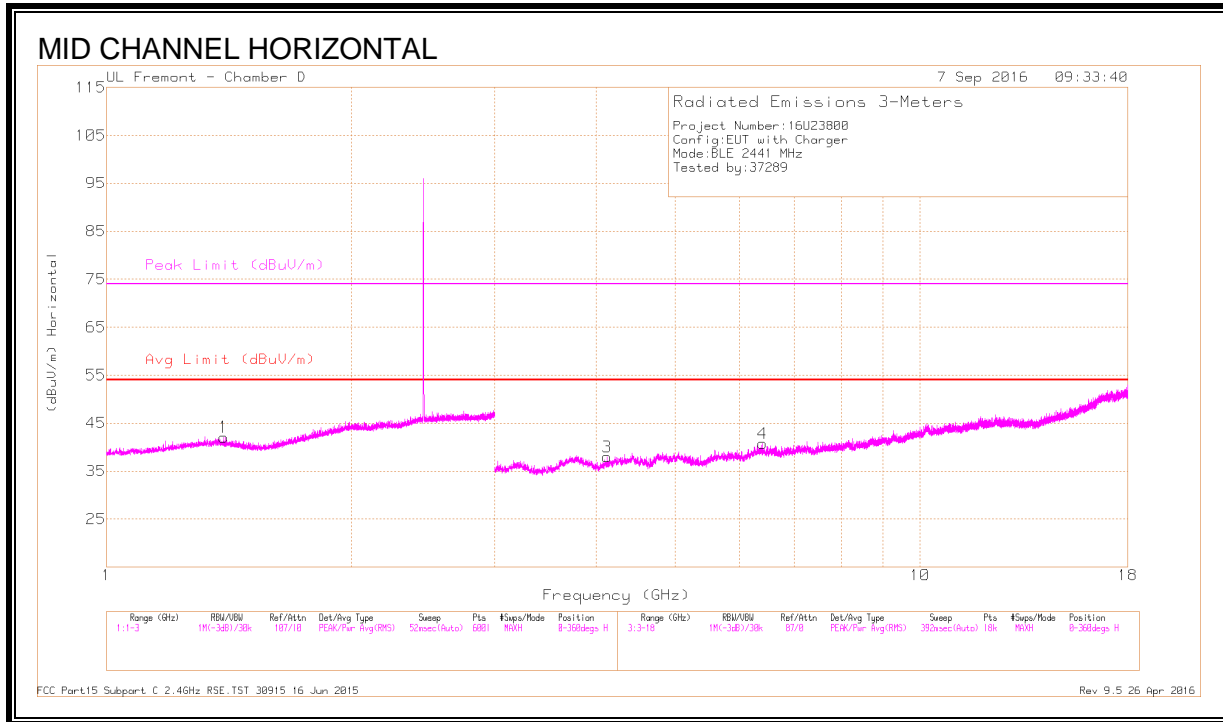

DATA

	Frequency (GHz)	Meter Reading (dBuV)	Det	AF T712 (dB/m)	Amp/Cb/Fitr/Pa d (dB)	DC Corr (dB)	Corrected Reading (dBuV/m)	Avg Limit (dBuV/m)	Margin (dB)	Peak Limit (dBuV/m)	PK Margin (dB)	Azimuth (Degs)	Height (cm)	Polarity
1	* 1.391	41.8	PK2	29	-21.9	0	48.9	-	-	74	-25.1	146	189	H
	* 1.391	30.33	MAv1	29	-21.9	3.71	41.14	54	-12.86	-	-	146	189	H
2	* 2.227	41.63	PK2	31.5	-20.8	0	52.33	-	-	74	-21.67	234	200	V
	* 2.227	30.28	MAv1	31.5	-20.8	3.71	44.69	54	-9.31	-	-	234	200	V
3	* 4.12	37.56	PK2	33.6	-27.9	0	43.26	-	-	74	-30.74	346	358	H
	* 4.12	26.85	MAv1	33.6	-27.9	3.71	36.26	54	-17.74	-	-	346	358	H
5	* 3.66	37.94	PK2	33.4	-28.9	0	42.44	-	-	74	-31.56	17	102	V
	* 3.661	27.62	MAv1	33.4	-28.9	3.71	35.83	54	-18.17	-	-	17	102	V
4	6.401	25.33	MAv1	35.7	-26	3.71	38.74	-	-	-	-	330	200	H
	6.402	36.54	PK2	35.7	-26	0	46.24	-	-	-	-	330	200	H
6	7.169	35.55	PK2	35.7	-24.8	0	46.45	-	-	-	-	190	102	V
	7.171	24.94	MAv1	35.7	-24.8	3.71	39.55	-	-	-	-	190	102	V

* - indicates frequency in CFR47 Pt 15 / IC RSS-Restricted Band
 PK2 - KDB558074 Method: Maximum Peak
 MAv1 - KDB558074 Option 1 Maximum RMS Average

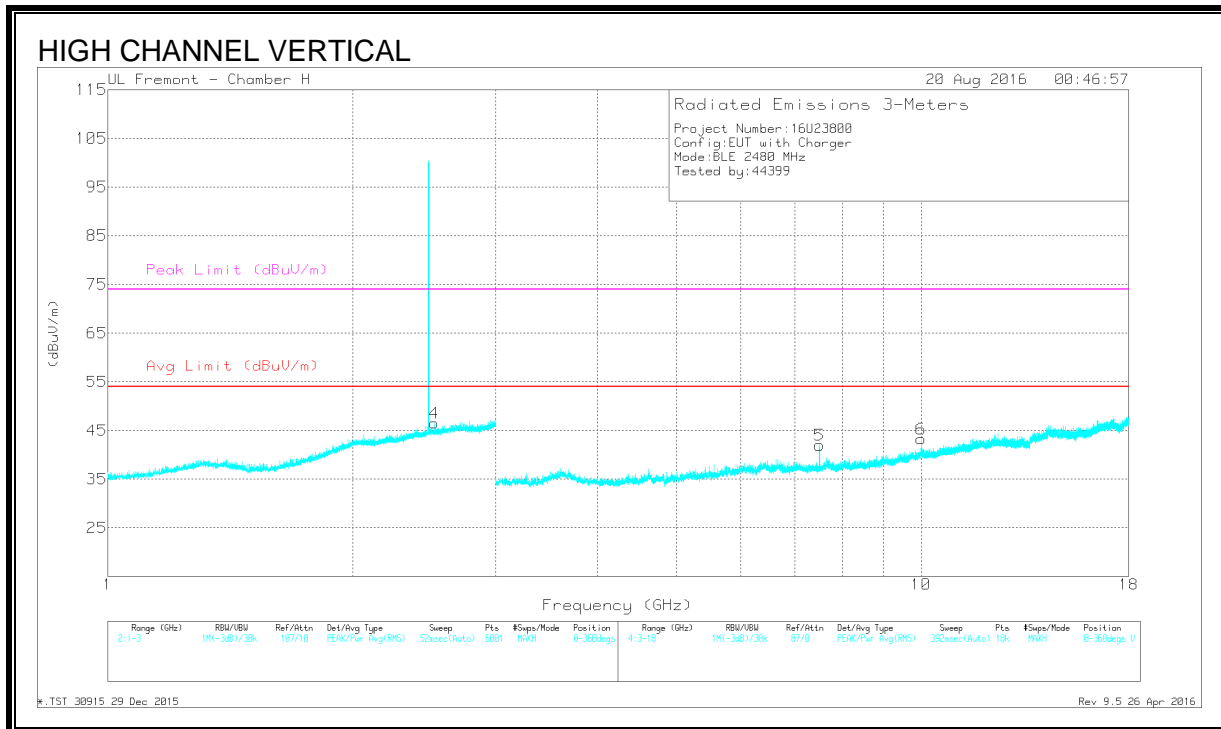
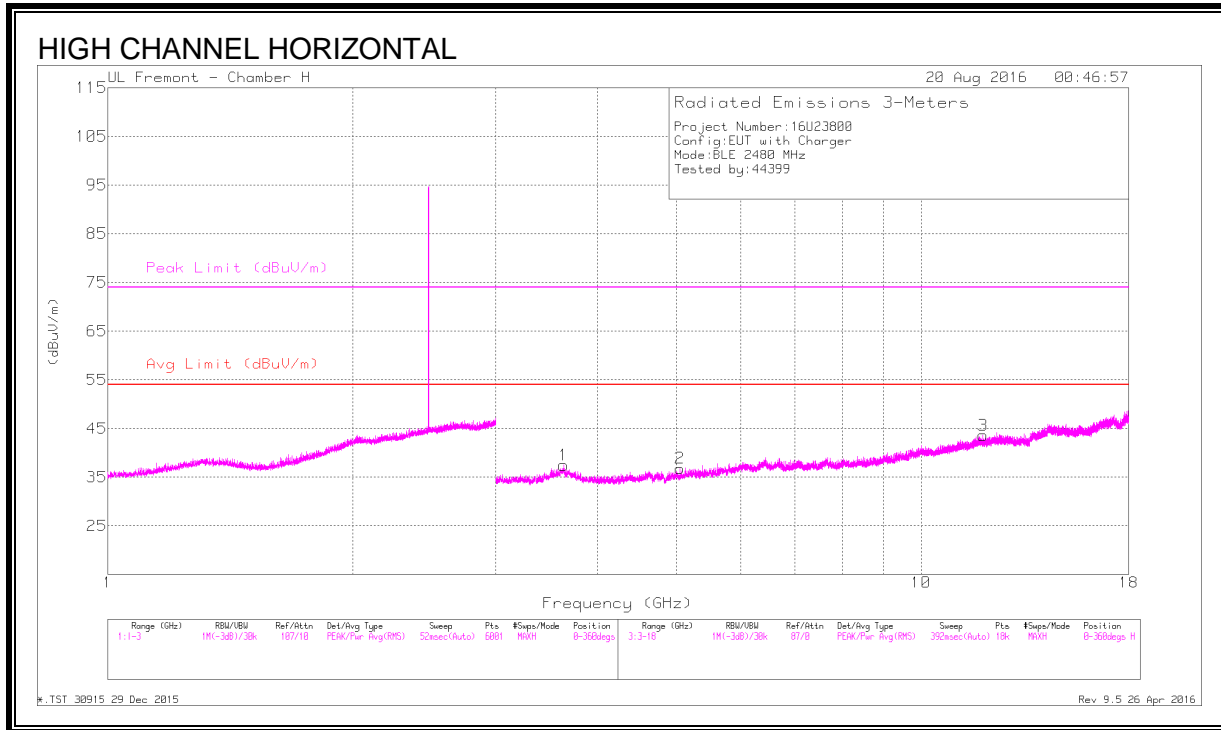

DATA

Markers	Frequency (GHz)	Meter Reading (dBuV)	Det	AF T120 (dB/m)	Amp/Cb/ Filt/Pad (dB)	DC Corr (dB)	Corrected Reading (dBuV/m)	Avg Limit (dBuV/m)	Margin (dB)	Peak Limit (dBuV/m)	PK Margin (dB)	Azimuth (Degs)	Height (cm)	Polarity
1	* 3.633	44.59	PK2	34.9	-35.8	0	43.69	-	-	74	-30.31	31	129	H
	* 3.636	34.16	MAv1	34.9	-35.8	3.71	36.97	54	-17.03	-	-	31	129	H
2	* 5.054	43.06	PK2	34.1	-34.3	0	42.86	-	-	74	-31.14	229	210	H
	* 5.055	32.64	MAv1	34.1	-34.3	3.71	36.15	54	-17.85	-	-	229	210	H
3	* 11.914	37.18	PK2	39.1	-26.7	0	49.58	-	-	74	-24.42	188	264	H
	* 11.918	26.95	MAv1	39.1	-26.7	3.71	43.06	54	-10.94	-	-	188	264	H
5	* 7.5	43.77	PK2	35.8	-31.5	0	48.07	-	-	74	-25.93	203	205	V
	* 7.5	36.46	MAv1	35.8	-31.5	3.71	44.47	54	-9.53	-	-	203	205	V
4	2.52	40.3	PK2	32.2	-19.5	0	53	-	-	-	-	283	173	V
	2.52	28.54	MAv1	32.2	-19.5	3.71	44.95	-	-	-	-	283	173	V
6	9.998	38.56	PK2	37.6	-28.2	0	47.96	-	-	-	-	154	277	V
	10	27.89	MAv1	37.6	-28.2	3.71	41	-	-	-	-	154	277	V

* - indicates frequency in CFR47 Pt 15 / IC RSS-Restricted Band
 PK2 - KDB558074 Method: Maximum Peak
 MAv1 - KDB558074 Option 1 Maximum RMS Average

8.3. WORST-CASE BELOW 1 GHz

SPURIOUS EMISSIONS 30 TO 1000 MHz (WORST-CASE CONFIGURATION)

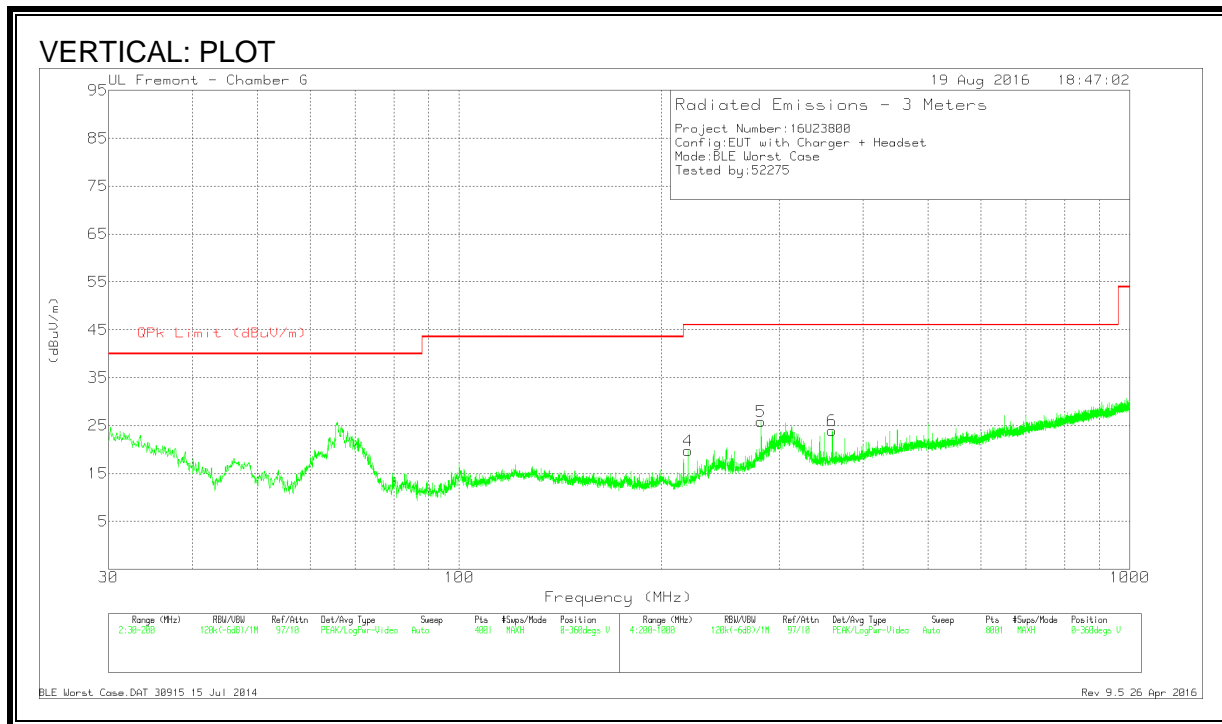
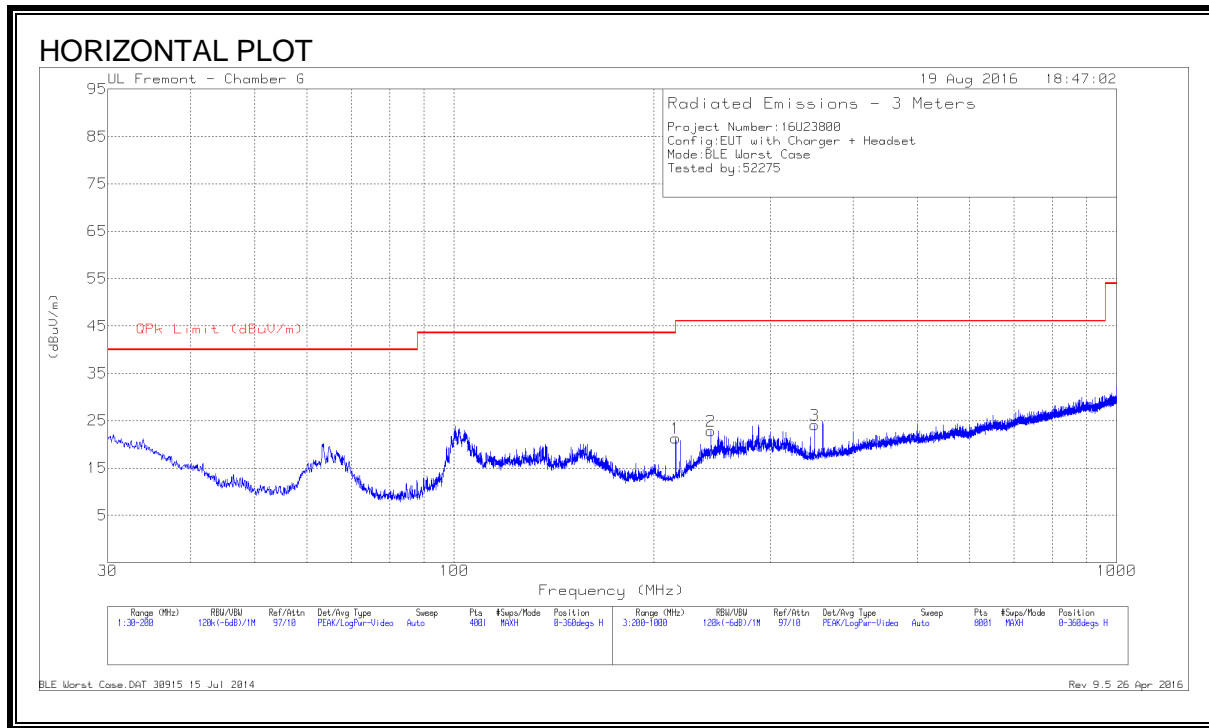

DATA

Marker	Frequency (MHz)	Meter Reading (dBuV)	Det	AFT407 (dB/m)	Amp/Cbl (dB)	Corrected Reading (dBuV/m)	QPk Limit (dBuV/m)	Margin (dB)	Azimuth (Degs)	Height (cm)	Polarity
2	* 244.1	36.71	Pk	15.5	-29.4	22.81	46.02	-23.21	0-360	100	H
5	* 282.1	37.83	Pk	17.3	-29.3	25.83	46.02	-20.19	0-360	199	V
1	216	36.52	Pk	14.4	-29.6	21.32	43.52	-22.2	0-360	100	H
4	219.4	34.78	Pk	14.6	-29.6	19.78	46.02	-26.24	0-360	299	V
3	350	34.58	Pk	18.3	-28.8	24.08	46.02	-21.94	0-360	100	H
6	360	34.08	Pk	18.7	-28.8	23.98	46.02	-22.04	0-360	98	V

* - indicates frequency in CFR47 Pt 15 / IC RSS-Restricted Band
 Pk - Peak detector

8.4. WORST-CASE 18 to 26 GHz

SPURIOUS EMISSIONS 18 to 26 GHz (WORST-CASE CONFIGURATION)

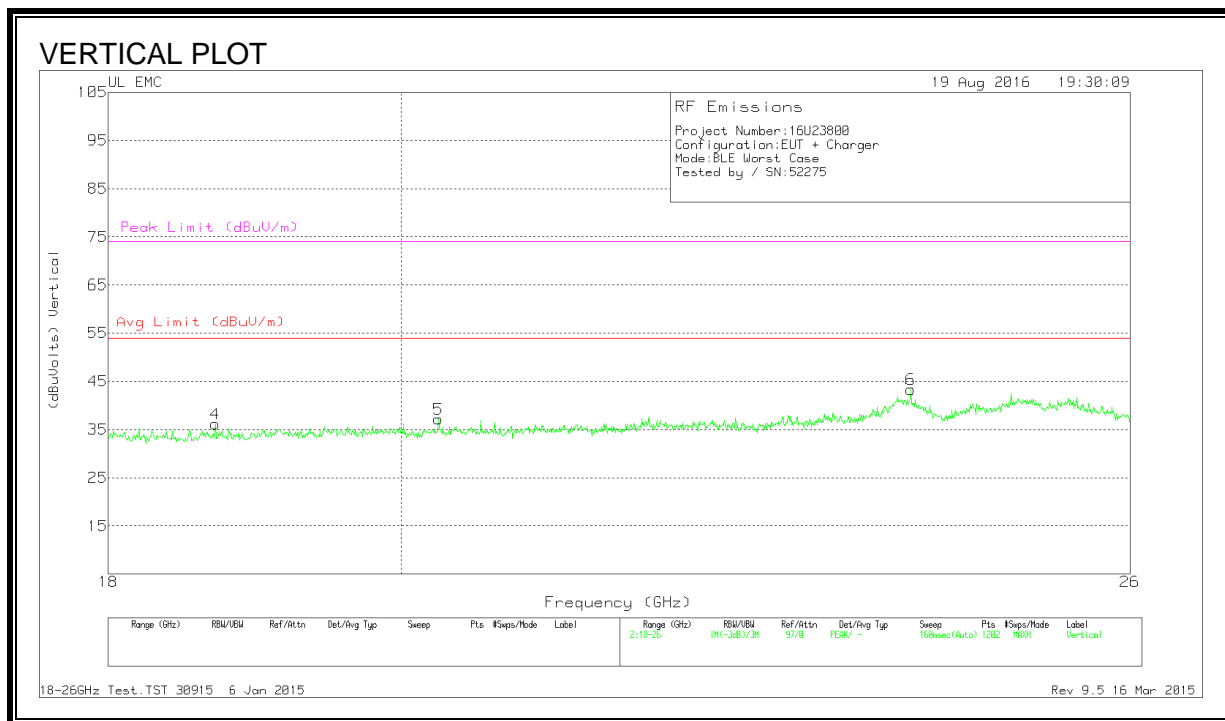
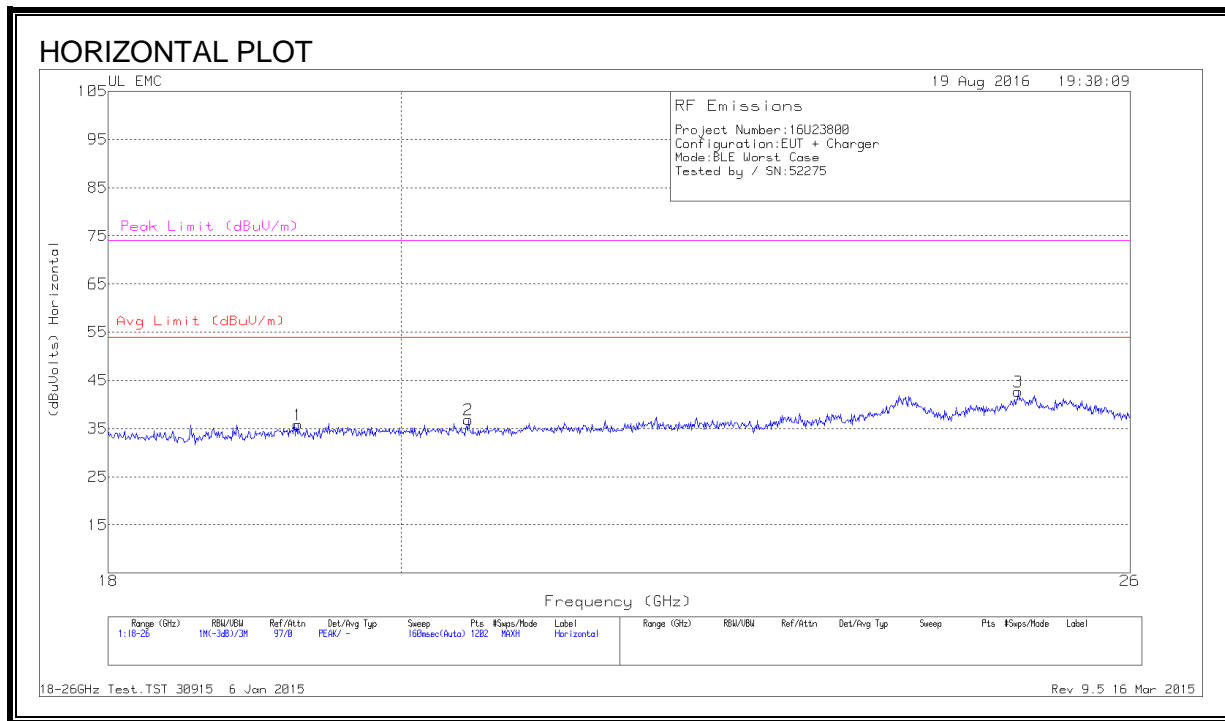

DATA

Marker	Frequency (GHz)	Meter Reading (dBuV)	Det	AF T449 (dB/m)	Amp/Cbl (dB)	Dist Corr (dB)	Corrected Reading (dBuVolts)	Avg Limit (dBuV/m)	Margin (dB)	Peak Limit (dBuV/m)	PK Margin (dB)
1	19.272	37.53	Pk	32.7	-24.9	-9.5	35.833	54	-18.167	74	-38.167
2	20.491	38.63	Pk	32.9	-25.2	-9.5	36.833	54	-17.167	74	-37.167
3	24.974	42.17	Pk	34.2	-24.2	-9.5	42.667	54	-11.333	74	-31.333
4	18.706	37.67	Pk	32.4	-24.4	-9.5	36.167	54	-17.833	74	-37.833
5	20.271	39.07	Pk	32.8	-25.2	-9.5	37.167	54	-16.833	74	-36.833
6	24.028	42.93	Pk	34	-24.1	-9.5	43.333	54	-10.667	74	-30.667

Pk - Peak detector

9. AC POWER LINE CONDUCTED EMISSIONS

LIMITS

FCC §15.207 (a)

RSS-Gen 8.8

Frequency of Emission (MHz)	Conducted Limit (dB μ V)	
	Quasi-peak	Average
0.15-0.5	66 to 56 *	56 to 46 *
0.5-5	56	46
5-30	60	50

*Decreases with the logarithm of the frequency.

TEST PROCEDURE

The EUT is placed on a non-conducting table 40 cm from the vertical ground plane and 80 cm above the horizontal ground plane. The EUT is configured in accordance with ANSI C63.10.

The receiver is set to a resolution bandwidth of 9 kHz. Peak detection is used unless otherwise noted as quasi-peak or average.

Line conducted data is recorded for both NEUTRAL and HOT lines.

RESULTS

WORST EMISSIONS

Range 1: Line-L1 .15 - 30MHz

Marker	Frequency (MHz)	Meter Reading (dBuV)	Det	LISN L1	LC Cables 1&3	Limiter (dB)	Corrected Reading dBuV	CFR 47 Part 15 Class B QP	QP Margin (dB)	CFR 47 Part 15 Class B Avg	Av(CISPR) Margin (dB)
1	.15225	32.08	Qp	.1	0	10.1	42.28	65.88	-23.6	-	-
2	.15225	12.51	Ca	.1	0	10.1	22.71	-	-	55.88	-33.17
3	.21525	23.91	Qp	0	0	10.1	34.01	63	-28.99	-	-
4	.213	9.14	Ca	0	0	10.1	19.24	-	-	53.09	-33.85
5	.3255	21.44	Qp	0	0	10.1	31.54	59.57	-28.03	-	-
6	.3255	12.8	Ca	0	0	10.1	22.9	-	-	49.57	-26.67
7	.52575	21.29	Qp	0	0	10.1	31.39	56	-24.61	-	-
8	.5235	11.13	Ca	0	0	10.1	21.23	-	-	46	-24.77
9	6.3375	25.83	Qp	0	.1	10.2	36.13	60	-23.87	-	-
10	6.3195	19.8	Ca	0	.1	10.2	30.1	-	-	50	-19.9
11	17.097	24.08	Qp	0	.2	10.3	34.58	60	-25.42	-	-
12	17.11275	18.68	Ca	0	.2	10.3	29.18	-	-	50	-20.82

Range 2: Line-L2 .15 - 30MHz

Marker	Frequency (MHz)	Meter Reading (dBuV)	Det	LISN L2	LC Cables 2&3	Limiter (dB)	Corrected Reading dBuV	CFR 47 Part 15 Class B QP	QP Margin (dB)	CFR 47 Part 15 Class B Avg	Av(CISPR) Margin (dB)
13	.15225	23.34	Qp	0	0	10.1	33.44	65.88	-32.44	-	-
14	.15225	5.38	Ca	0	0	10.1	15.48	-	-	55.88	-40.4
15	.19725	21.96	Qp	0	0	10.1	32.06	63.73	-31.67	-	-
16	.195	5.19	Ca	0	0	10.1	15.29	-	-	53.82	-38.53
17	.3255	18.58	Qp	0	0	10.1	28.68	59.57	-30.89	-	-
18	.3255	7.83	Ca	0	0	10.1	17.93	-	-	49.57	-31.64
19	.75975	18.61	Qp	0	.1	10.1	28.81	56	-27.19	-	-
20	.76425	4.8	Ca	0	0	10.1	14.9	-	-	46	-31.1
21	6.3015	25.58	Qp	0	.1	10.2	35.88	60	-24.12	-	-
22	6.29925	19.29	Ca	0	.1	10.2	29.59	-	-	50	-20.41
23	17.0025	25.49	Qp	0	.2	10.3	35.99	60	-24.01	-	-
24	16.9935	19.92	Ca	0	.2	10.3	30.42	-	-	50	-19.58

Qp - Quasi-Peak detector

Ca - CISPR average detection

FCC15 CE Class B 150kHz-30MHz Stepping.TST 30915 24 Feb 2016

Rev 9.5 26 May 2015

LINE 1 RESULTS

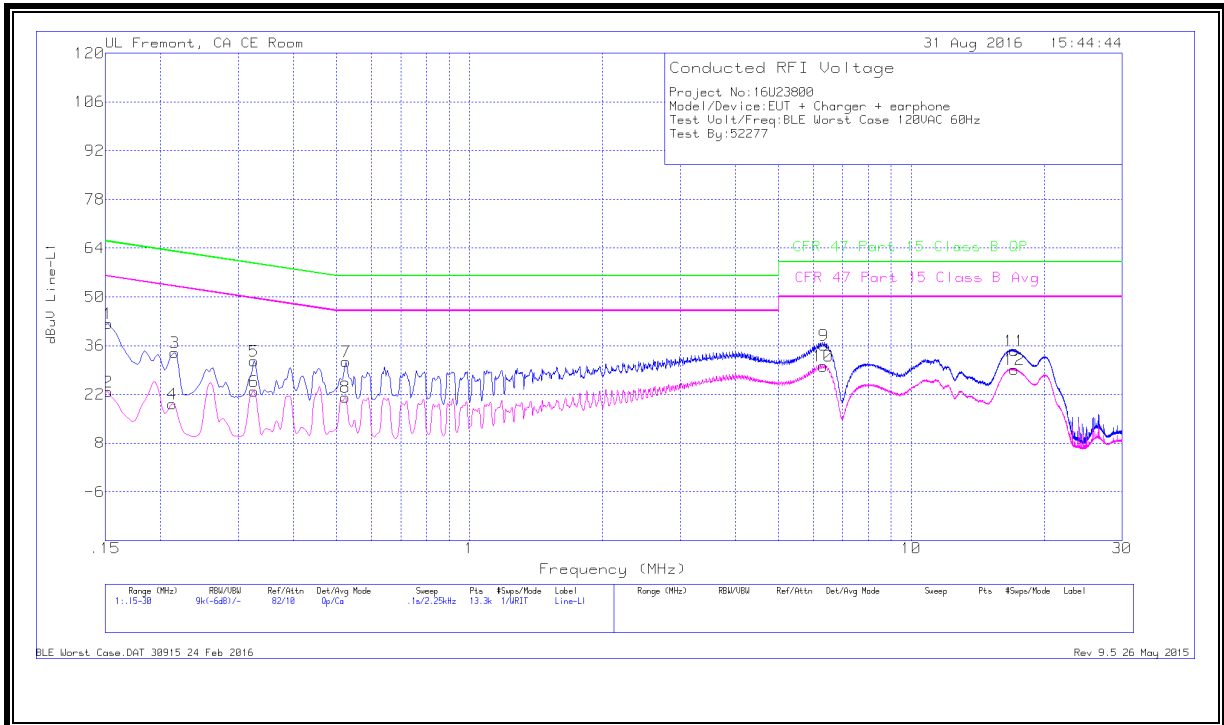

LINE 2 RESULTS

