



**FCC 47 CFR PART 15 SUBPART E
INDUSTRY CANADA RSS-247 ISSUE 1**

CERTIFICATION TEST REPORT

FOR

PORTABLE COMPUTER

MODEL NUMBER: A1707

FCC ID: BCGA1707

IC: 579C-A1707

REPORT NUMBER: 16U23800-E4V2

ISSUE DATE: OCTOBER 13, 2016

Prepared for

APPLE, INC.

1 INFINITE LOOP

CUPERTINO, CA 95014, U.S.A.

Prepared by

UL VERIFICATION SERVICES INC.

47173 BENICIA STREET

FREMONT, CA 94538, U.S.A.

TEL: (510) 771-1000

FAX: (510) 661-0888



NVLAP LAB CODE 200065-0

Revision History

<u>Rev.</u>	<u>Issue Date</u>	<u>Revisions</u>	<u>Revised By</u>
V1	09/28/2016	Initial Issue	Mengistu Mekuria
V2	10/13/2016	Updated Section 2, 5.2 to address TCB's questions	Tina Chu

TABLE OF CONTENTS

1. ATTESTATION OF TEST RESULTS	10
2. TEST METHODOLOGY	11
3. FACILITIES AND ACCREDITATION	11
4. CALIBRATION AND UNCERTAINTY	12
4.1. MEASURING INSTRUMENT CALIBRATION.....	12
4.2. SAMPLE CALCULATION.....	12
4.3. MEASUREMENT UNCERTAINTY	12
5. EQUIPMENT UNDER TEST.....	13
5.1. DESCRIPTION OF EUT.....	13
5.2. MAXIMUM OUTPUT POWER.....	13
5.3. DESCRIPTION OF AVAILABLE ANTENNAS.....	15
5.4. SOFTWARE AND FIRMWARE	15
5.5. WORST-CASE CONFIGURATION AND MODE.....	15
5.6. DESCRIPTION OF TEST SETUP	16
6. TEST AND MEASUREMENT EQUIPMENT.....	21
7. ON TIME, DUTY CYCLE AND MEASUREMENT METHODS.....	22
7.1. ON TIME AND DUTY CYCLE.....	22
7.2. MEASUREMENT METHODS.....	34
8. ANTENNA PORT TEST RESULTS.....	35
8.1. 802.11n HT20 CHAIN 0 MODE IN THE 5.2 GHz BAND.....	35
8.1.1. 26 dB BANDWIDTH	35
8.1.2. 99% BANDWIDTH.....	38
8.1.3. AVERAGE POWER (FCC).....	41
8.1.4. OUTPUT POWER AND PSD (FCC).....	42
8.1.5. AVERAGE POWER (IC).....	46
8.1.6. OUTPUT POWER AND PSD (IC).....	47
8.2. 802.11n HT20 CHAIN 1 MODE IN THE 5.2 GHz BAND.....	51
8.2.1. 26 dB BANDWIDTH	51
8.2.2. 99% BANDWIDTH.....	54
8.2.3. AVERAGE POWER (FCC).....	57
8.2.4. OUTPUT POWER AND PSD (FCC).....	58
8.2.5. AVERAGE POWER (IC).....	62
8.2.6. OUTPUT POWER AND PSD (IC).....	63
8.3. 802.11n HT20 CHAIN 2 MODE IN THE 5.2 GHz BAND.....	67
8.3.1. 26 dB BANDWIDTH	67
8.3.2. 99% BANDWIDTH.....	70
8.3.3. AVERAGE POWER (FCC).....	73
8.3.4. OUTPUT POWER AND PSD (FCC).....	74

8.3.5.	AVERAGE POWER (IC).....	78
8.3.6.	OUTPUT POWER AND PSD (IC).....	79
8.4.	<i>802.11n HT20 2Tx (CHAIN 0 + CHAIN 1) CDD MODE IN THE 5.2 GHz BAND</i>	83
8.4.1.	26 dB BANDWIDTH	83
8.4.2.	99% BANDWIDTH.....	87
8.4.3.	AVERAGE POWER (FCC)	91
8.4.4.	OUTPUT POWER AND PSD (FCC).....	92
8.4.5.	AVERAGE POWER (IC).....	98
8.4.6.	OUTPUT POWER AND PSD (IC).....	99
8.5.	<i>802.11n HT20 2Tx (CHAIN 0 + CHAIN 2) CDD MODE IN THE 5.2 GHz BAND</i>	104
8.5.1.	26 dB BANDWIDTH	104
8.5.2.	99% BANDWIDTH.....	108
8.5.3.	AVERAGE POWER (FCC)	112
8.5.4.	OUTPUT POWER AND PSD (FCC).....	113
8.5.5.	AVERAGE POWER (IC).....	119
8.5.6.	OUTPUT POWER AND PSD (IC).....	120
8.6.	<i>802.11n HT20 2Tx (CHAIN 1 + CHAIN 2) CDD MODE IN THE 5.2 GHz BAND</i>	125
8.6.1.	26 dB BANDWIDTH	125
8.6.2.	99% BANDWIDTH.....	129
8.6.3.	AVERAGE POWER (FCC)	133
8.6.4.	OUTPUT POWER AND PSD (FCC).....	134
8.6.5.	AVERAGE POWER (IC).....	140
8.6.6.	OUTPUT POWER AND PSD (IC).....	141
8.7.	<i>802.11n HT20 2Tx (CHAIN 0 + CHAIN 1) STBC MODE IN THE 5.2 GHz BAND</i>	146
8.7.1.	26 dB BANDWIDTH	146
8.7.2.	99% BANDWIDTH.....	150
8.7.3.	AVERAGE POWER (FCC)	154
8.7.4.	OUTPUT POWER AND PSD (FCC).....	155
8.7.5.	AVERAGE POWER (IC).....	160
8.7.6.	OUTPUT POWER AND PSD (IC).....	161
8.8.	<i>802.11n HT20 2Tx (CHAIN 0 + CHAIN 2) STBC MODE IN THE 5.2 GHz BAND</i>	166
8.8.1.	26 dB BANDWIDTH	166
8.8.2.	99% BANDWIDTH.....	170
8.8.3.	AVERAGE POWER (FCC)	174
8.8.4.	OUTPUT POWER AND PSD (FCC).....	175
8.8.5.	AVERAGE POWER (IC).....	180
8.8.6.	OUTPUT POWER AND PSD (IC).....	181
8.9.	<i>802.11n HT20 2Tx (CHAIN 1 + CHAIN 2) STBC MODE IN THE 5.2 GHz BAND</i>	186
8.9.1.	26 dB BANDWIDTH	186
8.9.2.	99% BANDWIDTH.....	190
8.9.3.	AVERAGE POWER (FCC)	194
8.9.4.	OUTPUT POWER AND PSD (FCC).....	195
8.9.5.	AVERAGE POWER (IC).....	200
8.9.6.	OUTPUT POWER AND PSD (IC).....	201
8.10.	<i>802.11ac VHT20 2Tx (CHAIN 0 + CHAIN 1) BEAM FORMING MODE IN THE 5.2 GHz BAND 206</i>	
8.10.1.	26 dB BANDWIDTH.....	206
8.10.2.	99% BANDWIDTH.....	210
8.10.3.	AVERAGE POWER (FCC)	214
8.10.4.	OUTPUT POWER AND PSD (FCC)	215

8.10.5.	AVERAGE POWER (IC)	221
8.10.6.	OUTPUT POWER AND PSD (IC)	222
8.11.	<i>802.11ac VHT20 2Tx (CHAIN 0 + CHAIN 2) BEAM FORMING MODE IN THE 5.2 GHz BAND 227</i>	
8.11.1.	26 dB BANDWIDTH.....	227
8.11.2.	99% BANDWIDTH.....	231
8.11.3.	AVERAGE POWER (FCC)	235
8.11.4.	OUTPUT POWER AND PSD (FCC)	236
8.11.5.	AVERAGE POWER (IC)	242
8.11.6.	OUTPUT POWER AND PSD (IC)	243
8.12.	<i>802.11ac VHT20 2Tx (CHAIN 1 + CHAIN 2) BEAM FORMING MODE IN THE 5.2 GHz BAND 248</i>	
8.12.1.	26 dB BANDWIDTH.....	248
8.12.2.	99% BANDWIDTH.....	252
8.12.3.	AVERAGE POWER (FCC)	256
8.12.4.	OUTPUT POWER AND PSD (FCC)	257
8.12.5.	AVERAGE POWER (IC)	263
8.12.6.	OUTPUT POWER AND PSD (IC)	264
8.13.	<i>802.11n HT20 3Tx CDD MODE IN THE 5.2 GHz BAND.....</i>	<i>269</i>
8.13.1.	26 dB BANDWIDTH.....	269
8.13.2.	99% BANDWIDTH.....	275
8.13.3.	AVERAGE POWER (FCC)	281
8.13.4.	OUTPUT POWER AND PSD (FCC)	282
8.13.5.	AVERAGE POWER (IC)	290
8.13.6.	OUTPUT POWER AND PSD (IC)	291
8.14.	<i>802.11n HT20 3Tx STBC MODE IN THE 5.2 GHz BAND.....</i>	<i>298</i>
8.14.1.	26 dB BANDWIDTH.....	298
8.14.2.	99% BANDWIDTH.....	304
8.14.3.	AVERAGE POWER (FCC)	310
8.14.4.	OUTPUT POWER AND PSD (FCC)	311
8.14.5.	AVERAGE POWER (IC)	319
8.14.6.	OUTPUT POWER AND PSD (IC)	320
8.15.	<i>802.11ac VHT20 3Tx BEAM FORMING MODE IN THE 5.2 GHz BAND.....</i>	<i>327</i>
8.15.1.	26 dB BANDWIDTH.....	327
8.15.2.	99% BANDWIDTH.....	333
8.15.3.	AVERAGE POWER (FCC)	339
8.15.4.	OUTPUT POWER AND PSD (FCC)	340
8.15.5.	AVERAGE POWER (IC)	348
8.15.6.	OUTPUT POWER AND PSD (IC)	349
8.16.	<i>802.11n HT40 CHAIN 0 MODE IN THE 5.2 GHz BAND.....</i>	<i>356</i>
8.16.1.	26 dB BANDWIDTH.....	356
8.16.2.	99% BANDWIDTH.....	358
8.16.3.	AVERAGE POWER (FCC)	360
8.16.4.	OUTPUT POWER AND PSD (FCC)	361
8.16.5.	AVERAGE POWER (IC)	364
8.16.6.	OUTPUT POWER AND PSD (IC)	365
8.17.	<i>802.11n HT40 CHAIN 1 MODE IN THE 5.2 GHz BAND.....</i>	<i>368</i>
8.17.1.	26 dB BANDWIDTH.....	368
8.17.2.	99% BANDWIDTH.....	370
8.17.3.	AVERAGE POWER (FCC)	372

8.17.4.	OUTPUT POWER AND PSD (FCC)	373
8.17.5.	AVERAGE POWER (IC)	376
8.17.6.	OUTPUT POWER AND PSD (IC)	377
8.18.	<i>802.11n HT40 CHAIN 2 MODE IN THE 5.2 GHz BAND</i>	380
8.18.1.	26 dB BANDWIDTH	380
8.18.2.	99% BANDWIDTH	382
8.18.3.	AVERAGE POWER (FCC)	384
8.18.4.	OUTPUT POWER AND PSD (FCC)	385
8.18.5.	AVERAGE POWER (IC)	388
8.18.6.	OUTPUT POWER AND PSD (IC)	389
8.19.	<i>802.11n HT40 2Tx (CHAIN 0 + CHAIN 1) CDD MODE IN THE 5.2 GHz BAND</i>	392
8.19.1.	26 dB BANDWIDTH	392
8.19.2.	99% BANDWIDTH	395
8.19.3.	AVERAGE POWER (FCC)	398
8.19.4.	OUTPUT POWER AND PSD (FCC)	399
8.19.5.	AVERAGE POWER (IC)	404
8.19.6.	OUTPUT POWER AND PSD (IC)	405
8.20.	<i>802.11n HT40 2Tx (CHAIN 0 + CHAIN 2) CDD MODE IN THE 5.2 GHz BAND</i>	409
8.20.1.	26 dB BANDWIDTH	409
8.20.2.	99% BANDWIDTH	412
8.20.3.	AVERAGE POWER (FCC)	415
8.20.4.	OUTPUT POWER AND PSD (FCC)	416
8.20.5.	AVERAGE POWER (IC)	421
8.20.6.	OUTPUT POWER AND PSD (IC)	422
8.21.	<i>802.11n HT40 2Tx (CHAIN 1 + CHAIN 2) CDD MODE IN THE 5.2 GHz BAND</i>	426
8.21.1.	26 dB BANDWIDTH	426
8.21.2.	99% BANDWIDTH	429
8.21.3.	AVERAGE POWER (FCC)	432
8.21.4.	OUTPUT POWER AND PSD (FCC)	433
8.21.5.	AVERAGE POWER (IC)	438
8.21.6.	OUTPUT POWER AND PSD (IC)	439
8.22.	<i>802.11n HT40 2Tx (CHAIN 0 + CHAIN 1) STBC MODE IN THE 5.2 GHz BAND</i>	443
8.22.1.	26 dB BANDWIDTH	443
8.22.2.	99% BANDWIDTH	446
8.22.3.	AVERAGE POWER (FCC)	449
8.22.4.	OUTPUT POWER AND PSD (FCC)	450
8.22.5.	AVERAGE POWER (IC)	455
8.22.6.	OUTPUT POWER AND PSD (IC)	456
8.23.	<i>802.11n HT40 2Tx (CHAIN 0 + CHAIN 2) STBC MODE IN THE 5.2 GHz BAND</i>	460
8.23.1.	26 dB BANDWIDTH	460
8.23.2.	99% BANDWIDTH	463
8.23.3.	AVERAGE POWER (FCC)	466
8.23.4.	OUTPUT POWER AND PSD (FCC)	467
8.23.5.	AVERAGE POWER (IC)	472
8.23.6.	OUTPUT POWER AND PSD (IC)	473
8.24.	<i>802.11n HT40 2Tx (CHAIN 1 + CHAIN 2) STBC MODE IN THE 5.2 GHz BAND</i>	477
8.24.1.	26 dB BANDWIDTH	477
8.24.2.	99% BANDWIDTH	480
8.24.3.	AVERAGE POWER (FCC)	483
8.24.4.	OUTPUT POWER AND PSD (FCC)	484

8.24.5.	AVERAGE POWER (IC)	489
8.24.6.	OUTPUT POWER AND PSD (IC)	490
8.25.	<i>802.11ac VHT40 2Tx (CHAIN 0 + CHAIN 1) BEAM FORMING MODE IN THE 5.2 GHz BAND 494</i>	
8.25.1.	26 dB BANDWIDTH.....	494
8.25.2.	99% BANDWIDTH.....	497
8.25.3.	AVERAGE POWER (FCC)	500
8.25.4.	OUTPUT POWER AND PSD (FCC)	501
8.25.5.	AVERAGE POWER (IC)	506
8.25.6.	OUTPUT POWER AND PSD (IC)	507
8.26.	<i>802.11ac VHT40 2Tx (CHAIN 0 + CHAIN 2) BEAM FORMING MODE IN THE 5.2 GHz BAND 511</i>	
8.26.1.	26 dB BANDWIDTH.....	511
8.26.2.	99% BANDWIDTH.....	514
8.26.3.	AVERAGE POWER (FCC)	517
8.26.4.	OUTPUT POWER AND PSD (FCC)	518
8.26.5.	AVERAGE POWER (IC)	523
8.26.6.	OUTPUT POWER AND PSD (IC)	524
8.27.	<i>802.11ac VHT40 2Tx (CHAIN 1 + CHAIN 2) BEAM FORMING MODE IN THE 5.2 GHz BAND 528</i>	
8.27.1.	26 dB BANDWIDTH.....	528
8.27.2.	99% BANDWIDTH.....	531
8.27.3.	AVERAGE POWER (FCC)	534
8.27.4.	OUTPUT POWER AND PSD (FCC)	535
8.27.5.	AVERAGE POWER (IC)	540
8.27.6.	OUTPUT POWER AND PSD (IC)	541
8.28.	<i>802.11n HT40 3Tx CDD MODE IN THE 5.2 GHz BAND.....</i>	<i>545</i>
8.28.1.	26 dB BANDWIDTH.....	545
8.28.2.	99% BANDWIDTH.....	549
8.28.3.	AVERAGE POWER (FCC)	553
8.28.4.	OUTPUT POWER AND PSD (FCC)	554
8.28.5.	AVERAGE POWER (IC)	560
8.28.6.	OUTPUT POWER AND PSD (IC)	561
8.29.	<i>802.11n HT40 3Tx STBC MODE IN THE 5.2 GHz BAND.....</i>	<i>566</i>
8.29.1.	26 dB BANDWIDTH.....	566
8.29.2.	99% BANDWIDTH.....	570
8.29.3.	AVERAGE POWER (FCC)	574
8.29.4.	OUTPUT POWER AND PSD (FCC)	575
8.29.5.	AVERAGE POWER (IC)	581
8.29.6.	OUTPUT POWER AND PSD (IC)	582
8.30.	<i>802.11ac VHT40 3Tx BEAM FORMING MODE IN THE 5.2 GHz BAND.....</i>	<i>587</i>
8.30.1.	26 dB BANDWIDTH.....	587
8.30.2.	99% BANDWIDTH.....	591
8.30.3.	AVERAGE POWER (FCC)	595
8.30.4.	OUTPUT POWER AND PSD (FCC)	596
8.30.5.	AVERAGE POWER (IC)	602
8.30.6.	OUTPUT POWER AND PSD (IC)	603
8.31.	<i>802.11ac VHT80 CHAIN 0 MODE IN THE 5.2 GHz BAND</i>	<i>608</i>
8.31.1.	26 dB BANDWIDTH.....	608
8.31.2.	99% BANDWIDTH.....	609

8.31.3.	AVERAGE POWER (FCC/IC)	610
8.31.4.	OUTPUT POWER AND PSD (FCC)	611
8.31.5.	OUTPUT POWER AND PSD (IC)	614
8.32.	<i>802.11ac VHT80 CHAIN 1 MODE IN THE 5.2 GHz BAND</i>	617
8.32.1.	26 dB BANDWIDTH	617
8.32.2.	99% BANDWIDTH	618
8.32.3.	AVERAGE POWER (FCC/IC)	619
8.32.4.	OUTPUT POWER AND PSD (FCC)	620
8.32.5.	OUTPUT POWER AND PSD (IC)	623
8.33.	<i>802.11ac VHT80 CHAIN 2 MODE IN THE 5.2 GHz BAND</i>	626
8.33.1.	26 dB BANDWIDTH	626
8.33.2.	99% BANDWIDTH	627
8.33.3.	AVERAGE POWER (FCC/IC)	628
8.33.4.	OUTPUT POWER AND PSD (FCC)	629
8.33.5.	OUTPUT POWER AND PSD (IC)	632
8.34.	<i>802.11ac VHT80 2Tx (CHAIN 0 + CHAIN 1) CDD MODE IN THE 5.2 GHz BAND</i>	635
8.34.1.	26 dB BANDWIDTH	635
8.34.2.	99% BANDWIDTH	637
8.34.3.	AVERAGE POWER (FCC/IC)	639
8.34.4.	OUTPUT POWER AND PSD (FCC)	640
8.34.5.	OUTPUT POWER AND PSD (IC)	644
8.35.	<i>802.11ac VHT80 2Tx (CHAIN 0 + CHAIN 2) CDD MODE IN THE 5.2 GHz BAND</i>	647
8.35.1.	26 dB BANDWIDTH	647
8.35.2.	99% BANDWIDTH	649
8.35.3.	AVERAGE POWER (FCC/IC)	651
8.35.4.	OUTPUT POWER AND PSD (FCC)	652
8.35.5.	OUTPUT POWER AND PSD (IC)	656
8.36.	<i>802.11ac VHT80 2Tx (CHAIN 1 + CHAIN 2) CDD MODE IN THE 5.2 GHz BAND</i>	659
8.36.1.	26 dB BANDWIDTH	659
8.36.2.	99% BANDWIDTH	661
8.36.3.	AVERAGE POWER (FCC/IC)	663
8.36.4.	OUTPUT POWER AND PSD (FCC)	664
8.36.5.	OUTPUT POWER AND PSD (IC)	668
8.37.	<i>802.11ac VHT80 2Tx (CHAIN 0 + CHAIN 1) STBC MODE IN THE 5.2 GHz BAND</i>	671
8.37.1.	26 dB BANDWIDTH	671
8.37.2.	99% BANDWIDTH	673
8.37.3.	AVERAGE POWER (FCC/IC)	675
8.37.4.	OUTPUT POWER AND PSD (FCC)	676
8.37.5.	OUTPUT POWER AND PSD (IC)	680
8.38.	<i>802.11ac VHT80 2Tx (CHAIN 0 + CHAIN 2) STBC MODE IN THE 5.2 GHz BAND</i>	683
8.38.1.	26 dB BANDWIDTH	683
8.38.2.	99% BANDWIDTH	685
8.38.3.	AVERAGE POWER (FCC/IC)	687
8.38.4.	OUTPUT POWER AND PSD (FCC)	688
8.38.5.	OUTPUT POWER AND PSD (IC)	692
8.39.	<i>802.11ac VHT80 2Tx (CHAIN 1 + CHAIN 2) STBC MODE IN THE 5.2 GHz BAND</i>	695
8.39.1.	26 dB BANDWIDTH	695
8.39.2.	99% BANDWIDTH	697
8.39.3.	AVERAGE POWER (FCC/IC)	699

8.39.4.	OUTPUT POWER AND PSD (FCC)	700
8.39.5.	OUTPUT POWER AND PSD (IC)	704
8.40.	<i>802.11ac VHT80 2Tx (CHAIN 0 + CHAIN 1) BEAM FORMING MODE IN THE 5.2 GHz BAND 707</i>	
8.40.1.	26 dB BANDWIDTH.....	707
8.40.2.	99% BANDWIDTH.....	709
8.40.3.	AVERAGE POWER (FCC/IC)	711
8.40.4.	OUTPUT POWER AND PSD (FCC)	712
8.40.5.	OUTPUT POWER AND PSD (IC)	716
8.41.	<i>802.11ac VHT80 2Tx (CHAIN 0 + CHAIN 2) BEAM FORMING MODE IN THE 5.2 GHz BAND 719</i>	
8.41.1.	26 dB BANDWIDTH.....	719
8.41.2.	99% BANDWIDTH.....	721
8.41.3.	AVERAGE POWER (FCC/IC)	723
8.41.4.	OUTPUT POWER AND PSD (FCC)	724
8.41.5.	OUTPUT POWER AND PSD (IC)	728
8.42.	<i>802.11ac VHT80 2Tx (CHAIN 1 + CHAIN 2) BEAM FORMING MODE IN THE 5.2 GHz BAND 731</i>	
8.42.1.	26 dB BANDWIDTH.....	731
8.42.2.	99% BANDWIDTH.....	733
8.42.3.	AVERAGE POWER (FCC/IC)	735
8.42.4.	OUTPUT POWER AND PSD (FCC)	736
8.42.5.	OUTPUT POWER AND PSD (IC)	740
8.43.	<i>802.11ac VHT80 3Tx CDD MODE IN THE 5.2 GHz BAND.....</i>	<i>743</i>
8.43.1.	26 dB BANDWIDTH.....	743
8.43.2.	99% BANDWIDTH.....	746
8.43.3.	AVERAGE POWER (FCC/IC)	749
8.43.4.	OUTPUT POWER AND PSD (FCC)	750
8.43.5.	OUTPUT POWER AND PSD (IC)	755
8.44.	<i>802.11ac VHT80 3Tx STBC MODE IN THE 5.2 GHz BAND.....</i>	<i>759</i>
8.44.1.	26 dB BANDWIDTH.....	759
8.44.2.	99% BANDWIDTH.....	762
8.44.3.	AVERAGE POWER (FCC/IC)	765
8.44.4.	OUTPUT POWER AND PSD (FCC)	766
8.44.5.	OUTPUT POWER AND PSD (IC)	771
8.45.	<i>802.11ac VHT80 3Tx BEAM FORMING MODE IN THE 5.2 GHz BAND.....</i>	<i>775</i>
8.45.1.	26 dB BANDWIDTH.....	775
8.45.2.	99% BANDWIDTH.....	778
8.45.3.	AVERAGE POWER (FCC/IC)	781
8.45.4.	OUTPUT POWER AND PSD (FCC)	782
8.45.5.	OUTPUT POWER AND PSD (IC)	787

1. ATTESTATION OF TEST RESULTS

COMPANY NAME: APPLE, INC.
1 INFINITE LOOP
CUPERTINO, CA 95014, U.S.A.

EUT DESCRIPTION: PORTABLE COMPUTER

MODEL: A1707

SERIAL NUMBER: C02S3004H7CF (CONDUCTED);
C02S400FH7C9 (RADIATED/DFS)

DATE TESTED: AUGUST 02, 2016- SEPTEMBER 21, 2016

APPLICABLE STANDARDS	
STANDARD	TEST RESULTS
CFR 47 Part 15 Subpart E	Pass
INDUSTRY CANADA RSS-247 Issue 1	Pass
INDUSTRY CANADA RSS-GEN Issue 4	Pass

UL Verification Services Inc. tested the above equipment in accordance with the requirements set forth in the above standards. All indications of Pass/Fail in this report are opinions expressed by UL Verification Services Inc. based on interpretations and/or observations of test results. Measurement Uncertainties were not taken into account and are published for informational purposes only. The test results show that the equipment tested is capable of demonstrating compliance with the requirements as documented in this report.

Note: The results documented in this report apply only to the tested sample, under the conditions and modes of operation as described herein. This document may not be altered or revised in any way unless done so by UL Verification Services Inc. and all revisions are duly noted in the revisions section. Any alteration of this document not carried out by UL Verification Services Inc. will constitute fraud and shall nullify the document. This report must not be used by the client to claim product certification, approval, or endorsement by NVLAP, NIST, any agency of the Federal Government, or any agency of any government.

Approved & Released For
UL Verification Services Inc. By:

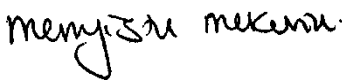

MENGISTU MEKURIA
SENIOR ENGINEER
UL VERIFICATION SERVICES INC.

Prepared By:



TRI PHAM
EMC ENGINEER
UL VERIFICATION SERVICES INC.

2. TEST METHODOLOGY

FCC: The tests documented in this report were performed in accordance with FCC CFR 47 Part 2, FCC CFR 47 Part 15, FCC 14-30, FCC KDB 662911 D01 v02r01, FCC KDB 905462 D02 v02/D03 v01r01/D06 v02/ D07 v01r01, FCC KDB 789033 D02 v01r03, FCC KDB 644545 D03 v01, ANSI C63.10-2013.

IC: The tests documented in this report were performed in accordance with FCC KDB 789033 D02 v01r03, FCC KDB 905462 D02 v02/D03 v01r01, ANSI C63.10-2013, RSS-GEN Issue 4, and RSS-247 Issue 1

3. FACILITIES AND ACCREDITATION

The test sites and measurement facilities used to collect data are located at 47173 and 47266 Benicia Street, Fremont, California, USA. Line conducted emissions are measured only at the 47173 address. The following table identifies which facilities were utilized for radiated emission measurements documented in this report. Specific facilities are also identified in the test results sections.

47173 Benicia Street	47266 Benicia Street
<input type="checkbox"/> Chamber A	<input checked="" type="checkbox"/> Chamber D
<input type="checkbox"/> Chamber B	<input checked="" type="checkbox"/> Chamber E
<input type="checkbox"/> Chamber C	<input type="checkbox"/> Chamber F
	<input checked="" type="checkbox"/> Chamber G
	<input checked="" type="checkbox"/> Chamber H

The above test sites and facilities are covered under FCC Test Firm Registration # 208313. Chambers A through H are covered under Industry Canada company address code 2324B with site numbers 2324B -1 through 2324B-8, respectively.

UL Verification Services Inc. is accredited by NVLAP, Laboratory Code 200065-0. The full scope of accreditation can be viewed at <http://ts.nist.gov/standards/scopes/2000650.htm>.

4. CALIBRATION AND UNCERTAINTY

4.1. MEASURING INSTRUMENT CALIBRATION

The measuring equipment utilized to perform the tests documented in this report has been calibrated in accordance with the manufacturer's recommendations, and is traceable to recognized national standards.

4.2. SAMPLE CALCULATION

Where relevant, the following sample calculation is provided:

$$\begin{aligned} \text{Field Strength (dBuV/m)} &= \text{Measured Voltage (dBuV)} + \text{Antenna Factor (dB/m)} + \text{Cable} \\ &\text{Loss (dB)} - \text{Preamp Gain (dB)} \\ 36.5 \text{ dBuV} + 18.7 \text{ dB/m} + 0.6 \text{ dB} - 26.9 \text{ dB} &= 28.9 \text{ dBuV/m} \end{aligned}$$

4.3. MEASUREMENT UNCERTAINTY

Where relevant, the following measurement uncertainty levels have been estimated for tests performed on the apparatus:

PARAMETER	UNCERTAINTY
Conducted Disturbance, 9KHz to 0.15 MHz	3.84 dB
Conducted Disturbance, 0.15 to 30 MHz	3.65 dB
Radiated Disturbance, 9KHz to 30 MHz	3.15 dB
Radiated Disturbance, 30 to 1000 MHz	5.36 dB
Radiated Disturbance, 1000 to 18000 MHz	4.32 dB
Radiated Disturbance, 18000 to 26000 MHz	4.45 dB
Radiated Disturbance, 26000 to 40000 MHz	5.24 dB

Uncertainty figures are valid to a confidence level of 95%.

5. EQUIPMENT UNDER TEST

5.1. DESCRIPTION OF EUT

The EUT is a portable computer with Bluetooth and WLAN Radios (AC 80 MHz Beam Forming).

5.2. MAXIMUM OUTPUT POWER

The transmitter has a maximum average conducted output power as follows:

5.2GHz Band FCC

Frequency Range (MHz)	Mode	Output Power (dBm)	Output Power (mW)
5180 - 5240	802.11a	Covered by 802.11n HT20 SISO	
	802.11n HT20 SISO	13.23	21.04
	802.11n HT20 2TX CDD	15.96	39.45
	802.11n HT20 2TX STBC	16.26	42.27
	802.11ac VHT20 2TX Beam Forming	15.98	39.63
	802.11n HT20 3TX CDD	14.70	29.51
	802.11n HT20 3TX STBC	17.70	58.88
5190 - 5230	802.11ac VHT20 3TX Beam Forming	14.67	29.31
	802.11n HT40 SISO	13.21	20.94
	802.11n HT40 2TX CDD	16.24	42.07
	802.11n HT40 2TX STBC	16.23	41.98
	802.11n HT40 2TX Beam Forming	16.23	41.98
	802.11n HT40 3TX CDD	17.98	62.81
	802.11n HT40 3TX STBC	17.95	62.37
5210	802.11n HT40 3TX Beam Forming	17.23	52.84
	802.11ac VHT80 SISO	11.98	15.78
	802.11ac VHT80 2TX CDD	11.00	12.59
	802.11ac VHT80 2TX STBC/SDM	10.93	12.39
	802.11ac VHT80 2TX Beam Forming	10.50	11.22
	802.11ac VHT80 3TX CDD	12.21	16.63
	802.11ac VHT80 3TX STBC/SDM	15.24	33.42
	802.11ac VHT80 3TX Beam Forming	12.10	16.22

5.2GHz Band IC

Frequency Range (MHz)	Mode	Output Power (dBm)	Output Power (mW)
5180 - 5240	802.11a	Covered by 802.11n HT20 SISO	
	802.11n HT20 SISO	10.98	12.53
	802.11n HT20 2TX CDD	9.01	7.96
	802.11n HT20 2TX STBC	11.00	12.59
	802.11ac VHT20 2TX Beam Forming	8.96	7.87
	802.11n HT20 3TX CDD	7.24	5.30
	802.11n HT20 3TX STBC	10.69	11.72
5190 - 5230	802.11n HT40 SISO	13.00	19.95
	802.11n HT40 2TX CDD	10.97	12.50
	802.11n HT40 2TX STBC	12.93	19.63
	802.11n HT40 2TX Beam Forming	10.98	12.53
	802.11n HT40 3TX CDD	10.22	10.52
	802.11n HT40 3TX STBC	13.70	23.44
	802.11n HT40 3TX Beam Forming	10.27	10.64
5210	802.11ac VHT80 SISO	11.98	15.78
	802.11ac VHT80 2TX CDD	11.00	12.59
	802.11ac VHT80 2TX STBC/SDM	10.93	12.39
	802.11ac VHT80 2TX Beam Forming	10.50	11.22
	802.11ac VHT80 3TX CDD	12.21	16.63
	802.11ac VHT80 3TX STBC/SDM	15.24	33.42
	802.11ac VHT80 3TX Beam Forming	12.10	16.22

5.3. DESCRIPTION OF AVAILABLE ANTENNAS

Frequency Band (GHz)	Antenna Gain (dBi)		
	Chain 0	Chain 1	Chain 2
5.2	3.8	6.7	4.9

5.4. SOFTWARE AND FIRMWARE

The firmware version installed in the EUT during testing was 7.21.170.1.

5.5. WORST-CASE CONFIGURATION AND MODE

For radiated harmonics spurious and power line conducted emissions were performed with the EUT set at the CDD mode at highest power setting among the CDD/STBC/SDM/Beamforming modes as worst-case scenario.

For SISO modes, there are three transmission antennas. The antenna used in any given time can be either Chain 0, Chain 1 or Chain 2. All antenna ports have the same power; output power and PSD measurement for SISO modes on both antennas are reported. For 2TX MIMO modes, Chain 0/Chain 1, Chain 0/Chain 2, Chain 1/Chain 2 used at the same time. For 3TX MIMO mode, Chain 0/Chain 1/Chain 2 used at the same time.

Worst-case data rates as provided by the client were:

- 802.11a mode: 6 Mbps
- 802.11n HT20 mode: MCS0
- 802.11n HT40 mode: MCS0
- 802.11ac VHT20 mode: MCS0
- 802.11ac VHT40 mode: MCS0
- 802.11ac VHT80 mode: MCS0

802.11ac VHT20 and VHT40 mode are different from 802.11nHT20 and HT40 only in control messages and have the same power settings.

For simultaneous transmission of multiple channels from the same antenna in the 2.4GHz and 5GHz bands, tests were conducted for various configurations having the highest power. No noticeable new emission was found.

5.6. DESCRIPTION OF TEST SETUP

SUPPORT EQUIPMENT

Support Equipment List				
Description	Manufacturer	Model	Serial Number	FCC ID
AC/ DC Adapter	Apple Inc.	A1540	N/A	N/A

I/O CABLES (CONDUCTED TEST)

I/O Cable List						
Cable No	Port	# of identical ports	Connector Type	Cable Type	Cable Length (m)	Remarks
1	Antenna	2	SMA	Un-Shielded	0.2	To Spectrum Analyzer
2	DC	1	Lightning	Un-Shielded	2	N/A

I/O CABLES (ABOVE 1G RADIATED TEST)

I/O Cable List						
Cable No	Port	# of identical ports	Connector Type	Cable Type	Cable Length (m)	Remarks
1	DC	1	Lightning	Un-Shielded	2	N/A

I/O CABLES (BELOW 1G RADIATED AND AC POWER CONDUCTED TEST)

I/O Cable List						
Cable No	Port	# of identical ports	Connector Type	Cable Type	Cable Length (m)	Remarks
1	DC	1	Lightning	Un-Shielded	2	NA
2	Audio	1	Jack	Un-Shielded	0.5	NA

TEST SETUP- CONDUCTED PORT

The EUT was tested connected to spectrum analyzer via antenna port. Test software exercised the EUT.

SETUP DIAGRAM

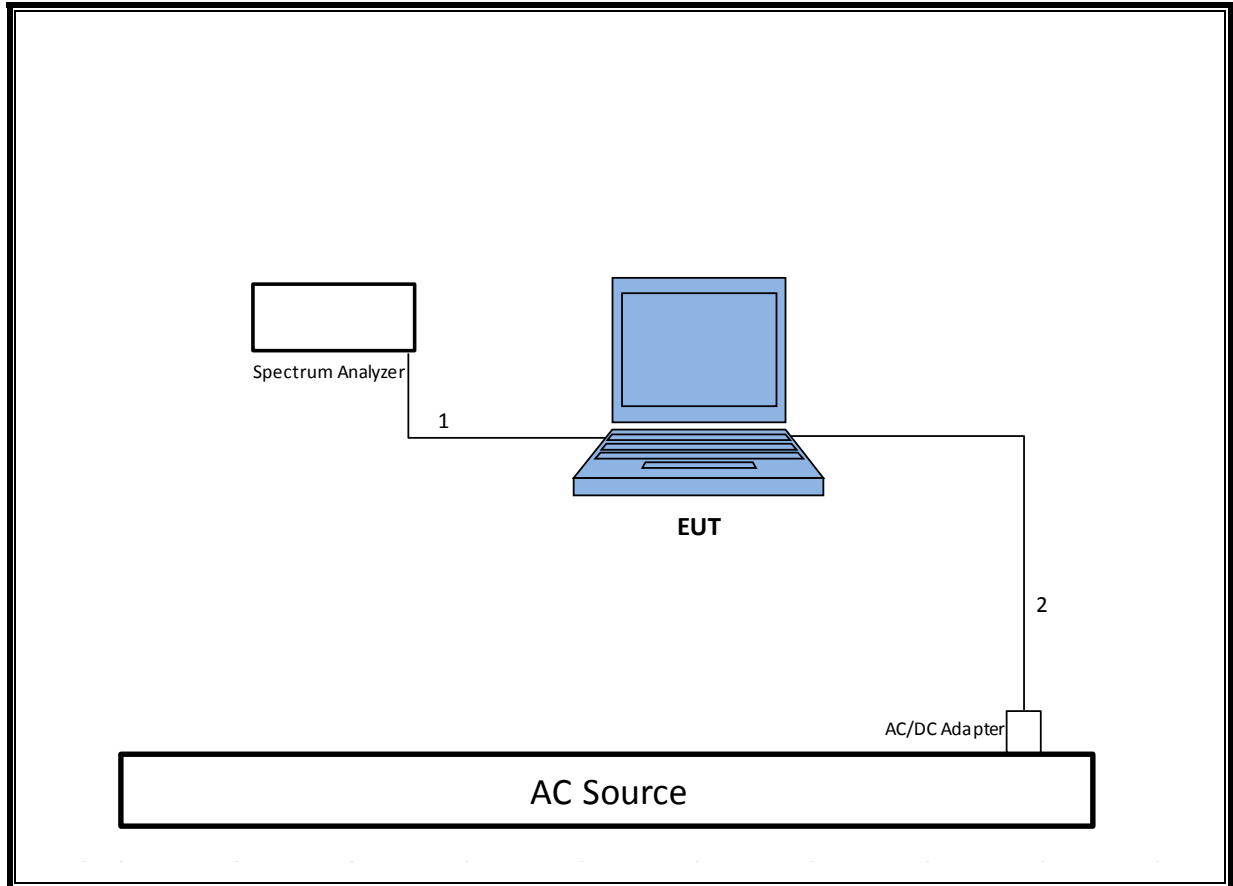

TEST SETUP- RADIATED- ABOVE 1 GHz

The EUT was powered by AC/DC adapter. Test software exercised the EUT.

SETUP DIAGRAM

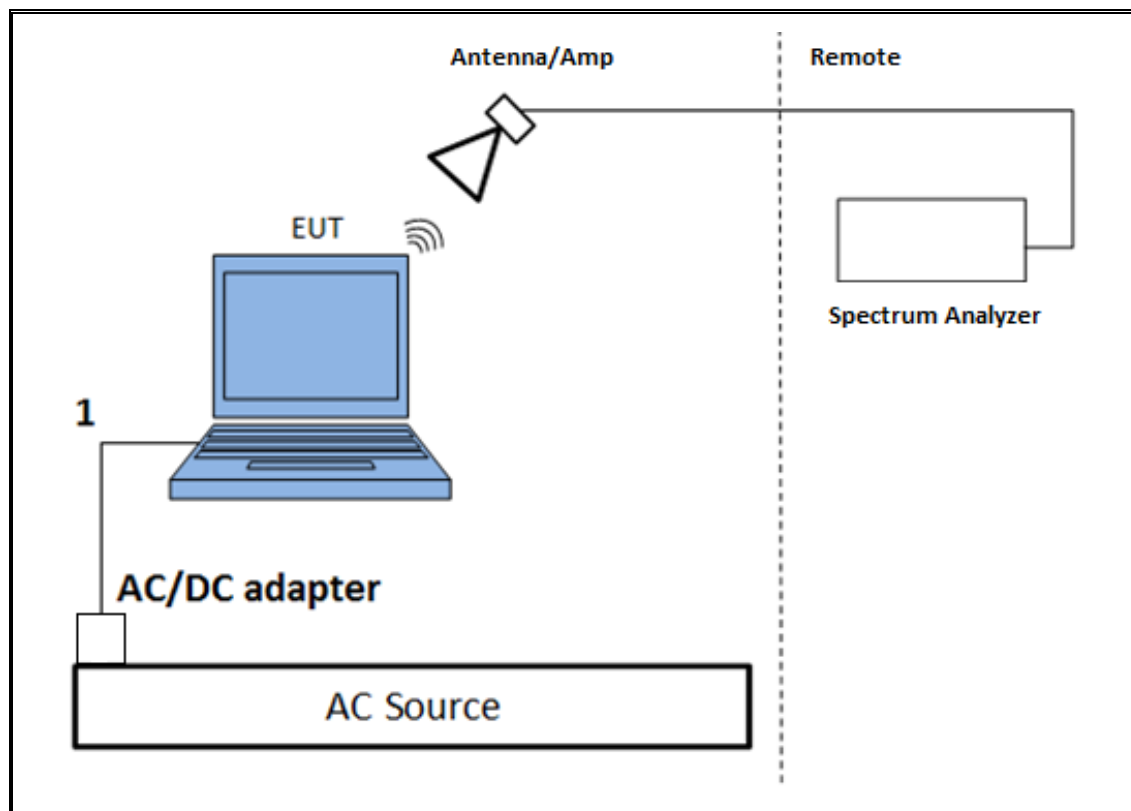

TEST SETUP- RADIATED- BELOW 1 GHz

The EUT was powered by AC/DC adapter and with earphone plugged in. Test software exercised the EUT.

SETUP DIAGRAM

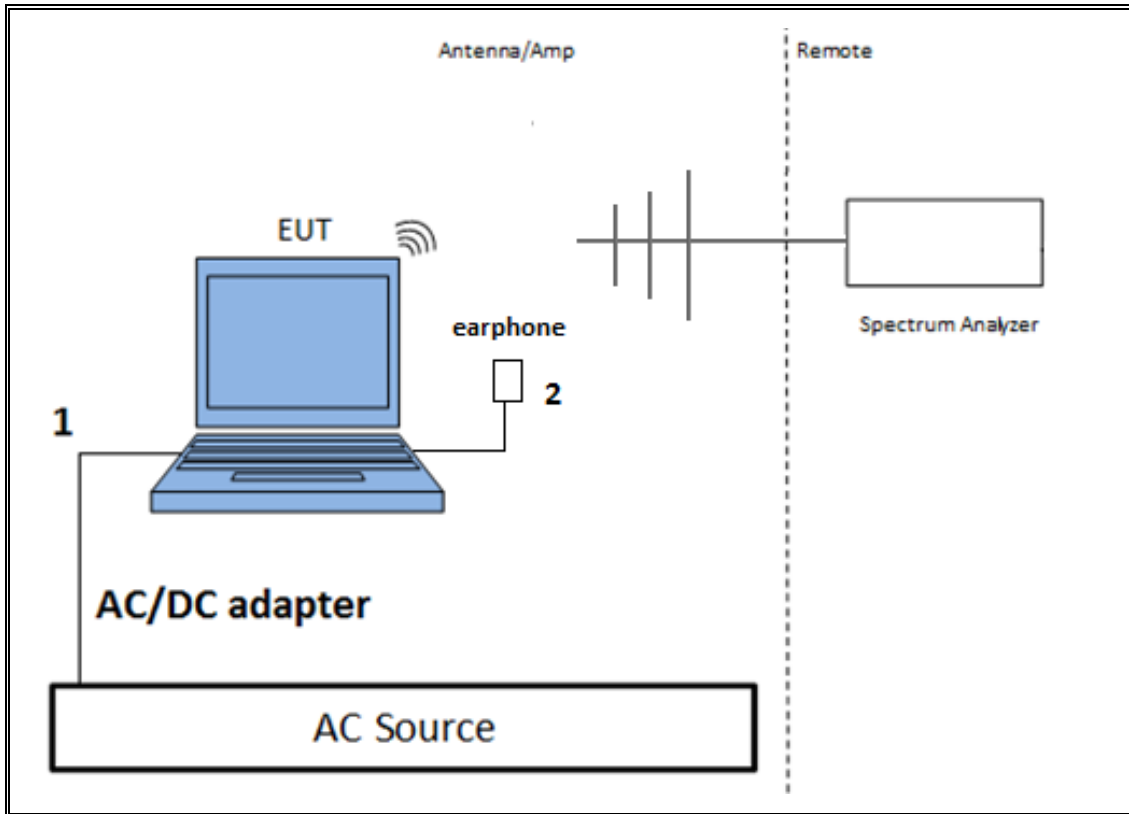

TEST SETUP- AC LINE CONDUCTED TESTS

The EUT was powered by AC/DC adapter and with earphone plugged in. Test software exercised the EUT.

SETUP DIAGRAM

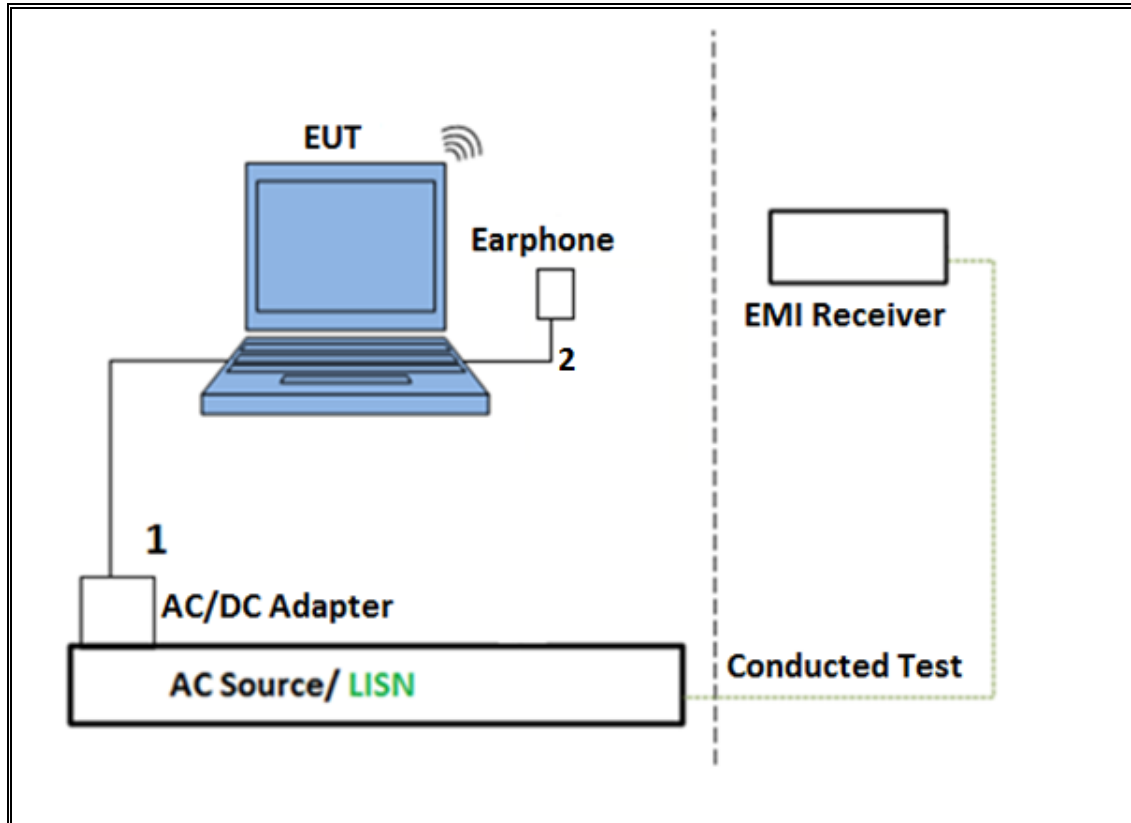

6. TEST AND MEASUREMENT EQUIPMENT

The following test and measurement equipment was utilized for the tests documented in this report:

Test Equipment List				
Description	Manufacturer	Model	T Number	Cal Due
Antenna, Horn 1-18GHz	ETS Lindgren	3117	T120	4/5/2017
Antenna, Broadband Hybrid, 30MHz to 2000MHz	Sunol Sciences	JB3	T122	1/29/2017
Amplifier, 10KHz to 1GHz, 32dB	Sonoma	310N	T173	6/17/2017
Spectrum Analyzer, PXA, 3Hz to 44GHz	Agilent	N9030A	T341	10/14/2016
Antenna, Horn 1-18GHz	ETS Lindgren	3117	T862	4/18/2017
Antenna, Broadband Hybrid, 30MHz to 2000MHz	Sunol Sciences	JB3	T899	5/26/2017
Amplifier, 1 - 18GHz	Miteq	AFS42-00101800-25-S-42	T491	5/31/2017
Amplifier, 10KHz to 1GHz, 32dB	Sonoma	310N	T834	6/17/2017
Spectrum Analyzer, PXA, 3Hz to 44GHz	Agilent	N9030A	T905	6/21/2017
Power Meter, P-series single channel	Agilent	N1911A	T1271	7/8/2017
Power Sensor, P - series, 50MHz to 18GHz, Wideband	Agilent	N1921A	T1228	6/20/2017
Antenna, Horn 18 to 26.5GHz	ARA	MWH-1826	T447	6/16/2017
***Spectrum Analyzer, 40 GHz	Agilent	8564E	T106	9/7/2017
Amplifier, 1 to 26.5GHz, 23.5dB Gain minimum	Keysight	8449B	T402	7/5/2017
AC Line Conducted				
EMI Test Receiver 9KHz-7GHz	Rohde & Schwarz	ESCI7	T1436	12/19/2016
LISN for Conducted Emissions CISPR-16	Fischer	50/250-25-2-01	T1310	6/8/2017
**AC Source	Shaffner	NSG 1007	T134	9/11/2016
UL SOFTWARE				
* Radiated Software	UL	UL EMC	Ver 9.5, June 24, 2015	
* Conducted Software	UL	UL EMC	Ver 4.0, January 11, 2016	
* AC Line Conducted Software	UL	UL EMC	Ver 9.5, May 26, 2015	

Note: * indicates automation software version used in the compliance certification testing

** equipment was used before calibration due date.

*** equipment was used after calibration.

7. ON TIME, DUTY CYCLE AND MEASUREMENT METHODS

7.1. ON TIME AND DUTY CYCLE

LIMITS

None; for reporting purposes only.

PROCEDURE

KDB 789033 Zero-Span Spectrum Analyzer Method.

RESULTS

Mode	ON Time B (msec)	Period (msec)	Duty Cycle x (linear)	Duty Cycle (%)	Duty Cycle Correction Factor (dB)	1/B Minimum VBW (kHz)
802.11n HT20 1TX	1.911	1.929	0.991	99.07%	0.00	0.010
802.11n HT20 CDD 2TX	1.917	1.938	0.989	98.92%	0.00	0.010
802.11n HT20 CDD 3TX	2.290	2.311	0.991	99.09%	0.00	0.010
802.11n HT20 STBC/SDM 2TX	2.289	2.307	0.992	99.22%	0.00	0.010
802.11n HT20 STBC/SDM 3TX	2.286	2.314	0.988	98.79%	0.00	0.010
802.11n HT20 BF 2TX	1.996	2.544	0.785	78.47%	1.05	0.501
802.11n HT20 BF 3TX	1.993	2.338	0.853	85.26%	0.69	0.502
802.11n HT40 1TX	1.122	1.140	0.984	98.42%	0.00	0.010
802.11n HT40 CDD 2TX	1.124	1.140	0.986	98.60%	0.00	0.010
802.11n HT40 CDD 3TX	1.123	1.140	0.985	98.51%	0.00	0.010
802.11n HT40 STBC/SDM 2TX	1.128	1.146	0.984	98.43%	0.00	0.010
802.11n HT40 STBC/SDM 3TX	1.127	1.145	0.984	98.43%	0.00	0.010
802.11n HT40 BF 2TX	2.823	3.386	0.834	83.38%	0.79	0.354
802.11n HT40 BF 3TX	2.055	2.350	0.874	87.45%	0.58	0.487
802.11ac VHT80 1TX	0.942	0.962	0.979	97.92%	0.09	1.062
802.11ac VHT80 CDD 2TX	0.460	0.479	0.960	95.99%	0.18	2.175
802.11ac VHT80 CDD 3TX	0.460	0.479	0.960	96.03%	0.18	2.174
802.11ac VHT80 STBC/SDM 2TX	0.467	0.488	0.958	95.84%	0.18	2.140
802.11ac VHT80 STBC/SDM 3TX	0.467	0.487	0.959	95.89%	0.18	2.141
802.11ac VHT80 BF 2TX	2.620	3.090	0.848	84.79%	0.72	0.382
802.11ac VHT80 BF 3TX	2.275	2.625	0.867	86.67%	0.62	0.440

DUTY CYCLE PLOTS

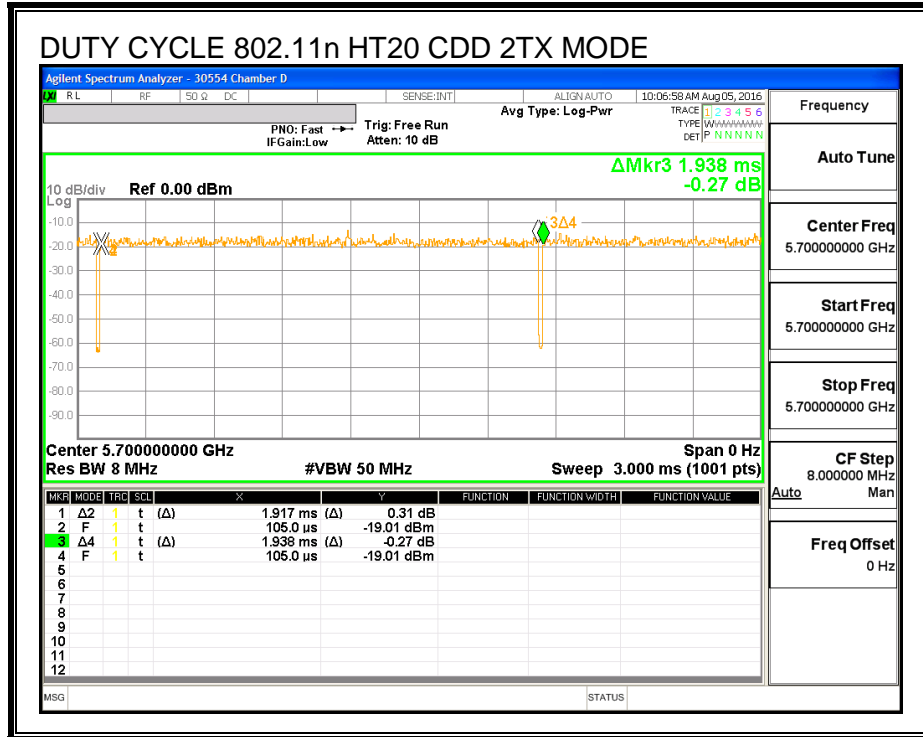
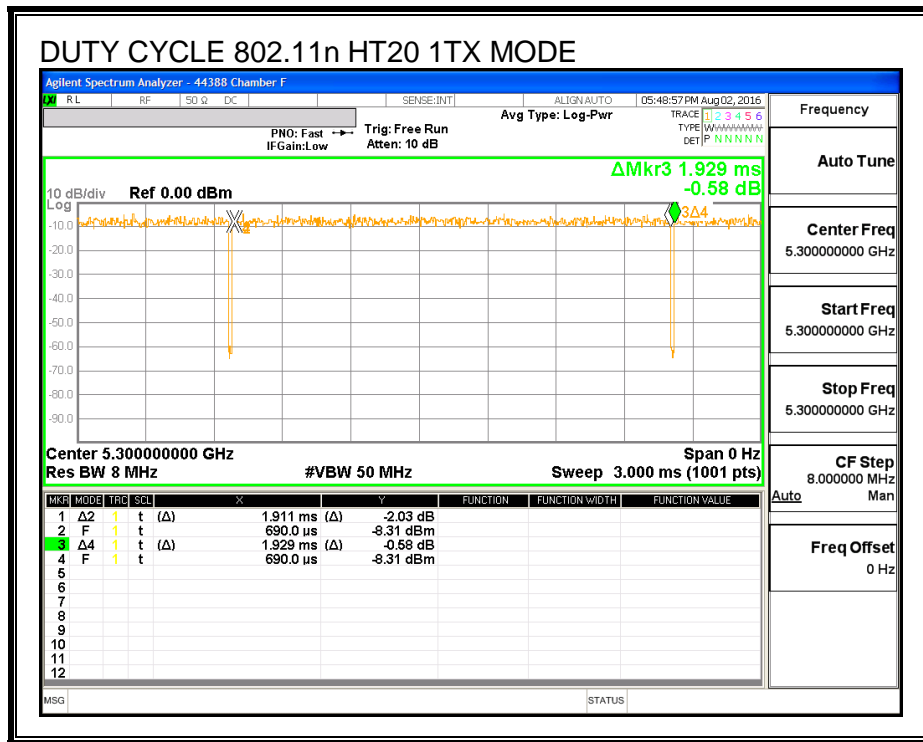

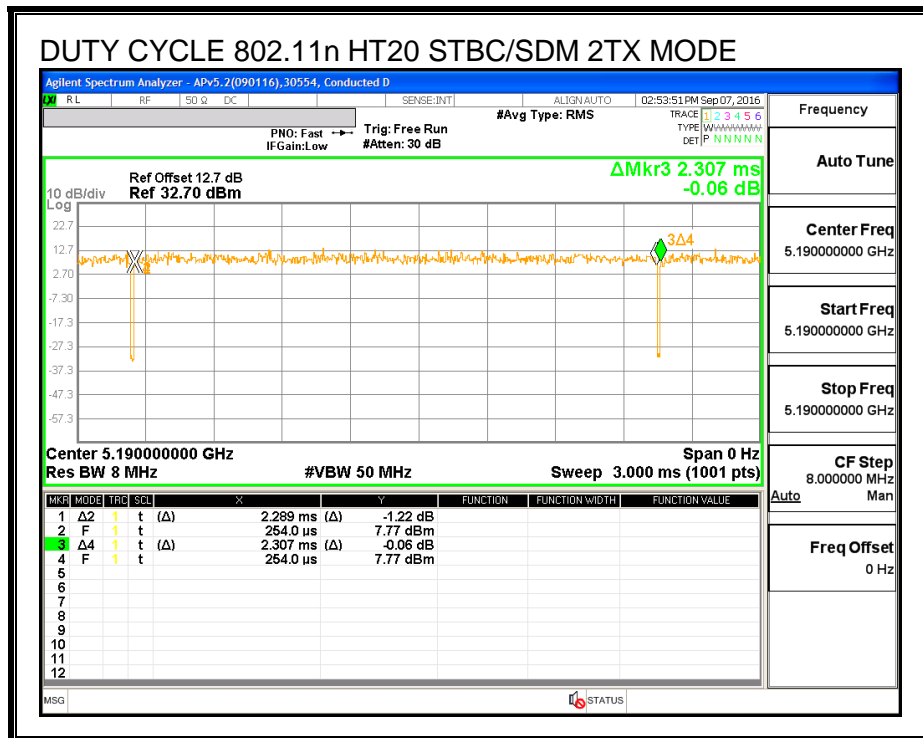
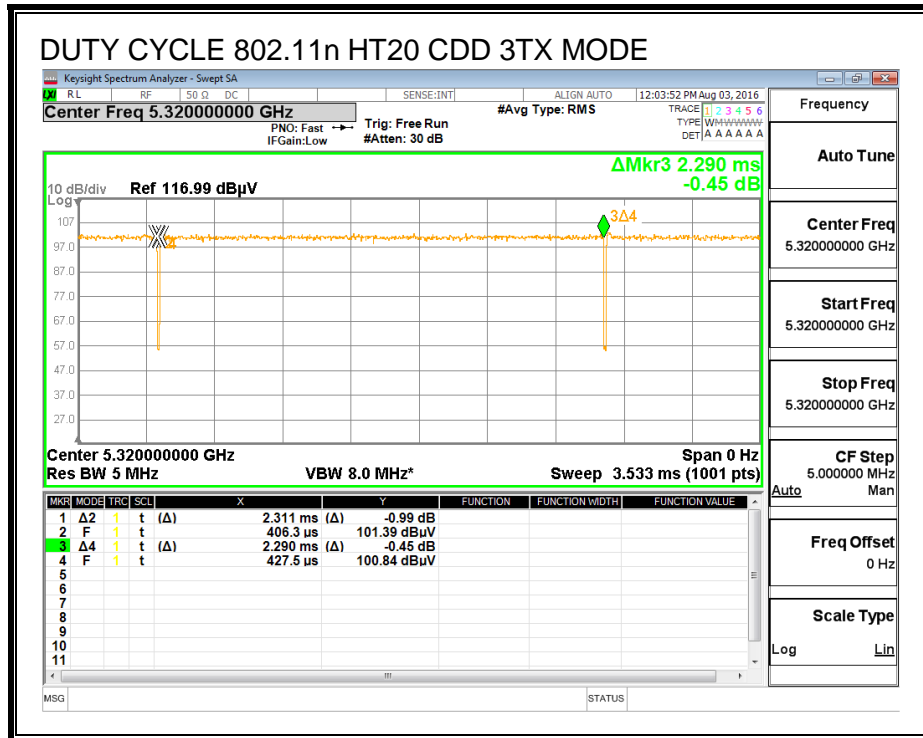

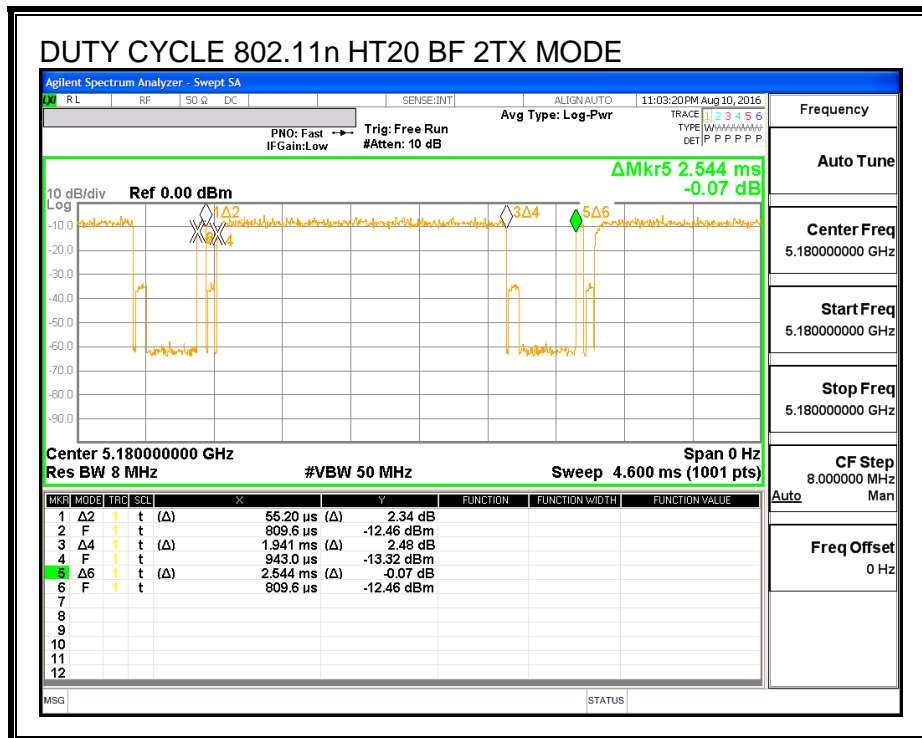
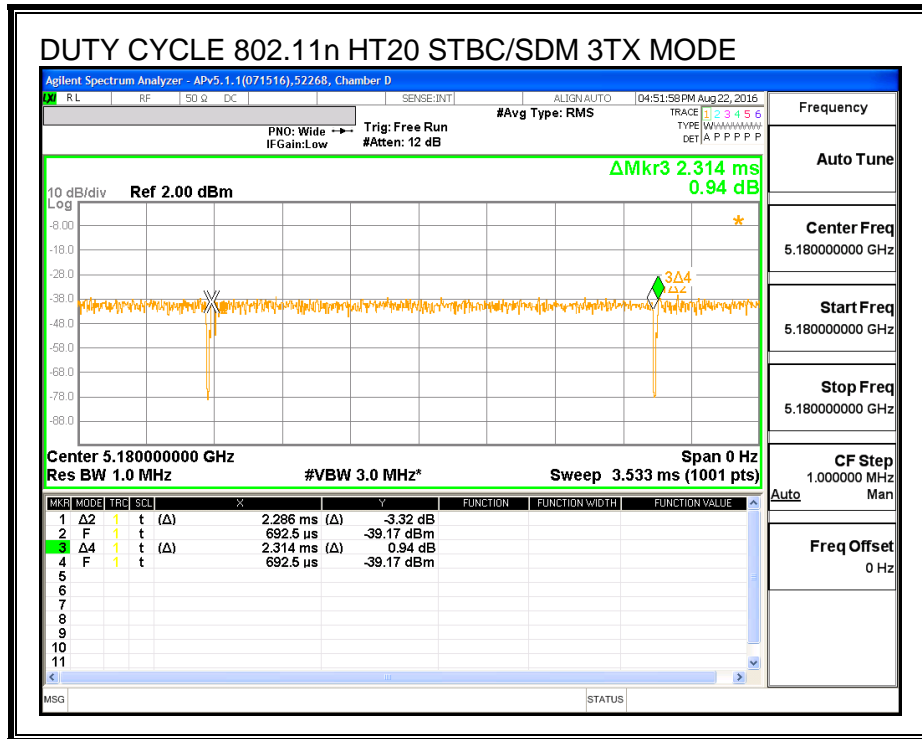

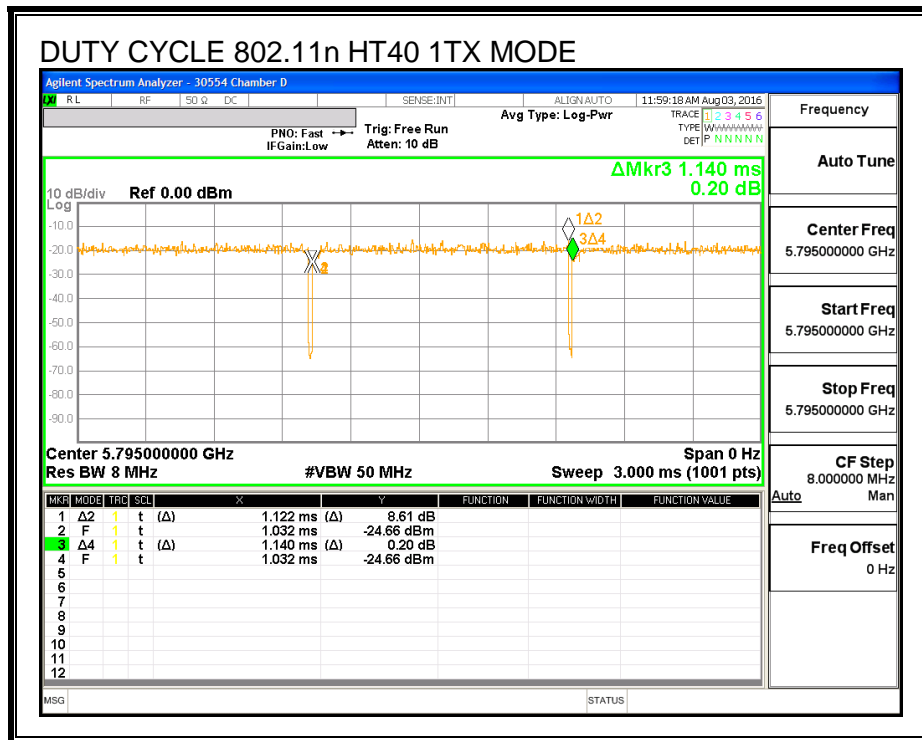
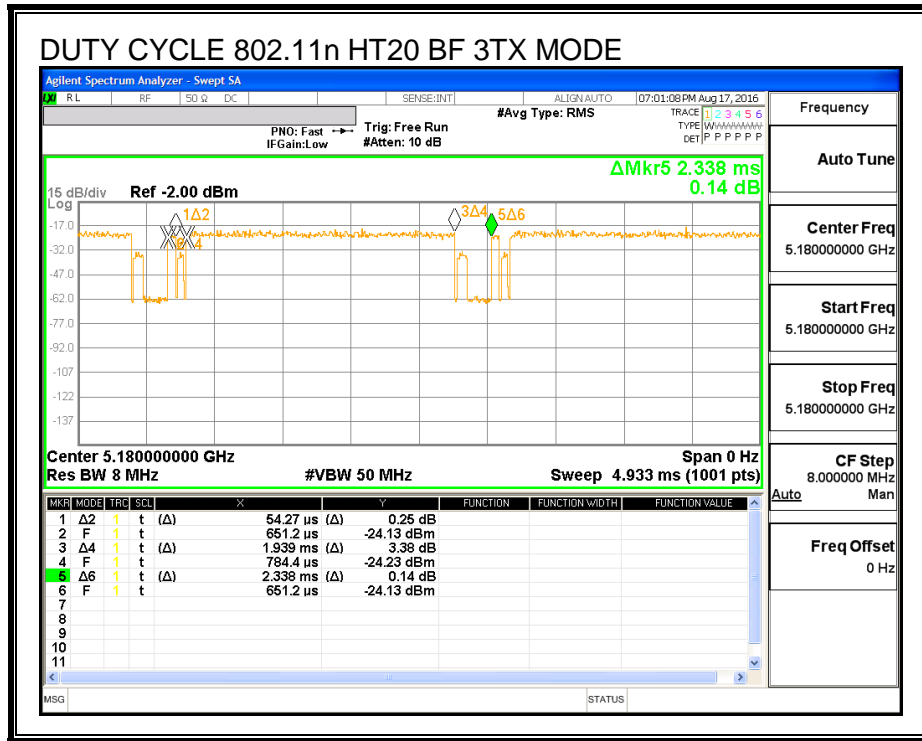

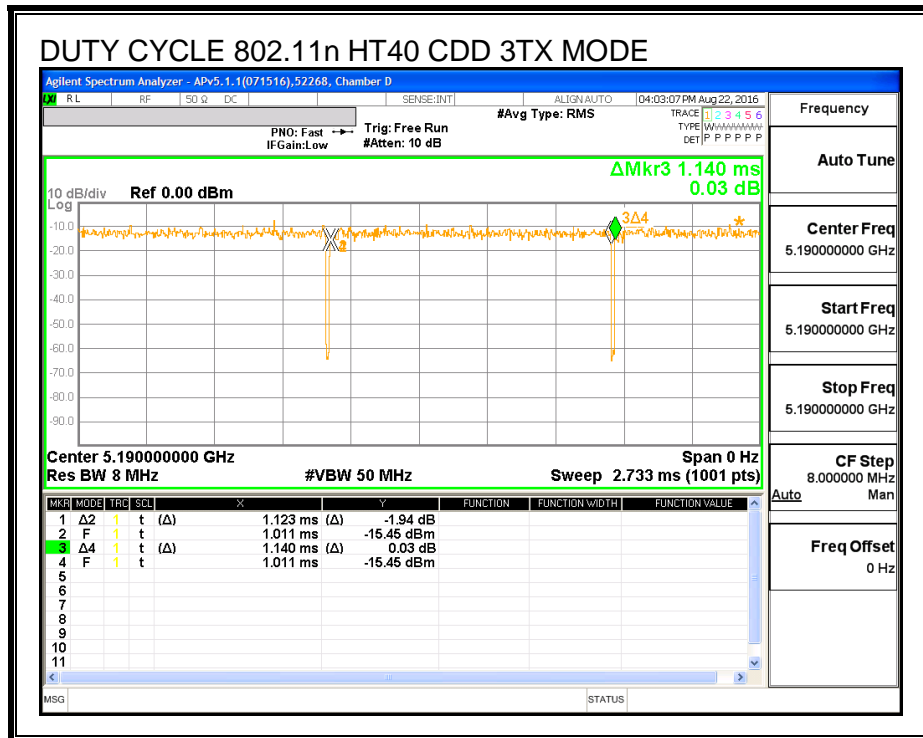
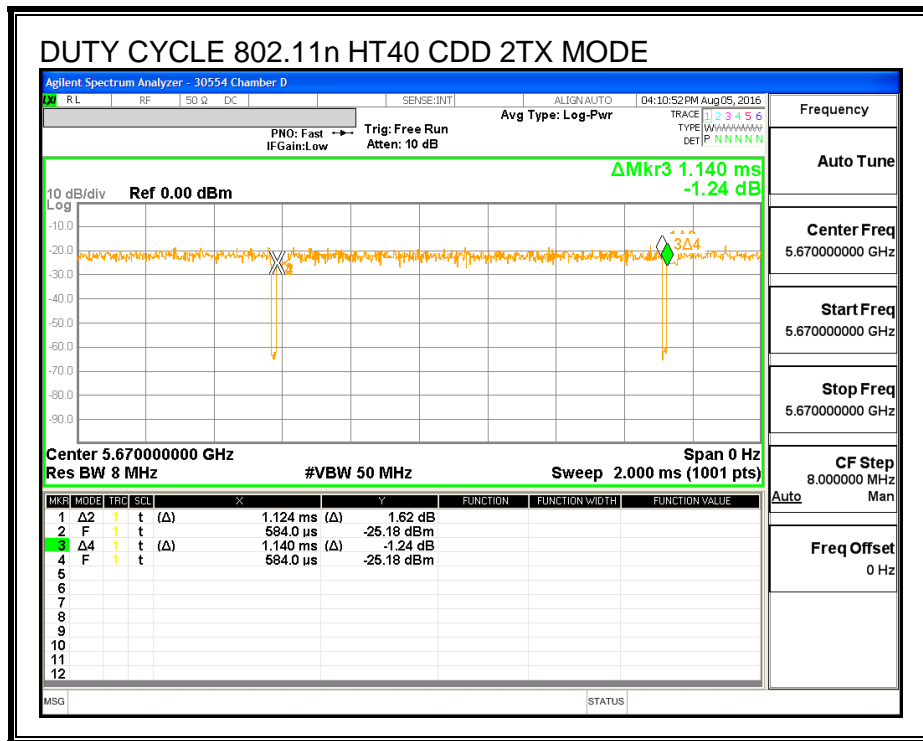

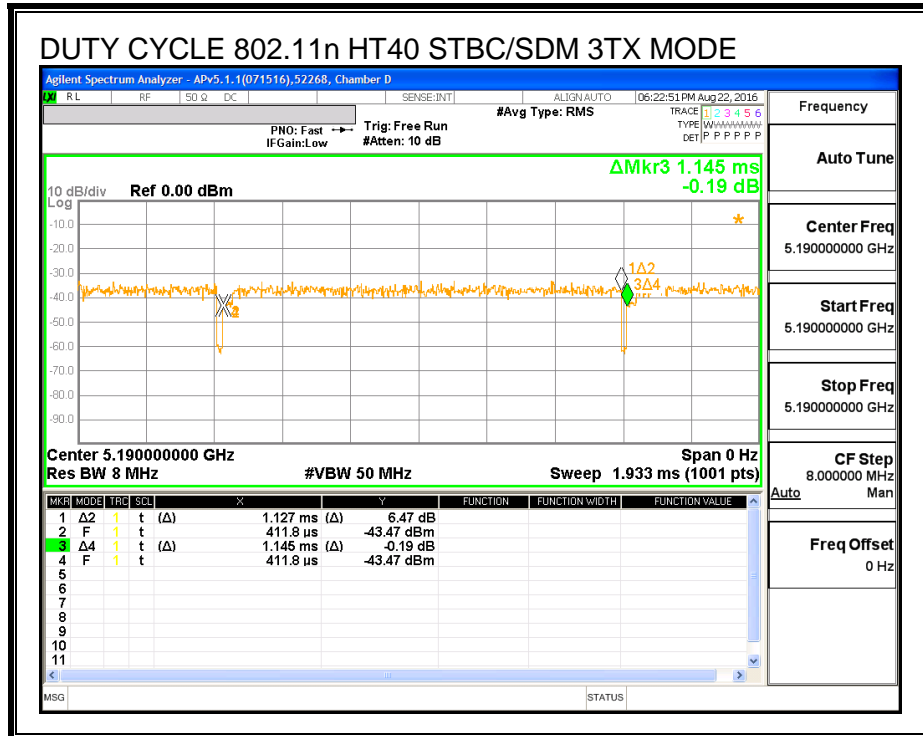
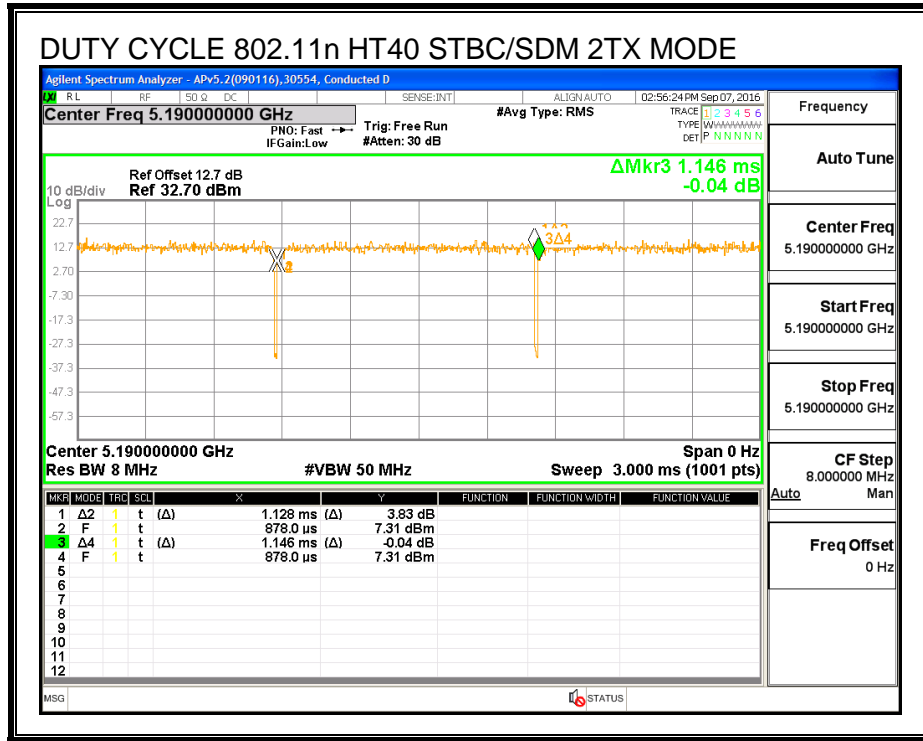

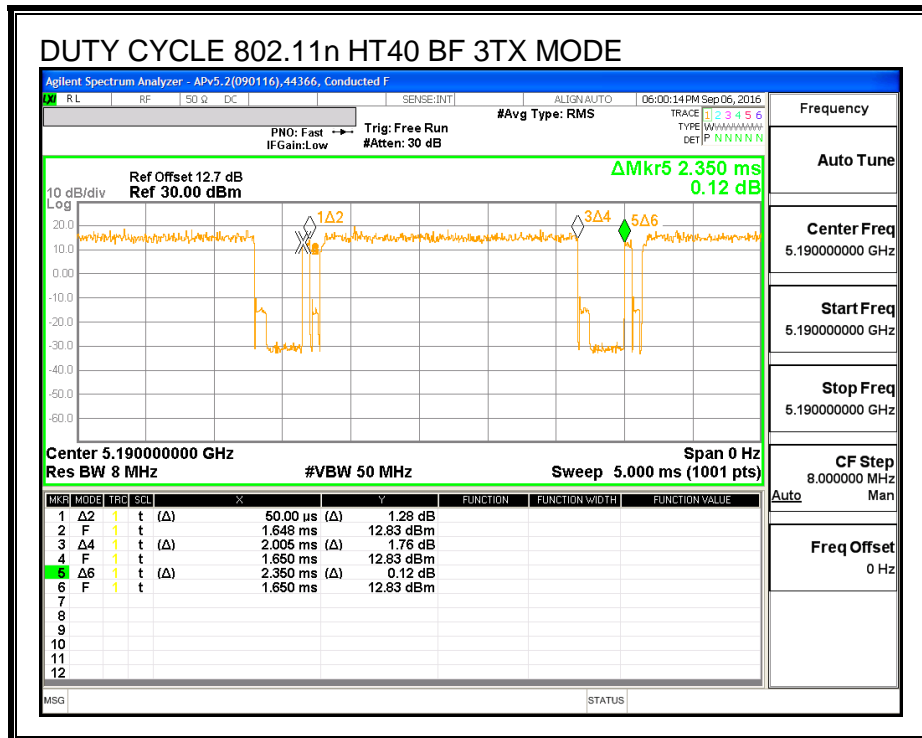
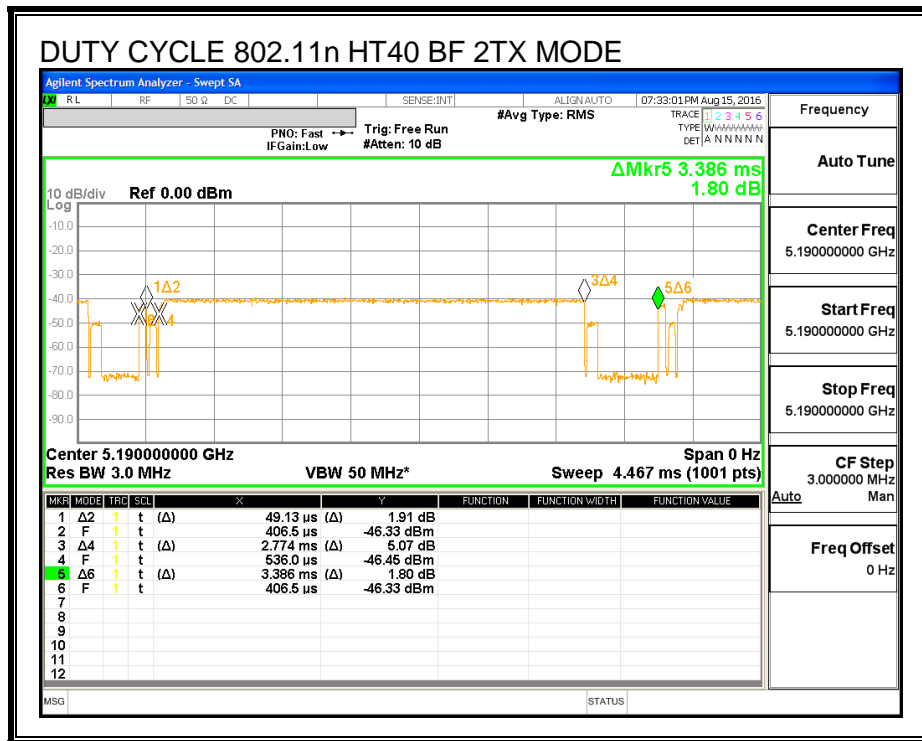

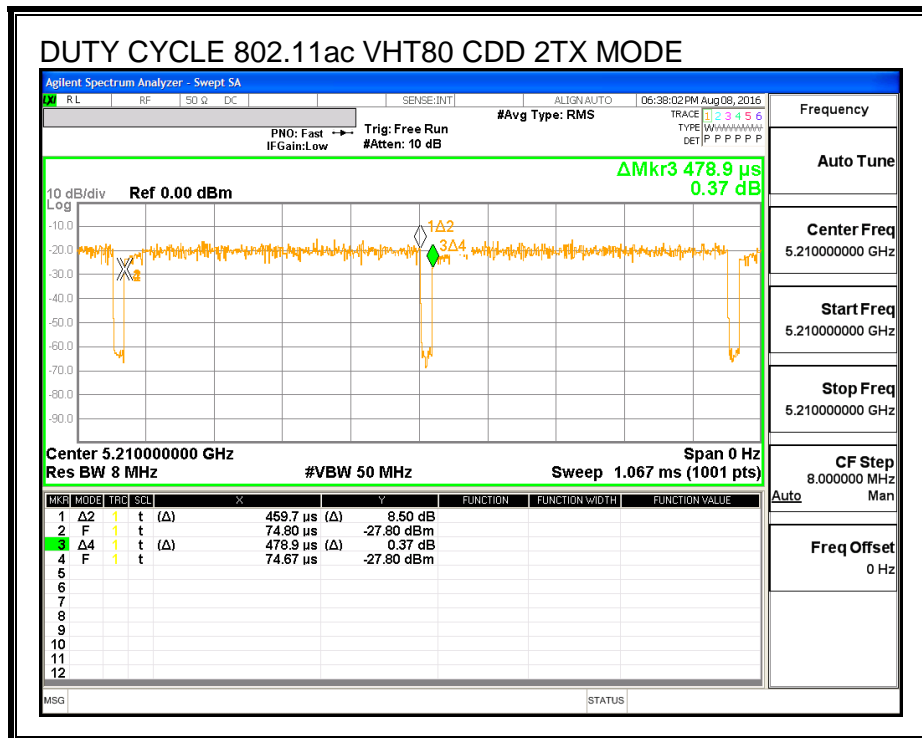
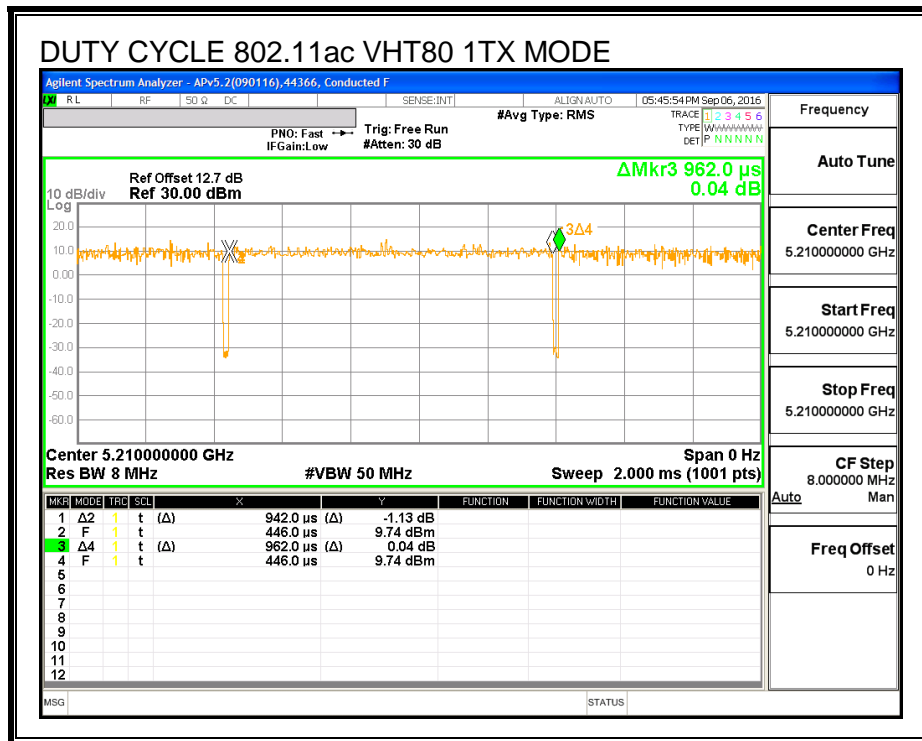

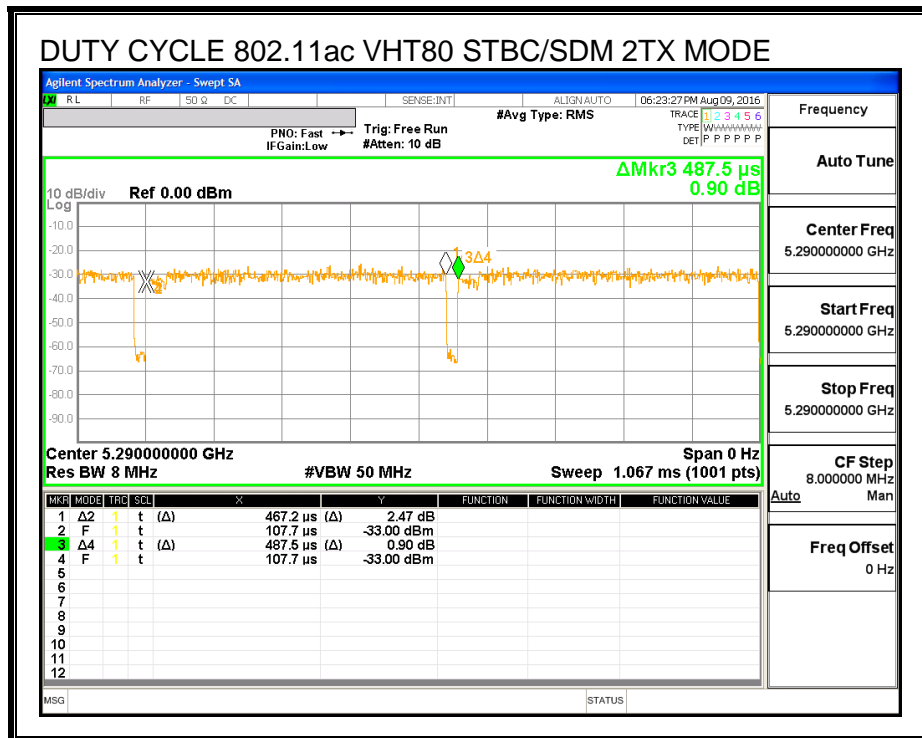
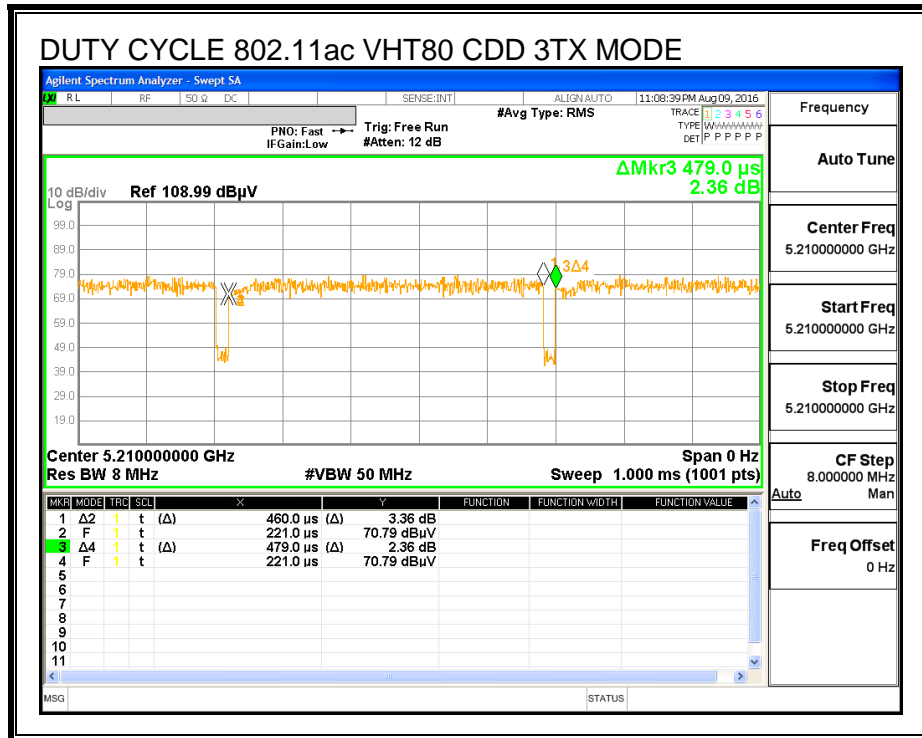

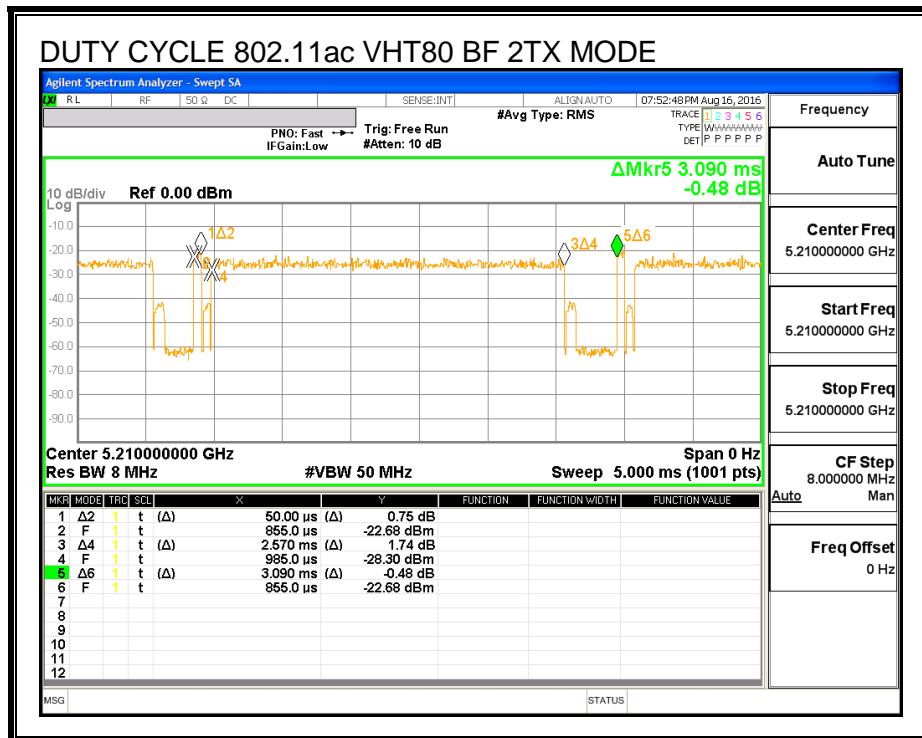
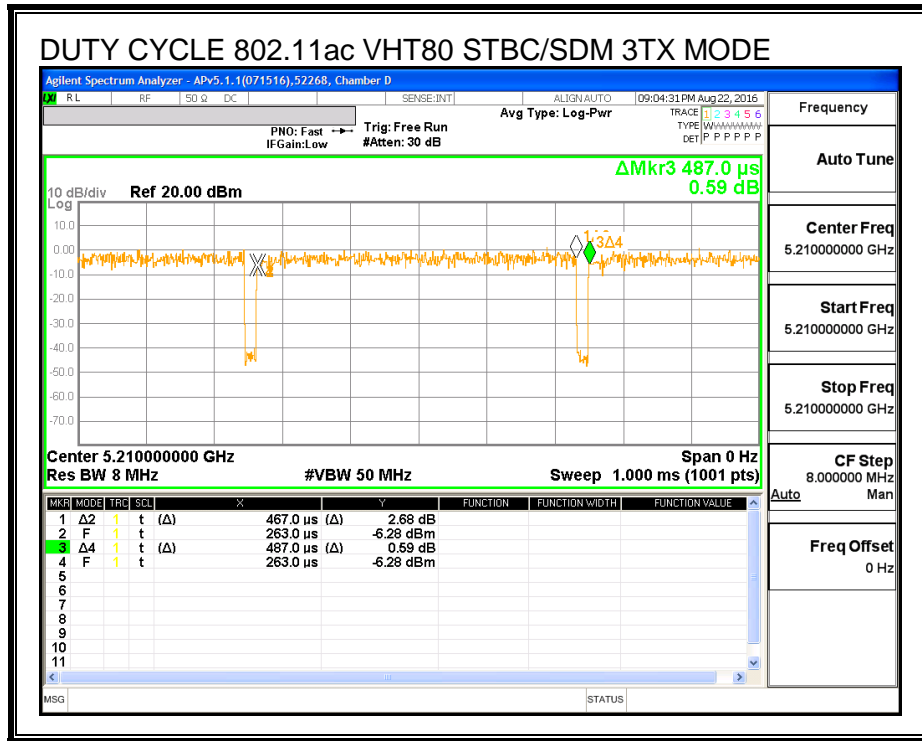

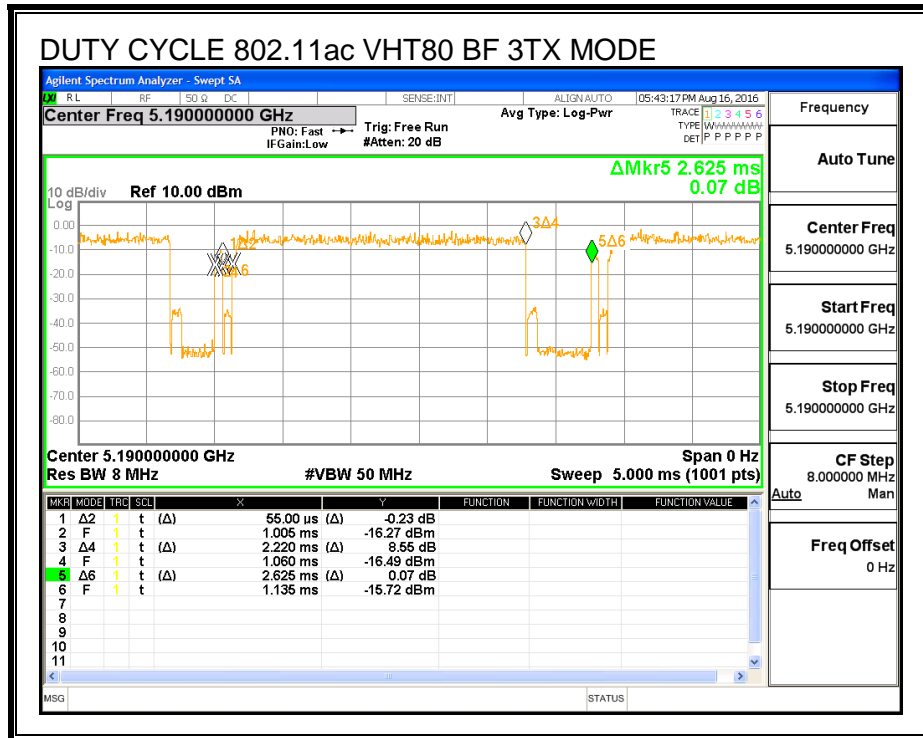

7.2. MEASUREMENT METHODS

6 dB Emission BW: KDB 789033 D02 v01r03, Section C.

26 dB Emission BW: KDB 789033 D02 v01r03, Section C.

99% Occupied BW: KDB 789033 D02 v01r03, Section D.

Conducted Output Power: KDB 789033 D02 v01r03, Section E.3.b (Method PM-G).

Power Spectral Density: KDB 789033 D02 v01r03, Section F (Method SA-2).

Unwanted emissions in restricted bands: KDB 789033 D02 v01r03, Sections G.3, G.4, G.5, and G.6.

Unwanted emissions in non-restricted bands: KDB 789033 D02 v01r03, Sections G.3, G.4, and G.5.

8. ANTENNA PORT TEST RESULTS

8.1. 802.11n HT20 CHAIN 0 MODE IN THE 5.2 GHz BAND

8.1.1. 26 dB BANDWIDTH

LIMITS

None; for reporting purposes only.

RESULTS

Channel	Frequency (MHz)	26 dB Bandwidth (MHz)
Low	5180	22.338
Mid	5200	22.270
High	5240	22.820

26 dB BANDWIDTH

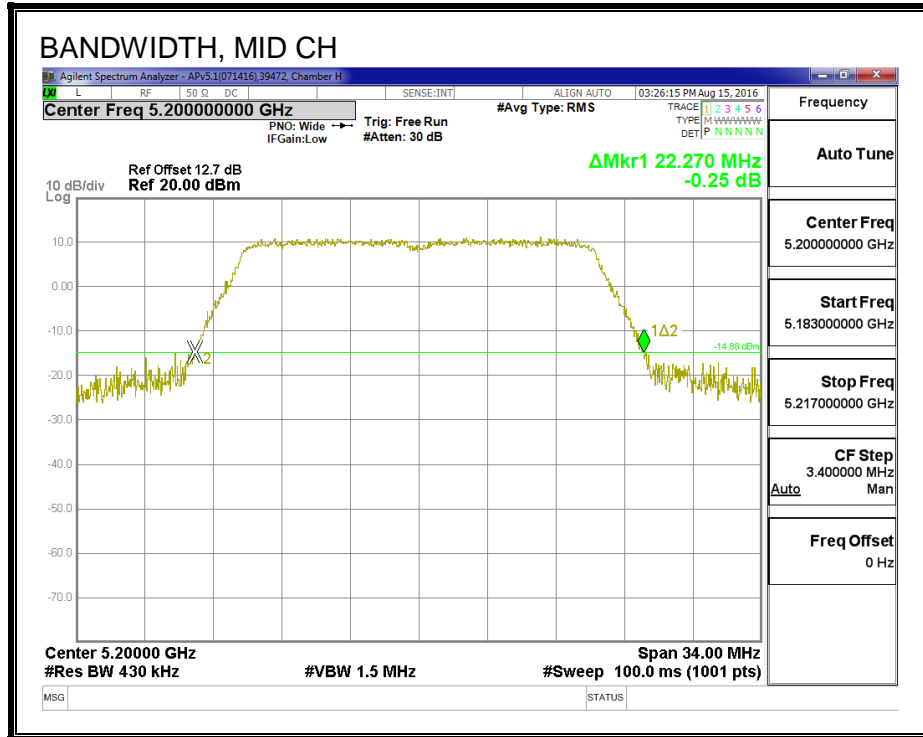
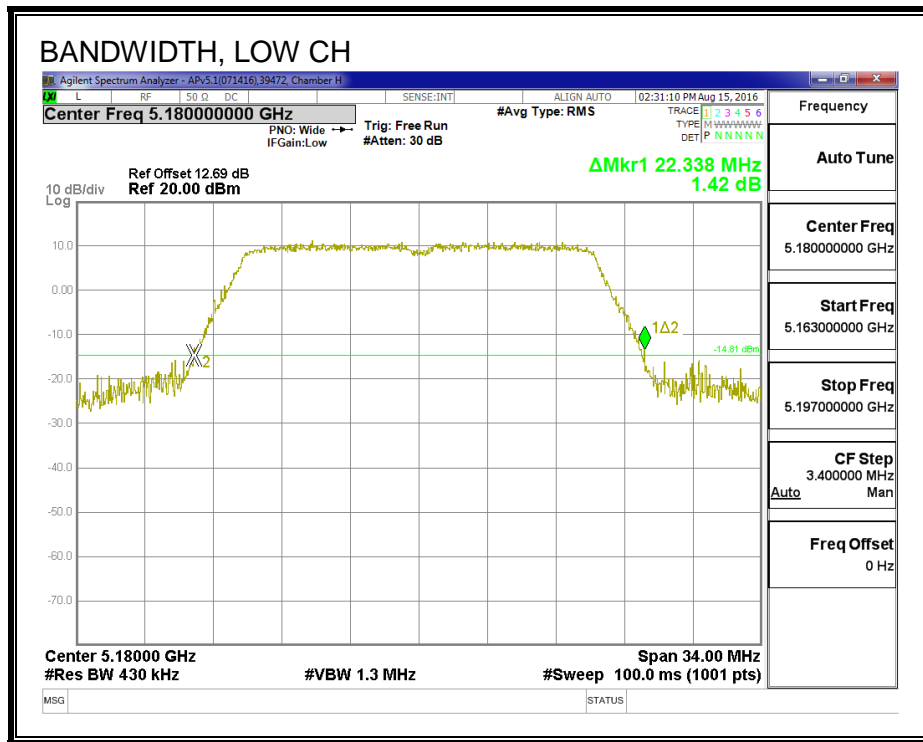

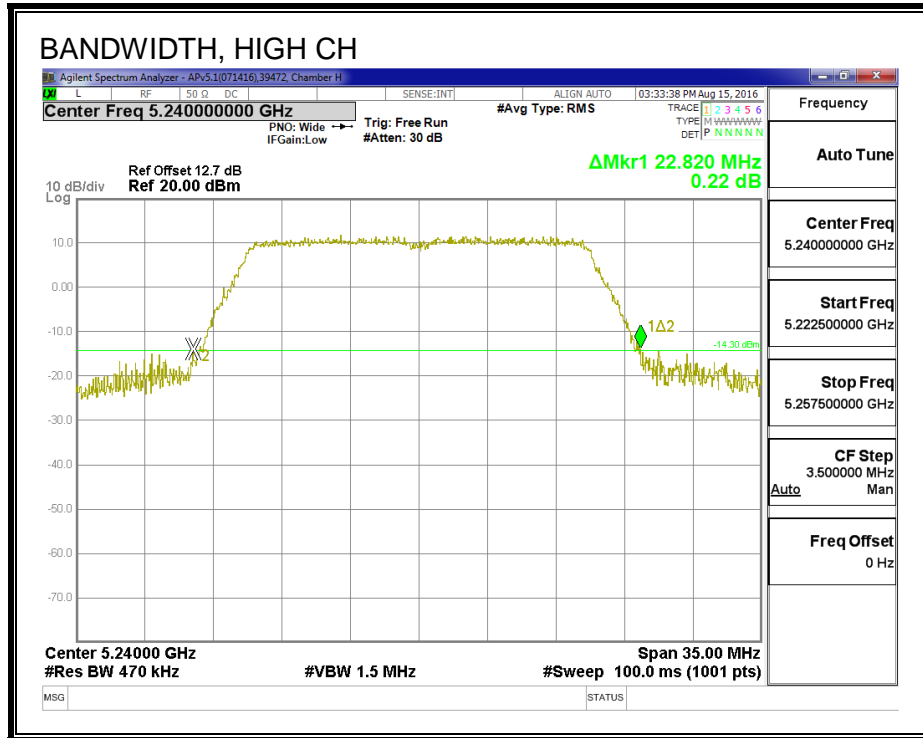

8.1.2. 99% BANDWIDTH

LIMITS

None; for reporting purposes only.

RESULTS

Channel	Frequency (MHz)	99% BW (MHz)
Low	5180	17.861
Mid	5200	17.900
High	5240	17.912

99% BANDWIDTH

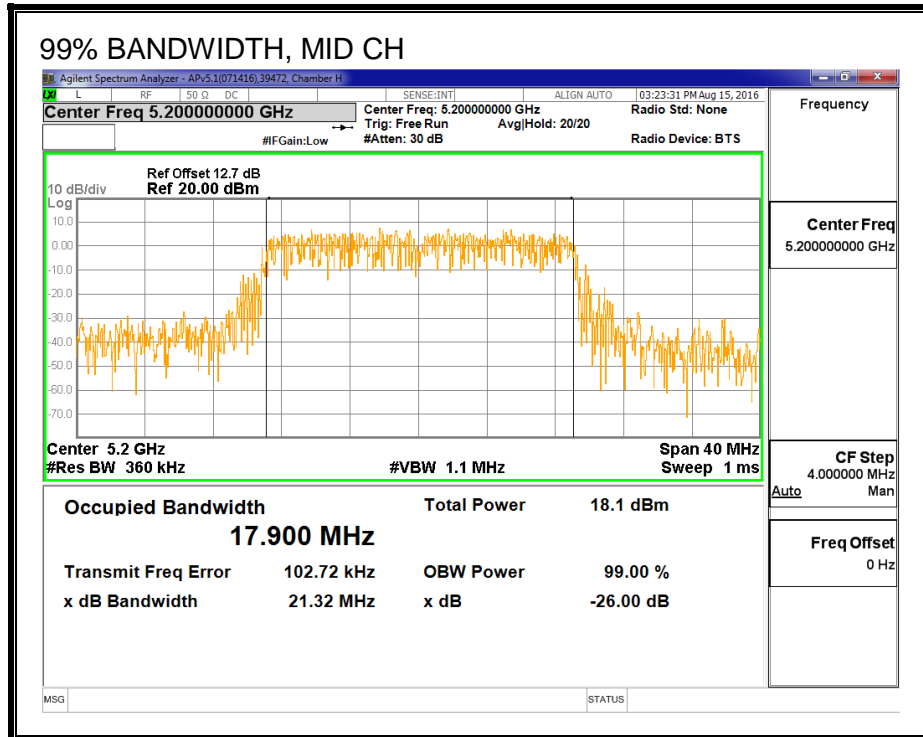
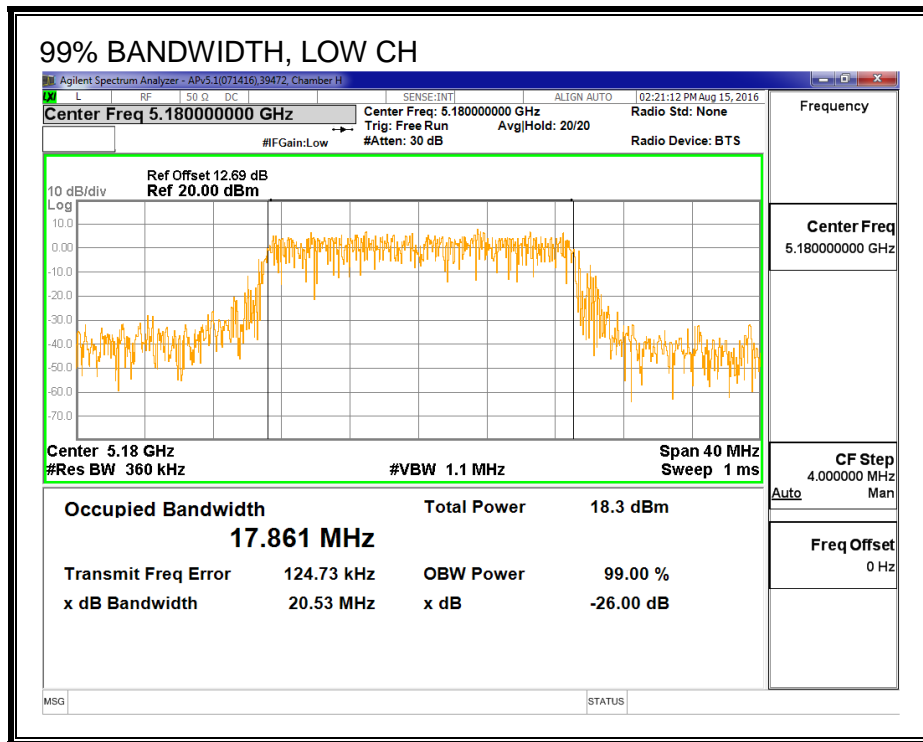

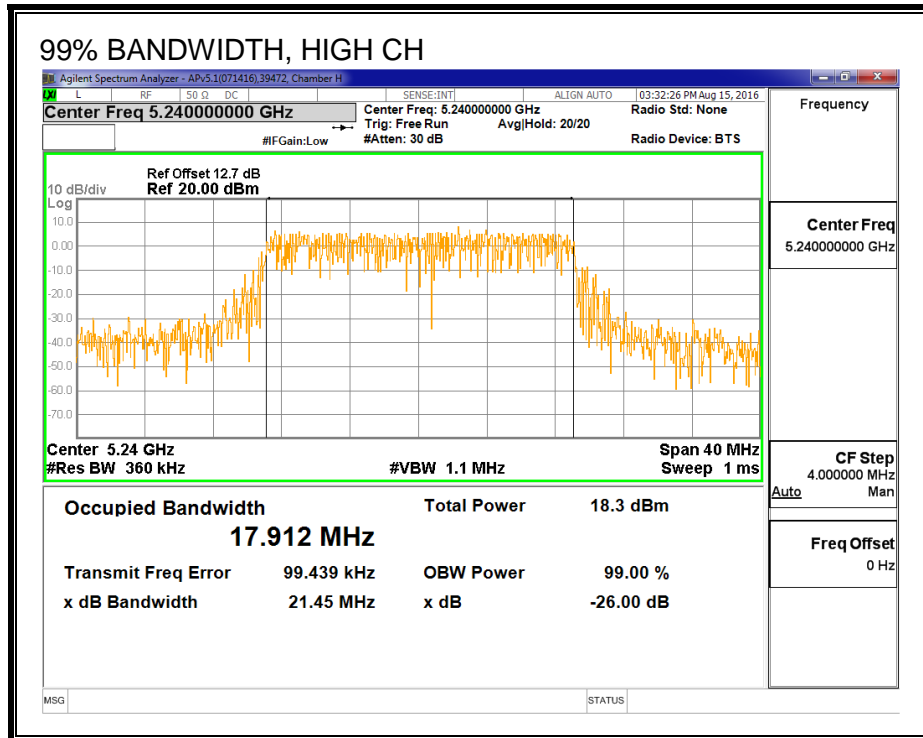

8.1.3. AVERAGE POWER (FCC)

LIMITS

None; for reporting purposes only.

TEST PROCEDURE

Measurements perform using a wideband gated RF power meter.

RESULTS

ID:	30554	Date:	9/12/16
------------	-------	--------------	---------

Channel	Frequency (MHz)	Power (dBm)
Low	5180	13.15
Mid	5200	13.23
High	5240	13.22

8.1.4. OUTPUT POWER AND PSD (FCC)

LIMITS

FCC §15.407 (a) (1)

(i) For an outdoor access point operating in the band 5.15-5.25 GHz, the maximum conducted output power over the frequency band of operation shall not exceed 1 W provided the maximum antenna gain does not exceed 6 dBi. In addition, the maximum power spectral density shall not exceed 17 dBm in any 1 megahertz band. If transmitting antennas of directional gain greater than 6 dBi are used, both the maximum conducted output power and the maximum power spectral density shall be reduced by the amount in dB that the directional gain of the antenna exceeds 6 dBi. The maximum e.i.r.p. at any elevation angle above 30 degrees as measured from the horizon must not exceed 125 mW (21 dBm).

(ii) For an indoor access point operating in the band 5.15-5.25 GHz, the maximum conducted output power over the frequency band of operation shall not exceed 1 W provided the maximum antenna gain does not exceed 6 dBi. In addition, the maximum power spectral density shall not exceed 17 dBm in any 1 megahertz band. If transmitting antennas of directional gain greater than 6 dBi are used, both the maximum conducted output power and the maximum power spectral density shall be reduced by the amount in dB that the directional gain of the antenna exceeds 6 dBi.

(iii) For fixed point-to-point access points operating in the band 5.15-5.25 GHz, the maximum conducted output power over the frequency band of operation shall not exceed 1 W. Fixed point-to-point U-NII devices may employ antennas with directional gain up to 23 dBi without any corresponding reduction in the maximum conducted output power or maximum power spectral density. For fixed point-to-point transmitters that employ a directional antenna gain greater than 23 dBi, a 1 dB reduction in maximum conducted output power and maximum power spectral density is required for each 1 dB of antenna gain in excess of 23 dBi. Fixed, point-to-point operations exclude the use of point-to-multipoint systems, omnidirectional applications, and multiple collocated transmitters transmitting the same information. The operator of the U-NII device, or if the equipment is professionally installed, the installer, is responsible for ensuring that systems employing high gain directional antennas are used exclusively for fixed, point-to-point operations.

(iv) For mobile and portable client devices in the 5.15-5.25 GHz band, the maximum conducted output power over the frequency band of operation shall not exceed 250 mW provided the maximum antenna gain does not exceed 6 dBi. In addition, the maximum power spectral density shall not exceed 11 dBm in any 1 megahertz band. If transmitting antennas of directional gain greater than 6 dBi are used, both the maximum conducted output power and the maximum power spectral density shall be reduced by the amount in dB that the directional gain of the antenna exceeds 6 dBi.

TEST PROCEDURE

Measurements perform using a wideband gated RF power meter provided that the gate parameters are adjusted such that the power is measured only when the EUT is transmitting at its maximum power control level. Since the measurement is made only during the ON time of the transmitter, no duty cycle correction factor is required.

DIRECTIONAL ANTENNA GAIN

There is only one transmitter output therefore the directional gain is equal to the antenna gain.

RESULTS

ID:	30554	Date:	9/12/16
------------	-------	--------------	---------

Antenna Gain and Limits

Channel	Frequency (MHz)	Directional Gain for Power (dBi)	Directional Gain for PSD (dBi)	Power Limit (dBm)	PSD Limit (dBm)
Low	5180	3.80	3.80	24.00	11.00
Mid	5200	3.80	3.80	24.00	11.00
High	5240	3.80	3.80	24.00	11.00

Duty Cycle CF (dB)	0.00	Included in Calculations of Corr'd PSD
---------------------------	------	---

Output Power Results

Channel	Frequency (MHz)	Chain 0 Meas Power (dBm)	Total Corr'd Power (dBm)	Power Limit (dBm)	Power Margin (dB)
Low	5180	13.15	13.15	24.00	-10.85
Mid	5200	13.23	13.23	24.00	-10.77
High	5240	13.22	13.22	24.00	-10.78

PSD Results

Channel	Frequency (MHz)	Chain 0 Meas PSD (dBm)	Total Corr'd PSD (dBm)	PSD Limit (dBm)	PSD Margin (dB)
Low	5180	1.67	1.67	11.00	-9.33
Mid	5200	1.51	1.51	11.00	-9.49
High	5240	1.39	1.39	11.00	-9.61

PSD

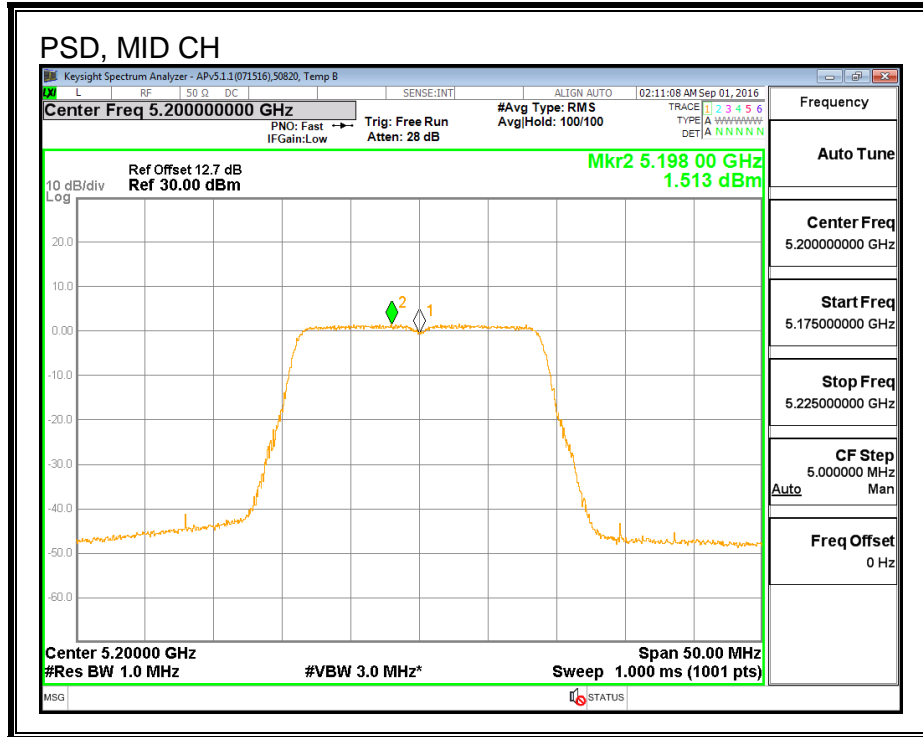
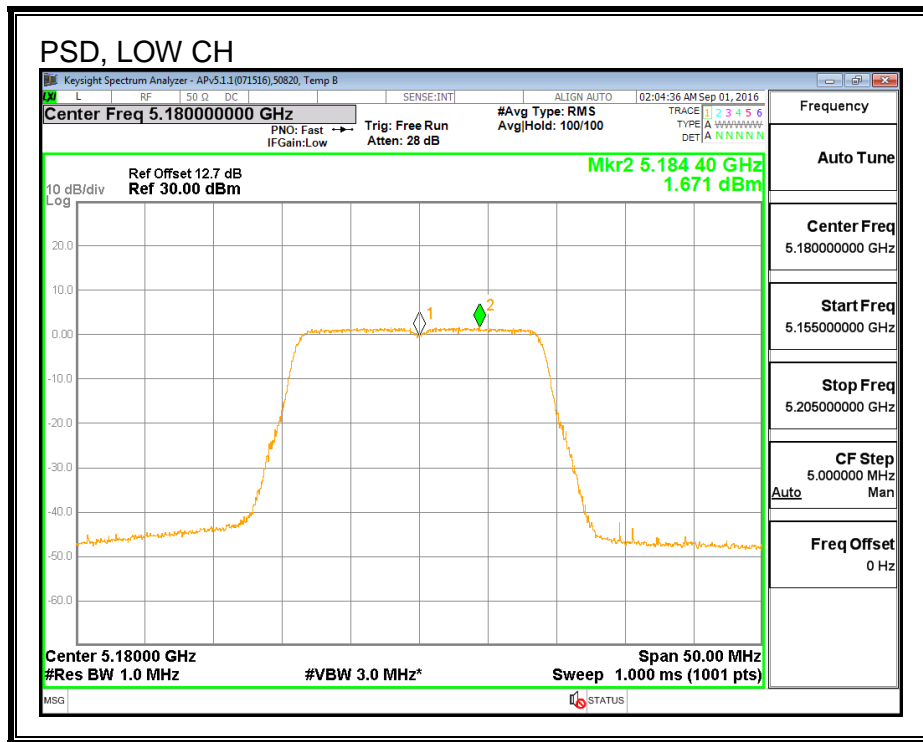

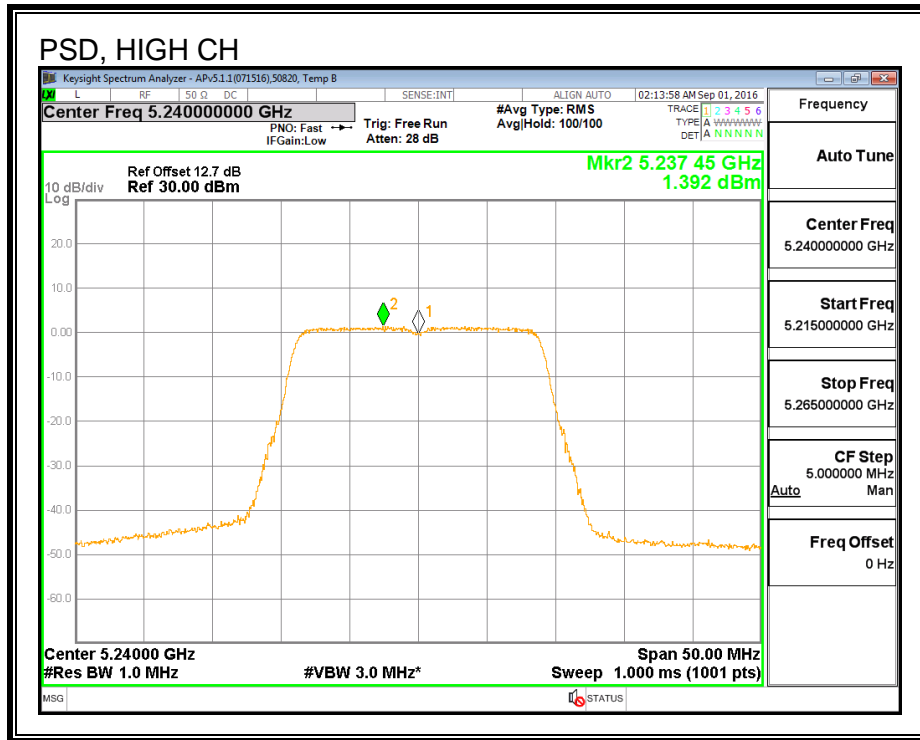

8.1.5. AVERAGE POWER (IC)

LIMITS

None; for reporting purposes only.

TEST PROCEDURE

Measurements perform using a wideband gated RF power meter.

RESULTS

ID:	50820	Date:	9/15/16
------------	-------	--------------	---------

Channel	Frequency (MHz)	Power (dBm)
Low	5180	10.97
Mid	5200	10.98
High	5240	10.91

8.1.6. OUTPUT POWER AND PSD (IC)

LIMITS

IC RSS-247 (6.2.1) (1)

The maximum e.i.r.p. shall not exceed 200 mW or $10 + 10 \log_{10} B$, dBm, whichever power is less. B is the 99% emission bandwidth in MHz. The e.i.r.p. spectral density shall not exceed 10 dBm in any 1.0 MHz band.

TEST PROCEDURE

Measurements perform using a wideband gated RF power meter provided that the gate parameters are adjusted such that the power is measured only when the EUT is transmitting at its maximum power control level. Since the measurement is made only during the ON time of the transmitter, no duty cycle correction factor is required.

DIRECTIONAL ANTENNA GAIN

There is only one transmitter output therefore the directional gain is equal to the antenna gain.

RESULTS

ID:	50820	Date:	9/15/16
------------	-------	--------------	---------

Bandwidth and Antenna Gain

Channel	Frequency (MHz)	Min 99% BW (MHz)	Direction Gain (dBi)
Low	5180	17.861	3.80
Mid	5200	17.900	3.80
High	5240	17.912	3.80

Limits

Channel	Frequency (MHz)	IC EIRP Limit (dBm)	Max IC Power (dBm)	IC eirp PSD Limit (dBm)	Max IC PSD (dBm)
Low	5180	22.52	18.72	10.00	6.20
Mid	5200	22.53	18.73	10.00	6.20
High	5240	22.53	18.73	10.00	6.20

Duty Cycle CF (dB)	0.00	Included in Calculations of Corr'd PSD
---------------------------	------	---

Output Power Results

Channel	Frequency (MHz)	Chain 0 Meas Power (dBm)	Total Corr'd Power (dBm)	Power Limit (dBm)	Power Margin (dB)
Low	5180	10.97	10.97	18.72	-7.75
Mid	5200	10.98	10.98	18.73	-7.75
High	5240	10.91	10.91	18.73	-7.82

PSD Results

Channel	Frequency (MHz)	Chain 0 Meas PSD (dBm)	Total Corr'd PSD (dBm)	PSD Limit (dBm)	PSD Margin (dB)
Low	5180	-0.32	-0.32	6.20	-6.52
Mid	5200	-0.56	-0.56	6.20	-6.76
High	5240	-0.56	-0.56	6.20	-6.76

PSD

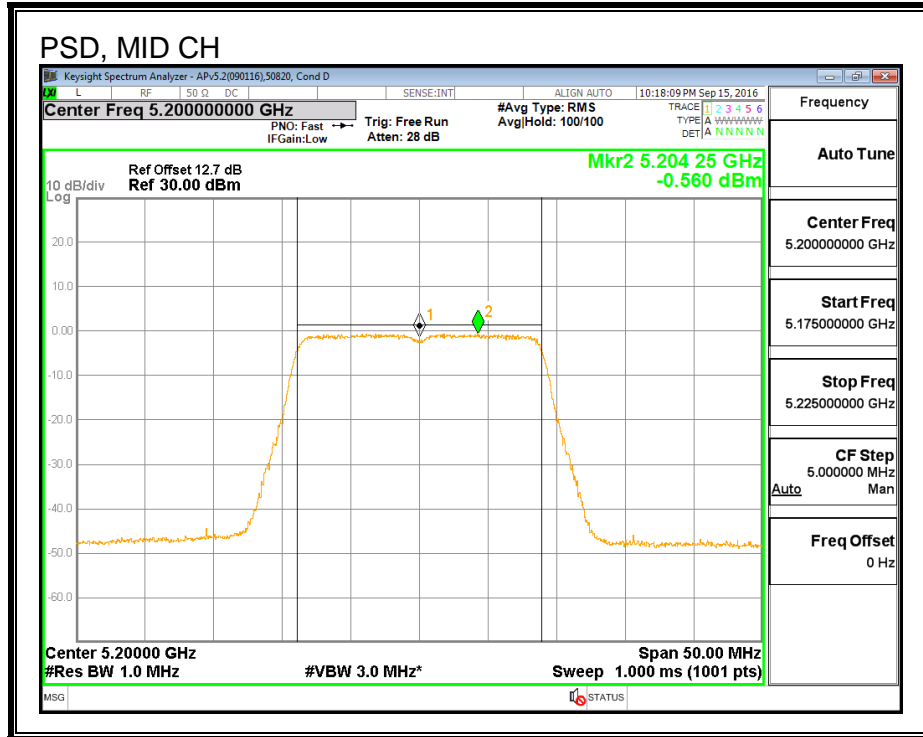
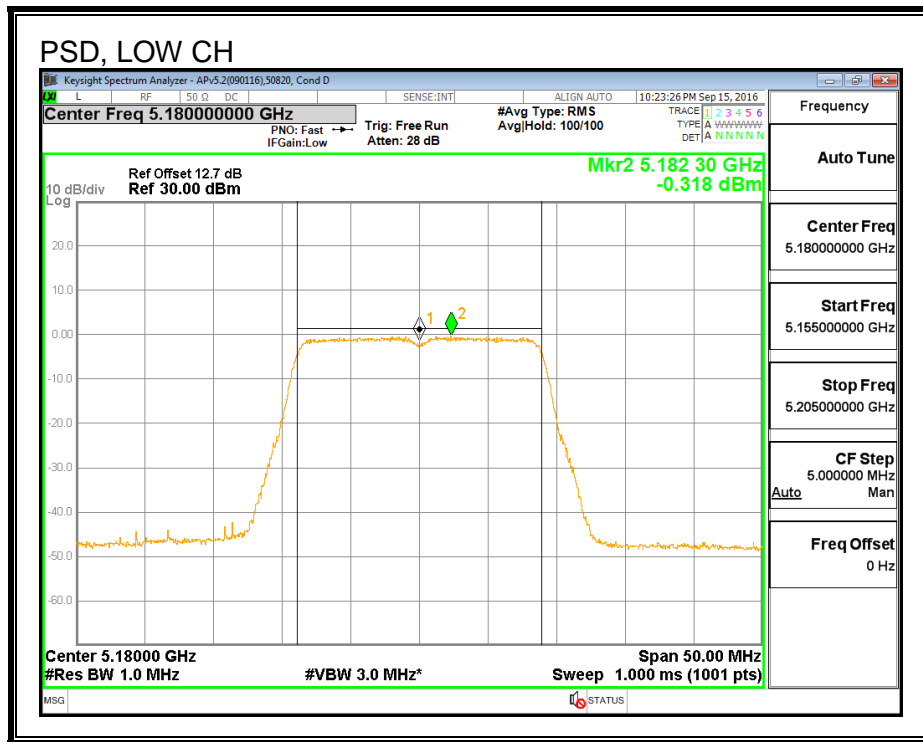

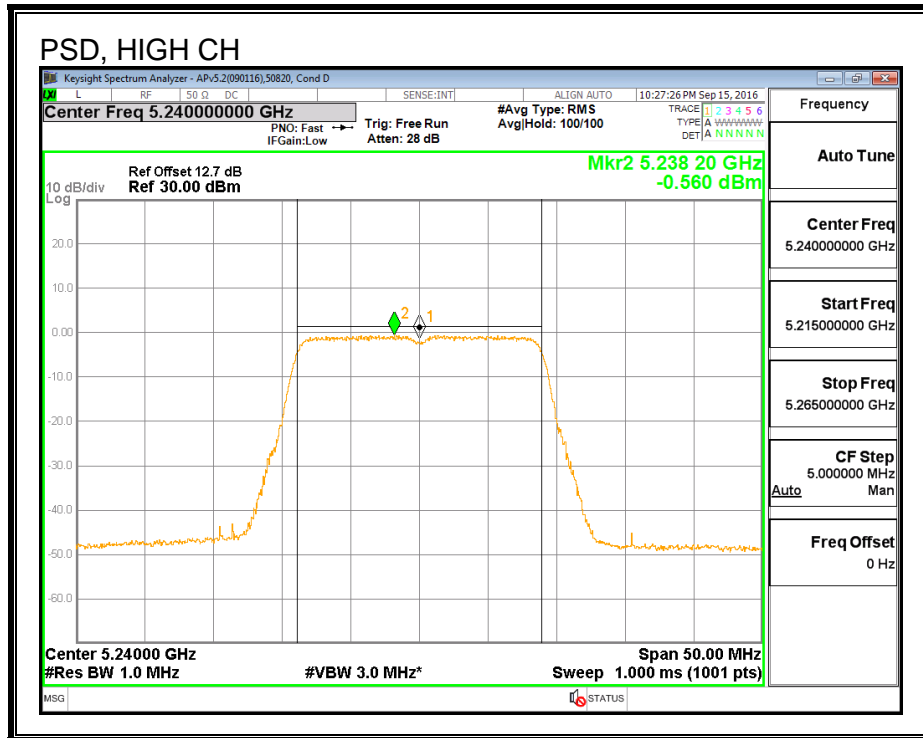

8.2. 802.11n HT20 CHAIN 1 MODE IN THE 5.2 GHz BAND

8.2.1. 26 dB BANDWIDTH

LIMITS

None; for reporting purposes only.

RESULTS

Channel	Frequency (MHz)	26 dB Bandwidth (MHz)
Low	5180	21.912
Mid	5200	21.879
High	5240	21.978

26 dB BANDWIDTH

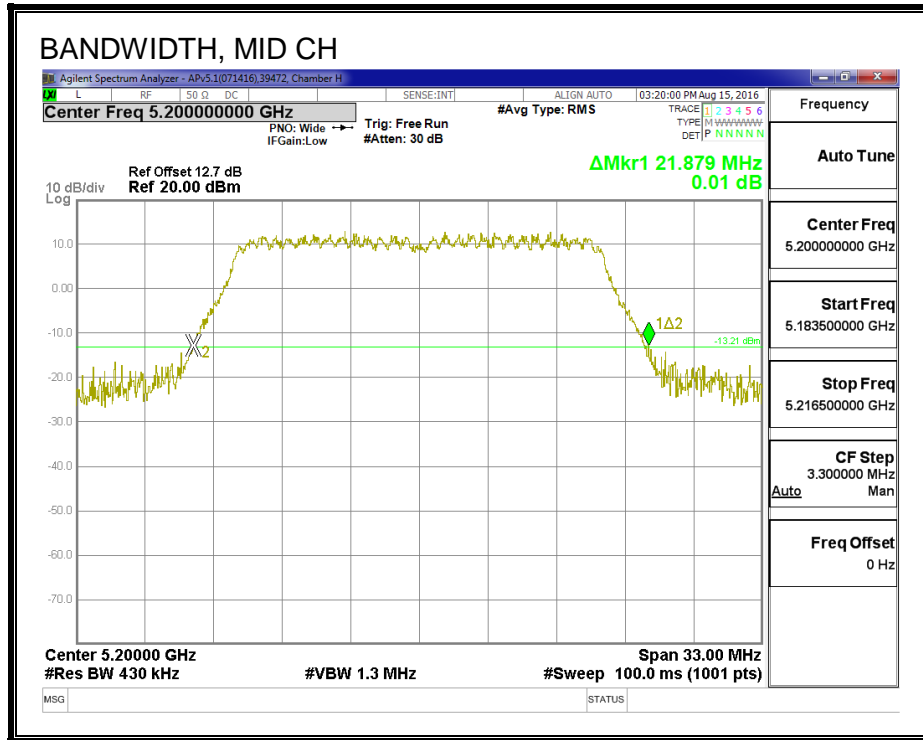
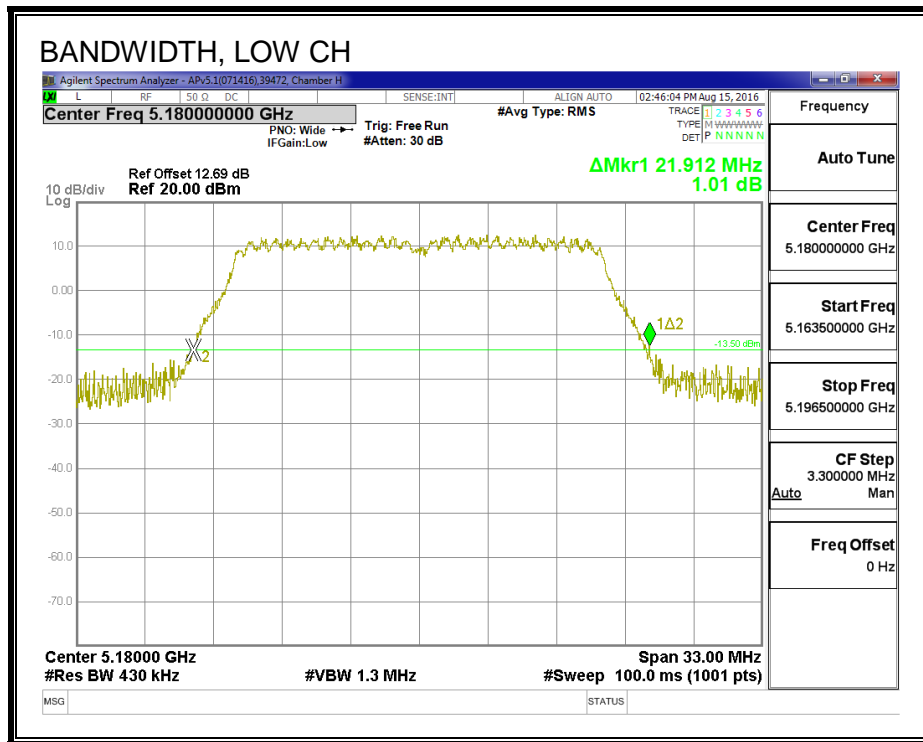

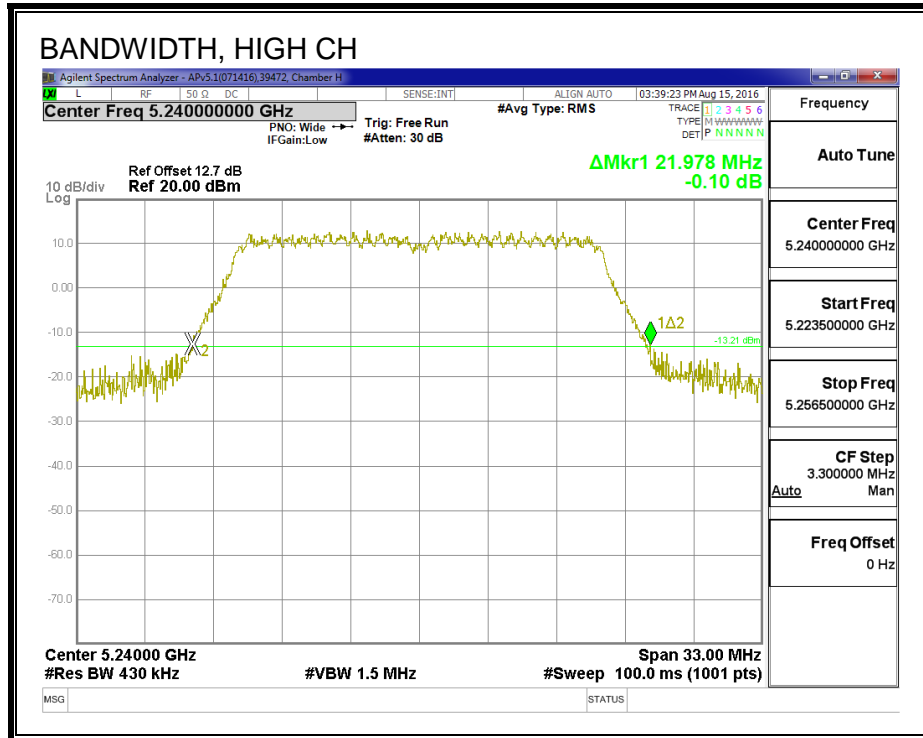

8.2.2. 99% BANDWIDTH

LIMITS

None; for reporting purposes only.

RESULTS

Channel	Frequency (MHz)	99% BW (MHz)
Low	5180	17.838
Mid	5200	17.763
High	5240	17.686

99% BANDWIDTH

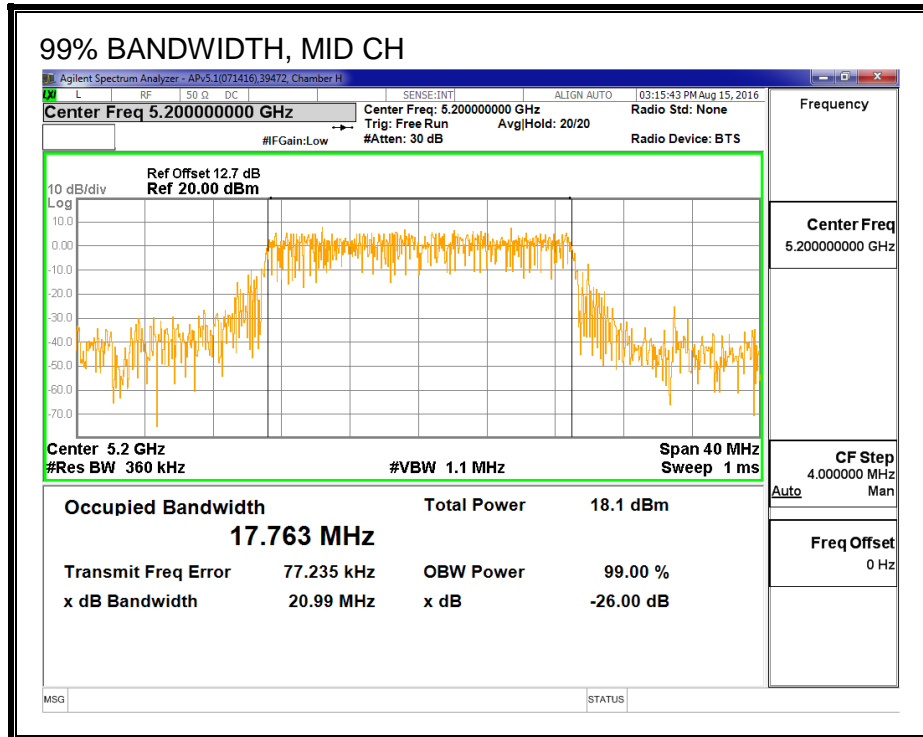
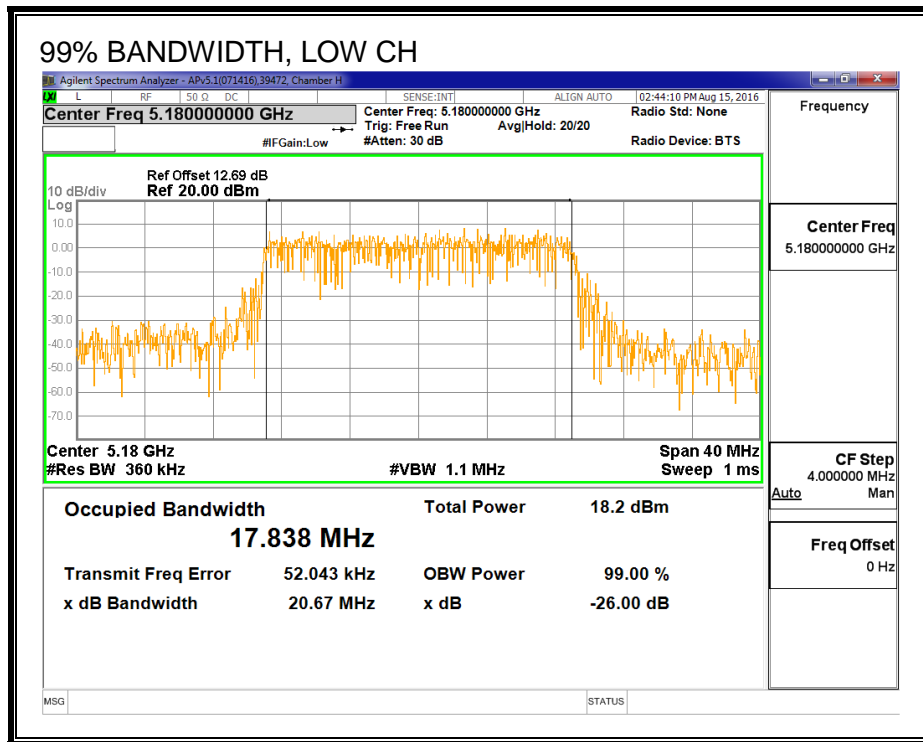

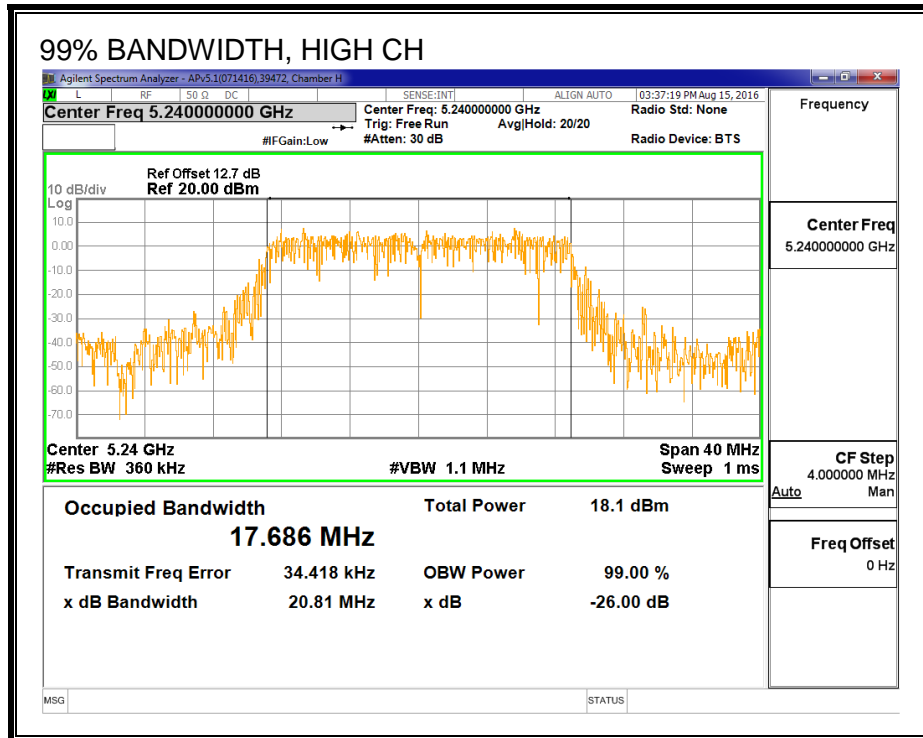

8.2.3. AVERAGE POWER (FCC)

LIMITS

None; for reporting purposes only.

TEST PROCEDURE

Measurements perform using a wideband gated RF power meter.

RESULTS

ID:	30554	Date:	9/12/16
------------	-------	--------------	---------

Channel	Frequency (MHz)	Power (dBm)
Low	5180	13.10
Mid	5200	13.15
High	5240	13.17

8.2.4. OUTPUT POWER AND PSD (FCC)

LIMITS

FCC §15.407 (a) (1)

(i) For an outdoor access point operating in the band 5.15-5.25 GHz, the maximum conducted output power over the frequency band of operation shall not exceed 1 W provided the maximum antenna gain does not exceed 6 dBi. In addition, the maximum power spectral density shall not exceed 17 dBm in any 1 megahertz band. If transmitting antennas of directional gain greater than 6 dBi are used, both the maximum conducted output power and the maximum power spectral density shall be reduced by the amount in dB that the directional gain of the antenna exceeds 6 dBi. The maximum e.i.r.p. at any elevation angle above 30 degrees as measured from the horizon must not exceed 125 mW (21 dBm).

(ii) For an indoor access point operating in the band 5.15-5.25 GHz, the maximum conducted output power over the frequency band of operation shall not exceed 1 W provided the maximum antenna gain does not exceed 6 dBi. In addition, the maximum power spectral density shall not exceed 17 dBm in any 1 megahertz band. If transmitting antennas of directional gain greater than 6 dBi are used, both the maximum conducted output power and the maximum power spectral density shall be reduced by the amount in dB that the directional gain of the antenna exceeds 6 dBi.

(iii) For fixed point-to-point access points operating in the band 5.15-5.25 GHz, the maximum conducted output power over the frequency band of operation shall not exceed 1 W. Fixed point-to-point U-NII devices may employ antennas with directional gain up to 23 dBi without any corresponding reduction in the maximum conducted output power or maximum power spectral density. For fixed point-to-point transmitters that employ a directional antenna gain greater than 23 dBi, a 1 dB reduction in maximum conducted output power and maximum power spectral density is required for each 1 dB of antenna gain in excess of 23 dBi. Fixed, point-to-point operations exclude the use of point-to-multipoint systems, omnidirectional applications, and multiple collocated transmitters transmitting the same information. The operator of the U-NII device, or if the equipment is professionally installed, the installer, is responsible for ensuring that systems employing high gain directional antennas are used exclusively for fixed, point-to-point operations.

(iv) For mobile and portable client devices in the 5.15-5.25 GHz band, the maximum conducted output power over the frequency band of operation shall not exceed 250 mW provided the maximum antenna gain does not exceed 6 dBi. In addition, the maximum power spectral density shall not exceed 11 dBm in any 1 megahertz band. If transmitting antennas of directional gain greater than 6 dBi are used, both the maximum conducted output power and the maximum power spectral density shall be reduced by the amount in dB that the directional gain of the antenna exceeds 6 dBi.

TEST PROCEDURE

Measurements perform using a wideband gated RF power meter provided that the gate parameters are adjusted such that the power is measured only when the EUT is transmitting at its maximum power control level. Since the measurement is made only during the ON time of the transmitter, no duty cycle correction factor is required.

DIRECTIONAL ANTENNA GAIN

There is only one transmitter output therefore the directional gain is equal to the antenna gain.

RESULTS

ID:	30554	Date:	9/12/16
------------	-------	--------------	---------

Antenna Gain and Limits

Channel	Frequency (MHz)	Directional Gain for Power (dBi)	Directional Gain for PSD (dBi)	Power Limit (dBm)	PSD Limit (dBm)
Low	5180	6.70	6.70	23.30	10.30
Mid	5200	6.70	6.70	23.30	10.30
High	5240	6.70	6.70	23.30	10.30

Duty Cycle CF (dB)	0.00	Included in Calculations of Corr'd PSD
---------------------------	------	---

Output Power Results

Channel	Frequency (MHz)	Chain 1 Meas Power (dBm)	Total Corr'd Power (dBm)	Power Limit (dBm)	Power Margin (dB)
Low	5180	13.10	13.10	23.30	-10.20
Mid	5200	13.15	13.15	23.30	-10.15
High	5240	13.17	13.17	23.30	-10.13

PSD Results

Channel	Frequency (MHz)	Chain 1 Meas PSD (dBm)	Total Corr'd PSD (dBm)	PSD Limit (dBm)	PSD Margin (dB)
Low	5180	1.80	1.80	10.30	-8.50
Mid	5200	1.86	1.86	10.30	-8.45
High	5240	1.80	1.80	10.30	-8.50

PSD

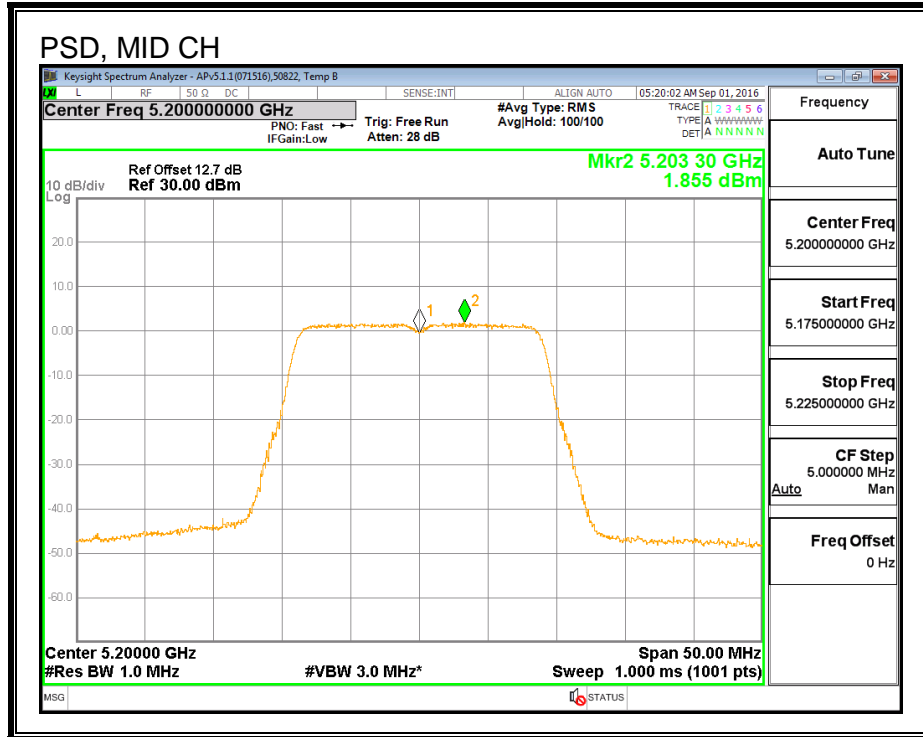
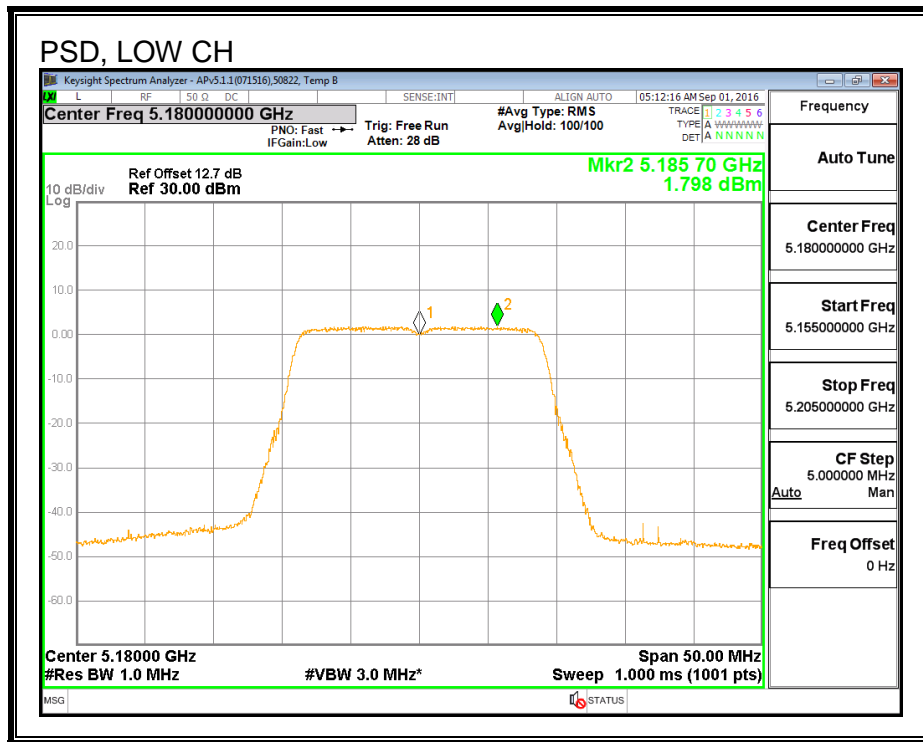

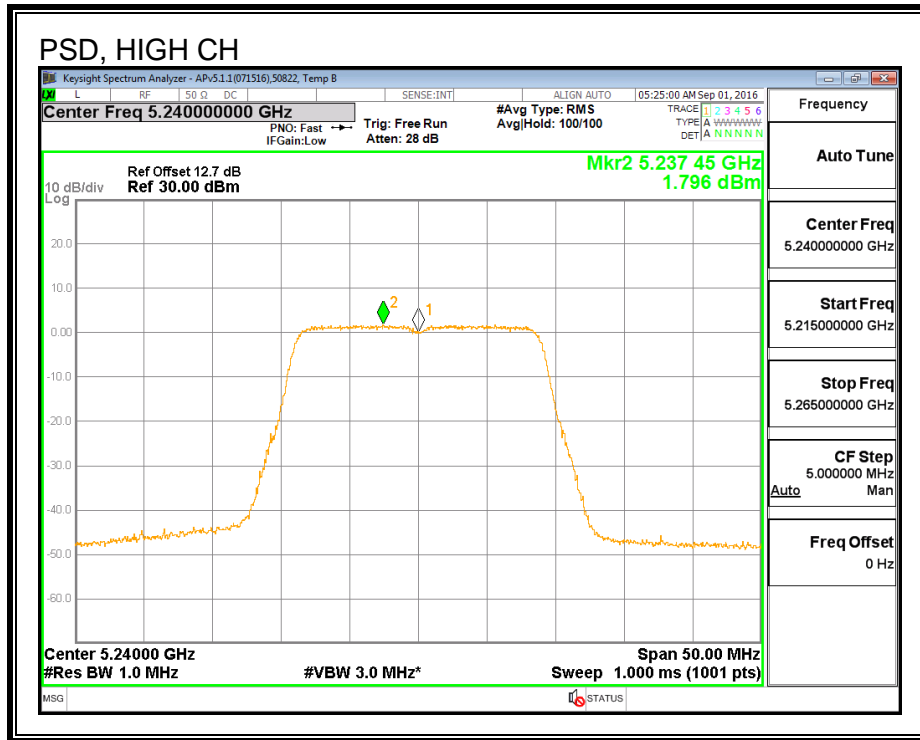

8.2.5. AVERAGE POWER (IC)

LIMITS

None; for reporting purposes only.

TEST PROCEDURE

Measurements perform using a wideband gated RF power meter.

RESULTS

ID:	50820	Date:	9/15/16
------------	-------	--------------	---------

Channel	Frequency (MHz)	Power (dBm)
Low	5180	10.95
Mid	5200	10.95
High	5240	10.97

8.2.6. OUTPUT POWER AND PSD (IC)

LIMITS

IC RSS-247 (6.2.1) (1)

The maximum e.i.r.p. shall not exceed 200 mW or $10 + 10 \log_{10} B$, dBm, whichever power is less. B is the 99% emission bandwidth in MHz. The e.i.r.p. spectral density shall not exceed 10 dBm in any 1.0 MHz band.

TEST PROCEDURE

Measurements perform using a wideband gated RF power meter provided that the gate parameters are adjusted such that the power is measured only when the EUT is transmitting at its maximum power control level. Since the measurement is made only during the ON time of the transmitter, no duty cycle correction factor is required.

DIRECTIONAL ANTENNA GAIN

There is only one transmitter output therefore the directional gain is equal to the antenna gain.

RESULTS

ID:	50820	Date:	9/15/16
------------	-------	--------------	---------

Bandwidth and Antenna Gain

Channel	Frequency (MHz)	Min 99% BW (MHz)	Direction Gain (dBi)
Low	5180	17.838	6.70
Mid	5200	17.763	6.70
High	5240	17.686	6.70

Limits

Channel	Frequency (MHz)	IC EIRP Limit (dBm)	Max IC Power (dBm)	IC eirp PSD Limit (dBm)	Max IC PSD (dBm)
Low	5180	22.51	15.81	10.00	3.30
Mid	5200	22.50	15.80	10.00	3.30
High	5240	22.48	15.78	10.00	3.30

Duty Cycle CF (dB)	0.00	Included in Calculations of Corr'd PSD
---------------------------	------	---

Output Power Results

Channel	Frequency (MHz)	Chain 1 Meas Power (dBm)	Total Corr'd Power (dBm)	Power Limit (dBm)	Power Margin (dB)
Low	5180	10.95	10.95	15.81	-4.86
Mid	5200	10.95	10.95	15.80	-4.85
High	5240	10.97	10.97	15.78	-4.81

PSD Results

Channel	Frequency (MHz)	Chain 1 Meas PSD (dBm)	Total Corr'd PSD (dBm)	PSD Limit (dBm)	PSD Margin (dB)
Low	5180	-1.027	-1.03	3.30	-4.33
Mid	5200	-1.031	-1.03	3.30	-4.33
High	5240	-1.020	-1.02	3.30	-4.32

PSD, CHAIN 1

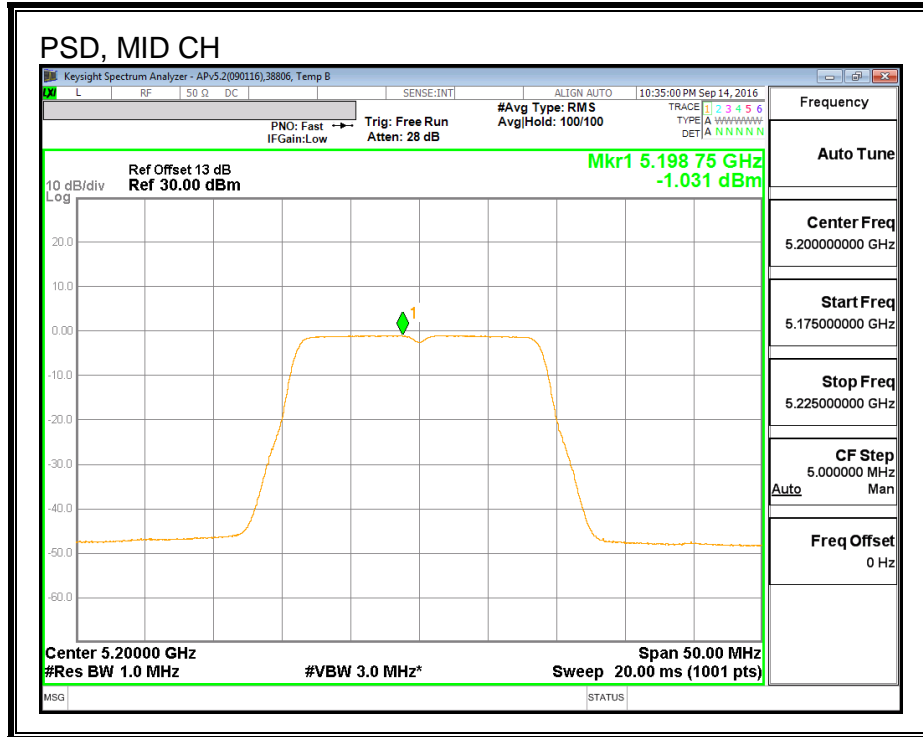
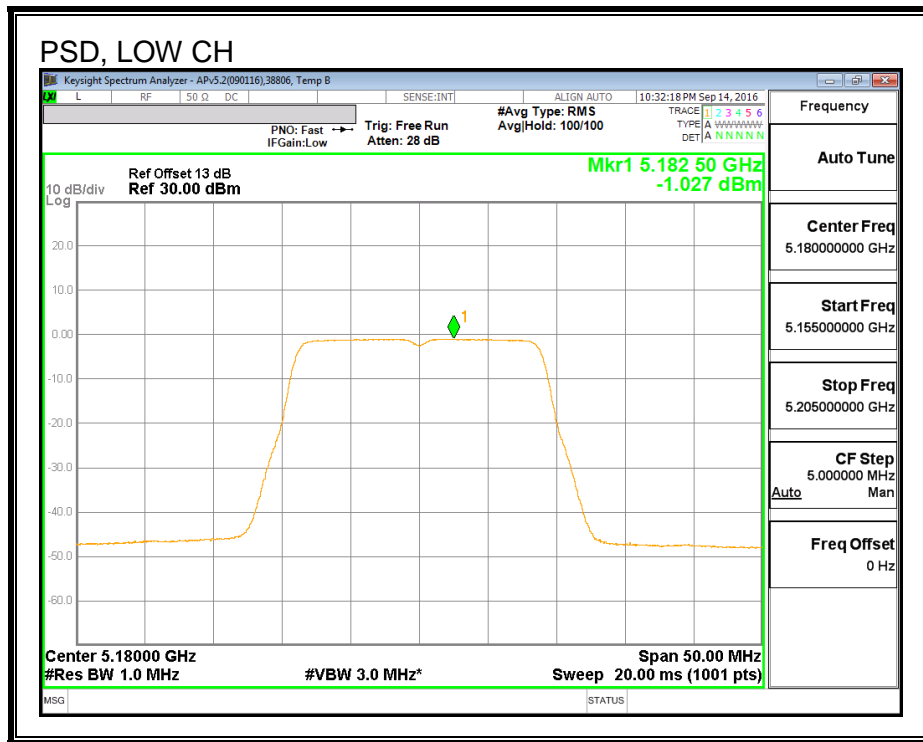

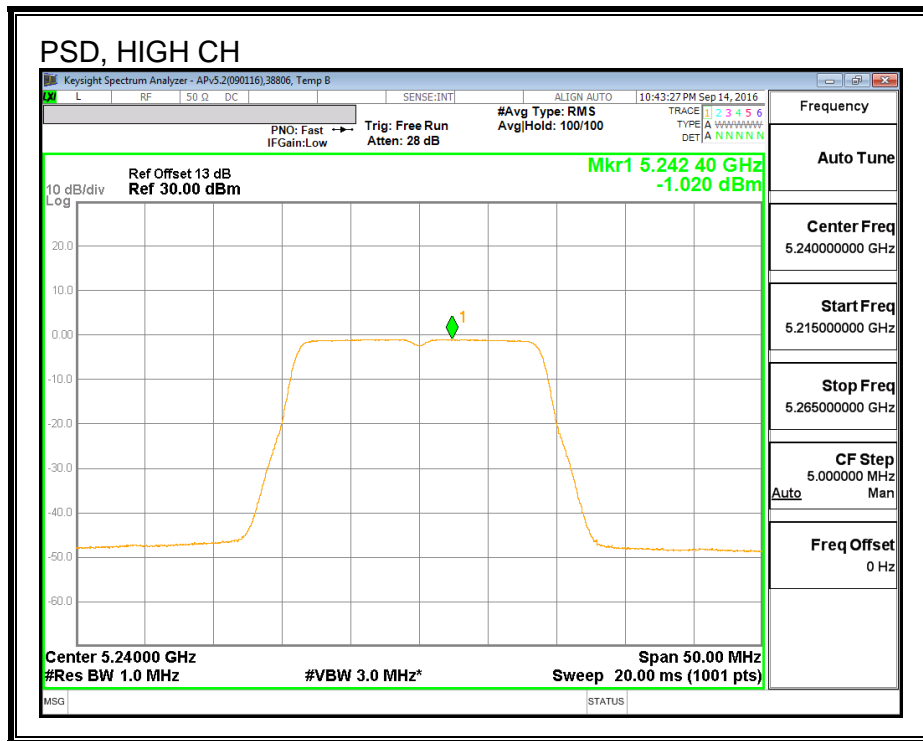

8.3. 802.11n HT20 CHAIN 2 MODE IN THE 5.2 GHz BAND

8.3.1. 26 dB BANDWIDTH

LIMITS

None; for reporting purposes only.

RESULTS

Channel	Frequency (MHz)	26 dB Bandwidth (MHz)
Low	5180	21.978
Mid	5200	22.066
High	5240	22.066

26 dB BANDWIDTH

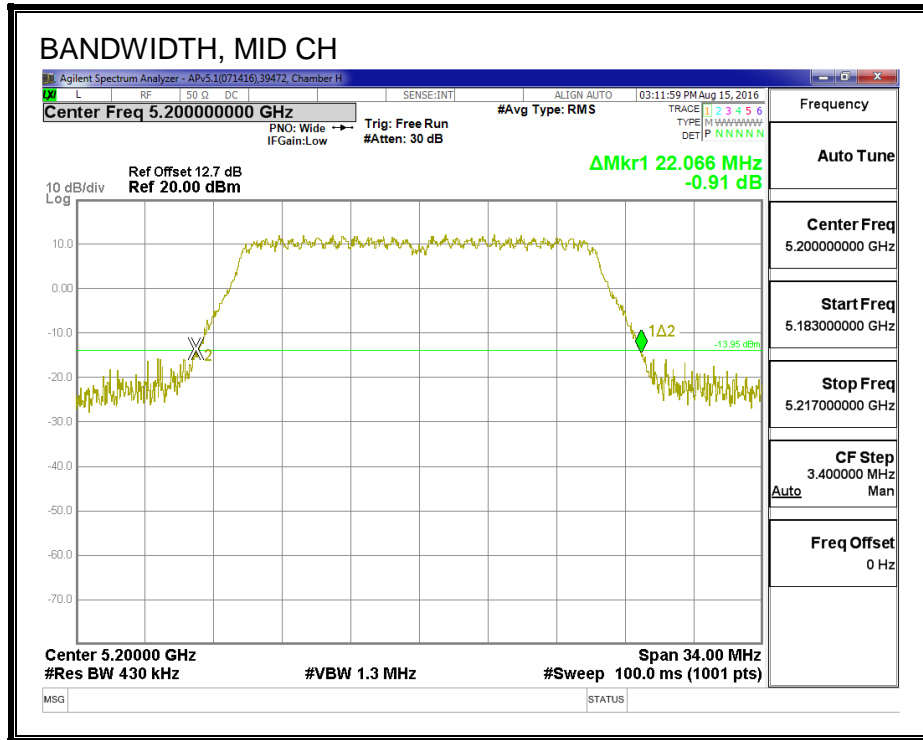
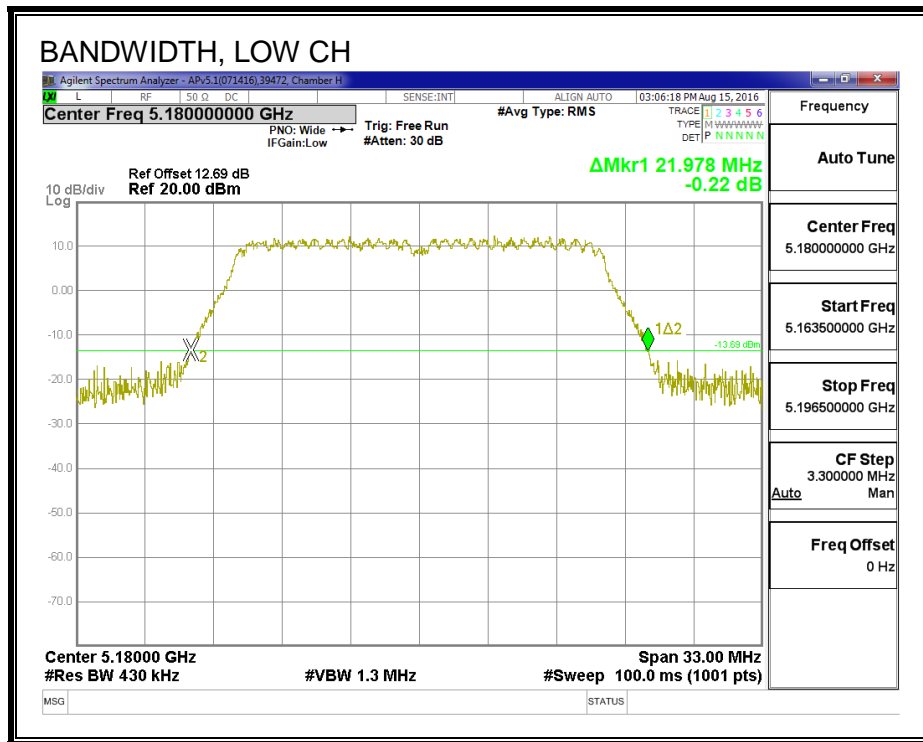

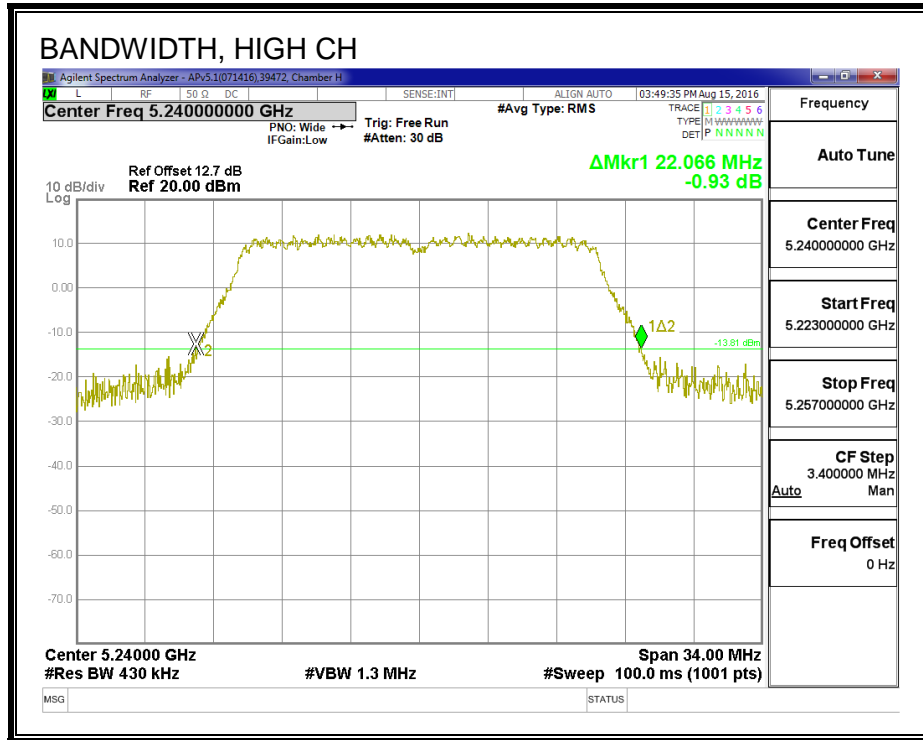

8.3.2. 99% BANDWIDTH

LIMITS

None; for reporting purposes only.

RESULTS

Channel	Frequency (MHz)	99% BW (MHz)
Low	5180	17.823
Mid	5200	17.887
High	5240	17.831

99% BANDWIDTH

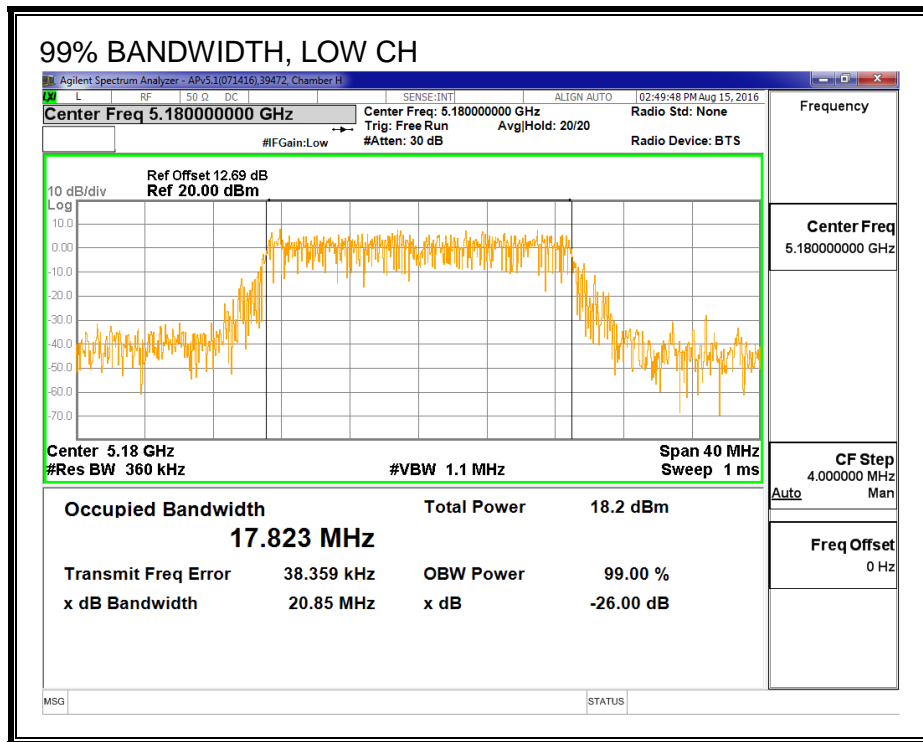

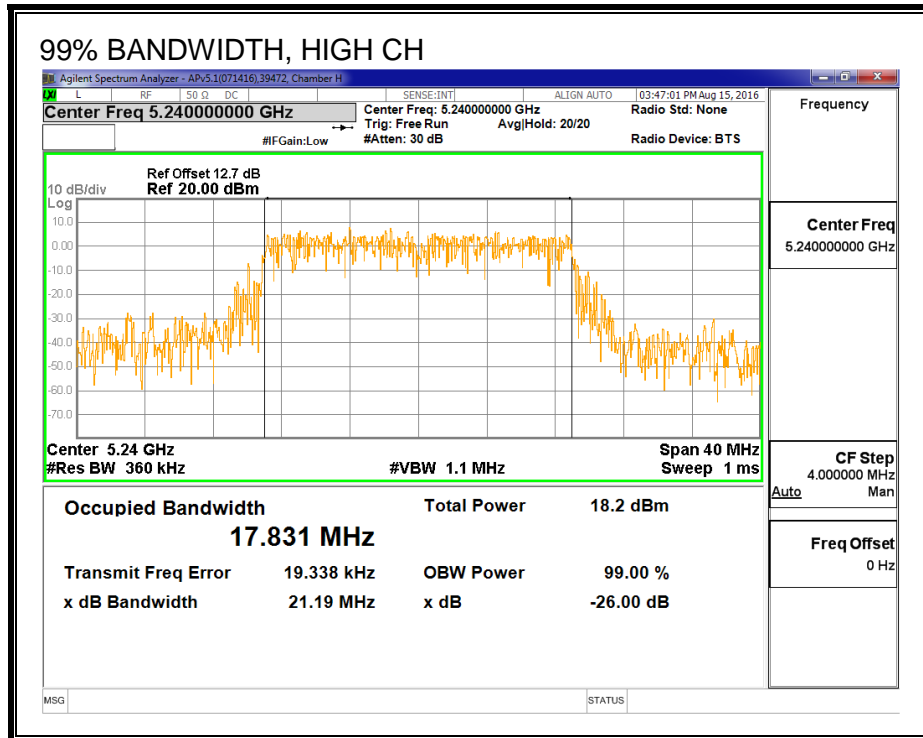

8.3.3. AVERAGE POWER (FCC)

LIMITS

None; for reporting purposes only.

TEST PROCEDURE

Measurements perform using a wideband gated RF power meter.

RESULTS

ID:	30554	Date:	9/12/16
------------	-------	--------------	---------

Channel	Frequency (MHz)	Power (dBm)
Low	5180	13.18
Mid	5200	13.14
High	5240	13.21

8.3.4. OUTPUT POWER AND PSD (FCC)

LIMITS

FCC §15.407 (a) (1)

(i) For an outdoor access point operating in the band 5.15-5.25 GHz, the maximum conducted output power over the frequency band of operation shall not exceed 1 W provided the maximum antenna gain does not exceed 6 dBi. In addition, the maximum power spectral density shall not exceed 17 dBm in any 1 megahertz band. If transmitting antennas of directional gain greater than 6 dBi are used, both the maximum conducted output power and the maximum power spectral density shall be reduced by the amount in dB that the directional gain of the antenna exceeds 6 dBi. The maximum e.i.r.p. at any elevation angle above 30 degrees as measured from the horizon must not exceed 125 mW (21 dBm).

(ii) For an indoor access point operating in the band 5.15-5.25 GHz, the maximum conducted output power over the frequency band of operation shall not exceed 1 W provided the maximum antenna gain does not exceed 6 dBi. In addition, the maximum power spectral density shall not exceed 17 dBm in any 1 megahertz band. If transmitting antennas of directional gain greater than 6 dBi are used, both the maximum conducted output power and the maximum power spectral density shall be reduced by the amount in dB that the directional gain of the antenna exceeds 6 dBi.

(iii) For fixed point-to-point access points operating in the band 5.15-5.25 GHz, the maximum conducted output power over the frequency band of operation shall not exceed 1 W. Fixed point-to-point U-NII devices may employ antennas with directional gain up to 23 dBi without any corresponding reduction in the maximum conducted output power or maximum power spectral density. For fixed point-to-point transmitters that employ a directional antenna gain greater than 23 dBi, a 1 dB reduction in maximum conducted output power and maximum power spectral density is required for each 1 dB of antenna gain in excess of 23 dBi. Fixed, point-to-point operations exclude the use of point-to-multipoint systems, omnidirectional applications, and multiple collocated transmitters transmitting the same information. The operator of the U-NII device, or if the equipment is professionally installed, the installer, is responsible for ensuring that systems employing high gain directional antennas are used exclusively for fixed, point-to-point operations.

(iv) For mobile and portable client devices in the 5.15-5.25 GHz band, the maximum conducted output power over the frequency band of operation shall not exceed 250 mW provided the maximum antenna gain does not exceed 6 dBi. In addition, the maximum power spectral density shall not exceed 11 dBm in any 1 megahertz band. If transmitting antennas of directional gain greater than 6 dBi are used, both the maximum conducted output power and the maximum power spectral density shall be reduced by the amount in dB that the directional gain of the antenna exceeds 6 dBi.

TEST PROCEDURE

Measurements perform using a wideband gated RF power meter provided that the gate parameters are adjusted such that the power is measured only when the EUT is transmitting at its maximum power control level. Since the measurement is made only during the ON time of the transmitter, no duty cycle correction factor is required.

DIRECTIONAL ANTENNA GAIN

There is only one transmitter output therefore the directional gain is equal to the antenna gain.

RESULTS

ID:	30554	Date:	9/12/16
------------	-------	--------------	---------

Antenna Gain and Limits

Channel	Frequency (MHz)	Directional Gain for Power (dBi)	Directional Gain for PSD (dBi)	Power Limit (dBm)	PSD Limit (dBm)
Low	5180	4.90	4.90	24.00	11.00
Mid	5200	4.90	4.90	24.00	11.00
High	5240	4.90	4.90	24.00	11.00

Duty Cycle CF (dB)	0.00	Included in Calculations of Corr'd PSD
---------------------------	------	---

Output Power Results

Channel	Frequency (MHz)	Chain 2 Meas Power (dBm)	Total Corr'd Power (dBm)	Power Limit (dBm)	Power Margin (dB)
Low	5180	13.18	13.18	24.00	-10.82
Mid	5200	13.14	13.14	24.00	-10.86
High	5240	13.21	13.21	24.00	-10.79

PSD Results

Channel	Frequency (MHz)	Chain 2 Meas PSD (dBm)	Total Corr'd PSD (dBm)	PSD Limit (dBm)	PSD Margin (dB)
Low	5180	1.54	1.54	11.00	-9.46
Mid	5200	1.89	1.89	11.00	-9.11
High	5240	1.82	1.82	11.00	-9.18

PSD

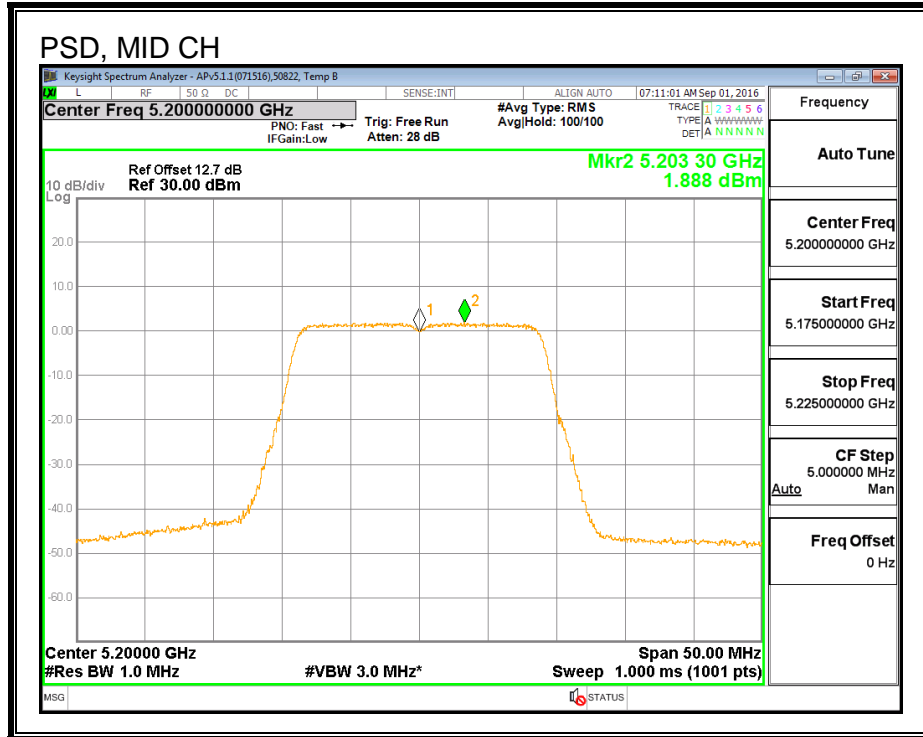
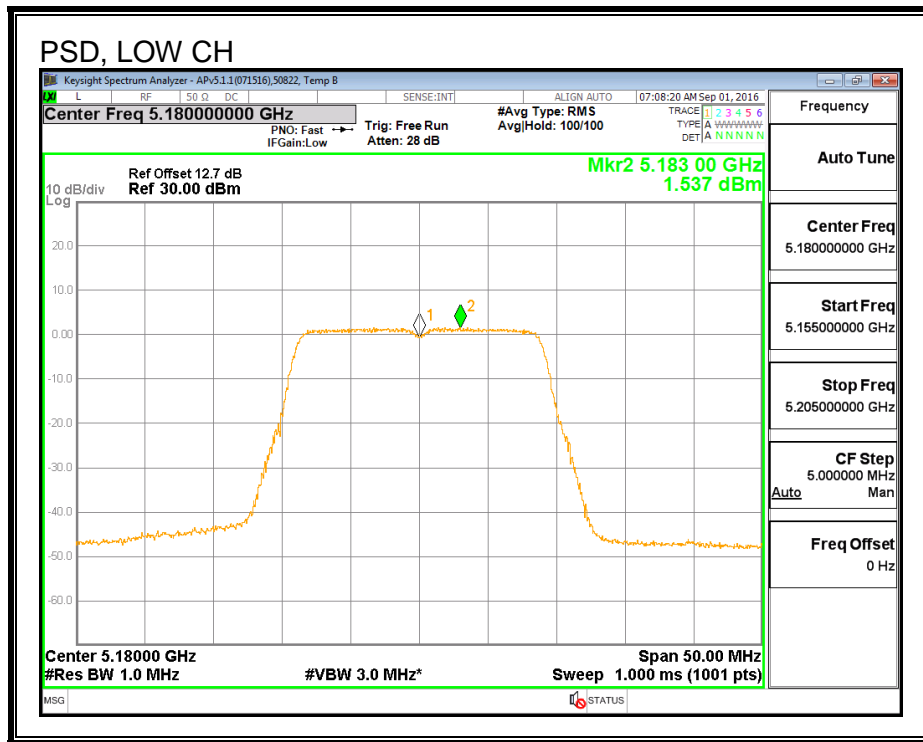

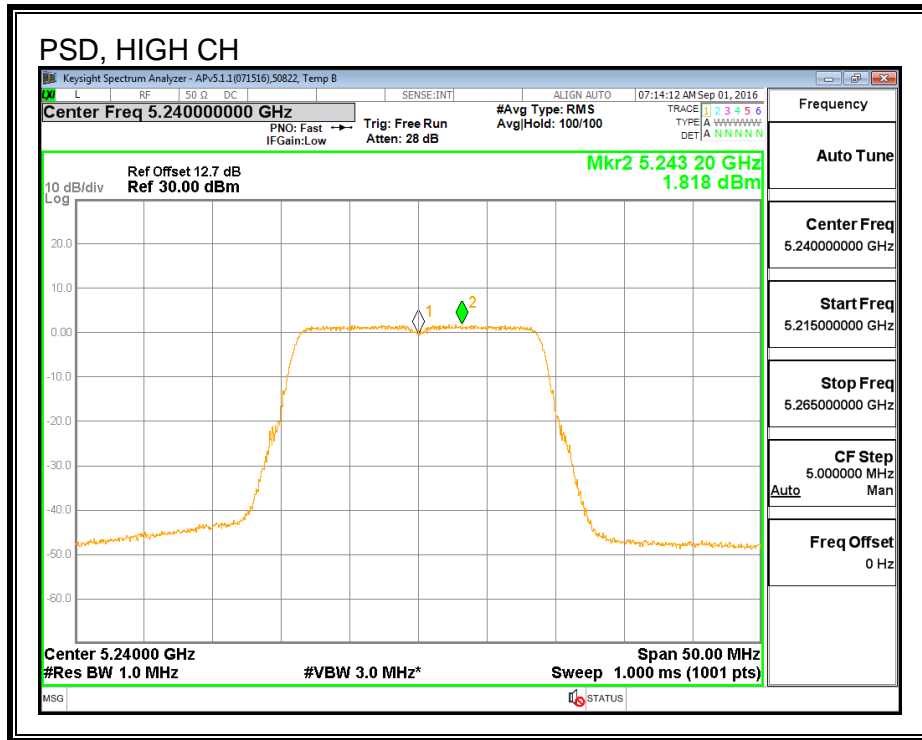

8.3.5. AVERAGE POWER (IC)

LIMITS

None; for reporting purposes only.

TEST PROCEDURE

Measurements perform using a wideband gated RF power meter.

RESULTS

ID:	50820	Date:	9/15/16
------------	-------	--------------	---------

Channel	Frequency (MHz)	Power (dBm)
Low	5180	10.87
Mid	5200	10.97
High	5240	10.96

8.3.6. OUTPUT POWER AND PSD (IC)

LIMITS

IC RSS-247 (6.2.1) (1)

The maximum e.i.r.p. shall not exceed 200 mW or $10 + 10 \log_{10} B$, dBm, whichever power is less. B is the 99% emission bandwidth in MHz. The e.i.r.p. spectral density shall not exceed 10 dBm in any 1.0 MHz band.

TEST PROCEDURE

Measurements perform using a wideband gated RF power meter provided that the gate parameters are adjusted such that the power is measured only when the EUT is transmitting at its maximum power control level. Since the measurement is made only during the ON time of the transmitter, no duty cycle correction factor is required.

DIRECTIONAL ANTENNA GAIN

There is only one transmitter output therefore the directional gain is equal to the antenna gain.

RESULTS

ID:	50820	Date:	9/15/16
------------	-------	--------------	---------

Bandwidth and Antenna Gain

Channel	Frequency (MHz)	Min 99% BW (MHz)	Direction Gain (dBi)
Low	5180	17.823	4.90
Mid	5200	17.887	4.90
High	5240	17.831	4.90

Limits

Channel	Frequency (MHz)	IC EIRP Limit (dBm)	Max IC Power (dBm)	IC eirp PSD Limit (dBm)	Max IC PSD (dBm)
Low	5180	22.51	17.61	10.00	5.10
Mid	5200	22.53	17.63	10.00	5.10
High	5240	22.51	17.61	10.00	5.10

Duty Cycle CF (dB)	0.00	Included in Calculations of Corr'd PSD
---------------------------	------	---

Output Power Results

Channel	Frequency (MHz)	Chain 2 Meas Power (dBm)	Total Corr'd Power (dBm)	Power Limit (dBm)	Power Margin (dB)
Low	5180	10.87	10.87	17.61	-6.74
Mid	5200	10.97	10.97	17.63	-6.66
High	5240	10.96	10.96	17.61	-6.65

PSD Results

Channel	Frequency (MHz)	Chain 2 Meas PSD (dBm)	Total Corr'd PSD (dBm)	PSD Limit (dBm)	PSD Margin (dB)
Low	5180	-1.112	-1.11	5.10	-6.21
Mid	5200	-1.005	-1.01	5.10	-6.11
High	5240	-1.060	-1.06	5.10	-6.16

PSD, CHAIN 1

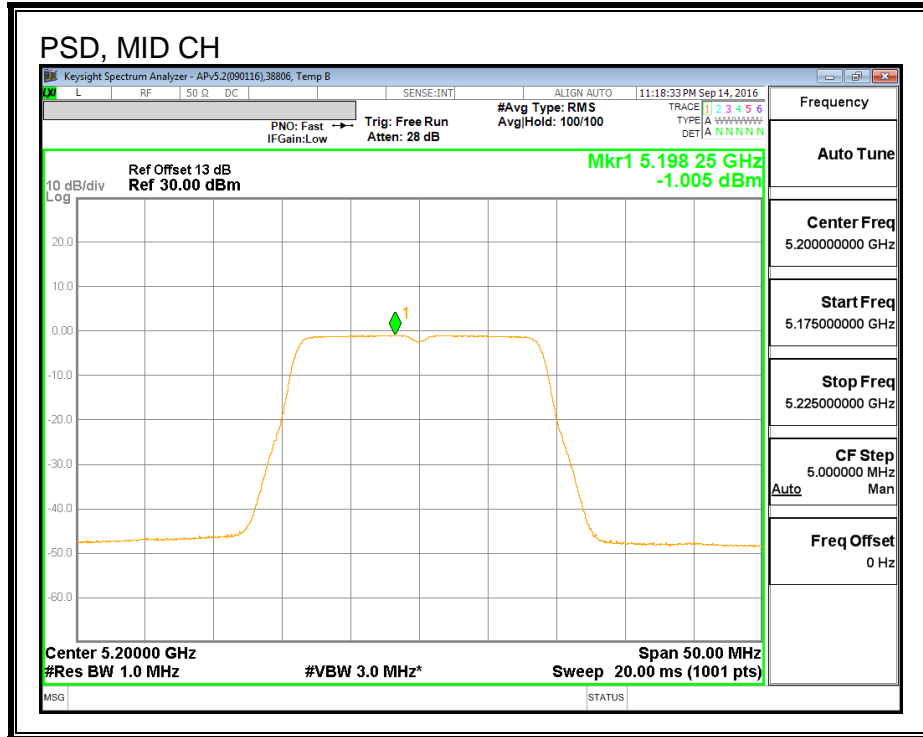
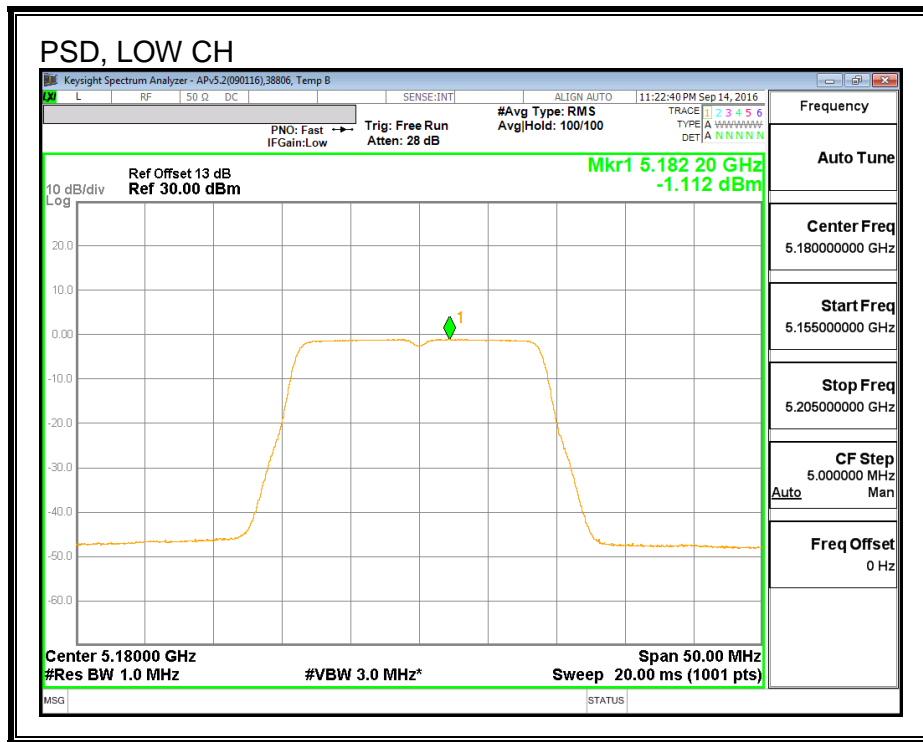

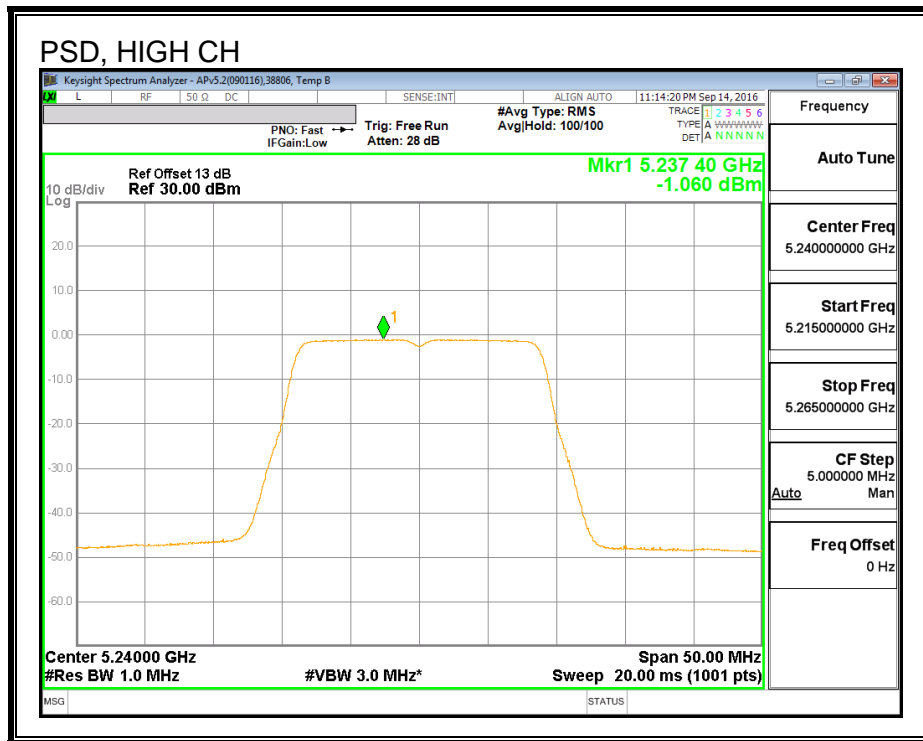

8.4. 802.11n HT20 2Tx (CHAIN 0 + CHAIN 1) CDD MODE IN THE 5.2 GHz BAND

8.4.1. 26 dB BANDWIDTH

LIMITS

None; for reporting purposes only.

RESULTS

Channel	Frequency (MHz)	26 dB BW Chain 0 (MHz)	26 dB BW Chain 1 (MHz)
Low	5180	22.372	21.813
Mid	5200	22.236	21.714
High	5240	22.338	21.747

26 DB BANDWIDTH, CHAIN 0

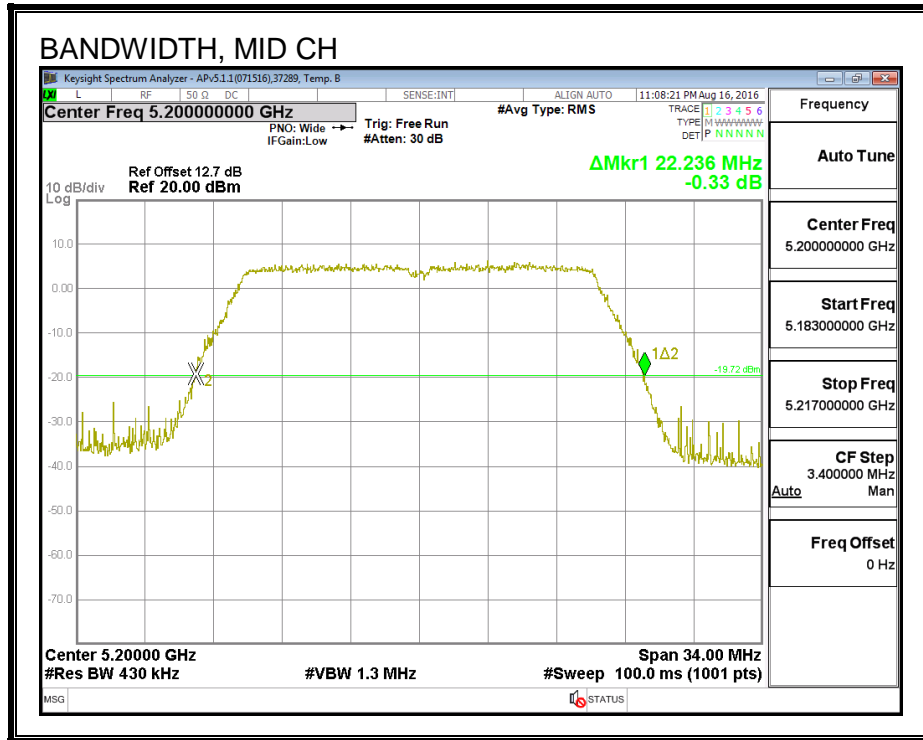
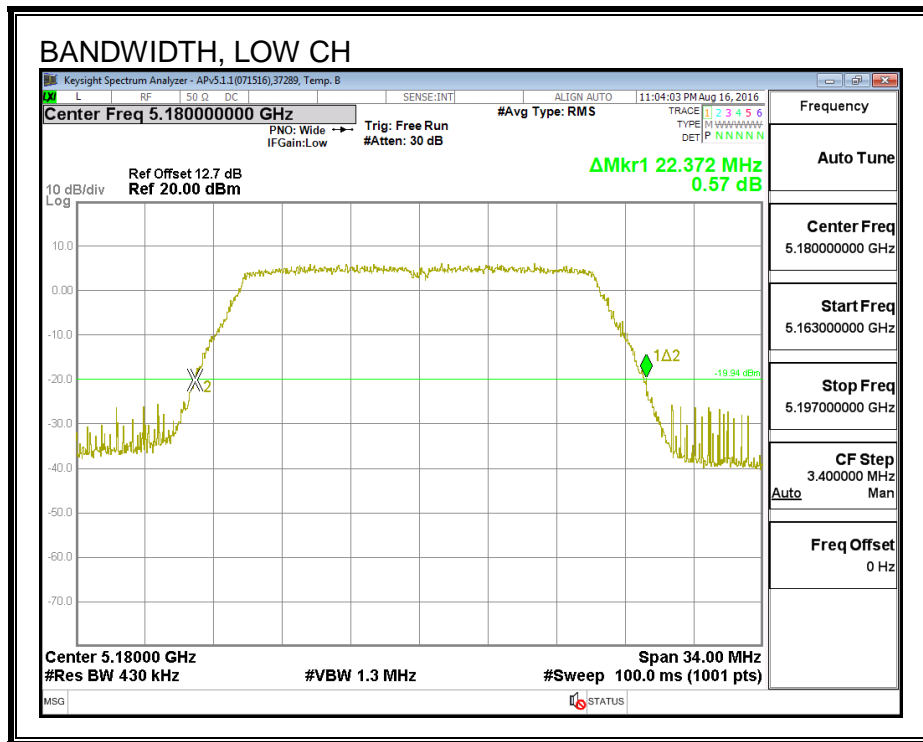

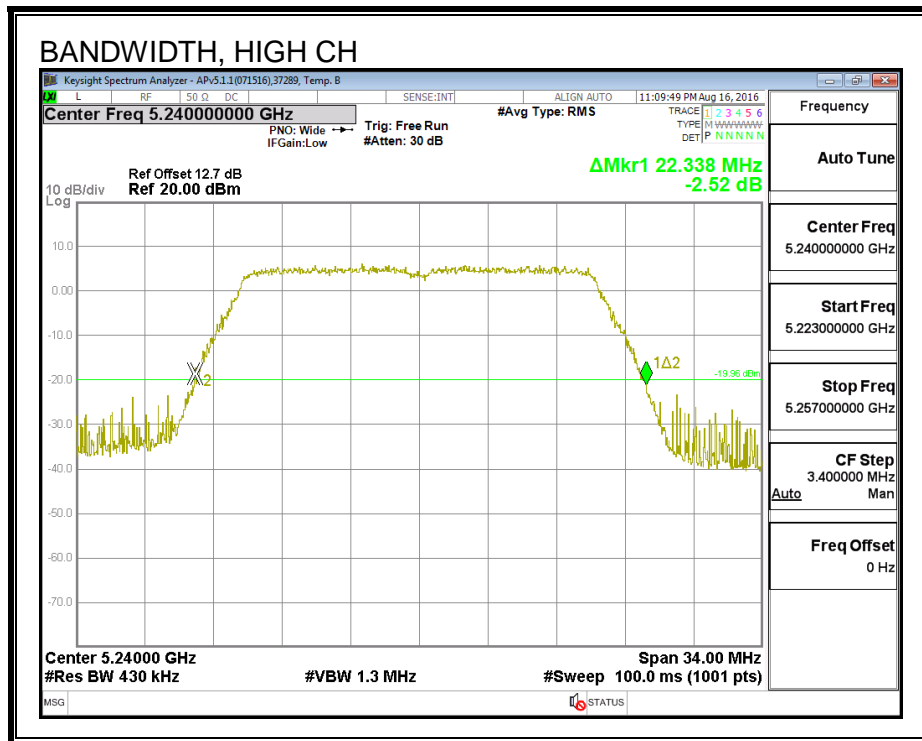

26 DB BANDWIDTH, CHAIN 1

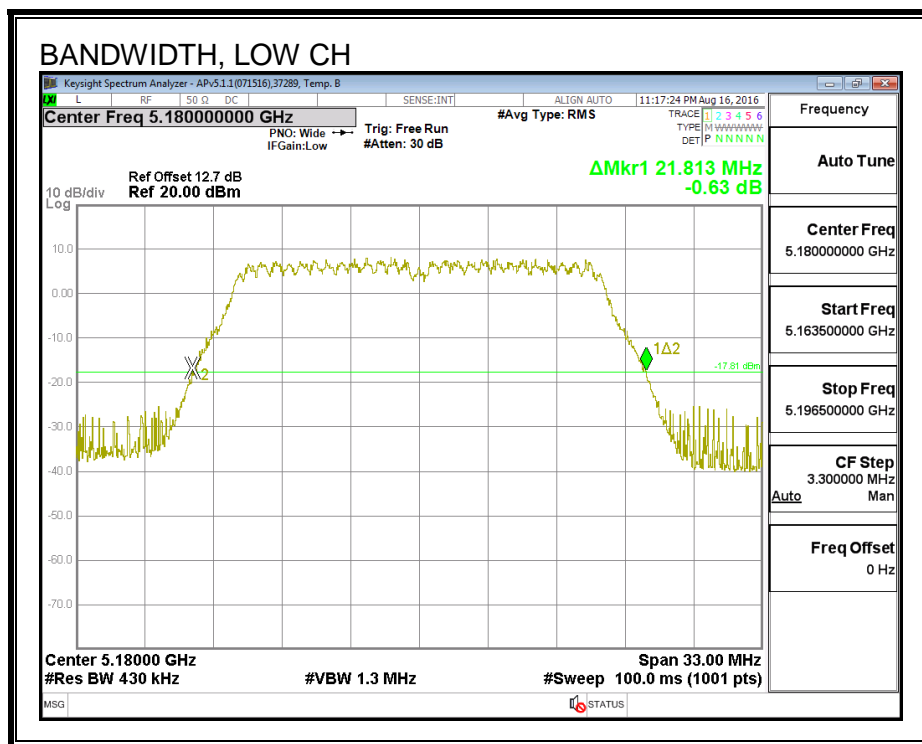

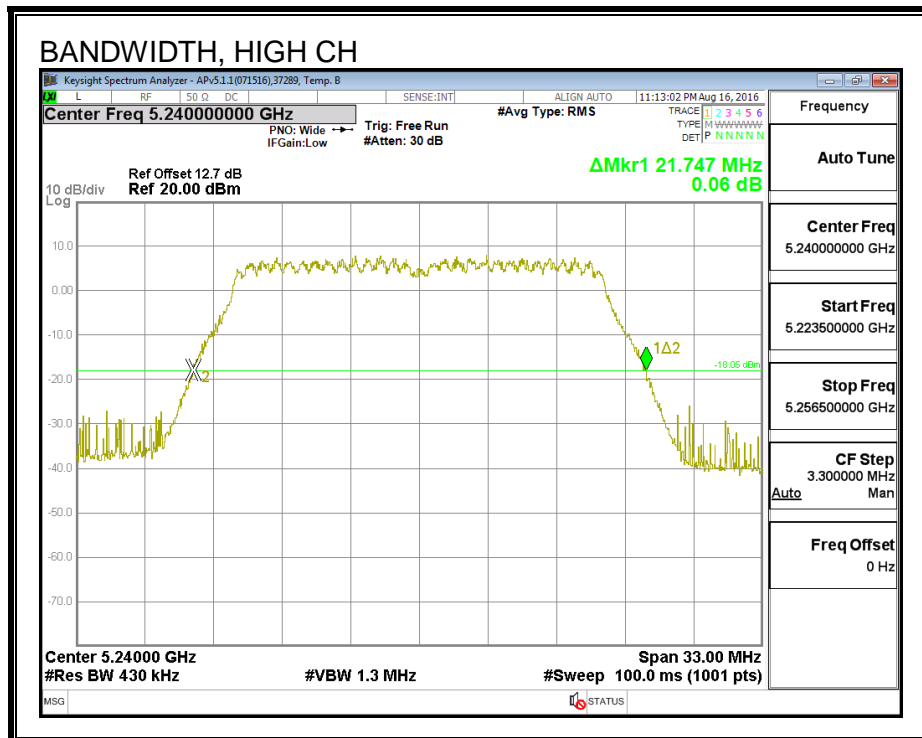
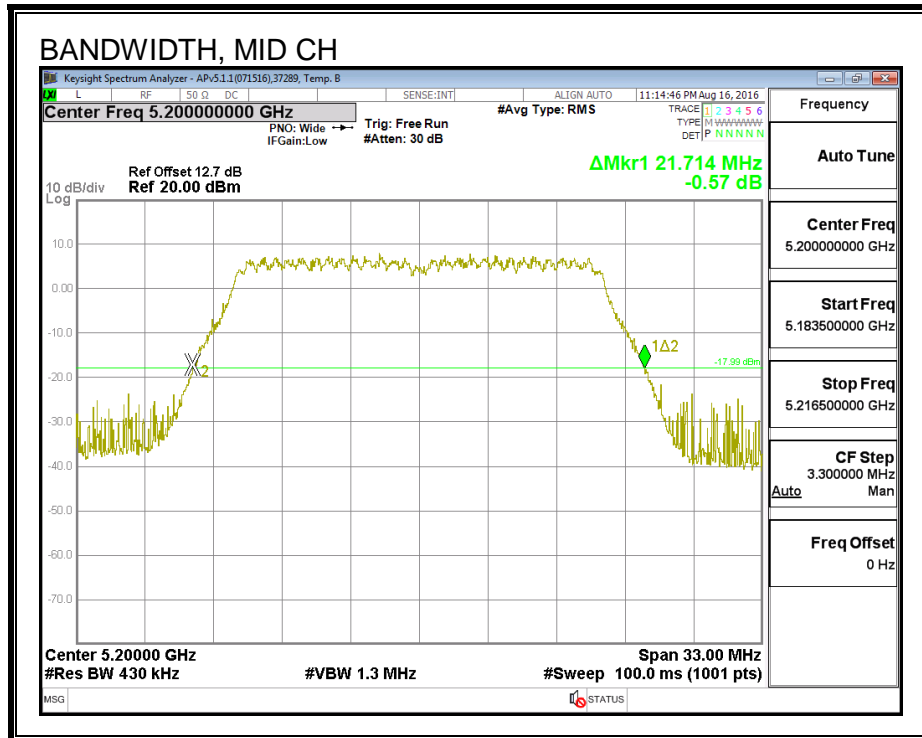

8.4.2. 99% BANDWIDTH

LIMITS

None; for reporting purposes only.

RESULTS

Channel	Frequency (MHz)	99% BW Chain 0 (MHz)	99% BW Chain 1 (MHz)
Low	5180	17.739	17.824
Mid	5200	17.752	17.875
High	5240	17.753	17.816

99% BANDWIDTH, CHAIN 0

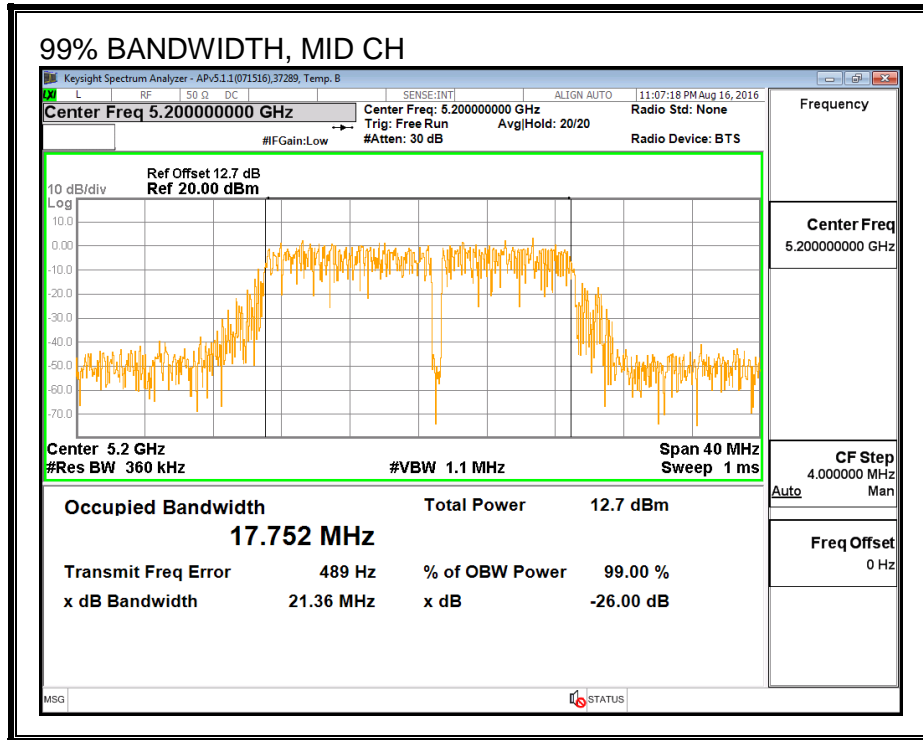
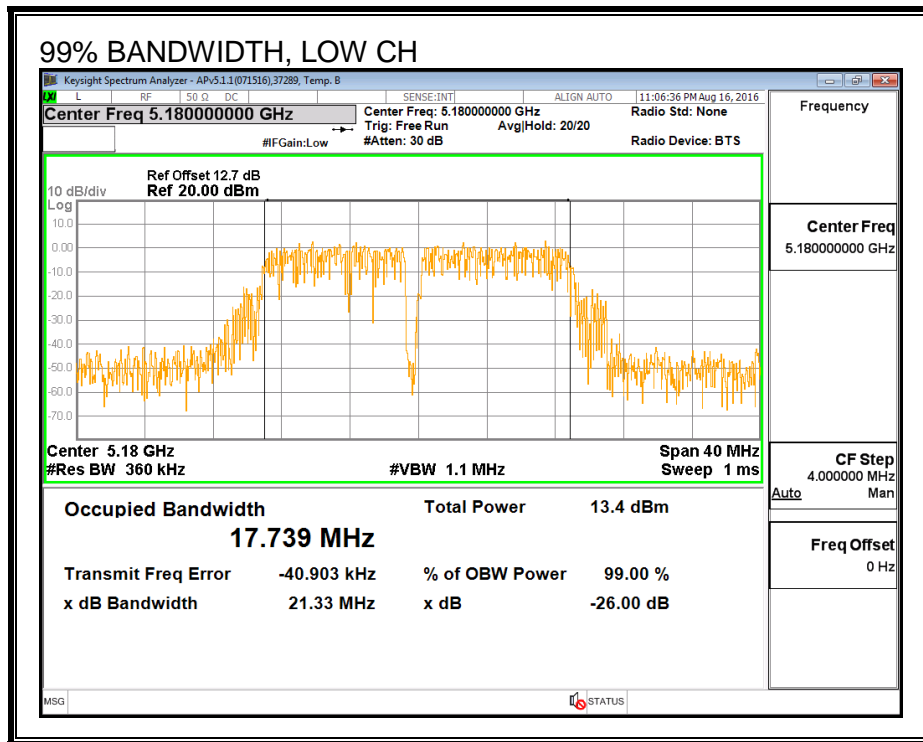

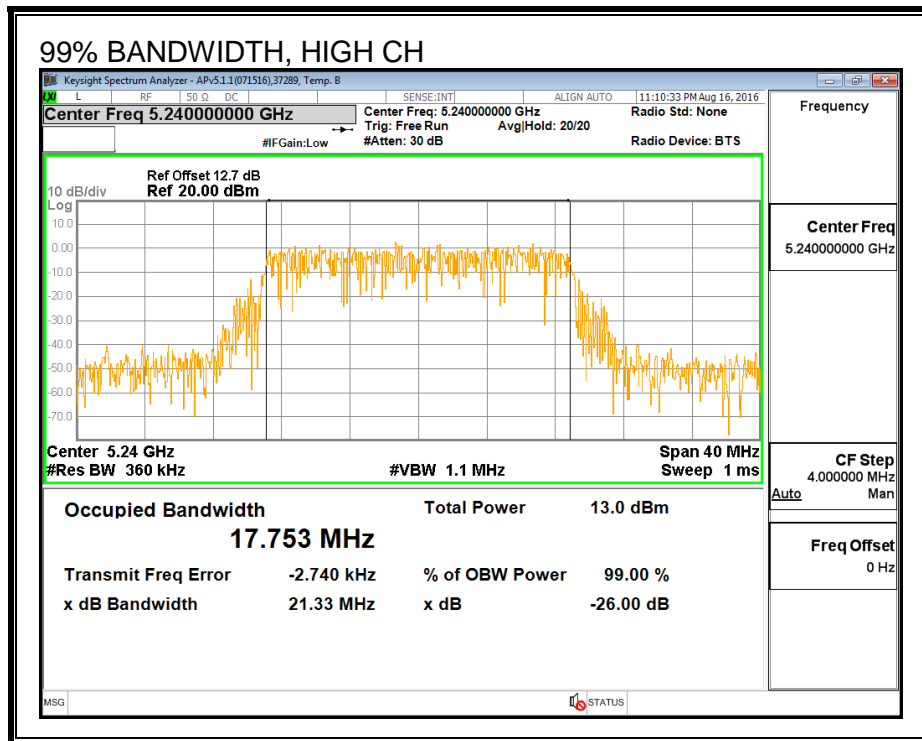

99% BANDWIDTH, CHAIN 1

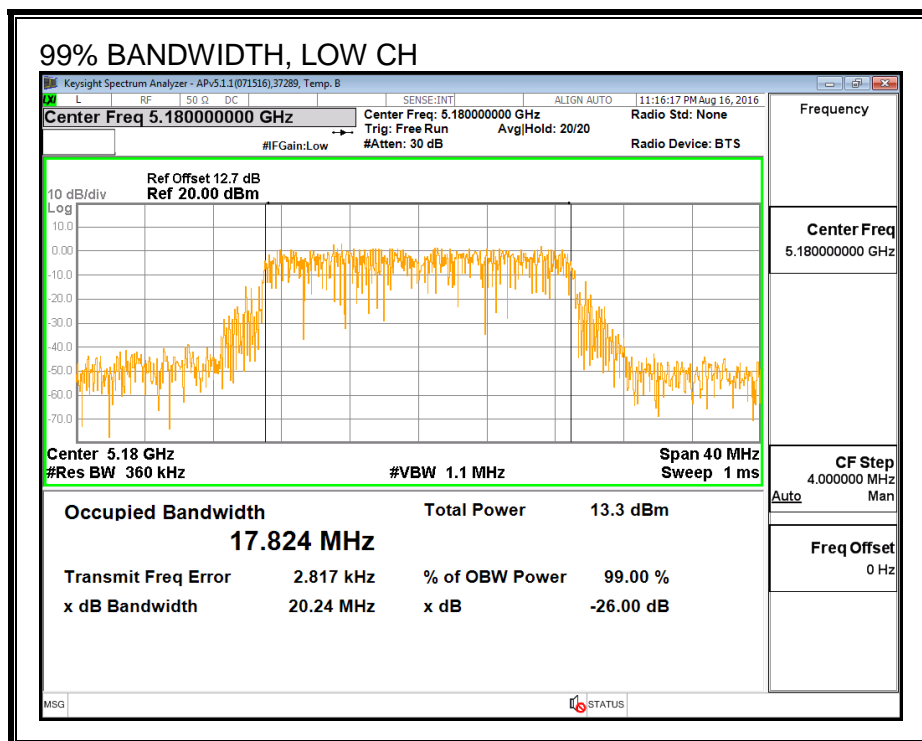

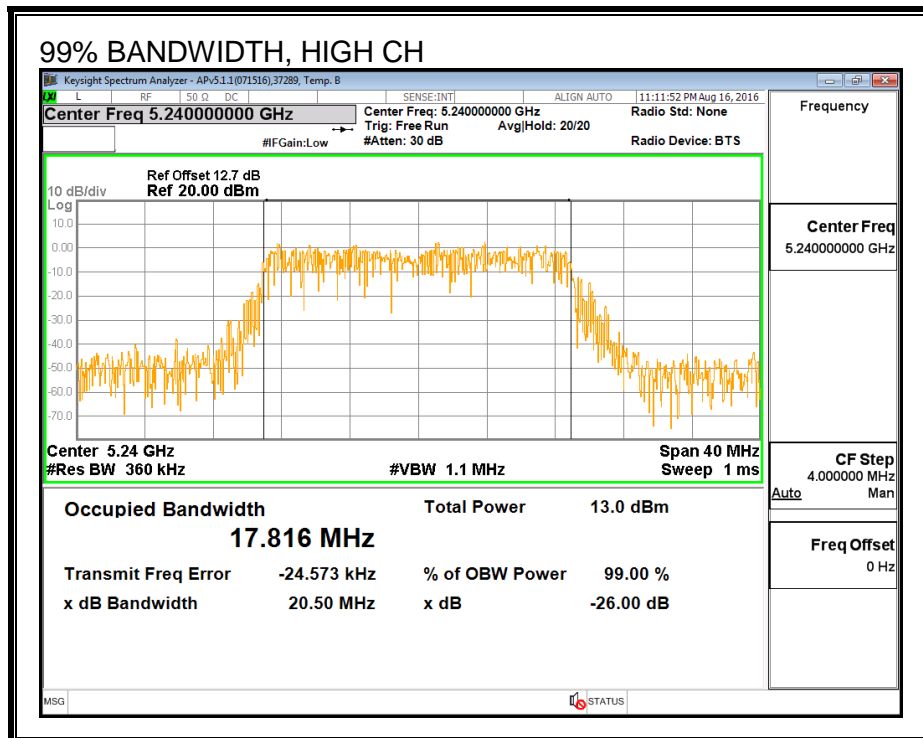
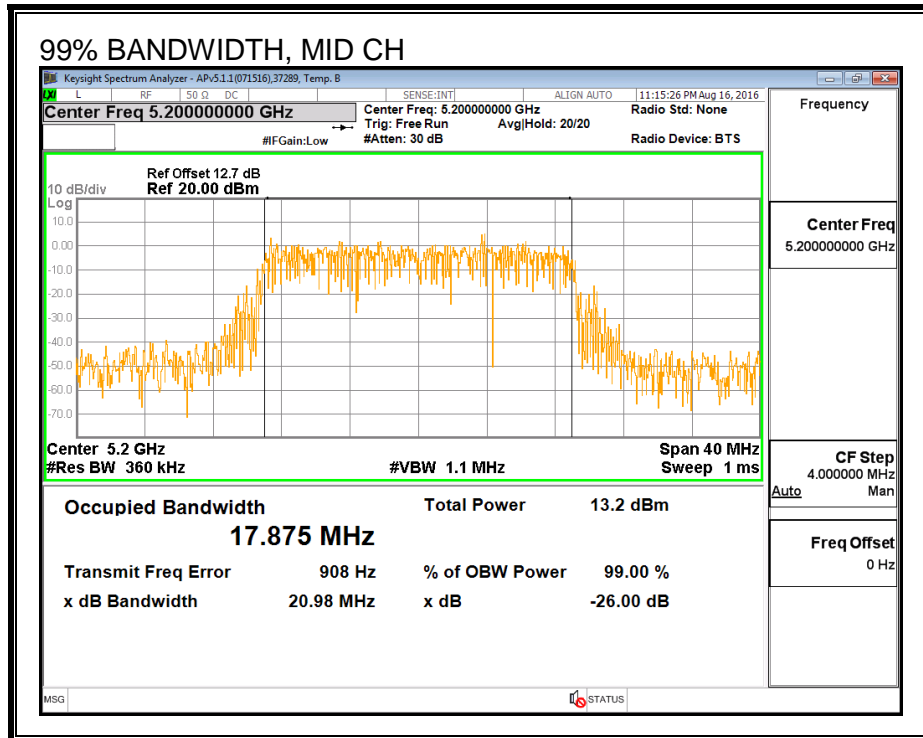

8.4.3. AVERAGE POWER (FCC)

LIMITS

None; for reporting purposes only.

TEST PROCEDURE

Measurements perform using a wideband gated RF power meter.

RESULTS

ID:	43573	Date:	9/7/16
------------	-------	--------------	--------

Average Power Results

Channel	Frequency (MHz)	Chain 0 Power (dBm)	Chain 1 Power (dBm)	Total Power (dBm)
Low	5180	12.78	12.86	15.83
Mid	5200	12.89	12.98	15.95
High	5240	12.88	12.99	15.95

8.4.4. OUTPUT POWER AND PSD (FCC)

LIMITS

FCC §15.407 (a) (1)

(i) For an outdoor access point operating in the band 5.15-5.25 GHz, the maximum conducted output power over the frequency band of operation shall not exceed 1 W provided the maximum antenna gain does not exceed 6 dBi. In addition, the maximum power spectral density shall not exceed 17 dBm in any 1 megahertz band. If transmitting antennas of directional gain greater than 6 dBi are used, both the maximum conducted output power and the maximum power spectral density shall be reduced by the amount in dB that the directional gain of the antenna exceeds 6 dBi. The maximum e.i.r.p. at any elevation angle above 30 degrees as measured from the horizon must not exceed 125 mW (21 dBm).

(ii) For an indoor access point operating in the band 5.15-5.25 GHz, the maximum conducted output power over the frequency band of operation shall not exceed 1 W provided the maximum antenna gain does not exceed 6 dBi. In addition, the maximum power spectral density shall not exceed 17 dBm in any 1 megahertz band. If transmitting antennas of directional gain greater than 6 dBi are used, both the maximum conducted output power and the maximum power spectral density shall be reduced by the amount in dB that the directional gain of the antenna exceeds 6 dBi.

(iii) For fixed point-to-point access points operating in the band 5.15-5.25 GHz, the maximum conducted output power over the frequency band of operation shall not exceed 1 W. Fixed point-to-point U-NII devices may employ antennas with directional gain up to 23 dBi without any corresponding reduction in the maximum conducted output power or maximum power spectral density. For fixed point-to-point transmitters that employ a directional antenna gain greater than 23 dBi, a 1 dB reduction in maximum conducted output power and maximum power spectral density is required for each 1 dB of antenna gain in excess of 23 dBi. Fixed, point-to-point operations exclude the use of point-to-multipoint systems, omnidirectional applications, and multiple collocated transmitters transmitting the same information. The operator of the U-NII device, or if the equipment is professionally installed, the installer, is responsible for ensuring that systems employing high gain directional antennas are used exclusively for fixed, point-to-point operations.

(iv) For mobile and portable client devices in the 5.15-5.25 GHz band, the maximum conducted output power over the frequency band of operation shall not exceed 250 mW provided the maximum antenna gain does not exceed 6 dBi. In addition, the maximum power spectral density shall not exceed 11 dBm in any 1 megahertz band. If transmitting antennas of directional gain greater than 6 dBi are used, both the maximum conducted output power and the maximum power spectral density shall be reduced by the amount in dB that the directional gain of the antenna exceeds 6 dBi.

TEST PROCEDURE

Measurements perform using a wideband gated RF power meter provided that the gate parameters are adjusted such that the power is measured only when the EUT is transmitting at its maximum power control level. Since the measurement is made only during the ON time of the transmitter, no duty cycle correction factor is required.

DIRECTIONAL ANTENNA GAIN

The TX chains are uncorrelated and the antenna gain is unequal among the chains. The directional gain is:

Chain 0 Antenna Gain (dBi)	Chain 1 Antenna Gain (dBi)	Uncorrelated Chains Directional Gain (dBi)
3.80	6.70	5.49

The TX chains are correlated and the antenna gain is unequal among the chains. The directional gain is:

Chain 0 Antenna Gain (dBi)	Chain 1 Antenna Gain (dBi)	Correlated Chains Directional Gain (dBi)
3.80	6.70	8.38

RESULTS

ID:	43573	Date:	9/7/16
------------	-------	--------------	--------

Antenna Gain and Limits

Channel	Frequency (MHz)	Directional Gain for Power (dBi)	Directional Gain for PSD (dBi)	Power Limit (dBm)	PSD Limit (dBm)
Low	5180	5.49	8.38	24.00	8.62
Mid	5200	5.49	8.38	24.00	8.62
High	5240	5.49	8.38	24.00	8.62

Duty Cycle CF (dB)	0.00	Included in Calculations of Corr'd PSD
---------------------------	------	---

Output Power Results

Channel	Frequency (MHz)	Chain 0 Meas Power (dBm)	Chain 1 Meas Power (dBm)	Total Corr'd Power (dBm)	Power Limit (dBm)	Power Margin (dB)
Low	5180	12.78	12.86	15.83	24.00	-8.17
Mid	5200	12.89	12.98	15.95	24.00	-8.05
High	5240	12.88	12.99	15.95	24.00	-8.05

PSD Results

Channel	Frequency (MHz)	Chain 0 Meas PSD (dBm)	Chain 1 Meas PSD (dBm)	Total Corr'd PSD (dBm)	PSD Limit (dBm)	PSD Margin (dB)
Low	5180	1.23	1.46	4.35	8.62	-4.27
Mid	5200	1.51	1.81	4.67	8.62	-3.95
High	5240	1.52	1.82	4.68	8.62	-3.94

PSD, CHAIN 0

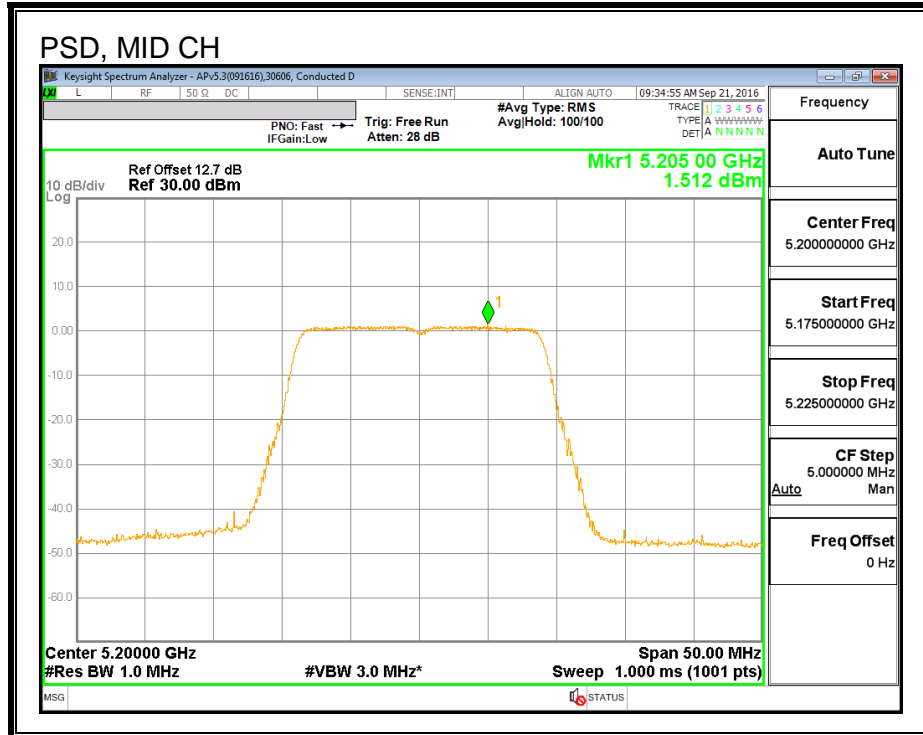
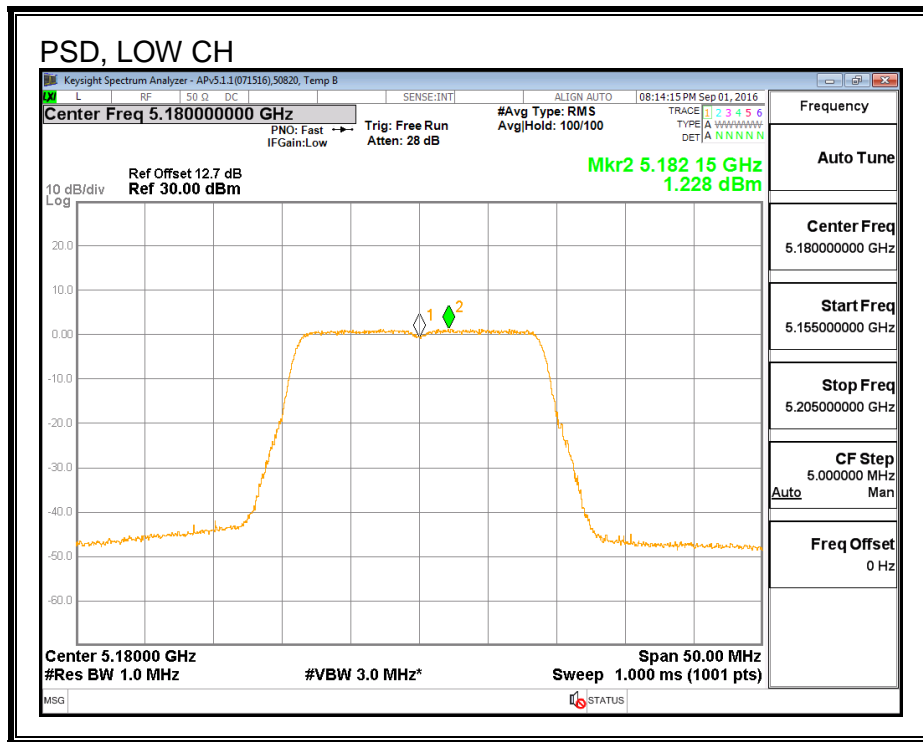

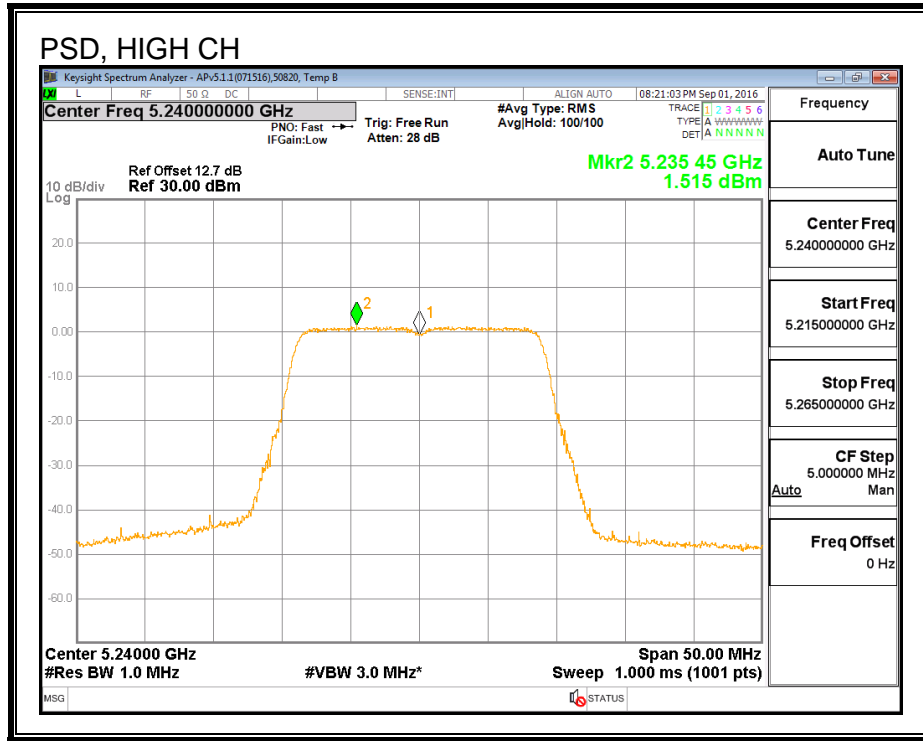

PSD, CHAIN 1

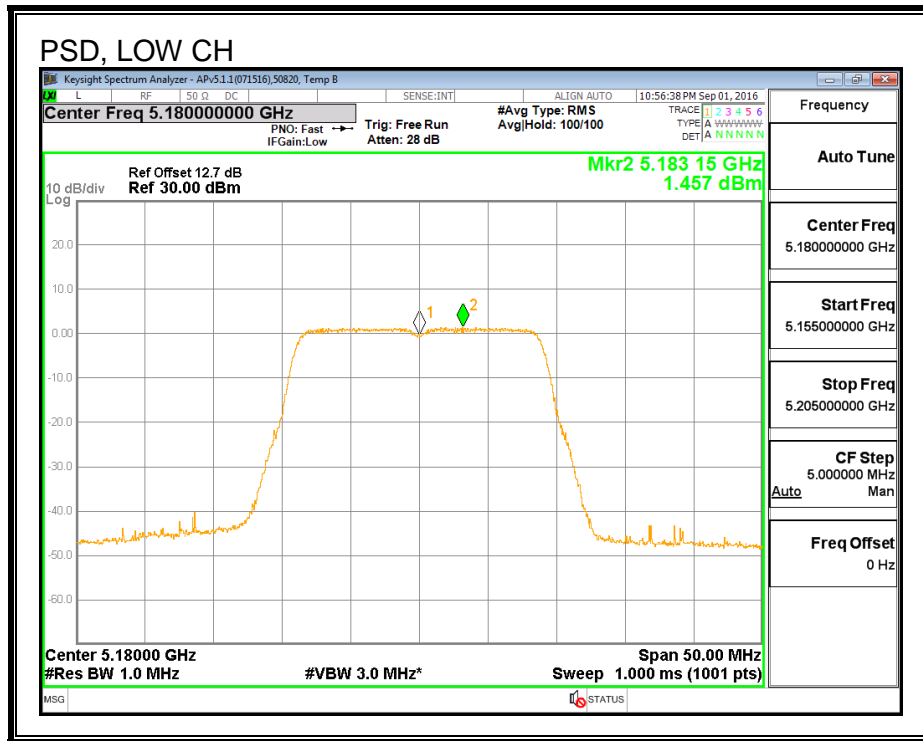

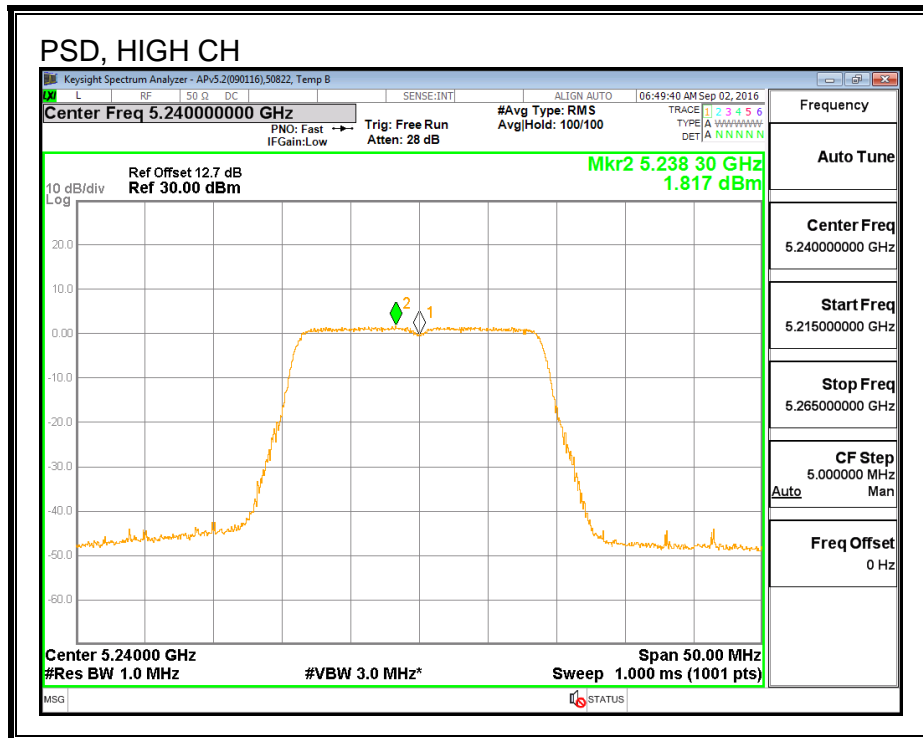
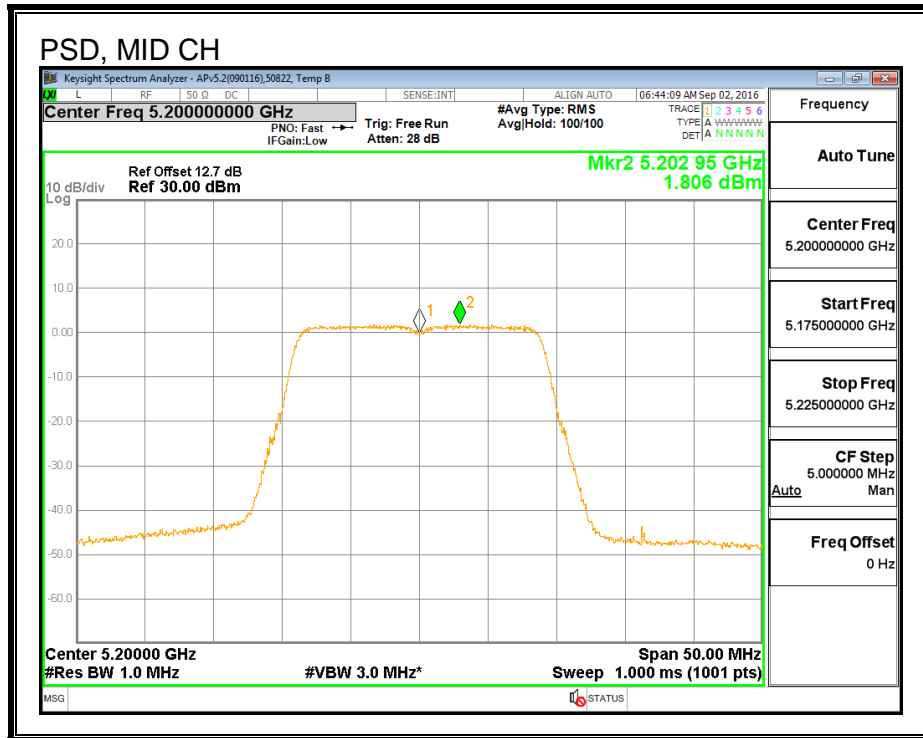

8.4.5. AVERAGE POWER (IC)

LIMITS

None; for reporting purposes only.

TEST PROCEDURE

Measurements perform using a wideband gated RF power meter.

RESULTS

ID:	37289	Date:	9/16/16
------------	-------	--------------	---------

Average Power Results

Channel	Frequency (MHz)	Chain 0 Power (dBm)	Chain 1 Power (dBm)	Total Power (dBm)
Low	5180	5.89	5.88	8.89
Mid	5200	6.00	6.00	9.01
High	5240	5.98	5.99	9.00

8.4.6. OUTPUT POWER AND PSD (IC)

LIMITS

IC RSS-247 (6.2.1) (1)

The maximum e.i.r.p. shall not exceed 200 mW or $10 + 10 \log_{10} B$, dBm, whichever power is less. B is the 99% emission bandwidth in MHz. The e.i.r.p. spectral density shall not exceed 10 dBm in any 1.0 MHz band.

TEST PROCEDURE

Measurements perform using a wideband gated RF power meter provided that the gate parameters are adjusted such that the power is measured only when the EUT is transmitting at its maximum power control level. Since the measurement is made only during the ON time of the transmitter, no duty cycle correction factor is required.

DIRECTIONAL ANTENNA GAIN

The TX chains are uncorrelated and the antenna gain is unequal among the chains. The directional gain is:

Chain 0 Antenna Gain (dBi)	Chain 1 Antenna Gain (dBi)	Uncorrelated Chains Directional Gain (dBi)
3.80	6.70	5.49

The TX chains are correlated and the antenna gain is unequal among the chains. The directional gain is:

Chain 0 Antenna Gain (dBi)	Chain 1 Antenna Gain (dBi)	Correlated Chains Directional Gain (dBi)
3.80	6.70	8.38

RESULTS

ID:	37289	Date:	9/16/16
------------	-------	--------------	---------

Bandwidth and Antenna Gain

Channel	Frequency (MHz)	Min 99% BW (MHz)	Directional Gain for Power (dBi)	Directional Gain for PSD (dBi)
Low	5180	17.739	5.49	8.38
Mid	5200	17.752	5.49	8.38
High	5240	17.753	5.49	8.38

Limits

Channel	Frequency (MHz)	IC EIRP Limit (dBm)	Max IC Power (dBm)	IC eirp PSD Limit (dBm)	Max IC PSD (dBm)
Low	5180	22.49	17.00	10.00	1.62
Mid	5200	22.49	17.00	10.00	1.62
High	5240	22.49	17.00	10.00	1.62

Duty Cycle CF (dB)	0.00	Included in Calculations of Corr'd PSD
---------------------------	------	---

Output Power Results

Channel	Frequency (MHz)	Chain 0 Meas Power (dBm)	Chain 1 Meas Power (dBm)	Total Corr'd Power (dBm)	Power Limit (dBm)	Power Margin (dB)
Low	5180	5.89	5.88	8.89	17.00	-8.11
Mid	5200	6.00	6.00	9.01	17.00	-7.99
High	5240	5.98	5.99	9.00	17.00	-8.01

PSD Results

Channel	Frequency (MHz)	Chain 0 Meas PSD (dBm)	Chain 1 Meas PSD (dBm)	Total Corr'd PSD (dBm)	PSD Limit (dBm)	PSD Margin (dB)
Low	5180	-5.62	-5.51	-2.55	1.62	-4.17
Mid	5200	-5.25	-5.52	-2.37	1.62	-3.99
High	5240	-5.33	-5.23	-2.27	1.62	-3.89