



FCC CFR47 PART 22H, 24E, 27L, AND 90S

CERTIFICATION TEST REPORT

FOR

TABLET DEVICE

MODEL NUMBERS: A1674, A1675

FCC ID: BCGA1674

REPORT NUMBER: 15U22428-E6V2

ISSUE DATE: FEBRUARY 09, 2016

Prepared for

APPLE, INC.

1 INFINITE LOOP

CUPERTINO, CA 95014, U.S.A.

Prepared by

UL VERIFICATION SERVICES INC.

47173 BENICIA STREET

FREMONT, CA 94538, U.S.A.

TEL: (510) 771-1000

FAX: (510) 661-0888



NVLAP LAB CODE 200065-0

Revision History

<u>Rev.</u>	<u>Issue Date</u>	<u>Revisions</u>	<u>Revised By</u>
V1	02/03/2016	Initial Review	C. Pang
V2	02/09/2016	Address TCB's Questions	C. Pang

TABLE OF CONTENTS

1. ATTESTATION OF TEST RESULTS	6
2. TEST METHODOLOGY	7
3. FACILITIES AND ACCREDITATION	7
4. CALIBRATION AND UNCERTAINTY	7
4.1. <i>MEASURING INSTRUMENT CALIBRATION</i>	<i>7</i>
4.2. <i>SAMPLE CALCULATION</i>	<i>8</i>
4.3. <i>MEASUREMENT UNCERTAINTY.....</i>	<i>8</i>
5. EQUIPMENT UNDER TEST	9
5.1. <i>DESCRIPTION OF EUT</i>	<i>9</i>
5.2. <i>DESCRIPTION OF MODELS DIFFERENCES.....</i>	<i>9</i>
5.3. <i>MAXIMUM OUTPUT POWER.....</i>	<i>9</i>
5.3.1. <i>ANTENNA - C.....</i>	<i>9</i>
5.3.1. <i>ANTENNA - D.....</i>	<i>12</i>
5.4. <i>DESCRIPTION OF AVAILABLE ANTENNAS</i>	<i>14</i>
5.5. <i>SOFTWARE AND FIRMWARE.....</i>	<i>14</i>
5.6. <i>WORST-CASE CONFIGURATION AND MODE.....</i>	<i>14</i>
5.7. <i>DESCRIPTION OF TEST SETUP.....</i>	<i>15</i>
6. TEST AND MEASUREMENT EQUIPMENT	17
7. RF POWER OUTPUT VERIFICATION	18
7.1. <i>GSM.....</i>	<i>18</i>
7.1.1. <i>GPRS/EGPRS (ANTENNA - C)</i>	<i>20</i>
7.1.2. <i>GPRS/EGPRS (ANTENNA - D)</i>	<i>20</i>
7.2. <i>CDMA2000.....</i>	<i>21</i>
7.2.1. <i>1XRTT (ANTENNA - C)</i>	<i>22</i>
7.2.2. <i>1XRTT (ANTENNA - D)</i>	<i>26</i>
7.2.3. <i>1xEV-DO - REV 0 (ANTENNA - C)</i>	<i>31</i>
7.2.4. <i>1xEV-DO - REV 0 (ANTENNA - D)</i>	<i>32</i>
7.2.5. <i>1xEV-DO - REV A (ANTENNA - C).....</i>	<i>34</i>
7.2.6. <i>1xEV-DO - REV A (ANTENNA - D).....</i>	<i>35</i>
7.3. <i>UMTS.....</i>	<i>36</i>
7.3.1. <i>UMTS REL99 (ANTENNA - C).....</i>	<i>37</i>
7.3.2. <i>UMTS REL99 (ANTENNA - D).....</i>	<i>37</i>
7.4. <i>HSDPA REL 5</i>	<i>38</i>
7.4.1. <i>HSDPA REL 5 (ANTENNA - C)</i>	<i>39</i>
7.4.2. <i>HSDPA REL 5 (ANTENNA - D)</i>	<i>40</i>
7.5. <i>HSPA REL 6 (HSDPA & HSUPA).....</i>	<i>41</i>
7.5.1. <i>HSPA REL 6 (HSDPA & HSUPA) (ANTENNA - C)</i>	<i>42</i>
7.5.2. <i>HSPA REL 6 (HSDPA & HSUPA) (ANTENNA - D).....</i>	<i>44</i>

7.6.	DUAL CARRIER HSDPA	46
7.6.1.	DUAL CARRIER HSDPA (ANTENNA - C)	48
7.6.2.	DUAL CARRIER HSDPA (ANTENNA - D)	49
8.	CONDUCTED TEST RESULTS	50
8.1.	OCCUPIED BANDWIDTH	50
8.1.1.	GSM GPRS	54
8.1.2.	GSM EGPRS	57
8.1.3.	CDMA2000 1xRTT	60
8.1.4.	CDMA2000 EVDO Rev. A	68
8.1.5.	UMTS REL 99	76
8.1.6.	UMTS HSDPA	82
8.2.	BAND EDGE	88
8.2.1.	GSM-GPRS	89
8.2.2.	GSM-EGPRS	91
8.2.3.	CDMA2000 1xRTT	93
8.2.4.	CDMA2000 1xRTT BC10 MASK	97
8.2.5.	CDMA2000 EVDO REV A	99
8.2.6.	CDMA2000 EVDO REV A BC10 MASK	103
8.2.7.	UMTS REL 99	105
8.2.8.	UMTS HSDPA	108
8.3.	OUT OF BAND EMISSIONS	111
8.3.1.	GSM-GPRS	112
8.3.2.	GSM-EGPRS	115
8.3.3.	CDMA2000 1xRTT	119
8.3.4.	CDMA2000 EVDO REV A	127
8.3.5.	UMTS REL 99	135
8.3.6.	UMTS HSDPA	141
9.	FREQUENCY STABILITY	147
9.1.	GSM	148
9.2.	WCDMA	150
9.3.	CDMA	152
10.	RADIATED TEST RESULTS	154
10.1.	RADIATED POWER (ERP & EIRP) (ANTENNA - C)	154
10.1.1.	GSM	156
10.1.2.	CDMA2000	157
10.1.3.	UMTS	158
10.1.4.	GSM	159
10.1.5.	CDMA2000	163
10.1.6.	UMTS	171
10.2.	RADIATED POWER (ERP & EIRP) (ANTENNA - D)	177
10.2.1.	GSM	177
10.2.2.	CDMA2000	178
10.2.3.	UMTS	179
10.2.4.	GSM	180
10.2.5.	CDMA2000	184
10.2.6.	UMTS	192

10.3.	PEAK-TO-AVERAGE RATIO	198
10.4.	FIELD STRENGTH OF SPURIOUS RADIATION (ANTENNA - C)	210
10.4.1.	GSM.....	212
10.4.2.	CDMA2000.....	216
10.4.3.	UMTS.....	224
10.5.	FIELD STRENGTH OF SPURIOUS RADIATION (ANTENNA - D)	230
10.5.1.	GSM.....	230
10.5.2.	CDMA2000.....	234
10.5.3.	UMTS.....	242
11.	SETUP PHOTOS	248

1. ATTESTATION OF TEST RESULTS

COMPANY NAME: APPLE
1 INFINITE LOOP
CUPERTINO, CA 95014, U.S.A.

EUT DESCRIPTION: TABLET DEVICE

MODELS: A1674, A1675

SERIAL NUMBER: DLXQL00HH0J4 (CONDUCTED); DLXQV014H36N (RADIATED)

DATE TESTED: NOVEMBER 17, 2015 – JANUARY 28, 2016

APPLICABLE STANDARDS	
STANDARD	TEST RESULTS
CFR 47 Part 22H, 24E, 27L, AND 90S	Pass

UL Verification Services Inc. tested the above equipment in accordance with the requirements set forth in the above standards. All indications of Pass/Fail in this report are opinions expressed by UL Verification Services Inc. based on interpretations and/or observations of test results. Measurement Uncertainties were not taken into account and are published for informational purposes only. The test results show that the equipment tested is capable of demonstrating compliance with the requirements as documented in this report.

Note: The results documented in this report apply only to the tested sample, under the conditions and modes of operation as described herein. This document may not be altered or revised in any way unless done so by UL Verification Services Inc. and all revisions are duly noted in the revisions section. Any alteration of this document not carried out by UL Verification Services Inc. will constitute fraud and shall nullify the document. This report must not be used by the client to claim product certification, approval, or endorsement by NVLAP, NIST, any agency of the Federal Government, or any agency of any government.

Approved & Released For
UL Verification Services Inc. By:

Tested By:



CHIN PANG
SENIOR ENGINEER
UL VERIFICATION SERVICES INC.

TINA CHU
EMC LAB TECHNICIAN
UL VERIFICATION SERVICES INC.

2. TEST METHODOLOGY

The tests documented in this report were performed in accordance with TIA-603-D, FCC CFR 47 Part 2, FCC CFR 47 Part 22, FCC CFR Part 24, FCC Part 27 and FCC KDB 971168 D01 v02r02.

3. FACILITIES AND ACCREDITATION

The test sites and measurement facilities used to collect data are located at 47173 and 47266 Benicia Street, Fremont, California, USA. The following table identifies which facilities were utilized for radiated emission measurements documented in this report. Specific facilities are also identified in the test results sections.

47173 Benicia Street	47266 Benicia Street
<input type="checkbox"/> Chamber A	<input checked="" type="checkbox"/> Chamber D
<input type="checkbox"/> Chamber B	<input type="checkbox"/> Chamber E
<input type="checkbox"/> Chamber C	<input checked="" type="checkbox"/> Chamber F
	<input type="checkbox"/> Chamber G
	<input type="checkbox"/> Chamber H

The above test sites and facilities are covered under FCC Test Firm Registration # 208313. Chambers A through H are covered under Industry Canada company address code 2324B with site numbers 2324B -1 through 2324B-8, respectively.

UL Verification Services Inc. is accredited by NVLAP, Laboratory Code 200065-0. The full scope of accreditation can be viewed at <http://ts.nist.gov/standards/scopes/2000650.htm>.

4. CALIBRATION AND UNCERTAINTY

4.1. MEASURING INSTRUMENT CALIBRATION

The measuring equipment utilized to perform the tests documented in this report has been calibrated in accordance with the manufacturer's recommendations, and is traceable to recognized national standards.

4.2. SAMPLE CALCULATION

Where relevant, the following sample calculation is provided:

Field Strength (dBuV/m) = Measured Voltage (dBuV) + Antenna Factor (dB/m) + Cable Loss (dB) – Preamp Gain (dB)

$$36.5 \text{ dBuV} + 18.7 \text{ dB/m} + 0.6 \text{ dB} - 26.9 \text{ dB} = 28.9 \text{ dBuV/m}$$

4.3. MEASUREMENT UNCERTAINTY

Where relevant, the following measurement uncertainty levels have been estimated for tests performed on the apparatus:

PARAMETER	UNCERTAINTY
Conducted Disturbance, 0.15 to 30 MHz	± 3.52 dB
Radiated Disturbance, 30 to 1000 MHz	± 4.94 dB
Radiated Disturbance, 1 to 6 GHz	± 3.86 dB
Radiated Disturbance, 6 to 18 GHz	± 4.23 dB
Radiated Disturbance, 18 to 26 GHz	± 5.30 dB
Radiated Disturbance, 26 to 40 GHz	± 5.23 dB

Uncertainty figures are valid to a confidence level of 95%.

5. EQUIPMENT UNDER TEST

5.1. DESCRIPTION OF EUT

The EUT is a tablet with multimedia functions (music, application support, and video), Cellular GSM/GPRS/EGPRS/CDMA2000 1xRTT/1x Advanced/EVDO Rev. A/WCDMA /HSPA+/DC-HSDPA/LTE FDD & Carrier Aggregation/TDD/TD-SCDMA radio, IEEE 802.11a/b/g/n/ac radio, and Bluetooth radio. The rechargeable battery is not user accessible.

5.2. DESCRIPTION OF MODELS DIFFERENCES

Model tested: A1674. The Models A1674 & A1675 have one FCC ID: BCGA1674 and IC ID: 579C-A1674

Both Model A1674 and A1675 have identical PCB layout, design and functionality, except that A1674 supports second electronic-UICC based SIM or "soft SIM" (called eSIM) beside the regular UICC based SIM and A1675 will come with eSIM removed.

RF and electromagnetic characteristic are independent of the eSIM element. Both models have exactly same technology and band support.

5.3. MAXIMUM OUTPUT POWER

The transmitter has a maximum average conducted and ERP / EIRP output powers as follows:

5.3.1. ANTENNA - C

GSM MODES

Part 22 / RSS 132 850MHz Band

Frequency range (MHz)	Modulation	Conducted (Average)		ERP (Average)	
		dBm	mW	dBm	mW
824- 849	GPRS	33.5	2238.7	31.4	1383.6
	EGPRS	29.0	794.3	24.7	297.2

Part 24 / RSS 133 1900MHz Band

Frequency range (MHz)	Modulation	Conducted (Average)		EIRP (Average)	
		dBm	mW	dBm	mW
1850 - 1910	GPRS	29.5	891.3	32.3	1706.1
	EGPRS	28.0	631.0	29.1	809.1

CDMA2000 MODES

Part 90 800MHz Band

Frequency range (MHz)	Modulation	Conducted (Average)		ERP (Average)	
		dBm	mW	dBm	mW
816 - 824	CDMA 2000 1xRTT	25.0	316.2	23.7	235.5
	CDMA 2000 EVDO-Rev A	25.0	316.2	23.8	237.1

Part 22 / RSS 132 850MHz Band

Frequency range (MHz)	Modulation	Conducted (Average)		ERP (Average)	
		dBm	mW	dBm	mW
824 – 849	CDMA 2000 1xRTT	24.5	281.8	24.7	292.4
	CDMA 2000 EVDO-Rev A	24.5	281.8	24.7	294.4

Part 24 / RSS 133 1900MHz Band

Frequency range (MHz)	Modulation	Conducted (Average)		EIRP (Average)	
		dBm	mW	dBm	mW
1850 – 1910	CDMA 2000 1xRTT	24.5	281.8	27.7	583.4
	CDMA 2000 EVDO-Rev A	24.5	281.8	27.7	587.5

Part 27 / RSS 139 1700MHz Band

Frequency range (MHz)	Modulation	Conducted (Average)		EIRP (Average)	
		dBm	mW	dBm	mW
1710 – 1755	CDMA 2000 1xRTT	24.5	281.8	26.8	483.1
	CDMA 2000 EVDO-Rev A	24.5	281.8	26.9	485.3

UMTS MODES

Part 22 / RSS 132 850MHz Band

Frequency range (MHz)	Modulation	Conducted (Average)		ERP (Average)	
		dBm	mW	dBm	mW
824 – 849	REL 99	25.0	316.2	23.7	233.3
	HSDPA REL 5	24.0	251.2	22.7	187.9

Part 24 / RSS 133 1900MHz Band

Frequency range (MHz)	Modulation	Conducted (Average)		EIRP (Average)	
		dBm	mW	dBm	mW
1850 – 1910	REL 99	24.5	281.8	27.2	526.0
	HSDPA REL 5	23.5	223.9	26.3	422.7

Part 27 / RSS 139 1700MHz Band

Frequency range (MHz)	Modulation	Conducted (Average)		EIRP (Average)	
		dBm	mW	dBm	mW
1710– 1755	REL 99	24.5	281.8	25.7	373.3
	HSDPA REL 5	23.5	223.9	24.9	306.9

5.3.1. ANTENNA - D

GSM MODES

Part 22 / RSS 132 850MHz Band

Frequency range (MHz)	Modulation	Conducted (Average)		ERP (Average)	
		dBm	mW	dBm	mW
824- 849	GPRS	32.0	1584.9	29.7	922.6
	EGPRS	27.0	501.2	24.5	284.4

Part 24 / RSS 133 1900MHz Band

Frequency range (MHz)	Modulation	Conducted (Average)		EIRP (Average)	
		dBm	mW	dBm	mW
1850 - 1910	GPRS	27.5	562.3	28.0	633.9
	EGPRS	25.0	316.2	26.9	484.2

CDMA2000 MODES

Part 90 800MHz Band

Frequency range (MHz)	Modulation	Conducted (Average)		ERP (Average)	
		dBm	mW	dBm	mW
816 - 824	CDMA 2000 1xRTT	23.5	223.9	21.6	144.5
	CDMA 2000 EVDO-Rev A	23.5	223.9	21.8	150.3

Part 22 / RSS 132 850MHz Band

Frequency range (MHz)	Modulation	Conducted (Average)		ERP (Average)	
		dBm	mW	dBm	mW
824 - 849	CDMA 2000 1xRTT	23.5	223.9	21.6	145.9
	CDMA 2000 EVDO-Rev A	23.5	223.9	21.7	147.9

Part 24 / RSS 133 1900MHz Band

Frequency range (MHz)	Modulation	Conducted (Average)		EIRP (Average)	
		dBm	mW	dBm	mW
1850 - 1910	CDMA 2000 1xRTT	22.0	158.5	23.5	221.3
	CDMA 2000 EVDO-Rev A	22.0	158.5	23.5	223.4

Part 27 / RSS 139 1700MHz Band

Frequency range (MHz)	Modulation	Conducted (Average)		EIRP (Average)	
		dBm	mW	dBm	mW
1710 - 1755	CDMA 2000 1xRTT	22.0	158.5	21.1	127.4
	CDMA 2000 EVDO-Rev A	22.0	158.5	21.2	131.8

UMTS MODES

Part 22 / RSS 132 850MHz Band

Frequency range (MHz)	Modulation	Conducted (Average)		ERP (Average)	
		dBm	mW	dBm	mW
824 – 849	REL 99	23.5	223.9	21.5	142.6
	HSDPA REL 5	22.5	177.8	20.6	115.9

Part 24 / RSS 133 1900MHz Band

Frequency range (MHz)	Modulation	Conducted (Average)		EIRP (Average)	
		dBm	mW	dBm	mW
1850 – 1910	REL 99	22.0	158.5	22.5	177.0
	HSDPA REL 5	21.0	125.9	21.6	143.2

Part 27 / RSS 139 1700MHz Band

Frequency range (MHz)	Modulation	Conducted (Average)		EIRP (Average)	
		dBm	mW	dBm	mW
1710– 1755	REL 99	22.0	158.5	22.1	162.9
	HSDPA REL 5	20.9	123.0	21.2	132.7

5.4. DESCRIPTION OF AVAILABLE ANTENNAS

Frequency (MHz)	Port A (ANTENNA - C) Antenna Gain (dBi)	Port B (ANTENNA - D) Antenna Gain (dBi)
816 - 824	1.21	1.1
824 - 849	1.21	1.1
1850 - 1910	1.63	0.82
1710 - 1755	-0.44	-0.4

5.5. SOFTWARE AND FIRMWARE

The EUT firmware installed during testing was version 13E31820k Baseband 1.56.02.
The EUT is linked with Agilent 8960 and CMW500 Communication Test Sets.

5.6. WORST-CASE CONFIGURATION AND MODE

The worst-case is EUT on the highest power. Based on Peak Power measurement investigations, the following modes should be considered as worst-case scenario for all other measurements.

Worst-case modes:

- GSM GPRS
- GSM EGPRS
- CDMA 2000 1xRTT
- CDMA 2000 EVDO REV. A
- UMTS REL 99
- UMTS HSDPA

The fundamental of the EUT was investigated in three orthogonal orientations X/Y/Z, it was determined that X-flatbed orientation was worst-case orientation for cell bands without AC/DC adapter and headset; X-flatbed orientation was worst-case orientation for pcs bands without AC/DC adapter and headset.

For simultaneous transmission of multiple channels from the same antenna in the 2.4GHz and Cellular bands, tests were conducted for various configurations having the highest power, least separation in frequencies and widest operation bandwidths. No noticeable new emission was found. Simultaneous transmission does not support BT/BLE high power mode.

5.7. DESCRIPTION OF TEST SETUP

SUPPORT EQUIPMENT

Support Equipment List			
Description	Manufacturer	Model	Serial Number
Laptop	Dell	Latitude D630	N/A
AC/DC adapter	Dell	PA-1900-02D	N/A
DC power supply	Sorensen	XT20-3	N/A

I/O CABLES (RF Conducted Test)

I/O Cable List						
Cable No	Port	# of identical ports	Connector Type	Cable Type	Cable Length (m)	Remarks
1	AC	1	US 115V	Un-shielded	2m	N/A
2	DC	1	DC	Un-shielded	1.4m	N/A
3	RF In/Out	1	EUT	Un-shielded	0.4m	N/A
4	RF In/Out	1	Barrel	N/A	N/A	N/A
5	RF In/Out	1	Communication Test Set	Un-shielded	1m	N/A

I/O CABLES (RF Radiated Test)

I/O Cable List						
Cable No	Port	# of identical ports	Connector Type	Cable Type	Cable Length (m)	Remarks
1	RF In/Out	1	Antenna	Un-shielded	5m	NA

TEST SETUP

CONDUCTED SETUP

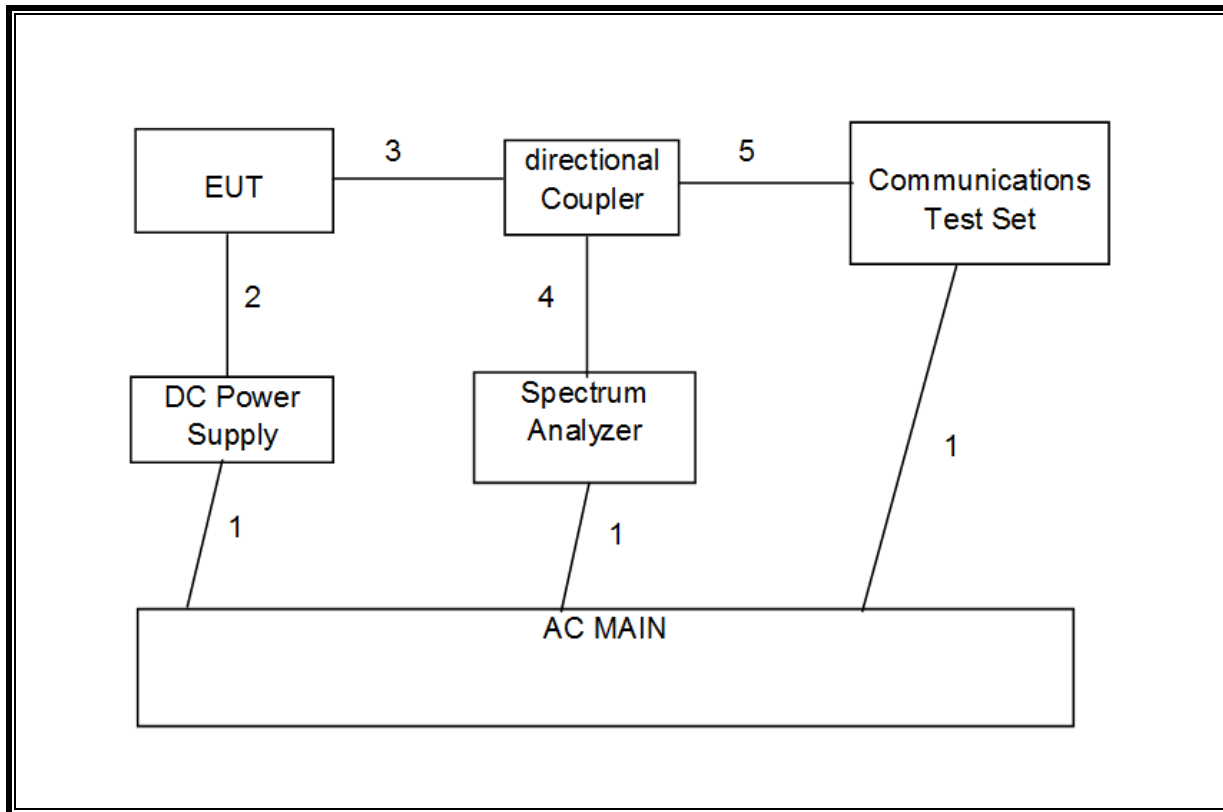

RADIATED SETUP

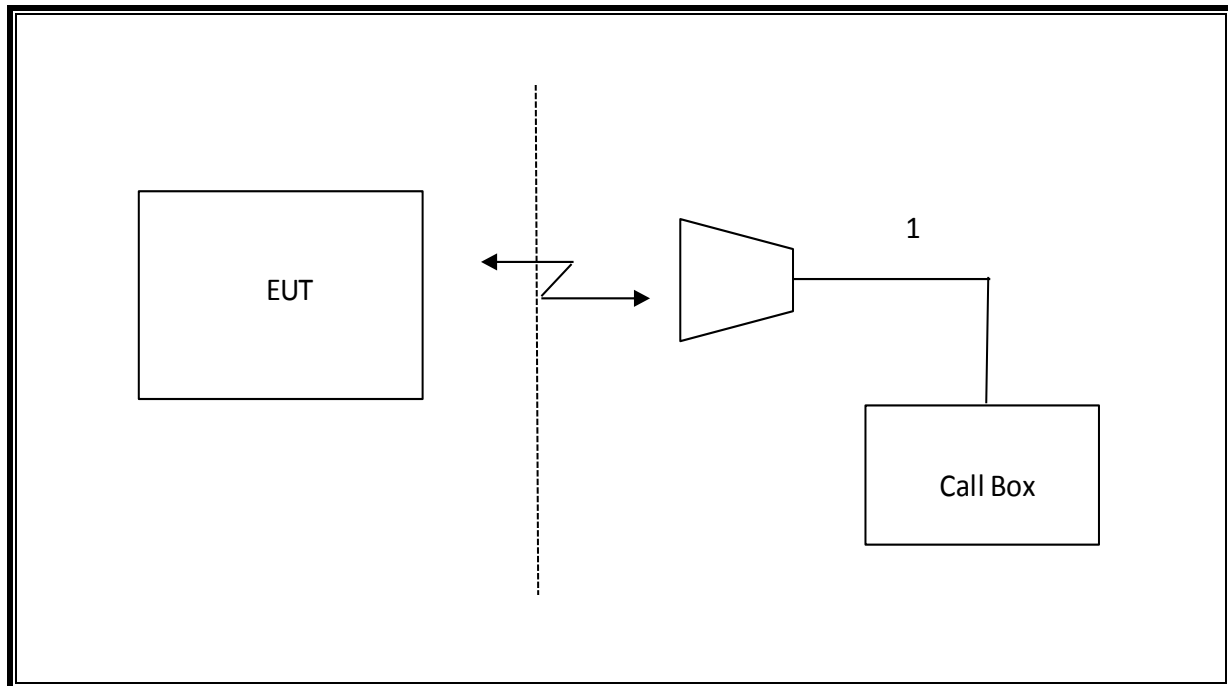

6. TEST AND MEASUREMENT EQUIPMENT

The following test and measurement equipment was utilized for the tests documented in this report:

TEST EQUIPMENT LIST				
Description	Manufacturer	Model	T No.	Cal Due
Spectrum Analyzer, PSA, 3Hz to 44GHz	Keysight	E4446A	T177	03/07/16
Wideband Communication Test Set, Call Box	Rohde & Schwarz	CMW500	T971	07/23/16
Directional Coupler, 10dB SMA, 0.5GHz to 26.5GHz	Krytar	152610	T922	06/10/16
Chamber, Environmental	Cincinnati Sub Zero	ZPHS-8-3.5-SCT/WC	T754	03/21/16
Wideband Communication Test Set, Call Box	Rohde & Schwarz	CMW500	T703	02/11/16
Wireless Communications Test Set, 8960 Series 10	Keysight	E5515C	T211	11/19/16
Spectrum Analyzer, PXA, 3Hz to 44GHz	Keysight	N9030A	T905	05/26/16
Antenna, Horn 1-18GHz	ETS Lindgren	3117	T344	02/10/16
Antenna, Broadband Hybrid, 30MHz to 2000MHz	Sunol Sciences	JB3	T407	03/05/16
Amplifier, 1 - 18GHz	Miteq	AFS42-00101800-25-S-42	T740	01/26/16
Amplifier, 10KHz to 1GHz, 32dB	Sonoma	310N	T286	05/07/16
Wideband Communication Test Set, Call Box	Rohde & Schwarz	CMW500	T260	07/10/16
Spectrum Analyzer, PXA, 3Hz to 44GHz	Keysight	N9030A	T340	11/16/16
Antenna, Horn 1-18GHz	ETS Lindgren	3117	T120	03/26/16
Antenna, Broadband Hybrid, 30MHz to 2000MHz	Sunol Sciences	JB3	T407	03/05/16
Amplifier, 1 - 18GHz	Miteq	AFS42-00101800-25-S-42	T742	01/31/16
Amplifier, 10KHz to 1GHz, 32dB	Sonoma	310N	T173	06/09/16
Spectrum Analyzer, PXA, 3Hz to 44GHz	Keysight	N9030A	T341	10/15/16
Antenna, Horn 18 to 26.5GHz	ARA	MWH-1826	T447	05/12/16
Amplifier, 1 to 26.5GHz, 23.5dB Gain minimum	Agilent	8449B	T404	06/29/16
Spectrum Analyzer, 40 GHz	Agilent	8564E	T106	08/06/16
Tuned Dipole, 400 - 1000MHz	ETS Lindgren	3121C DB4	T273	05/05/16
Antenna, Horn 1-18GHz	Emco	3115	T59	11/18/16
Filter, Highpass 4.0GHz	Micro-Tronics	HPM13351	T1239	06/24/16
Filter, HPF 1.2GHz	Wainwright Instruments	WHKX1.2/15G-6ST	T1182	04/24/16
*Filter, HPF 3.0GHz	Micro-Tronics	HPM17543	T428	01/26/16

*Testing is completed before equipment expiration date.

7. RF POWER OUTPUT VERIFICATION

7.1. GSM

Using CMU200 Communication Test Set

Function: Menu select > GSM Mobile Station > GSM 850/900/1800/1900

Press **Connection control** to choose the different menus

Press **RESET** > choose all to reset all settings

Connection	Press Signal Off to turn off the signal and change settings Network Support > GSM+GPRS or GSM+EGPRS Main Service > Packet Data Service selection > Test Mode A – Auto Slot Config. off
MS Signal	Press Slot Config bottom on the right twice to select and change the number of time slots and power setting > Slot configuration > Uplink/Gamma > 33 dBm for GPRS 850/900 > 27 dBm for EGPRS 850/900 > 30 dBm for GPRS1800/1900 > 26 dBm for EGPRS1800/1900
BS Signal	Enter the same channel number for TCH channel (test channel) and BCCH channel Frequency Offset > + 0 Hz Mode > BCCH and TCH BCCH Level > -85 dBm (May need to adjust if link is not stable) BCCH Channel > choose desire test channel [Enter the same channel number for TCH channel (test channel) and BCCH channel] Channel Type > Off P0> 4 dB Slot Config > Unchanged (if already set under MS Signal) TCH > choose desired test channel Hopping > Off Main Timeslot > 3 (Default)
Network	Coding Scheme > CS 4 (GPRS) and MCS5-9 (EGPRS) Bit Stream > 2E9-1PSR Bit Pattern
AF/RF	Enter appropriate offsets for Ext. Att. Output and Ext. Att. Input
Connection	Press Signal On to turn on the signal and change settings

Using Agilent 8960A Communication Test Set

System Config: GSM/GPRS Mobile Test
E1968A A.06.31

Call Params: BCH → Cell Band: GSM850/PCS
TCH → Traffic Band: GSM850/PCS
Traffic Channel: 128/192/251 or 512/661/810
MS Tx Level: 0
PDTCH → Traffic Band: GSM850/PCS
Traffic Channel: 128/192/251 512/661/810
MS Tx Level: 0
Coding Scheme: CS-4 (GPRS)
Coding Scheme: MCS-5 to 9 (EGPRS)
MultiSlot Config: 1 up, 1 down (Assuming that the highest
conducted power)

Control: Active Cell → GSM/GPRS

7.1.1. GPRS/EGPRS (ANTENNA - C)

Mode	Ch.	f (MHz)	1 time slot		2 time slots	
			Peak (dBm)	Average (dBm)	Peak (dBm)	Average (dBm)
GPRS	128	824.2	34.0	33.5	32.5	32.0
	190	836.6	34.0	33.4	32.4	31.8
	251	848.8	34.0	33.5	32.4	31.9
EGPRS	128	824.2	32.2	28.7	32.1	28.6
	190	836.6	32.5	29.0	32.5	28.8
	251	848.8	32.3	28.9	32.5	28.9
GPRS	512	1850.2	29.9	29.5	29.8	29.4
	661	1880.0	29.8	29.5	29.8	29.4
	810	1909.8	29.9	29.5	29.7	29.3
EGPRS	512	1850.2	32.0	28.0	31.8	27.8
	661	1880.0	32.0	28.0	31.6	27.8
	810	1909.8	32.0	27.9	31.0	27.8

7.1.2. GPRS/EGPRS (ANTENNA - D)

Mode	Ch.	f (MHz)	1 time slot		2 time slots	
			Peak (dBm)	Average (dBm)	Peak (dBm)	Average (dBm)
GPRS	128	824.2	32.5	32.0	30.9	30.5
	190	836.6	32.3	31.9	30.8	30.4
	251	848.8	31.7	31.3	30.8	30.3
EGPRS	128	824.2	30.6	27.0	30.5	26.9
	190	836.6	30.4	26.9	30.3	26.8
	251	848.8	30.1	26.8	30.2	26.8
GPRS	512	1850.2	27.9	27.4	26.9	26.5
	661	1880.0	28.0	27.5	26.9	26.4
	810	1909.8	27.8	27.4	26.8	26.4
EGPRS	512	1850.2	28.7	24.9	28.6	24.8
	661	1880.0	28.8	25.0	28.6	24.8
	810	1909.8	28.5	24.8	28.4	24.8

7.2. CDMA2000

Maximum output power is verified on the Low, Middle and High channels according to procedures in section 4.4.5.2 of 3GPP2 C.S0011/TIA-98-E for 1xRTT, section 3.1.2.3.4 of 3GPP2 C.S0033-0/TIA-866 for Rel. 0 and section 4.3.4 of 3GPP2 C.S0033-A for Rev. A

CDMA2000 1xRTT

This procedure assumes the Agilent 8960 Test Set has the following applications installed and with valid license.

<u>Application</u>	<u>Rev, License</u>
CDMA2000 Mobile Test	B.15.18, L

- Protocol Rev > 6 (IS-2000-0)
- System ID: 18; NID: 65535, Reg. Ch. #: 610 for Cell, 600 for PCS & 450 for AWS
- Radio Config (RC) > RC1 or RC3
- Service Option (SO) Setup > SO55 or SO32
- Traffic Data Rate > Full
- Rvs Power Ctrl > All Up bits (Maximum TxPout)

RESULT

7.2.1. 1XR TT (ANTENNA - C)

1xRTT, BC10, SECONDARY 800

Radio Configuration (RC)	Service Option (SO)	Conducted Output Power (dBm)					
		CH 450 - 817.25MHz		CH 560 - 820MHz		CH 670 - 822.75MHz	
		Peak	Average	Peak	Average	Peak	Average
RC1	2 (Loopback)	29.0	25.0	28.6	24.9	28.8	24.9
	55 (Loopback)	29.0	24.9	28.6	24.8	28.8	24.9
RC2	9 (Loopback)	29.0	24.9	28.6	24.9	28.5	24.9
	55 (Loopback)	29.0	24.9	28.6	24.9	28.6	24.9
RC3	2 (Loopback)	28.8	24.9	28.4	24.8	28.4	24.9
	55 (Loopback)	28.8	24.9	28.5	24.9	28.4	24.9
	32 (+ F-SCH)	28.8	24.9	28.5	24.9	28.4	24.9
	32 (+ SCH)	28.8	24.9	28.5	24.9	28.6	24.9
RC4	2 (Loopback)	28.8	24.9	28.4	24.9	28.6	24.9
	55 (Loopback)	28.8	24.9	28.5	24.9	28.6	24.9
	32 (+ F-SCH)	28.7	24.9	28.5	24.9	28.6	24.9
	32 (+ SCH)	28.8	24.9	28.5	24.9	28.6	24.9
RC5	9 (Loopback)	28.8	24.9	28.5	24.9	28.6	24.9
	55 (Loopback)	28.8	24.9	28.5	24.9	28.6	24.8
RC11	2 (Loopback)	28.8	25.0	28.5	25.0	28.4	25.0
	75 (Loopback)	28.8	24.9	28.5	25.0	28.4	25.0
	32 (+ F-SCH)	28.8	24.9	28.5	24.9	28.5	25.0
	32 (+ SCH)	28.8	25.0	28.5	25.0	28.6	25.0

1xRTT, BC0, CELL BAND

Radio Configuration (RC)	Service Option (SO)	Conducted Output Power (dBm)					
		CH 1013 - 824.7MHz		CH 384 - 836.52MHz		CH 777 - 848.31MHz	
		Peak	Average	Peak	Average	Peak	Average
RC1	2 (Loopback)	29.6	24.4	29.7	24.3	29.0	24.5
	55 (Loopback)	29.7	24.4	29.5	24.3	29.0	24.4
RC2	9 (Loopback)	29.6	24.3	29.7	24.3	28.9	24.4
	55 (Loopback)	29.5	24.4	29.5	24.3	29.0	24.4
RC3	2 (Loopback)	28.7	24.4	28.8	24.4	28.7	24.4
	55 (Loopback)	28.8	24.4	28.8	24.4	28.7	24.4
	32 (+ F-SCH)	28.8	24.4	28.8	24.4	28.7	24.5
	32 (+ SCH)	28.8	24.4	28.7	24.3	28.7	24.5
RC4	2 (Loopback)	28.8	24.4	28.8	24.4	28.7	24.4
	55 (Loopback)	28.8	24.4	28.8	24.3	28.7	24.4
	32 (+ F-SCH)	28.8	24.4	28.7	24.4	28.7	24.5
	32 (+ SCH)	28.8	24.4	28.8	24.4	28.7	24.5
RC5	9 (Loopback)	28.8	24.4	28.8	24.5	28.8	24.5
	55 (Loopback)	28.8	24.3	28.8	24.3	28.7	24.4
RC11	2 (Loopback)	28.9	24.4	28.9	24.5	28.8	24.5
	75 (Loopback)	28.9	24.4	28.8	24.4	28.7	24.5
	32 (+ F-SCH)	28.8	24.4	28.9	24.4	28.8	24.5
	32 (+ SCH)	28.8	24.5	28.9	24.5	28.8	24.5

1xRTT, BC1, PCS BAND

Radio Configuration (RC)	Service Option (SO)	Conducted Output Power (dBm)					
		CH 25 - 1851.25MHz		CH 600 - 1880MHz		CH 1175 - 1908.75MHz	
		Peak	Average	Peak	Average	Peak	Average
RC1	2 (Loopback)	28.5	24.3	28.9	24.5	28.8	24.3
	55 (Loopback)	28.5	24.3	28.7	24.4	28.7	24.2
RC2	9 (Loopback)	28.5	24.3	28.7	24.4	28.5	24.3
	55 (Loopback)	28.5	24.3	28.7	24.5	28.6	24.2
RC3	2 (Loopback)	28.3	24.4	28.4	24.4	28.1	24.3
	55 (Loopback)	28.2	24.3	28.4	24.5	28.3	24.4
	32 (+ F-SCH)	28.2	24.3	28.5	24.5	28.1	24.3
	32 (+ SCH)	28.2	24.4	28.4	24.5	28.3	24.3
RC4	2 (Loopback)	28.2	24.3	28.4	24.5	28.2	24.3
	55 (Loopback)	28.3	24.3	28.4	24.5	28.1	24.3
	32 (+ F-SCH)	28.3	24.3	28.5	24.5	28.1	24.3
	32 (+ SCH)	28.3	24.4	28.4	24.4	28.2	24.3
RC5	9 (Loopback)	28.2	24.3	28.3	24.5	28.1	24.3
	55 (Loopback)	28.2	24.3	28.4	24.5	28.1	24.3
RC11	2 (Loopback)	28.2	24.3	28.4	24.5	28.3	24.3
	75 (Loopback)	28.2	24.4	28.4	24.5	28.4	24.3
	32 (+ F-SCH)	28.2	24.4	28.4	24.5	28.2	24.3
	32 (+ SCH)	28.3	24.3	28.5	24.4	28.2	24.3

1xRTT, BC15, AWS BAND

Radio Configuration (RC)	Service Option (SO)	Conducted Output Power (dBm)					
		CH 25 - 1711.25MHz		CH 450 - 1732.5MHz		CH 875 - 1753.75MHz	
		Peak	Average	Peak	Average	Peak	Average
RC1	2 (Loopback)	29.0	24.5	29.1	24.3	29.2	24.4
	55 (Loopback)	28.9	24.4	29.0	24.3	29.1	24.3
RC2	9 (Loopback)	28.9	24.4	29.1	24.2	29.1	24.4
	55 (Loopback)	28.8	24.4	29.1	24.3	29.1	24.4
RC3	2 (Loopback)	28.4	24.4	28.3	24.3	28.5	24.4
	55 (Loopback)	28.4	24.4	28.3	24.3	28.5	24.4
	32 (+ F-SCH)	28.5	24.4	28.3	24.3	28.6	24.4
	32 (+ SCH)	28.5	24.4	28.4	24.3	28.6	24.4
RC4	2 (Loopback)	28.4	24.4	28.3	24.3	28.5	24.4
	55 (Loopback)	28.5	24.5	28.3	24.3	28.5	24.4
	32 (+ F-SCH)	28.4	24.4	28.3	24.3	28.5	24.4
	32 (+ SCH)	28.5	24.4	28.3	24.3	28.5	24.4
RC5	9 (Loopback)	28.4	24.4	28.2	24.3	28.5	24.4
	55 (Loopback)	28.5	24.4	28.2	24.3	28.5	24.4
*RC11	2 (Loopback)	28.4	24.4	28.3	24.3	28.6	24.4
	75 (Loopback)	28.6	24.5	28.2	24.3	28.6	24.4
	32 (+ F-SCH)	28.6	24.4	28.4	24.3	28.6	24.4
	32 (+ SCH)	28.5	24.5	28.3	24.3	28.6	24.4

7.2.2. 1XR TT (ANTENNA - D)

1xRTT, BC10, SECONDARY 800

Radio Configuration (RC)	Service Option (SO)	Conducted Output Power (dBm)					
		CH 450 - 817.25MHz		CH 560 - 820MHz		CH 670 - 822.75MHz	
		Peak	Average	Peak	Average	Peak	Average
RC1	2 (Loopback)	28.5	23.5	28.2	23.3	28.1	23.4
	55 (Loopback)	28.3	23.4	28.1	23.3	28.1	23.5
RC2	9 (Loopback)	28.3	23.4	28.1	23.3	28.0	23.4
	55 (Loopback)	28.4	23.4	28.1	23.3	28.1	23.4
RC3	2 (Loopback)	27.7	23.4	27.6	23.3	27.5	23.4
	55 (Loopback)	27.6	23.4	27.5	23.3	27.5	23.4
	32 (+ F-SCH)	27.6	23.4	27.6	23.3	27.7	23.4
	32 (+ SCH)	28.5	23.4	27.6	23.3	27.7	23.4
RC4	2 (Loopback)	27.7	23.4	27.6	23.3	27.7	23.4
	55 (Loopback)	27.7	23.4	27.6	23.3	27.7	23.4
	32 (+ F-SCH)	27.6	23.4	27.6	23.3	27.7	23.5
	32 (+ SCH)	28.5	23.4	28.2	23.4	27.6	23.4
RC5	9 (Loopback)	27.6	23.4	27.6	23.3	27.7	23.5
	55 (Loopback)	27.6	23.4	27.7	23.3	27.7	23.5
RC11	2 (Loopback)	27.7	23.5	27.7	23.4	27.8	23.5
	75 (Loopback)	27.6	23.5	27.5	23.4	27.8	23.5
	32 (+ F-SCH)	27.6	23.5	27.6	23.4	27.8	23.5
	32 (+ SCH)	27.7	23.5	27.7	23.4	27.8	23.5

1xRTT, BC0, CELL BAND

Radio Configuration (RC)	Service Option (SO)	Conducted Output Power (dBm)					
		CH 1013 - 824.7MHz		CH 384 - 836.52MHz		CH 777 - 848.31MHz	
		Peak	Average	Peak	Average	Peak	Average
RC1	2 (Loopback)	28.9	23.5	28.6	23.3	28.7	23.4
	55 (Loopback)	28.8	23.4	28.6	23.4	28.6	23.4
RC2	9 (Loopback)	28.8	23.4	28.5	23.3	28.6	23.4
	55 (Loopback)	28.8	23.4	28.7	23.4	28.6	23.3
RC3	2 (Loopback)	27.9	23.4	28.0	23.4	27.9	23.4
	55 (Loopback)	27.9	23.4	27.9	23.4	28.0	23.4
	32 (+ F-SCH)	28.0	23.4	28.0	23.4	28.0	23.4
	32 (+ SCH)	28.0	23.4	27.9	23.4	27.9	23.4
RC4	2 (Loopback)	27.9	23.4	27.9	23.4	28.1	23.3
	55 (Loopback)	28.0	23.4	27.8	23.4	28.2	23.4
	32 (+ F-SCH)	27.9	23.4	27.9	23.4	28.2	23.4
	32 (+ SCH)	27.9	23.4	27.9	23.4	28.8	23.5
RC5	9 (Loopback)	28.0	23.4	27.9	23.4	28.0	23.4
	55 (Loopback)	27.9	23.4	27.8	23.4	28.0	23.4
RC11	2 (Loopback)	28.0	23.5	27.9	23.5	28.0	23.5
	75 (Loopback)	28.0	23.5	27.9	23.4	28.2	23.5
	32 (+ F-SCH)	28.0	23.5	28.1	23.5	28.2	23.5
	32 (+ SCH)	28.0	23.5	27.9	23.5	28.1	23.5

1xRTT, BC1, PCS BAND

Radio Configuration (RC)	Service Option (SO)	Conducted Output Power (dBm)					
		CH 25 - 1851.25MHz		CH 600 - 1880MHz		CH 1175 - 1908.75MHz	
		Peak	Average	Peak	Average	Peak	Average
RC1	2 (Loopback)	26.6	21.7	26.9	22.0	26.7	21.8
	55 (Loopback)	26.8	21.9	26.8	21.9	26.8	21.9
RC2	9 (Loopback)	26.5	21.7	26.5	21.9	26.8	21.7
	55 (Loopback)	26.5	21.7	26.5	21.9	26.8	21.7
RC3	2 (Loopback)	25.8	21.7	25.9	21.9	25.9	21.7
	55 (Loopback)	25.7	21.7	25.8	21.9	25.9	21.7
	32 (+ F-SCH)	25.8	21.7	25.8	21.9	25.9	21.8
	32 (+ SCH)	25.7	21.8	25.8	21.9	25.9	21.8
RC4	2 (Loopback)	25.8	21.7	25.8	21.9	25.5	21.7
	55 (Loopback)	25.8	21.7	25.9	21.9	25.6	21.7
	32 (+ F-SCH)	25.8	21.7	25.8	21.9	25.7	21.8
	32 (+ SCH)	25.7	21.8	25.8	21.9	25.5	21.8
RC5	9 (Loopback)	25.7	21.7	25.9	21.9	25.5	21.8
	55 (Loopback)	25.7	21.8	25.8	21.9	25.9	21.7
RC11	2 (Loopback)	25.8	21.8	25.9	22.0	25.4	21.8
	75 (Loopback)	25.8	21.8	25.9	21.8	26.2	21.8
	32 (+ F-SCH)	25.8	21.8	25.9	22.0	25.9	21.9
	32 (+ SCH)	25.8	21.8	25.9	22.0	25.8	21.8

1xRTT, BC15, AWS BAND

Radio Configuration (RC)	Service Option (SO)	Conducted Output Power (dBm)					
		CH 25 - 1711.25MHz		CH 450 - 1732.5MHz		CH 875 - 1753.75MHz	
		Peak	Average	Peak	Average	Peak	Average
RC1	2 (Loopback)	26.4	21.7	26.8	22.0	26.8	21.8
	55 (Loopback)	26.5	21.8	25.2	21.9	26.8	21.8
RC2	9 (Loopback)	26.3	21.7	26.0	21.8	26.8	21.8
	55 (Loopback)	26.4	21.7	26.1	21.9	26.7	21.7
RC3	2 (Loopback)	25.9	21.8	25.0	21.9	26.1	21.9
	55 (Loopback)	25.8	21.8	25.0	21.9	26.0	21.8
	32 (+ F-SCH)	25.9	21.8	25.1	21.9	26.0	21.9
	32 (+ SCH)	25.9	21.8	25.0	21.9	26.1	21.9
RC4	2 (Loopback)	25.8	21.8	25.1	21.9	26.1	21.9
	55 (Loopback)	25.8	21.8	25.1	21.9	26.2	21.9
	32 (+ F-SCH)	25.8	21.8	25.1	21.9	26.1	21.8
	32 (+ SCH)	25.9	21.8	25.1	21.9	26.1	21.9
RC5	9 (Loopback)	25.9	21.9	25.1	21.9	26.0	21.8
	55 (Loopback)	25.8	21.8	25.1	21.9	26.0	21.8
*RC11	2 (Loopback)	25.8	21.9	25.1	22.0	26.2	21.9
	75 (Loopback)	25.8	21.9	25.0	21.9	26.2	21.9
	32 (+ F-SCH)	26.0	21.9	25.0	21.9	26.1	21.9
	32 (+ SCH)	25.8	21.9	25.1	22.0	26.2	21.9

1xEV-DO - Release 0 (REV 0)

This procedure assumes the Agilent 8960 Test Set has the following applications installed and with valid license.

EVDO Release 0 - RTAP

- Call Setup > Shift & Preset
- Call Control:
 - Access Network Info > Cell Parameters > Sector ID > 00000000 : 00000000 : 00000000 : 00000000 > Subnet Mask > 0
 - Generator Info > Termination Parameters > Max Forward Packet Duration > 16 Slots
- Call Params:
 - Cell Power > -105.5 dBm/1.23 MHz
 - Channel > (Enter channel number)
 - Application Config > Enhanced Test Application Protocol > RTAP
 - RTAP Rate > 153.6 kbps
 - Rvs Power Ctrl > Active bits
 - Protocol Rel > 0 (1xEV-DO)
- Press "Start Data Connection" when "Session Open" appear in "Active Cell"
- Rvs Power Ctrl > All Up bits (Maximum TxPout)

EVDO Release 0 - FTAP

- Call Setup > Shift & Preset
- Call Control:
 - Access Network Info > Cell Parameters > Sector ID > 00000000 : 00000000 : 00000000 : 00000000 > Subnet Mask > 0
 - Generator Info > Termination Parameters > Max Forward Packet Duration > 16 Slots
- Call Params:
 - Cell Power > -105.5 dBm/1.23 MHz
 - Cell Band > (Select US Cellular or US PCS)
 - Channel > (Enter channel number)
 - Application Config > Enhanced Test Application Protocol > FTAP (default)
 - FTAP Rate > 307.2 kbps (2 Slot, QPSK)
 - Rvs Power Ctrl > Active bits
 - Protocol Rel > 0 (1xEV-DO)
- Press "Start Data Connection" when "Session Open" appear in "Active Cell"
- Rvs Power Ctrl > All Up bits (Maximum TxPout)

RESULTS

7.2.3. 1xEV-DO - REV 0 (ANTENNA - C)

CDMA2000 EVDO REV. 0 800MHz SECONDARY BAND

FTAP Rate	RTAP Rate	Channel	f (MHz)	Conducted Output Power (dBm)	
				Peak	Average
307.2 kbps (2 Slot QPSK)	153.6 kbps	450	817.25	29.1	24.9
		560	820.00	29.1	25.0
		670	822.75	29.1	24.9

CDMA2000 EVDO REV 0 850MHz BAND

FTAP Rate	RTAP Rate	Channel	Frequency (MHz)	Peak Conducted Power (dBm)	Average Conducted Power (dBm)
307.2 Kbps (2 slot QPSK)	153.6 Kbps	1013	824.70	29.7	24.4
		384	836.52	29.6	24.3
		777	848.31	29.8	24.5

CDMA2000 EVDO REV 0 1900MHz BAND

FTAP Rate	RTAP Rate	Channel	Frequency (MHz)	Peak Conducted Power (dBm)	Average Conducted Power (dBm)
307.2 Kbps (2 slot QPSK)	153.6 Kbps	25	1851.25	28.5	24.3
		600	1880.00	29.0	24.5
		1175	1908.75	28.8	24.3

CDMA2000 EVDO REV. 0 1700MHz BAND

FTAP Rate	RTAP Rate	Channel	f (MHz)	Conducted Output Power (dBm)	
				Peak	Average
307.2 kbps (2 Slot QPSK)	153.6 kbps	25	1711.25	29.0	24.3
		450	1732.50	29.1	24.4
		875	1753.75	29.2	24.5

7.2.4. 1xEV-DO - REV 0 (ANTENNA - D)

CDMA2000 EVDO REV. 0 800MHz SECONDARY BAND

FTAP Rate	RTAP Rate	Channel	f (MHz)	Conducted Output Power (dBm)	
				Peak	Average
307.2 kbps (2 Slot QPSK)	153.6 kbps	450	817.25	28.4	23.3
		560	820.00	28.3	23.2
		670	822.75	28.5	23.5

CDMA2000 EVDO REV 0 850MHz BAND

FTAP Rate	RTAP Rate	Channel	Frequency (MHz)	Peak Conducted Power (dBm)	Average Conducted Power (dBm)
307.2 Kbps (2 slot QPSK)	153.6 Kbps	1013	824.70	28.3	23.5
		384	836.52	28.2	23.4
		777	848.31	28.2	23.4

CDMA2000 EVDO REV 0 1900MHz BAND

FTAP Rate	RTAP Rate	Channel	Frequency (MHz)	Peak Conducted Power (dBm)	Average Conducted Power (dBm)
307.2 Kbps (2 slot QPSK)	153.6 Kbps	25	1851.25	27.4	21.9
		600	1880.00	27.5	22.0
		1175	1908.75	27.4	21.9

CDMA2000 EVDO REV. 0 1700MHz BAND

FTAP Rate	RTAP Rate	Channel	f (MHz)	Conducted Output Power (dBm)	
				Peak	Average
307.2 kbps (2 Slot QPSK)	153.6 kbps	25	1711.25	27.3	21.8
		450	1732.50	27.5	22.0
		875	1753.75	27.4	21.9

CDMA2000 1xEV-DO - Revision A (REV A)

This procedure assumes the Agilent 8960 Test Set has the following applications installed and with valid license.

<u>Application</u>	<u>Rev, License</u>
1xEV-DO Terminal Test	A.09.13

EVDO Rev. A – RETAP

- Call Setup > Shift & Preset
- Cell Power > -60 dBm/1.23 MHz
- Protocol Rev > A (1xEV-DO-A)
- Application Config > Enhanced Test Application Protocol > RETAP
- R-Data Pkt Size > 4096
- Protocol Subtype Config > Release A Physical Layer Subtype > Subtype 2
- > PL Subtype 2 Access Channel MAC Subtype > Default (Subtype 0)
- Access Network Info > Cell Parameters > Sector ID > 00000000: 00000000: 00000000: 00000000
- > Subnet Mask > 0
- Generator Info > Termination Parameters > Max Forward Packet Duration >16 Slots > ACK R-Data After > Subpacket 0 (All ACK)
- Rvs Power Ctrl > All Up bits (to get the maximum power)

EVDO Rev. A - FETAP

- Call Setup > Shift & Preset
- Cell Power > -60 dBm/1.23 MHz
- Protocol Rev > A (1xEV-DO-A)
- Application Config > Enhanced Test Application Protocol > FETAP
- F-Traffic Format > 4 (1024, 2,128) Canonical (307.2k, QPSK)
- Protocol Subtype Config > Release A Physical Layer Subtype > Subtype 2
- > PL Subtype 2 Access Channel MAC Subtype > Default (Subtype 0)
- Access Network Info > Cell Parameters > Sector ID > 00000000: 00000000: 00000000: 00000000
- > Subnet Mask > 0
- Generator Info > Termination Parameters > Max Forward Packet Duration >16 Slots > ACK R-Data After > Subpacket 0 (All ACK)
- Rvs Power Ctrl > All Up bits (to get the maximum power)

RESULTS

7.2.5. 1xEV-DO - REV A (ANTENNA - C)

CDMA2000 EVDO REV A 800MHz SECONDARY BAND

FETAP Traffic Format	RETAP Data Payload Size	Channel	Frequency (MHz)	Peak Conducted Power (dBm)	Average Conducted Power (dBm)
307.2k, QPSK / ACK channel is transmitted at all the slots	4096	450	817.25	29.2	25.0
		560	820.00	29.2	25.0
		670	822.75	29.1	24.9

CDMA2000 EVDO REV A 850MHz BAND

FETAP Traffic Format	RETAP Data Payload Size	Channel	Frequency (MHz)	Peak Conducted Power (dBm)	Average Conducted Power (dBm)
307.2k, QPSK / ACK channel is transmitted at all the slots	4096	1013	824.70	29.1	24.5
		384	836.52	29.0	24.5
		777	848.31	28.9	24.5

CDMA2000 EVDO REV A 1900MHz BAND

FETAP Traffic Format	RETAP Data Payload Size	Channel	Frequency (MHz)	Peak Conducted Power (dBm)	Average Conducted Power (dBm)
307.2k, QPSK / ACK channel is transmitted at all the slots	4096	25	1851.25	28.7	24.4
		600	1880.00	29.2	24.5
		1175	1908.75	29.1	24.4

CDMA2000 EVDO REV A 1700MHz BAND

FETAP - Traffic Format	RETAP - Data Payload Size	Channel	f (MHz)	Conducted Output Power (dBm)	
				Peak	Average
307.2k QPSK/ ACK channel is transmitted at all the slots	4096	25	1711.25	29.4	24.5
		450	1732.50	29.0	24.4
		875	1753.75	29.1	24.5

7.2.6. 1xEV-DO - REV A (ANTENNA - D)

CDMA2000 EVDO REV A 800MHz SECONDARY BAND

FETAP Traffic Format	RETAP Data Payload Size	Channel	Frequency (MHz)	Peak Conducted Power (dBm)	Average Conducted Power (dBm)
307.2k, QPSK / ACK channel is transmitted at all the slots	4096	450	817.25	28.6	23.5
		560	820.00	28.4	23.4
		670	822.75	28.6	23.5

CDMA2000 EVDO REV A 850MHz BAND

FETAP Traffic Format	RETAP Data Payload Size	Channel	Frequency (MHz)	Peak Conducted Power (dBm)	Average Conducted Power (dBm)
307.2k, QPSK / ACK channel is transmitted at all the slots	4096	1013	824.70	28.6	23.5
		384	836.52	28.6	23.5
		777	848.31	28.6	23.5

CDMA2000 EVDO REV A 1900MHz BAND

FETAP Traffic Format	RETAP Data Payload Size	Channel	Frequency (MHz)	Peak Conducted Power (dBm)	Average Conducted Power (dBm)
307.2k, QPSK / ACK channel is transmitted at all the slots	4096	25	1851.25	27.0	21.9
		600	1880.00	27.0	22.0
		1175	1908.75	27.0	21.9

CDMA2000 EVDO REV A 1700MHz BAND

FETAP - Traffic Format	RETAP - Data Payload Size	Channel	f (MHz)	Conducted Output Power (dBm)	
				Peak	Average
307.2k QPSK/ ACK channel is transmitted at all the slots	4096	25	1711.25	27.1	21.9
		450	1732.50	27.1	22.0
		875	1753.75	27.0	22.0

7.3. UMTS

TEST PROCEDURE

The transmitter output was connected to the input terminal of Directional Coupler via calibrated coaxial cable. The output coupling terminal of the Directional Coupler was directly connected to a spectrum analyzer while the output through terminal connected to the communication test set via calibrated coaxial cable.

The output power was measured with the spectrum analyzer at the low, middle and high channel in each band.

- Set the spectrum analyzer span wide enough or greater than the modulated signal BW.
- Set a spectrum analyzer at peak detection mode with $VBW \geq RBW \geq 26dB$ BW, typically 5MHz.
- Set a marker to point the corresponding peak value.

UMTS REL99

The following summary of these settings are illustrated below:

	Mode	Rel99
	Subtest	-
WCDMA General Settings	Loopback Mode	Test Mode 1
	Rel99 RMC	12.2kbps RMC
	HSDPA FRC	Not Applicable
	HSUPA Test	Not Applicable
	Power Control Algorithm	Algorithm2
	β_c	Not Applicable
	β_d	Not Applicable
	β_{ec}	Not Applicable
	β_c/β_d	8/15
	β_{hs}	Not Applicable
	β_{ed}	Not Applicable

RESULTS

7.3.1. UMTS REL99 (ANTENNA - C)

Part 22 / RSS 132 850MHz Band

Band	UL Channel	DL Channel	Frequency (MHz)	Peak Power (dBm)	Average Power (dBm)
UMTS Rel. 99 850MHz	4132	4357	826.4	28.5	25.0
	4183	4408	836.6	28.7	25.0
	4233	4458	846.6	29.2	25.0

Part 24 / RSS 133 1900MHz Band

Band	UL Channel	DL Channel	Frequency (MHz)	Peak Power (dBm)	Average Power (dBm)
UMTS Rel. 99 1900MHz	9262	9662	1852.4	28.5	24.5
	9400	9800	1880.0	28.3	24.5
	9538	9938	1907.6	27.9	24.5

Part 27 / RSS 139 1700MHz Band

Band	UL Channel	DL Channel	Frequency (MHz)	Peak Power (dBm)	Average Power (dBm)
UMTS Rel. 99 1700MHz	1312	1537	1712.4	28.4	24.5
	1413	1638	1732.6	27.7	24.5
	1513	1738	1752.6	27.7	24.5

7.3.2. UMTS REL99 (ANTENNA - D)

Part 22 / RSS 132 850MHz Band

Band	UL Channel	DL Channel	Frequency (MHz)	Peak Power (dBm)	Average Power (dBm)
UMTS Rel. 99 850MHz	4132	4357	826.4	27.9	23.4
	4183	4408	836.6	27.8	23.3
	4233	4458	846.6	27.7	23.5

Part 24 / RSS 133 1900MHz Band

Band	UL Channel	DL Channel	Frequency (MHz)	Peak Power (dBm)	Average Power (dBm)
UMTS Rel. 99 1900MHz	9262	9662	1852.4	26.1	21.8
	9400	9800	1880.0	26.3	22.0
	9538	9938	1907.6	26.2	21.8

Part 27 / RSS 139 1700MHz Band

Band	UL Channel	DL Channel	Frequency (MHz)	Peak Power (dBm)	Average Power (dBm)
UMTS Rel. 99 1700MHz	1312	1537	1712.4	26.2	21.7
	1413	1638	1732.6	25.9	22.0
	1513	1738	1752.6	25.6	21.8

7.4. HSDPA REL 5

The following 4 Sub-tests were completed according to Release 6 procedures in section 5.2 of 3GPP TS34.121.

Summary of settings are illustrated below:

	Mode	Rel5 HSDPA			
	Subtest	1	2	3	4
WCDMA General Settings	Loopback Mode	Test Mode 1			
	Rel99 RMC	12.2kbps RMC			
	HSDPA FRC	H-Set1			
	Power Control Algorithm	Algorithm 2			
	β_c	2/15	12/15	15/15	15/15
	β_d	15/15	15/15	8/15	4/15
	Bd (SF)	64			
	β_c/β_d	2/15	12/15	15/8	15/4
	β_{hs}	4/15	24/15	30/15	30/15
	MPR (dB)	0	0	0.5	0.5
HSDPA Specific Settings	D_{ACK}	8			
	D_{NAK}	8			
	DCQI	8			
	Ack-Nack repetition factor	3			
	CQI Feedback (Table 5.2B.4)	4ms			
	CQI Repetition Factor (Table 5.2B.4)	2			
	$A_{hs} = \beta_{hs}/\beta_c$	30/15			

RESULT

7.4.1. HSDPA REL 5 (ANTENNA - C)

Part 22 / RSS 132 850MHz Band

Band	Subtest	UL Channel	DL Channel	Frequency (MHz)	Peak Power (dBm)	Average Power (dBm)
UMTS HSDPA 850MHz	1	4132	4357	826.4	28.2	24.0
		4183	4408	836.6	28.2	24.0
		4233	4458	846.6	28.5	24.0
	2	4132	4357	826.4	28.1	24.0
		4183	4408	836.6	27.8	24.0
		4233	4458	846.6	28.4	24.0
	3	4132	4357	826.4	27.7	23.5
		4183	4408	836.6	27.7	23.4
		4233	4458	846.6	28.4	23.5
	4	4132	4357	826.4	28.1	23.5
		4183	4408	836.6	27.8	23.5
		4233	4458	846.6	28.1	23.4

Part 24 / RSS 133 1900MHz Band

Band	Subtest	UL Channel	DL Channel	Frequency (MHz)	Peak Power (dBm)	Average Power (dBm)
UMTS HSDPA 1900MHz	1	9262	9662	1852.4	27.7	23.5
		9400	9800	1880.0	27.7	23.5
		9538	9938	1907.6	28.1	23.5
	2	9262	9662	1852.4	27.9	23.5
		9400	9800	1880.0	28.0	23.5
		9538	9938	1907.6	27.7	23.4
	3	9262	9662	1852.4	27.4	23.0
		9400	9800	1880.0	27.6	23.0
		9538	9938	1907.6	27.6	23.0
	4	9262	9662	1852.4	27.5	23.0
		9400	9800	1880.0	27.5	23.0
		9538	9938	1907.6	27.5	23.0

Part 27 / RSS 139 1700MHz Band

Band	Subtest	UL Channel	DL Channel	Frequency (MHz)	Peak Power (dBm)	Average Power (dBm)
UMTS HSDPA 1700MHz	1	1312	1537	1712.4	27.6	23.5
		1413	1638	1732.6	27.9	23.5
		1513	1738	1752.6	27.8	23.5
	2	1312	1537	1712.4	27.3	23.5
		1413	1638	1732.6	27.6	23.5
		1513	1738	1752.6	27.6	23.5
	3	1312	1537	1712.4	27.3	23.0
		1413	1638	1732.6	27.6	23.0
		1513	1738	1752.6	27.7	23.0
	4	1312	1537	1712.4	27.5	23.0
		1413	1638	1732.6	27.7	23.0
		1513	1738	1752.6	27.6	23.0

7.4.2. HSDPA REL 5 (ANTENNA - D)

Part 22 / RSS 132 850MHz Band

Band	Subtest	UL Channel	DL Channel	Frequency (MHz)	Peak Power (dBm)	Average Power (dBm)
UMTS HSDPA 850MHz	1	4132	4357	826.4	27.7	22.5
		4183	4408	836.6	27.6	22.3
		4233	4458	846.6	27.6	22.4
	2	4132	4357	826.4	27.4	22.4
		4183	4408	836.6	27.4	22.3
		4233	4458	846.6	27.5	22.3
	3	4132	4357	826.4	27.1	22.0
		4183	4408	836.6	27.1	21.9
		4233	4458	846.6	27.0	21.9
	4	4132	4357	826.4	27.0	21.9
		4183	4408	836.6	27.1	22.0
		4233	4458	846.6	27.0	21.9

Part 24 / RSS 133 1900MHz Band

Band	Subtest	UL Channel	DL Channel	Frequency (MHz)	Peak Power (dBm)	Average Power (dBm)
UMTS HSDPA 1900MHz	1	9262	9662	1852.4	25.6	21.0
		9400	9800	1880.0	25.5	20.9
		9538	9938	1907.6	25.4	20.9
	2	9262	9662	1852.4	25.5	20.9
		9400	9800	1880.0	25.5	20.9
		9538	9938	1907.6	25.3	20.9
	3	9262	9662	1852.4	25.1	20.4
		9400	9800	1880.0	25.2	20.4
		9538	9938	1907.6	25.0	20.5
	4	9262	9662	1852.4	25.1	20.4
		9400	9800	1880.0	25.0	20.5
		9538	9938	1907.6	25.0	20.4

Part 27 / RSS 139 1700MHz Band

Band	Subtest	UL Channel	DL Channel	Frequency (MHz)	Peak Power (dBm)	Average Power (dBm)
UMTS HSDPA 1700MHz	1	1312	1537	1712.4	25.5	20.9
		1413	1638	1732.6	25.3	20.9
		1513	1738	1752.6	25.4	20.9
	2	1312	1537	1712.4	25.3	20.8
		1413	1638	1732.6	25.4	20.8
		1513	1738	1752.6	25.4	20.8
	3	1312	1537	1712.4	24.9	20.3
		1413	1638	1732.6	24.9	20.4
		1513	1738	1752.6	24.9	20.4
	4	1312	1537	1712.4	25.0	20.4
		1413	1638	1732.6	25.0	20.4
		1513	1738	1752.6	25.0	20.4

7.5. HSPA REL 6 (HSDPA & HSUPA)

TEST PROCEDURE

The following summary of these settings are illustrated below:

	Mode	Rel6 HSUPA	Rel6 HSUPA	Rel6 HSUPA	Rel6 HSUPA	Rel6 HSUPA	
	Subtest	1	2	3	4	5	
WCDMA General Settings	Loopback Mode	Test Mode 1					
	Rel99 RMC	12.2kbps RMC					
	HSDPA FRC	H-Set1					
	HSUPA Test	HSUPA Loopback					
	Power Control Algorithm	Algorithm2					
	β_c	11/15	6/15	15/15	2/15	15/15	
	β_d	15/15	15/15	9/15	15/15	0	
	β_{ec}	209/225	12/15	30/15	2/15	5/15	
	β_c/β_d	11/15	6/15	15/9	2/15	15/1	
	β_{hs}	22/15	12/15	30/15	4/15	5/15	
	β_{ed}	1309/225	94/75	47/15	56/75	47/15	
CM (dB)	1	3	2	3	1		
MPR (dB)	0	2	1	2	0		
HSDPA Specific Settings	DACK	8					
	DNAK	8					
	DCQI	8					
	Ack-Nack repetition factor	3					
	CQI Feedback (Table 5.2B.4)	4ms					
	CQI Repetition Factor (Table 5.2B.4)	2					
$A_{hs} = \beta_{hs}/\beta_c$	30/15						
HSUPA Specific Settings	D E-DPCCH	6	8	8	5	7	
	DHARQ	0	0	0	0	0	
	AG Index	20	12	15	17	12	
	ETFCI (from 34.121 Table C.11.1.3)	75	67	92	71	67	
	Associated Max UL Data Rate kbps	242.1	174.9	482.8	205.8	308.9	
	Reference E_TFCIs	E-TFCI 11 E-TFCI PO 4 E-TFCI 67 E-TFCI PO 18 E-TFCI 71 E-TFCI PO 23 E-TFCI 75 E-TFCI PO 26 E-TFCI 81 E-TFCI PO 27	E-TFCI 11 E-TFCI PO 4 E-TFCI 67 E-TFCI PO 18 E-TFCI 71 E-TFCI PO 23 E-TFCI 75 E-TFCI PO 26 E-TFCI 81 E-TFCI PO 27	E-TFCI 11 E-TFCI PO 4 E-TFCI 92 E-TFCI PO 18	E-TFCI 11 E-TFCI PO 4 E-TFCI 67 E-TFCI PO 18 E-TFCI 71 E-TFCI PO 23 E-TFCI 75 E-TFCI PO 26 E-TFCI 81 E-TFCI PO 27		

RESULTS

7.5.1. HSPA REL 6 (HSDPA & HSUPA) (ANTENNA - C)

Part 22 / RSS 132 850MHz Band

Band	Subtest	UL Channel	DL Channel	Frequency (MHz)	Peak Power (dBm)	Average Power (dBm)
UMTS HSUPA 850MHz	1	4132	4357	826.4	28.4	24.0
		4183	4408	836.6	27.9	24.0
		4233	4458	846.6	28.2	24.0
	2	4132	4357	826.4	26.4	22.0
		4183	4408	836.6	26.4	22.1
		4233	4458	846.6	26.3	22.1
	3	4132	4357	826.4	26.7	23.0
		4183	4408	836.6	26.8	23.0
		4233	4458	846.6	26.8	23.0
	4	4132	4357	826.4	26.2	22.0
		4183	4408	836.6	26.1	22.0
		4233	4458	846.6	26.2	22.0
	5	4132	4357	826.4	28.2	24.0
		4183	4408	836.6	28.3	24.0
		4233	4458	846.6	28.4	24.0

Part 24 / RSS 133 1900MHz Band

Band	Subtest	UL Ch	DL Ch	Frequency	Conducted Output Power (dBm)	
					Peak	Average
UMTS HSUPA 1900MHz (Band 2)	1	9262	9662	1852	27.5	23.5
		9400	9800	1880	27.8	23.5
		9538	9938	1908	27.6	23.5
	2	9262	9662	1852	26.0	21.5
		9400	9800	1880	26.2	21.5
		9538	9938	1908	26.0	21.5
	3	9262	9662	1852	26.5	22.5
		9400	9800	1880	26.5	22.5
		9538	9938	1908	26.7	22.5
	4	9262	9662	1852	25.6	21.7
		9400	9800	1880	25.6	21.7
		9538	9938	1908	25.4	21.4
	5	9262	9662	1852	27.7	23.5
		9400	9800	1880	27.8	23.5
		9538	9938	1908	27.6	23.5

Part 27 / RSS 139 1700MHz Band

Band	Subtest	UL Channel	DL Channel	Frequency (MHz)	Peak Power (dBm)	Average Power (dBm)
UMTS HSUPA 1700MHz	1	1312	1537	1712.4	27.5	23.5
		1413	1638	1732.6	27.7	23.5
		1513	1738	1752.6	27.8	23.4
	2	1312	1537	1712.4	26.2	21.5
		1413	1638	1732.6	25.9	21.4
		1513	1738	1752.6	26.1	21.4
	3	1312	1537	1712.4	26.5	22.5
		1413	1638	1732.6	26.3	22.4
		1513	1738	1752.6	26.8	22.5
	4	1312	1537	1712.4	25.9	21.7
		1413	1638	1732.6	26.1	21.7
		1513	1738	1752.6	25.9	21.6
	5	1312	1537	1712.4	27.6	23.5
		1413	1638	1732.6	27.7	23.5
		1513	1738	1752.6	27.8	23.5

7.5.2. HSPA REL 6 (HSDPA & HSUPA) (ANTENNA - D)

Part 22 / RSS 132 850MHz Band

Band	Subtest	UL Channel	DL Channel	Frequency (MHz)	Peak Power (dBm)	Average Power (dBm)
UMTS HSUPA 850MHz	1	4132	4357	826.4	27.3	22.4
		4183	4408	836.6	27.6	22.3
		4233	4458	846.6	27.6	22.4
	2	4132	4357	826.4	26.0	20.4
		4183	4408	836.6	26.0	20.3
		4233	4458	846.6	26.0	20.3
	3	4132	4357	826.4	26.5	21.3
		4183	4408	836.6	26.4	21.3
		4233	4458	846.6	26.2	21.3
	4	4132	4357	826.4	26.0	20.3
		4183	4408	836.6	26.1	20.2
		4233	4458	846.6	26.0	20.2
	5	4132	4357	826.4	27.4	22.4
		4183	4408	836.6	27.5	22.3
		4233	4458	846.6	27.4	22.3

Part 24 / RSS 133 1900MHz Band

Band	Subtest	UL Ch	DL Ch	Frequency	Conducted Output Power (dBm)	
					Peak	Average
UMTS HSUPA 1900MHz (Band 2)	1	9262	9662	1852	25.5	20.9
		9400	9800	1880	25.4	20.9
		9538	9938	1908	25.5	20.9
	2	9262	9662	1852	24.1	19.1
		9400	9800	1880	24.1	19.1
		9538	9938	1908	24.2	19.0
	3	9262	9662	1852	25.3	20.0
		9400	9800	1880	25.3	20.1
		9538	9938	1908	25.3	20.0
	4	9262	9662	1852	24.2	19.1
		9400	9800	1880	24.1	19.1
		9538	9938	1908	24.1	19.0
	5	9262	9662	1852	25.5	20.9
		9400	9800	1880	25.4	20.9
		9538	9938	1908	25.5	20.9

Part 27 / RSS 139 1700MHz Band

Band	Subtest	UL Channel	DL Channel	Frequency (MHz)	Peak Power (dBm)	Average Power (dBm)
UMTS HSUPA 1700MHz	1	1312	1537	1712.4	25.1	20.9
		1413	1638	1732.6	25.2	20.8
		1513	1738	1752.6	25.2	20.9
	2	1312	1537	1712.4	23.2	18.9
		1413	1638	1732.6	23.1	18.9
		1513	1738	1752.6	23.0	18.8
	3	1312	1537	1712.4	24.5	19.9
		1413	1638	1732.6	24.5	19.8
		1513	1738	1752.6	24.7	19.9
	4	1312	1537	1712.4	23.2	18.9
		1413	1638	1732.6	23.2	18.8
		1513	1738	1752.6	23.1	18.8
	5	1312	1537	1712.4	25.2	20.9
		1413	1638	1732.6	25.1	20.8
		1513	1738	1752.6	25.2	20.9

7.6. DUAL CARRIER HSDPA

DC-HSDPA (Rel 8, CAT 24)

The following tests were completed according to procedures in section 7.3.13 of 3GPP TS34.108 v9.5.0. A summary of these settings are illustrated below:

Downlink Physical Channels are set as per 3GPP TS34.121-1 v9.0.0 E.5.0

Table E.5.0: Levels for HSDPA connection setup

Parameter During Connection setup	Unit	Value
P-CPICH_Ec/Ior	dB	-10
P-CCPCH and SCH_Ec/Ior	dB	-12
PICH_Ec/Ior	dB	-15
HS-PDSCH	dB	off
HS-SCCH_1	dB	off
DPCH_Ec/Ior	dB	-5
OCNS_Ec/Ior	dB	-3.1

Call is set up as per 3GPP TS34.108 v9.5.0 sub clause 7.3.13

The configurations of the fixed reference channels for HSDPA RF tests are described in 3GPP TS 34.121, annex C for FDD and 3GPP TS 34.122.

Table C.8.1.12: Fixed Reference Channel H-Set 12

Parameter	Unit	Value
Nominal Avg. Inf. Bit Rate	kbps	60
Inter-TTI Distance	TTI's	1
Number of HARQ Processes	Processes	6
Information Bit Payload (N_{INF})	Bits	120
Number Code Blocks	Blocks	1
Binary Channel Bits Per TTI	Bits	960
Total Available SML's in UE	SML's	19200
Number of SML's per HARQ Proc.	SML's	3200
Coding Rate		0.15
Number of Physical Channel Codes	Codes	1
Modulation		QPSK
Note 1: The RMC is intended to be used for DC-HSDPA mode and both cells shall transmit with identical parameters as listed in the table. Note 2: Maximum number of transmission is limited to 1, i.e., retransmission is not allowed. The redundancy and constellation version 0 shall be used.		

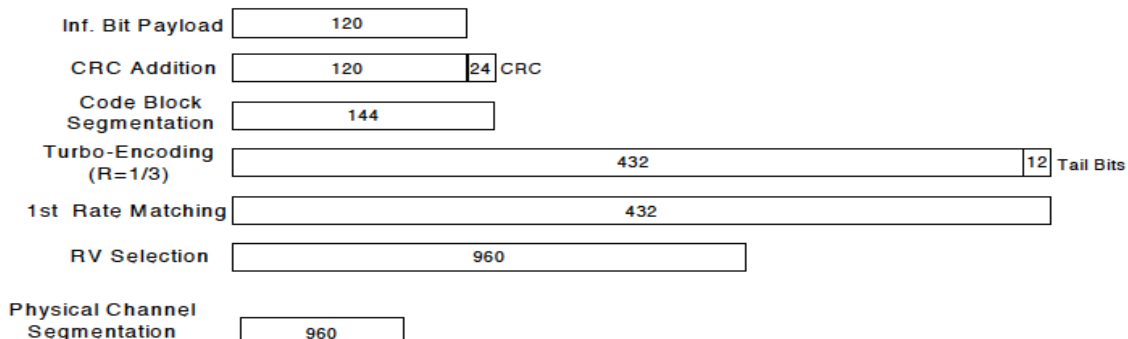

Figure C.8.19: Coding rate for Fixed reference Channel H-Set 12 (QPSK)

The following 4 Sub-tests for HSDPA were completed according to Release 6 procedures in section 5.2 of 3GPP TS34.121. A summary of subtest settings are illustrated below:

	Mode	Rel6 HSDPA	Rel6 HSDPA	Rel6 HSDPA	Rel6 HSDPA
	Subtest	1	2	3	4
WCDMA General Settings	Loopback Mode	Test Mode 1			
	Rel99 RMC	12.2kbps RMC			
	HSDPA FRC	H-Set1A			
	Power Control Algorithm	Algorithm2			
	β_c	2/15	12/15	15/15	15/15
	β_d	15/15	15/15	8/15	4/15
	β_d (SF)	64			
	β_c/β_d	2/15	12/15	15/8	15/4
	β_{hs}	4/15	24/15	30/15	30/15
MPR	0	0	0.5	0.5	
HSDPA Specific Settings	DACK	8			
	DNAK	8			
	DCQI	8			
	Ack-Nack Repetition factor	3			
	CQI Feedback	4ms			
	CQI Repetition Factor	2			
	Ahs = β_{hs} / β_c	30/15			

RESULT

7.6.1. DUAL CARRIER HSDPA (ANTENNA - C)

Part 22 / RSS 132 850MHz Band

Band	Subtest	UL Channel	DL Channel	Frequency (MHz)	Peak Power (dBm)	Average Power (dBm)
UMTS HSDPA 850MHz	1	4132	4357	826.4	28.2	24.0
		4183	4408	836.6	28.0	23.9
		4233	4458	846.6	28.0	23.9
	2	4132	4357	826.4	28.2	23.9
		4183	4408	836.6	28.1	23.9
		4233	4458	846.6	27.9	23.9
	3	4132	4357	826.4	27.3	23.5
		4183	4408	836.6	27.6	23.4
		4233	4458	846.6	27.3	23.4
	4	4132	4357	826.4	27.4	23.5
		4183	4408	836.6	27.5	23.5
		4233	4458	846.6	27.5	23.4

Part 24 / RSS 133 1900MHz Band

Band	Subtest	UL Channel	DL Channel	Frequency (MHz)	Peak Power (dBm)	Average Power (dBm)
UMTS HSDPA 1900MHz	1	9262	9662	1852.4	27.7	23.4
		9400	9800	1880.0	27.7	23.4
		9538	9938	1907.6	27.7	23.3
	2	9262	9662	1852.4	27.5	23.4
		9400	9800	1880.0	27.7	23.4
		9538	9938	1907.6	27.6	23.4
	3	9262	9662	1852.4	27.2	23.0
		9400	9800	1880.0	27.4	23.0
		9538	9938	1907.6	27.2	22.9
	4	9262	9662	1852.4	27.1	23.0
		9400	9800	1880.0	27.0	22.9
		9538	9938	1907.6	27.3	22.9

Part 27 / RSS 139 1700MHz Band

Band	Subtest	UL Channel	DL Channel	Frequency (MHz)	Peak Power (dBm)	Average Power (dBm)
UMTS HSDPA 1700MHz	1	1312	1537	1712.4	27.6	23.4
		1413	1638	1732.6	27.8	23.5
		1513	1738	1752.6	27.7	23.4
	2	1312	1537	1712.4	27.7	23.5
		1413	1638	1732.6	27.7	23.4
		1513	1738	1752.6	27.6	23.3
	3	1312	1537	1712.4	27.1	22.9
		1413	1638	1732.6	27.3	22.9
		1513	1738	1752.6	27.3	22.8
	4	1312	1537	1712.4	27.1	22.9
		1413	1638	1732.6	27.2	22.9
		1513	1738	1752.6	27.4	22.8

7.6.2. DUAL CARRIER HSDPA (ANTENNA - D)

Part 22 / RSS 132 850MHz Band

Band	Subtest	UL Channel	DL Channel	Frequency (MHz)	Peak Power (dBm)	Average Power (dBm)
UMTS HSDPA 850MHz	1	4132	4357	826.4	27.3	22.4
		4183	4408	836.6	27.5	22.4
		4233	4458	846.6	27.4	22.4
	2	4132	4357	826.4	27.3	22.4
		4183	4408	836.6	27.4	22.4
		4233	4458	846.6	27.4	22.4
	3	4132	4357	826.4	27.0	21.9
		4183	4408	836.6	27.0	21.9
		4233	4458	846.6	27.1	21.9
	4	4132	4357	826.4	26.9	21.9
		4183	4408	836.6	27.0	21.9
		4233	4458	846.6	27.0	21.9

Part 24 / RSS 133 1900MHz Band

Band	Subtest	UL Channel	DL Channel	Frequency (MHz)	Peak Power (dBm)	Average Power (dBm)
UMTS HSDPA 1900MHz	1	9262	9662	1852.4	25.5	20.9
		9400	9800	1880.0	25.5	20.9
		9538	9938	1907.6	25.4	20.9
	2	9262	9662	1852.4	25.3	20.9
		9400	9800	1880.0	25.5	20.9
		9538	9938	1907.6	25.4	20.9
	3	9262	9662	1852.4	25.2	20.5
		9400	9800	1880.0	25.1	20.5
		9538	9938	1907.6	25.0	20.5
	4	9262	9662	1852.4	25.1	20.5
		9400	9800	1880.0	25.1	20.5
		9538	9938	1907.6	25.1	20.5

Part 27 / RSS 139 1700MHz Band

Band	Subtest	UL Channel	DL Channel	Frequency (MHz)	Peak Power (dBm)	Average Power (dBm)
UMTS HSDPA 1700MHz	1	1312	1537	1712.4	25.4	20.9
		1413	1638	1732.6	25.3	20.8
		1513	1738	1752.6	25.4	20.9
	2	1312	1537	1712.4	25.3	20.9
		1413	1638	1732.6	25.2	20.9
		1513	1738	1752.6	25.2	20.8
	3	1312	1537	1712.4	25.0	20.4
		1413	1638	1732.6	25.1	20.4
		1513	1738	1752.6	25.1	20.4
	4	1312	1537	1712.4	25.1	20.5
		1413	1638	1732.6	25.0	20.4
		1513	1738	1752.6	25.1	20.4

8. CONDUCTED TEST RESULTS

8.1. OCCUPIED BANDWIDTH

RULE PART(S)

FCC: §2.1049

LIMITS

For reporting purposes only

TEST PROCEDURE

The transmitter output was connected to a calibrated coaxial cable and coupler, the other end of which was connected to a spectrum analyzer. The occupied bandwidth was measured with the spectrum analyzer at the low, middle and high channel in each band. The 99% and -26dB bandwidths was also measured and recorded.

RESULTS

GSM-GPRS MODE PART 22 AND 24 / RSS 132 AND 133

Band	Mode	Channel	f (MHz)	99% BW (KHz)	-26dB BW (KHz)
CELL	GPRS	128	824.2	239.0227	291.441
		190	836.6	242.4857	299.080
		251	848.8	238.2899	309.745

Band	Mode	Channel	f (MHz)	99% BW (KHz)	-26dB BW (KHz)
PCS	GPRS	512	1850.2	238.4945	292.669
		661	1880.0	245.1971	312.532
		810	1909.8	239.9775	288.460

GSM-EGPRS MODE PART 22 AND 24 / RSS 132 AND 133

Band	Mode	Channel	f (MHz)	99% BW (KHz)	-26dB BW (KHz)
CELL	EGPRS	128	824.2	238.9893	304.282
		190	836.6	241.0731	297.523
		251	848.8	237.7185	294.646

Band	Mode	Channel	f (MHz)	99% BW (KHz)	-26dB BW (KHz)
PCS	EGPRS	512	1850.2	238.9027	297.023
		661	1880.0	244.5356	315.933
		810	1909.8	238.7508	287.087

CDMA2000 1xRTT, PART 22, 24, 27 AND 90/ RSS 132, 133 AND 139

Band	Mode	Channel	f(MHz)	99% BW (MHz)	-26dB BW (MHz)
CELL	CDMA 2000 1xRTT	1013	824.70	1.2602	1.393
		384	836.52	1.2603	1.378
		777	848.31	1.2739	1.405
PCS		25	1851.25	1.2604	1.384
		600	1880.00	1.2668	1.407
		1175	1908.75	1.2796	1.414
AWS		25	1711.25	1.2646	1.396
		450	1732.50	1.2787	1.394
		875	1753.75	1.2745	1.389
800 MHz Secondary		450	817.25	1.2800	1.405
		560	820.00	1.2847	1.390
		670	822.75	1.2749	1.402

CDMA2000 EVDO REV A, PART 22, 24, 27 AND 90/ RSS 132, 133 AND 139

Band	Mode	Channel	f(MHz)	99% BW (MHz)	-26dB BW (MHz)
CELL	CDMA 2000 EVDO Rev. A	1013	824.70	1.2819	1.419
		384	836.52	1.2650	1.391
		777	848.31	1.2721	1.405
PCS		25	1851.25	1.2577	1.405
		600	1880.00	1.3013	1.379
		1175	1908.75	1.2556	1.400
AWS		25	1711.25	1.2624	1.385
		450	1732.50	1.2768	1.399
		875	1753.75	1.2735	1.400
800 MHz Secondary		450	817.25	1.2678	1.426
		560	820.00	1.2685	1.402
		670	822.75	1.2589	1.400

UMTS REL99 MODE PART 22, 24, AND 27 / RSS 132, 133 AND 139

Band	Mode	DL Channel	f(MHz)	99% BW (MHz)	-26dB BW (MHz)
850MHz	UMTS Rel. 99	4357	826.40	4.2309	4.633
		4408	836.60	4.1881	4.632
		4458	846.60	4.0635	4.506
1900MHz		9662	1852.40	4.1382	4.611
		9800	1880.00	4.1386	4.657
		9938	1907.60	4.1590	4.636
1700MHz		1537	1712.40	4.0993	4.536
		1638	1732.60	4.1113	4.579
		1738	1752.60	4.2056	4.729

UMTS HSDPA MODE PART 22, 24, AND 27 / RSS 132, 133 AND 139

Band	Mode	DL Channel	f(MHz)	99% BW (MHz)	-26dB BW (MHz)
850MHz	UMTS HSDPA	4357	826.40	4.1585	4.528
		4408	836.60	4.0656	4.586
		4458	846.60	4.2385	4.574
1900MHz		9662	1852.40	4.0764	4.656
		9800	1880.00	4.1471	4.637
		9938	1907.60	4.2316	4.614
1700MHz		1537	1712.40	4.1506	4.651
		1638	1732.60	4.1650	4.644
		1738	1752.60	4.0915	4.679

8.1.1. GSM GPRS

850MHz BAND

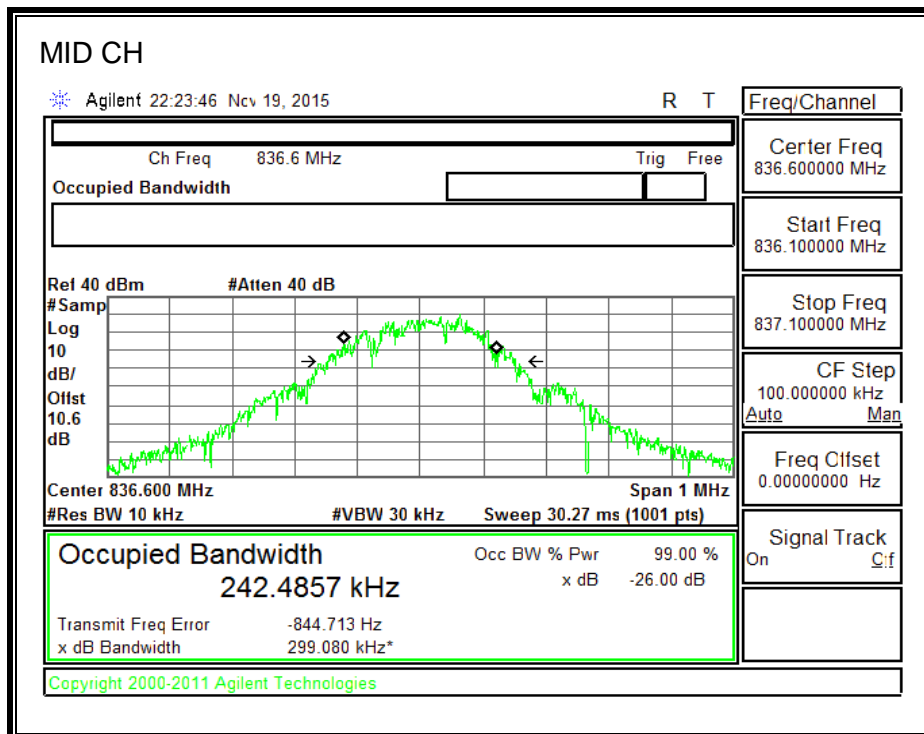
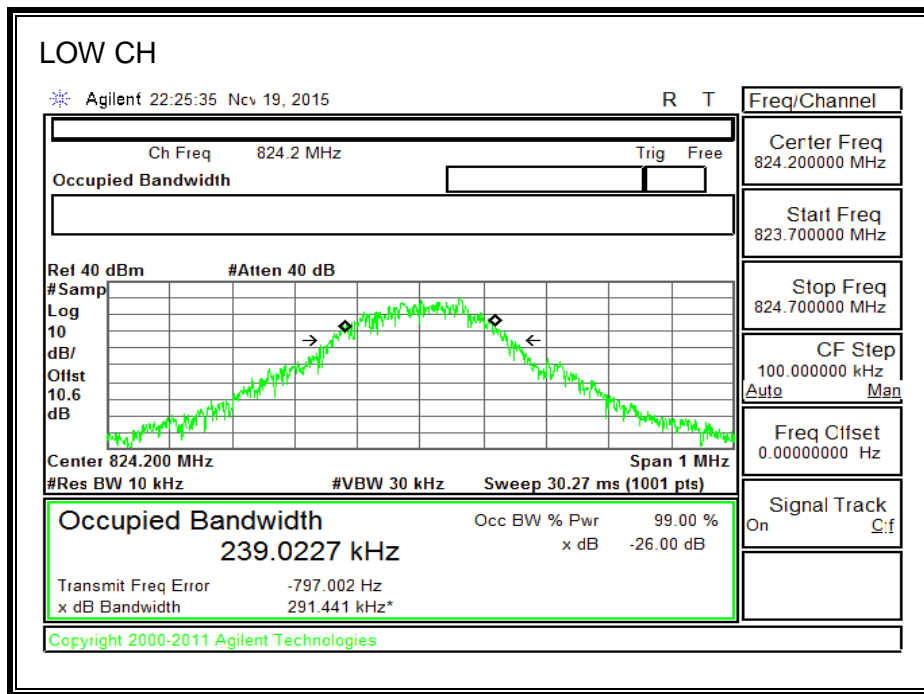

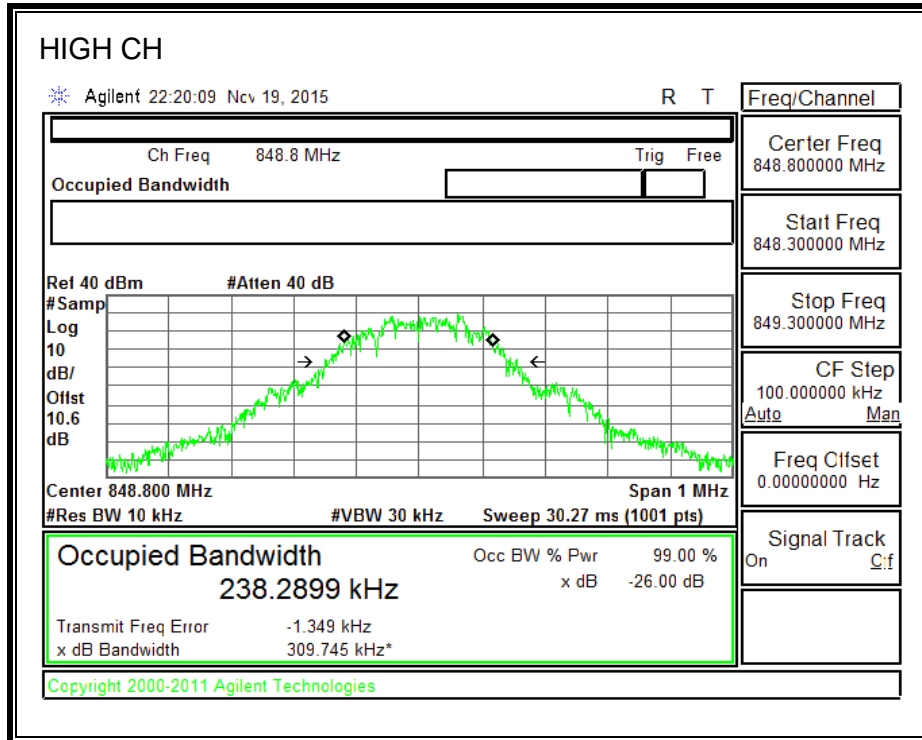

1900MHz BAND

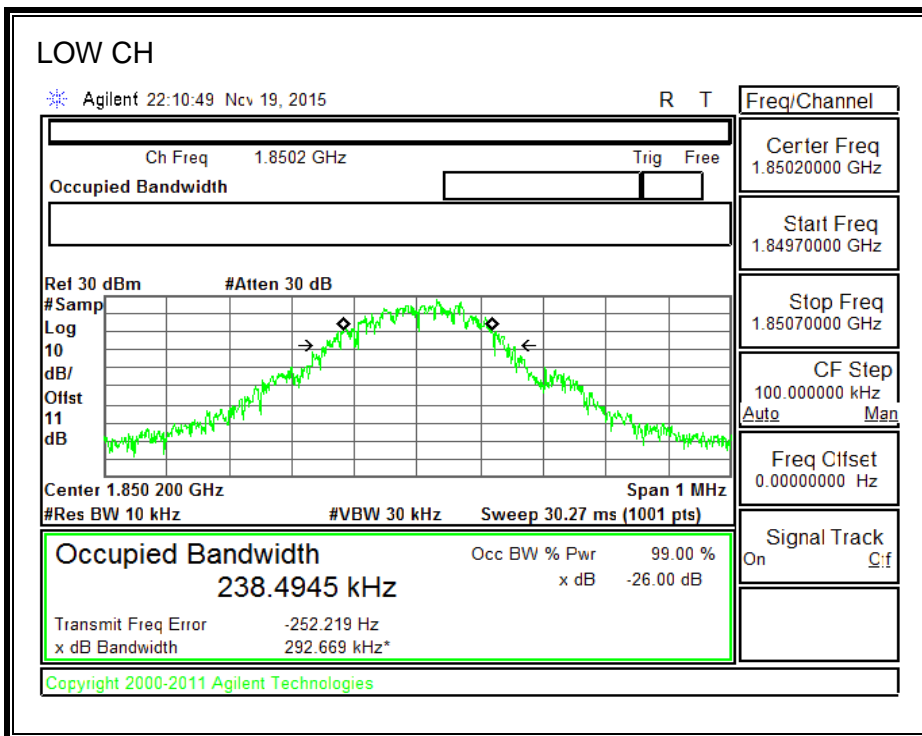

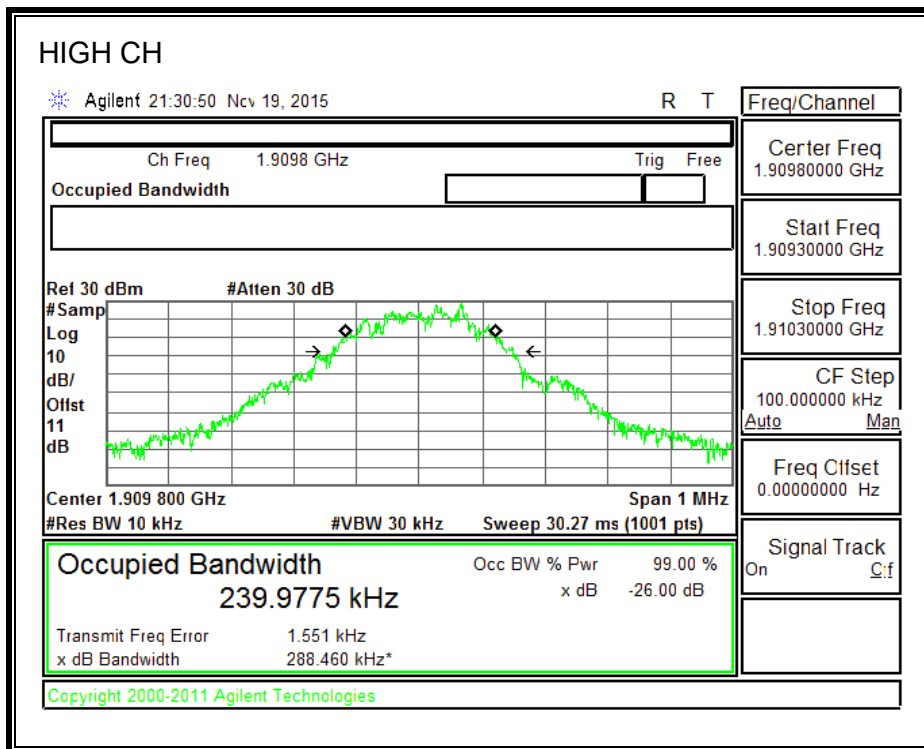
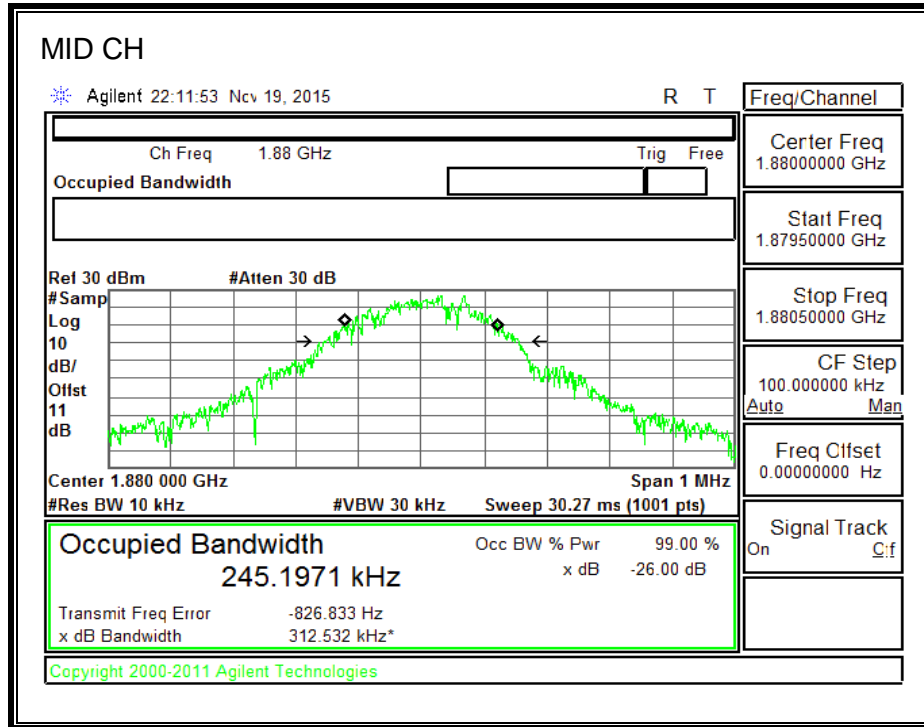

8.1.2. GSM EGPRS

850MHz BAND

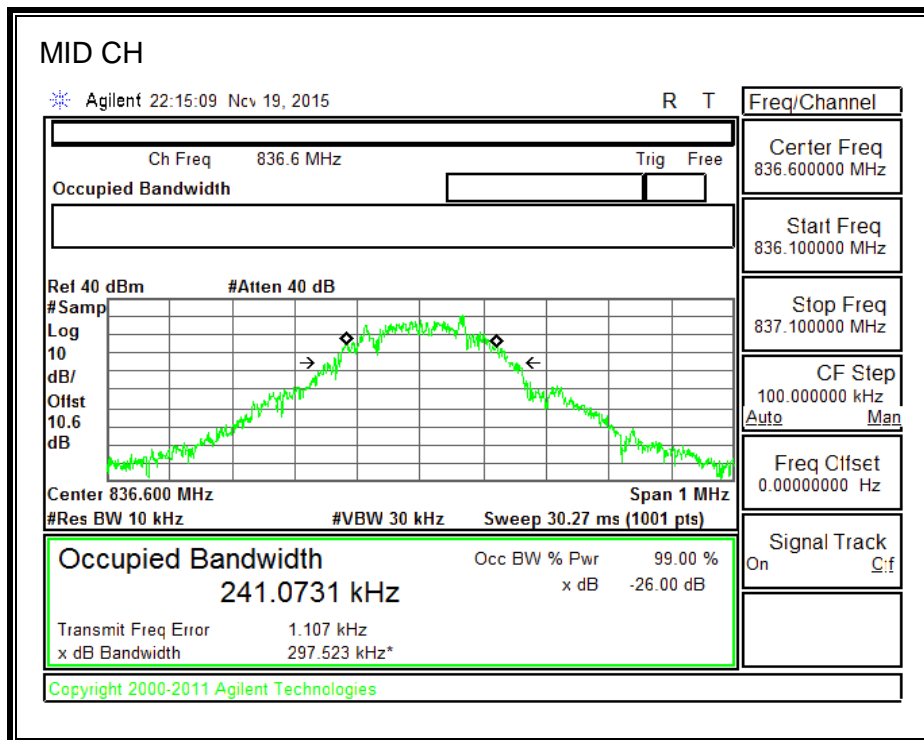
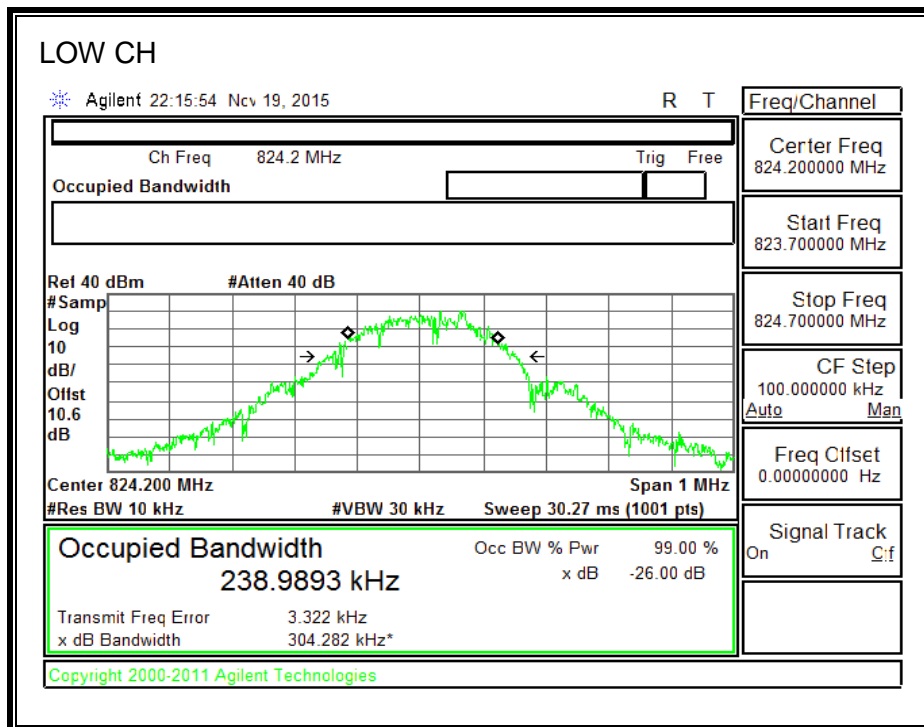

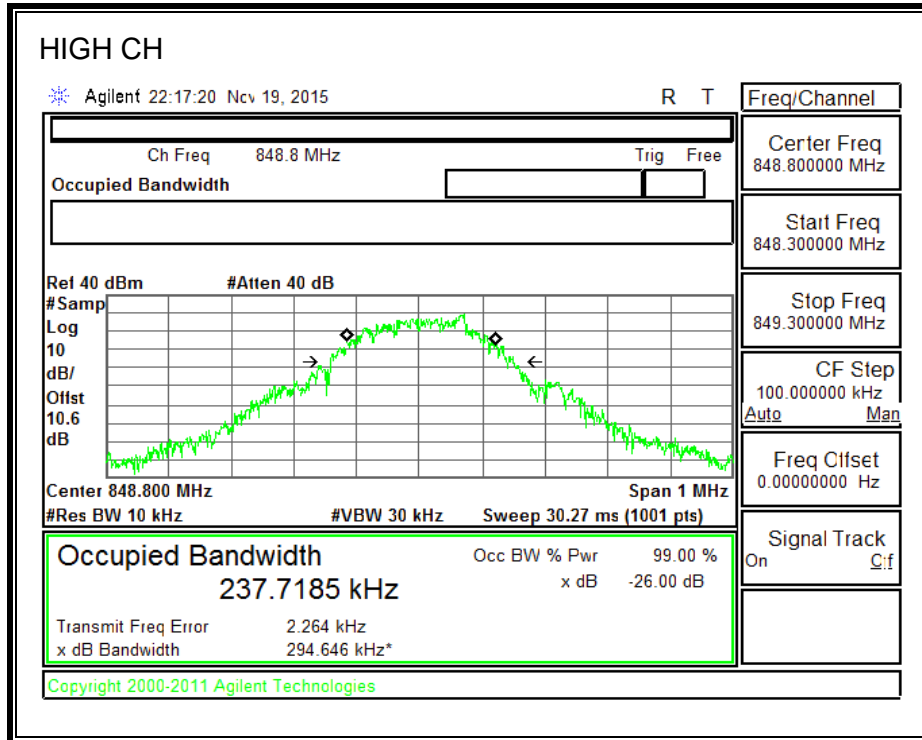

1900MHz BAND

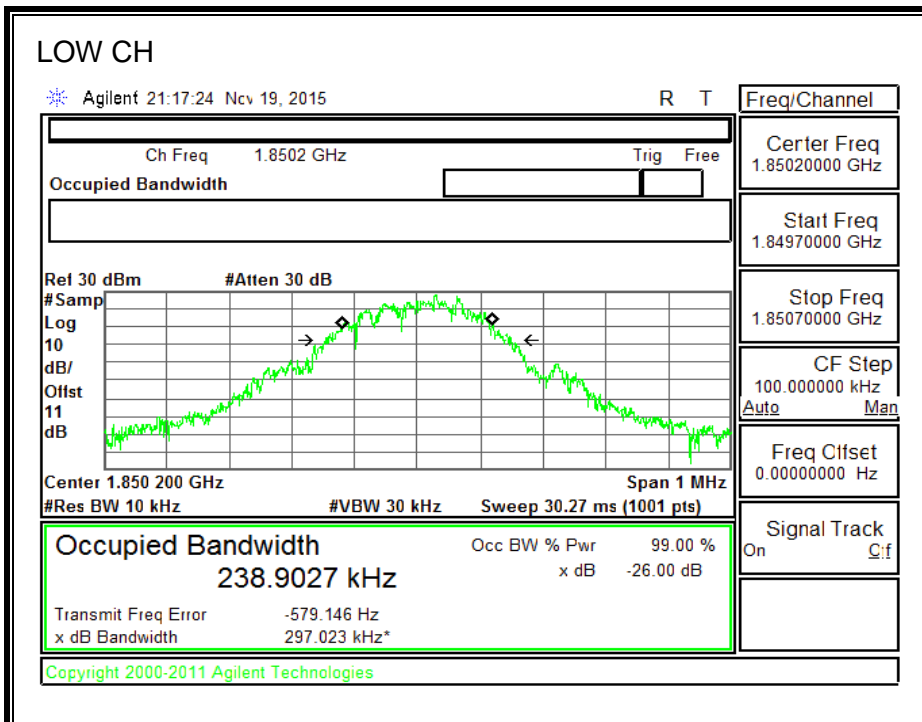

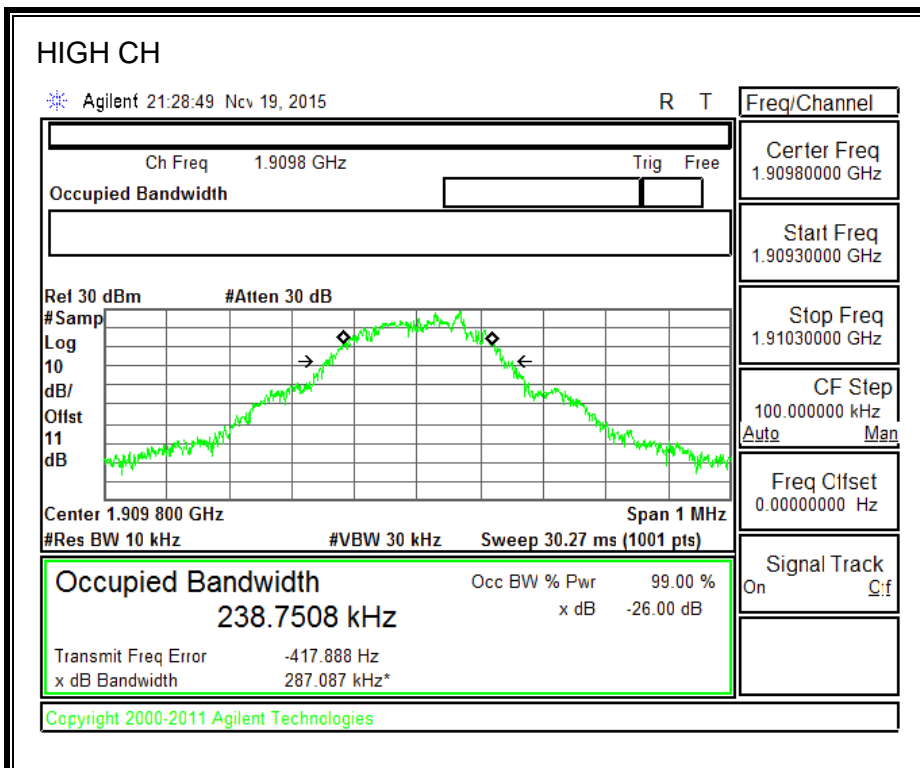
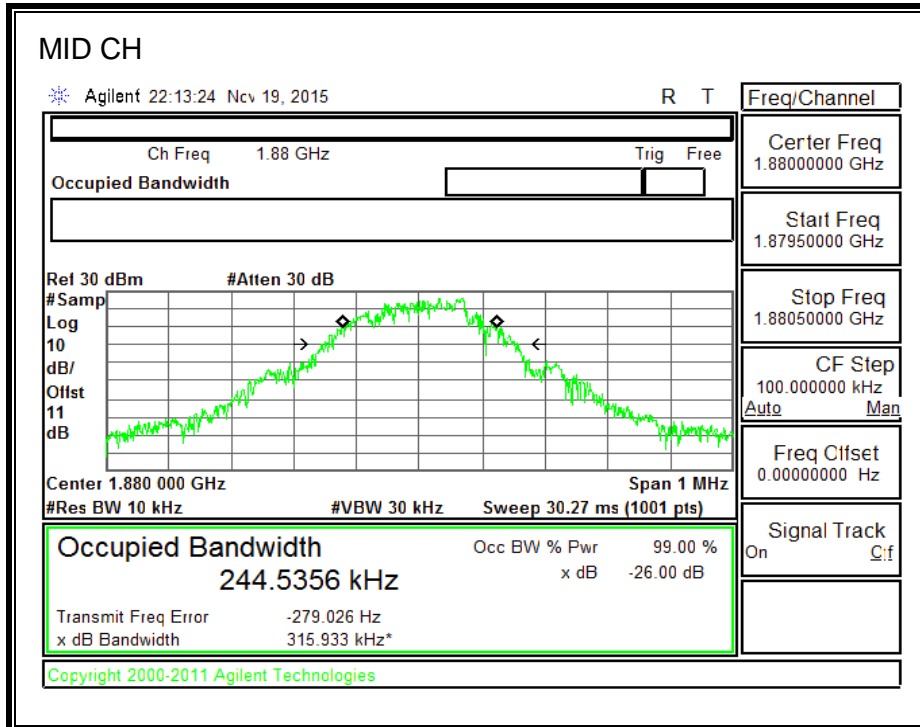

8.1.3. CDMA2000 1xRTT

850MHz BAND

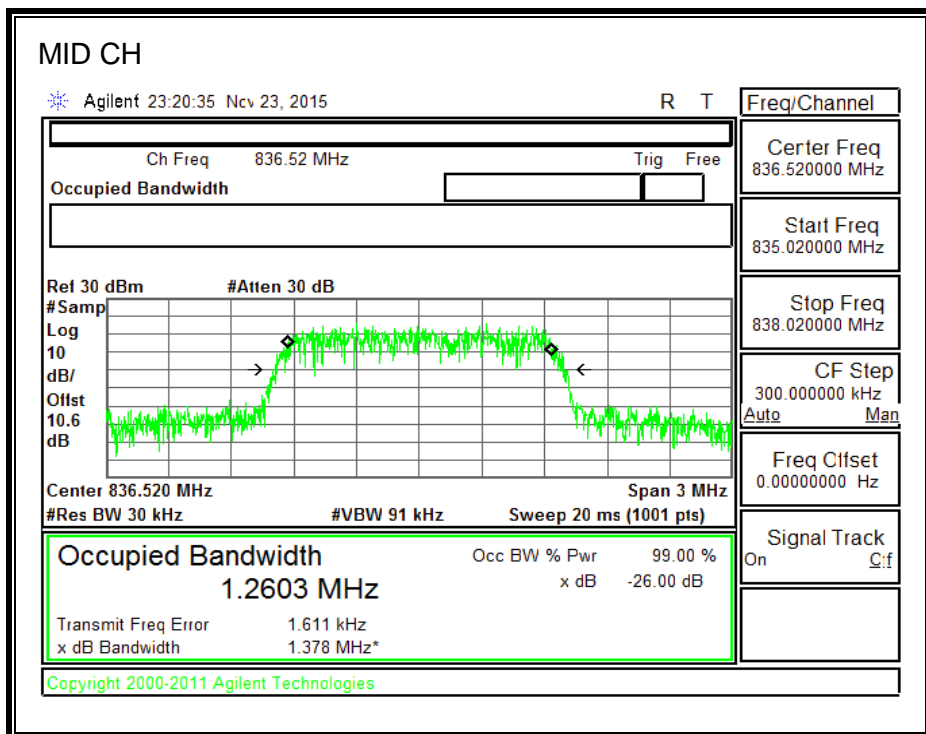
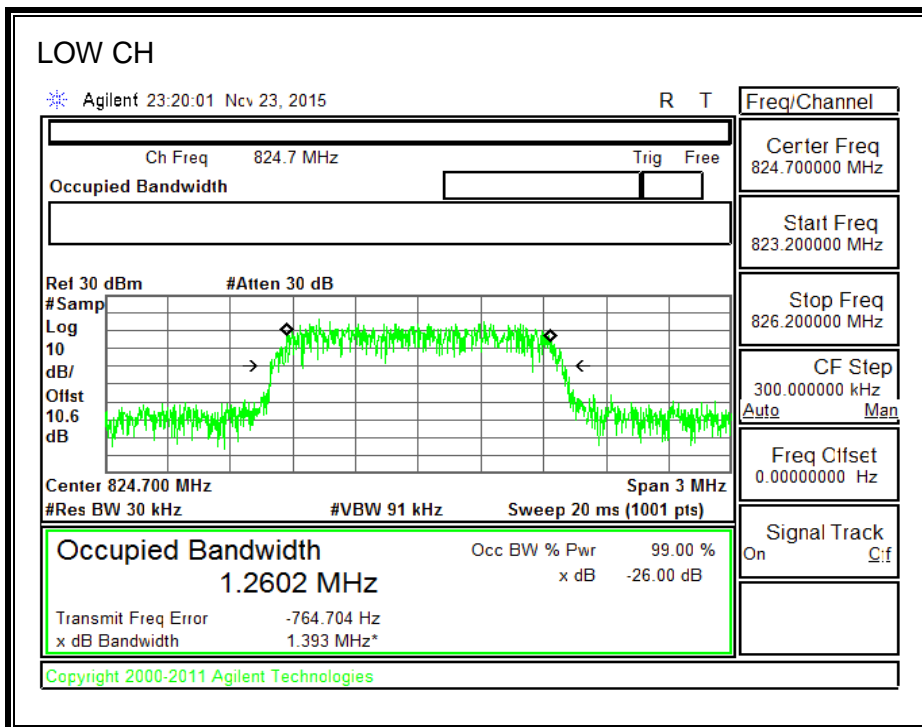

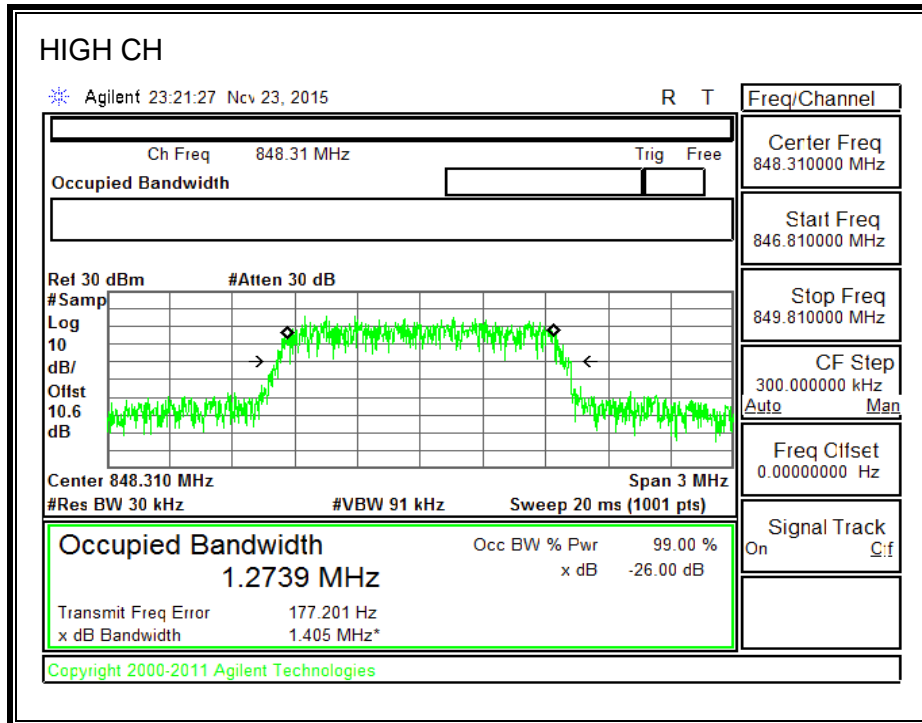

1900MHz BAND

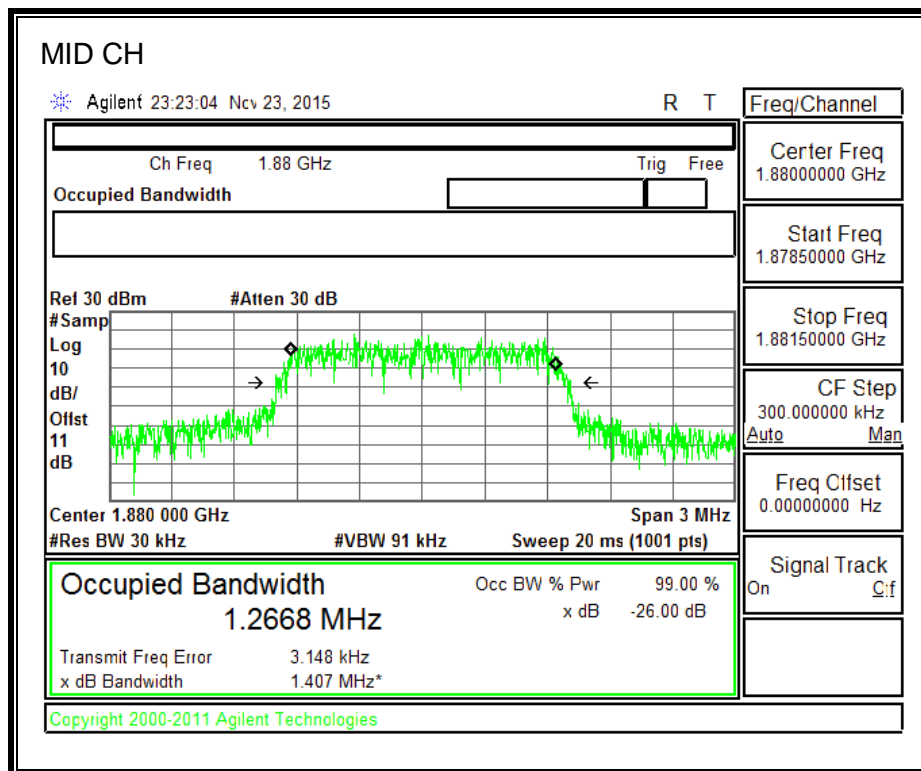
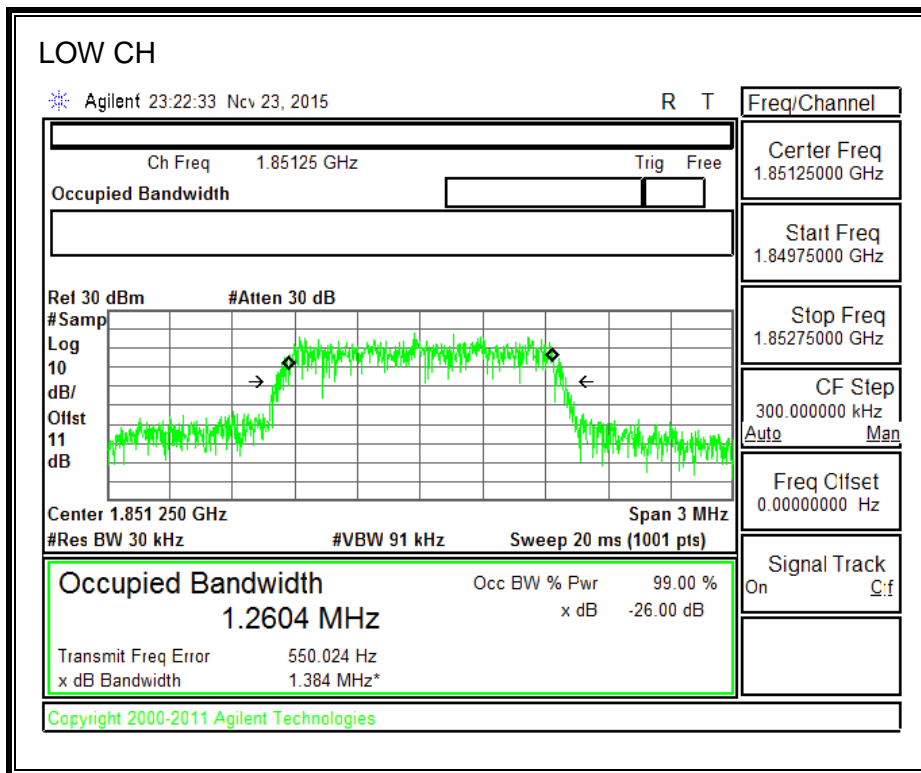

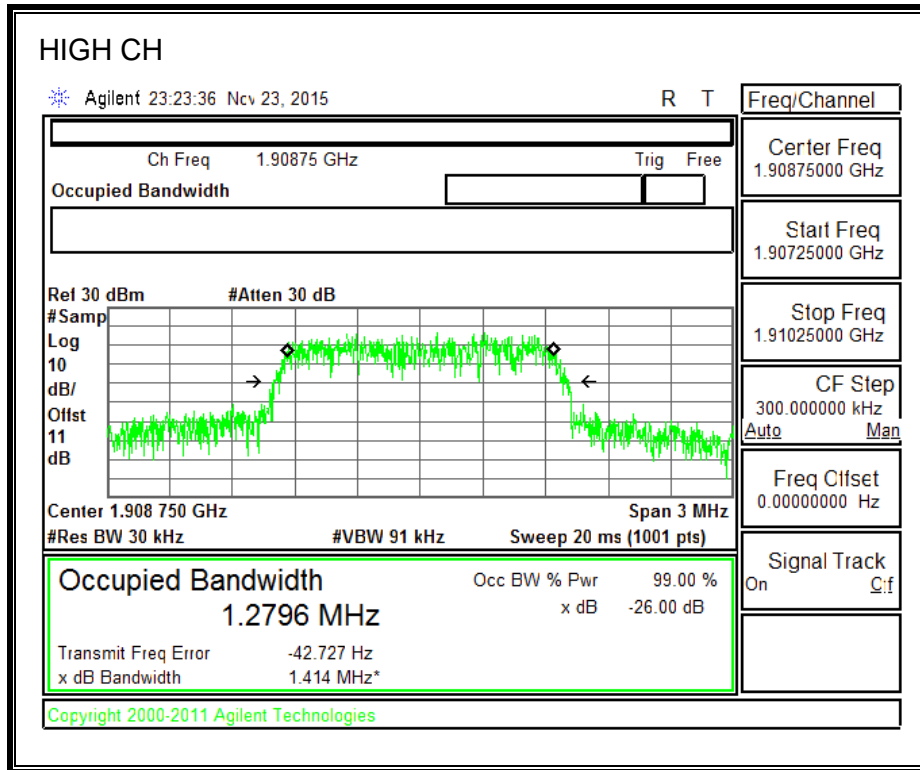

1700MHz BAND

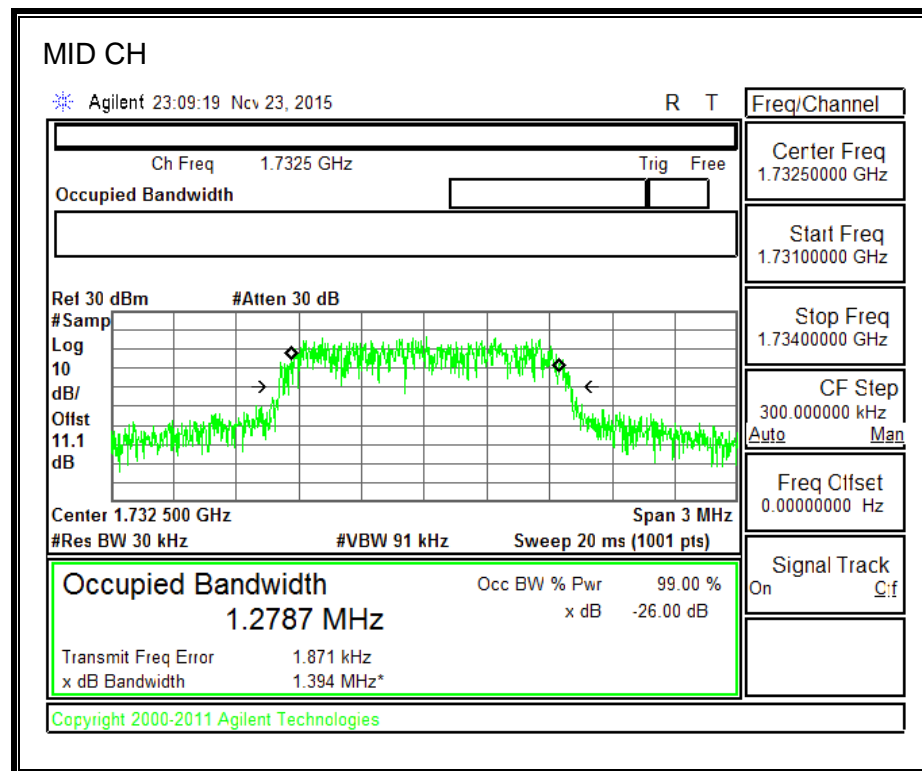
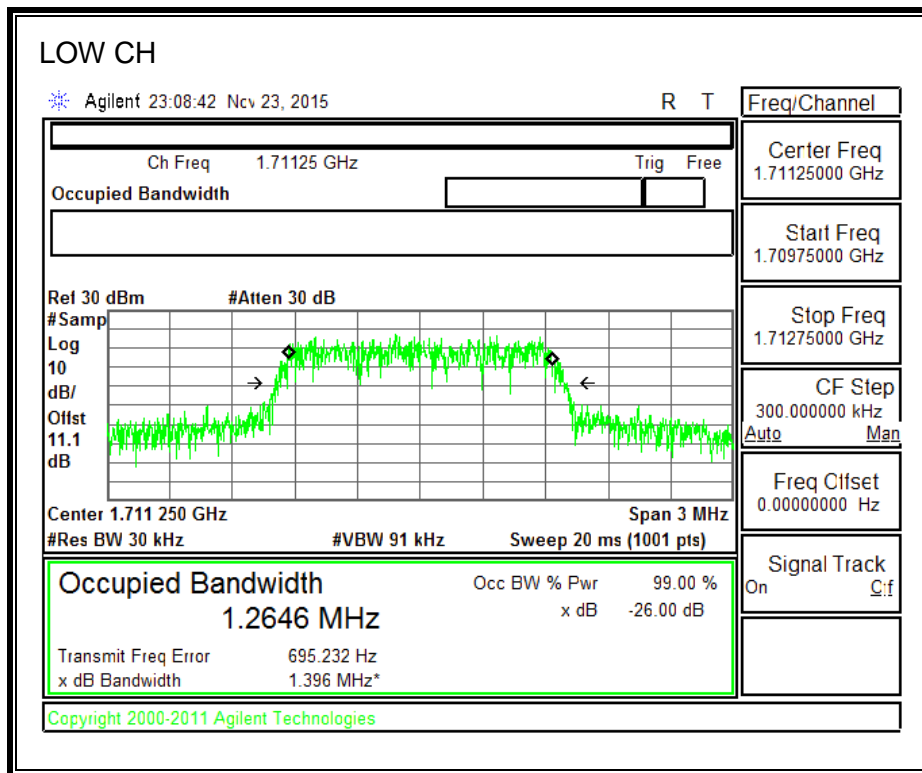

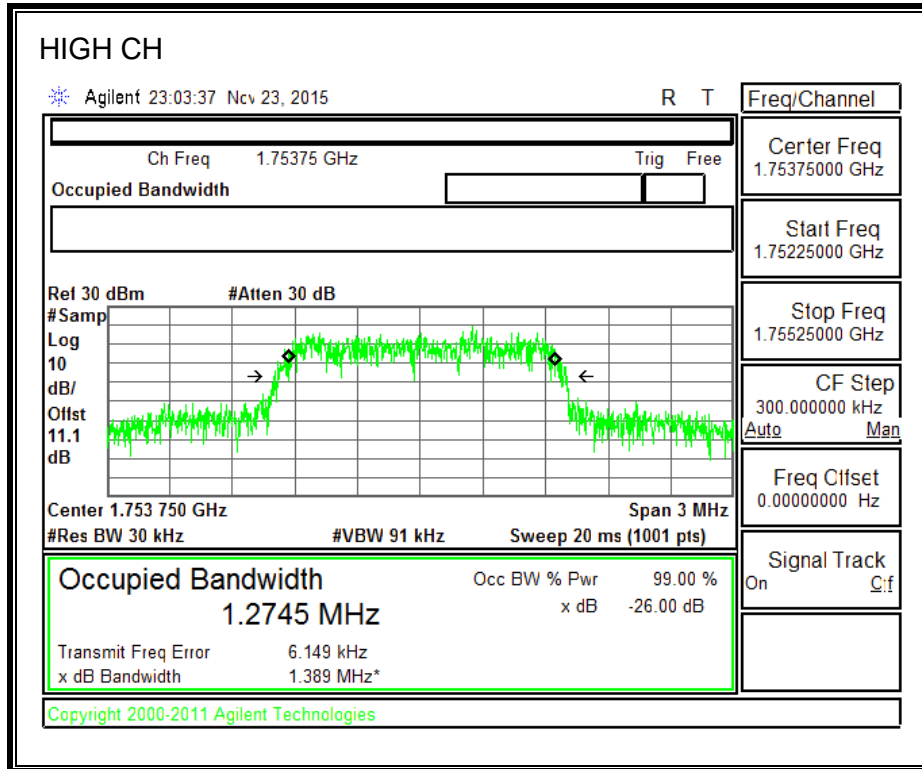

800MHz SECONDARY BAND

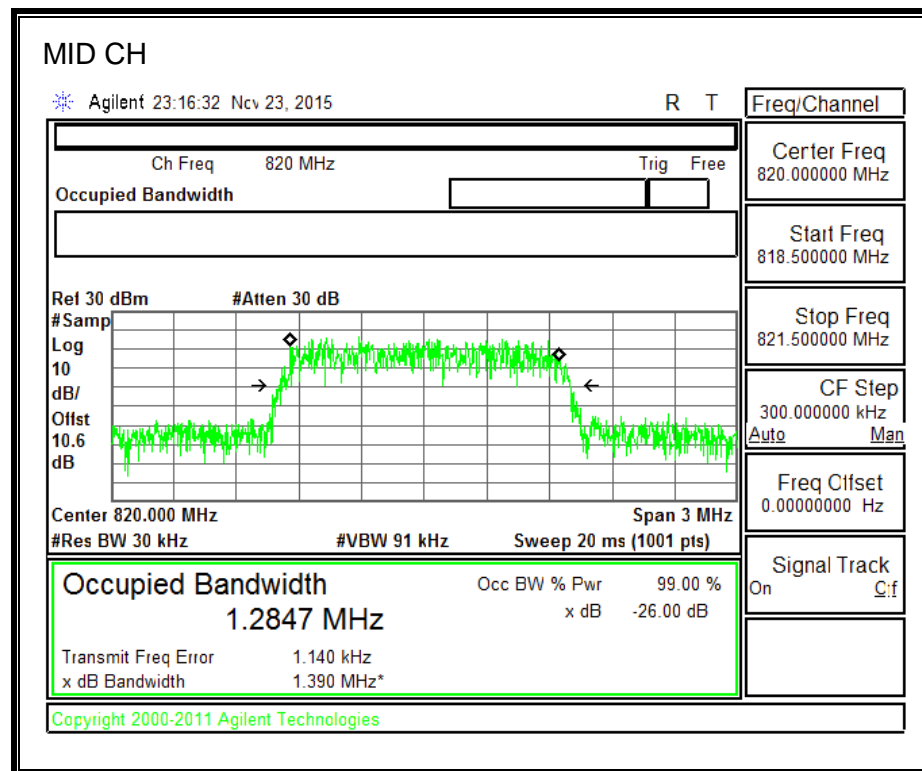
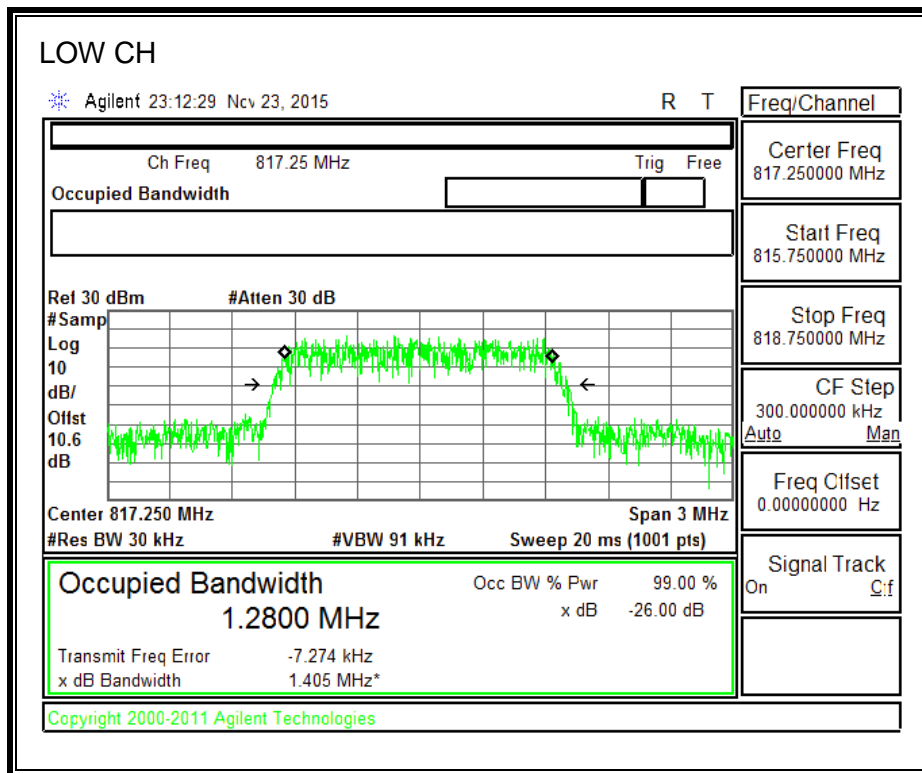

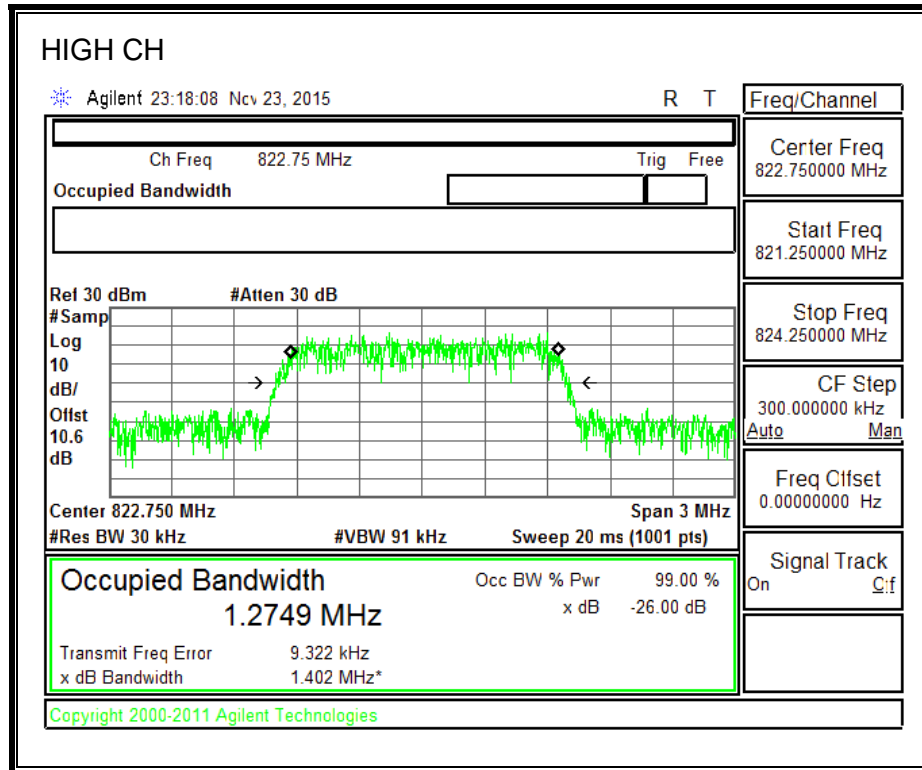

8.1.4. CDMA2000 EVDO Rev. A

850MHz BAND

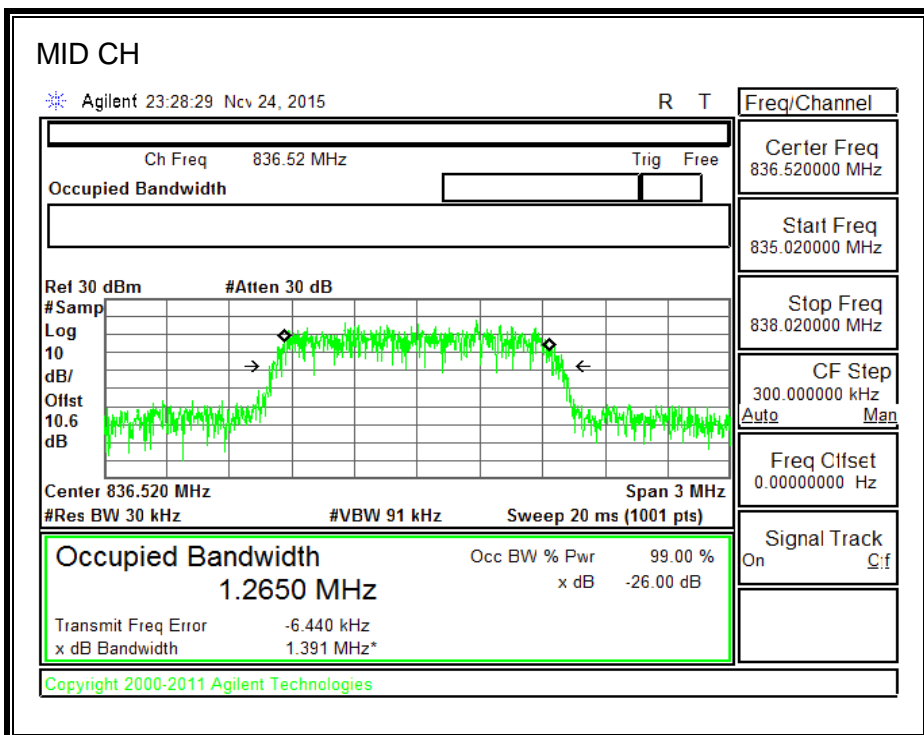
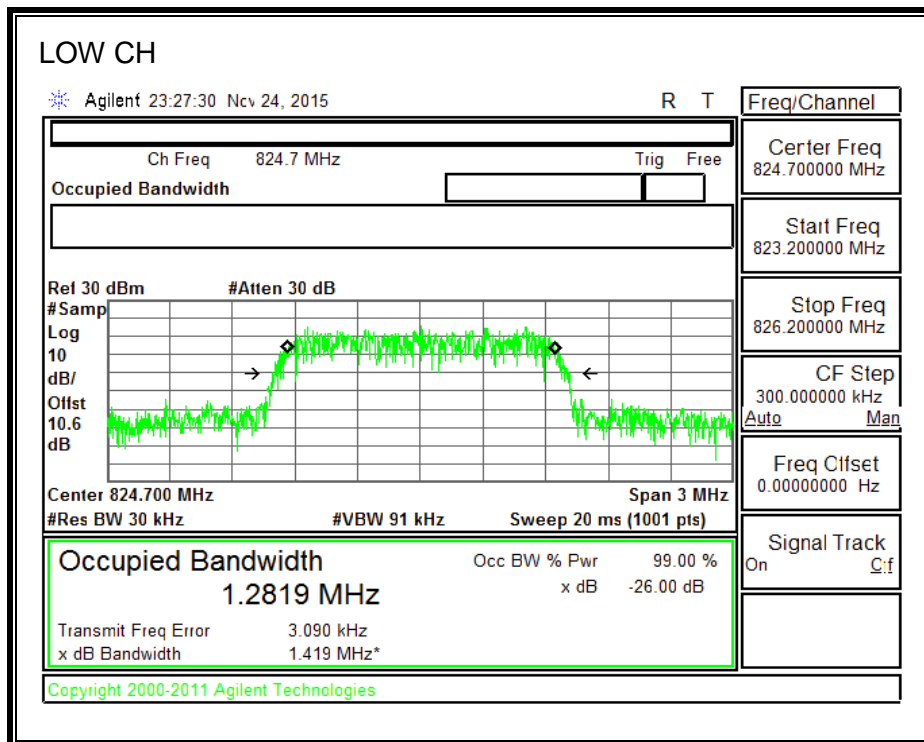

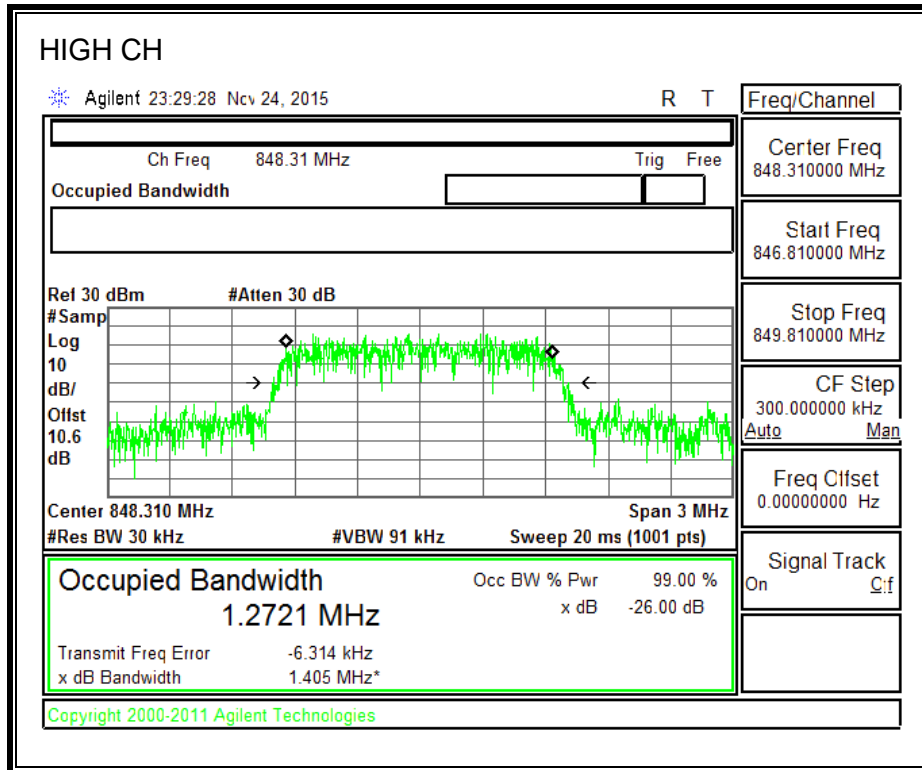

1900MHz BAND

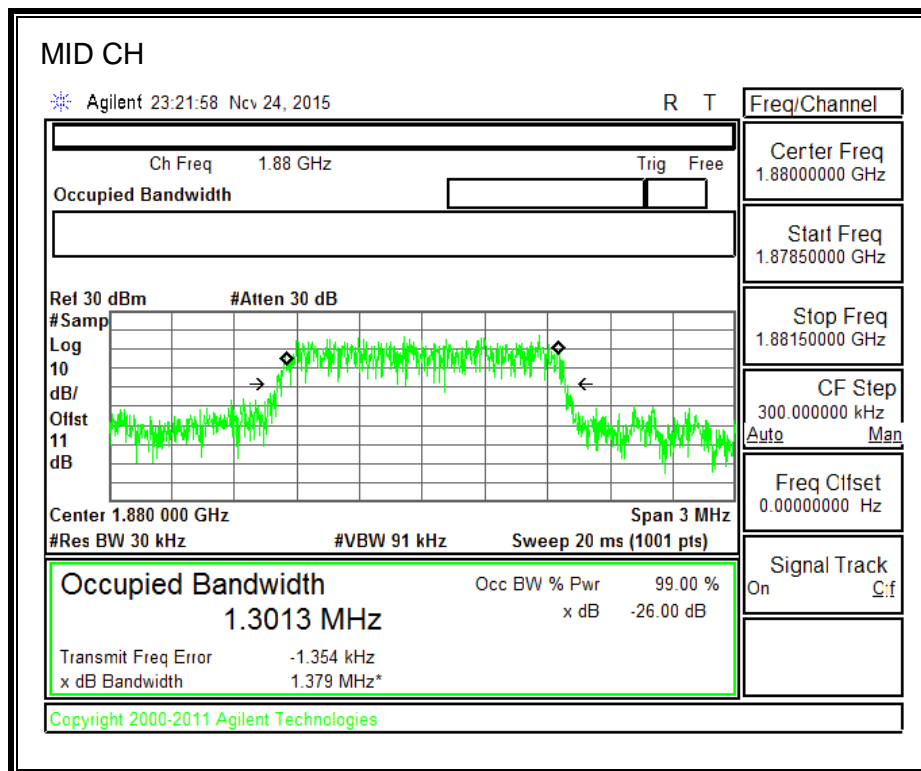
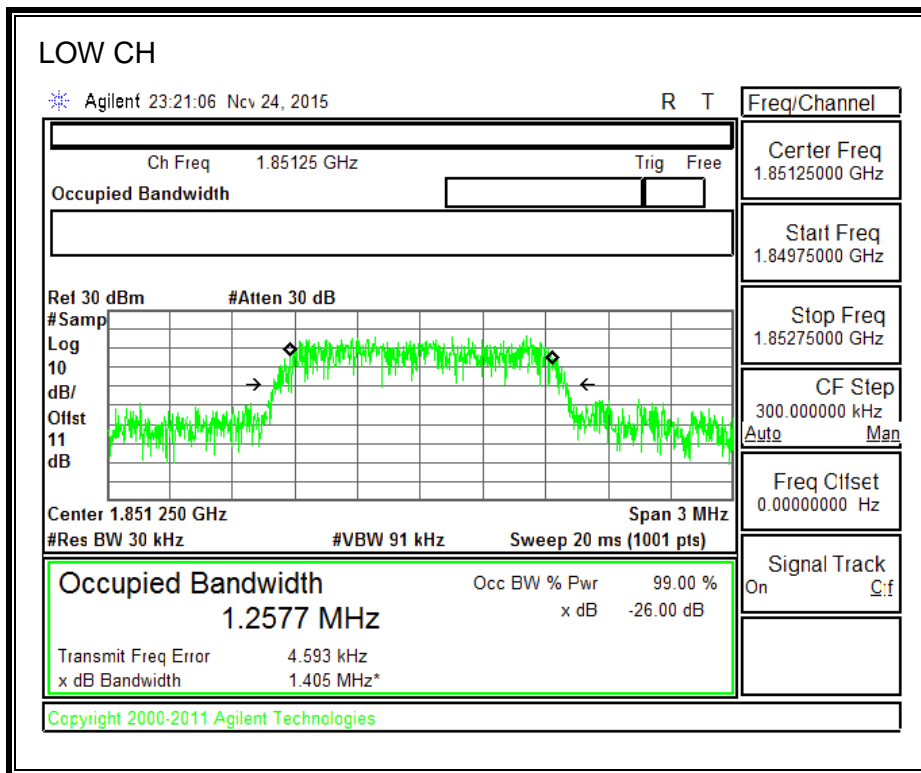

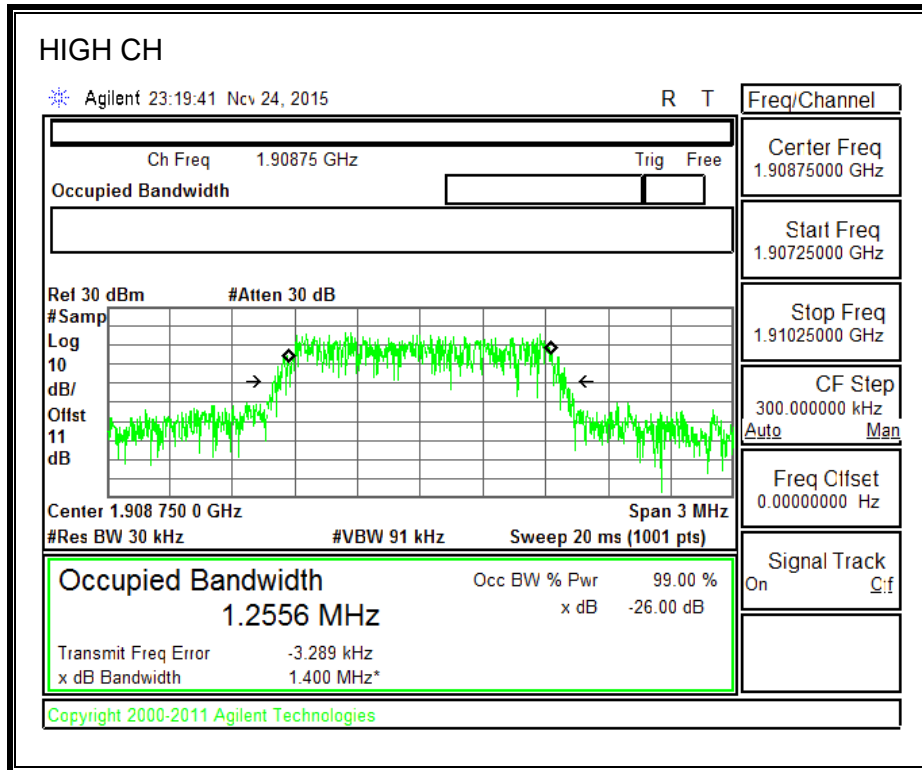

1700MHz BAND

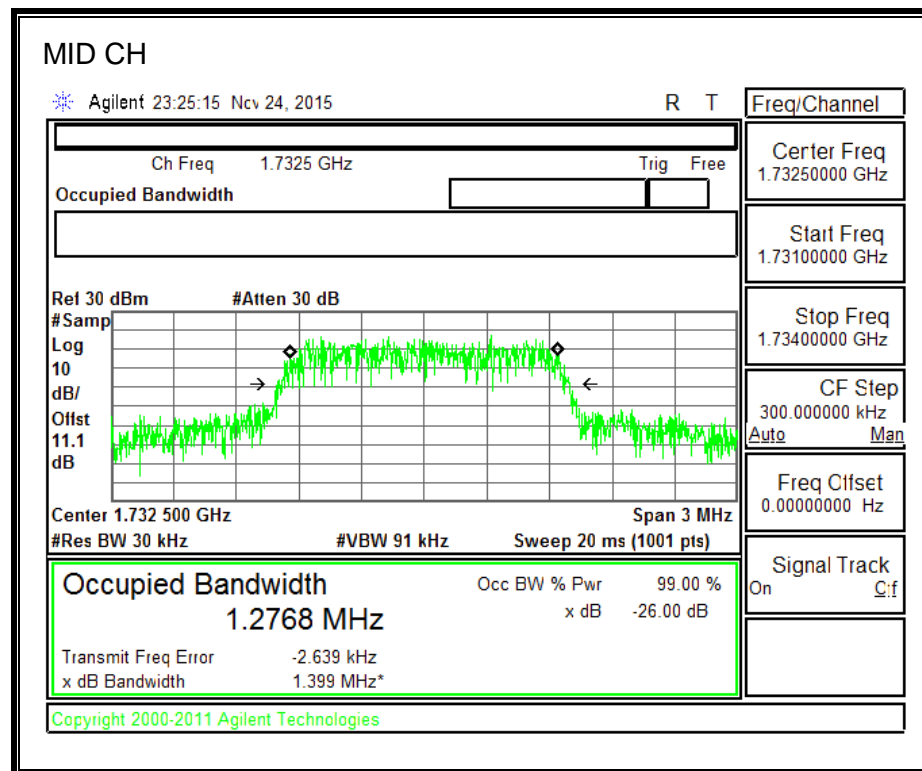
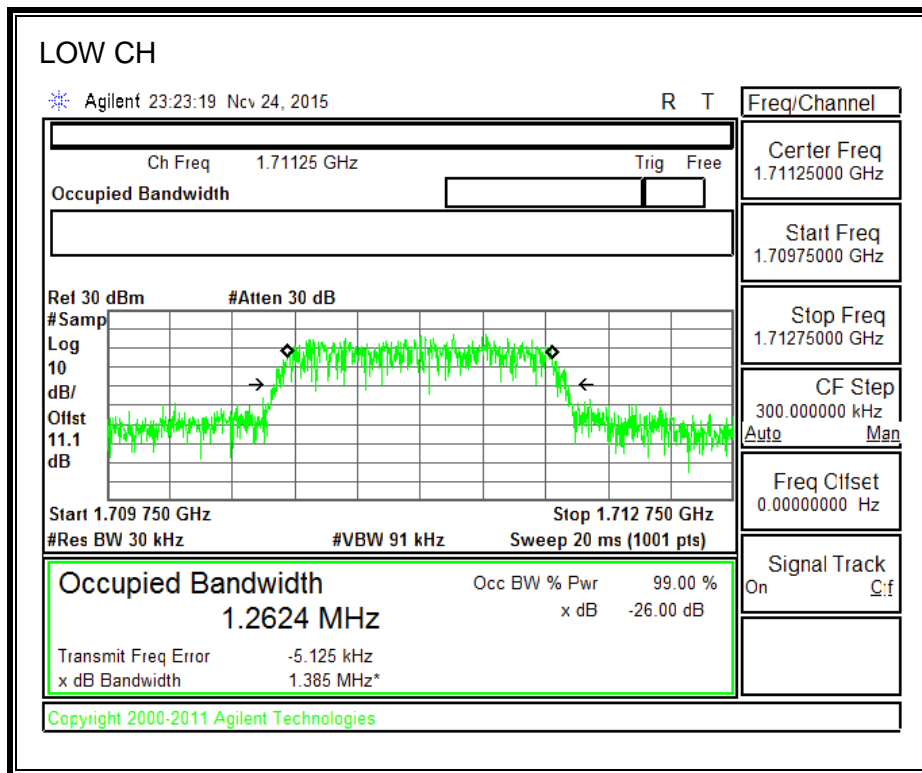

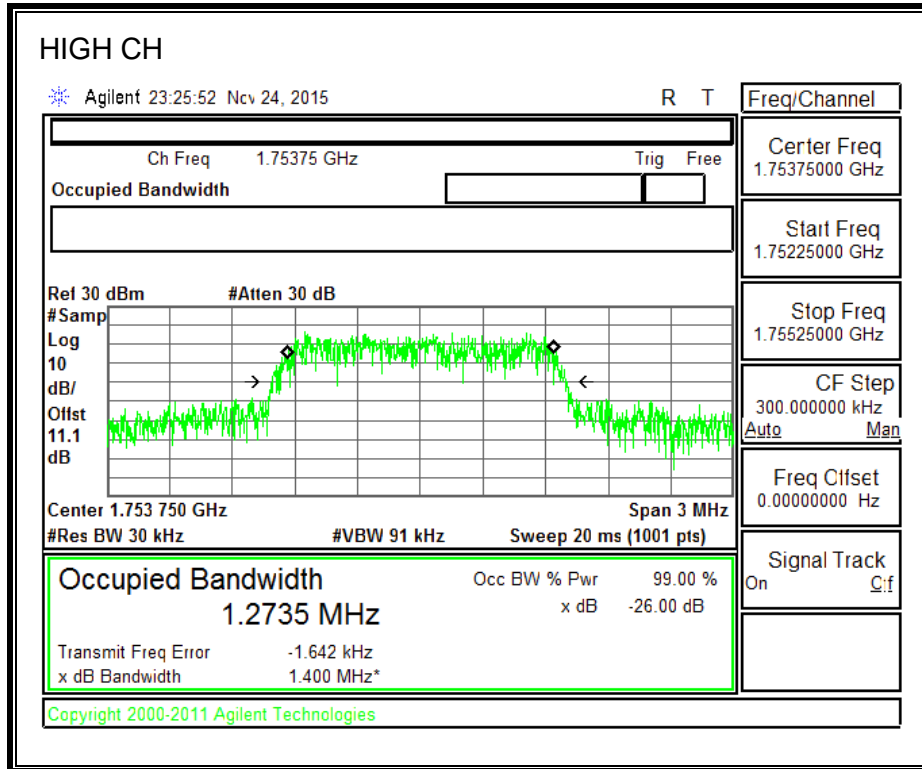

800MHz SECONDARY BAND

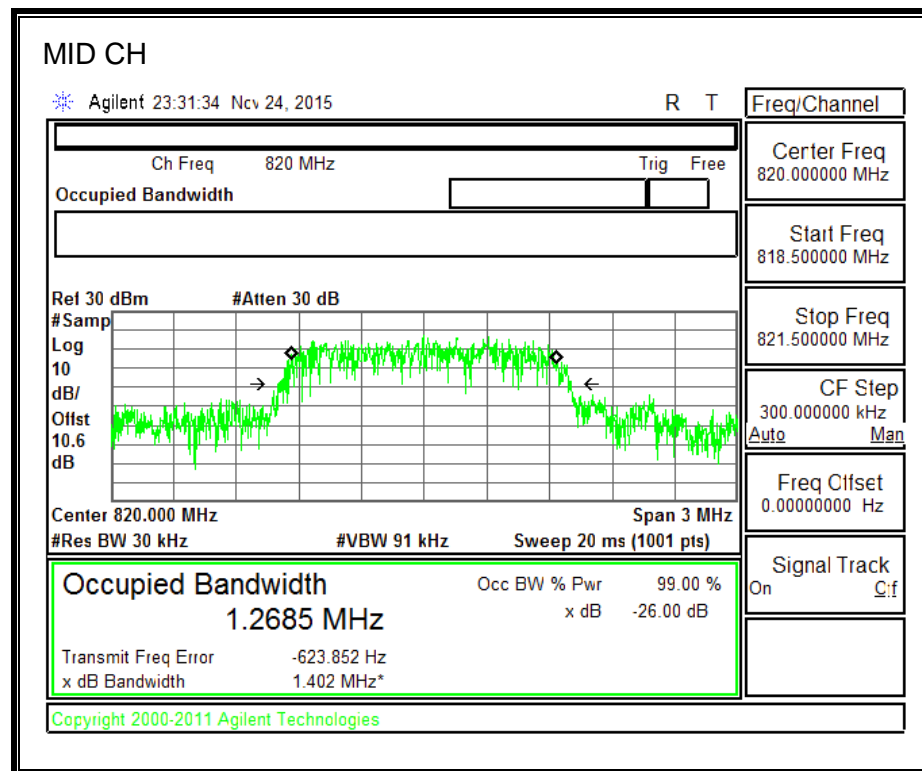
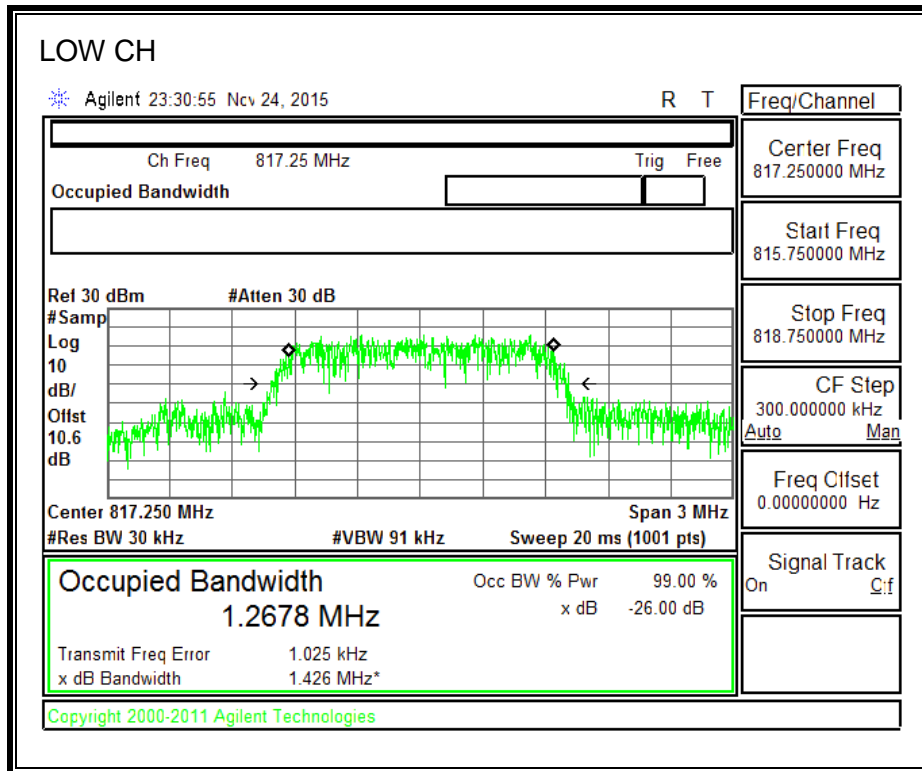

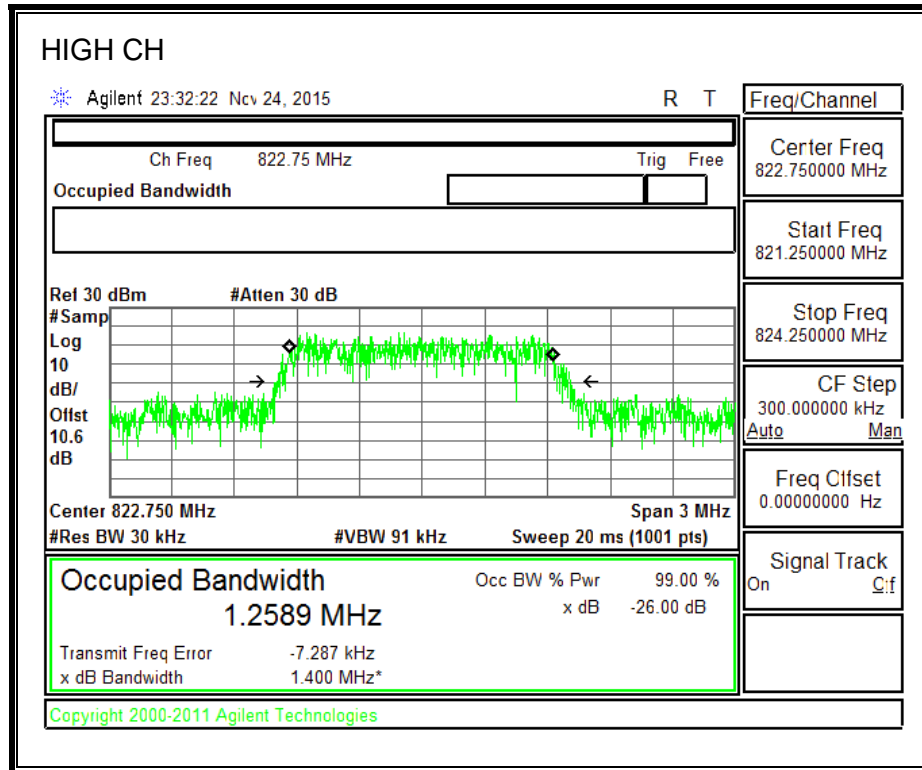

8.1.5. UMTS REL 99

850MHz BAND

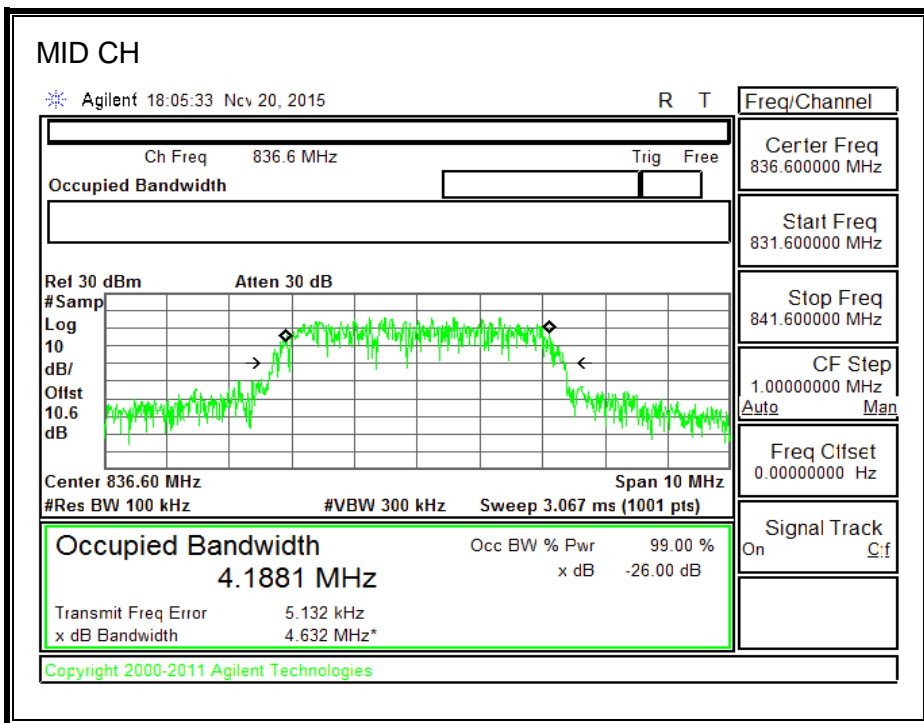
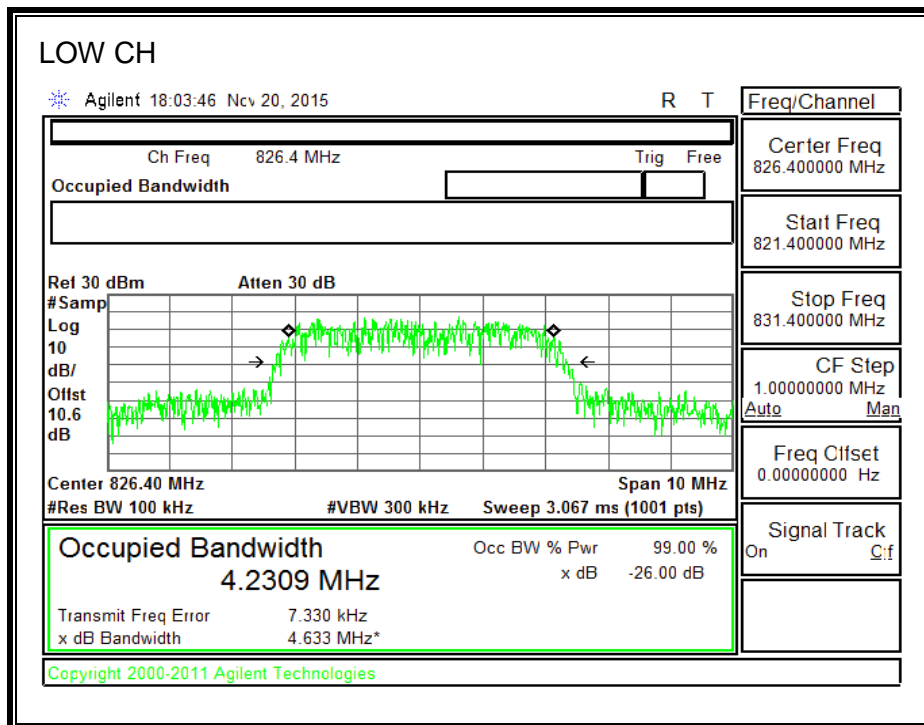

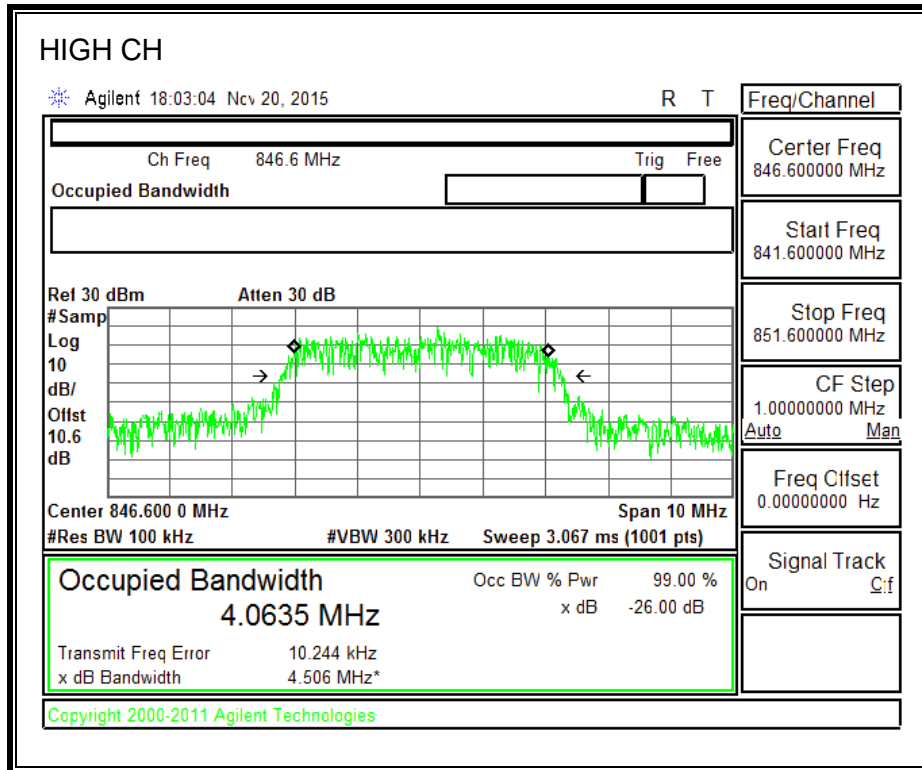

1900MHz BAND

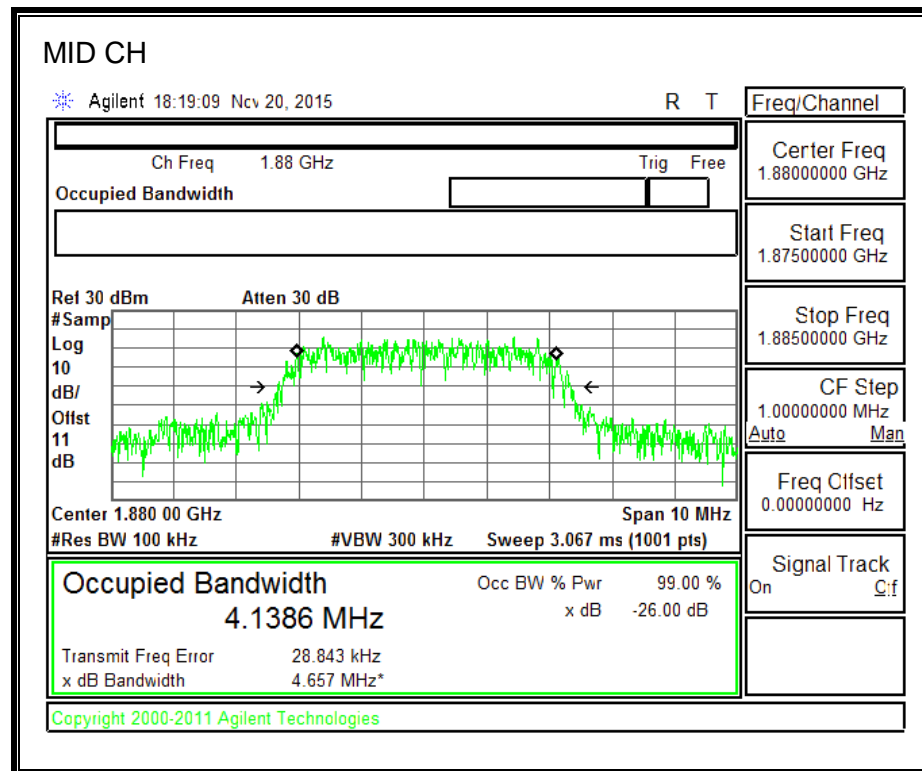
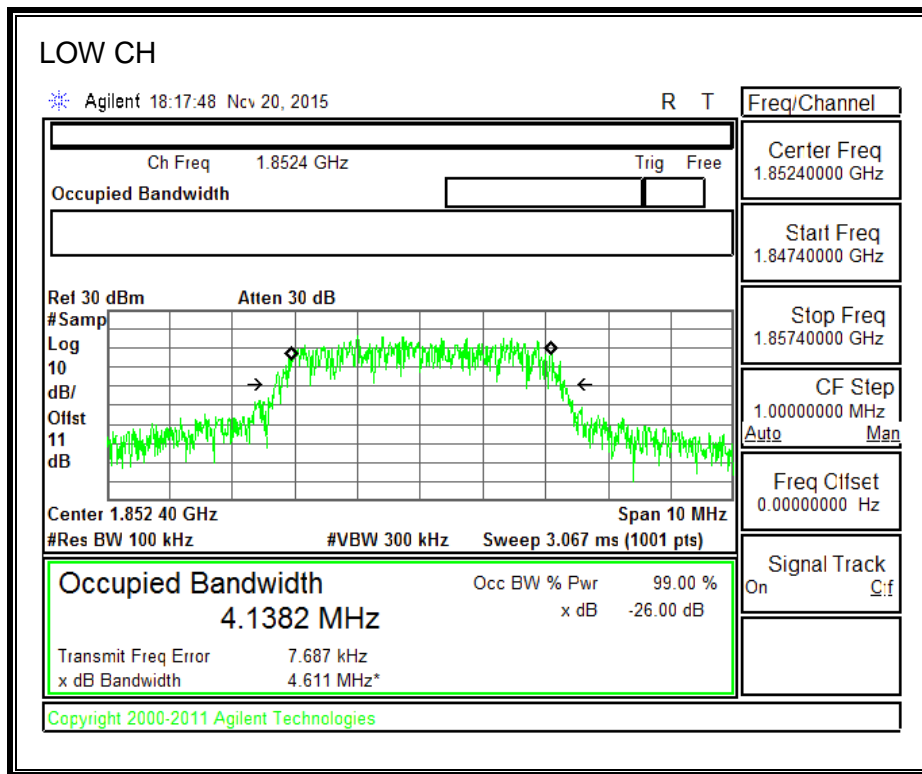

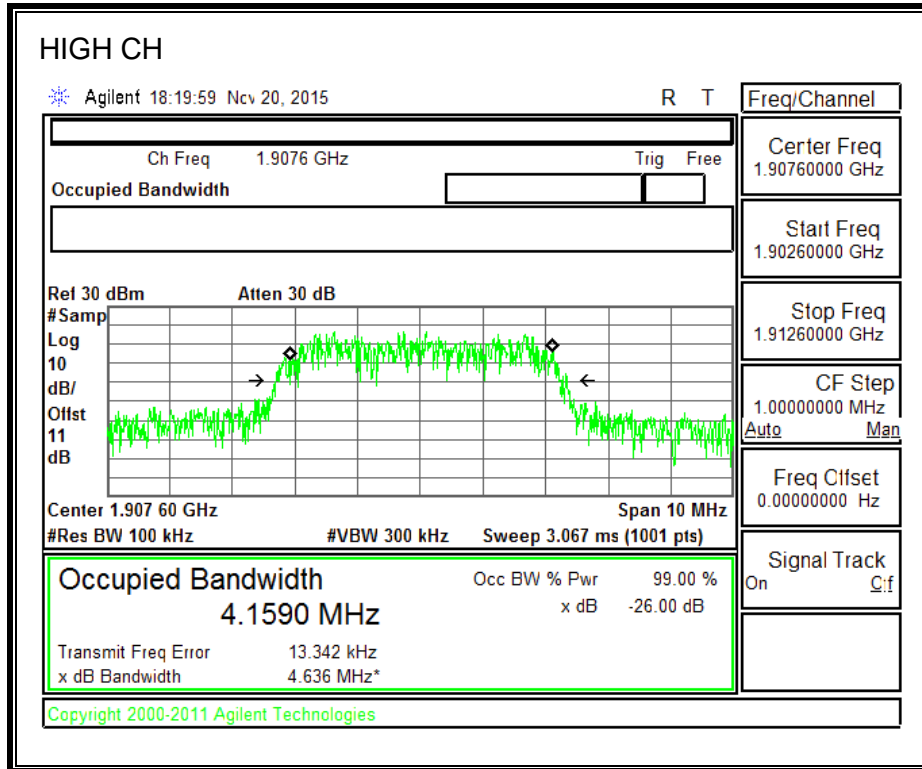

1700MHz BAND

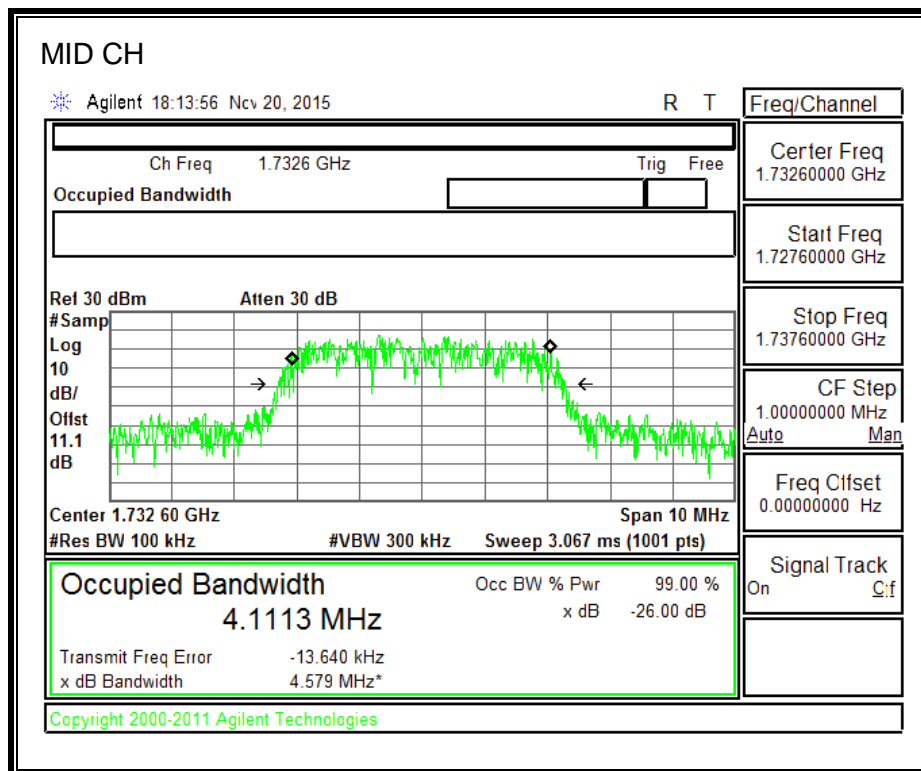
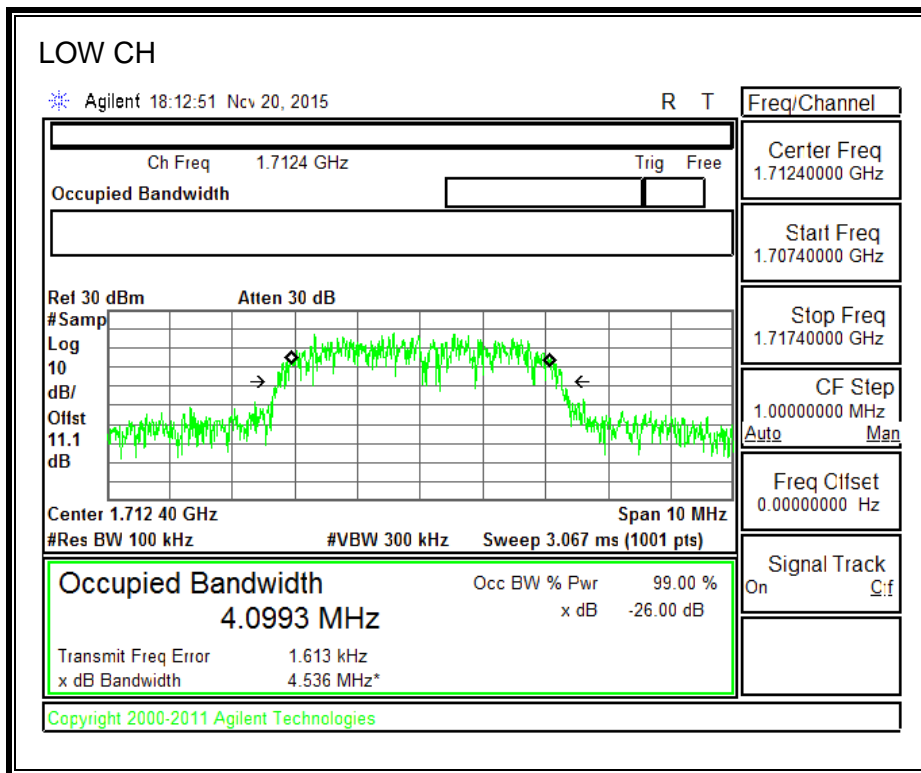

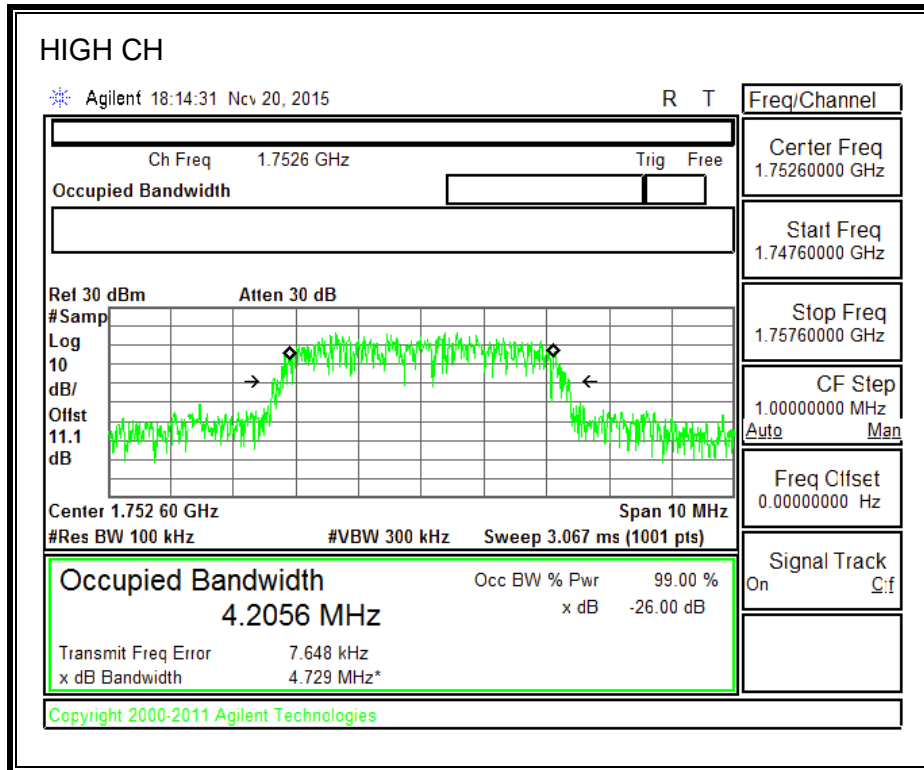

8.1.6. UMTS HSDPA

850MHz BAND

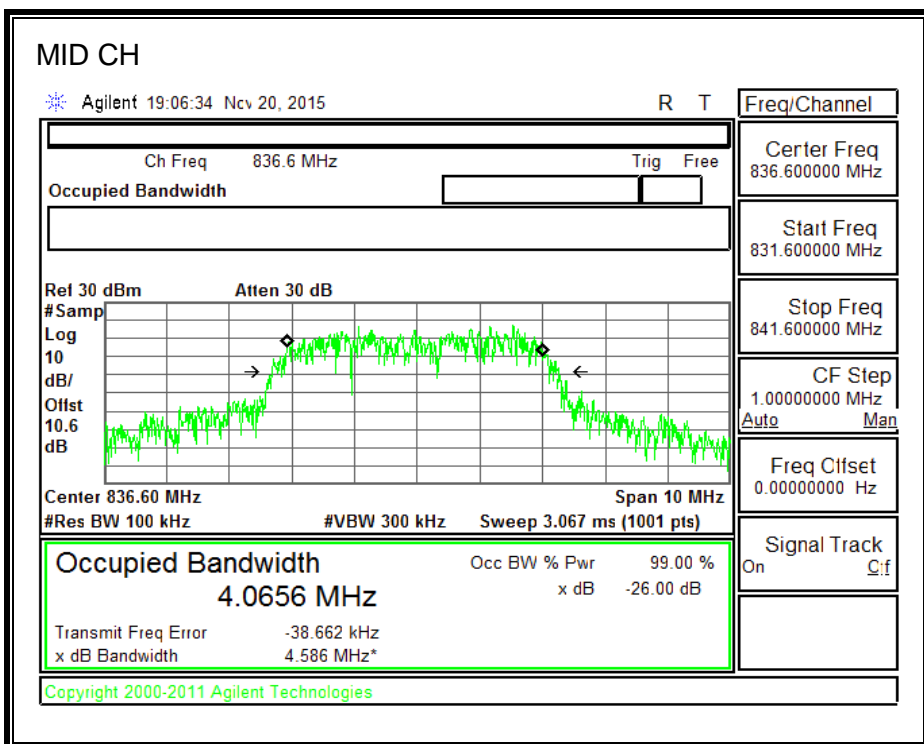
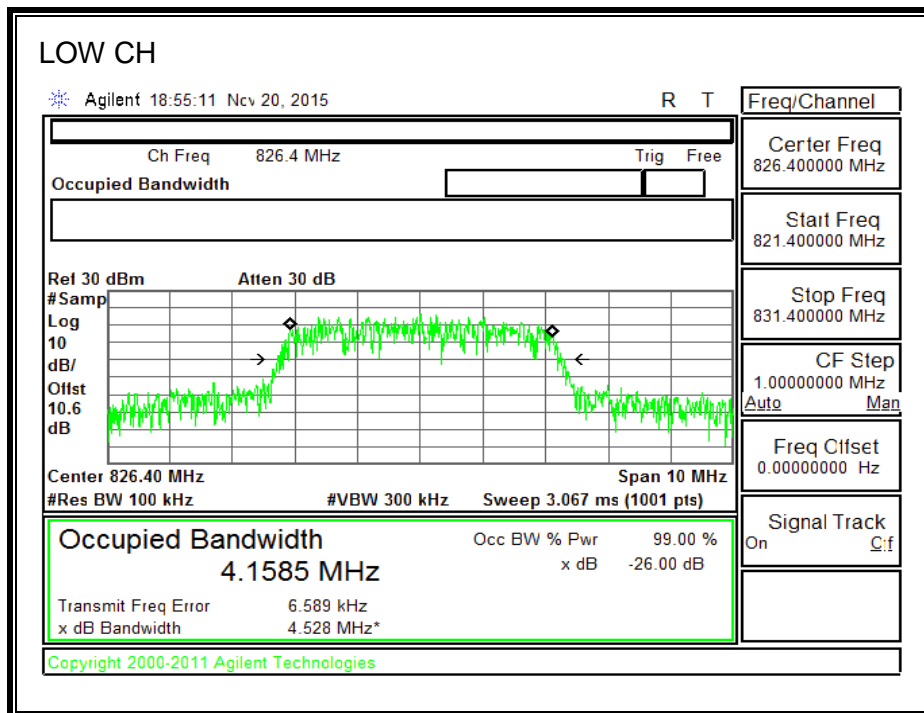

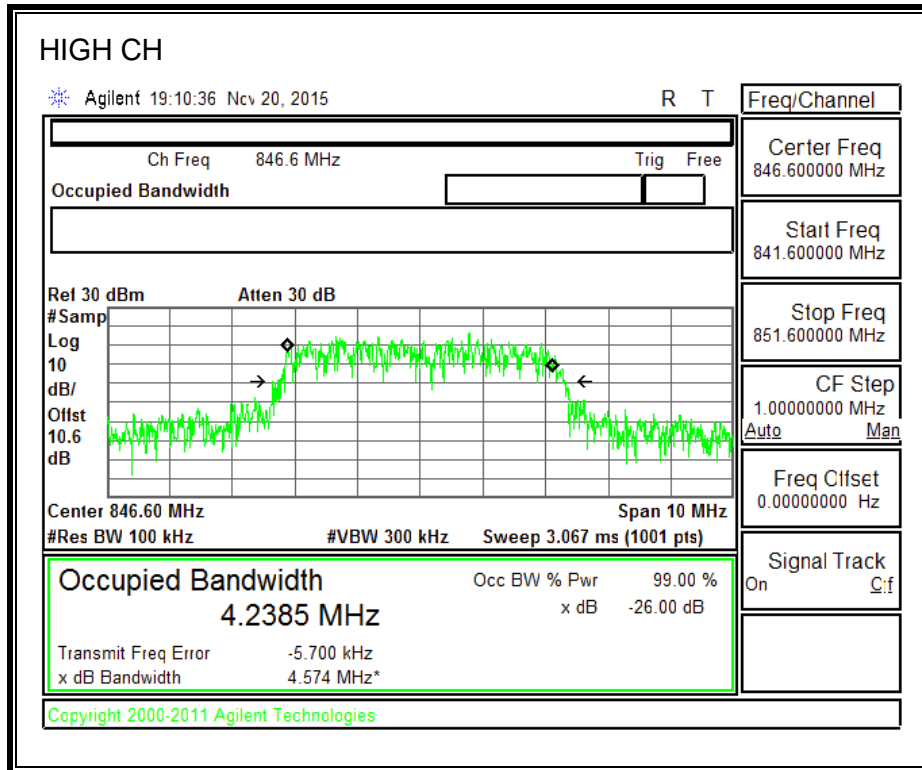

1900MHz BAND

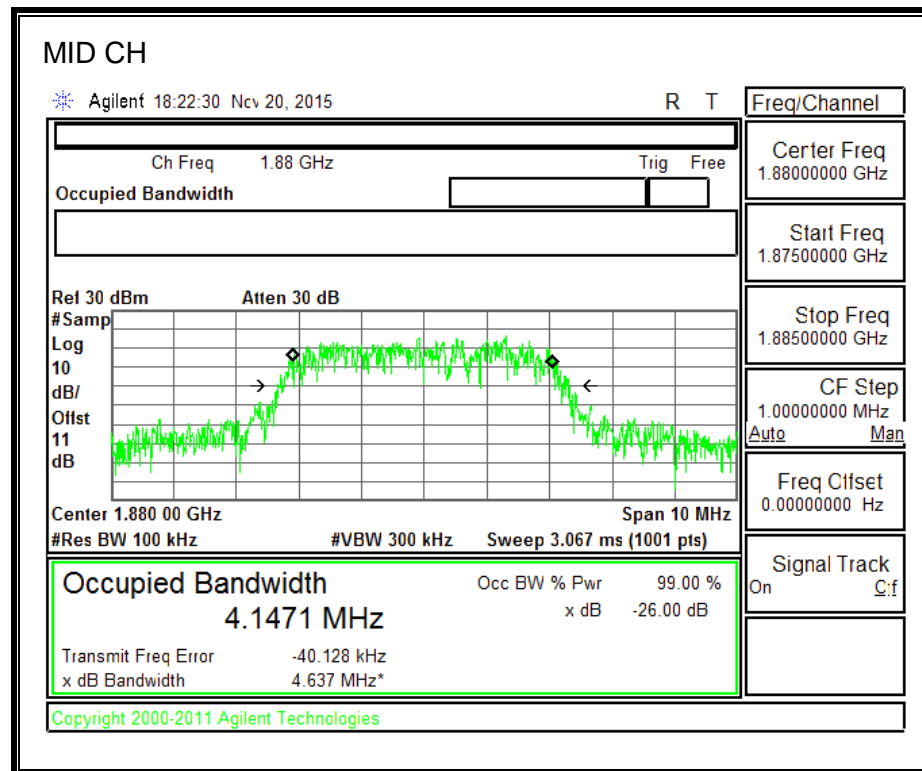
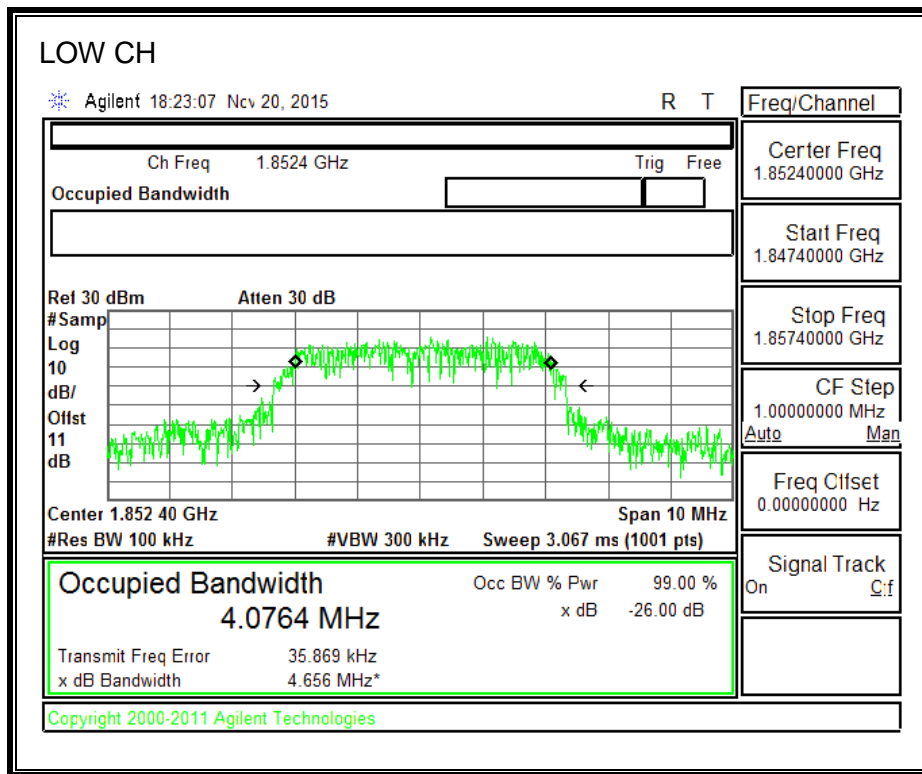

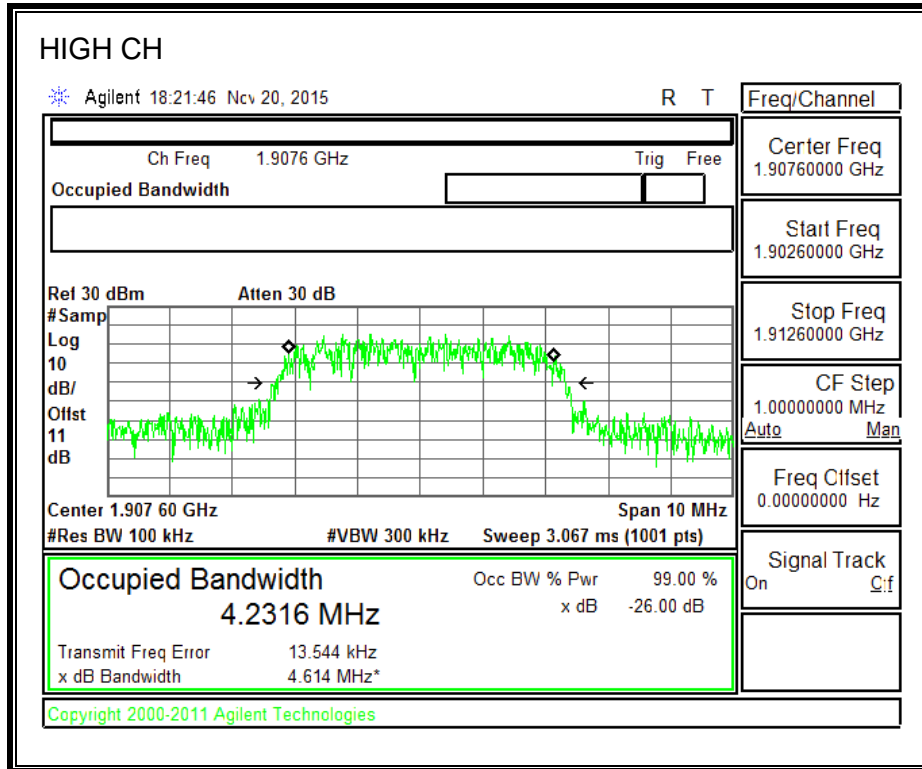

1700MHz BAND

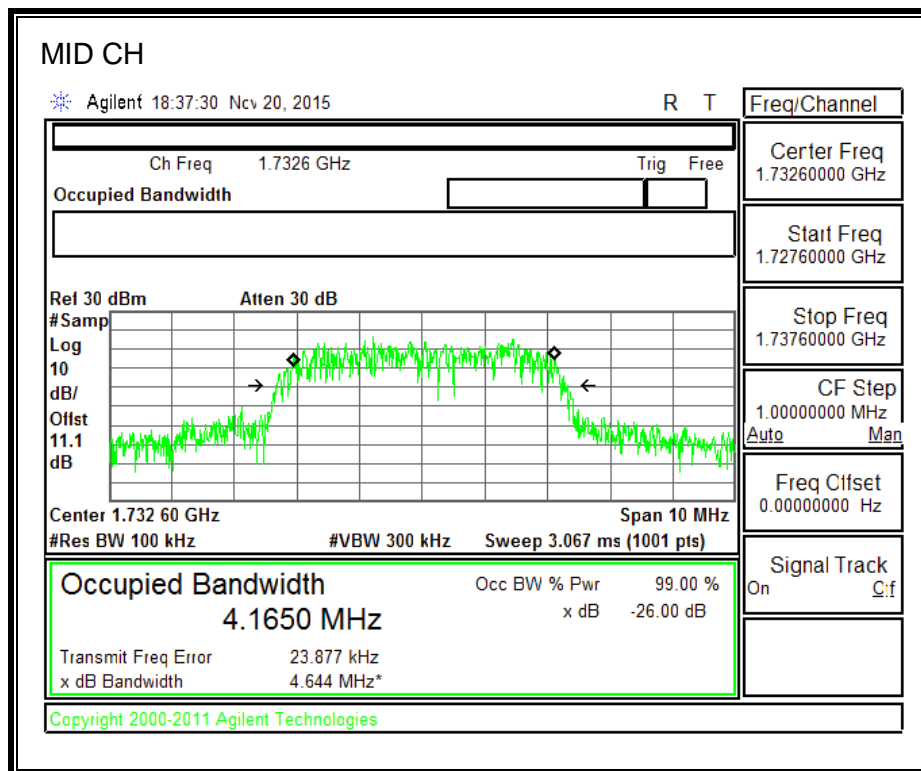
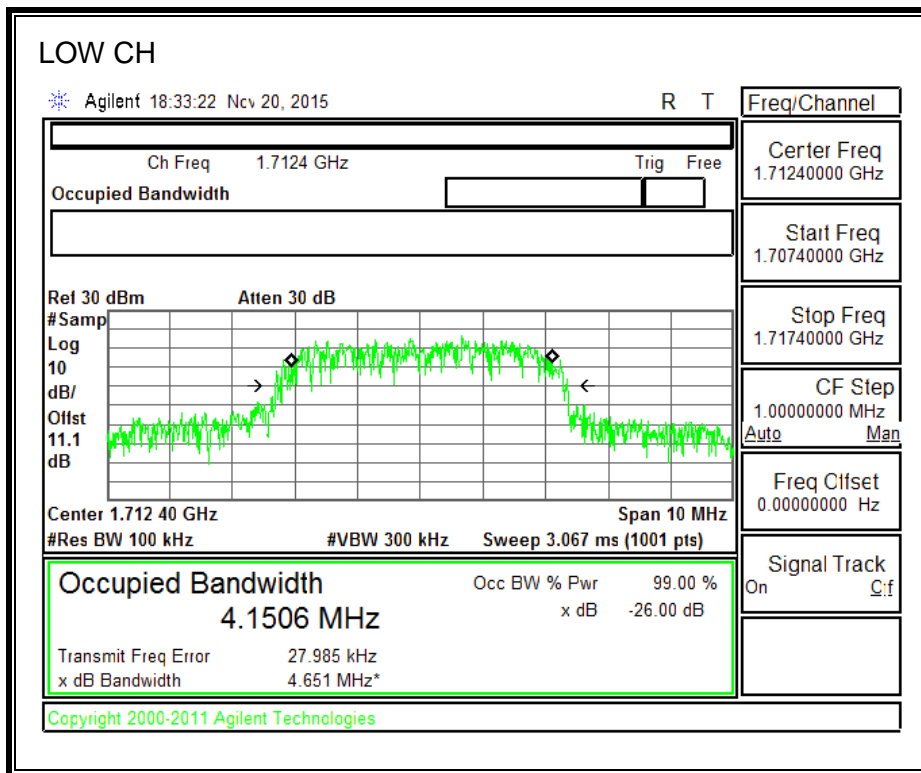

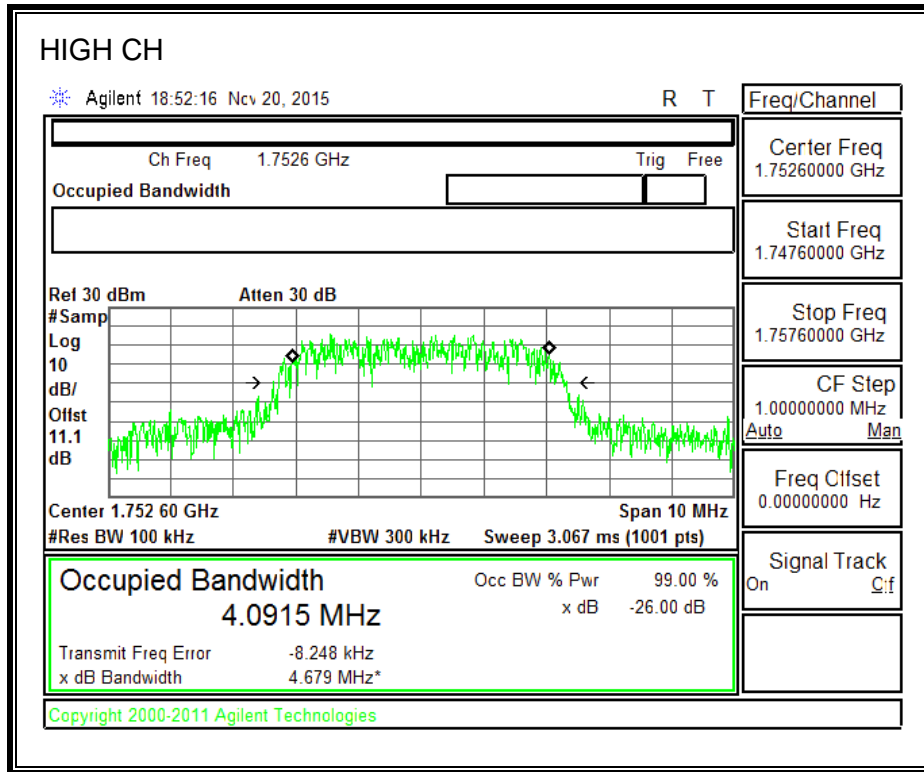

8.2. BAND EDGE

RULE PART(S)

FCC: §22.359, 24.238, §27.53 and §90.691

LIMITS

The power of any emission outside of the authorized operating frequency ranges must be attenuated below the transmitting power (P) by a factor of at least $43 + 10 \log (P)$ dB.

On any frequency outside the 776–788 MHz band, the power of any emission shall be attenuated outside the band below the transmitter power (P) by at least $43 + 10 \log (P)$ dB;

On all frequencies between 763–775 MHz and 793–805 MHz, by a factor not less than $65 + 10 \log (P)$ dB in a 6.25 kHz band segment, for mobile and portable stations.

Compliance with the provisions of paragraphs above of this section is based on the use of measurement instrumentation employing a resolution bandwidth of 100 kHz or greater. However, in the 100 kHz bands immediately outside and adjacent to the frequency block, a resolution bandwidth of at least 30 kHz may be employed;

TEST PROCEDURE

The transmitter output was connected to a Agilent 8960 Test Set and configured to operate at maximum power. The band edge emissions were measured at the required operating frequencies in each band on the Spectrum Analyzer.

For each band edge measurement:

- Set the spectrum analyzer span to include the block edge frequency (824, 849, 1850, 1910MHz)
- Set a marker to point the corresponding band edge frequency in each test case.
- Set display line at -13 dBm
- Set resolution bandwidth to at least 1% of emission bandwidth.

RESULTS

8.2.1. GSM-GPRS

850MHz BAND

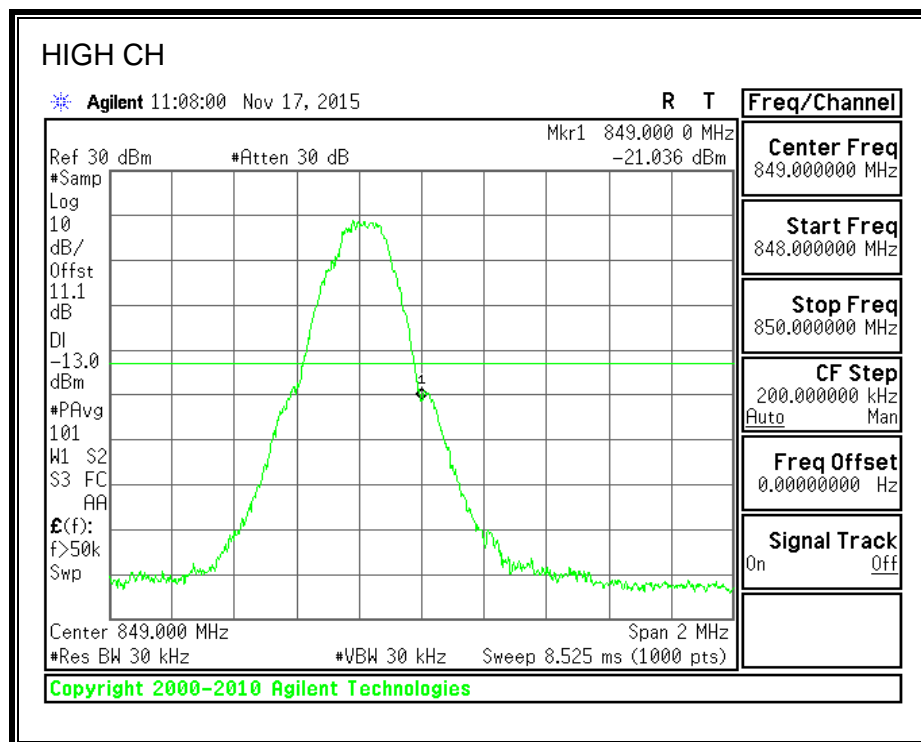
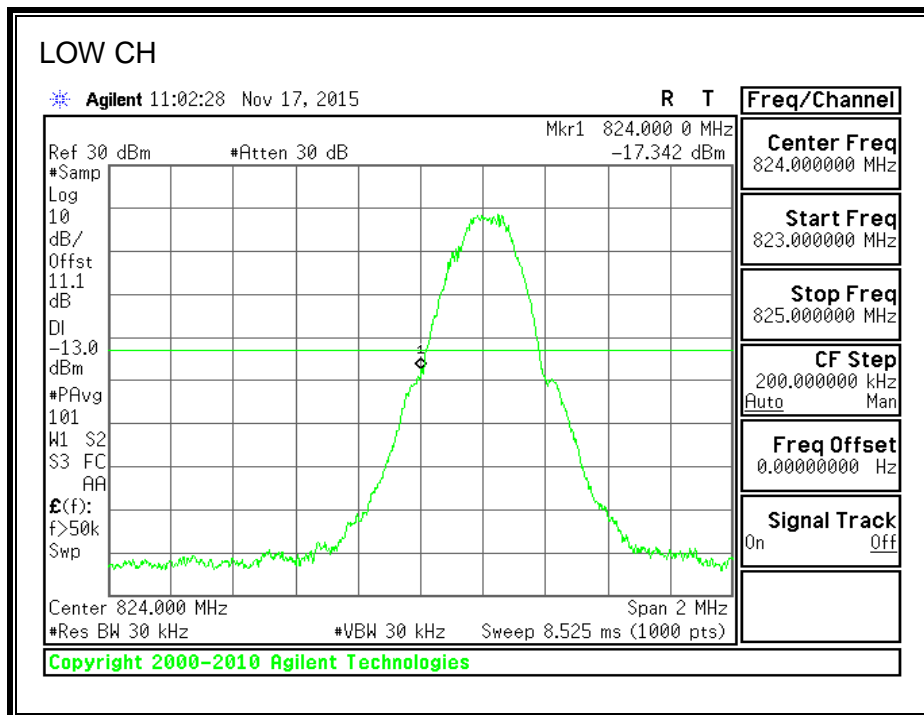

1900MHz BAND

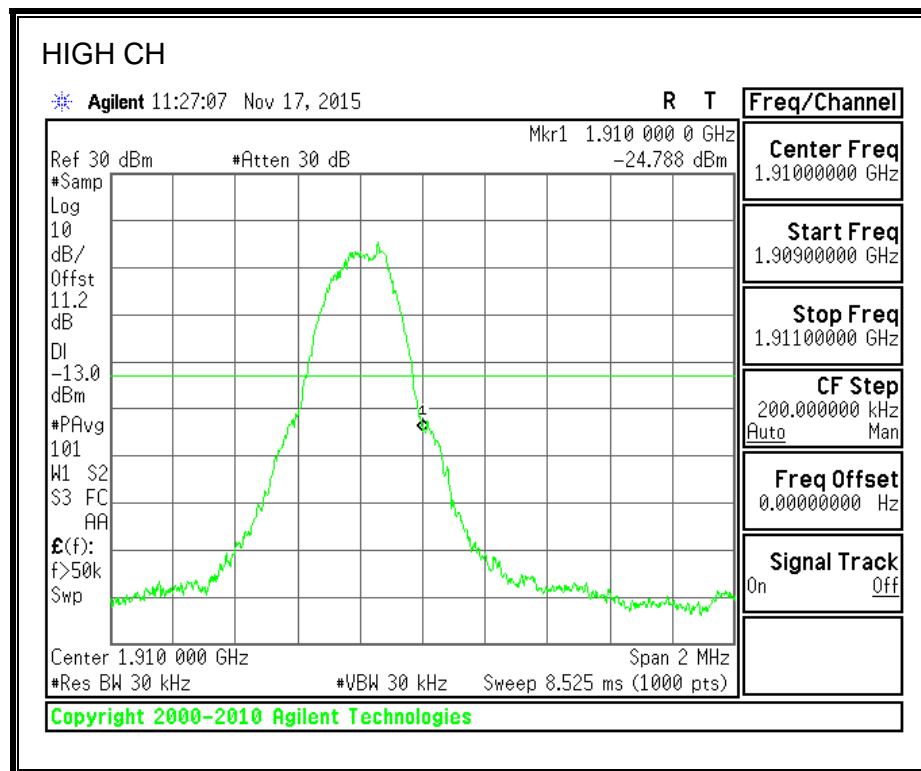
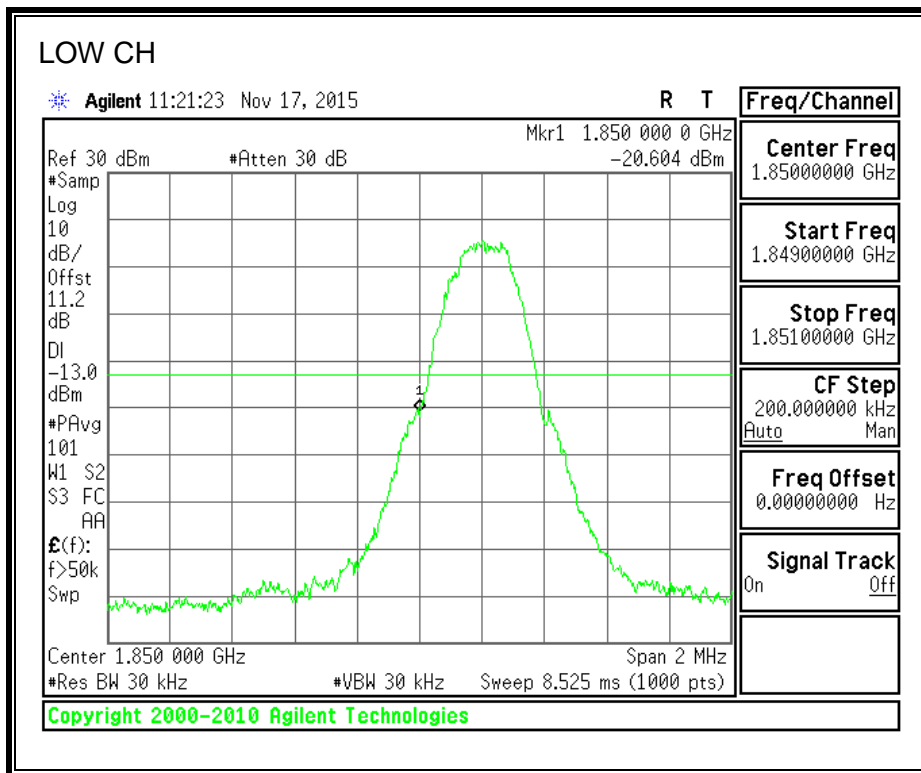

8.2.2. GSM-EGPRS

850MHz BAND

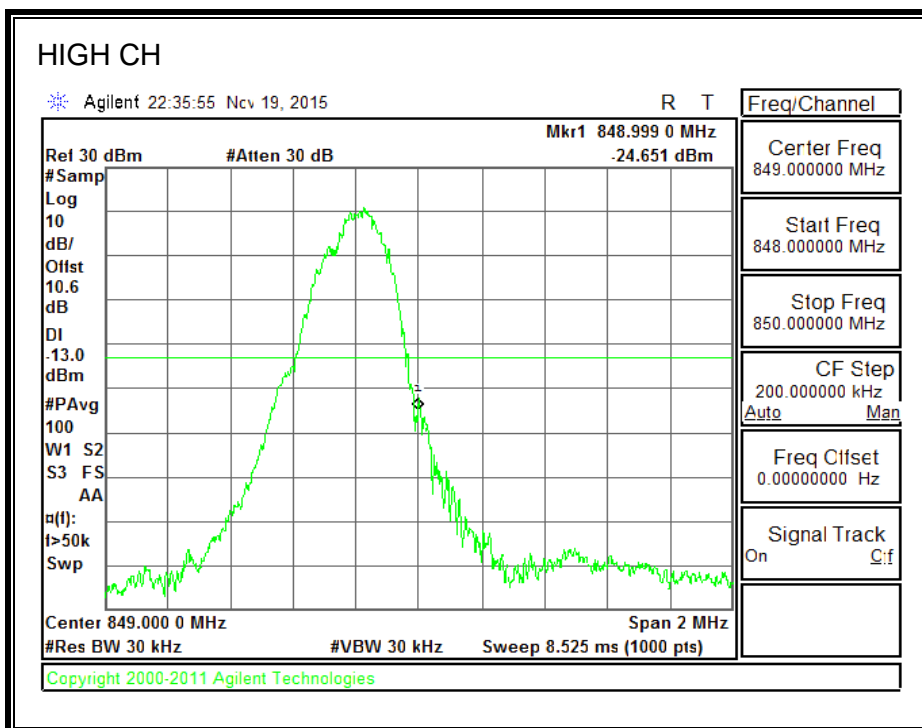
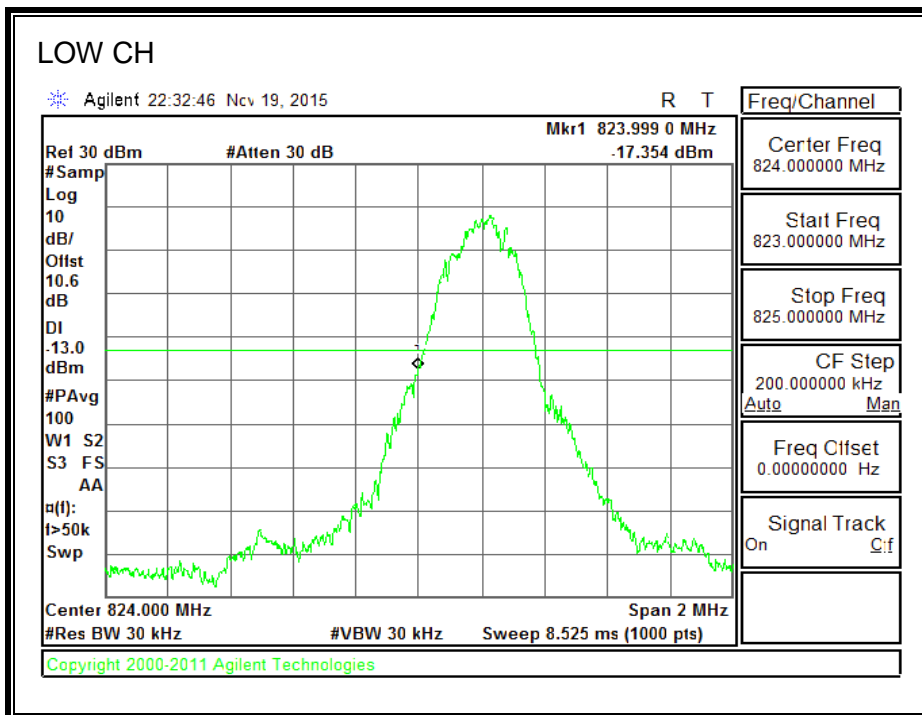

1900MHz BAND

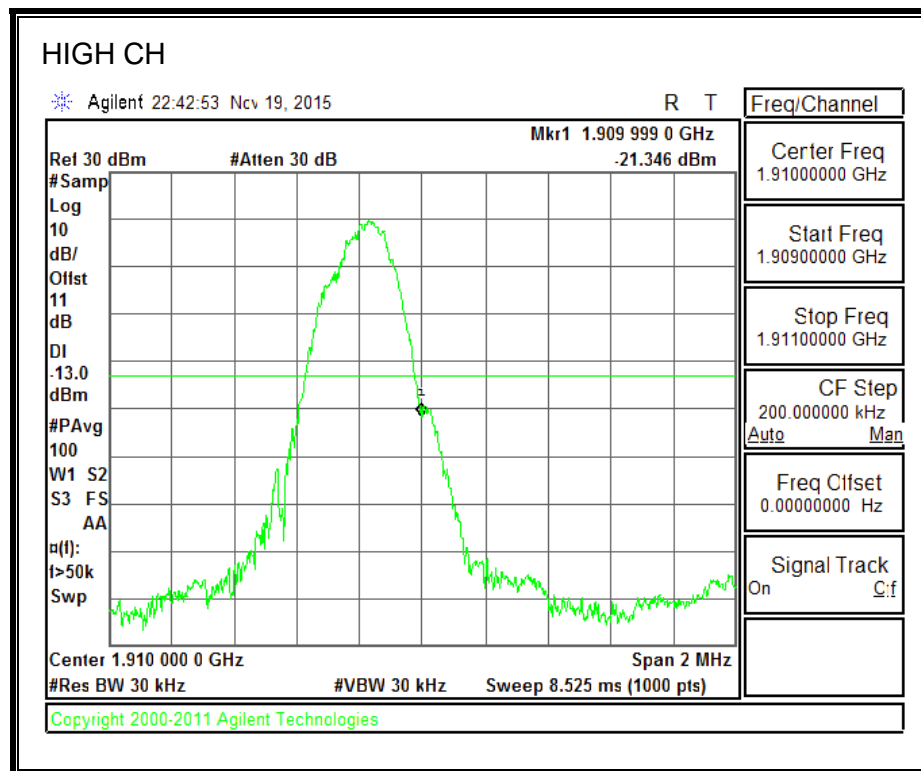
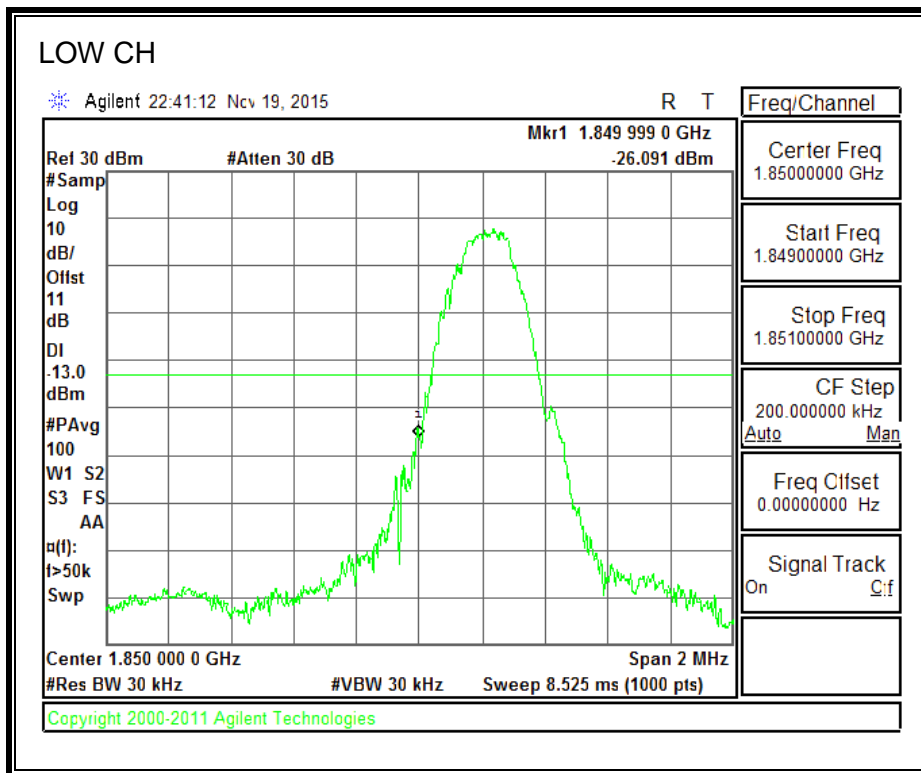

8.2.3. CDMA2000 1xRTT

850MHz BAND

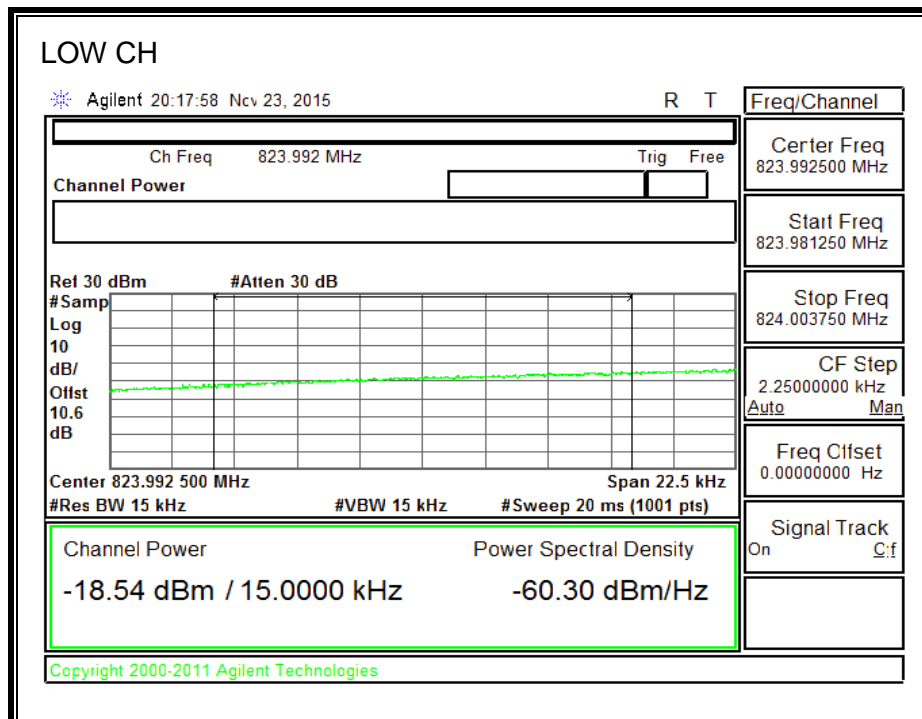
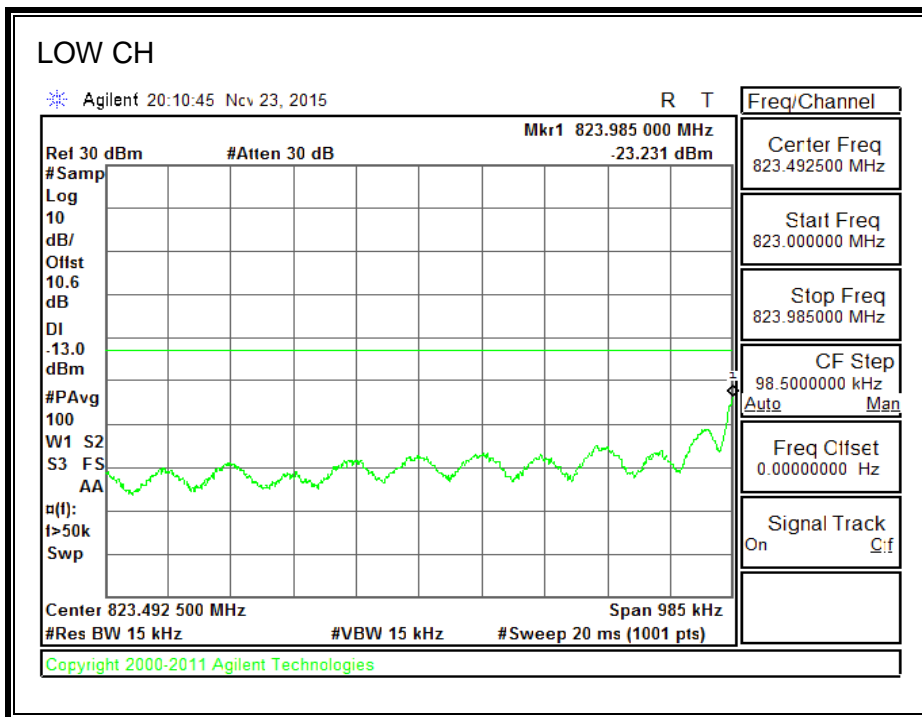

850MHz BAND

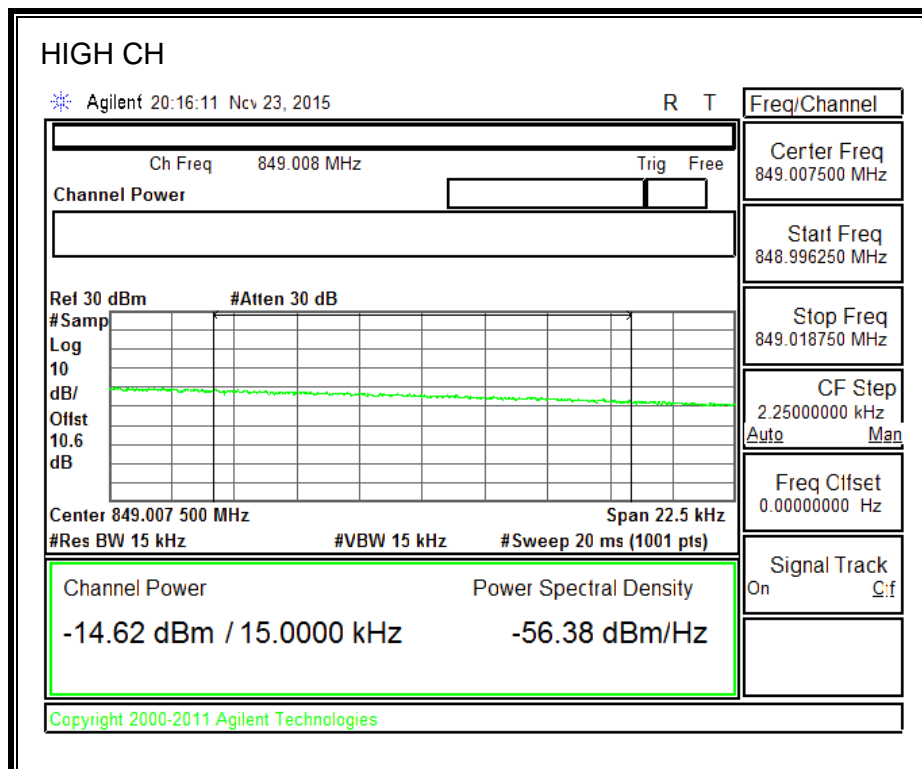
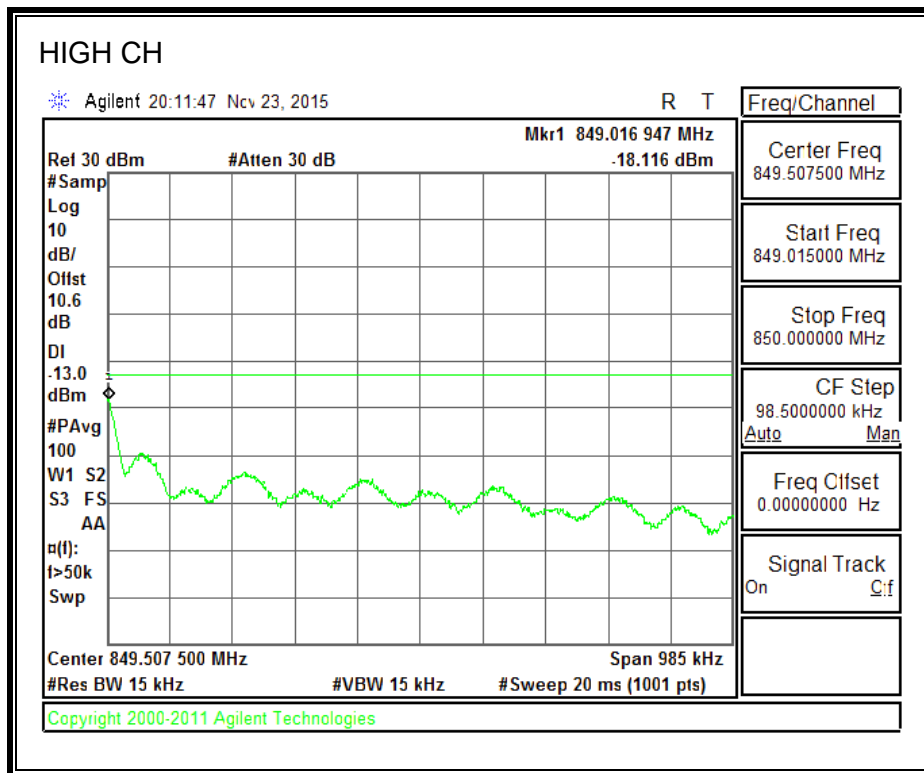

1900MHz BAND

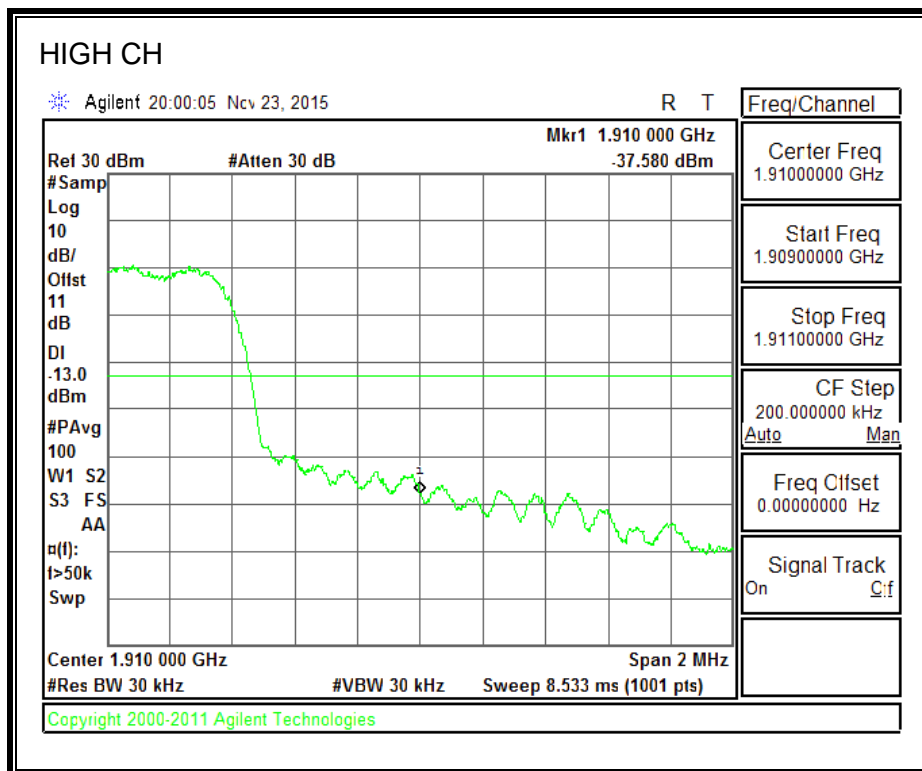
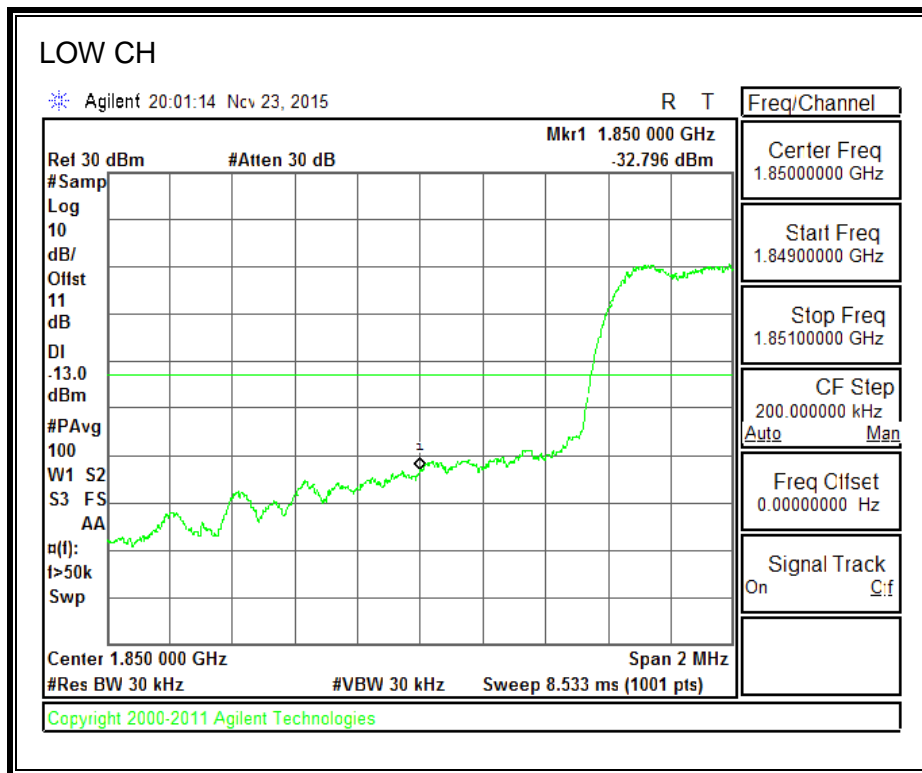

1700MHz BAND

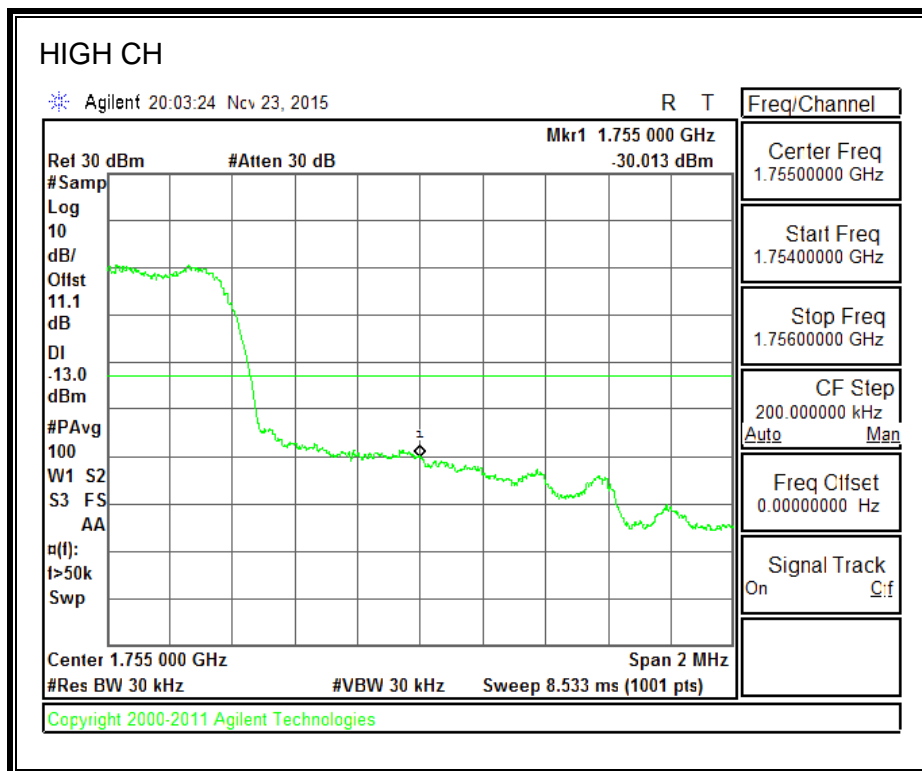
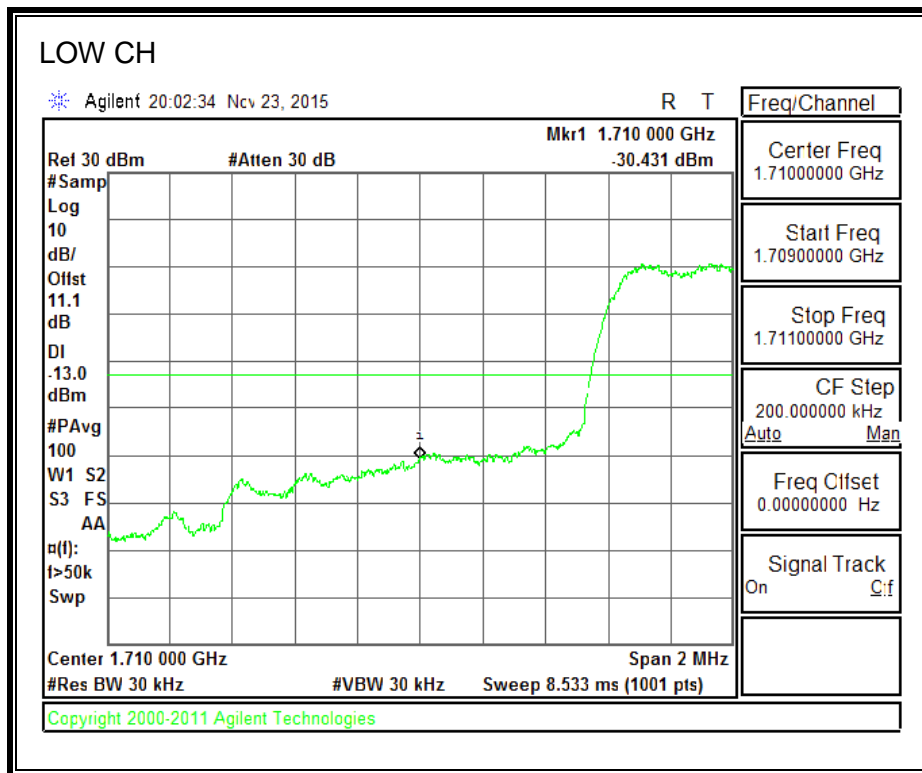

8.2.4. CDMA2000 1xRTT BC10 MASK

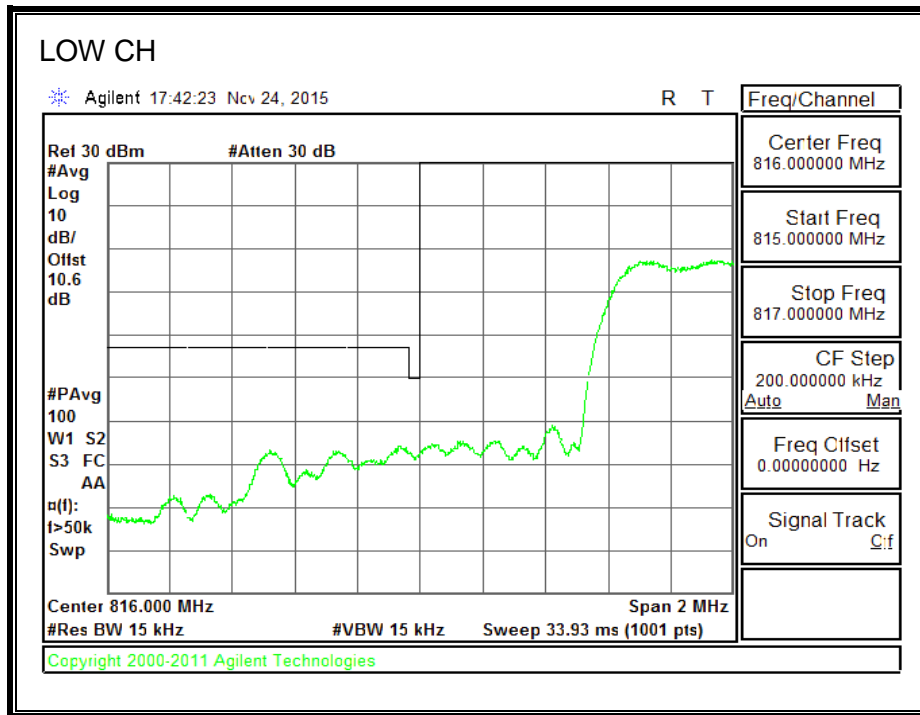

Note: RBW=1% of EBW

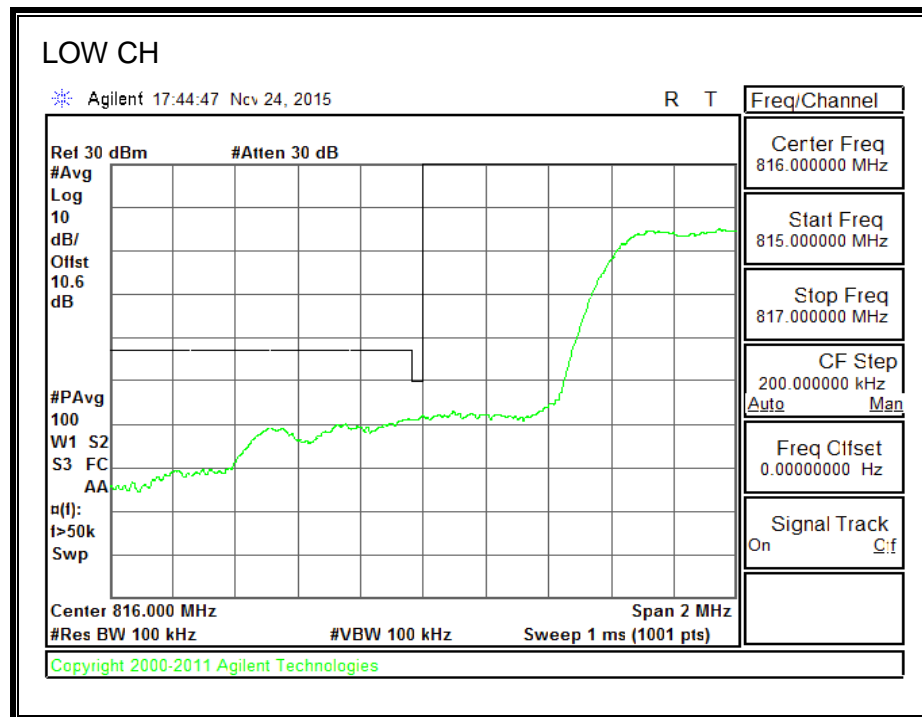

Note: RBW of 1% of 37.5KHz of outer channel frequency block

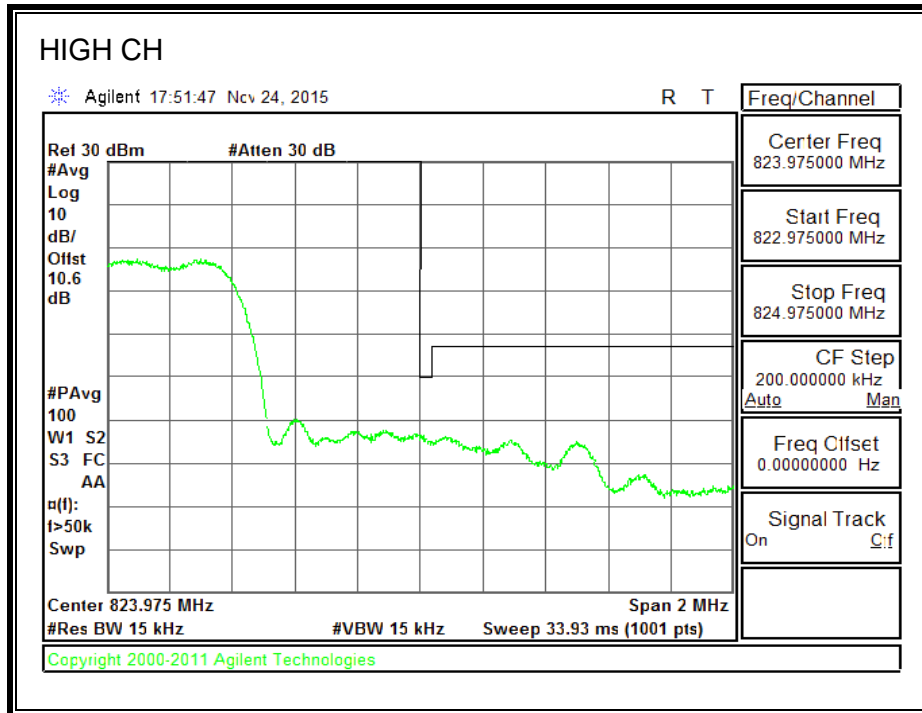

Note: RBW=1% of EBW

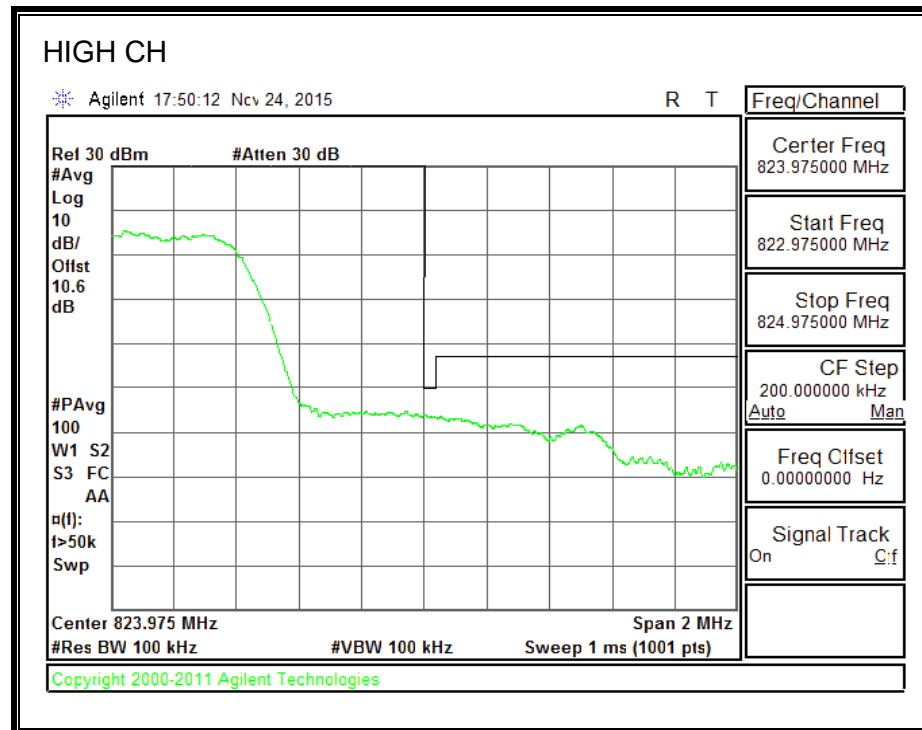

Note: RBW of 1% of 37.5KHz of outer channel frequency block

8.2.5. CDMA2000 EVDO REV A

850MHz BAND

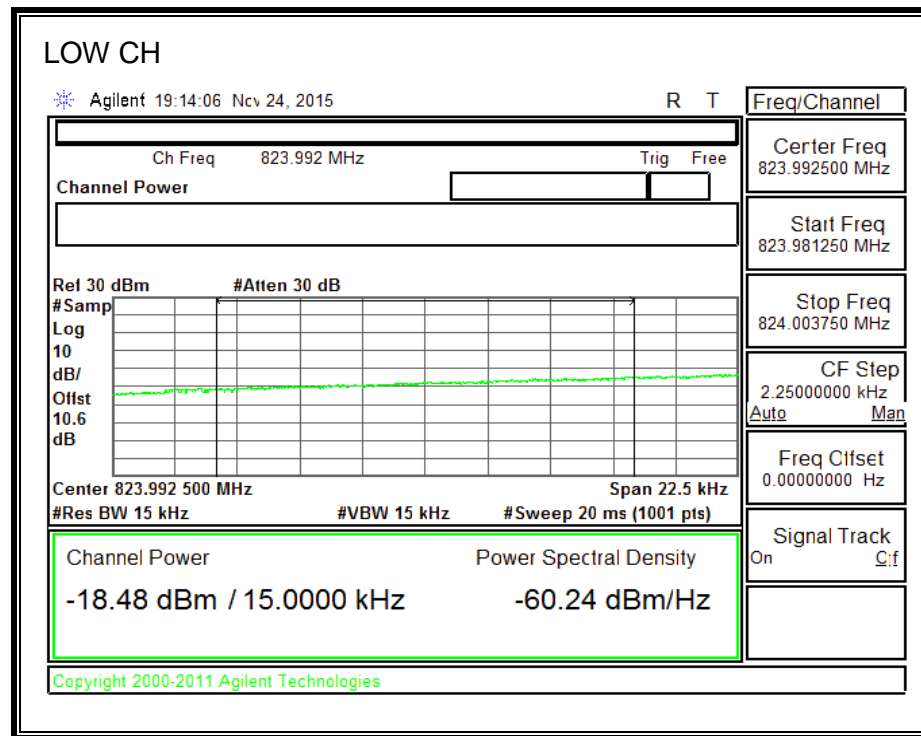
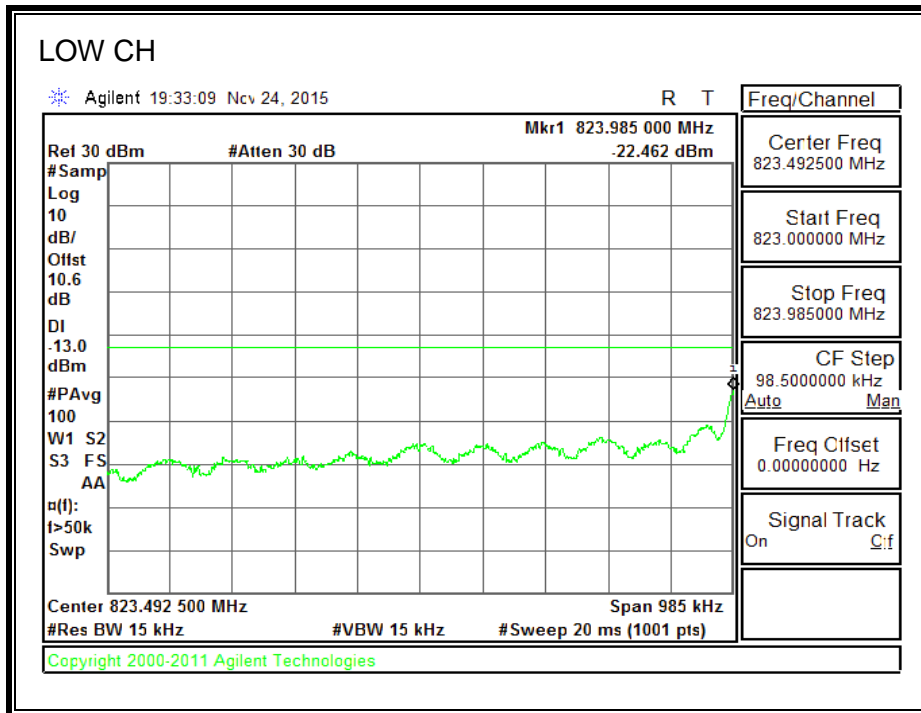

850MHz BAND

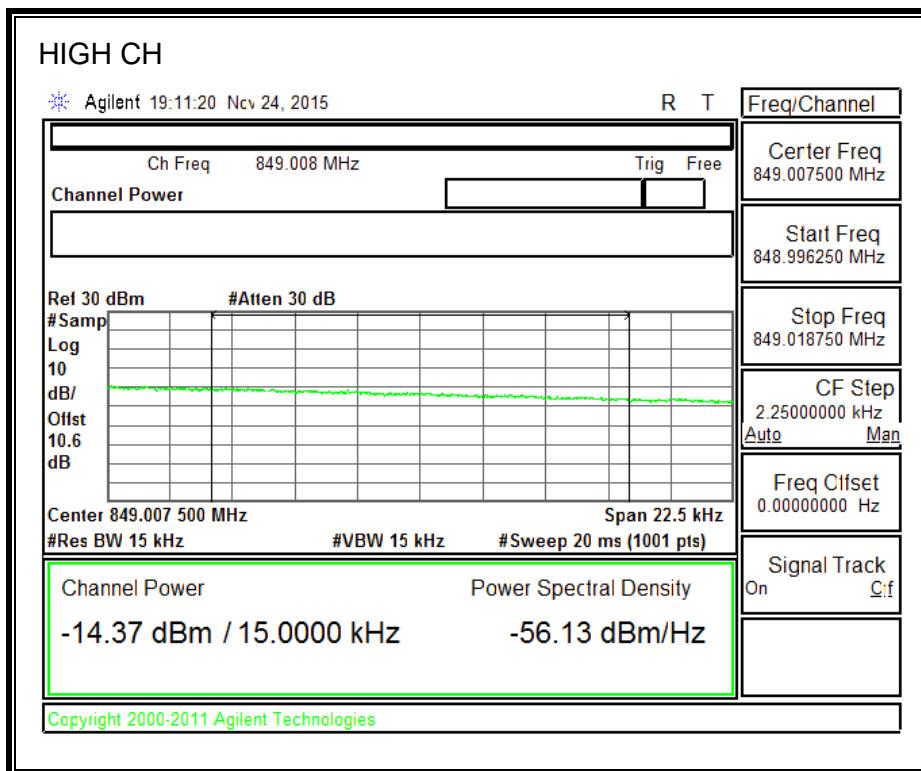
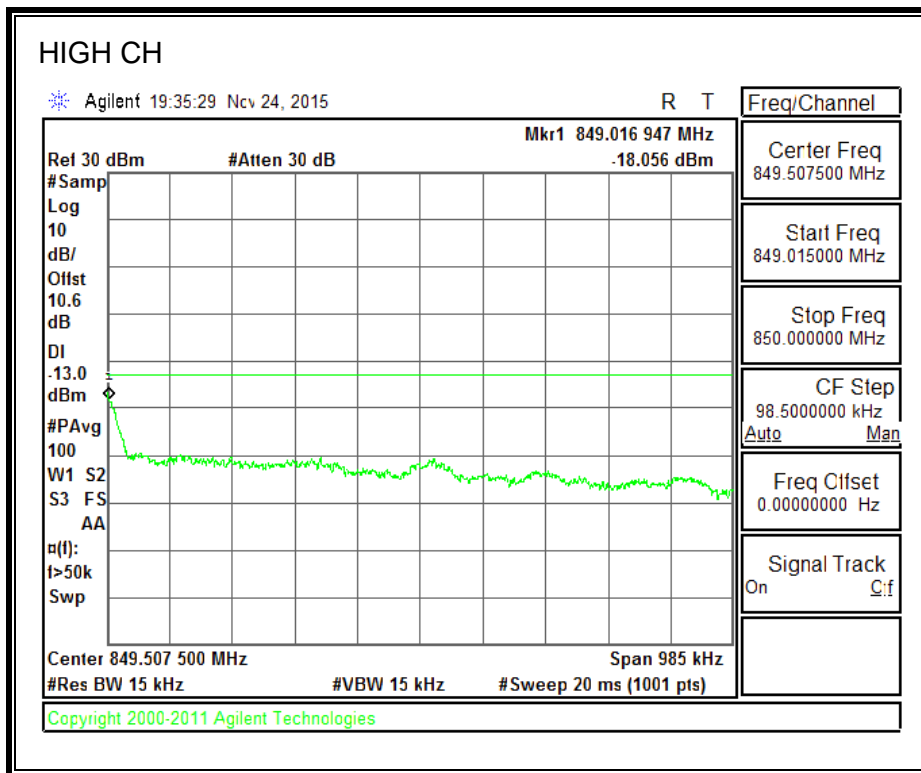

1900MHz BAND

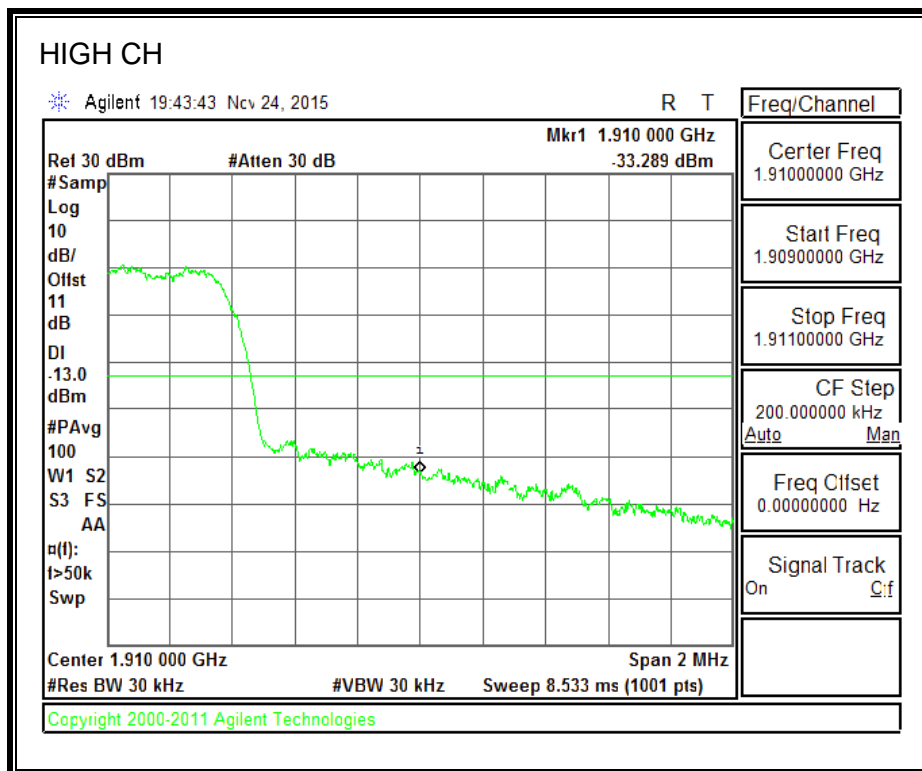
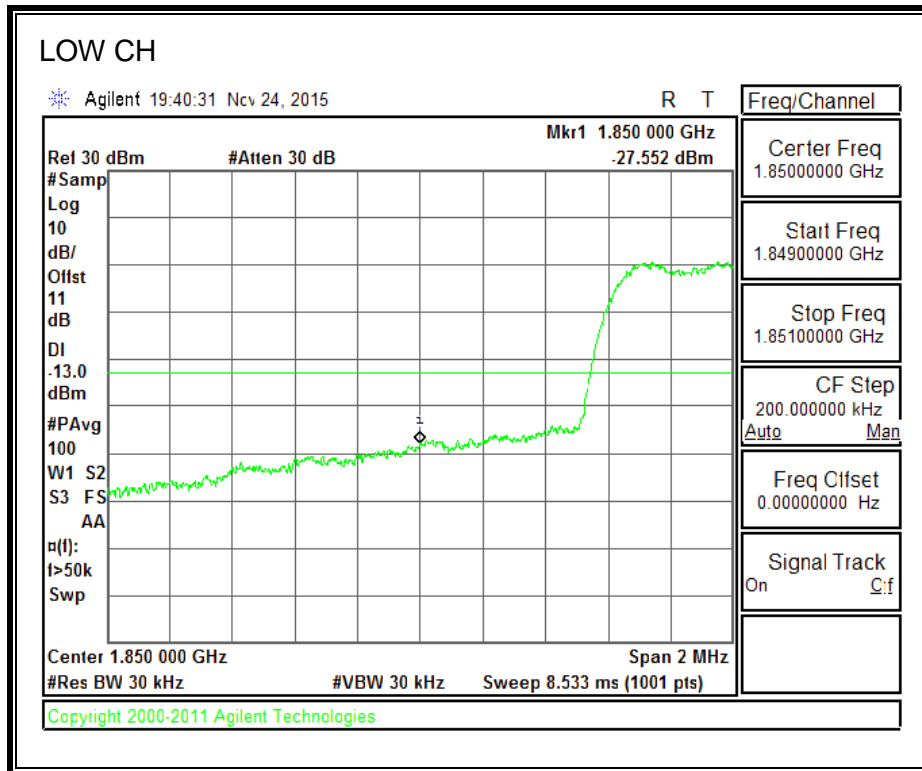

1700MHz BAND

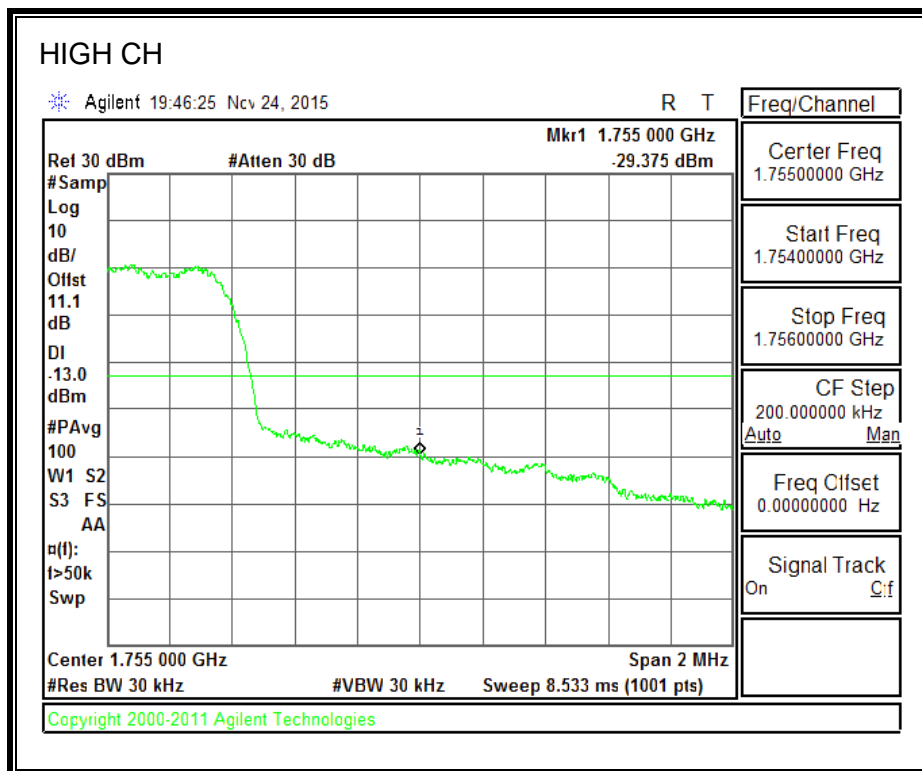
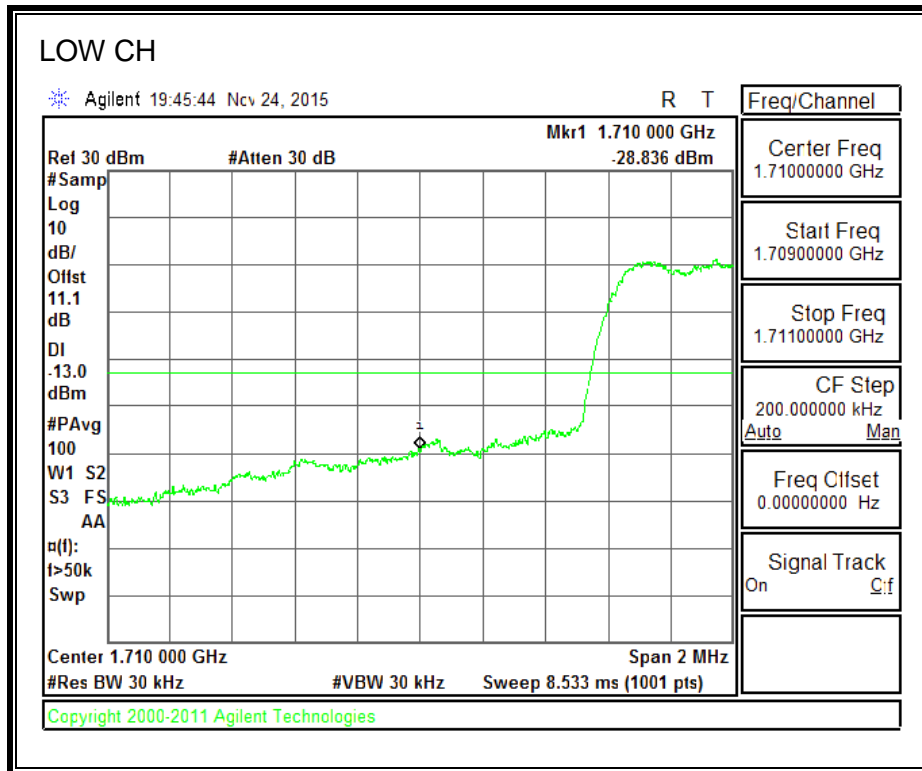

8.2.6. CDMA2000 EVDO REV A BC10 MASK

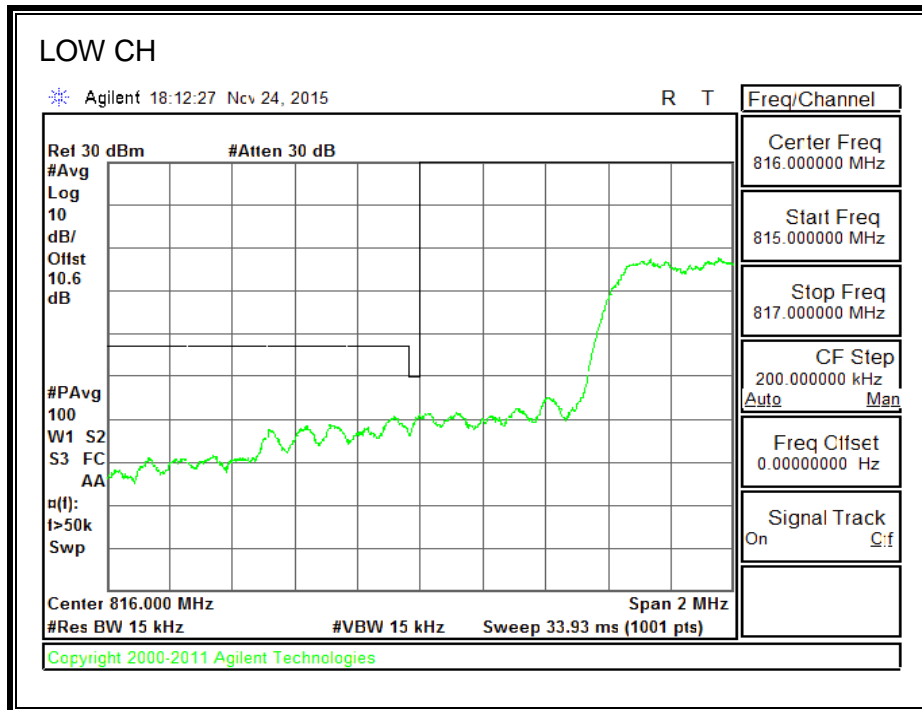

Note: RBW=1% of EBW

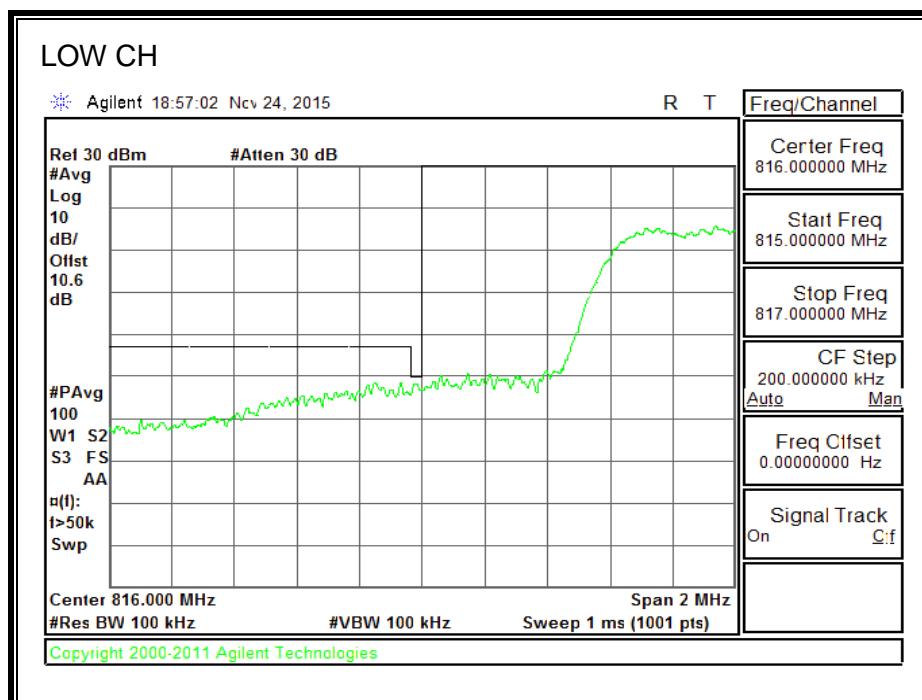

Note: RBW of 1% of 37.5KHz of outer channel frequency block

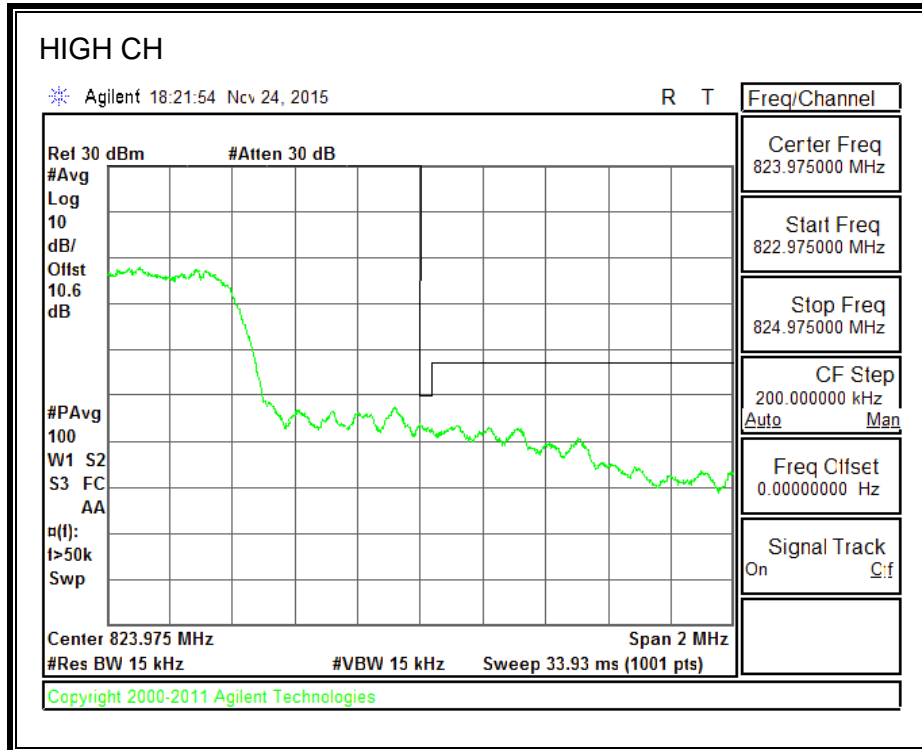

Note: RBW=1% of EBW

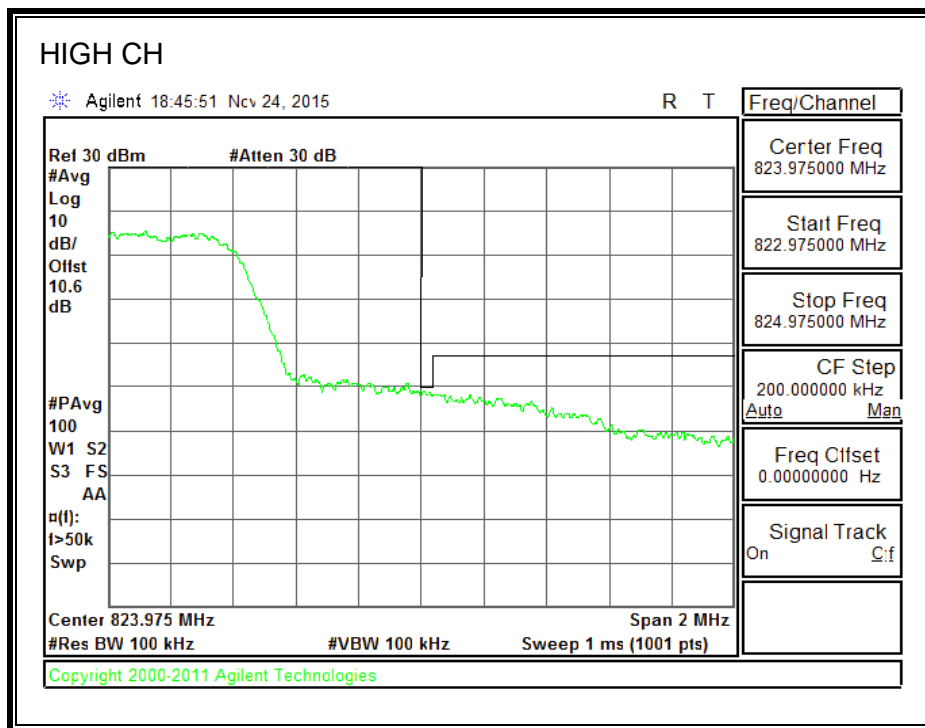

Note: RBW of 1% of 37.5KHz of outer channel frequency block

8.2.7. UMTS REL 99

850MHz BAND

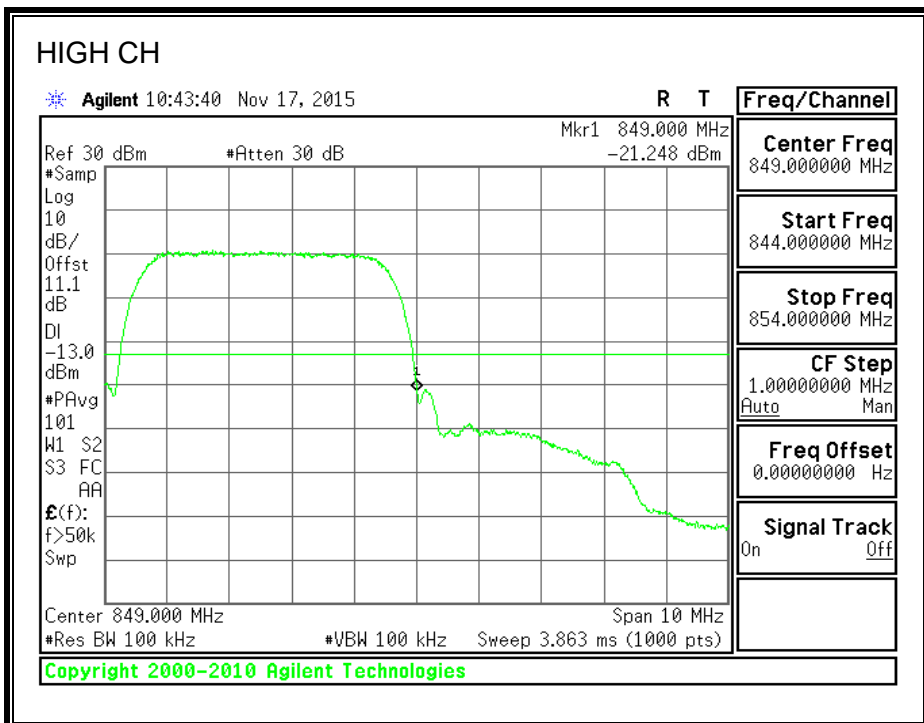
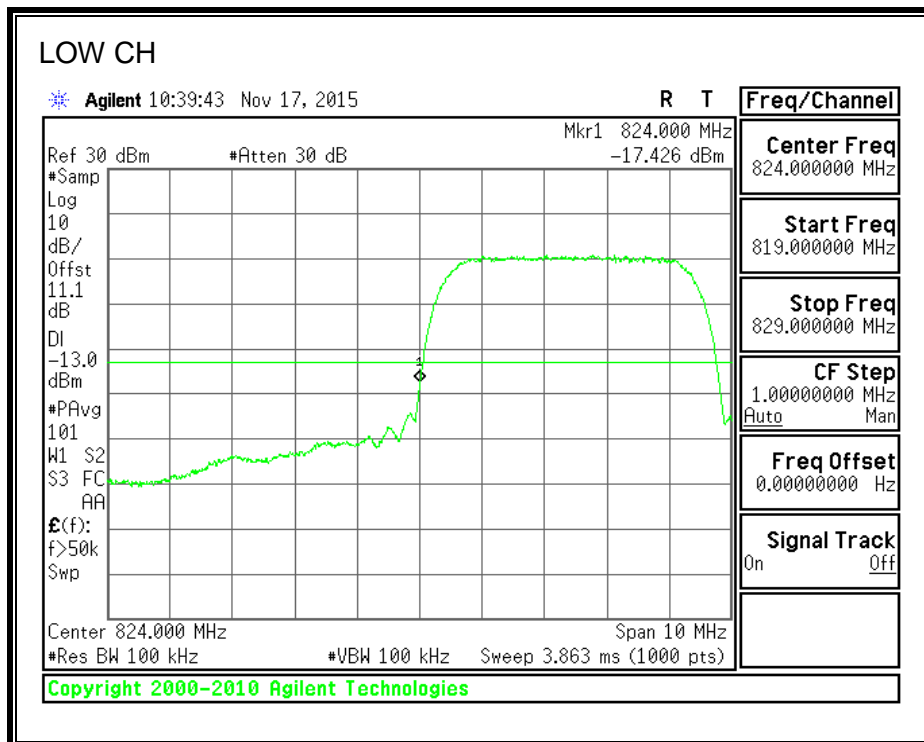

1900MHz BAND

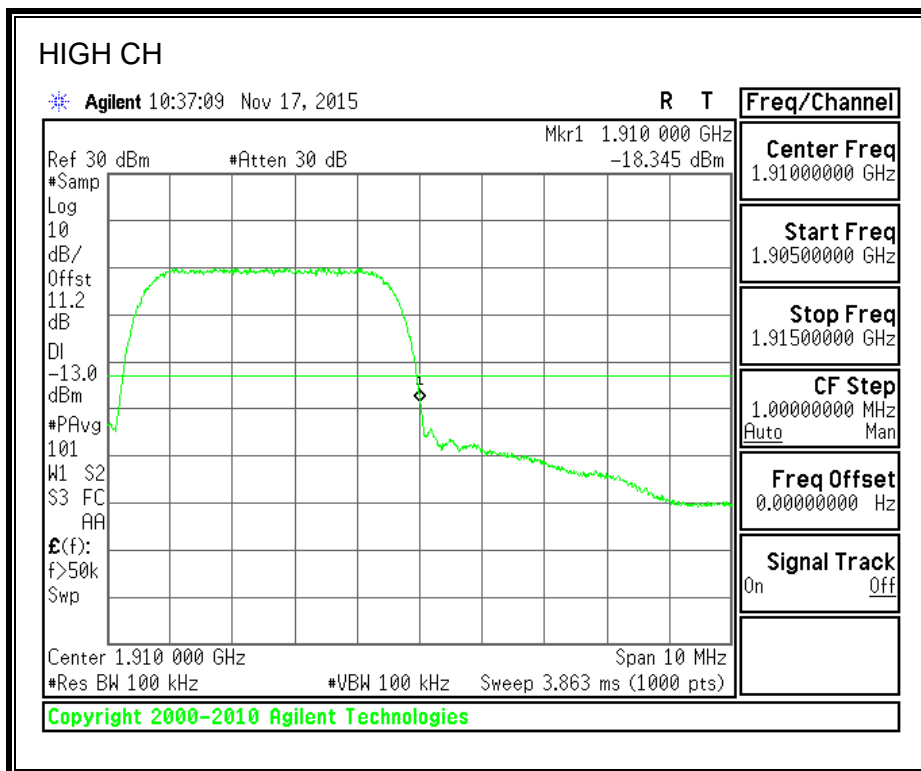
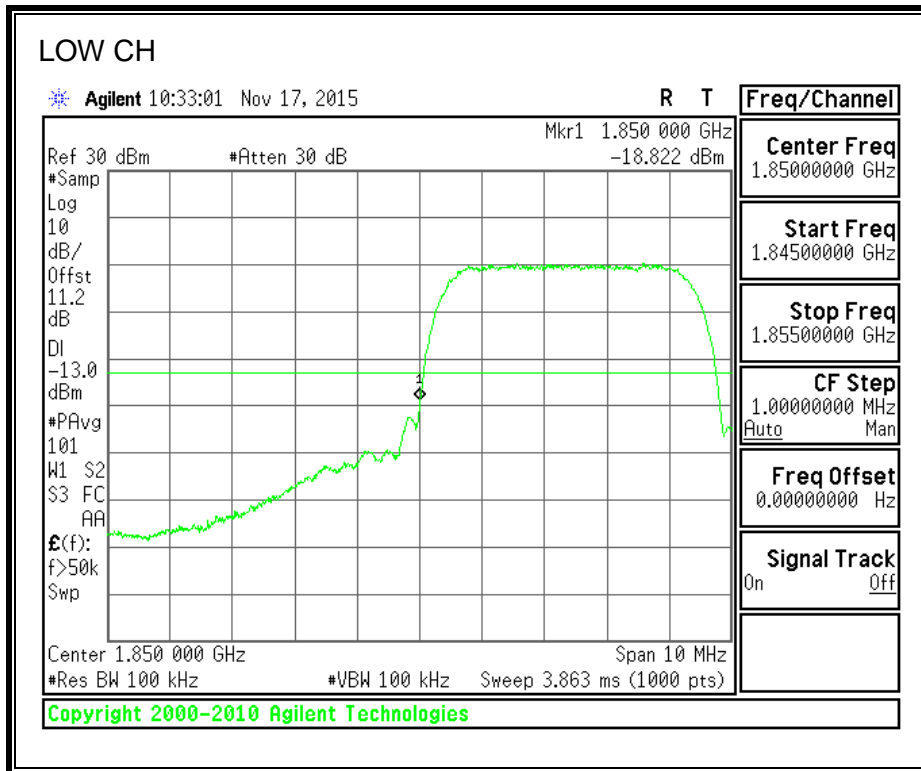

1700MHz BAND

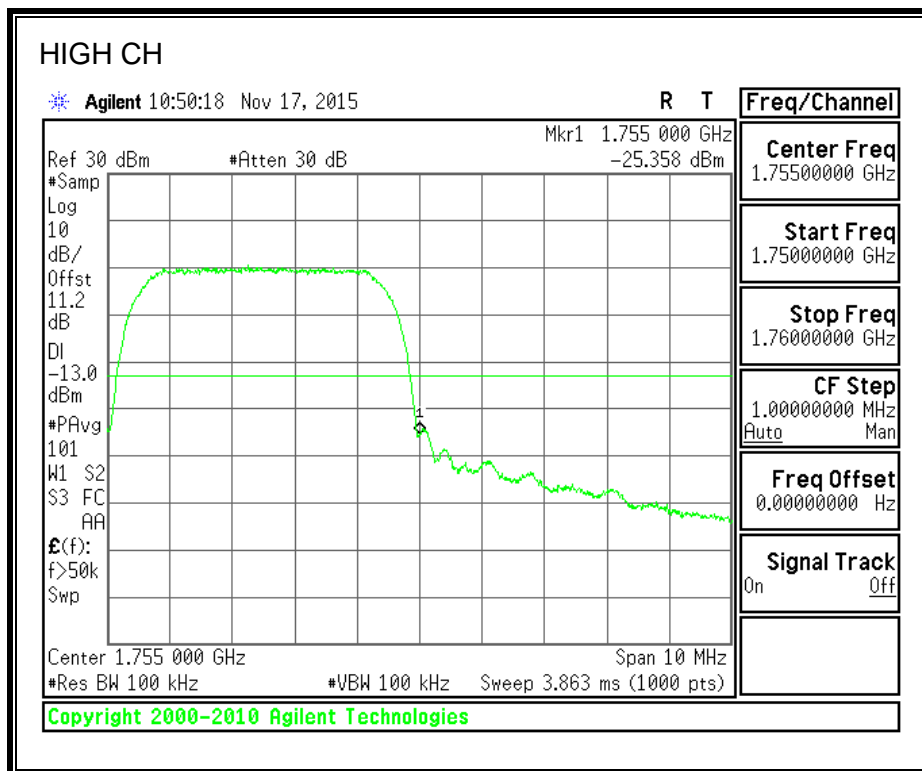
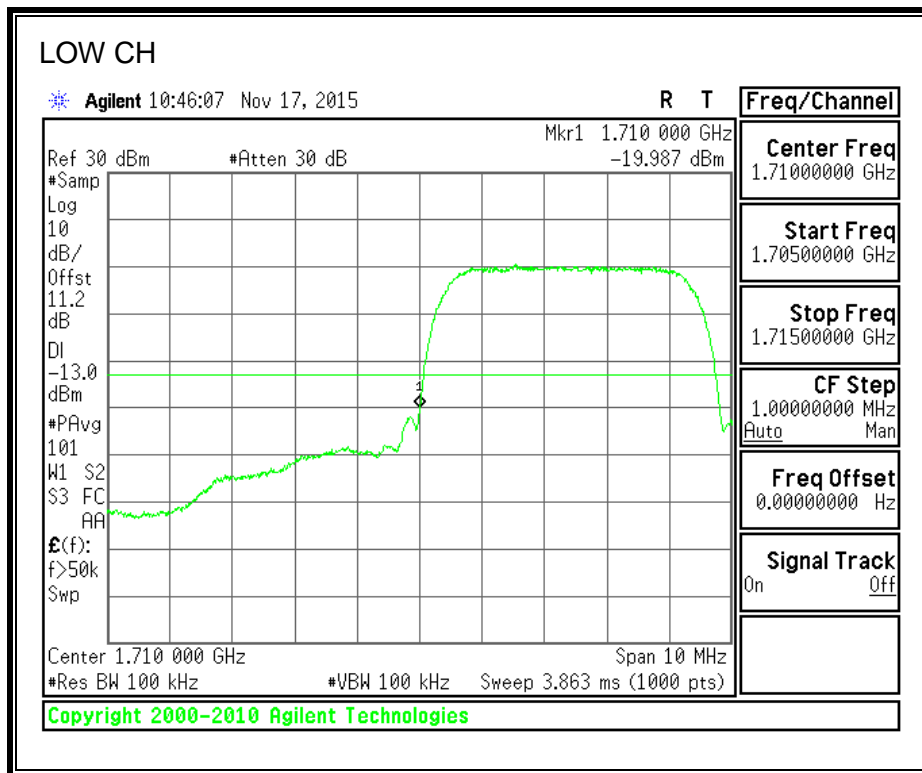

8.2.8. UMTS HSDPA

850MHz BAND

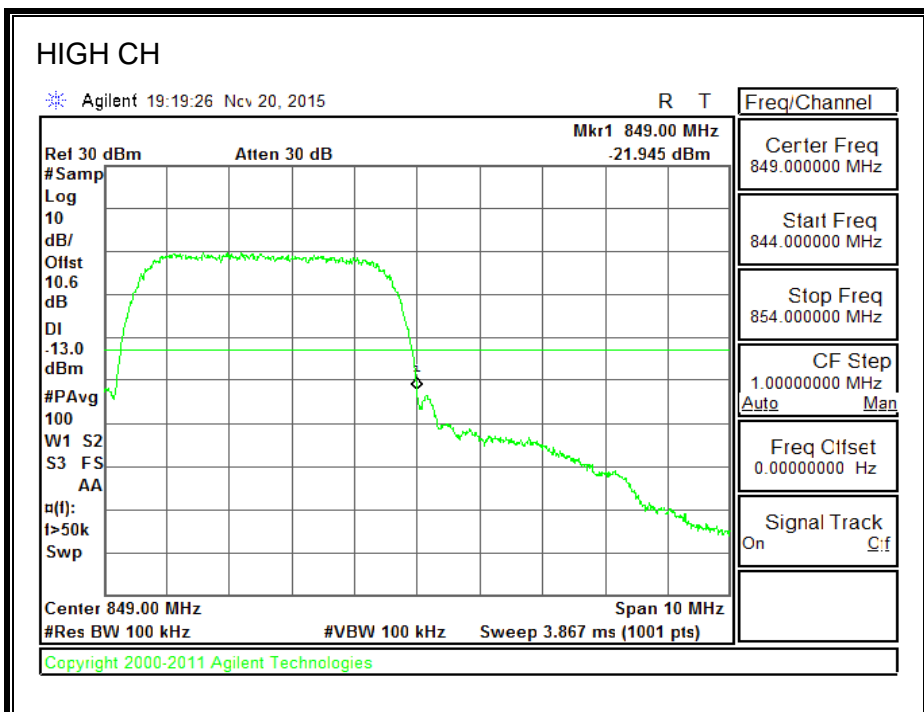
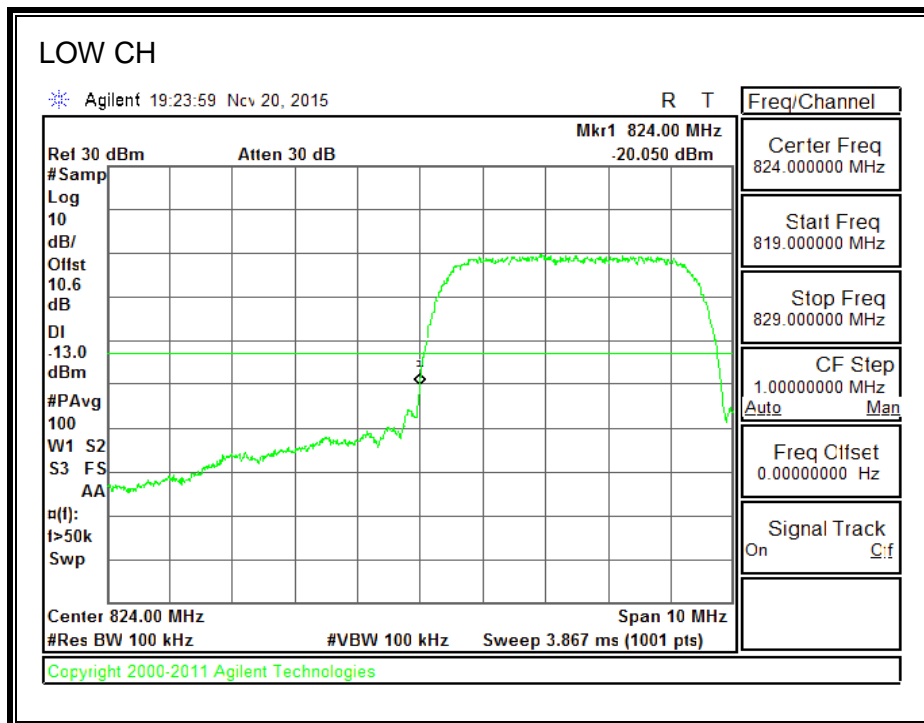

1900MHz BAND

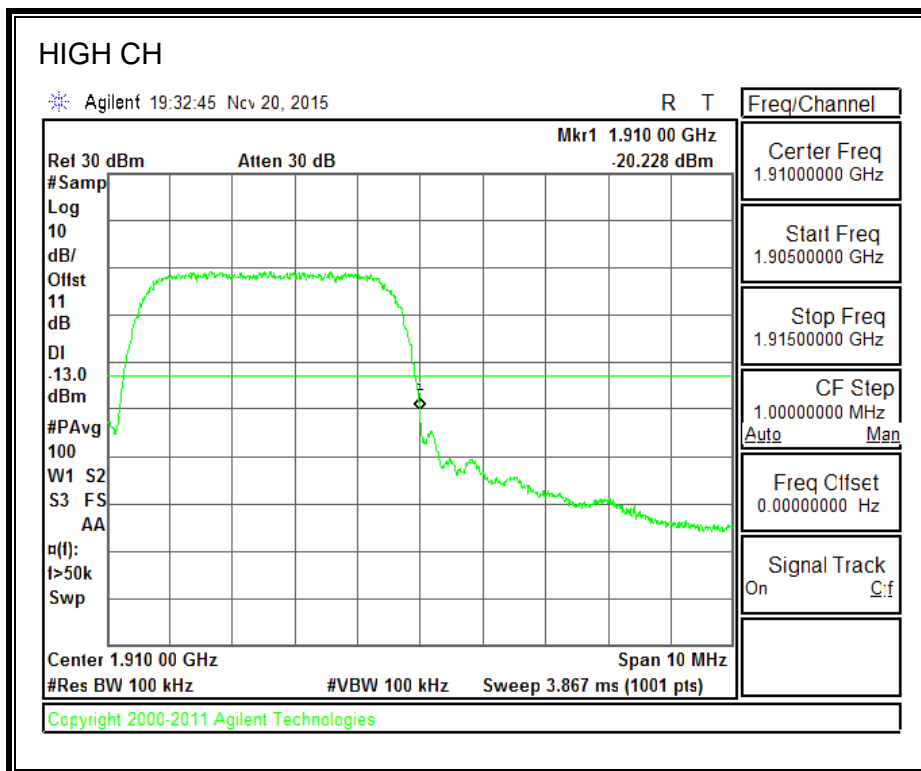
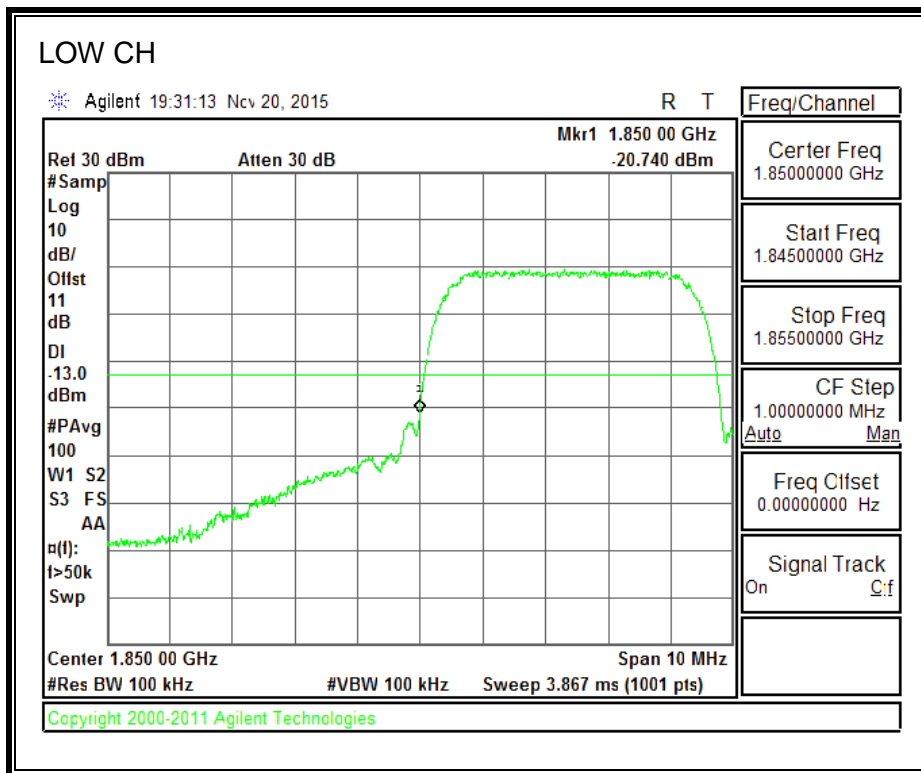

1700MHz BAND

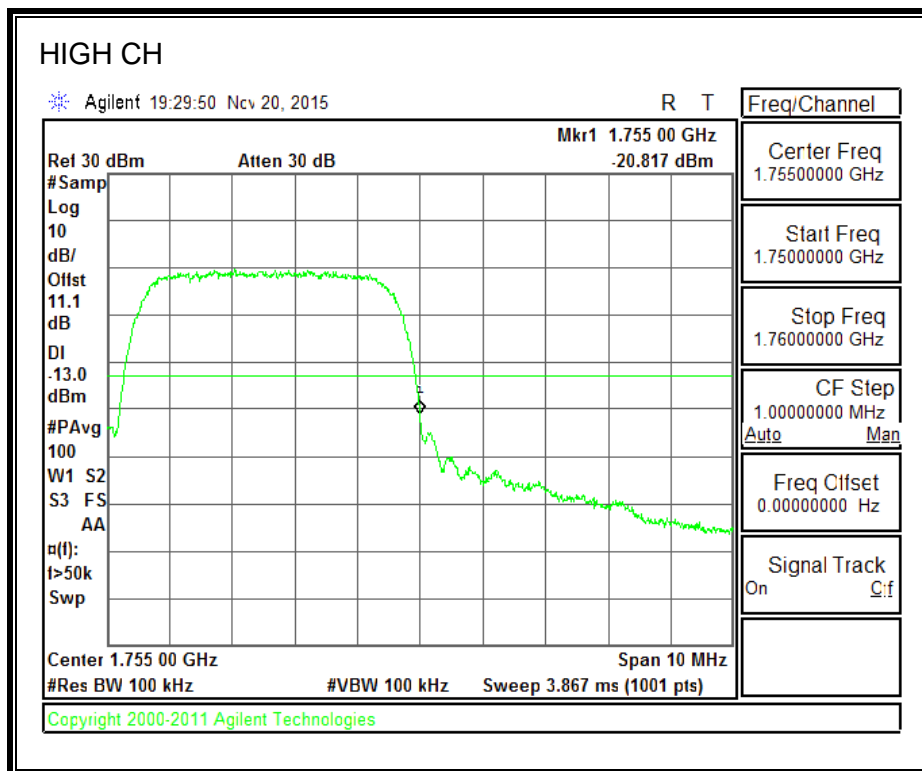
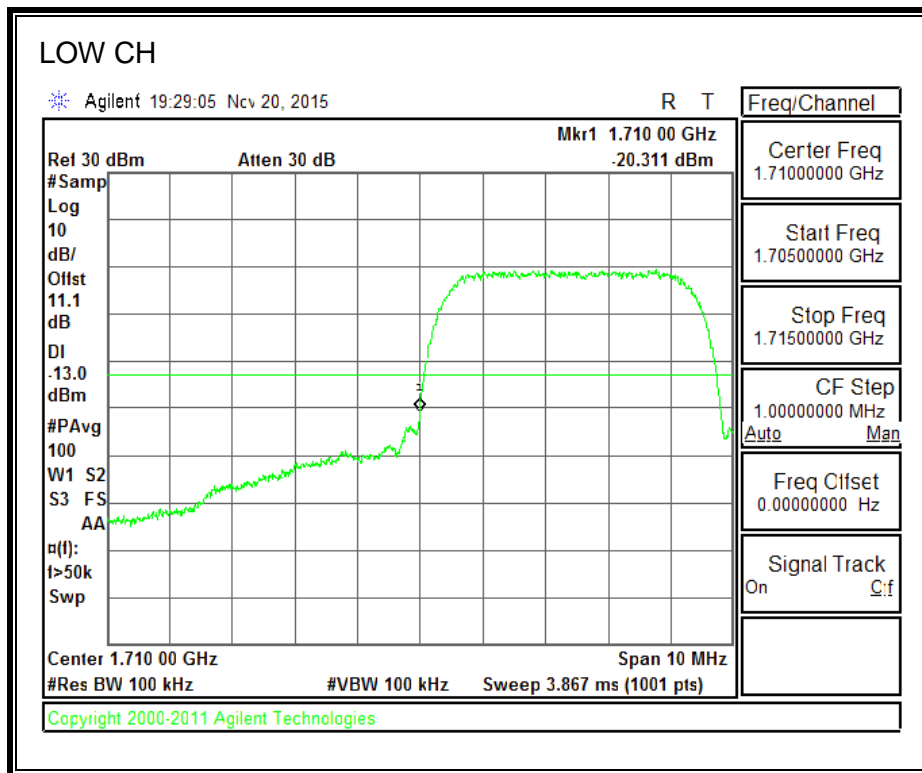

8.3. OUT OF BAND EMISSIONS

RULE PART(S)

FCC: §2.1051, §22.901, §22.917, §24.238 and §90.691

LIMITS

The power of any emission outside of the authorized operating frequency ranges must be attenuated below the transmitting power (P) by a factor of at least $43 + 10 \log (P)$ dB.

TEST PROCEDURE

The RF output of the transmitter was connected to a spectrum analyzer through a calibrated coaxial cable. Sufficient scans were taken to show the out-of-band Emissions, if any, up to 10th harmonic. Multiple sweeps were recorded in maximum hold mode using a peak detector to ensure that the worst-case emissions were caught.

For each out of band emissions measurement:

- Set display line at -13 dBm
- Set RBW & VBW to 100 kHz for the measurement below 1 GHz, and 1 MHz for the measurement above 1 GHz.

RESULTS

8.3.1. GSM-GPRS

850MHz BAND

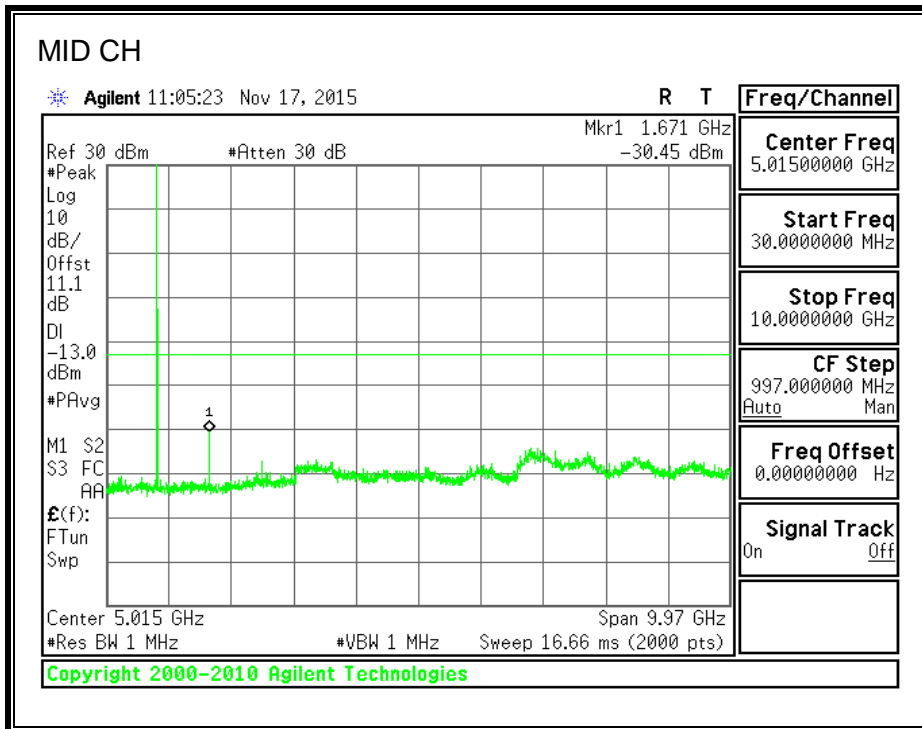
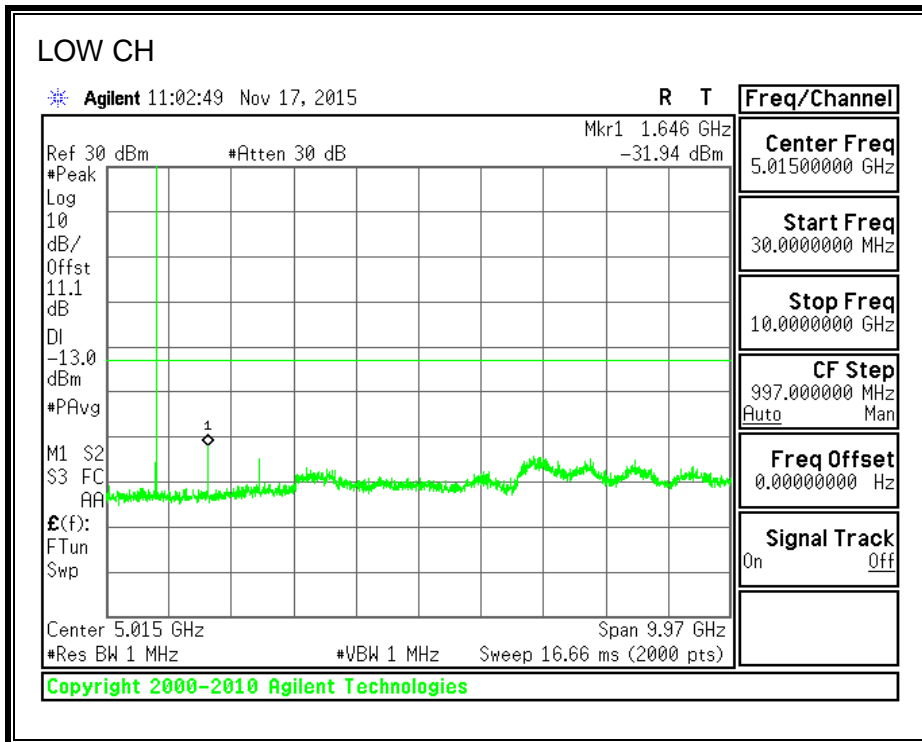

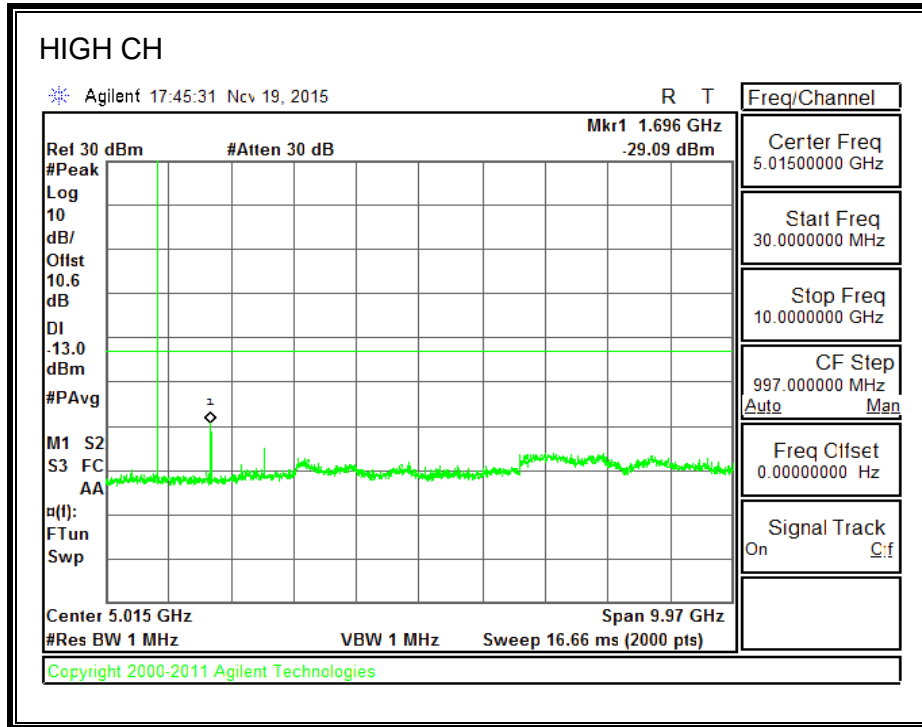

1900MHz BAND

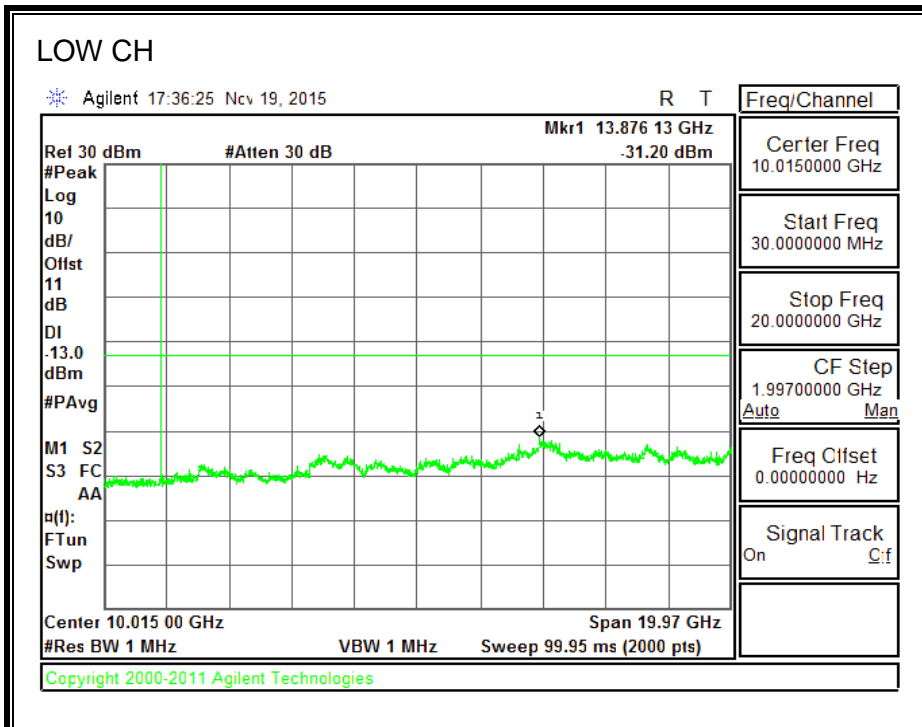

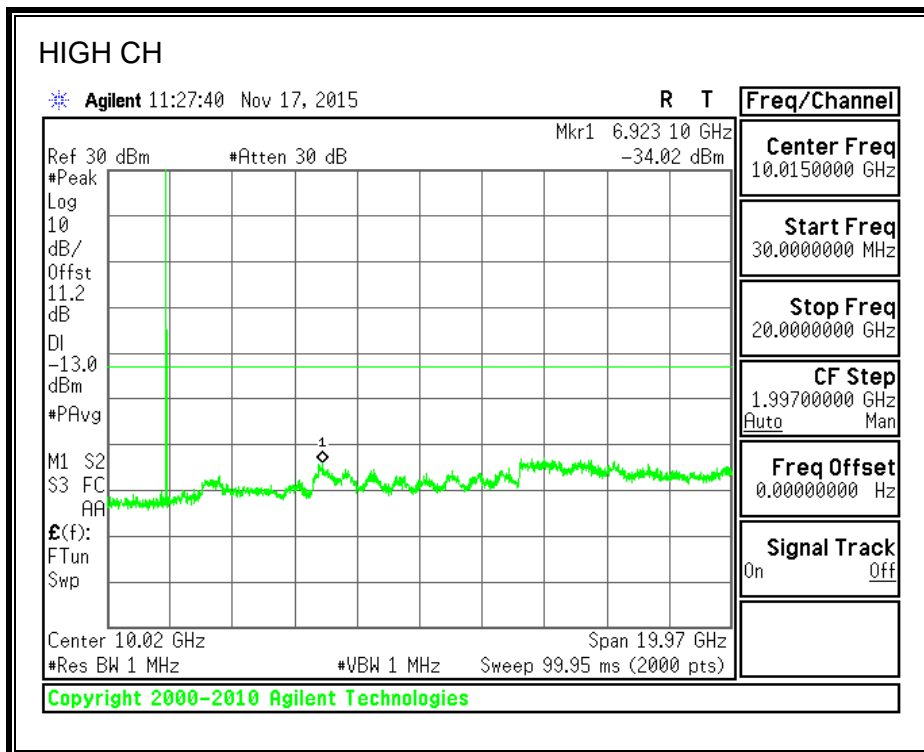
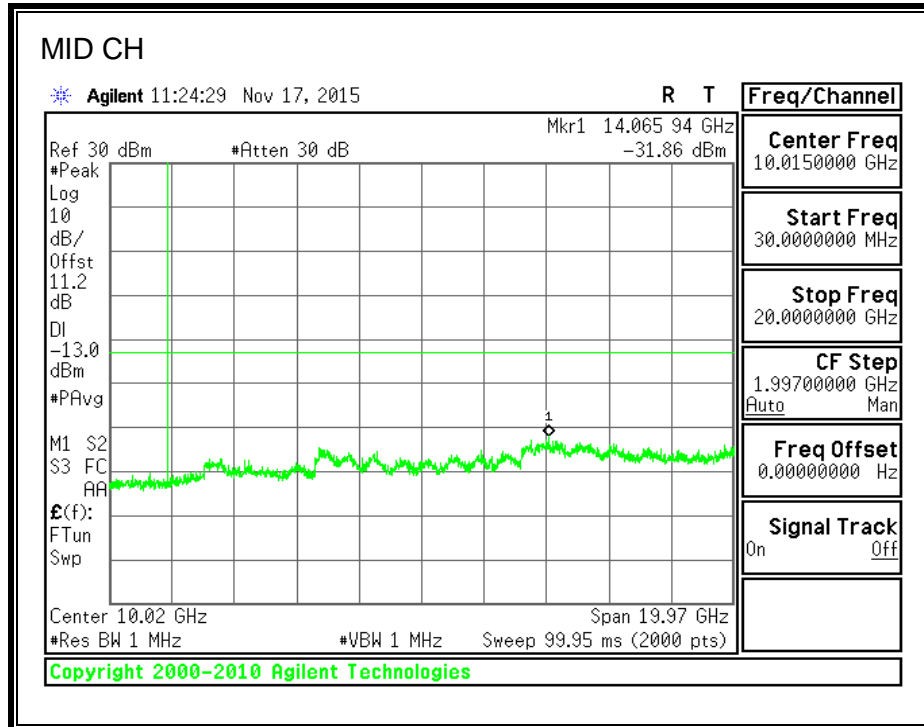

8.3.2. GSM-EGPRS

850MHz BAND

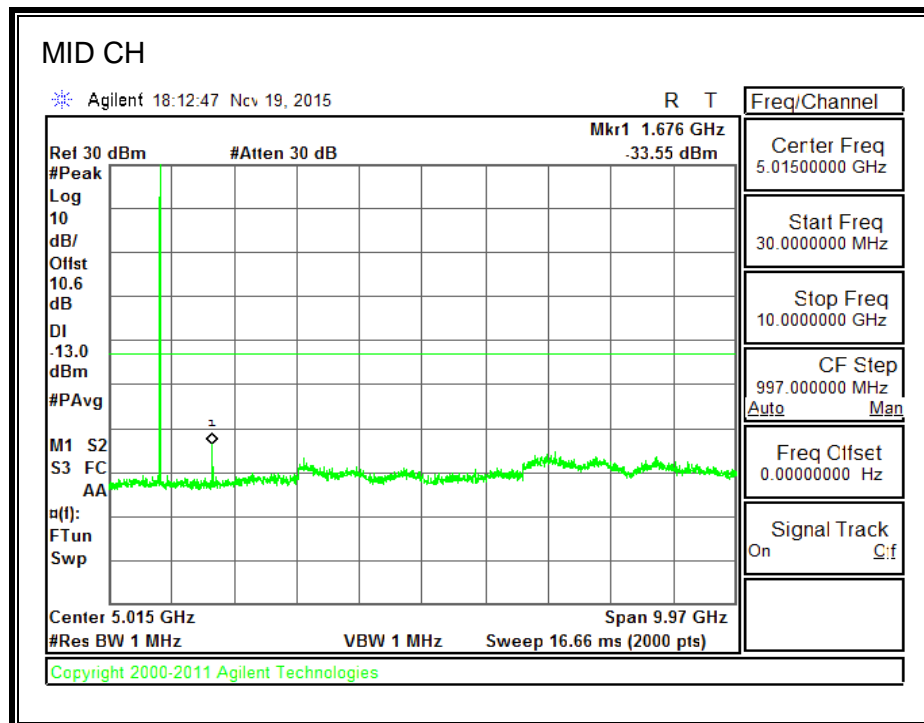
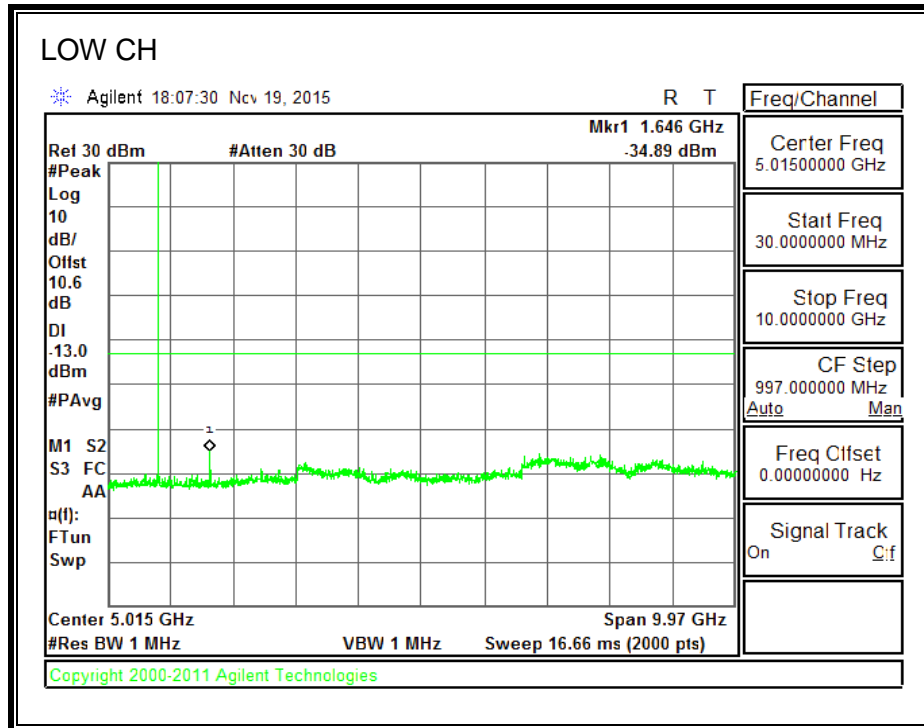

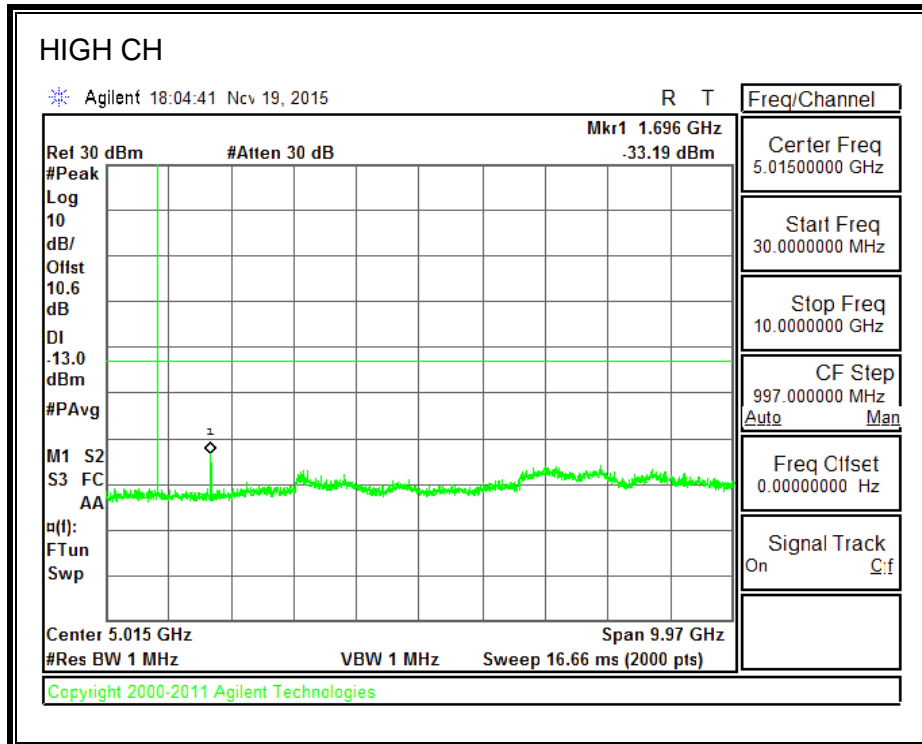

1900MHz BAND

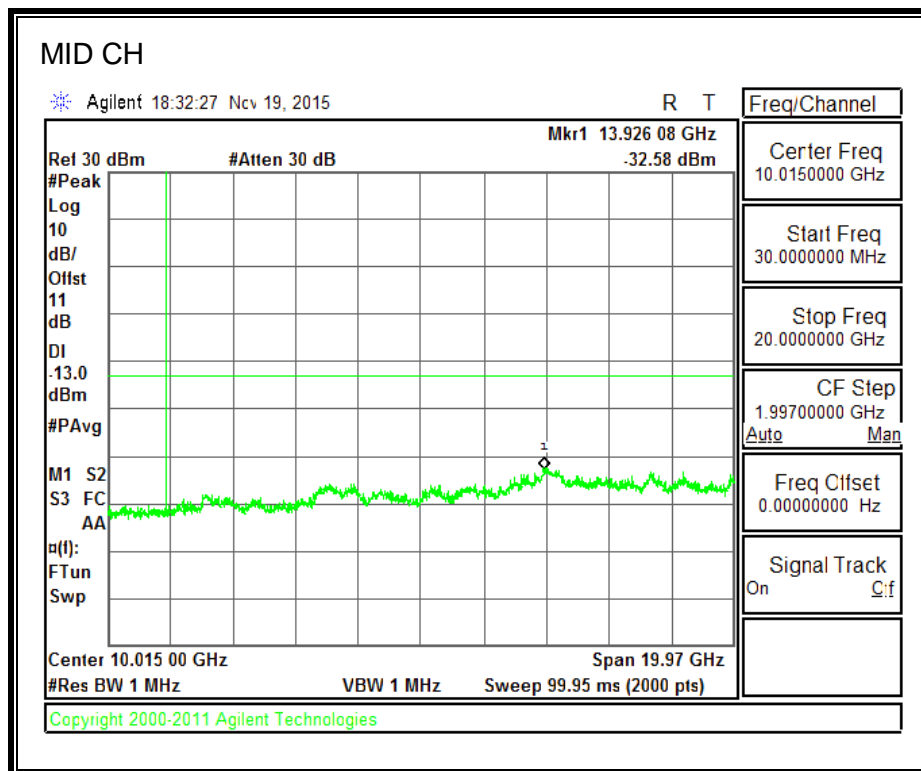
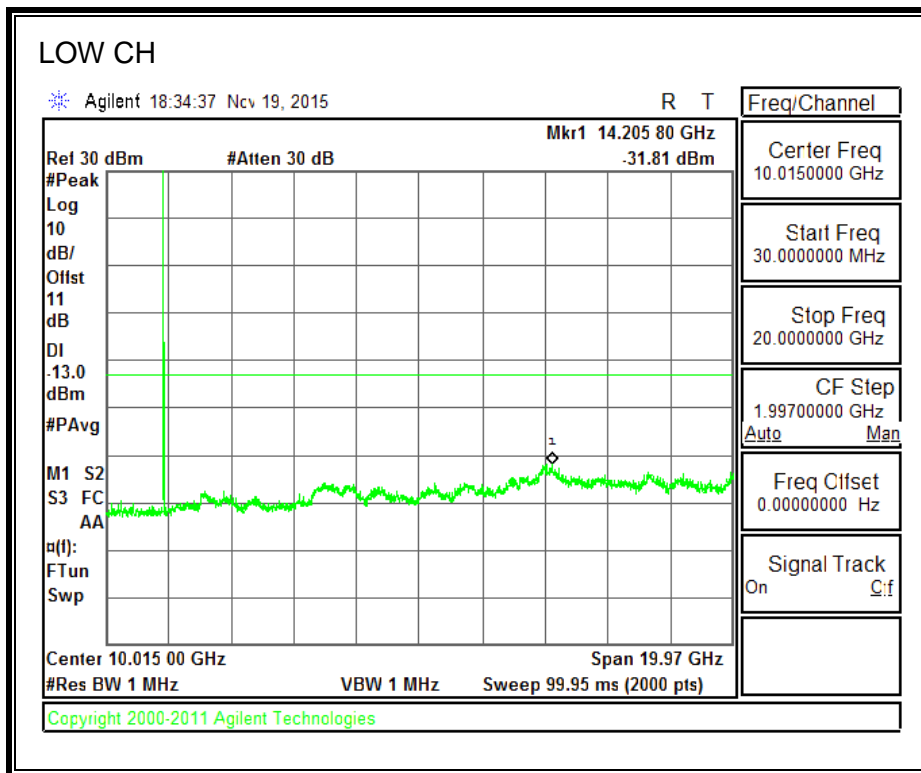

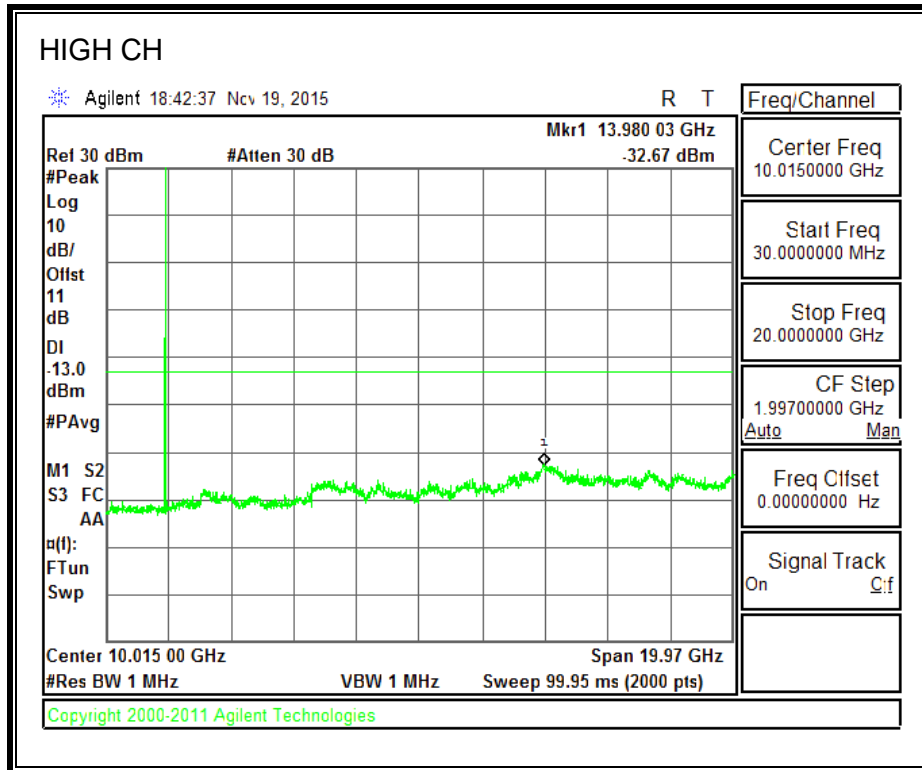

8.3.3. CDMA2000 1xRTT

850MHz BAND

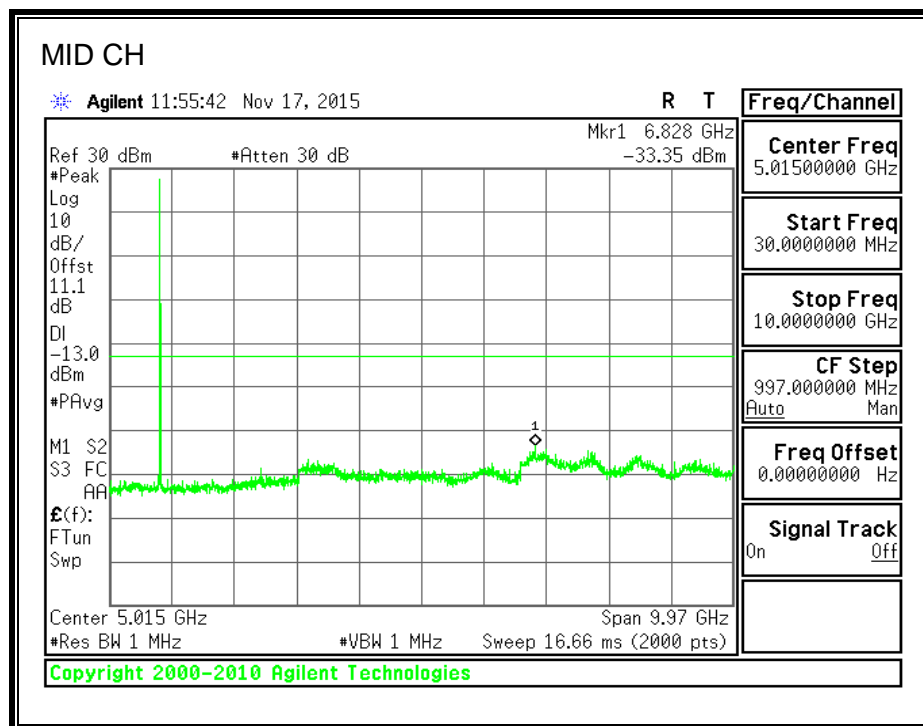
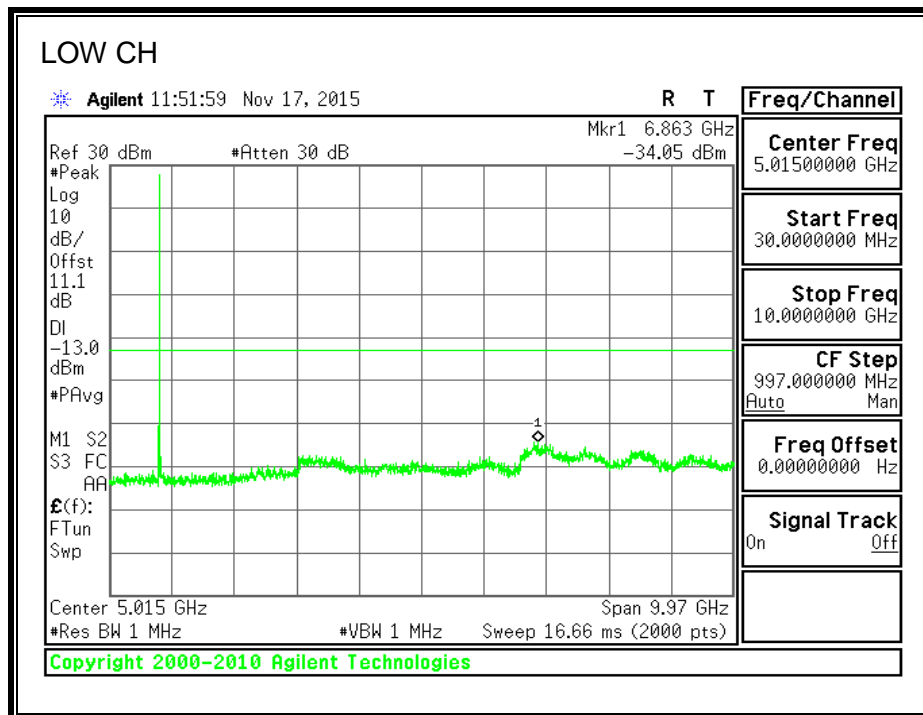

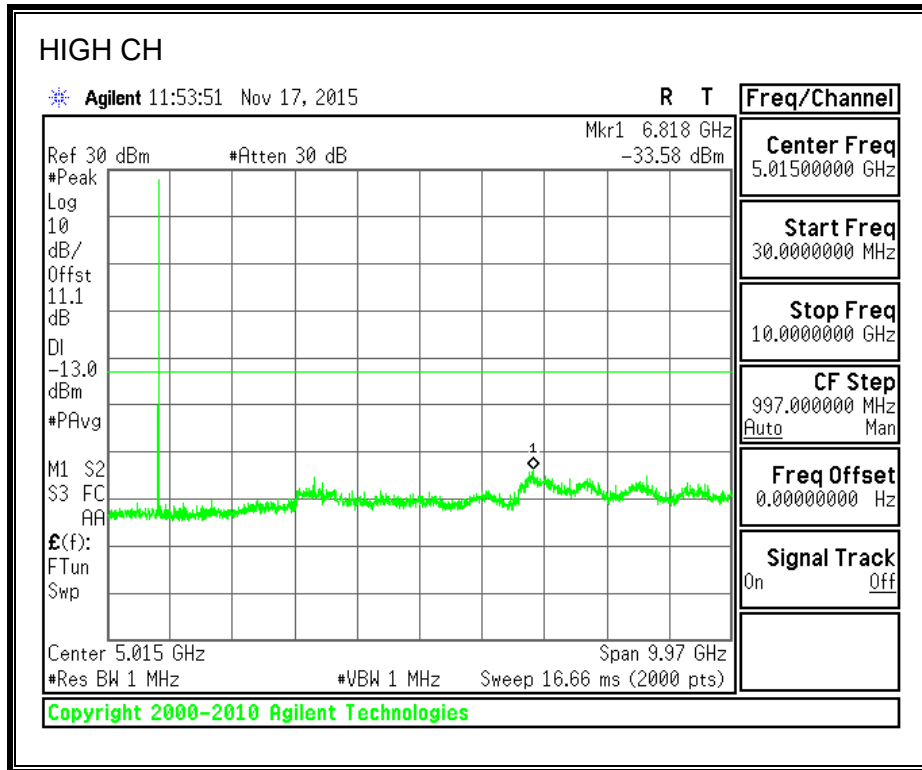

1900MHz BAND

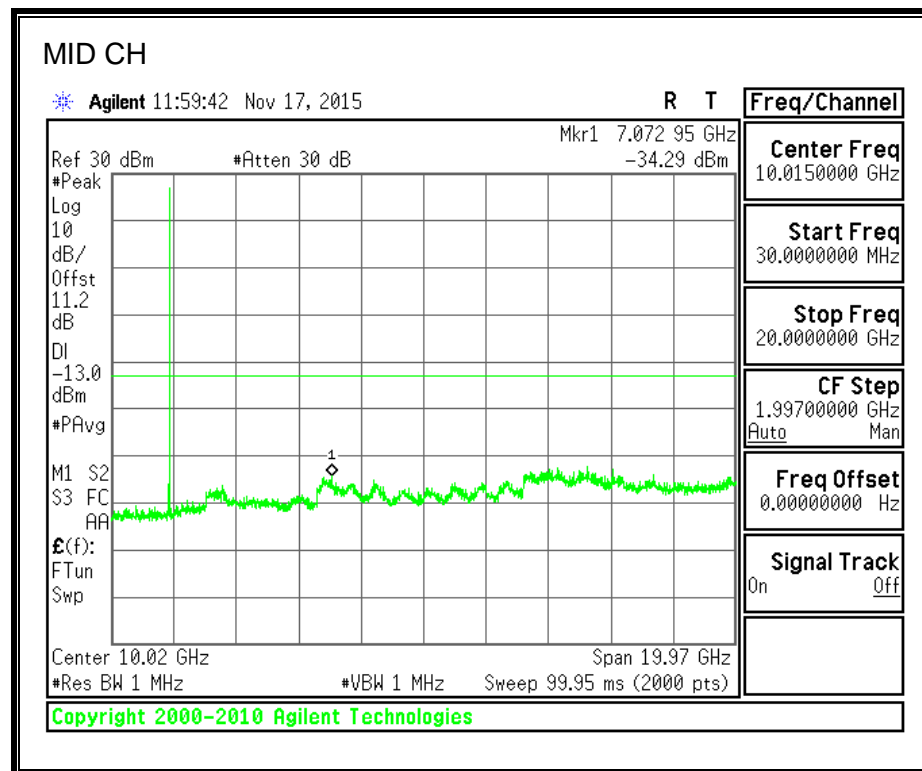
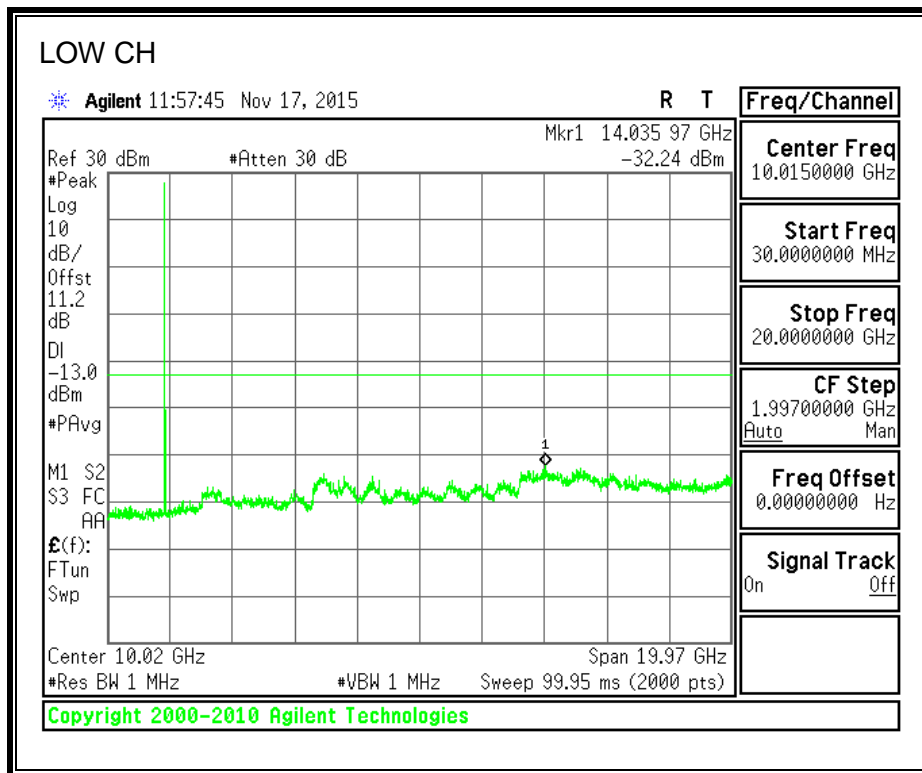

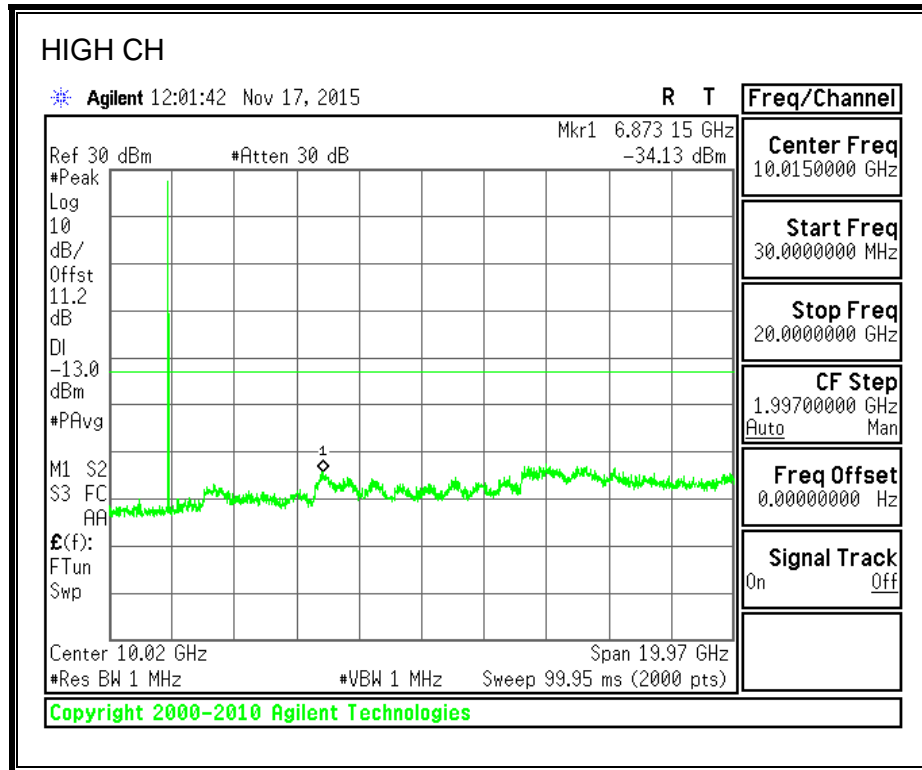

1700MHz BAND

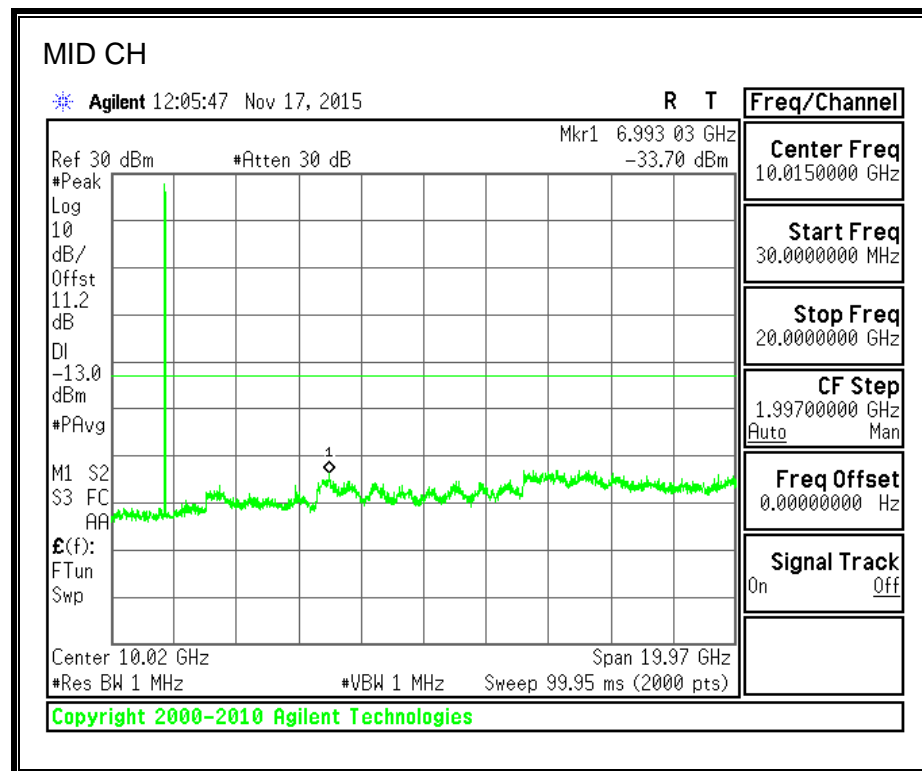
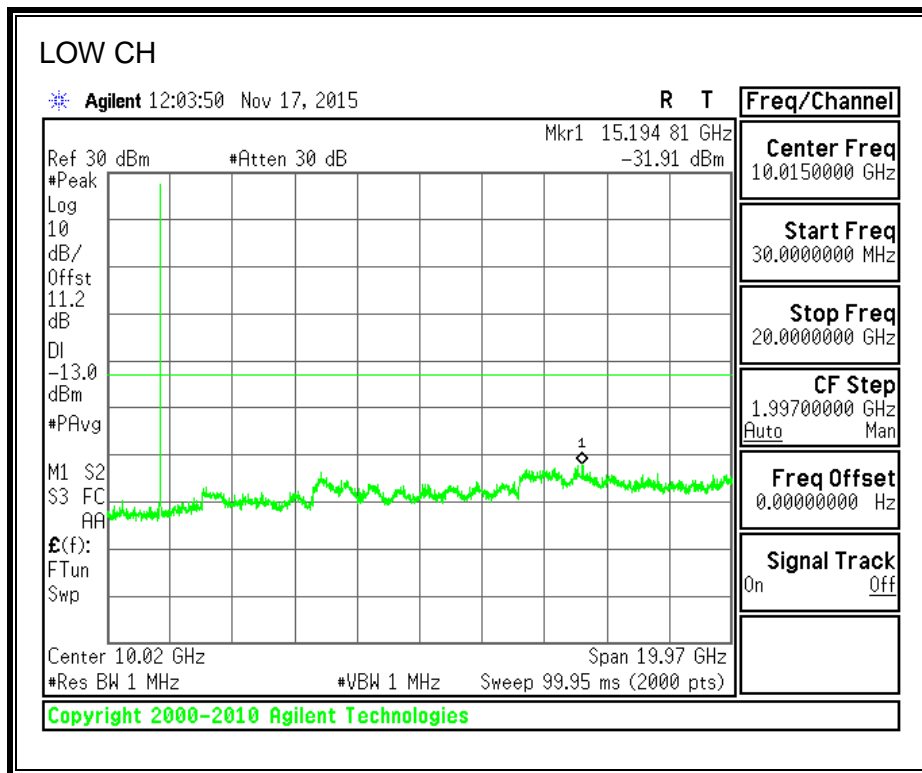

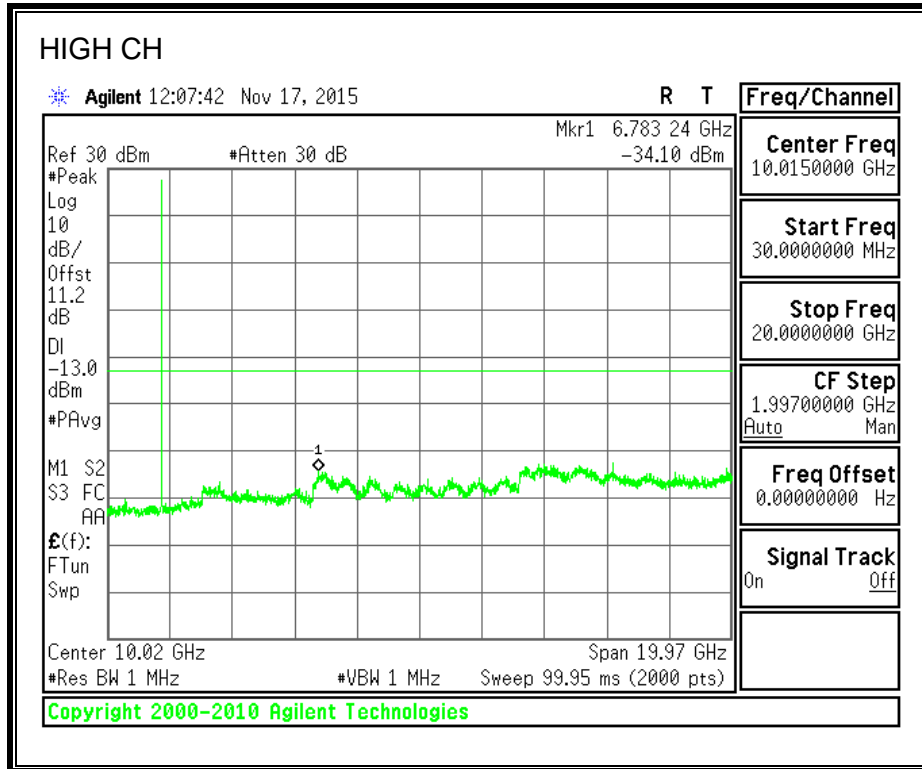

800MHz SECONDARY BAND

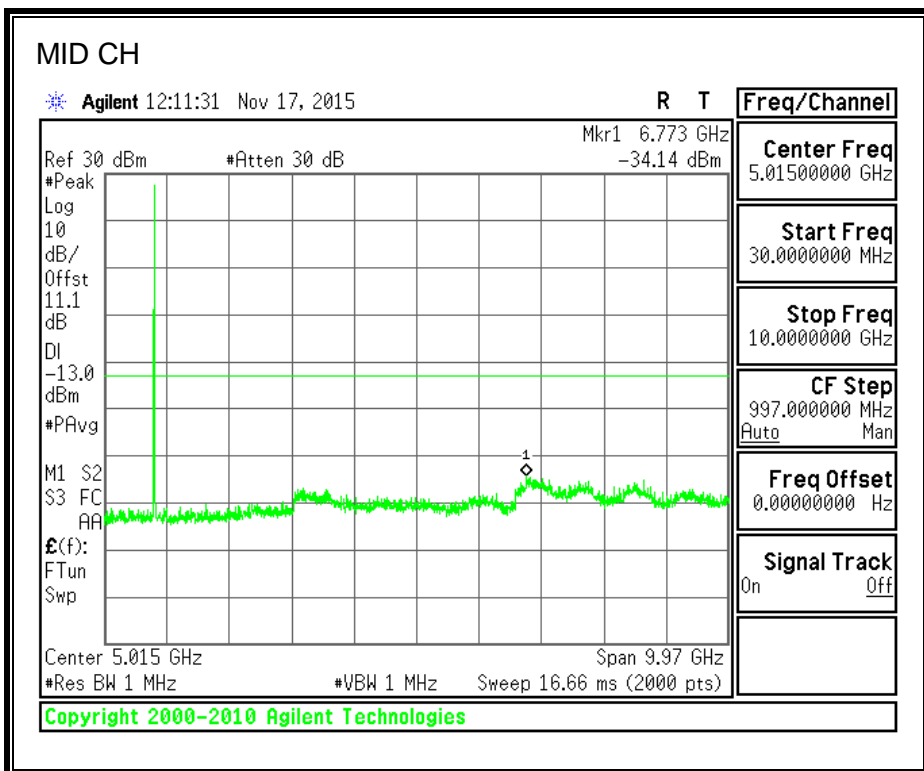
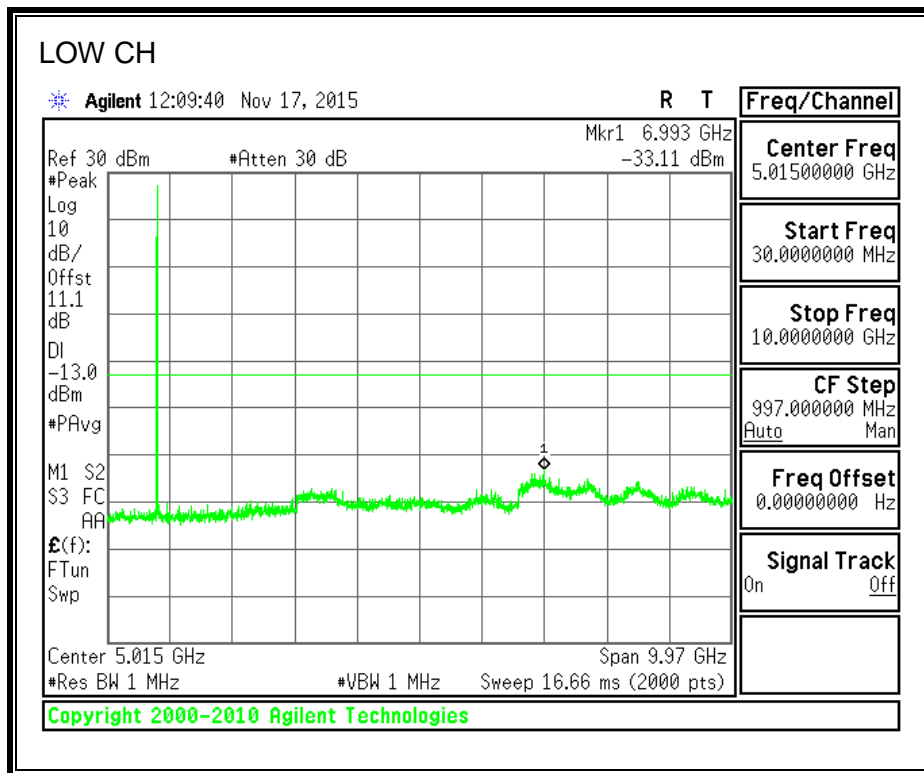

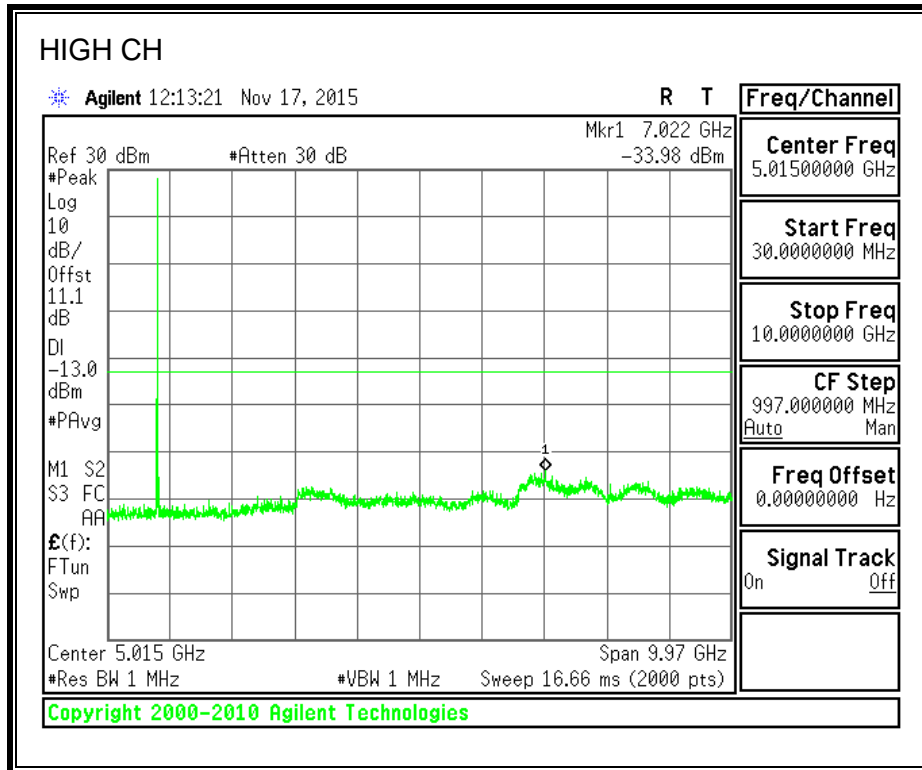

8.3.4. CDMA2000 EVDO REV A

850MHz BAND

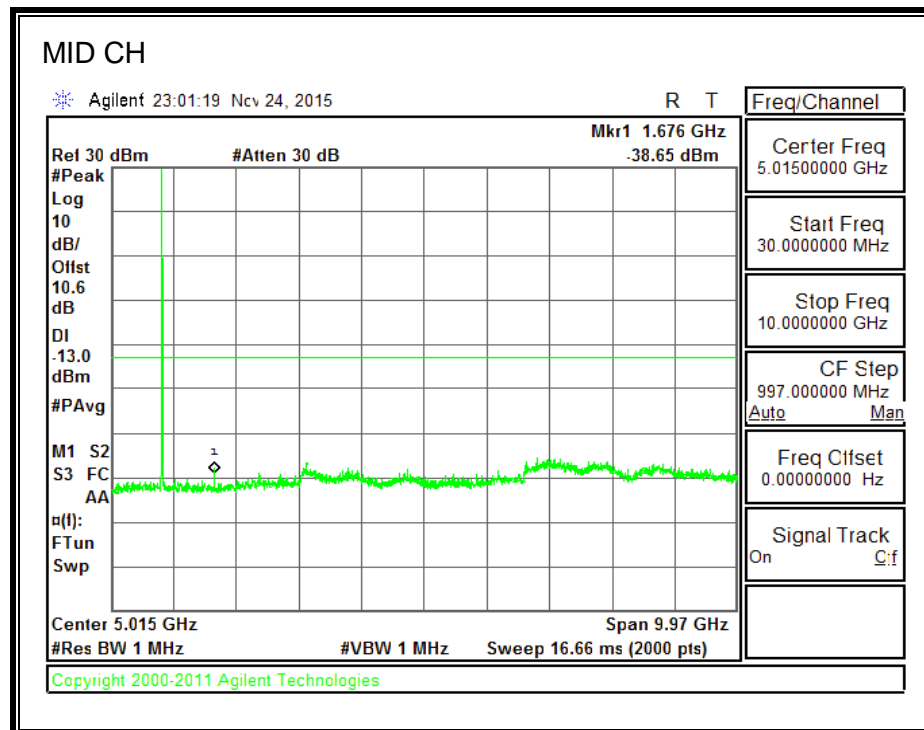
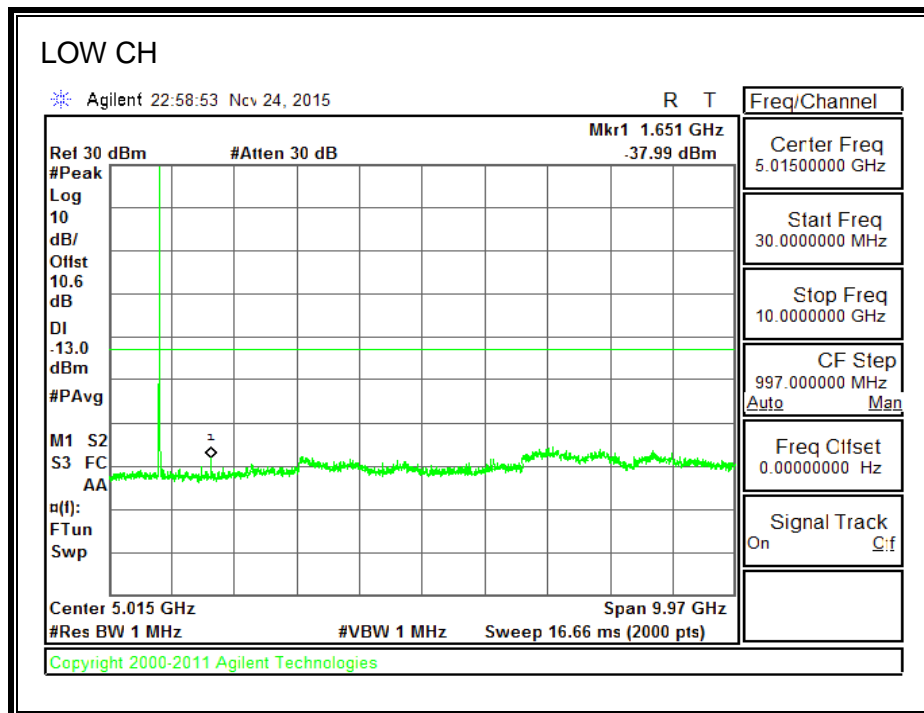

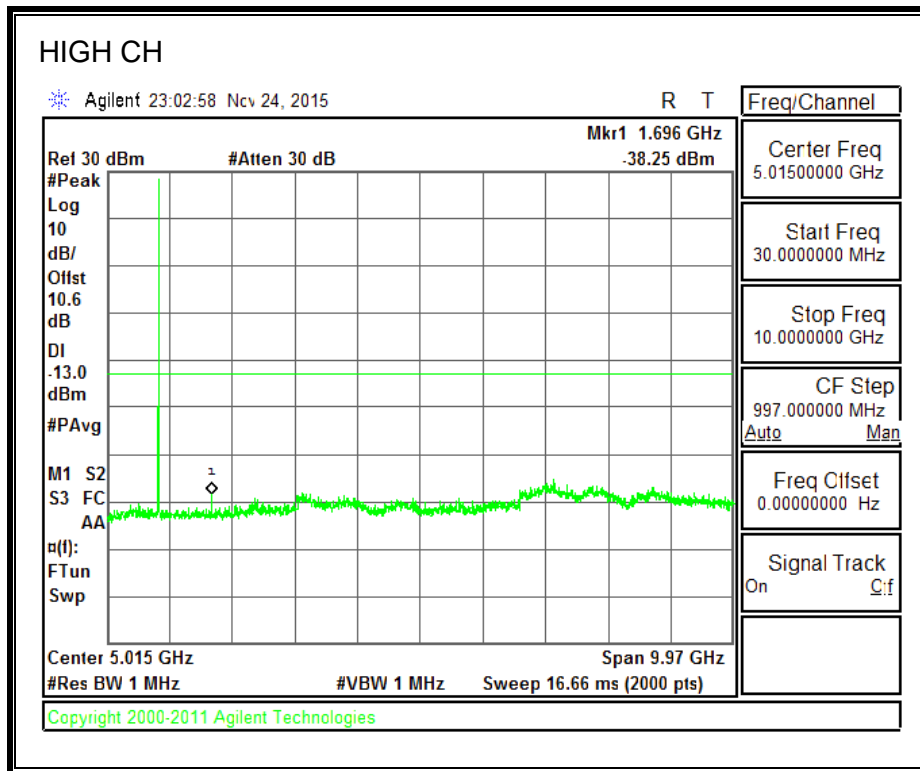

1900MHz BAND

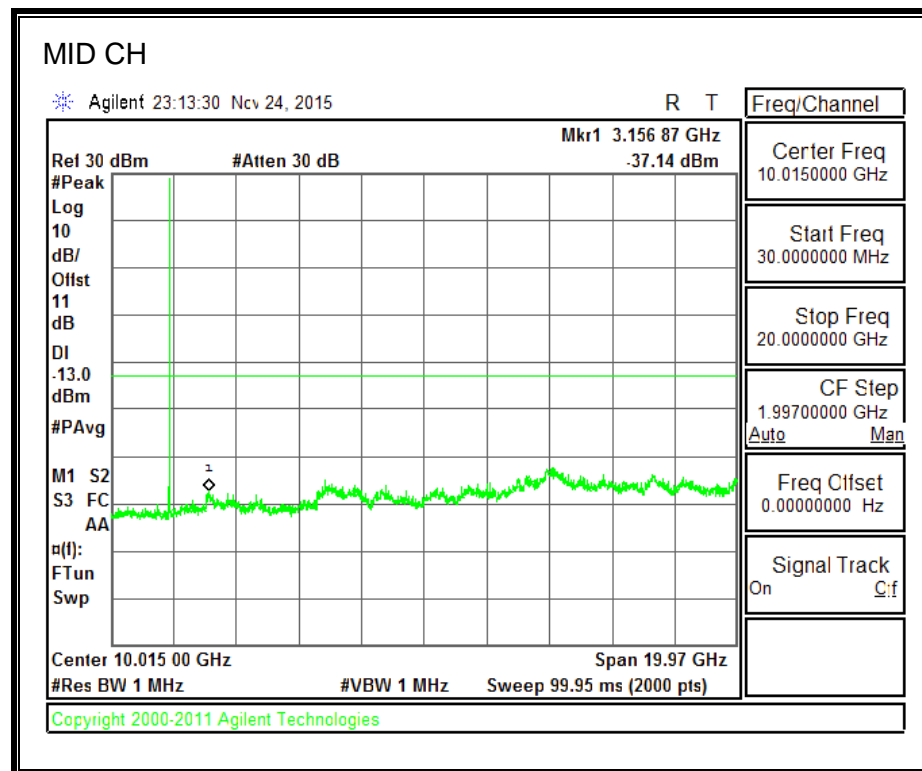
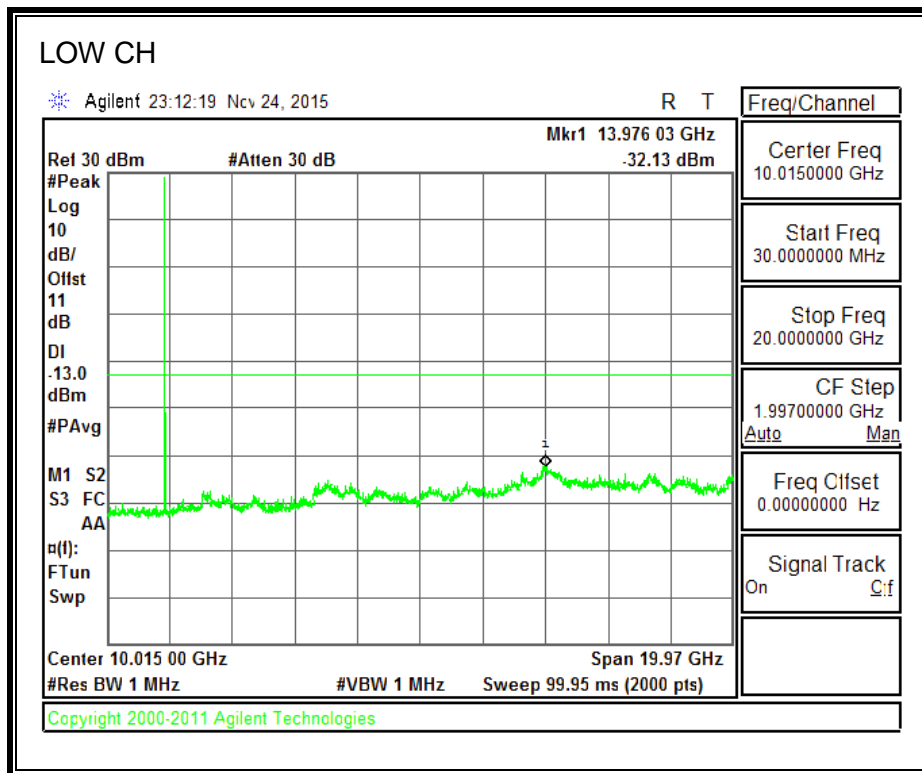

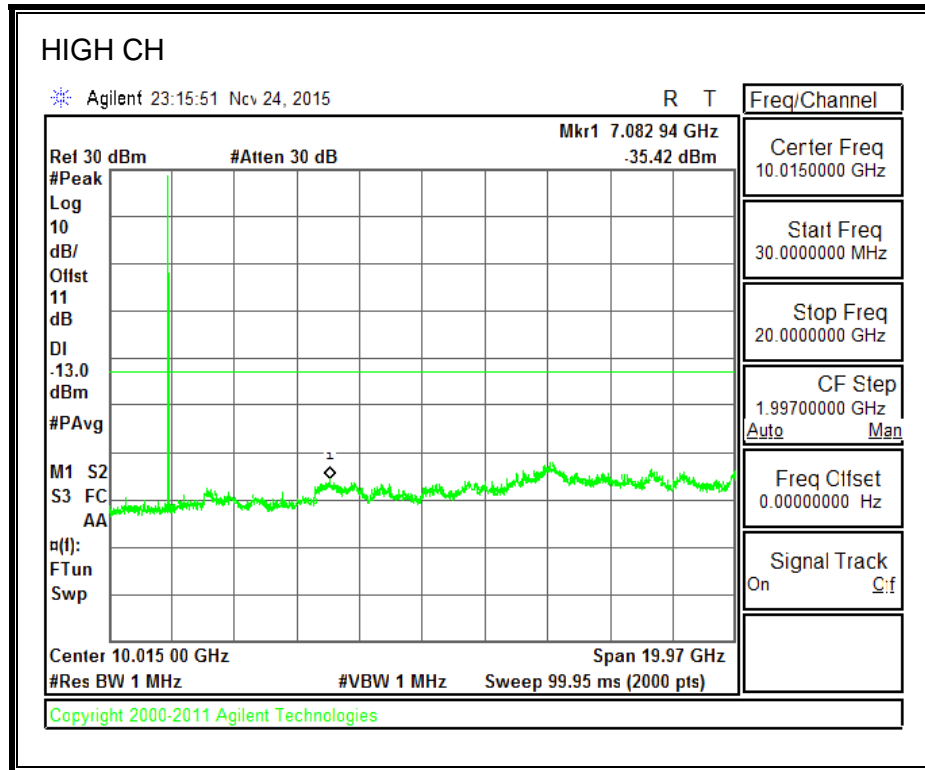

1700MHz BAND

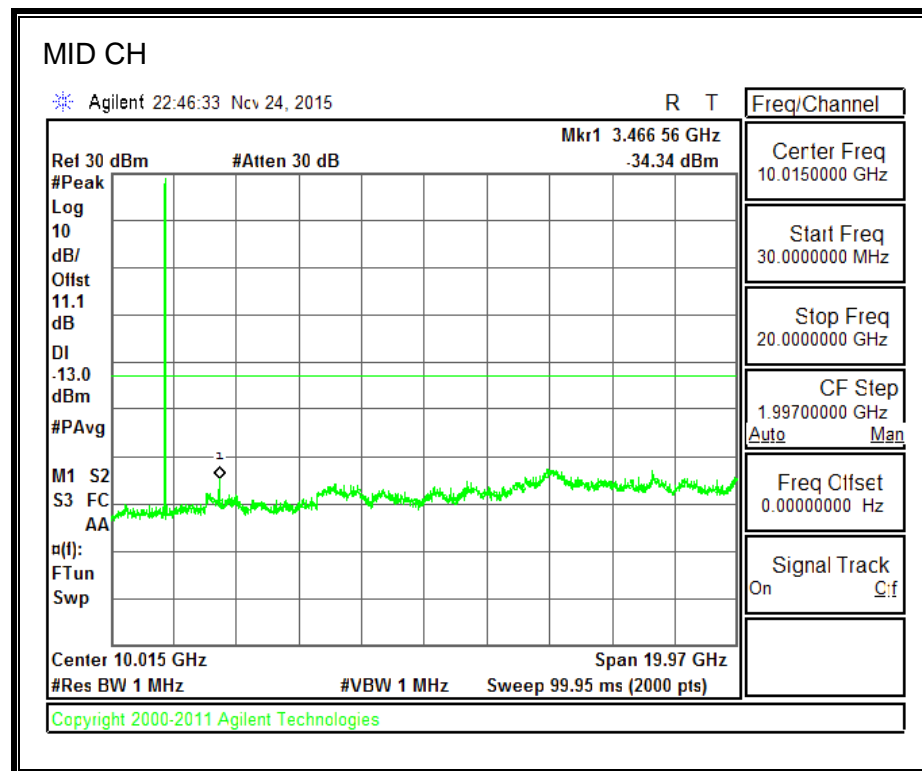
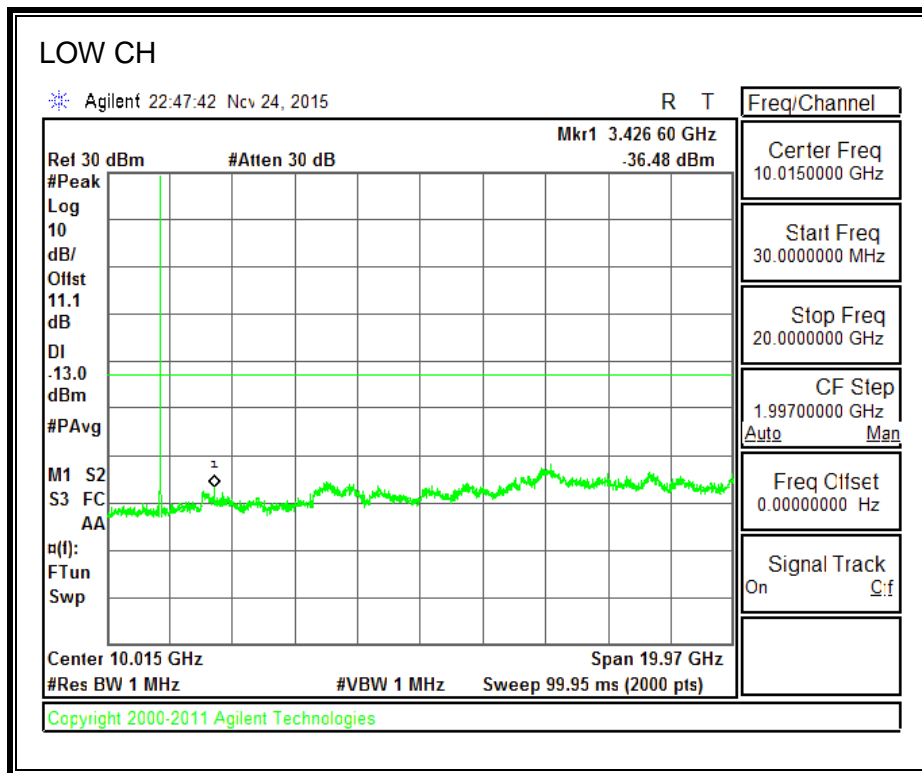

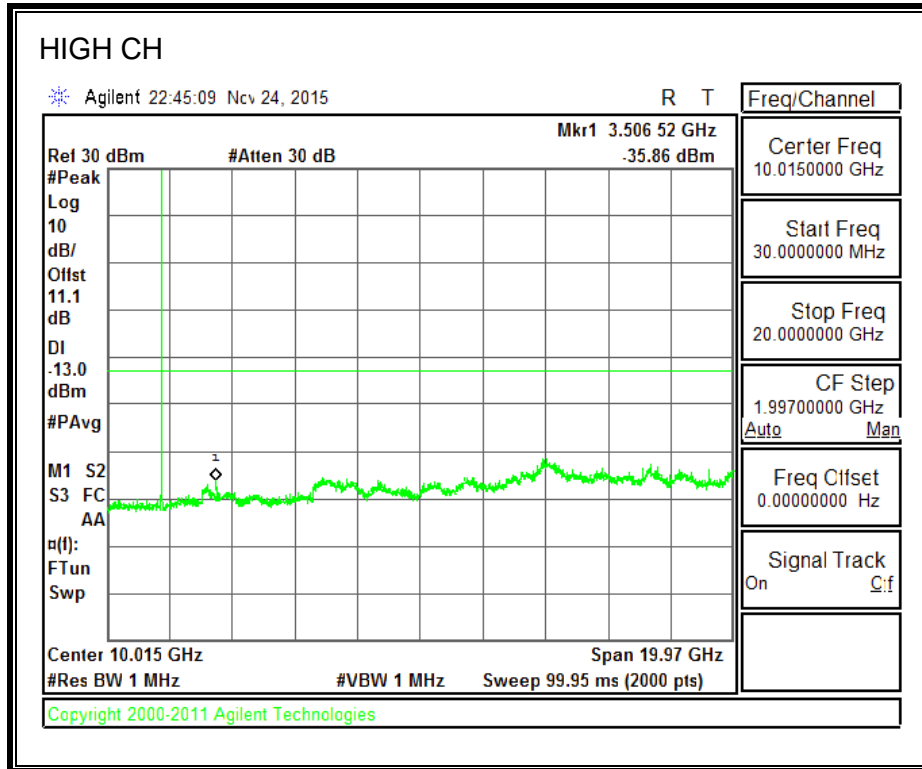

800MHz SECONDARY BAND

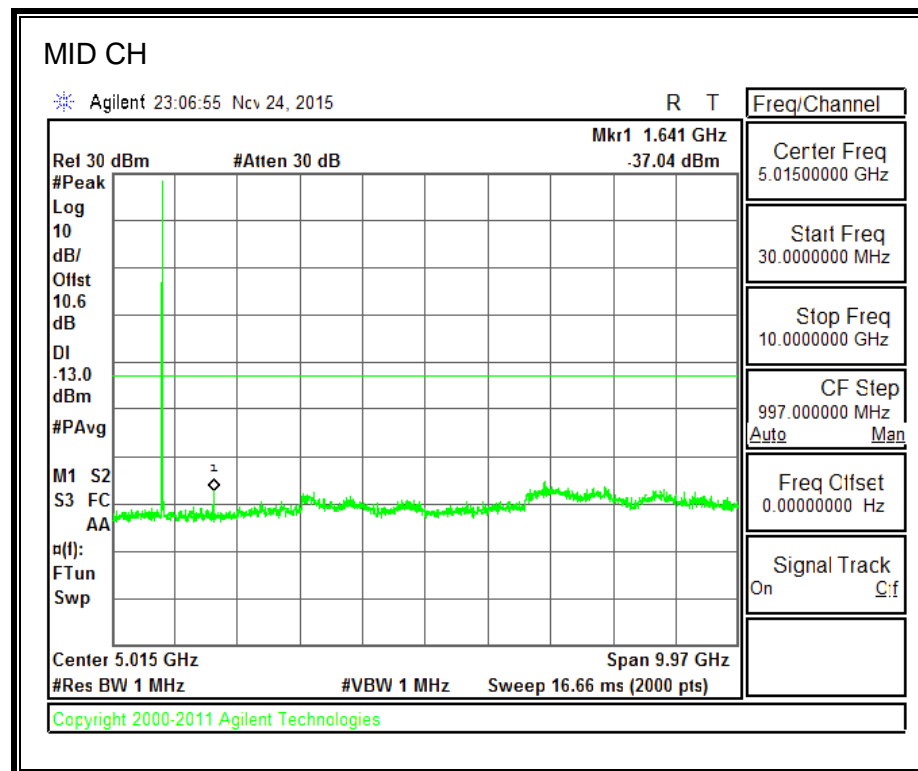
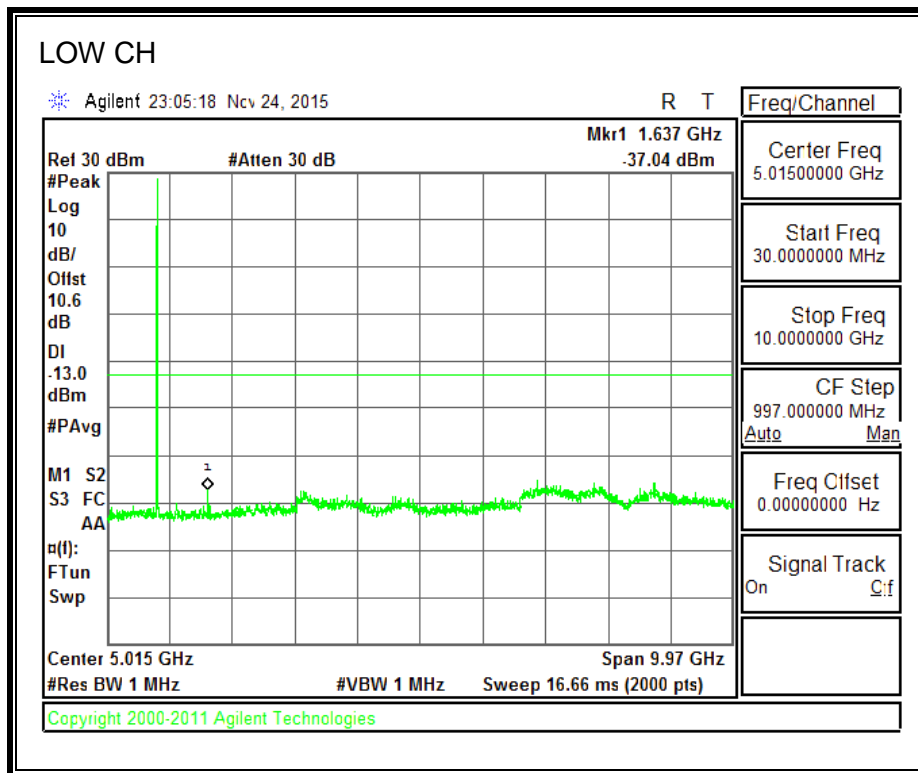

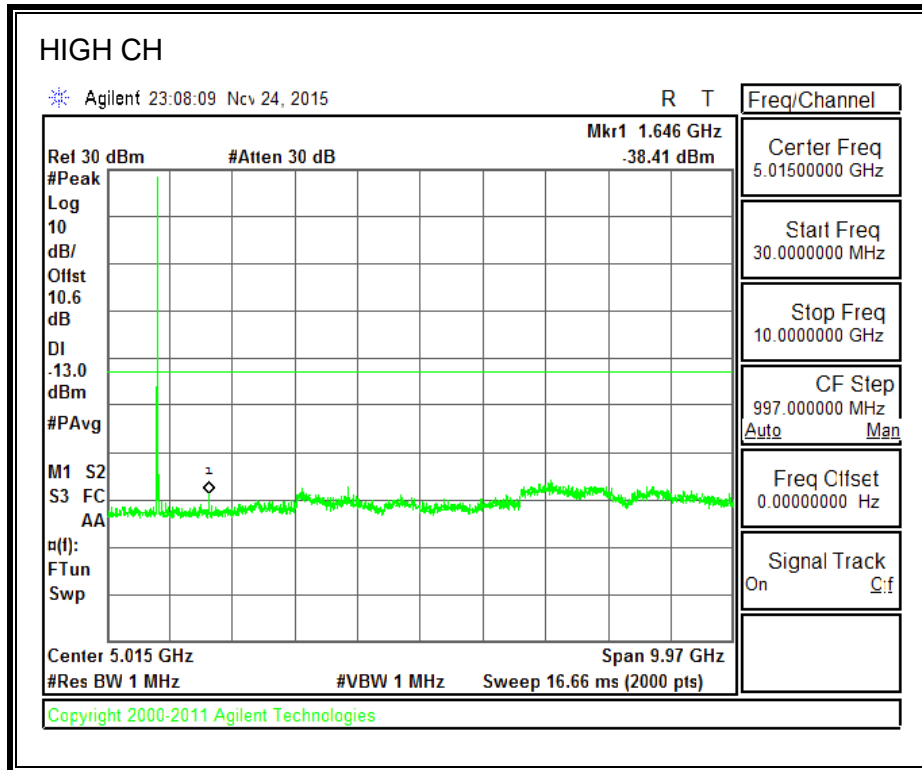

8.3.5. UMTS REL 99

850MHz BAND

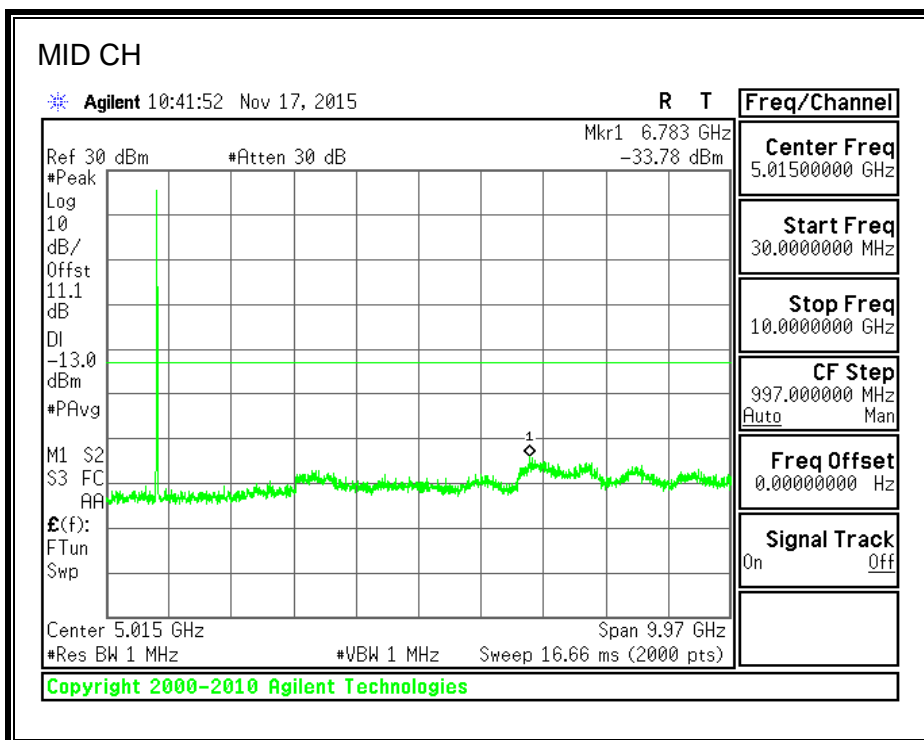
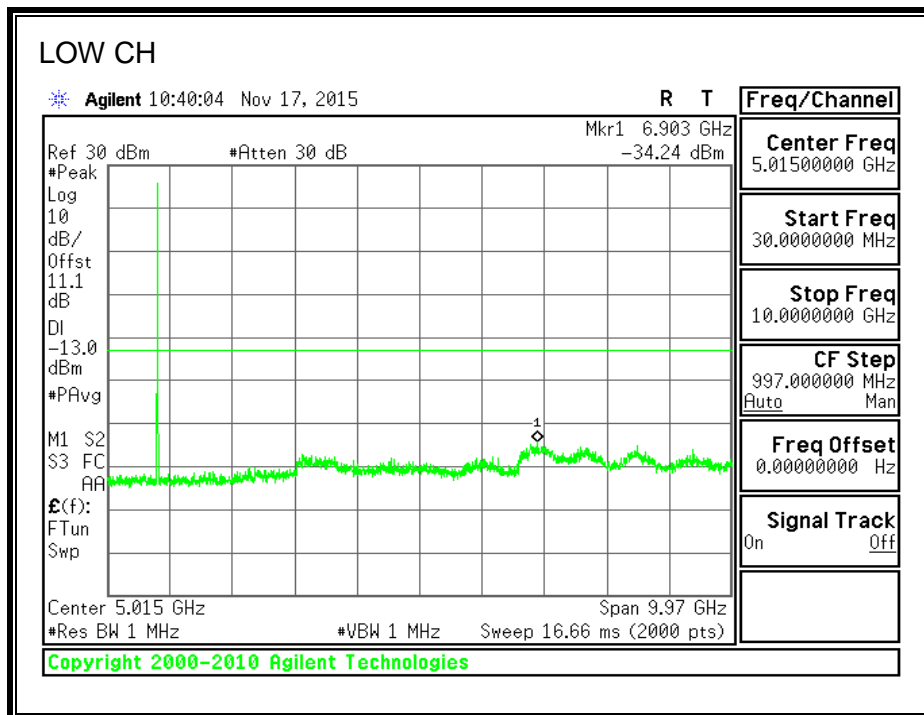

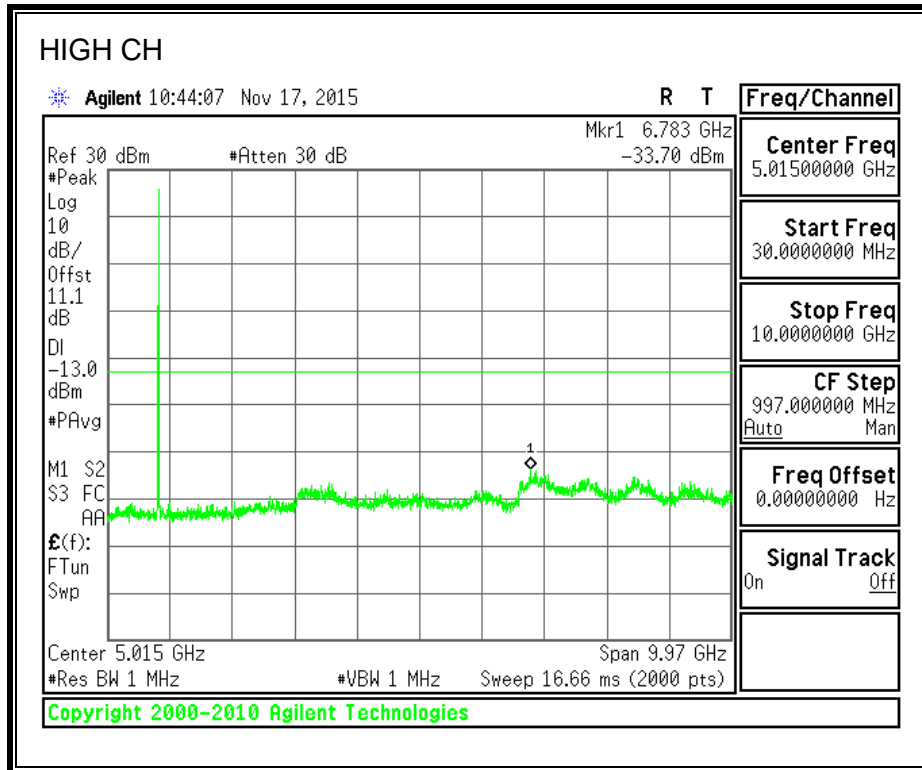

1900MHz BAND

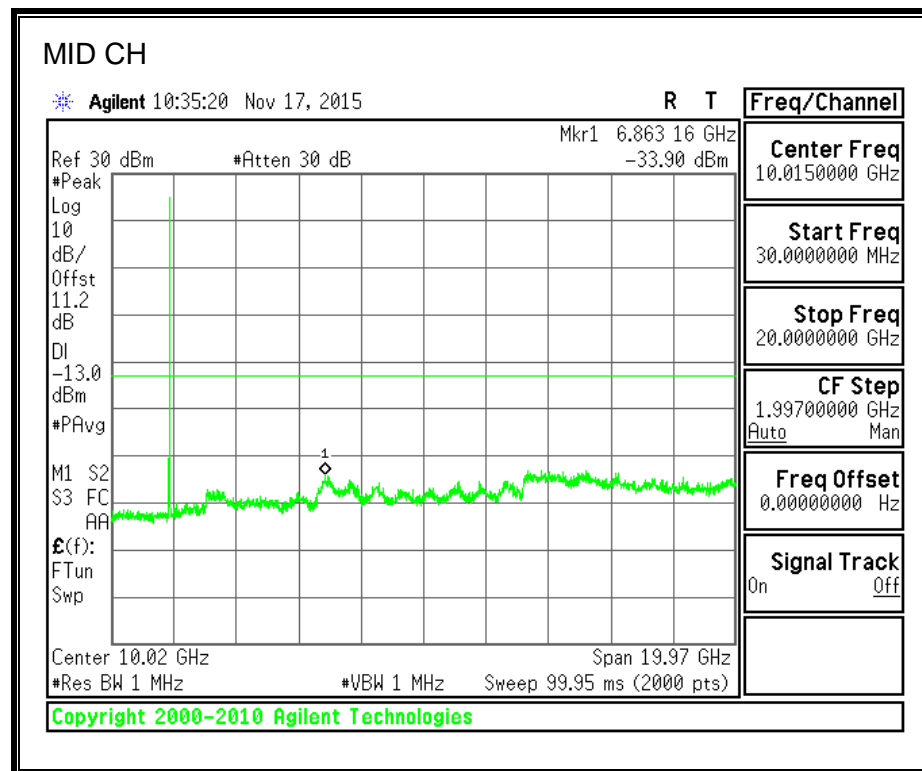
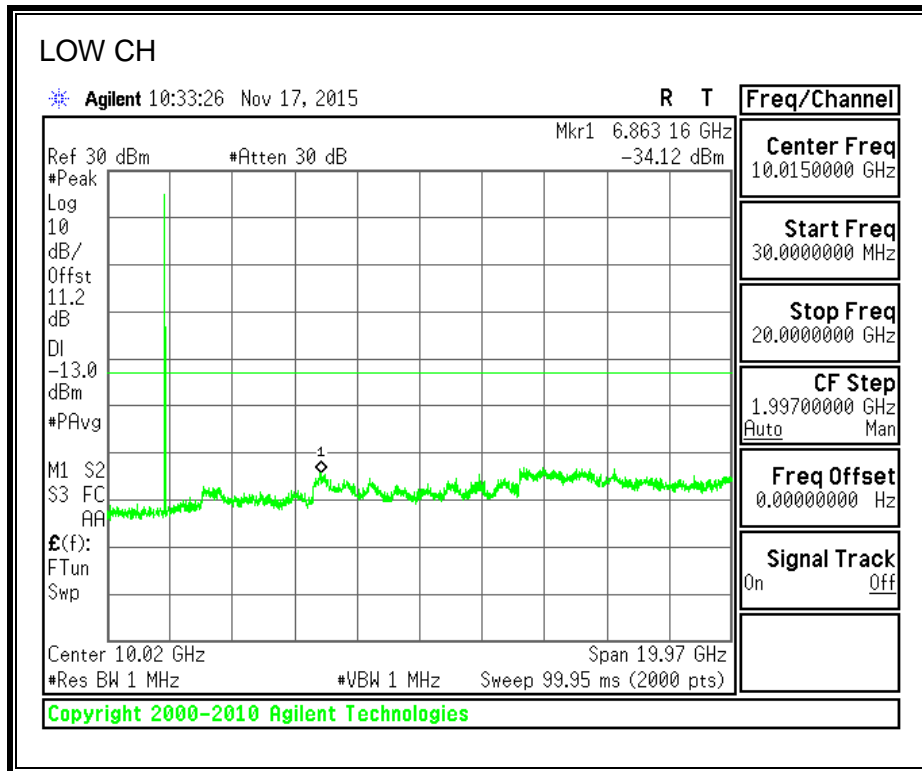

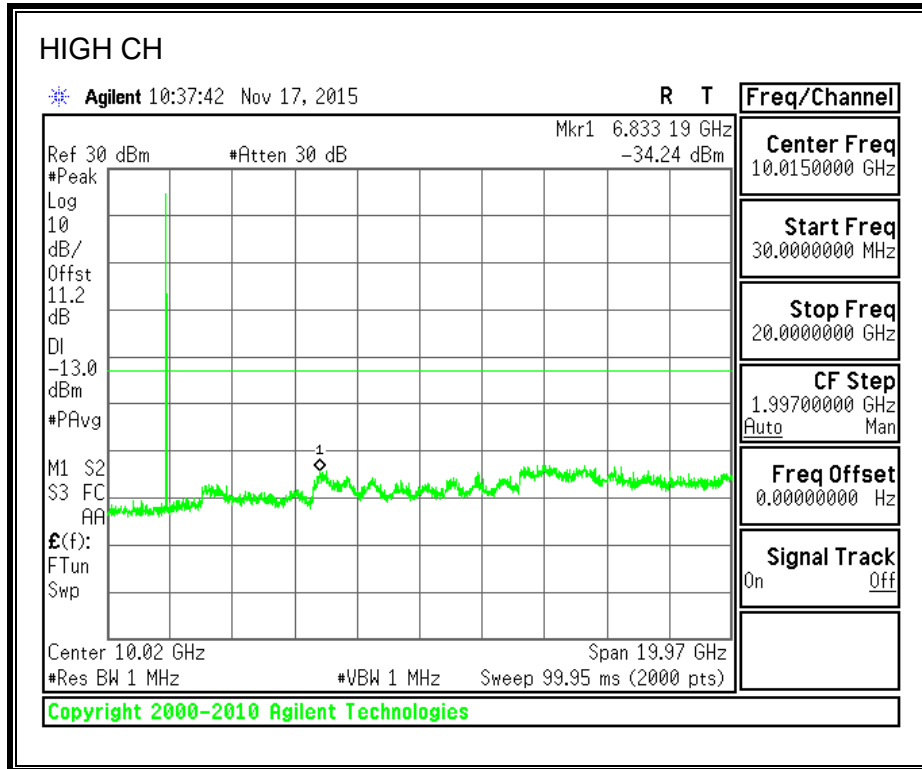

1700MHz BAND

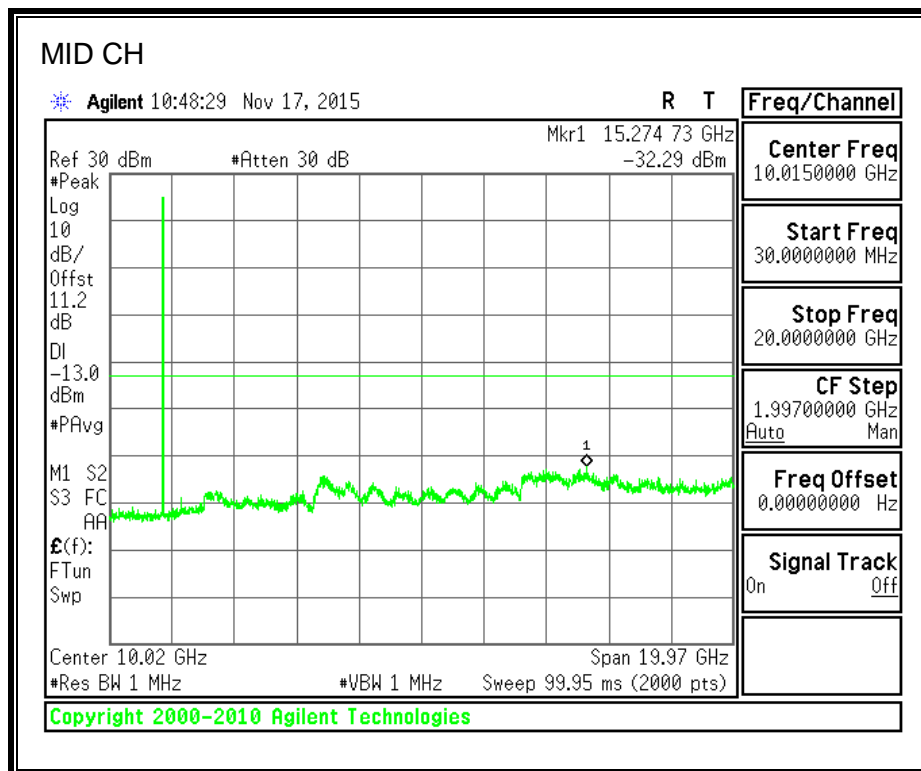
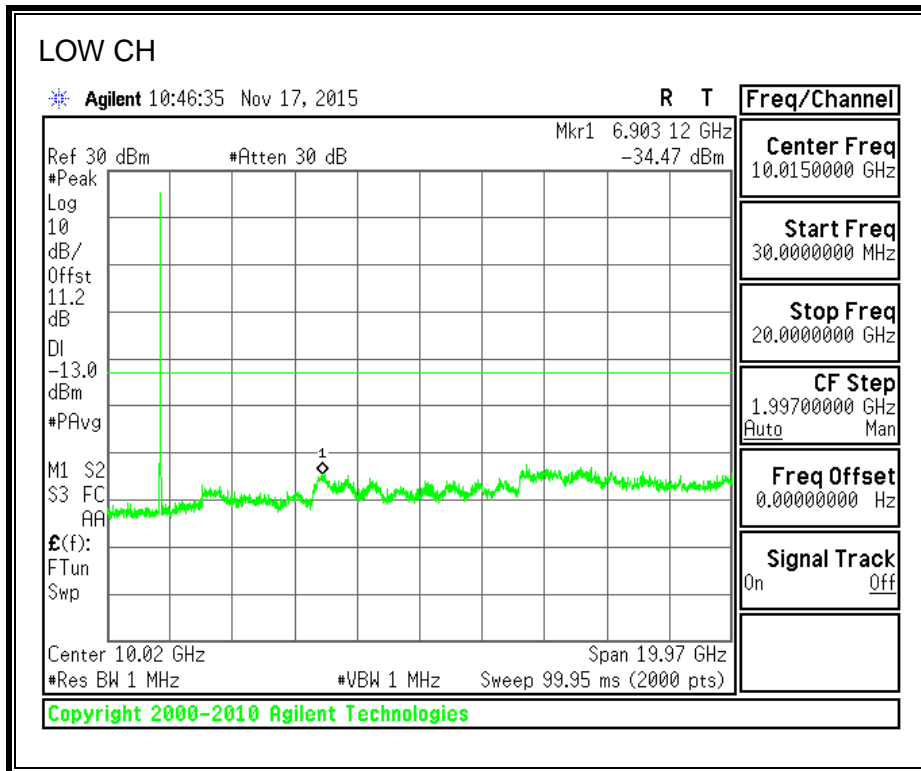

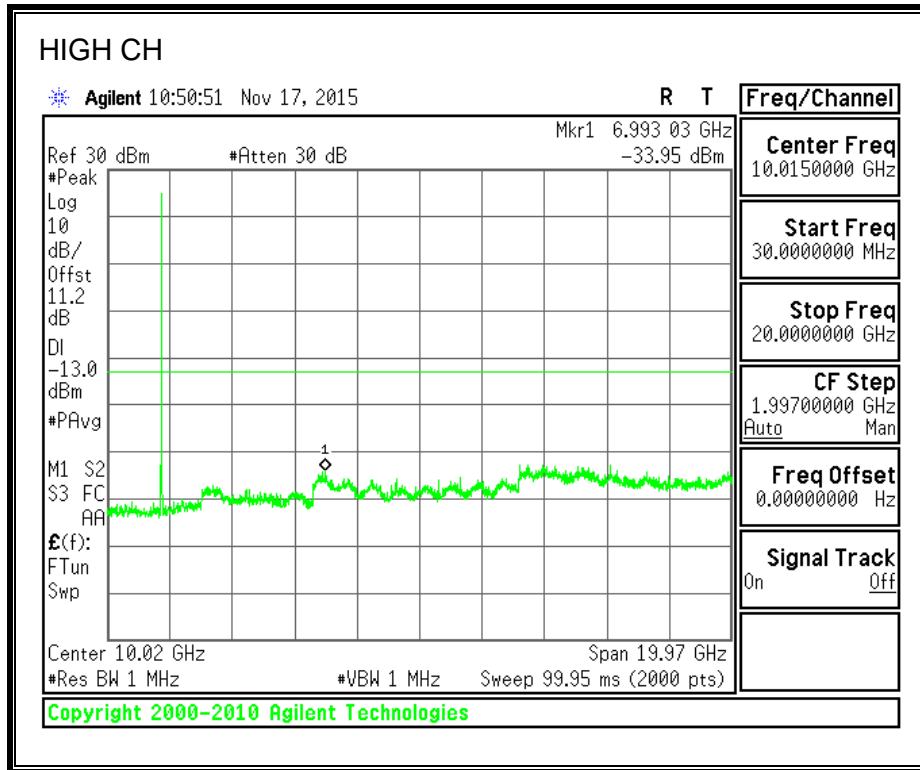

8.3.6. UMTS HSDPA

850MHz BAND

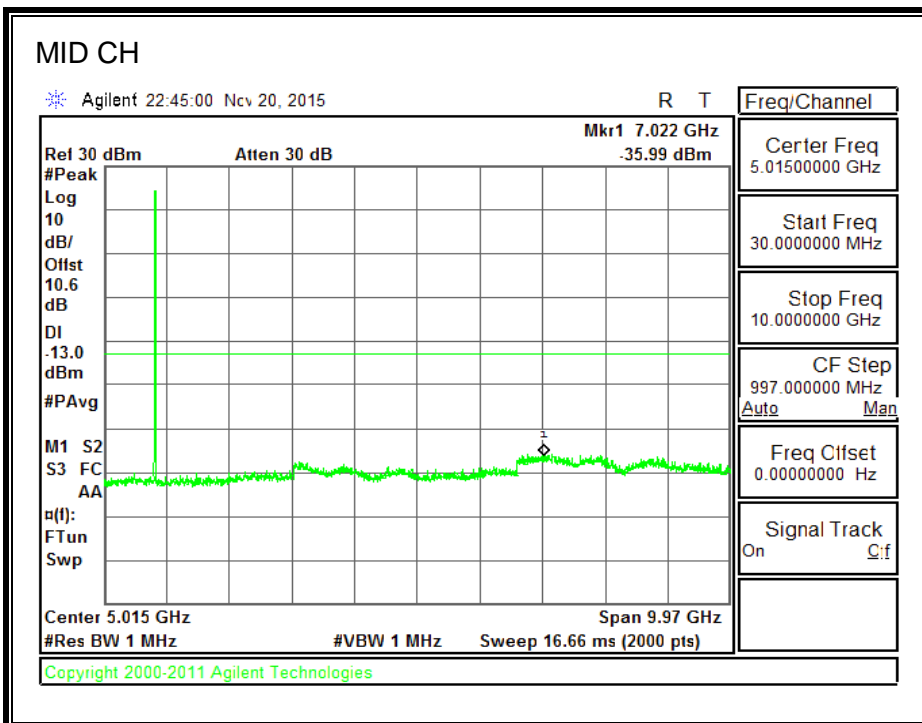
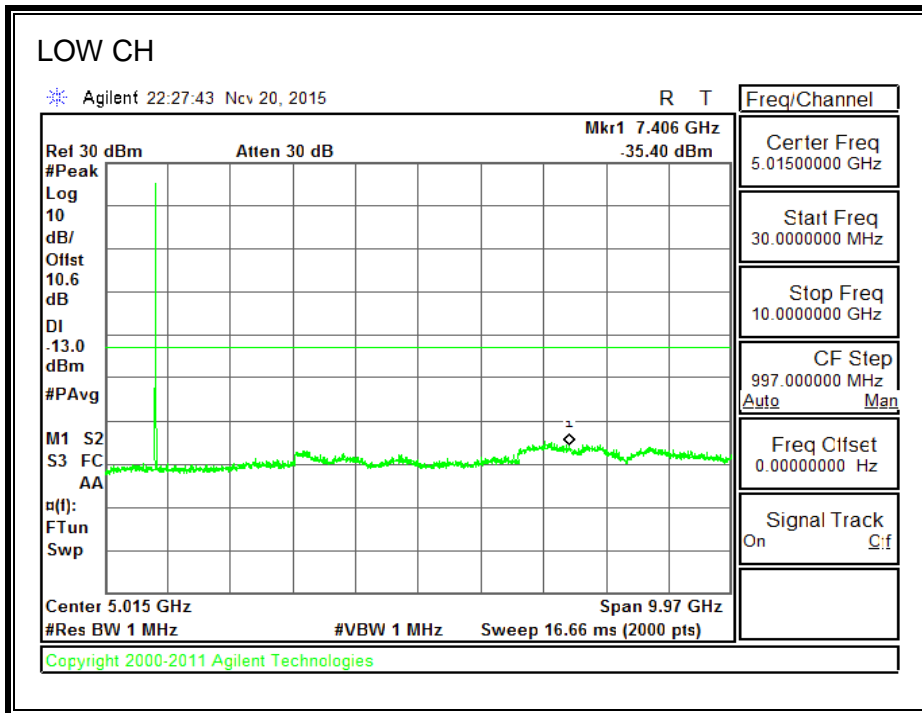

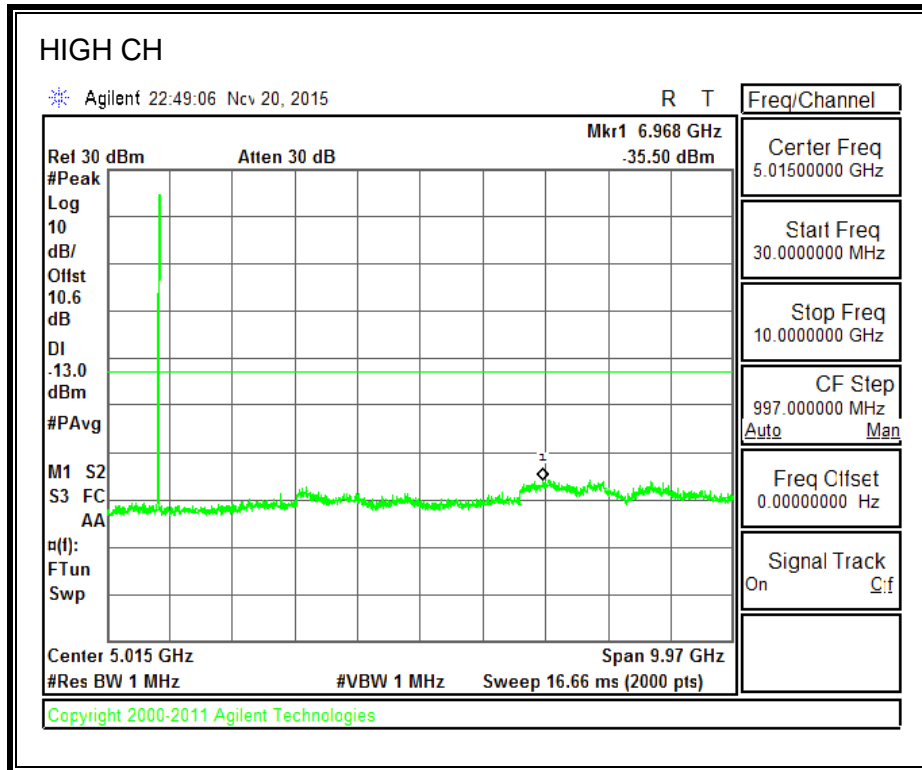

1900MHz BAND

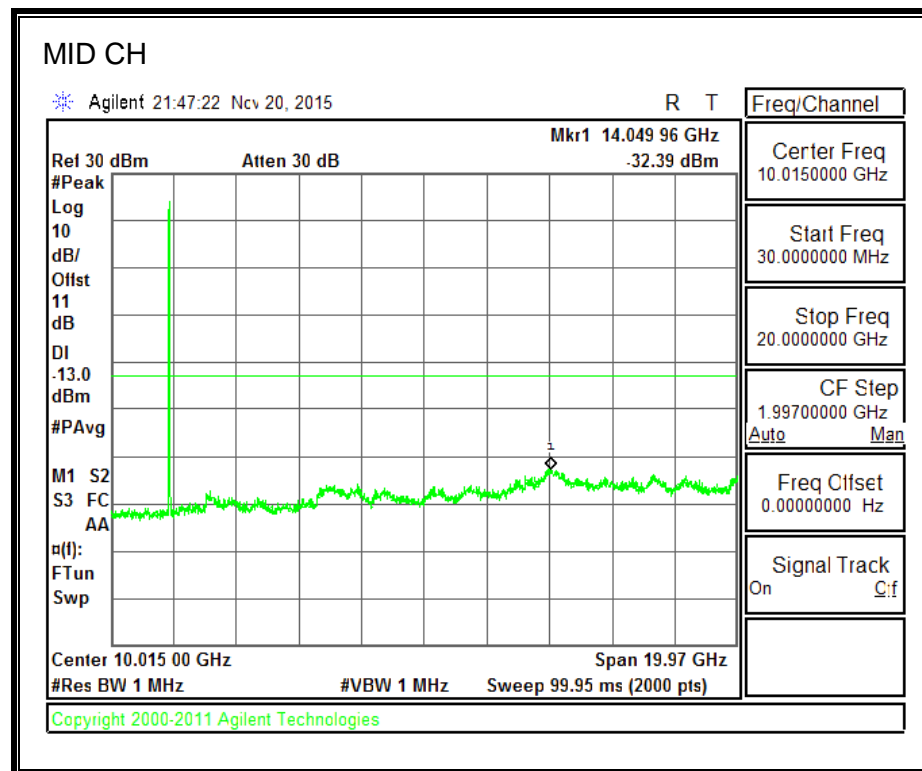
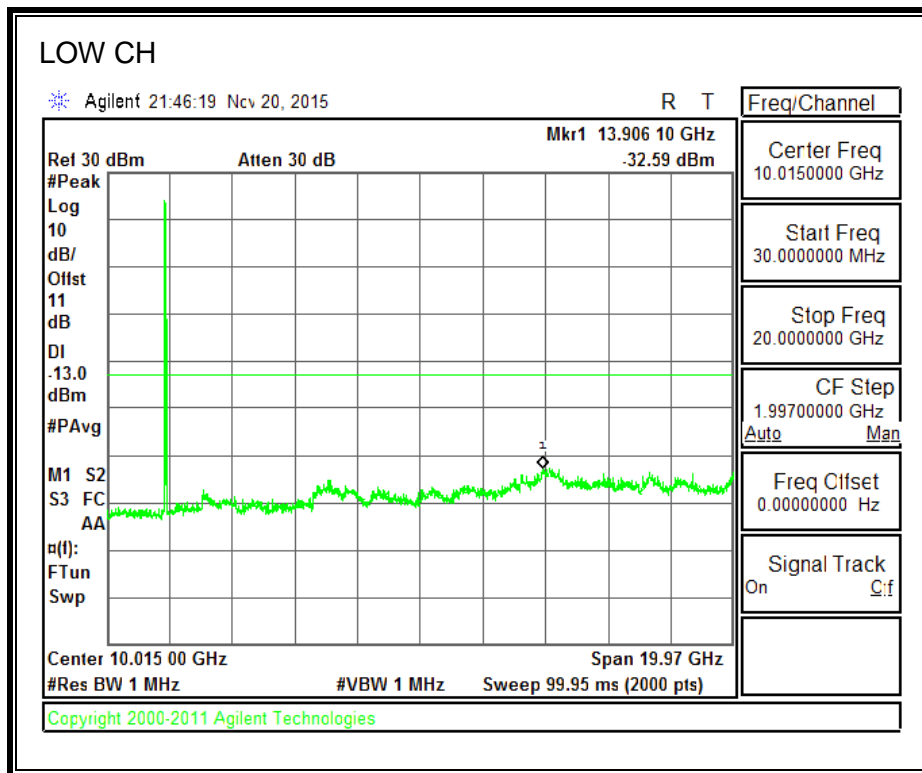

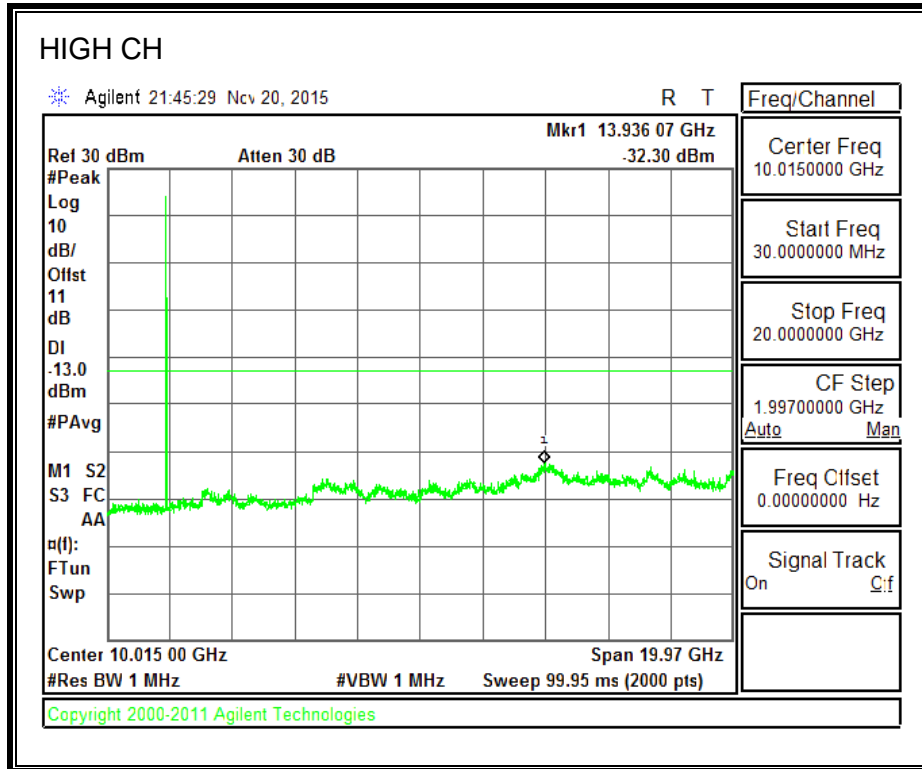

1700MHz BAND

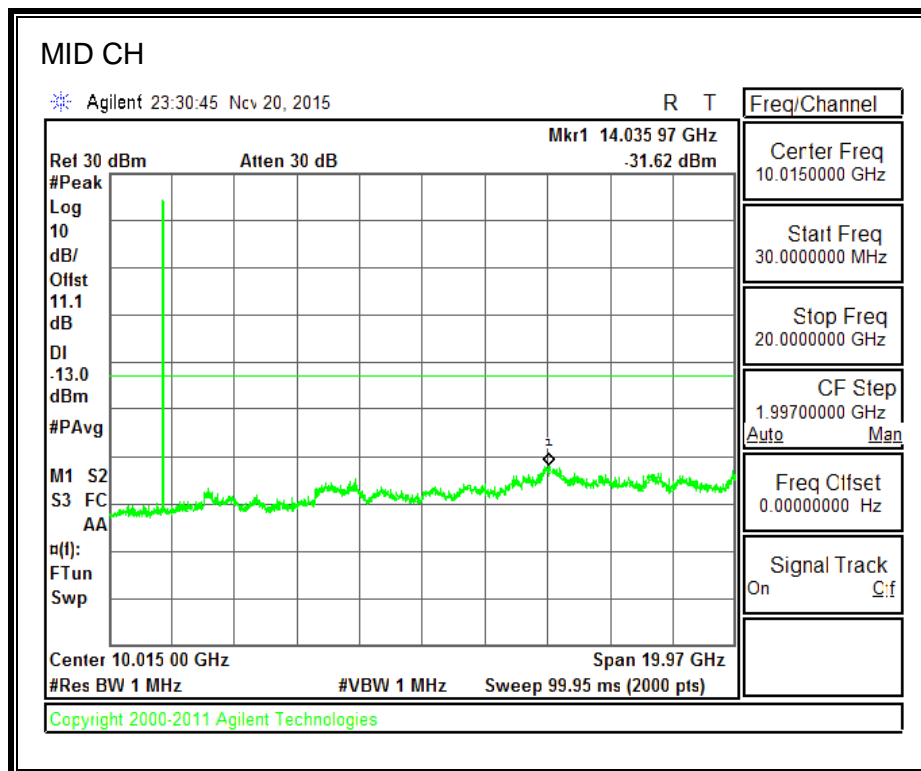
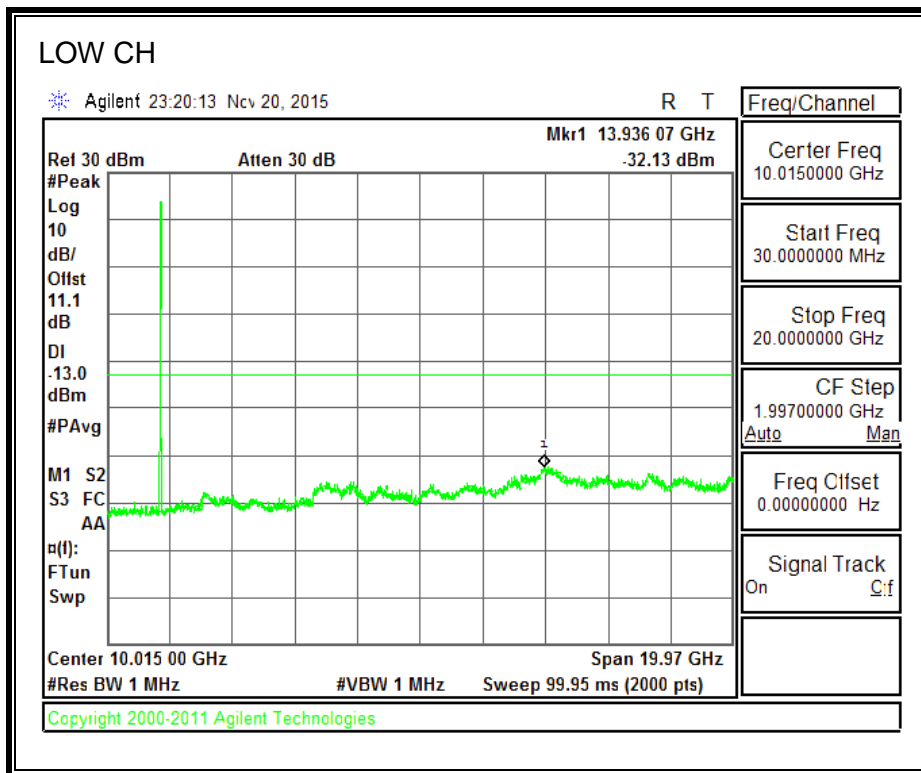

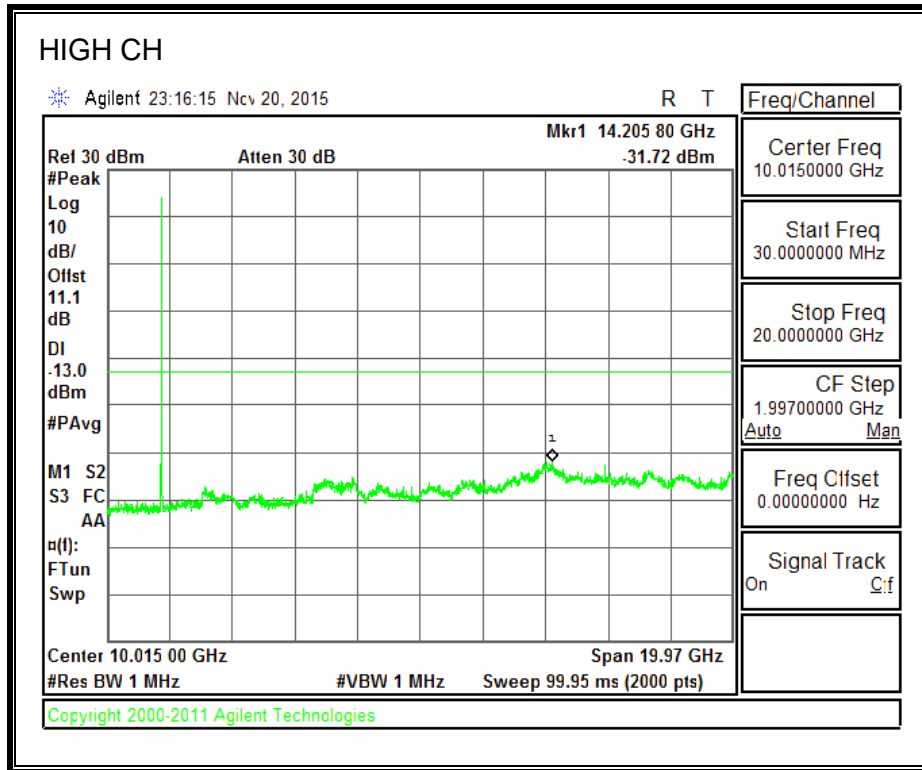

9. FREQUENCY STABILITY

RULE PART(S)

FCC: §2.1055, §22.355, §24.235, §27.54.and §90.213

LIMITS

§22.355 - The carrier frequency shall not depart from the reference frequency in excess of ± 2.5 ppm for mobile stations.

§24.235 & §27.54 - The frequency stability shall be sufficient to ensure that the fundamental emission stays within the authorized frequency block.

§90.213 - The carrier frequency shall not depart from the reference frequency in excess of ± 2.5 ppm for mobile stations

TEST PROCEDURE

Use CMW 500 with Frequency Error measurement capability.

- Temp. = -30° to $+50^{\circ}\text{C}$
- Voltage = (85% - 115%)

Frequency Stability vs Temperature:

The EUT is place inside a temperature chamber. The temperature is set to 20°C and allowed to stabilize. After sufficient soak time, the transmitting frequency error is measured. The temperature is increased by 10 degrees, allowed to stabilize and soak, and then the measurement is repeated. This is repeated until $+50^{\circ}\text{C}$ is reached.

Frequency Stability vs Voltage:

The peak frequency error is recorded (worst-case).

RESULTS

See the following pages.

9.1. GSM

GPRS 850

Limit		824	849	Delta (Hz)	Frequency Stability (ppm)
Condition		F low @ -13dBm (MHz)	F high @ -13dBm (MHz)		
Temperature	Voltage				
Normal (25C)	Normal	824.0206	848.9749		
Extreme (50C)		824.0206	848.9749	27.4	0.03
Extreme (40C)		824.0206	848.9749	20.2	0.02
Extreme (30C)		824.0206	848.9749	17.7	0.02
Extreme (10C)		824.0206	848.9749	16.2	0.02
Extreme (0C)		824.0206	848.9749	27.0	0.03
Extreme (-10C)		824.0206	848.9749	27.7	0.03
Extreme (-20C)		824.0206	848.9749	22.7	0.03
Extreme (-30C)		824.0206	848.9749	24.0	0.03
25C	10%	824.0206	848.9749	21.1	0.03
	-10%	824.0206	848.9749	18.8	0.02
	End Point	824.0206	848.9749	19.5	0.02

EGPRS 850

Limit		824	849	Delta (Hz)	Frequency Stability (ppm)
Condition		F low @ -13dBm (MHz)	F high @ -13dBm (MHz)		
Temperature	Voltage				
Normal (25C)	Normal	824.0140	848.9790		
Extreme (50C)		824.0140	848.9791	28.3	0.03
Extreme (40C)		824.0140	848.9791	29.8	0.04
Extreme (30C)		824.0140	848.9791	25.0	0.03
Extreme (10C)		824.0140	848.9791	25.3	0.03
Extreme (0C)		824.0140	848.9791	37.8	0.05
Extreme (-10C)		824.0140	848.9791	36.1	0.04
Extreme (-20C)		824.0140	848.9791	31.3	0.04
Extreme (-30C)		824.0140	848.9791	33.9	0.04
25C	10%	824.0140	848.9791	28.7	0.03
	-10%	824.0140	848.9791	30.5	0.04
	End Point	824.0140	848.9791	34.0	0.04

GPRS 1900

Limit		1850	1910	Delta (Hz)	Frequency Stability (ppm)
Condition		F low @ -13dBm (MHz)	F high @ -13dBm (MHz)		
Temperature	Voltage				
Normal (25C)	Normal	1850.0243	1909.9711		
Extreme (50C)		1850.0243	1909.9712	29.2	0.02
Extreme (40C)		1850.0243	1909.9712	26.2	0.01
Extreme (30C)		1850.0243	1909.9712	31.9	0.02
Extreme (10C)		1850.0243	1909.9712	44.2	0.02
Extreme (0C)		1850.0243	1909.9712	42.8	0.02
Extreme (-10C)		1850.0244	1909.9712	47.6	0.03
Extreme (-20C)		1850.0243	1909.9712	36.1	0.02
Extreme (-30C)		1850.0243	1909.9712	39.4	0.02
25C	10%	1850.0243	1909.9712	34.9	0.02
	-10%	1850.0243	1909.9712	31.4	0.02
	End Point	1850.0243	1909.9712	30.9	0.02

EGPRS 1900

Limit		1850	1910	Delta (Hz)	Frequency Stability (ppm)
Condition		F low @ -13dBm (MHz)	F high @ -13dBm (MHz)		
Temperature	Voltage				
Normal (25C)	Normal	1850.0266	1909.9687		
Extreme (50C)		1850.0266	1909.9687	21.6	0.01
Extreme (40C)		1850.0266	1909.9687	30.1	0.02
Extreme (30C)		1850.0266	1909.9687	23.0	0.01
Extreme (10C)		1850.0267	1909.9687	46.6	0.02
Extreme (0C)		1850.0266	1909.9687	40.2	0.02
Extreme (-10C)		1850.0267	1909.9687	44.5	0.02
Extreme (-20C)		1850.0266	1909.9687	35.2	0.02
Extreme (-30C)		1850.0267	1909.9687	47.5	0.03
25C	10%	1850.0266	1909.9687	39.7	0.02
	-10%	1850.0266	1909.9687	40.4	0.02
	End Point	1850.0266	1909.9687	37.1	0.02

9.2. WCDMA

WCDMA REL99 BAND 2

Limit		1850	1910	Delta (Hz)	Frequency Stability (ppm)
Condition		F low @ -13dBm (MHz)	F high @ -13dBm (MHz)		
Temperature	Voltage				
Normal (25C)	Normal	1850.0956	1909.9148		
Extreme (50C)		1850.0956	1909.9149	4.8	0.00
Extreme (40C)		1850.0956	1909.9149	2.5	0.00
Extreme (30C)		1850.0956	1909.9148	1.9	0.00
Extreme (10C)		1850.0956	1909.9148	-4.4	0.00
Extreme (0C)		1850.0956	1909.9148	-7.8	0.00
Extreme (-10C)		1850.0956	1909.9148	-5.9	0.00
Extreme (-20C)		1850.0956	1909.9148	-3.8	0.00
Extreme (-30C)		1850.0956	1909.9148	-2.5	0.00
25C		10%	1850.0956	1909.9148	-3.5
	-10%	1850.0956	1909.9148	-4.2	0.00
	End Point	1850.0956	1909.9148	-2.0	0.00

WCDMA REL99 BAND 4

Limit		1710	1755	Delta (Hz)	Frequency Stability (ppm)
Condition		F low @ -13dBm (MHz)	F high @ -13dBm (MHz)		
Temperature	Voltage				
Normal (25C)	Normal	1710.0950	1754.9096		
Extreme (50C)		1710.0950	1754.9096	-7.8	0.00
Extreme (40C)		1710.0950	1754.9096	-5.2	0.00
Extreme (30C)		1710.0950	1754.9096	-4.1	0.00
Extreme (10C)		1710.0950	1754.9096	-2.8	0.00
Extreme (0C)		1710.0950	1754.9096	-3.5	0.00
Extreme (-10C)		1710.0950	1754.9096	-4.8	0.00
Extreme (-20C)		1710.0950	1754.9096	-6.3	0.00
Extreme (-30C)		1710.0950	1754.9096	-8.2	0.00
25C		10%	1710.0950	1754.9096	-7.8
	-10%	1710.0950	1754.9096	-7.0	0.00
	End Point	1710.0950	1754.9096	-5.7	0.00

WCDMA REL99 BAND 5

Limit		824	849	Delta (Hz)	Frequency Stability (ppm)
Condition		F low @ -13dBm (MHz)	F high @ -13dBm (MHz)		
Temperature	Voltage				
Normal (25C)	Normal	824.0844	848.8942		
Extreme (50C)		824.0844	848.8942	1.5	0.00
Extreme (40C)		824.0844	848.8942	1.6	0.00
Extreme (30C)		824.0844	848.8942	-1.5	0.00
Extreme (10C)		824.0843	848.8942	-4.4	-0.01
Extreme (0C)		824.0843	848.8942	-6.2	-0.01
Extreme (-10C)		824.0843	848.8942	-3.8	0.00
Extreme (-20C)		824.0843	848.8942	-4.2	0.00
Extreme (-30C)		824.0843	848.8942	-4.0	0.00
25C	10%	824.0844	848.8942	-2.9	0.00
	-10%	824.0844	848.8942	-2.2	0.00
	End Point	824.0843	848.8942	-3.0	0.00

9.3. CDMA

CDMA 1xRTT BC0

Limit		824	849	Delta (Hz)	Frequency Stability (ppm)
Condition		F low @ -13dBm (MHz)	F high @ -13dBm (MHz)		
Temperature	Voltage				
Normal (25C)	Normal	824.0086	848.9924		
Extreme (50C)		824.0086	848.9924	6.2	0.01
Extreme (40C)		824.0086	848.9924	5.8	0.01
Extreme (30C)		824.0086	848.9924	6.0	0.01
Extreme (10C)		824.0086	848.9924	5.9	0.01
Extreme (0C)		824.0086	848.9924	4.7	0.01
Extreme (-10C)		824.0086	848.9924	4.6	0.01
Extreme (-20C)		824.0086	848.9924	4.2	0.01
Extreme (-30C)		824.0086	848.9924	4.3	0.01
25C	10%	824.0086	848.9924	7.0	0.01
	-10%	824.0086	848.9924	6.6	0.01
	End Point	824.0086	848.9924	6.9	0.01

CDMA 1x RTT BC1

Limit		1850	1910	Delta (Hz)	Frequency Stability (ppm)
Condition		F low @ -13dBm (MHz)	F high @ -13dBm (MHz)		
Temperature	Voltage				
Normal (25C)	Normal	1850.5569	1909.4469		
Extreme (50C)		1850.5568	1909.4468	-6.7	0.00
Extreme (40C)		1850.5568	1909.4468	-4.5	0.00
Extreme (30C)		1850.5568	1909.4468	-11.7	-0.01
Extreme (10C)		1850.5568	1909.4468	-7.5	0.00
Extreme (0C)		1850.5568	1909.4468	-4.9	0.00
Extreme (-10C)		1850.5568	1909.4468	-6.3	0.00
Extreme (-20C)		1850.5569	1909.4468	-2.6	0.00
Extreme (-30C)		1850.5569	1909.4469	-1.5	0.00
25C	10%	1850.5568	1909.4468	-3.5	0.00
	-10%	1850.5568	1909.4468	-4.1	0.00
	End Point	1850.5568	1909.4468	-3.4	0.00

CDMA 1xRTT BC10

Limit		816.35	823.65	Delta (Hz)	Frequency Stability (ppm)
Condition		F low @ -13dBm (MHz)	F high @ -13dBm (MHz)		
Temperature	Voltage				
Normal (25C)	Normal	816.5507	823.4494		
Extreme (50C)		816.5507	823.4494	8.6	0.01
Extreme (40C)		816.5507	823.4494	7.1	0.01
Extreme (30C)		816.5507	823.4494	5.9	0.01
Extreme (10C)		816.5507	823.4494	7.2	0.01
Extreme (0C)		816.5507	823.4494	4.5	0.01
Extreme (-10C)		816.5507	823.4494	8.1	0.01
Extreme (-20C)		816.5507	823.4494	6.8	0.01
Extreme (-30C)		816.5507	823.4494	6.6	0.01
25C		10%	816.5507	823.4494	4.2
	-10%	816.5507	823.4494	5.0	0.01
	End Point	816.5507	823.4494	4.5	0.01

CDMA 1xRTT BC15

Limit		1710	1755	Delta (Hz)	Frequency Stability (ppm)
Condition		F low @ -13dBm (MHz)	F high @ -13dBm (MHz)		
Temperature	Voltage				
Normal (25C)	Normal	1710.5531	1754.4462		
Extreme (50C)		1710.5531	1754.4462	-6.4	0.00
Extreme (40C)		1710.5531	1754.4462	-5.3	0.00
Extreme (30C)		1710.5531	1754.4462	-1.4	0.00
Extreme (10C)		1710.5531	1754.4462	5.6	0.00
Extreme (0C)		1710.5531	1754.4462	-5.1	0.00
Extreme (-10C)		1710.5532	1754.4462	12.2	0.01
Extreme (-20C)		1710.5532	1754.4462	15.5	0.01
Extreme (-30C)		1710.5532	1754.4462	18.8	0.01
25C		10%	1710.5532	1754.4462	16.5
	-10%	1710.5532	1754.4462	14.9	0.01
	End Point	1710.5532	1754.4462	14.3	0.01

10. RADIATED TEST RESULTS

10.1. RADIATED POWER (ERP & EIRP) (ANTENNA - C)

RULE PART(S)

FCC: §2.1046, §22.913, §24.232, §27.50 and §90.635

LIMITS

§22.913(a) - The ERP of mobile transmitters and auxiliary test transmitters must not exceed 7 Watts.

§24.232(c) - Mobile/portable stations are limited to 2 watts e.i.r.p. peak power and the equipment must employ means to limit the power to the minimum necessary for successful communications.

§27.50(d) (4) Fixed, mobile, and portable (hand-held) stations operating in the 1710-1755 MHz band are limited to 1 watt EIRP. Fixed stations operating in this band are limited to a maximum antenna height of 10 meters above ground. Mobile and portable stations operating in this band must employ a means for limiting power to the minimum necessary for successful communications

§90.635 Limitations on power and antenna height.

(a) The effective radiated power and antenna height for base stations may not exceed 1 kilowatt (30 dBw) and 304 m. (1,000 ft.) above average terrain (AAT), respectively, or the equivalent thereof as determined from the Table. These are maximum values, and applicants will be required to justify power levels and antenna heights requested.

(b) The maximum output power of the transmitter for mobile stations is 100 watts (20 dBw).

Table—Equivalent Power and Antenna Heights for Base Stations in the 851–869 MHz and 935–940 MHz Bands Which Have a Requirement for a 32 km (20 mi) Service Area Radius

Antenna height (ATT) meters (feet)	Effective radiated power (watts) ^{1,2,4}
Above 1,372 (4,500)	65
Above 1,220 (4,000) to 1,372 (4,500)	70
Above 1,067 (3,500) to 1,220 (4,000)	75
Above 915 (3,000) to 1,067 (3,500)	100
Above 763 (2,500) to 915 (3,000)	140
Above 610 (2,000) to 763 (2,500)	200
Above 458 (1,500) to 610 (2,000)	350
Above 305 (1,000) to 458 (1,500)	600
Up to 305 (1,000)	31,000

1 Power is given in terms of effective radiated power (ERP).

2 Applicants in the Los Angeles, CA, area who demonstrate a need to serve both the downtown and fringe areas will be permitted to utilize an ERP of 1 kw at the following mountaintop sites: Santiago Park, Sierra Peak, Mount Lukens, and Mount Wilson.

3 Stations with antennas below 305 m (1,000 ft) (AAT) will be restricted to a maximum power of 1 kw (ERP).

In addition, when the transmitter power is measured in terms of average value, the peak-to-average ratio of the power shall not exceed 13 dB.

TEST PROCEDURE

ANSI / TIA / EIA 603-D Clause 2.2.17

KDB 971168 D01 RF Power output using broadband peak and average power meter method

MODES TESTED

- GPRS/EGPRS
- UMTS, REL 99 and HSDPA
- CDMA2000, 1xRTT and EVDO, Rev A

RESULTS

10.1.1. GSM

Part 22 / RSS 132 850MHz Band

Band	Mode	Channel	f (MHz)	ERP (Average)	
				dBm	mW
CELL	GPRS	128	824.2	30.77	1193.99
		190	836.6	31.41	1383.57
		251	848.8	31.10	1288.25
	EGPRS	128	824.2	24.73	297.17
		190	836.6	24.69	294.44
		251	848.8	24.58	287.08

Part 24 / RSS 133 1900MHz Band

Band	Mode	Channel	f (MHz)	EIRP (Average)	
				dBm	mW
PCS	GPRS	512	1850.2	32.24	1674.94
		661	1880.0	32.32	1706.08
		810	1909.8	32.11	1625.55
	EGPRS	512	1850.2	29.08	809.10
		661	1880.0	28.80	758.58
		810	1909.8	28.83	763.84

10.1.2. CDMA2000

Part 90 800MHz Band

Band	Mode	Channel	f (MHz)	ERP (Average)	
				dBm	mW
CELL	BC10, 1xRTT	450	817.3	23.28	212.81
		560	820.0	23.15	206.54
		670	822.8	23.72	235.50
	BC10, EVDO A	450	817.3	23.47	222.33
		560	820.0	23.43	220.29
		670	822.8	23.75	237.14

Part 22 / RSS 132 850MHz Band

Band	Mode	Channel	f (MHz)	ERP (Average)	
				dBm	mW
CELL	BC 0, 1xRTT	1013	824.7	24.20	263.03
		384	836.5	24.66	292.42
		777	848.3	24.13	258.82
	BC 0, EVDO Rev A	1013	824.7	24.27	267.30
		384	836.5	24.69	294.44
		777	848.3	24.40	275.42

Part 24 / RSS 133 1900MHz Band

Band	Mode	Channel	f (MHz)	EIRP (Average)	
				dBm	mW
PCS	BC1, 1xRTT	25	1851.3	27.66	583.45
		600	1880.0	26.96	496.59
		1175	1908.8	27.06	508.16
	BC1, EVDO REV A	25	1851.3	27.69	587.49
		600	1880.0	27.27	533.33
		1175	1908.8	27.11	514.04

Part 27 / RSS 139 1700MHz Band

Band	Mode	Channel	f (MHz)	EIRP (Average)	
				dBm	mW
AWS	BC15, 1xRTT	25	1711.3	26.84	483.06
		450	1732.5	26.67	464.52
		875	1753.8	26.31	427.56
	BC15, EVDO, REV A	25	1711.3	26.86	485.29
		450	1732.5	26.72	469.89
		875	1753.8	26.35	431.52

10.1.3. UMTS

Part 22 / RSS 132 850MHz Band

Band	Mode	Channel	f (MHz)	ERP (Average)	
				dBm	mW
CELL	UMTS,REL 99	4132	826.4	23.12	205.12
		4183	836.6	23.29	213.30
		4233	846.6	23.68	233.35
	UMTS, HSDPA	4132	826.4	22.21	166.34
		4183	836.6	22.39	173.38
		4233	846.6	22.74	187.93

Part 24 / RSS 133 1900MHz Band

Band	Mode	Channel	f (MHz)	EIRP (Average)	
				dBm	mW
PCS	UMTS,REL 99	9662	1852.4	27.20	524.81
		9800	1880.0	27.21	526.02
		9938	1907.6	27.06	508.16
	UMTS, HSDPA	9662	1852.4	26.26	422.67
		9800	1880.0	26.20	416.87
		9938	1907.6	26.11	408.32

Part 27 / RSS 139 1700MHz Band

Band	Mode	Channel	f (MHz)	EIRP (Average)	
				dBm	mW
PCS	UMTS,REL 99	1537	1712.4	25.72	373.25
		1638	1732.6	25.28	337.29
		1738	1752.5	25.21	331.89
	UMTS, HSDPA	1537	1712.4	24.87	306.90
		1638	1732.6	24.38	274.16
		1738	1752.5	24.31	269.77

10.1.4. GSM

GPRS, 850MHz BAND 5

High Frequency Substitution Measurement UL Fremont Radiated Chamber D										
Company:										
Project #: 15U22428										
Date: 12/02/15										
Test Engineer: F. Guamero										
Configuration: EUT Only										
Mode: GSM 850MHz										
Test Equipment:										
Receiving: Sunol T407, and Chamber D Cable										
Substitution: Dipole S/N: 00022117, 8ft SMA Cable										
f MHz	SG reading (dBm)	Ant. Pol. (H/V)	Cable Loss (dB)	Antenna Gain (dBd)	ERP (dBm)	EIRP (dBm)	ERP Limit (dBm)	EIRP Limit (dBm)	Margin (dB)	Notes
Low Ch										
824.20	24.1	V	0.6	0.0	23.46	25.61	38.45	40.60	-15.0	
824.20	31.4	H	0.6	0.0	30.77	32.92	38.45	40.60	-7.7	
Mid Ch										
836.60	24.6	V	0.6	0.0	23.99	26.14	38.45	40.60	-14.5	
836.60	32.0	H	0.6	0.0	31.41	33.56	38.45	40.60	-7.0	
High Ch										
848.80	23.8	V	0.6	0.0	23.18	25.33	38.45	40.60	-15.3	
848.80	31.7	H	0.6	0.0	31.10	33.25	38.45	40.60	-7.4	
Rev. 11.24.15										

EGPRS, 850MHz BAND 5

High Frequency Substitution Measurement UL Fremont Radiated Chamber D										
Company:										
Project #: 15U22428										
Date: 12/02/15										
Test Engineer: F. Guarnero										
Configuration: EUT Only										
Mode: EDGE 850MHz										
Test Equipment:										
Receiving: Sunol T407, and Chamber D Cable										
Substitution: Dipole S/N: 00022117, 8ft SMA Cable										
f MHz	SG reading (dBm)	Ant. Pol. (H/V)	Cable Loss (dB)	Antenna Gain (dBd)	ERP (dBm)	EIRP (dBm)	ERP Limit (dBm)	EIRP Limit (dBm)	Margin (dB)	Notes
Low Ch										
824.20	18.3	V	0.6	0.0	17.67	19.82	38.45	40.60	-20.8	
824.20	25.4	H	0.6	0.0	24.73	26.88	38.45	40.60	-13.7	
Mid Ch										
836.60	18.3	V	0.6	0.0	17.67	19.82	38.45	40.60	-20.8	
836.60	25.3	H	0.6	0.0	24.69	26.84	38.45	40.60	-13.8	
High Ch										
848.80	17.4	V	0.6	0.0	16.77	18.92	38.45	40.60	-21.7	
848.80	25.2	H	0.6	0.0	24.58	26.73	38.45	40.60	-13.9	
Rev. 11.24.15										

GPRS, 1900MHz BAND 2

High Frequency Substitution Measurement UL Fremont Radiated Chamber D									
Company:									
Project #: 15U22428									
Date: 12/02/15									
Test Engineer: F. Guarnero									
Configuration: EUT Only									
Mode: GSM 1900MHz									
Test Equipment:									
Receiving: Horn T344 and Chamber D SMA Cables									
Substitution: Horn T59 Substitution, and 8ft SMA Cable									
f GHz	SG reading (dBm)	Ant. Pol. (H/V)	Cable Loss (dB)	Antenna Gain (dBi)	EIRP (dBm)	Limit (dBm)	Margin (dB)	Notes	
Low Ch									
1.851	25.2	V	0.98	8.05	32.24	33.0	-0.8		
1.851	23.0	H	0.98	8.05	30.05	33.0	-3.0		
Mid Ch									
1.880	25.3	V	0.98	8.03	32.32	33.0	-0.7		
1.880	22.9	H	0.98	8.03	29.99	33.0	-3.0		
High Ch									
1.910	25.0	V	0.98	8.05	32.11	33.0	-0.9		
1.910	23.8	H	0.98	8.05	30.89	33.0	-2.1		
Rev. 11.20.15									

EGPRS, 1900MHz BAND 2

High Frequency Substitution Measurement UL Fremont Radiated Chamber D								
Company:								
Project #: 15U22428								
Date: 12/02/15								
Test Engineer: F. Guarnero								
Configuration: EUT Only								
Mode: EDGE 1900MHz								
Test Equipment:								
Receiving: Horn T344 and Chamber D SMA Cables								
Substitution: Horn T59 Substitution, and 8ft SMA Cable								
f GHz	SG reading (dBm)	Ant. Pol. (H/V)	Cable Loss (dB)	Antenna Gain (dBi)	EIRP (dBm)	Limit (dBm)	Margin (dB)	Notes
Low Ch								
1.851	22.0	V	0.98	8.05	29.08	33.0	-3.9	
1.851	19.5	H	0.98	8.05	26.62	33.0	-6.4	
Mid Ch								
1.880	21.8	V	0.98	8.03	28.80	33.0	-4.2	
1.880	19.5	H	0.98	8.03	26.58	33.0	-6.4	
High Ch								
1.910	21.8	V	0.98	8.05	28.83	33.0	-4.2	
1.910	21.0	H	0.98	8.05	28.05	33.0	-4.9	
Rev. 11.20.15								

10.1.5. CDMA2000

CDMA2000 1xRTT, 800MHz BC10

High Frequency Substitution Measurement UL Fremont Radiated Chamber D								
Company:								
Project #: 15U22428								
Date: 12/03/15								
Test Engineer: F. Guarnero								
Configuration: EUT Only								
Mode: CDMA 1XRTT 800MHz								
Test Equipment:								
Receiving: Sunol T407, and Chamber D Cable								
Substitution: Dipole S/N: 00022117, 8ft SMA Cable								
F MHz	SG reading (dBm)	Ant. Pol. (H/V)	Cable Loss (dB)	Antenna Gain (dBd)	ERP (dBm)	Limit (dBm)	Margin (dB)	Notes
Low Ch								
817.25	16.11	V	0.6	0.0	15.50	50.00	-34.5	
817.25	23.90	H	0.6	0.0	23.28	50.00	-26.7	
Mid Ch								
820.00	15.93	V	0.6	0.0	15.31	50.00	-34.7	
820.00	23.77	H	0.6	0.0	23.15	50.00	-26.8	
High Ch								
822.75	16.06	V	0.6	0.0	15.44	50.00	-34.6	
822.75	24.34	H	0.6	0.0	23.72	50.00	-26.3	
Rev. 11.24.15								

EVDO-Rev A, 800MHz BC10

High Frequency Substitution Measurement UL Fremont Radiated Chamber F								
Company:								
Project #: 15U22428								
Date: 01/05/16								
Test Engineer: M. Hua								
Configuration: EUT Only								
Mode: CDMA Rev A 800MHz								
Test Equipment:								
Receiving: Sunol T122, and Chamber F Cable								
Substitution: Dipole S/N: 00022117, 8ft SMA Cable								
F MHz	SG reading (dBm)	Ant. Pol. (H/V)	Cable Loss (dB)	Antenna Gain (dBd)	ERP (dBm)	Limit (dBm)	Margin (dB)	Notes
Low Ch								
817.25	18.62	V	0.6	0.0	18.00	50.00	-32.0	
817.25	24.09	H	0.6	0.0	23.47	50.00	-26.5	
Mid Ch								
820.00	18.63	V	0.6	0.0	18.01	50.00	-32.0	
820.00	24.05	H	0.6	0.0	23.43	50.00	-26.6	
High Ch								
822.75	18.46	V	0.6	0.0	17.84	50.00	-32.2	
822.75	24.37	H	0.6	0.0	23.75	50.00	-26.2	
Rev. 01.05.16								

CDMA2000 1xRTT, 850MHz BC0

High Frequency Substitution Measurement UL Fremont Radiated Chamber D										
Company:										
Project #: 15U22428										
Date: 12/03/15										
Test Engineer: F. Guarnero										
Configuration: EUT Only										
Mode: CDMA 1XRTT 850MHz										
Test Equipment:										
Receiving: Sunol T407, and Chamber D Cable										
Substitution: Dipole S/N: 00022117, 8ft SMA Cable										
f MHz	SG reading (dBm)	Ant. Pol. (H/V)	Cable Loss (dB)	Antenna Gain (dBd)	ERP (dBm)	EIRP (dBm)	ERP Limit (dBm)	EIRP Limit (dBm)	Margin (dB)	Notes
Low Ch										
824.70	17.4	V	0.6	0.0	16.78	18.93	38.45	40.60	-21.7	
824.70	24.8	H	0.6	0.0	24.20	26.35	38.45	40.60	-14.2	
Mid Ch										
836.52	17.0	V	0.6	0.0	16.37	18.52	38.45	40.60	-22.1	
836.52	25.3	H	0.6	0.0	24.66	26.81	38.45	40.60	-13.8	
High Ch										
848.31	16.1	V	0.6	0.0	15.47	17.62	38.45	40.60	-23.0	
848.31	24.7	H	0.6	0.0	24.13	26.28	38.45	40.60	-14.3	
Rev. 11.24.15										

EVDO-Rev A, 850MHz BC0

High Frequency Substitution Measurement UL Fremont Radiated Chamber F										
Company:										
Project #: 15U22428										
Date: 01/05/16										
Test Engineer: M. Hua										
Configuration: EUT Only										
Mode: CDMA Rev A 850MHz										
Test Equipment:										
Receiving: Sunol T122, and Chamber F Cable										
Substitution: Dipole S/N: 00022117, 8ft SMA Cable										
f MHz	SG reading (dBm)	Ant. Pol. (H/V)	Cable Loss (dB)	Antenna Gain (dBd)	ERP (dBm)	EIRP (dBm)	ERP Limit (dBm)	EIRP Limit (dBm)	Margin (dB)	Notes
Low Ch										
824.70	18.6	V	0.6	0.0	18.03	20.18	38.45	40.60	-20.4	
824.70	24.9	H	0.6	0.0	24.27	26.42	38.45	40.60	-14.2	
Mid Ch										
836.52	18.3	V	0.6	0.0	17.71	19.86	38.45	40.60	-20.7	
836.52	25.3	H	0.6	0.0	24.69	26.84	38.45	40.60	-13.8	
High Ch										
848.31	17.4	V	0.6	0.0	16.76	18.91	38.45	40.60	-21.7	
848.31	25.0	H	0.6	0.0	24.40	26.55	38.45	40.60	-14.0	
Rev. 01.05.16										

CDMA2000 1xRTT, 1900MHz BC1

High Frequency Substitution Measurement UL Fremont Radiated Chamber D								
Company:								
Project #: 15U22428								
Date: 12/03/15								
Test Engineer: F. Guamero								
Configuration: EUT Only								
Mode: CDMA 1XRTT 1900MHz								
Test Equipment:								
Receiving: Horn T344 and Chamber D SMA Cables								
Substitution: Horn T59 Substitution, and 8ft SMA Cable								
f GHz	SG reading (dBm)	Ant. Pol. (H/V)	Cable Loss (dB)	Antenna Gain (dBi)	EIRP (dBm)	Limit (dBm)	Margin (dB)	Notes
Low Ch								
1.851	20.6	V	0.98	8.05	27.66	33.0	-5.3	
1.851	18.0	H	0.98	8.05	25.07	33.0	-7.9	
Mid Ch								
1.880	19.9	V	0.98	8.03	26.96	33.0	-6.0	
1.880	18.5	H	0.98	8.03	25.56	33.0	-7.4	
High Ch								
1.909	20.0	V	0.98	8.05	27.06	33.0	-5.9	
1.909	18.1	H	0.98	8.05	25.17	33.0	-7.8	
Rev. 11.20.15								

EVDO-Rev A, 1900MHz BC1

High Frequency Substitution Measurement UL Fremont Radiated Chamber F								
Company:								
Project #: 15U22428								
Date: 01/05/16								
Test Engineer: M. Hua								
Configuration: EUT Only								
Mode: CDMA Rev A 1900MHz								
Test Equipment:								
Receiving: Horn T120 and Chamber F SMA Cables								
Substitution: Horn T59 Substitution, and 8ft SMA Cable								
f GHz	SG reading (dBm)	Ant. Pol. (H/V)	Cable Loss (dB)	Antenna Gain (dBi)	EIRP (dBm)	Limit (dBm)	Margin (dB)	Notes
Low Ch								
1.851	20.6	V	0.98	8.05	27.69	33.0	-5.3	
1.851	17.4	H	0.98	8.05	24.44	33.0	-8.6	
Mid Ch								
1.880	20.2	V	0.98	8.03	27.27	33.0	-5.7	
1.880	15.9	H	0.98	8.03	22.92	33.0	-10.1	
High Ch								
1.909	20.0	V	0.98	8.05	27.11	33.0	-5.9	
1.909	16.6	H	0.98	8.05	23.68	33.0	-9.3	
Rev. 01.05.16								

CDMA2000 1xRTT, 1700MHz BC15

High Frequency Substitution Measurement UL Fremont Radiated Chamber D								
Company:								
Project #: 15U22428								
Date: 12/03/15								
Test Engineer: F. Guarero								
Configuration: EUT Only								
Mode: CDMA 1XRTT 1700MHz								
Test Equipment:								
Receiving: Horn T344 and Chamber D SMA Cables								
Substitution: Horn T59 Substitution, and 8ft SMA Cable								
f GHz	SG reading (dBm)	Ant. Pol. (H/V)	Cable Loss (dB)	Antenna Gain (dBi)	EIRP (dBm)	Limit (dBm)	Margin (dB)	Notes
Low Ch								
1.711	19.5	V	0.95	8.27	26.84	30.0	-3.2	
1.711	16.8	H	0.95	8.27	24.14	30.0	-5.9	
Mid Ch								
1.733	19.4	V	0.95	8.23	26.67	30.0	-3.3	
1.733	16.4	H	0.95	8.23	23.65	30.0	-6.3	
High Ch								
1.754	19.1	V	0.95	8.18	26.31	30.0	-3.7	
1.754	15.7	H	0.95	8.18	22.97	30.0	-7.0	
Rev. 05.21.15								

EVDO-Rev A, 1700MHz BC15

High Frequency Substitution Measurement UL Fremont Radiated Chamber F								
Company:								
Project #: 15U22428								
Date: 01/05/16								
Test Engineer: M. Hua								
Configuration: EUT Only								
Mode: CDMA Rev A 1700MHz								
Test Equipment:								
Receiving: Horn T120 and Chamber F SMA Cables								
Substitution: Horn T59 Substitution, and 8ft SMA Cable								
f GHz	SG reading (dBm)	Ant. Pol. (H/V)	Cable Loss (dB)	Antenna Gain (dBi)	EIRP (dBm)	Limit (dBm)	Margin (dB)	Notes
Low Ch								
1.711	19.5	V	0.95	8.27	26.86	30.0	-3.1	
1.711	16.1	H	0.95	8.27	23.43	30.0	-6.6	
Mid Ch								
1.733	19.4	V	0.95	8.23	26.72	30.0	-3.3	
1.733	15.8	H	0.95	8.23	23.06	30.0	-6.9	
High Ch								
1.754	19.1	V	0.95	8.18	26.35	30.0	-3.6	
1.754	14.8	H	0.95	8.18	21.99	30.0	-8.0	
Rev. 01.05.16								

10.1.6. UMTS

UMTS REL 99, 850MHz BAND 5

High Frequency Substitution Measurement UL Fremont Radiated Chamber D										
Company:										
Project #: 15U22428										
Date: 12/02/15										
Test Engineer: F. Guarero										
Configuration: EUT Only										
Mode: WCDMA Rel 99 850MHz										
Test Equipment:										
Receiving: Sunol T407, and Chamber D Cable										
Substitution: Dipole S/N: 00022117, 8ft SMA Cable										
f MHz	SG reading (dBm)	Ant. Pol. (H/V)	Cable Loss (dB)	Antenna Gain (dBd)	ERP (dBm)	EIRP (dBm)	ERP Limit (dBm)	EIRP Limit (dBm)	Margin (dB)	Notes
Low Ch										
826.40	16.5	V	0.6	0.0	15.88	18.03	38.45	40.60	-22.6	
826.40	23.7	H	0.6	0.0	23.12	25.27	38.45	40.60	-15.3	
Mid Ch										
836.00	16.2	V	0.6	0.0	15.56	17.71	38.45	40.60	-22.9	
836.00	23.9	H	0.6	0.0	23.29	25.44	38.45	40.60	-15.2	
High Ch										
846.60	15.4	V	0.6	0.0	14.78	16.93	38.45	40.60	-23.7	
846.60	24.3	H	0.6	0.0	23.68	25.83	38.45	40.60	-14.8	
Rev. 11.24.15										

UMTS HSDPA, 850MHz BAND 5

High Frequency Substitution Measurement UL Fremont Radiated Chamber D										
Company:										
Project #: 15U22428										
Date: 12/02/15										
Test Engineer: Ali P										
Configuration: EUT Only										
Mode: WCDMA HSDPA 850MHz										
Test Equipment:										
Receiving: Sunol T407, and Chamber D Cable										
Substitution: Dipole S/N: 00022117, 8ft SMA Cable										
f MHz	SG reading (dBm)	Ant. Pol. (H/V)	Cable Loss (dB)	Antenna Gain (dBd)	ERP (dBm)	EIRP (dBm)	ERP Limit (dBm)	EIRP Limit (dBm)	Margin (dB)	Notes
Low Ch										
826.40	15.4	V	0.6	0.0	14.73	16.88	38.45	40.60	-23.7	
826.40	22.8	H	0.6	0.0	22.21	24.36	38.45	40.60	-16.2	
Mid Ch										
836.00	15.3	V	0.6	0.0	14.71	16.86	38.45	40.60	-23.7	
836.00	23.0	H	0.6	0.0	22.39	24.54	38.45	40.60	-16.1	
High Ch										
846.60	14.1	V	0.6	0.0	13.46	15.61	38.45	40.60	-25.0	
846.60	23.4	H	0.6	0.0	22.74	24.89	38.45	40.60	-15.7	
Rev. 11.24.15										

UMTS REL 99, 1900MHZ BAND 2

High Frequency Substitution Measurement UL Fremont Radiated Chamber D								
Company:								
Project #: 15U22428								
Date: 12/02/15								
Test Engineer: Ali.P								
Configuration: EUT Only								
Mode: WCDMA Rel 99 1900MHz								
Test Equipment:								
Receiving: Horn T344 and Chamber D SMA Cables								
Substitution: Horn T59 Substitution, and 8ft SMA Cable								
f GHz	SG reading (dBm)	Ant. Pol. (H/V)	Cable Loss (dB)	Antenna Gain (dBi)	EIRP (dBm)	Limit (dBm)	Margin (dB)	Notes
Low Ch								
1.852	20.1	V	0.98	8.05	27.20	33.0	-5.8	
1.852	17.8	H	0.98	8.05	24.86	33.0	-8.1	
Mid Ch								
1.880	20.2	V	0.98	8.03	27.21	33.0	-5.8	
1.880	17.2	H	0.98	8.03	24.22	33.0	-8.8	
High Ch								
1.908	20.0	V	0.98	8.04	27.06	33.0	-5.9	
1.908	17.9	H	0.98	8.04	24.92	33.0	-8.1	
Rev. 11.20.15								

UMTS HSDPA, 1900MHz BAND 2

High Frequency Substitution Measurement UL Fremont Radiated Chamber D								
Company:								
Project #: 15U21279								
Date: 12/02/15								
Test Engineer: Ali.P								
Configuration: EUT Only								
Mode: WCDMA HSDPA 1900MHz								
Test Equipment:								
Receiving: Horn T344 and Chamber D SMA Cables								
Substitution: Horn T59 Substitution, and 8ft SMA Cable								
f GHz	SG reading (dBm)	Ant. Pol. (H/V)	Cable Loss (dB)	Antenna Gain (dBi)	EIRP (dBm)	Limit (dBm)	Margin (dB)	Notes
Low Ch								
1.852	19.2	V	0.98	8.05	26.26	33.0	-6.7	
1.852	17.0	H	0.98	8.05	24.06	33.0	-8.9	
Mid Ch								
1.880	19.2	V	0.98	8.03	26.20	33.0	-6.8	
1.880	16.6	H	0.98	8.03	23.61	33.0	-9.4	
High Ch								
1.908	19.1	V	0.98	8.04	26.11	33.0	-6.9	
1.908	17.7	H	0.98	8.04	24.76	33.0	-8.2	
Rev. 11.20.15								

UMTS REL 99, 1700MHz BAND 4

High Frequency Substitution Measurement UL Fremont Radiated Chamber D								
Company:								
Project #: 15U22428								
Date: 12/02/15								
Test Engineer: Ali.P								
Configuration: EUT Only								
Mode: WCDMA Rel 99 1700MHz								
Test Equipment:								
Receiving: Horn T344 and Chamber D SMA Cables								
Substitution: Horn T59 Substitution, and 8ft SMA Cable								
f GHz	SG reading (dBm)	Ant. Pol. (H/V)	Cable Loss (dB)	Antenna Gain (dBi)	EIRP (dBm)	Limit (dBm)	Margin (dB)	Notes
Low Ch								
1.712	18.4	V	0.95	8.27	25.72	30.0	-4.3	
1.712	15.4	H	0.95	8.27	22.71	30.0	-7.3	
Mid Ch								
1.733	18.0	V	0.95	8.23	25.28	30.0	-4.7	
1.733	15.8	H	0.95	8.23	23.06	30.0	-6.9	
High Ch								
1.753	18.0	V	0.95	8.18	25.21	30.0	-4.8	
1.753	15.6	H	0.95	8.18	22.79	30.0	-7.2	
Rev. 11.20.15								

UMTS HSDPA, 1700MHz BAND 4

High Frequency Substitution Measurement UL Fremont Radiated Chamber D								
Company:								
Project #: 15U22428								
Date: 12/02/15								
Test Engineer: Ali.P								
Configuration: EUT Only								
Mode: WCDMA HSDPA 1700MHz								
Test Equipment:								
Receiving: Horn T344 and Chamber D SMA Cables								
Substitution: Horn T59 Substitution, and 8ft SMA Cable								
f GHz	SG reading (dBm)	Ant. Pol. (H/V)	Cable Loss (dB)	Antenna Gain (dBi)	EIRP (dBm)	Limit (dBm)	Margin (dB)	Notes
Low Ch								
1.712	17.5	V	0.95	8.27	24.87	30.0	-5.1	
1.712	15.2	H	0.95	8.27	22.54	30.0	-7.5	
Mid Ch								
1.733	17.1	V	0.95	8.23	24.38	30.0	-5.6	
1.733	15.3	H	0.95	8.23	22.55	30.0	-7.4	
High Ch								
1.753	17.1	V	0.95	8.18	24.31	30.0	-5.7	
1.753	15.5	H	0.95	8.18	22.69	30.0	-7.3	
Rev. 11.20.15								

10.2. RADIATED POWER (ERP & EIRP) (ANTENNA - D)

10.2.1. GSM

Part 22 / RSS 132 850MHz Band

Band	Mode	Channel	f (MHz)	ERP (Average)	
				dBm	mW
CELL	GPRS	128	824.2	29.25	841.40
		190	836.6	29.65	922.57
		251	848.8	29.36	862.98
	EGPRS	128	824.2	24.37	273.53
		190	836.6	24.04	253.51
		251	848.8	24.54	284.45

Part 24 / RSS 133 1900MHz Band

Band	Mode	Channel	f (MHz)	EIRP (Average)	
				dBm	mW
PCS	GPRS	512	1850.2	27.89	615.18
		661	1880.0	28.02	633.87
		810	1909.8	27.83	606.74
	EGPRS	512	1850.2	26.83	481.95
		661	1880.0	26.85	484.17
		810	1909.8	26.71	468.81

10.2.2. CDMA2000

Part 90 800MHz Band

Band	Mode	Channel	f (MHz)	ERP (Average)	
				dBm	mW
CELL	BC10, 1xRTT	450	817.3	21.60	144.54
		560	820.0	21.58	143.88
		670	822.8	21.09	128.53
	BC10, EVDO A	450	817.3	21.77	150.31
		560	820.0	21.69	147.57
		670	822.8	21.15	130.32

Part 22 / RSS 132 850MHz Band

Band	Mode	Channel	f (MHz)	ERP (Average)	
				dBm	mW
CELL	BC 0, 1xRTT	1013	824.7	21.11	129.12
		384	836.5	21.19	131.52
		777	848.3	21.64	145.88
	BC 0, EVDO Rev A	1013	824.7	21.22	132.43
		384	836.5	21.39	137.72
		777	848.3	21.70	147.91

Part 24 / RSS 133 1900MHz Band

Band	Mode	Channel	f (MHz)	EIRP (Average)	
				dBm	mW
PCS	BC1, 1xRTT	25	1851.3	23.45	221.31
		600	1880.0	22.76	188.80
		1175	1908.8	22.67	184.93
	BC1, EVDO REV A	25	1851.3	23.49	223.36
		600	1880.0	22.82	191.43
		1175	1908.8	22.73	187.50

Part 27 / RSS 139 1700MHz Band

Band	Mode	Channel	f (MHz)	EIRP (Average)	
				dBm	mW
AWS	BC15, 1xRTT	25	1711.3	20.78	119.67
		450	1732.5	20.45	110.92
		875	1753.8	21.05	127.35
	BC15, EVDO, REV A	25	1711.3	20.95	124.45
		450	1732.5	20.62	115.35
		875	1753.8	21.20	131.83

10.2.3. UMTS

Part 22 / RSS 132 850MHz Band

Band	Mode	Channel	f (MHz)	ERP (Average)	
				dBm	mW
CELL	UMTS,REL 99	4132	826.4	21.47	140.28
		4183	836.6	21.54	142.56
		4233	846.6	21.20	131.83
	UMTS, HSDPA	4132	826.4	20.51	112.46
		4183	836.6	20.64	115.88
		4233	846.6	20.11	102.57

Part 24 / RSS 133 1900MHz Band

Band	Mode	Channel	f (MHz)	EIRP (Average)	
				dBm	mW
PCS	UMTS,REL 99	9662	1852.4	22.48	177.01
		9800	1880.0	22.10	162.18
		9938	1907.6	22.36	172.19
	UMTS, HSDPA	9662	1852.4	21.56	143.22
		9800	1880.0	21.30	134.90
		9938	1907.6	21.41	138.36

Part 27 / RSS 139 1700MHz Band

Band	Mode	Channel	f (MHz)	EIRP (Average)	
				dBm	mW
PCS	UMTS,REL 99	1537	1712.4	22.07	161.06
		1638	1732.6	21.87	153.82
		1738	1752.5	22.12	162.93
	UMTS, HSDPA	1537	1712.4	21.12	129.42
		1638	1732.6	20.93	123.88
		1738	1752.5	21.23	132.74

10.2.4. GSM

GPRS, 850MHz BAND 5

High Frequency Substitution Measurement UL Fremont Radiated Chamber D										
Company:										
Project #: 15U21279										
Date: 12/02/15										
Test Engineer: F. Guamero										
Configuration: EUT Only										
Mode: GSM 850MHz										
Test Equipment:										
Receiving: Sunol T407, and Chamber D Cable										
Substitution: Dipole S/N: 00022117, 8ft SMA Cable										
f MHz	SG reading (dBm)	Ant. Pol. (H/V)	Cable Loss (dB)	Antenna Gain (dBd)	ERP (dBm)	EIRP (dBm)	ERP Limit (dBm)	EIRP Limit (dBm)	Margin (dB)	Notes
Low Ch										
824.20	23.5	V	0.6	0.0	22.89	25.04	38.45	40.60	-15.6	
824.20	29.9	H	0.6	0.0	29.25	31.40	38.45	40.60	-9.2	
Mid Ch										
836.60	23.6	V	0.6	0.0	23.00	25.15	38.45	40.60	-15.5	
836.60	30.3	H	0.6	0.0	29.65	31.80	38.45	40.60	-8.8	
High Ch										
848.80	22.7	V	0.6	0.0	22.07	24.22	38.45	40.60	-16.4	
848.80	30.0	H	0.6	0.0	29.36	31.51	38.45	40.60	-9.1	
Rev. 11.24.15										

EGPRS, 850MHz BAND 5

High Frequency Substitution Measurement UL Fremont Radiated Chamber D										
Company:										
Project #: 15U21279										
Date: 12/02/15										
Test Engineer: F. Guarnero										
Configuration: EUT Only										
Mode: EDGE 850MHz										
Test Equipment:										
Receiving: Sunoi T407, and Chamber D Cable										
Substitution: Dipole S/N: 00022117, 8ft SMA Cable										
f MHz	SG reading (dBm)	Ant. Pol. (H/V)	Cable Loss (dB)	Antenna Gain (dBd)	ERP (dBm)	EIRP (dBm)	ERP Limit (dBm)	EIRP Limit (dBm)	Margin (dB)	Notes
Low Ch										
824.20	17.1	V	0.6	0.0	16.52	18.67	38.45	40.60	-21.9	
824.20	25.0	H	0.6	0.0	24.37	26.52	38.45	40.60	-14.1	
Mid Ch										
836.60	16.9	V	0.6	0.0	16.30	18.45	38.45	40.60	-22.2	
836.60	24.7	H	0.6	0.0	24.04	26.19	38.45	40.60	-14.4	
High Ch										
848.80	16.4	V	0.6	0.0	15.74	17.89	38.45	40.60	-22.7	
848.80	25.2	H	0.6	0.0	24.54	26.69	38.45	40.60	-13.9	
Rev. 11.24.15										

GPRS, 1900MHz BAND 2

High Frequency Substitution Measurement UL Fremont Radiated Chamber F								
Company:								
Project #: 15U22428								
Date: 12.28.2015								
Test Engineer: N.Garcia								
Configuration: EUT Only								
Mode: GSM 1900MHz								
Test Equipment:								
Receiving: Horn T120 and Chamber F SMA Cables								
Substitution: Horn T59 Substitution, and 8ft SMA Cable								
f GHz	SG reading (dBm)	Ant. Pol. (H/V)	Cable Loss (dB)	Antenna Gain (dBi)	EIRP (dBm)	Limit (dBm)	Margin (dB)	Notes
Low Ch								
1.851	20.8	V	0.98	8.05	27.89	33.0	-5.1	
1.851	18.9	H	0.98	8.05	25.93	33.0	-7.1	
Mid Ch								
1.880	21.0	V	0.98	8.03	28.02	33.0	-5.0	
1.880	19.0	H	0.98	8.03	26.07	33.0	-6.9	
High Ch								
1.910	20.8	V	0.98	8.05	27.83	33.0	-5.2	
1.910	19.3	H	0.98	8.05	26.37	33.0	-6.6	
Rev. 01.05.16								

EGPRS, 1900MHz BAND 2

High Frequency Substitution Measurement UL Fremont Radiated Chamber F								
Company:								
Project #: 15U22428								
Date: 12.28.2015								
Test Engineer: N.Garcia								
Configuration: EUT Only								
Mode: EDGE 1900MHz								
Test Equipment:								
Receiving: Horn T120 and Chamber F SMA Cables								
Substitution: Horn T59 Substitution, and 8ft SMA Cable								
f GHz	SG reading (dBm)	Ant. Pol. (H/V)	Cable Loss (dB)	Antenna Gain (dBi)	EIRP (dBm)	Limit (dBm)	Margin (dB)	Notes
Low Ch								
1.851	19.8	V	0.98	8.05	26.83	33.0	-6.2	
1.851	18.2	H	0.98	8.05	25.24	33.0	-7.8	
Mid Ch								
1.880	19.8	V	0.98	8.03	26.85	33.0	-6.1	
1.880	18.5	H	0.98	8.03	25.54	33.0	-7.5	
High Ch								
1.910	19.6	V	0.98	8.05	26.71	33.0	-6.3	
1.910	18.8	H	0.98	8.05	25.87	33.0	-7.1	
Rev. 01.05.16								

10.2.5. CDMA2000

CDMA2000 1xRTT, 800MHz BC10

High Frequency Substitution Measurement UL Fremont Radiated Chamber D								
Company:								
Project #: 15U21279								
Date: 12/03/15								
Test Engineer: M. Hua								
Configuration: EUT Only								
Mode: CDMA 1XRTT 800MHz								
Test Equipment:								
Receiving: Sunol T407, and Chamber D Cable								
Substitution: Dipole S/N: 00022117, 8ft SMA Cable								
F MHz	SG reading (dBm)	Ant. Pol. (H/V)	Cable Loss (dB)	Antenna Gain (dBd)	ERP (dBm)	Limit (dBm)	Margin (dB)	Notes
Low Ch								
817.50	15.52	V	0.6	0.0	14.90	50.00	-35.1	
817.50	22.41	H	0.6	0.0	21.79	50.00	-28.2	
Mid Ch								
820.00	15.19	V	0.6	0.0	14.57	50.00	-35.4	
820.00	22.20	H	0.6	0.0	21.58	50.00	-28.4	
High Ch								
822.75	13.92	V	0.6	0.0	13.30	50.00	-36.7	
822.75	20.70	H	0.6	0.0	20.09	50.00	-29.9	
Rev. 05.21.15								

EVDO-Rev A, 800MHz BC10

High Frequency Substitution Measurement UL Fremont Radiated Chamber F								
Company:								
Project #: 15U22428								
Date: 01/05/16								
Test Engineer: M. Hua								
Configuration: EUT Only								
Mode: CDMA Rev A 800MHz								
Test Equipment:								
Receiving: Sunol T122, and Chamber F Cable								
Substitution: Dipole S/N: 00022117, 8ft SMA Cable								
F MHz	SG reading (dBm)	Ant. Pol. (H/V)	Cable Loss (dB)	Antenna Gain (dBd)	ERP (dBm)	Limit (dBm)	Margin (dB)	Notes
Low Ch								
817.25	17.95	V	0.6	0.0	17.33	50.00	-32.7	
817.25	22.39	H	0.6	0.0	21.77	50.00	-28.2	
Mid Ch								
820.00	17.79	V	0.6	0.0	17.17	50.00	-32.8	
820.00	22.31	H	0.6	0.0	21.69	50.00	-28.3	
High Ch								
822.75	16.80	V	0.6	0.0	16.18	50.00	-33.8	
822.75	21.77	H	0.6	0.0	21.15	50.00	-28.8	
Rev. 05.21.15								

CDMA2000 1xRTT, 850MHz BC0

High Frequency Substitution Measurement UL Fremont Radiated Chamber D										
Company:										
Project #: 15U21279										
Date: 12/03/15										
Test Engineer: M. Hua										
Configuration: EUT Only										
Mode: CDMA 1XRTT 850MHz										
Test Equipment:										
Receiving: Sunol T407, and Chamber D Cable										
Substitution: Dipole S/N: 00022117, 8ft SMA Cable										
f MHz	SG reading (dBm)	Ant. Pol. (H/V)	Cable Loss (dB)	Antenna Gain (dBd)	ERP (dBm)	EIRP (dBm)	ERP Limit (dBm)	EIRP Limit (dBm)	Margin (dB)	Notes
Low Ch										
824.70	14.4	V	0.6	0.0	13.83	15.98	38.45	40.60	-24.6	
824.70	21.7	H	0.6	0.0	21.11	23.26	38.45	40.60	-17.3	
Mid Ch										
836.52	12.7	V	0.6	0.0	12.11	14.26	38.45	40.60	-26.3	
836.52	21.8	H	0.6	0.0	21.19	23.34	38.45	40.60	-17.3	
High Ch										
848.31	13.0	V	0.6	0.0	12.41	14.56	38.45	40.60	-26.0	
848.31	22.3	H	0.6	0.0	21.64	23.79	38.45	40.60	-16.8	
Rev. 11.24.15										

EVDO-Rev A, 850MHz BC0

High Frequency Substitution Measurement UL Fremont Radiated Chamber F										
Company:										
Project #: 15U22428										
Date: 01/05/16										
Test Engineer: M. Hua										
Configuration: EUT Only										
Mode: CDMA Rev A 850MHz										
Test Equipment:										
Receiving: Sunol T122, and Chamber F Cable										
Substitution: Dipole S/N: 00022117, 8ft SMA Cable										
f MHz	SG reading (dBm)	Ant. Pol. (H/V)	Cable Loss (dB)	Antenna Gain (dBd)	ERP (dBm)	EIRP (dBm)	ERP Limit (dBm)	EIRP Limit (dBm)	Margin (dB)	Notes
Low Ch										
824.70	17.5	V	0.6	0.0	16.84	18.99	38.45	40.60	-21.6	
824.70	21.8	H	0.6	0.0	21.22	23.37	38.45	40.60	-17.2	
Mid Ch										
836.52	16.1	V	0.6	0.0	15.46	17.61	38.45	40.60	-23.0	
836.52	22.0	H	0.6	0.0	21.39	23.54	38.45	40.60	-17.1	
High Ch										
848.31	15.5	V	0.6	0.0	14.89	17.04	38.45	40.60	-23.6	
848.31	22.3	H	0.6	0.0	21.70	23.85	38.45	40.60	-16.7	
Rev. 06.18.14										

CDMA2000 1xRTT, 1900MHz BC1

High Frequency Substitution Measurement UL Fremont Radiated Chamber D								
Company:								
Project #:	15U21279							
Date:	12/03/15							
Test Engineer:	F. Guarnero							
Configuration:	EUT Only							
Mode:	CDMA 1XRTT 1900MHz							
Test Equipment:								
Receiving: Horn T344 and Chamber D SMA Cables								
Substitution: Horn T59 Substitution, and 8ft SMA Cable								
f GHz	SG reading (dBm)	Ant. Pol. (H/V)	Cable Loss (dB)	Antenna Gain (dBi)	EIRP (dBm)	Limit (dBm)	Margin (dB)	Notes
Low Ch								
1.851	16.4	V	0.98	8.05	23.45	33.0	-9.6	
1.851	14.3	H	0.98	8.05	21.36	33.0	-11.6	
Mid Ch								
1.880	15.7	V	0.98	8.03	22.76	33.0	-10.2	
1.880	14.0	H	0.98	8.03	21.02	33.0	-12.0	
High Ch								
1.909	15.6	V	0.98	8.05	22.67	33.0	-10.3	
1.909	13.7	H	0.98	8.05	20.73	33.0	-12.3	
Rev. 11.20.15								

EVDO-Rev A, 1900MHz BC1

High Frequency Substitution Measurement UL Fremont Radiated Chamber F								
Company:								
Project #: 15U22428								
Date: 01/05/16								
Test Engineer: M. Hua								
Configuration: EUT Only								
Mode: CDMA Rev A 1900MHz								
Test Equipment:								
Receiving: Horn T120 and Chamber F SMA Cables								
Substitution: Horn T59 Substitution, and 8ft SMA Cable								
f GHz	SG reading (dBm)	Ant. Pol. (H/V)	Cable Loss (dB)	Antenna Gain (dBi)	EIRP (dBm)	Limit (dBm)	Margin (dB)	Notes
Low Ch								
1.851	16.4	V	0.98	8.05	23.49	33.0	-9.5	
1.851	14.3	H	0.98	8.05	21.33	33.0	-11.7	
Mid Ch								
1.880	15.8	V	0.98	8.03	22.82	33.0	-10.2	
1.880	12.7	H	0.98	8.03	19.72	33.0	-13.3	
High Ch								
1.909	15.7	V	0.98	8.05	22.73	33.0	-10.3	
1.909	14.0	H	0.98	8.05	21.07	33.0	-11.9	
Rev. 05.21.15								

CDMA2000 1xRTT, 1700MHz BC15

High Frequency Substitution Measurement UL Fremont Radiated Chamber D								
Company:								
Project #:	15U21279							
Date:	12/03/15							
Test Engineer:	M. Hua							
Configuration:	EUT Only							
Mode:	CDMA 1XRTT 1700MHz							
Test Equipment:								
Receiving: Horn T344 and Chamber D SMA Cables								
Substitution: Horn T59 Substitution, and 8ft SMA Cable								
f GHz	SG reading (dBm)	Ant. Pol. (H/V)	Cable Loss (dB)	Antenna Gain (dBi)	EIRP (dBm)	Limit (dBm)	Margin (dB)	Notes
Low Ch								
1.711	13.1	V	0.95	8.27	20.44	30.0	-9.6	
1.711	13.5	H	0.95	8.27	20.78	30.0	-9.2	
Mid Ch								
1.733	12.2	V	0.95	8.23	19.52	30.0	-10.5	
1.733	13.2	H	0.95	8.23	20.45	30.0	-9.5	
High Ch								
1.754	9.7	V	0.95	8.18	16.94	30.0	-13.1	
1.754	13.8	H	0.95	8.18	21.05	30.0	-8.9	
Rev. 11.20.15								

EVDO-Rev A, 1700MHz BC15

High Frequency Substitution Measurement UL Fremont Radiated Chamber F								
Company:								
Project #: 15U22428								
Date: 01/05/16								
Test Engineer: M. Hua								
Configuration: EUT Only								
Mode: CDMA Rev A 1700MHz								
Test Equipment:								
Receiving: Horn T120 and Chamber F SMA Cables								
Substitution: Horn T59 Substitution, and 8ft SMA Cable								
f GHz	SG reading (dBm)	Ant. Pol. (H/V)	Cable Loss (dB)	Antenna Gain (dBi)	EIRP (dBm)	Limit (dBm)	Margin (dB)	Notes
Low Ch								
1.711	12.6	V	0.95	8.27	19.96	30.0	-10.0	
1.711	13.6	H	0.95	8.27	20.95	30.0	-9.0	
Mid Ch								
1.733	12.6	V	0.95	8.23	19.84	30.0	-10.2	
1.733	13.3	H	0.95	8.23	20.62	30.0	-9.4	
High Ch								
1.754	12.4	V	0.95	8.18	19.61	30.0	-10.4	
1.754	14.0	H	0.95	8.18	21.20	30.0	-8.8	
Rev. 05.21.15								

10.2.6. UMTS

UMTS REL 99, 850MHz BAND 5

High Frequency Substitution Measurement UL Fremont Radiated Chamber D										
Company:										
Project #: 15U21279										
Date: 12/04/15										
Test Engineer: F. Guamero										
Configuration: EUT Only										
Mode: WCDMA Rel 99 850MHz										
Test Equipment:										
Receiving: Sunol T407, and Chamber D Cable										
Substitution: Dipole S/N: 00022117, 8ft SMA Cable										
f MHz	SG reading (dBm)	Ant. Pol. (H/V)	Cable Loss (dB)	Antenna Gain (dBd)	ERP (dBm)	EIRP (dBm)	ERP Limit (dBm)	EIRP Limit (dBm)	Margin (dB)	Notes
Low Ch										
826.40	14.8	V	0.6	0.0	14.18	16.33	38.45	40.60	-24.3	
826.40	22.1	H	0.6	0.0	21.47	23.62	38.45	40.60	-17.0	
Mid Ch										
836.60	14.3	V	0.6	0.0	13.69	15.84	38.45	40.60	-24.8	
836.60	22.2	H	0.6	0.0	21.54	23.69	38.45	40.60	-16.9	
High Ch										
846.60	12.9	V	0.6	0.0	12.25	14.40	38.45	40.60	-26.2	
846.60	21.8	H	0.6	0.0	21.20	23.35	38.45	40.60	-17.3	
Rev. 11.24.15										

UMTS HSDPA, 850MHz BAND 5

High Frequency Substitution Measurement UL Fremont Radiated Chamber D										
Company:										
Project #: 15U21279										
Date: 12/04/15										
Test Engineer: F. Guarnero										
Configuration: EUT Only										
Mode: WCDMA HSDPA 850MHz										
Test Equipment:										
Receiving: Sunol T407, and Chamber D Cable										
Substitution: Dipole S/N: 00022117, 8ft SMA Cable										
f MHz	SG reading (dBm)	Ant. Pol. (H/V)	Cable Loss (dB)	Antenna Gain (dBd)	ERP (dBm)	EIRP (dBm)	ERP Limit (dBm)	EIRP Limit (dBm)	Margin (dB)	Notes
Low Ch										
826.40	13.5	V	0.6	0.0	12.83	14.98	38.45	40.60	-25.6	
826.40	21.1	H	0.6	0.0	20.51	22.66	38.45	40.60	-17.9	
Mid Ch										
836.60	11.9	V	0.6	0.0	11.31	13.46	38.45	40.60	-27.1	
836.60	21.3	H	0.6	0.0	20.64	22.79	38.45	40.60	-17.8	
High Ch										
846.60	12.0	V	0.6	0.0	11.40	13.55	38.45	40.60	-27.0	
846.60	20.7	H	0.6	0.0	20.11	22.26	38.45	40.60	-18.3	
Rev. 11.24.15										

UMTS REL 99, 1900MHZ BAND 2

High Frequency Substitution Measurement UL Fremont Radiated Chamber D								
Company:								
Project #: 15U21279								
Date: 12/04/15								
Test Engineer: F. Guarnero								
Configuration: EUT Only								
Mode: WCDMA Rel 99 1900MHz								
Test Equipment:								
Receiving: Horn T344 and Chamber D SMA Cables								
Substitution: Horn T59 Substitution, and 8ft SMA Cable								
f GHz	SG reading (dBm)	Ant. Pol. (H/V)	Cable Loss (dB)	Antenna Gain (dBi)	EIRP (dBm)	Limit (dBm)	Margin (dB)	Notes
Low Ch								
1.852	15.4	V	0.98	8.05	22.48	33.0	-10.5	
1.852	13.3	H	0.98	8.05	20.36	33.0	-12.6	
Mid Ch								
1.880	15.1	V	0.98	8.03	22.10	33.0	-10.9	
1.880	12.5	H	0.98	8.03	19.57	33.0	-13.4	
High Ch								
1.908	15.3	V	0.98	8.04	22.36	33.0	-10.6	
1.908	12.5	H	0.98	8.04	19.60	33.0	-13.4	
Rev. 11.20.15								

UMTS HSDPA, 1900MHz BAND 2

High Frequency Substitution Measurement UL Fremont Radiated Chamber D								
Company:								
Project #: 15U21279								
Date: 12/04/15								
Test Engineer: F. Guarero								
Configuration: EUT Only								
Mode: WCDMA HSDPA 1900MHz								
Test Equipment:								
Receiving: Horn T344 and Chamber D SMA Cables								
Substitution: Horn T59 Substitution, and 8ft SMA Cable								
f GHz	SG reading (dBm)	Ant. Pol. (H/V)	Cable Loss (dB)	Antenna Gain (dBi)	EIRP (dBm)	Limit (dBm)	Margin (dB)	Notes
Low Ch								
1.852	14.5	V	0.98	8.05	21.56	33.0	-11.4	
1.852	12.8	H	0.98	8.05	19.87	33.0	-13.1	
Mid Ch								
1.880	14.3	V	0.98	8.03	21.30	33.0	-11.7	
1.880	11.9	H	0.98	8.03	18.94	33.0	-14.1	
High Ch								
1.908	14.4	V	0.98	8.04	21.41	33.0	-11.6	
1.908	11.8	H	0.98	8.04	18.90	33.0	-14.1	
Rev. 11.20.15								

UMTS REL 99, 1700MHZ BAND 4

High Frequency Substitution Measurement UL Fremont Radiated Chamber D								
Company:								
Project #: 15U21279								
Date: 12/04/15								
Test Engineer: F. Guarnero								
Configuration: EUT Only								
Mode: WCDMA Rel 99 1700MHz								
Test Equipment:								
Receiving: Horn T344 and Chamber D SMA Cables								
Substitution: Horn T59 Substitution, and 8ft SMA Cable								
f GHz	SG reading (dBm)	Ant. Pol. (H/V)	Cable Loss (dB)	Antenna Gain (dBi)	EIRP (dBm)	Limit (dBm)	Margin (dB)	Notes
Low Ch								
1.712	14.7	V	0.95	8.27	22.07	30.0	-7.9	
1.712	13.2	H	0.95	8.27	20.54	30.0	-9.5	
Mid Ch								
1.733	14.6	V	0.95	8.23	21.87	30.0	-8.1	
1.733	12.8	H	0.95	8.23	20.06	30.0	-9.9	
High Ch								
1.753	14.9	V	0.95	8.18	22.12	30.0	-7.9	
1.753	13.7	H	0.95	8.18	20.90	30.0	-9.1	
Rev. 11.20.15								

UMTS HSDPA, 1700MHz BAND 4

High Frequency Substitution Measurement UL Fremont Radiated Chamber D								
Company:								
Project #: 15U21279								
Date: 12/04/15								
Test Engineer: F. Guarnero								
Configuration: EUT Only								
Mode: WCDMA HSDPA 1700MHz								
Test Equipment:								
Receiving: Horn T344 and Chamber D SMA Cables								
Substitution: Horn T59 Substitution, and 8ft SMA Cable								
f GHz	SG reading (dBm)	Ant. Pol. (H/V)	Cable Loss (dB)	Antenna Gain (dBi)	EIRP (dBm)	Limit (dBm)	Margin (dB)	Notes
Low Ch								
1.712	13.8	V	0.95	8.27	21.12	30.0	-8.9	
1.712	10.9	H	0.95	8.27	18.24	30.0	-11.8	
Mid Ch								
1.733	13.7	V	0.95	8.23	20.93	30.0	-9.1	
1.733	11.1	H	0.95	8.23	18.37	30.0	-11.6	
High Ch								
1.753	14.0	V	0.95	8.18	21.23	30.0	-8.8	
1.753	12.1	H	0.95	8.18	19.30	30.0	-10.7	
Rev. 11.20.15								

10.3. PEAK-TO-AVERAGE RATIO

In addition, when the transmitter power is measured in terms of average value, the peak-to-average ratio of the power shall not exceed 13 dB.

Peak-To-Average Ratio:

Mode	Modulation	Conducted Power (dBm)		Peak-to-Average Ratio (PAR)
		*Peak	Average	
GSM850	GPRS	33.87	33.32	0.55
	EGPRS	32.11	28.92	3.19
*Peak Reading = Average Reading + Peak-to-Average Ratio				

Mode	Modulation	Conducted Power (dBm)		Peak-to-Average Ratio (PAR)
		*Peak	Average	
GSM1900	GPRS	29.87	29.47	0.4
	EGPRS	31.35	27.98	3.37
*Peak Reading = Average Reading + Peak-to-Average Ratio				

Mode	Modulation	Conducted Power (dBm)		Peak-to-Average Ratio (PAR)
		*Peak	Average	
CDMA2000 BC0	1xRTT	29.21	24.41	4.8
	EVDO A	29.98	24.45	5.53
*Peak Reading = Average Reading + Peak-to-Average Ratio				

Mode	Modulation	Conducted Power (dBm)		Peak-to-Average Ratio (PAR)
		*Peak	Average	
CDMA2000 BC1	1xRTT	29.08	24.46	4.62
	EVDO A	29.87	24.48	5.39
*Peak Reading = Average Reading + Peak-to-Average Ratio				

Mode	Modulation	Couducted Power (dBm)		Peak-to-Average Ratio (PAR)
		*Peak	Average	
CDMA2000 BC15	1xRTT	28.96	24.4	4.56
	EVDO A	28.34	24.45	3.89
*Peak Reading = Average Reading + Peak-to-Average Ratio				

Mode	Modulation	Couducted Power (dBm)		Peak-to-Average Ratio (PAR)
		*Peak	Average	
CDMA2000 BC10	1xRTT	28.66	24.95	3.71
	EVDO A	28.63	25	3.63
*Peak Reading = Average Reading + Peak-to-Average Ratio				

Mode	Modulation	Couducted Power (dBm)		Peak-to-Average Ratio (PAR)
		*Peak	Average	
UMTS Band 5	REL99	27.96	24.97	2.99
	HSDPA	27.72	23.96	3.76
*Peak Reading = Average Reading + Peak-to-Average Ratio				

Mode	Modulation	Couducted Power (dBm)		Peak-to-Average Ratio (PAR)
		*Peak	Average	
UMTS Band 2	REL99	27.37	24.47	2.9
	HSDPA	27.18	23.43	3.75
*Peak Reading = Average Reading + Peak-to-Average Ratio				

Mode	Modulation	Couducted Power (dBm)		Peak-to-Average Ratio (PAR)
		*Peak	Average	
UMTS Band 4	REL99	27.53	24.47	3.06
	HSDPA	27.17	23.5	3.67
*Peak Reading = Average Reading + Peak-to-Average Ratio				

GSM850, GPRS

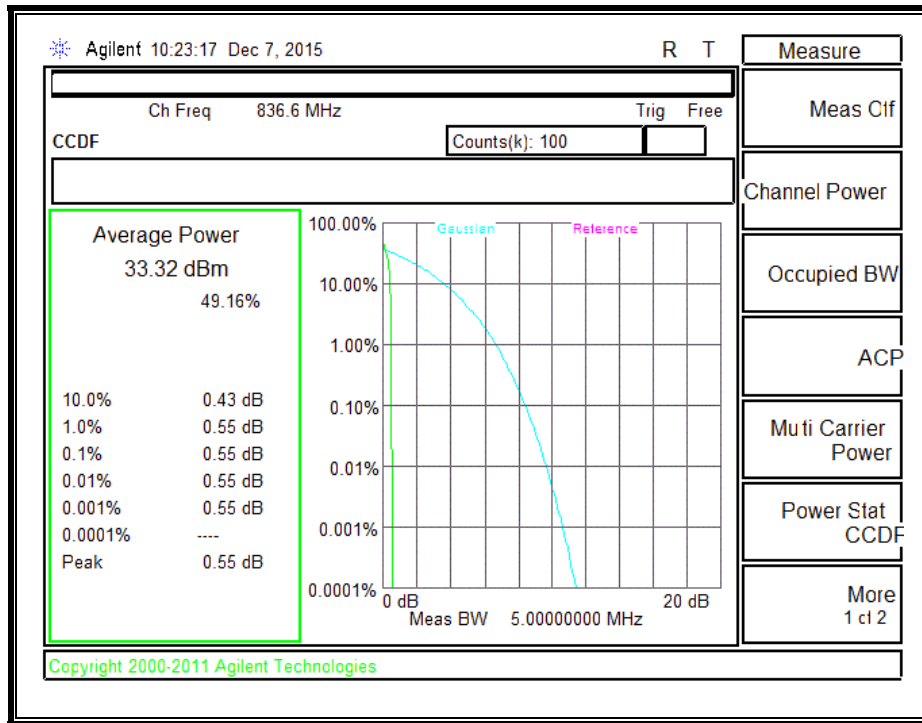

GSM850, EGPRS

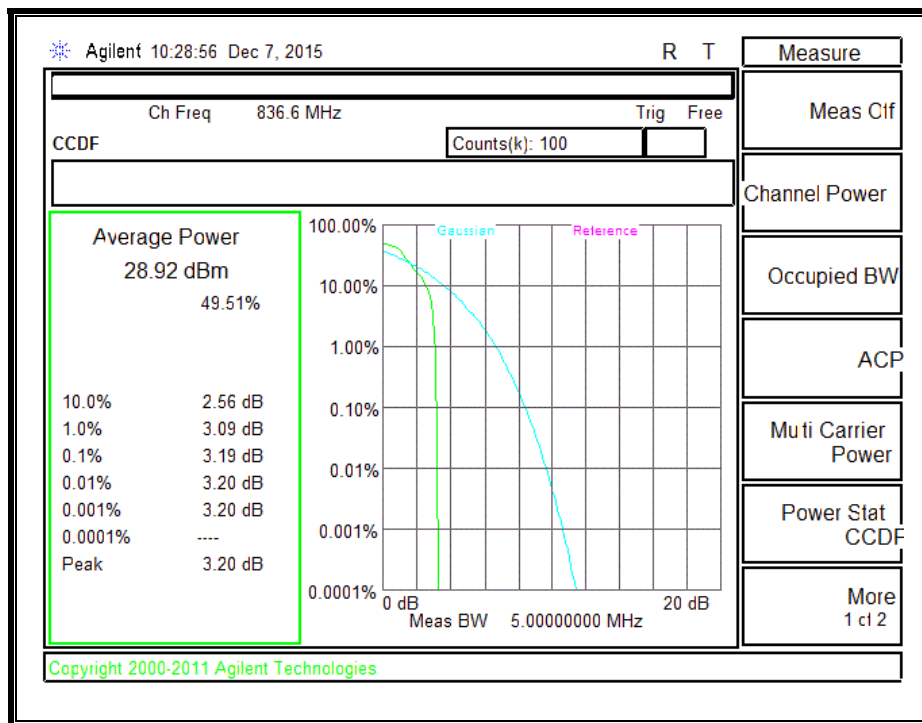

GSM1900, GPRS

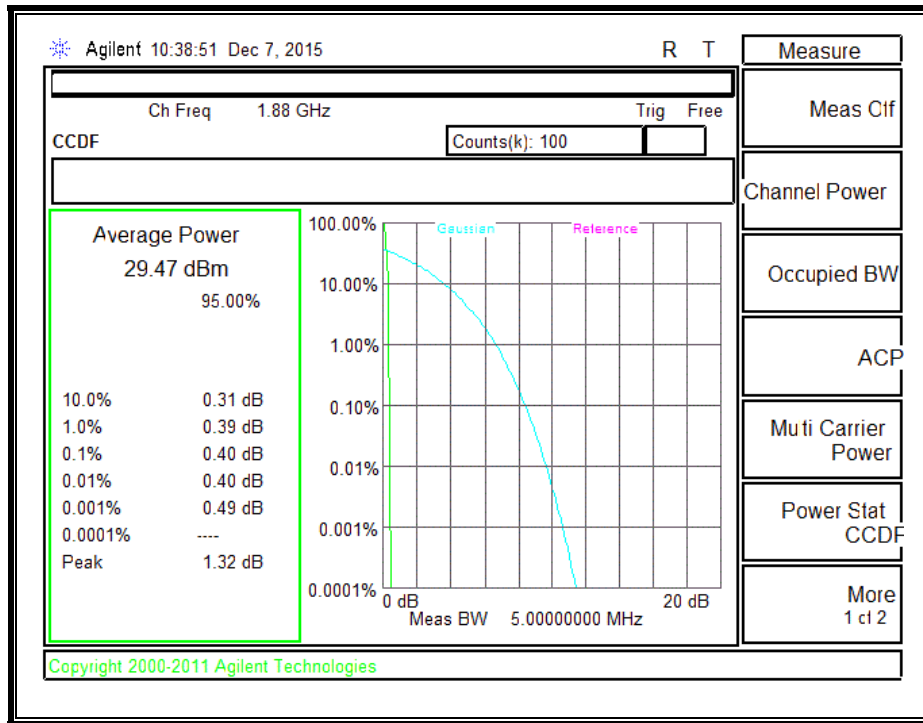

GSM1900, EGPRS

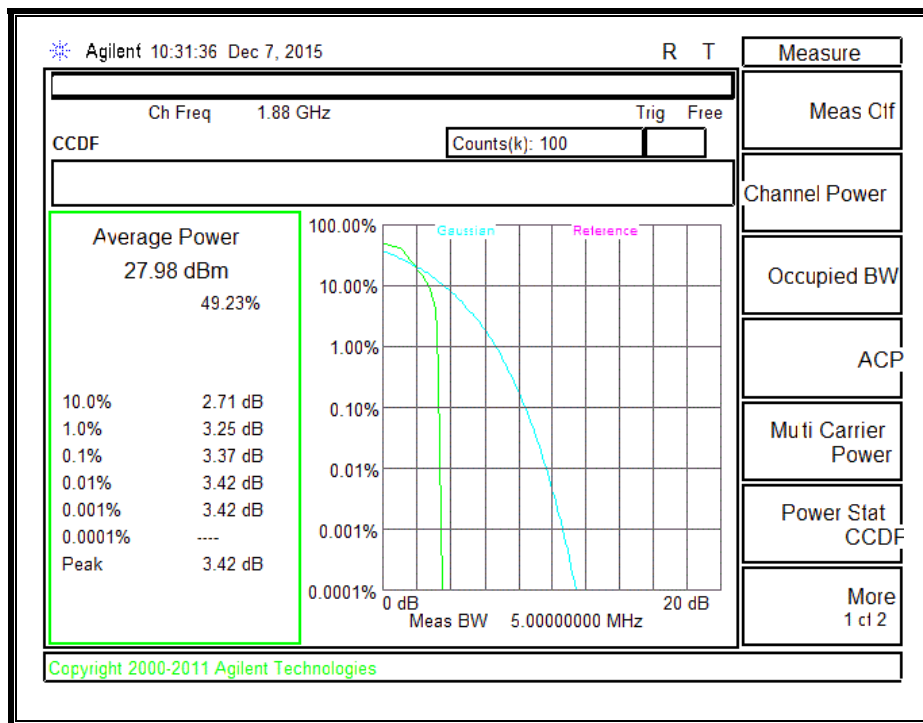

BC 0, 1xRTT

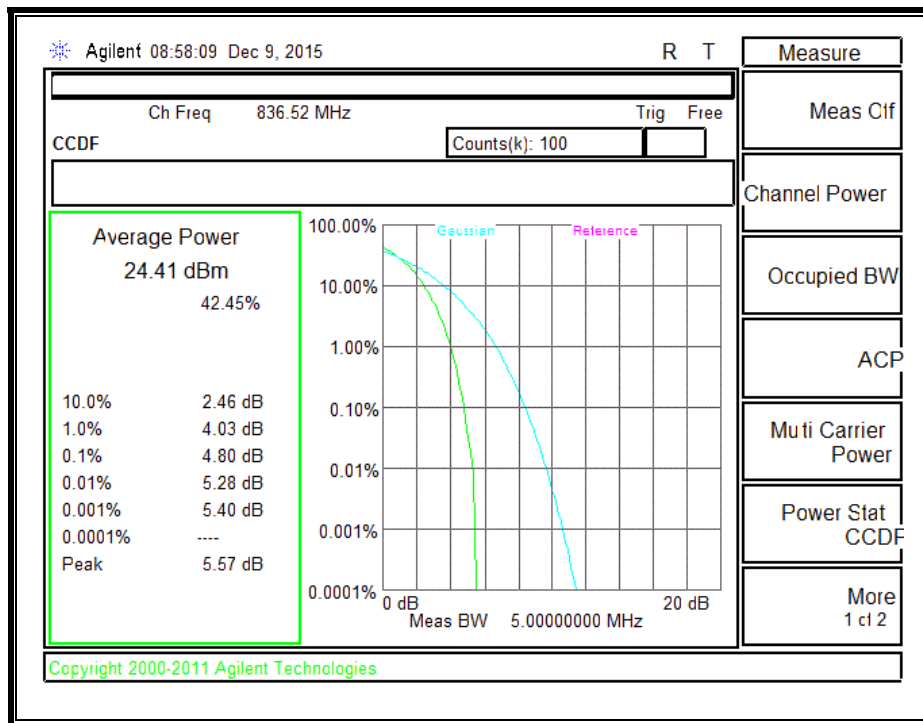

BC 0, EVDO A

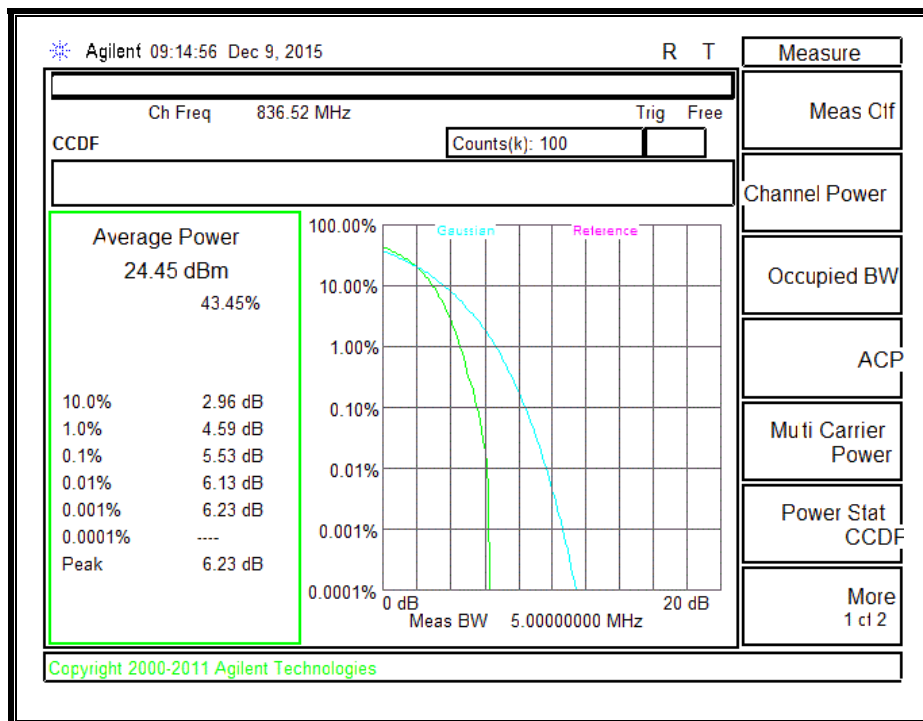

BC 1, 1xRTT

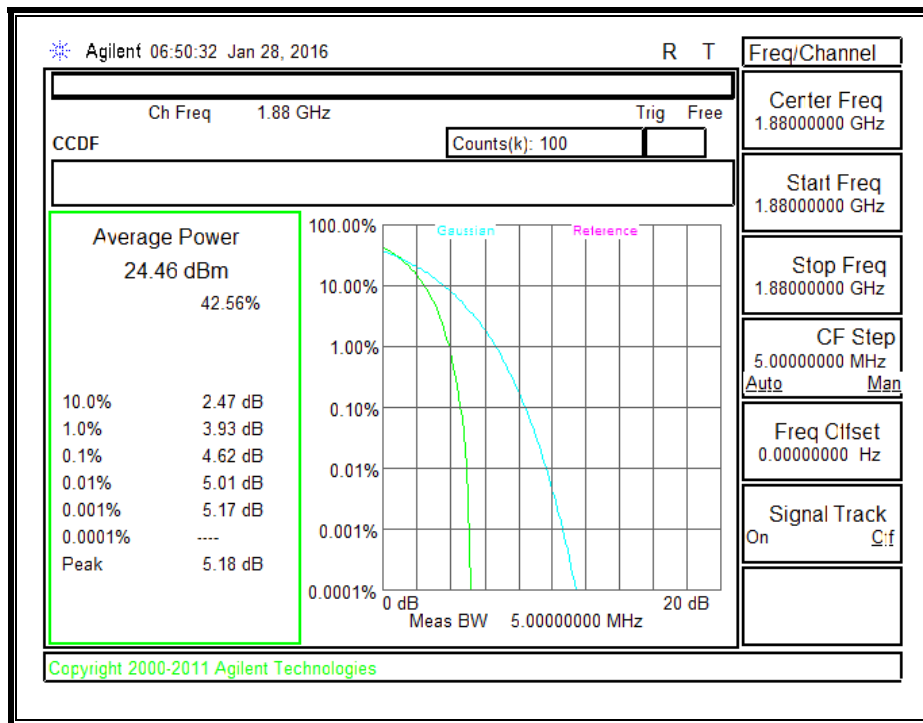

BC 1, EVDO A

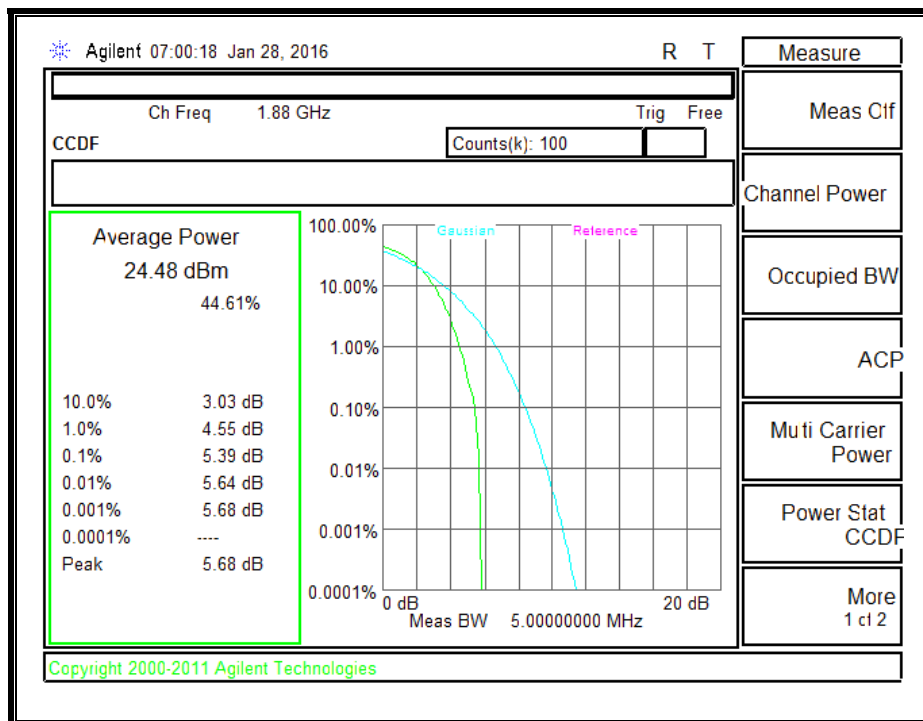

BC15, 1xRTT

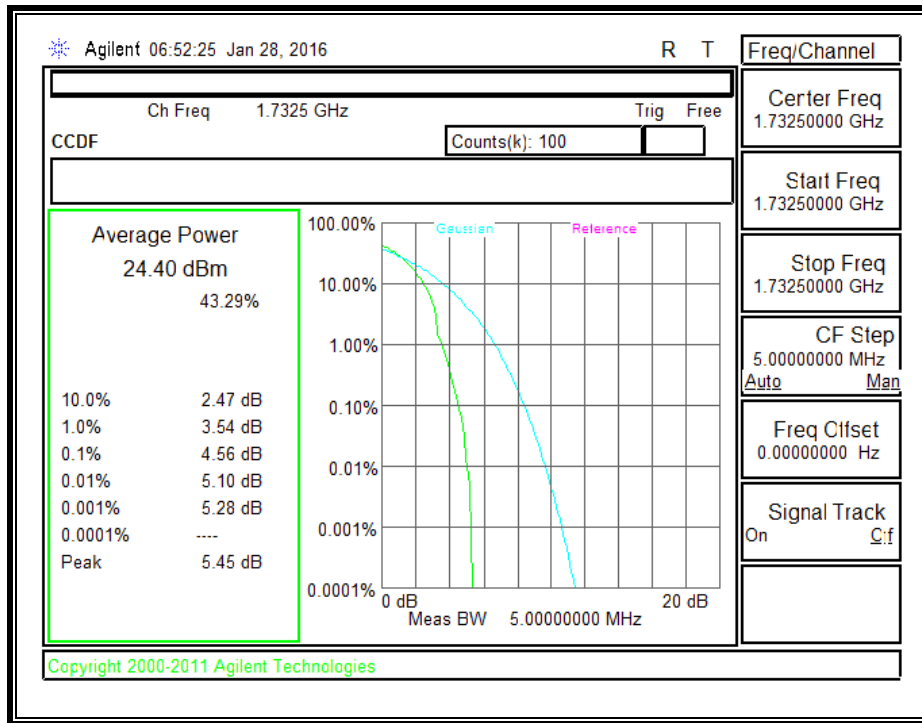

BC15, EVDO A

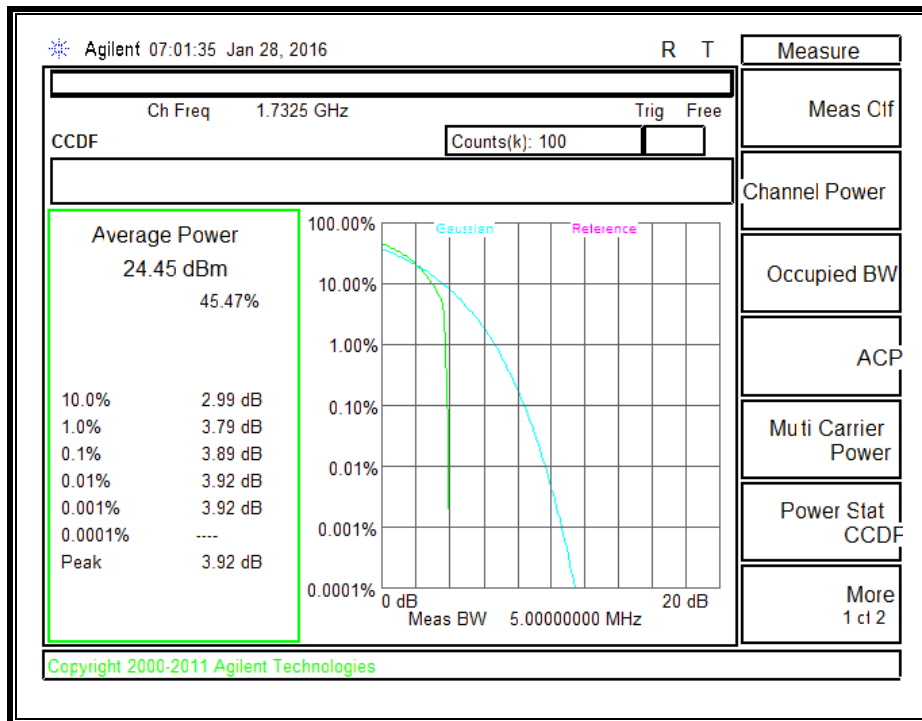

BC10, 1xRTT

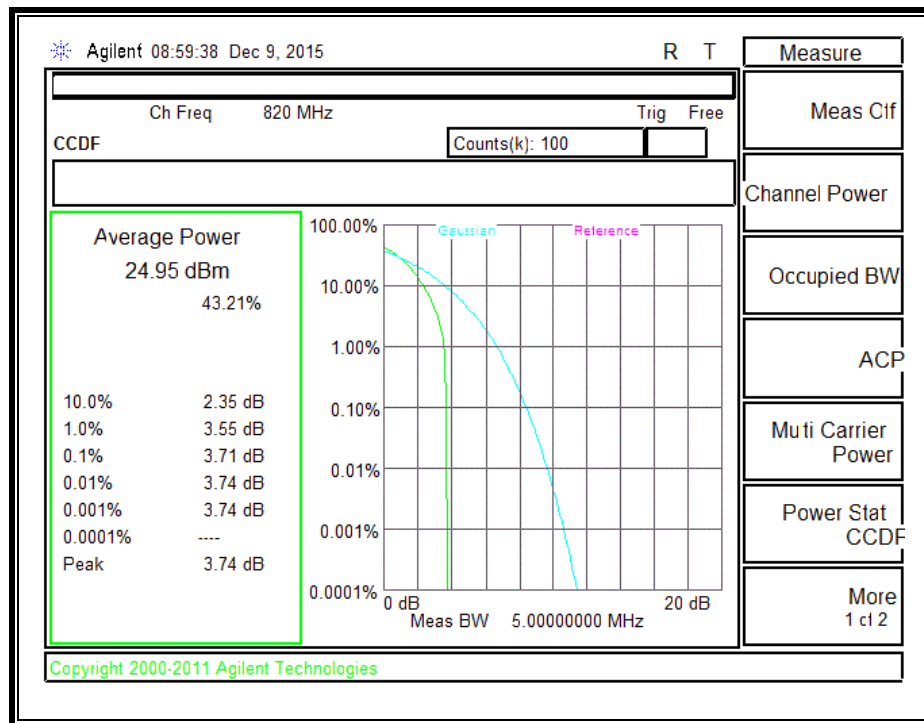

BC10, EVDO A

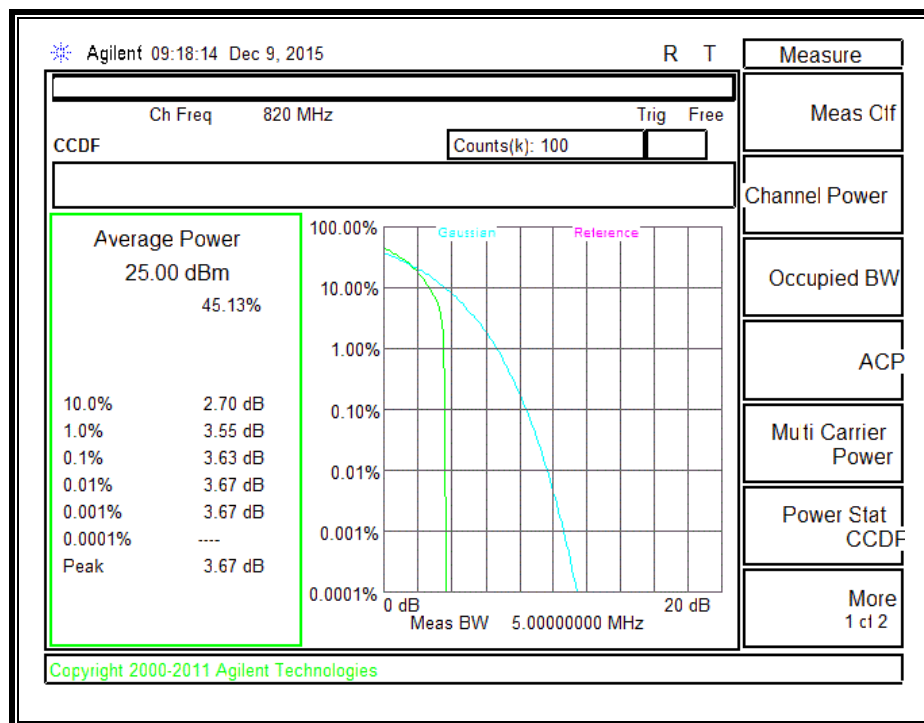

UMTS850, REL 99 BAND 5

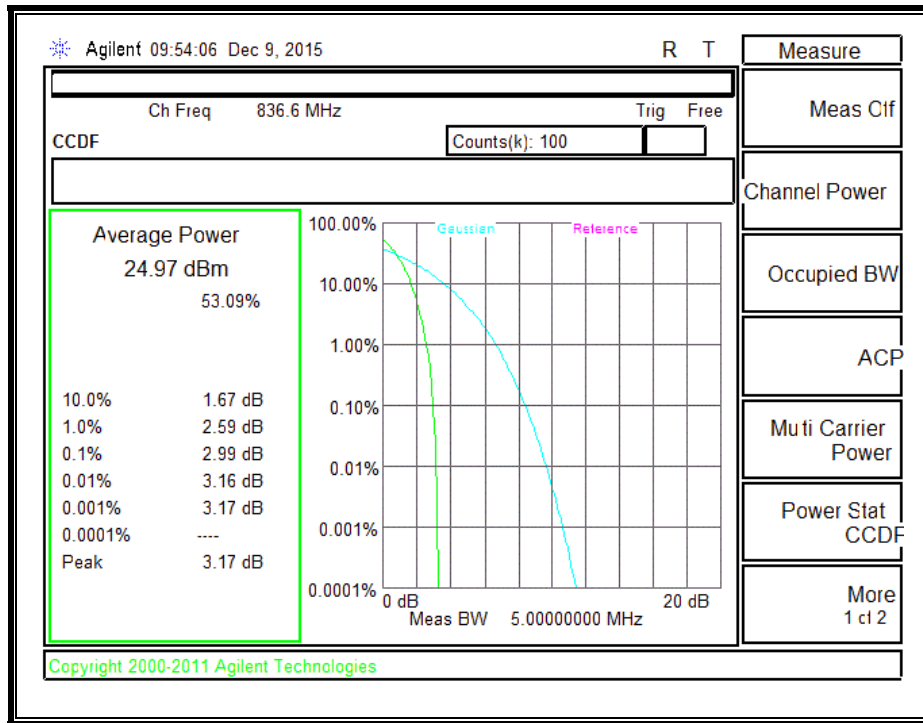

UMTS 850, HSDPA BAND 5

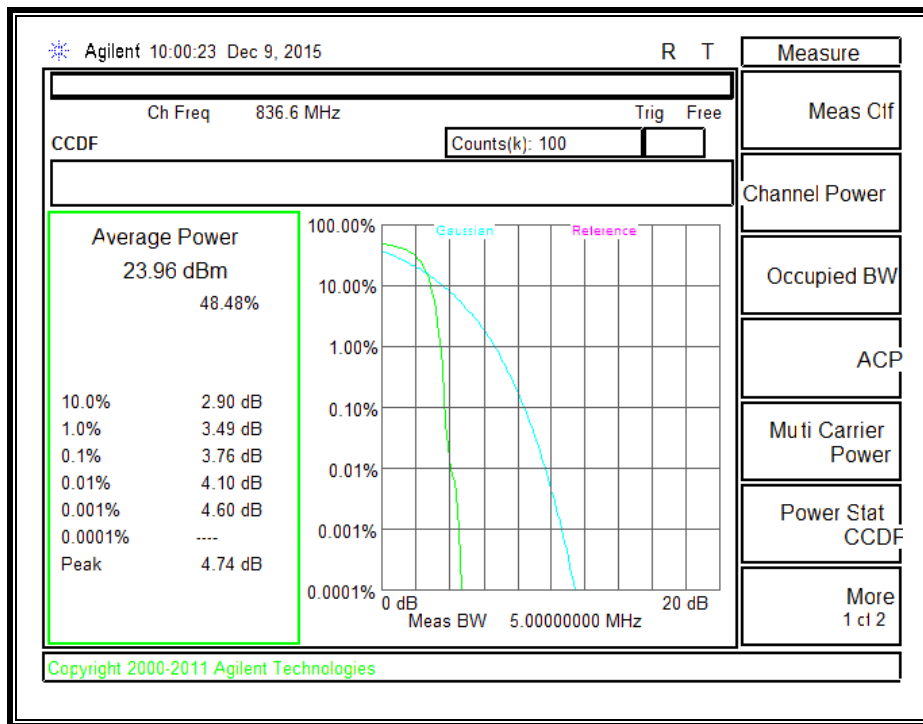

UMTS 1900, REL99 BAND 2

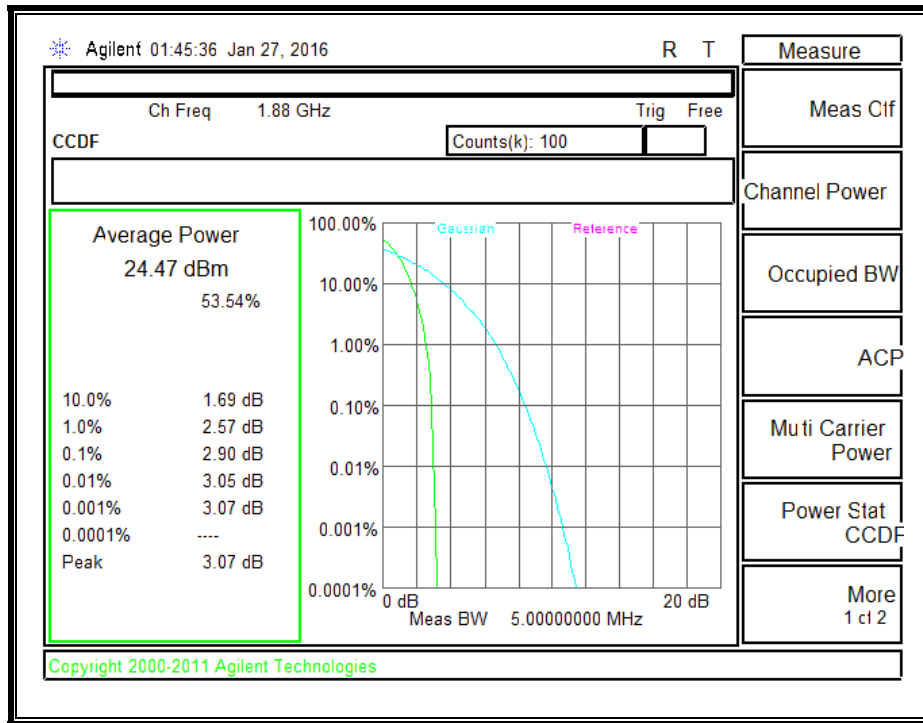

UMTS 1900, HSDPA BAND 2

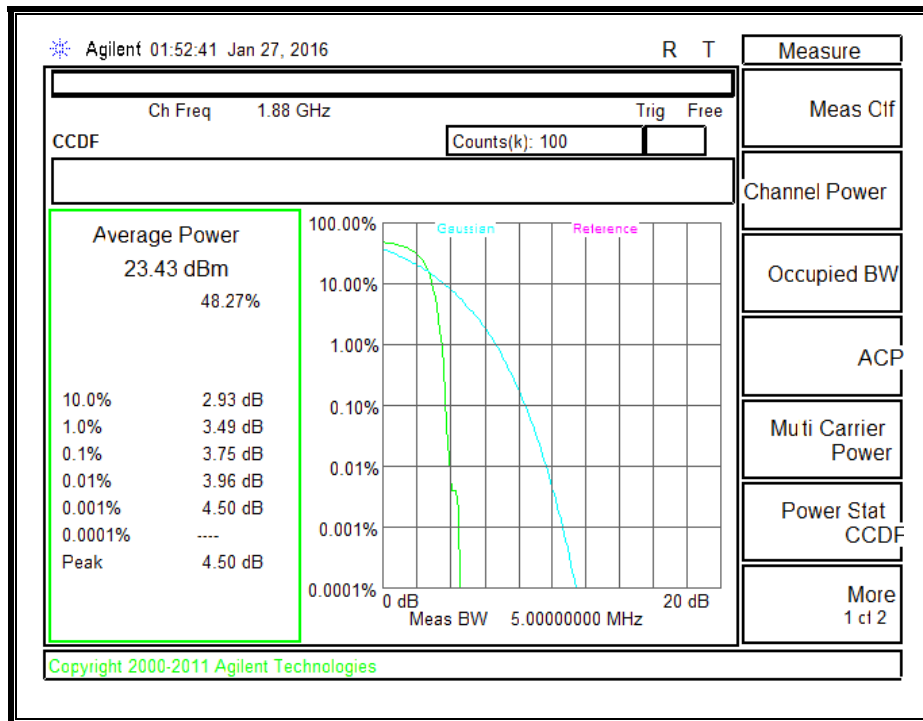

UMTS 1700, REL99 BAND 4

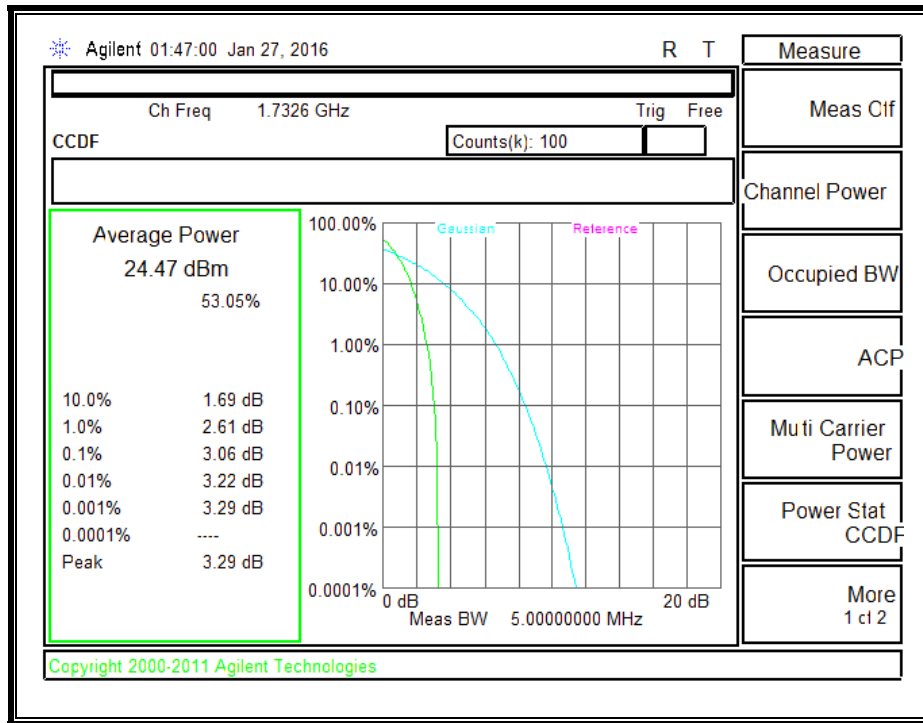

UMTS 1700, HSDPA BAND 4

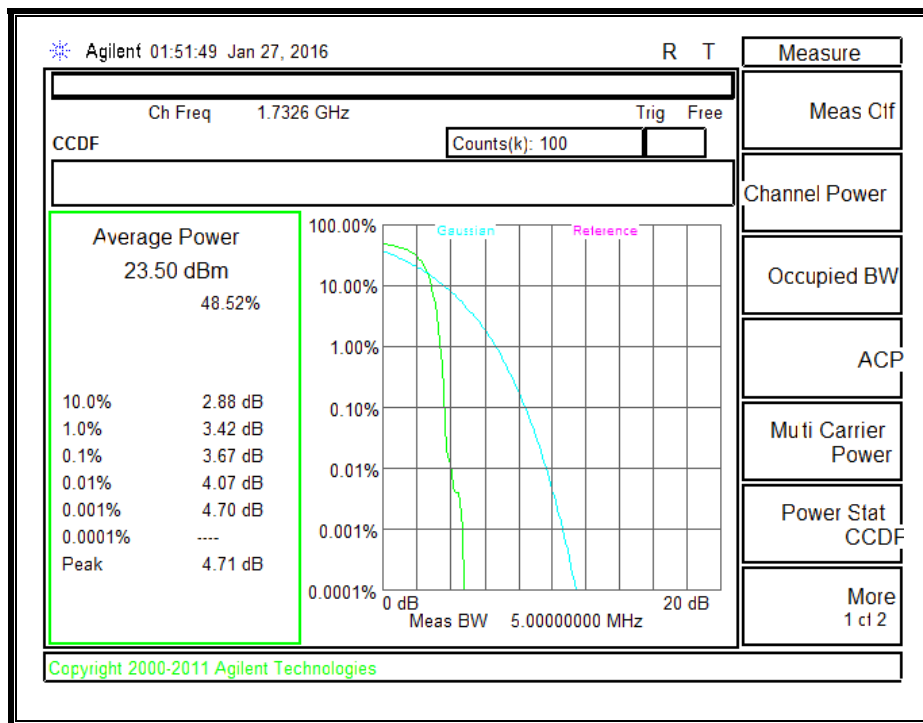

10.4. FIELD STRENGTH OF SPURIOUS RADIATION (ANTENNA - C)

RULE PART(S)

FCC: §2.1053, §22.917, §24.238, §27.53 and §90.691.

LIMIT

§22.917 (e) and §24.238 (a): Out of band emissions. The power of any emission outside of the authorized operating frequency ranges must be attenuated below the transmitting power (P) by a factor of at least $43 + 10 \log (P)$ dB.

§27.53 (h) For operations in the 1710–1755 MHz and 2110–2155 MHz bands, the power of any emission outside a licensee's frequency block shall be attenuated below the transmitter power (P) by at least $43 + 10 \log_{10}(P)$ dB

§90.691 Emission mask requirements for EA-based systems.

(a) Out-of-band emission requirement shall apply only to the “outer” channels included in an EA license and to spectrum adjacent to interior channels used by incumbent licensees. The emission limits are as follows:

(1) For any frequency removed from the EA licensee's frequency block by up to and including 37.5 kHz, the power of any emission shall be attenuated below the transmitter power (P) in watts by at least $116 \log_{10} (f/6.1)$ decibels or $50 + 10 \log_{10} (P)$ decibels or 80 decibels, whichever is the lesser attenuation, where f is the frequency removed from the center of the outer channel in the block in kilohertz and where f is greater than 12.5 kHz.

(2) For any frequency removed from the EA licensee's frequency block greater than 37.5 kHz, the power of any emission shall be attenuated below the transmitter power (P) in watts by at least $43 + 10 \log_{10} (P)$ decibels or 80 decibels, whichever is the lesser attenuation, where f is the frequency removed from the center of the outer channel in the block in kilohertz and where f is greater than 37.5 kHz.

(b) When an emission outside of the authorized bandwidth causes harmful interference, the Commission may, at its discretion, require greater attenuation than specified in this section.

TEST PROCEDURE

For Cellular equipment - Compliance with these rules is based on the use of measurement instrumentation employing a resolution bandwidth of 100 kHz or greater. In the 1 MHz bands immediately outside and adjacent to the frequency block a resolution bandwidth of at least one percent of the emission bandwidth of the fundamental emission of the transmitter may be employed. A narrower resolution bandwidth is permitted in all cases to improve measurement accuracy provided the measured power is integrated over the full required measurement bandwidth (i.e. 100 kHz or 1 percent of emission bandwidth, as specified). The emission bandwidth is defined as the width of the signal between two points, one below the carrier center frequency and one above the carrier center frequency, outside of which all emissions are attenuated at least 26 dB below the transmitter power.

For PCS equipment - Compliance with these rules is based on the use of measurement instrumentation employing a resolution bandwidth of 1 MHz or greater. However, in the 1 MHz bands immediately outside and adjacent to the frequency block a resolution bandwidth of at least one percent of the emission bandwidth of the fundamental emission of the transmitter may be employed. A narrower resolution bandwidth is permitted in all cases to improve measurement accuracy provided the measured power is integrated over the full required measurement bandwidth (i.e. 1 MHz or 1 percent of emission bandwidth, as specified). The emission bandwidth is defined as the width of the signal between two points, one below the carrier center frequency and one above the carrier center frequency, outside of which all emissions are attenuated at least 26 dB below the transmitter power.

MODES TESTED

- GPRS/EGPRS
- UMTS, REL 99 and HSDPA
- CDMA2000, 1xRTT and EVDO, Rev A

RESULTS

10.4.1. GSM

GPRS, 850MHz BAND 5

High Frequency Substitution Measurement
UL Fremont Radiated Chamber

Company: _____
 Project #: 15U22428
 Date: 12/07/15
 Test Engineer: F. Guamero
 Configuration: EUT Only
 Mode: GPRS 850MHz

Test Equipment:
 Substitution: Horn T59 Substitution, and 8ft SMA Cable

Chamber

Pre-amplifier

Filter

Limit

3m Chamber D

3m Chamber D

Filter

EIRP

Frequency (GHz)	SA reading (dBm)	Ant. Pol. (H/V)	Distance	EIRP @ TX Ant End (dBm)	Preamp	Attenuator	EIRP	Limit	Delta	Notes
Low Channel (824.2MHz)										
1.65	-51.5	H	3.0	-9.7	35.0	1.0	-43.7	-13.0	-30.7	
2.48	-54.3	H	3.0	-10.1	33.9	1.0	-43.0	-13.0	-30.0	
3.74	-64.1	H	3.0	-16.1	33.5	1.0	-48.6	-13.0	-35.6	
1.65	-51.0	V	3.0	-9.0	35.0	1.0	-43.0	-13.0	-30.0	
2.48	-60.8	V	3.0	-16.4	33.9	1.0	-49.3	-13.0	-36.3	
3.80	-67.2	V	3.0	-19.0	33.6	1.0	-51.6	-13.0	-38.6	
Mid Channel (836.6MHz)										
1.68	-50.2	H	3.0	-8.3	35.0	1.0	-42.3	-13.0	-29.3	
2.51	-57.4	H	3.0	-13.1	33.7	1.0	-45.8	-13.0	-32.8	
3.81	-62.2	H	3.0	-13.9	33.6	1.0	-46.5	-13.0	-33.5	
1.68	-53.1	V	3.0	-11.0	35.0	1.0	-45.1	-13.0	-32.1	
2.51	-60.4	V	3.0	-15.9	33.7	1.0	-48.6	-13.0	-35.6	
3.80	-62.3	V	3.0	-14.1	33.6	1.0	-46.6	-13.0	-33.6	
High Channel (848.8MHz)										
1.70	-53.3	H	3.0	-11.3	35.0	1.0	-45.3	-13.0	-32.3	
2.54	-59.7	H	3.0	-15.3	33.7	1.0	-48.0	-13.0	-35.0	
6.12	-59.4	H	3.0	-7.1	31.9	1.0	-38.0	-13.0	-25.0	
1.70	-54.3	V	3.0	-12.2	35.0	1.0	-46.2	-13.0	-33.2	
2.54	-60.5	V	3.0	-15.9	33.7	1.0	-48.6	-13.0	-35.6	
5.38	-64.8	V	3.0	-14.2	32.7	1.0	-45.8	-13.0	-32.8	

Rev. 03.19.15

EGPRS, 850MHz BAND 5

High Frequency Substitution Measurement UL Fremont Radiated Chamber

Company:
Project #: 15U22428
Date: 12/07/15
Test Engineer: F. Guarnero
Configuration: EUT Only
Mode: EGPRS 850MHz

Test Equipment:
 Substitution: Horn T59 Substitution, and 8ft SMA Cable

Chamber
 3m Chamber D

Pre-amplifier
 3m Chamber D

Filter
 Filter

Limit
 EIRP

Frequency (GHz)	SA reading (dBm)	Ant. Pol. (H/V)	Distance	EIRP @ TX Ant End (dBm)	Preamp	Attenuator	EIRP	Limit	Delta	Notes
Low Channel (824.2MHz)										
1.65	-51.2	H	3.0	-9.4	35.0	1.0	-43.5	-13.0	-30.5	
2.48	-57.2	H	3.0	-13.0	33.9	1.0	-45.9	-13.0	-32.9	
3.61	-63.0	H	3.0	-15.3	33.4	1.0	-47.8	-13.0	-34.8	
1.65	-58.5	V	3.0	-16.5	35.0	1.0	-50.5	-13.0	-37.5	
2.48	-63.0	V	3.0	-18.6	33.9	1.0	-51.5	-13.0	-38.5	
3.60	-63.7	V	3.0	-16.1	33.4	1.0	-48.5	-13.0	-35.5	
Mid Channel (836.6MHz)										
1.68	-54.2	H	3.0	-12.3	35.0	1.0	-46.3	-13.0	-33.3	
2.51	-53.3	H	3.0	-9.0	33.7	1.0	-41.8	-13.0	-28.8	
4.72	-57.3	H	3.0	-7.4	33.2	1.0	-39.6	-13.0	-26.6	
1.68	-55.1	V	3.0	-13.0	35.0	1.0	-47.0	-13.0	-34.0	
2.51	-56.3	V	3.0	-11.8	33.7	1.0	-44.5	-13.0	-31.5	
4.72	-59.5	V	3.0	-9.8	33.2	1.0	-42.0	-13.0	-29.0	
High Channel (848.8MHz)										
1.70	-53.8	H	3.0	-11.8	35.0	1.0	-45.8	-13.0	-32.8	
2.55	-54.6	H	3.0	-10.2	33.7	1.0	-42.9	-13.0	-29.9	
5.10	-60.5	H	3.0	-10.0	32.9	1.0	-41.9	-13.0	-28.9	
1.70	-55.5	V	3.0	-13.4	35.0	1.0	-47.4	-13.0	-34.4	
2.55	-56.2	V	3.0	-11.6	33.7	1.0	-44.3	-13.0	-31.3	
5.00	-63.7	V	3.0	-13.7	33.0	1.0	-45.7	-13.0	-32.7	

Rev. 03.19.15

GPRS, 1900MHz BAND 2

High Frequency Substitution Measurement
UL Fremont Radiated Chamber

Company:
Project #: 15U22428
Date: 12/07/15
Test Engineer: F. Guarnero
Configuration: EUT Only
Mode: GPRS 1900MHz

Test Equipment:
 Substitution: Horn T59 Substitution, and 8ft SMA Cable

Chamber

Pre-amplifier

Filter

Limit

3m Chamber D

3m Chamber D

Filter

EIRP

Frequency (GHz)	SA reading (dBm)	Ant. Pol. (H/V)	Distance	EIRP @ TX Ant End (dBm)	Preamp	Attenuator	EIRP	Limit	Delta	Notes
Low Channel (1850.2MHz)										
2.92	-65.0	H	3.0	-19.4	33.1	1.0	-51.5	-13.0	-38.5	
4.32	-64.0	H	3.0	-14.7	33.5	1.0	-47.2	-13.0	-34.2	
5.55	-66.2	H	3.0	-14.9	32.5	1.0	-46.4	-13.0	-33.4	
2.69	-67.0	V	3.0	-21.9	33.5	1.0	-54.4	-13.0	-41.4	
5.55	-62.5	V	3.0	-11.5	32.5	1.0	-43.0	-13.0	-30.0	
5.76	-63.4	V	3.0	-11.9	32.3	1.0	-43.2	-13.0	-30.2	
Mid Channel (1880.0)										
1.30	-63.0	H	3.0	-22.6	34.6	1.0	-56.3	-13.0	-43.3	
3.17	-62.0	H	3.0	-15.6	33.1	1.0	-47.7	-13.0	-34.7	
5.64	-63.4	H	3.0	-11.9	32.4	1.0	-43.3	-13.0	-30.3	
3.41	-63.2	V	3.0	-16.0	33.3	1.0	-48.3	-13.0	-35.3	
4.86	-64.0	V	3.0	-14.2	33.1	1.0	-46.3	-13.0	-33.3	
5.64	-62.4	V	3.0	-11.2	32.4	1.0	-42.6	-13.0	-29.6	
High Channel (1909.8MHz)										
3.13	-63.6	H	3.0	-17.3	33.1	1.0	-49.4	-13.0	-36.4	
4.11	-65.0	H	3.0	-16.0	33.6	1.0	-48.6	-13.0	-35.6	
5.73	-67.0	H	3.0	-15.4	32.3	1.0	-46.7	-13.0	-33.7	
2.96	-65.5	V	3.0	-19.6	33.1	1.0	-51.6	-13.0	-38.6	
4.35	-67.3	V	3.0	-18.1	33.5	1.0	-50.6	-13.0	-37.6	
5.73	-64.0	V	3.0	-12.6	32.3	1.0	-43.9	-13.0	-30.9	

Rev. 03.19.15

EGPRS, 1900MHz BAND 2

**High Frequency Substitution Measurement
 UL Fremont Radiated Chamber**

Company:
 Project #: 15U22428
 Date: 12/07/15
 Test Engineer: F. Guamero
 Configuration: EUT Only
 Mode: EGPRS 1900MHz

Test Equipment:
 Substitution: Horn T59 Substitution, and 8ft SMA Cable

Chamber

Pre-amplifier

Filter

Limit

3m Chamber D

3m Chamber D

Filter

EIRP

Frequency (GHz)	SA reading (dBm)	Ant. Pol. (H/V)	Distance	EIRP @ TX Ant End (dBm)	Preamp	Attenuator	EIRP	Limit	Delta	Notes
Low Channel (1850.2MHz)										
2.91	-61.9	H	3.0	-16.3	33.1	1.0	-48.5	-13.0	-35.5	
4.33	-62.7	H	3.0	-13.4	33.5	1.0	-45.9	-13.0	-32.9	
5.55	-67.9	H	3.0	-16.6	32.5	1.0	-48.1	-13.0	-35.1	
3.04	-64.6	V	3.0	-18.5	33.0	1.0	-50.5	-13.0	-37.5	
4.33	-65.4	V	3.0	-16.3	33.5	1.0	-48.7	-13.0	-35.7	
5.55	-68.1	V	3.0	-17.1	32.5	1.0	-48.5	-13.0	-35.5	
Mid Channel (1880.0)										
2.88	-61.3	H	3.0	-15.8	33.2	1.0	-48.0	-13.0	-35.0	
4.63	-62.7	H	3.0	-12.9	33.3	1.0	-45.1	-13.0	-32.1	
5.80	-67.1	H	3.0	-15.4	32.2	1.0	-46.6	-13.0	-33.6	
3.57	-65.0	V	3.0	-17.5	33.4	1.0	-49.9	-13.0	-36.9	
5.64	-64.7	V	3.0	-13.4	32.4	1.0	-44.8	-13.0	-31.8	
6.78	-67.7	V	3.0	-14.0	31.1	1.0	-44.2	-13.0	-31.2	
High Channel (1909.8MHz)										
2.94	-62.6	H	3.0	-16.9	33.1	1.0	-49.0	-13.0	-36.0	
4.56	-63.6	H	3.0	-14.0	33.3	1.0	-46.3	-13.0	-33.3	
6.26	-64.5	H	3.0	-11.9	31.7	1.0	-42.6	-13.0	-29.6	
2.95	-62.2	V	3.0	-16.3	33.1	1.0	-48.4	-13.0	-35.4	
4.36	-65.7	V	3.0	-16.5	33.5	1.0	-49.0	-13.0	-36.0	
5.73	-66.9	V	3.0	-15.5	32.3	1.0	-46.8	-13.0	-33.8	

Rev. 03.19.15

10.4.2. CDMA2000

CDMA2000 1xRTT, 850MHz BC0

High Frequency Substitution Measurement

UL Fremont Radiated Chamber

Company:
Project #: 15U22428
Date: 12/08/15
Test Engineer: F. Guamero
Configuration: EUT Only
Mode: 1xRTT 850MHz

Test Equipment:
Substitution: Horn T59 Substitution, and 8ft SMA Cable

Chamber

Pre-amplifier

Filter

Limit

3m Chamber D

3m Chamber D

Filter

EIRP

Frequency (GHz)	SA reading (dBm)	Ant. Pol. (H/V)	Distance	EIRP @ TX Ant End (dBm)	Preamp	Attenuator	EIRP	Limit	Delta	Notes
Low Channel (824.7MHz)										
1.65	-61.0	H	3.0	-19.2	35.0	1.0	-53.2	-13.0	-40.2	
3.96	-60.9	H	3.0	-12.2	33.7	1.0	-44.9	-13.0	-31.9	
5.69	-64.8	H	3.0	-13.3	32.3	1.0	-44.6	-13.0	-31.6	
1.65	-63.5	V	3.0	-21.5	35.0	1.0	-55.5	-13.0	-42.5	
3.96	-62.8	V	3.0	-14.2	33.7	1.0	-46.9	-13.0	-33.9	
5.74	-55.5	V	3.0	-4.1	32.3	1.0	-35.4	-13.0	-22.4	
Mid Channel (836.52MHz)										
1.77	-60.9	H	3.0	-18.7	35.0	1.0	-52.8	-13.0	-39.8	
2.65	-61.4	H	3.0	-16.7	33.5	1.0	-49.2	-13.0	-36.2	
5.49	-62.5	H	3.0	-11.3	32.5	1.0	-42.9	-13.0	-29.9	
1.77	-62.9	V	3.0	-20.6	35.0	1.0	-54.7	-13.0	-41.7	
2.65	-63.6	V	3.0	-18.7	33.5	1.0	-51.2	-13.0	-38.2	
5.49	-68.0	V	3.0	-17.1	32.5	1.0	-48.7	-13.0	-35.7	
High Channel (848.31MHz)										
1.70	-59.5	H	3.0	-17.5	35.0	1.0	-51.6	-13.0	-38.6	
2.55	-60.4	H	3.0	-15.9	33.7	1.0	-48.6	-13.0	-35.6	
4.80	-61.7	H	3.0	-11.6	33.1	1.0	-43.8	-13.0	-30.8	
1.70	-63.4	V	3.0	-21.3	35.0	1.0	-55.3	-13.0	-42.3	
2.55	-63.9	V	3.0	-19.2	33.7	1.0	-51.9	-13.0	-38.9	
4.75	-65.9	V	3.0	-16.2	33.2	1.0	-48.4	-13.0	-35.4	

Rev. 03.19.15

EVDO-Rev A, 850MHz BC0

High Frequency Substitution Measurement
UL Fremont Radiated Chamber

Company:
 Project #: 15U22428
 Date: 01/05/16
 Test Engineer: M. Hua
 Configuration: EUT Only
 Mode: Rev A 850MHz

Test Equipment:
 Substitution: Horn T59 Substitution, and 8ft SMA Cable

Chamber

Pre-amplifier

Filter

Limit

3m Chamber F

3m Chamber F

Filter

EIRP

Frequency (GHz)	SA reading (dBm)	Ant. Pol. (H/V)	Distance	EIRP @ TX Ant End (dBm)	Preamp	Attenuator	EIRP	Limit	Delta	Notes
Low Channel (824.7MHz)										
1.65	-57.3	H	3.0	-16.2	33.7	1.0	-48.9	-13.0	-35.9	
2.47	-56.8	H	3.0	-12.7	34.1	1.0	-45.8	-13.0	-32.8	
3.30	-60.6	H	3.0	-12.4	34.7	1.0	-46.0	-13.0	-33.0	
1.65	-59.5	V	3.0	-16.1	33.7	1.0	-48.8	-13.0	-35.8	
2.47	-60.1	V	3.0	-15.4	34.1	1.0	-48.5	-13.0	-35.5	
3.30	-60.3	V	3.0	-11.8	34.7	1.0	-45.5	-13.0	-32.5	
Mid Channel (836.52MHz)										
1.67	-57.9	H	3.0	-16.5	33.7	1.0	-49.2	-13.0	-36.2	
2.51	-58.3	H	3.0	-14.1	34.1	1.0	-47.2	-13.0	-34.2	
3.35	-59.5	H	3.0	-11.0	34.6	1.0	-44.7	-13.0	-31.7	
1.67	-62.0	V	3.0	-18.6	33.7	1.0	-51.3	-13.0	-38.3	
2.51	-63.4	V	3.0	-18.6	34.1	1.0	-51.7	-13.0	-38.7	
3.35	-65.2	V	3.0	-16.6	34.6	1.0	-50.2	-13.0	-37.2	
High Channel (848.31MHz)										
1.70	-55.3	H	3.0	-13.8	33.7	1.0	-46.5	-13.0	-33.5	
2.54	-57.5	H	3.0	-13.1	34.1	1.0	-46.3	-13.0	-33.3	
3.34	-58.7	H	3.0	-10.3	34.6	1.0	-43.9	-13.0	-30.9	
1.70	-60.1	V	3.0	-16.7	33.7	1.0	-49.4	-13.0	-36.4	
2.54	-62.0	V	3.0	-17.0	34.1	1.0	-50.1	-13.0	-37.1	
3.34	-65.5	V	3.0	-16.9	34.6	1.0	-50.5	-13.0	-37.5	

Rev. 03.19.15

CDMA2000 1xRTT, 1900MHz BC1

High Frequency Substitution Measurement
UL Fremont Radiated Chamber

Company:
Project #: 15U22428
Date: 12/08/15
Test Engineer: F. Guarnero
Configuration: EUT Only
Mode: 1xRTT 1900MHz

Test Equipment:
 Substitution: Horn T59 Substitution, and 8ft SMA Cable

Chamber

Pre-amplifier

Filter

Limit

3m Chamber D

3m Chamber D

Filter

EIRP

Frequency (GHz)	SA reading (dBm)	Ant. Pol. (H/V)	Distance	EIRP @ TX Ant End (dBm)	Preamp	Attenuator	EIRP	Limit	Delta	Notes
Low Channel (1851.25MHz)										
4.85	-64.4	H	3.0	-14.3	33.1	1.0	-46.4	-13.0	-33.4	
5.55	-64.6	H	3.0	-13.3	32.5	1.0	-44.8	-13.0	-31.8	
7.50	-69.0	H	3.0	-14.5	30.3	1.0	-43.8	-13.0	-30.8	
3.62	-66.0	V	3.0	-18.3	33.4	1.0	-50.7	-13.0	-37.7	
5.55	-65.8	V	3.0	-14.8	32.5	1.0	-46.3	-13.0	-33.3	
7.72	-67.2	V	3.0	-12.4	30.0	1.0	-41.4	-13.0	-28.4	
Mid Channel (1880MHz)										
2.72	-64.6	H	3.0	-19.6	33.4	1.0	-52.0	-13.0	-39.0	
3.76	-63.8	H	3.0	-15.7	33.5	1.0	-48.3	-13.0	-35.3	
5.45	-64.9	H	3.0	-13.8	32.6	1.0	-45.4	-13.0	-32.4	
3.76	-63.2	V	3.0	-15.1	33.5	1.0	-47.6	-13.0	-34.6	
5.64	-65.6	V	3.0	-14.4	32.4	1.0	-45.7	-13.0	-32.7	
6.57	-67.7	V	3.0	-14.5	31.4	1.0	-44.9	-13.0	-31.9	
High Channel (1908.75MHz)										
3.39	-62.9	H	3.0	-15.8	33.3	1.0	-48.1	-13.0	-35.1	
4.64	-62.9	H	3.0	-13.1	33.3	1.0	-45.4	-13.0	-32.4	
6.68	-65.0	H	3.0	-11.7	31.2	1.0	-41.9	-13.0	-28.9	
2.69	-65.5	V	3.0	-20.4	33.5	1.0	-52.9	-13.0	-39.9	
4.85	-66.0	V	3.0	-16.2	33.1	1.0	-48.3	-13.0	-35.3	
8.49	-67.3	V	3.0	-11.7	29.1	1.0	-39.8	-13.0	-26.8	

Rev. 03.19.15

EVDO-Rev A, 1900MHz BC1

High Frequency Substitution Measurement
UL Fremont Radiated Chamber

Company:
 Project #: 15U22428
 Date: 01/05/16
 Test Engineer: M. Hua
 Configuration: EUT Only
 Mode: Rev A 1900MHz

Test Equipment:
 Substitution: Horn T59 Substitution, and 8ft SMA Cable

Chamber

Pre-amplifier

Filter

Limit

3m Chamber F

3m Chamber F

Filter

EIRP

Frequency (GHz)	SA reading (dBm)	Ant. Pol. (H/V)	Distance	EIRP @ TX Ant End (dBm)	Preamp	Attenuator	EIRP	Limit	Delta	Notes
Low Channel (1851.25MHz)										
3.70	-57.3	H	3.0	-7.5	34.4	1.0	-41.0	-13.0	-28.0	
5.53	-59.5	H	3.0	-6.1	34.1	1.0	-39.2	-13.0	-26.2	
7.40	-64.4	H	3.0	-8.0	33.6	1.0	-40.6	-13.0	-27.6	
3.70	-60.1	V	3.0	-10.2	34.4	1.0	-43.7	-13.0	-30.7	
5.53	-63.8	V	3.0	-10.2	34.1	1.0	-43.3	-13.0	-30.3	
7.40	-67.4	V	3.0	-11.2	33.6	1.0	-43.9	-13.0	-30.9	
Mid Channel (1880MHz)										
3.76	-60.5	H	3.0	-10.5	34.4	1.0	-43.9	-13.0	-30.9	
5.64	-60.9	H	3.0	-7.3	34.1	1.0	-40.4	-13.0	-27.4	
7.52	-63.7	H	3.0	-7.2	33.5	1.0	-39.7	-13.0	-26.7	
3.76	-63.3	V	3.0	-13.2	34.4	1.0	-46.6	-13.0	-33.6	
5.64	-64.3	V	3.0	-10.6	34.1	1.0	-43.7	-13.0	-30.7	
7.52	-65.7	V	3.0	-9.4	33.5	1.0	-42.0	-13.0	-29.0	
High Channel (1908.75MHz)										
3.82	-60.8	H	3.0	-10.6	34.4	1.0	-44.0	-13.0	-31.0	
5.73	-61.4	H	3.0	-7.6	34.1	1.0	-40.7	-13.0	-27.7	
7.64	-63.1	H	3.0	-6.5	33.4	1.0	-38.9	-13.0	-25.9	
3.82	-62.3	V	3.0	-12.1	34.4	1.0	-45.4	-13.0	-32.4	
5.73	-63.2	V	3.0	-9.3	34.1	1.0	-42.4	-13.0	-29.4	
7.64	-67.5	V	3.0	-11.1	33.4	1.0	-43.5	-13.0	-30.5	

Rev. 03.19.15

CDMA2000 1xRTT, 1700MHz BC15

**High Frequency Substitution Measurement
 UL Fremont Radiated Chamber**

Company:
Project #: 15U22428
Date: 12/08/15
Test Engineer: F. Guamero
Configuration: EUT Only
Mode: 1xRTT 1700MHz

Test Equipment:
 Substitution: Horn T59 Substitution, and 8ft SMA Cable

Chamber	Pre-amplifier	Filter	Limit
3m Chamber D	3m Chamber D	Filter	EIRP

Frequency (GHz)	SA reading (dBm)	Ant. Pol. (H/V)	Distance	EIRP @ TX Ant End (dBm)	Preamp	Attenuator	EIRP	Limit	Delta	Notes
Low Channel (1711.25MHz)										
3.42	-57.0	H	3.0	-9.9	33.3	1.0	-42.2	-13.0	-29.2	
5.17	-58.4	H	3.0	-7.8	32.9	1.0	-39.6	-13.0	-26.6	
6.90	-60.7	H	3.0	-7.0	31.0	1.0	-37.0	-13.0	-24.0	
3.42	-57.0	V	3.0	-9.9	33.3	1.0	-42.2	-13.0	-29.2	
4.97	-60.3	V	3.0	-10.3	33.0	1.0	-42.4	-13.0	-29.4	
6.79	-67.5	V	3.0	-13.8	31.1	1.0	-43.9	-13.0	-30.9	
Mid Channel (1732.5MHz)										
3.46	-56.0	H	3.0	-8.8	33.3	1.0	-41.1	-13.0	-28.1	
4.32	-57.6	H	3.0	-8.3	33.5	1.0	-40.8	-13.0	-27.8	
6.75	-59.9	H	3.0	-6.5	31.2	1.0	-36.6	-13.0	-23.6	
3.50	-60.0	V	3.0	-12.6	33.4	1.0	-45.0	-13.0	-32.0	
5.31	-60.1	V	3.0	-9.5	32.7	1.0	-41.3	-13.0	-28.3	
6.45	-67.4	V	3.0	-14.5	31.5	1.0	-45.0	-13.0	-32.0	
High Channel (1753.75MHz)										
3.51	-59.6	H	3.0	-12.2	33.4	1.0	-44.6	-13.0	-31.6	
5.31	-60.6	H	3.0	-9.7	32.7	1.0	-41.4	-13.0	-28.4	
6.45	-65.3	H	3.0	-12.4	31.5	1.0	-42.9	-13.0	-29.9	
3.51	-61.0	V	3.0	-13.6	33.4	1.0	-45.9	-13.0	-32.9	
5.77	-62.1	V	3.0	-10.6	32.2	1.0	-41.9	-13.0	-28.9	
7.12	-68.6	V	3.0	-14.3	30.7	1.0	-44.1	-13.0	-31.1	

Rev. 03.19.15

EVDO-Rev A, 1700MHz BC15

High Frequency Substitution Measurement
UL Fremont Radiated Chamber

Company: 15U22428
 Project #: 15U22428
 Date: 01/05/16
 Test Engineer: F. Guarnero
 Configuration: EUT Only
 Mode: Rev A, 1700MHz

Test Equipment:
 Substitution: Horn T59 Substitution, and 8ft SMA Cable

Chamber

Pre-amplifier

Filter

Limit

3m Chamber F

3m Chamber F

Filter

EIRP

Frequency (GHz)	SA reading (dBm)	Ant. Pol. (H/V)	Distance	EIRP @ TX Ant End (dBm)	Preamp	Attenuator	EIRP	Limit	Delta	Notes
Low Channel (1711.25MHz)										
3.40	-60.3	H	3.0	-11.7	34.6	1.0	-45.3	-13.0	-32.3	
5.10	-60.3	H	3.0	-7.6	34.2	1.0	-40.8	-13.0	-27.8	
6.80	-61.1	H	3.0	-5.7	33.9	1.0	-38.6	-13.0	-25.6	
3.40	-62.0	V	3.0	-13.2	34.6	1.0	-46.8	-13.0	-33.8	
5.10	-62.6	V	3.0	-9.6	34.2	1.0	-42.8	-13.0	-29.8	
6.80	-65.4	V	3.0	-10.1	33.9	1.0	-43.0	-13.0	-30.0	
Mid Channel (1732.5MHz)										
3.46	-60.5	H	3.0	-11.6	34.6	1.0	-45.2	-13.0	-32.2	
5.20	-61.4	H	3.0	-8.5	34.2	1.0	-41.7	-13.0	-28.7	
6.93	-62.3	H	3.0	-6.7	33.9	1.0	-39.6	-13.0	-26.6	
3.46	-63.3	V	3.0	-14.3	34.6	1.0	-47.8	-13.0	-34.8	
5.20	-64.5	V	3.0	-11.3	34.2	1.0	-44.5	-13.0	-31.5	
6.93	-66.0	V	3.0	-10.5	33.9	1.0	-43.5	-13.0	-30.5	
High Channel (1753.75MHz)										
3.51	-59.4	H	3.0	-10.4	34.5	1.0	-43.9	-13.0	-30.9	
5.26	-60.6	H	3.0	-7.6	34.2	1.0	-40.8	-13.0	-27.8	
7.01	-61.9	H	3.0	-6.1	33.9	1.0	-39.0	-13.0	-26.0	
3.51	-64.0	V	3.0	-14.8	34.5	1.0	-48.3	-13.0	-35.3	
5.26	-63.0	V	3.0	-9.8	34.2	1.0	-42.9	-13.0	-29.9	
7.01	-65.5	V	3.0	-9.9	33.9	1.0	-42.8	-13.0	-29.8	

Rev. 03.19.15

CDMA2000 1xRTT, 800MHz BC10

**High Frequency Substitution Measurement
 UL Fremont Radiated Chamber**

Company:
Project #: 15U22428
Date: 12/08/15
Test Engineer: F. Guarnero
Configuration: EUT Only
Mode: 1xRTT 800MHz

Test Equipment:
 Substitution: Horn T59 Substitution, and 8ft SMA Cable

Chamber	Pre-amplifier	Filter	Limit
3m Chamber D	3m Chamber D	Filter	EIRP

Frequency (GHz)	SA reading (dBm)	Ant. Pol. (H/V)	Distance	EIRP @ TX Ant End (dBm)	Preamp	Attenuator	EIRP	Limit	Delta	Notes
Low Channel (817.25MHz)										
2.55	-60.2	H	3.0	-15.8	33.7	1.0	-48.4	-13.0	-35.4	
4.78	-63.6	H	3.0	-13.6	33.2	1.0	-45.8	-13.0	-32.8	
6.85	-63.3	H	3.0	-9.7	31.1	1.0	-39.7	-13.0	-26.7	
2.55	-64.7	V	3.0	-20.0	33.7	1.0	-52.7	-13.0	-39.7	
4.18	-65.3	V	3.0	-16.3	33.6	1.0	-48.9	-13.0	-35.9	
5.63	-65.7	V	3.0	-14.5	32.4	1.0	-45.9	-13.0	-32.9	
Mid Channel (820MHz)										
1.33	-60.6	H	3.0	-20.1	34.7	1.0	-53.8	-13.0	-40.8	
4.13	-61.3	H	3.0	-12.3	33.6	1.0	-44.9	-13.0	-31.9	
8.50	-68.8	H	3.0	-13.1	29.1	1.0	-41.2	-13.0	-28.2	
1.98	-61.4	V	3.0	-18.7	35.1	1.0	-52.8	-13.0	-39.8	
5.15	-63.1	V	3.0	-12.9	32.9	1.0	-44.8	-13.0	-31.8	
6.90	-64.3	V	3.0	-10.4	31.0	1.0	-40.4	-13.0	-27.4	
High Channel (822.75MHz)										
1.27	-60.5	H	3.0	-20.3	34.6	1.0	-53.9	-13.0	-40.9	
5.63	-61.2	H	3.0	-9.8	32.4	1.0	-41.2	-13.0	-28.2	
7.91	-66.2	H	3.0	-11.2	29.8	1.0	-40.0	-13.0	-27.0	
1.37	-63.3	V	3.0	-22.4	34.8	1.0	-56.1	-13.0	-43.1	
3.80	-65.8	V	3.0	-17.6	33.6	1.0	-50.1	-13.0	-37.1	
6.50	-67.9	V	3.0	-14.8	31.4	1.0	-45.3	-13.0	-32.3	

Rev. 03.19.15

EVDO-Rev A, 800MHz BC10

High Frequency Substitution Measurement
UL Fremont Radiated Chamber

Company:
 Project #: 15U22428
 Date: 01/05/16
 Test Engineer: F. Guarnero
 Configuration: EUT Only
 Mode: Rev A, 800MHz

Test Equipment:
 Substitution: Horn T59 Substitution, and 8ft SMA Cable

Chamber

Pre-amplifier

Filter

Limit

3m Chamber F

3m Chamber F

Filter

EIRP

Frequency (GHz)	SA reading (dBm)	Ant. Pol. (H/V)	Distance	EIRP @ TX Ant End (dBm)	Preamp	Attenuator	EIRP	Limit	Delta	Notes
Low Channel (817.25MHz)										
1.78	-60.5	H	3.0	-18.4	33.6	1.0	-51.0	-13.0	-38.0	
3.41	-60.4	H	3.0	-11.7	34.6	1.0	-45.3	-13.0	-32.3	
6.17	-63.1	H	3.0	-8.7	34.0	1.0	-41.7	-13.0	-28.7	
1.15	-60.4	V	3.0	-20.3	34.6	1.0	-53.9	-13.0	-40.9	
3.00	-62.4	V	3.0	-14.9	34.8	1.0	-48.8	-13.0	-35.8	
6.53	-63.5	V	3.0	-8.6	34.0	1.0	-41.5	-13.0	-28.5	
Mid Channel (820MHz)										
1.20	-59.4	H	3.0	-20.7	34.5	1.0	-54.2	-13.0	-41.2	
4.51	-60.1	H	3.0	-8.4	34.2	1.0	-41.6	-13.0	-28.6	
7.59	-61.6	H	3.0	-5.0	33.5	1.0	-37.4	-13.0	-24.4	
1.53	-62.3	V	3.0	-19.0	33.8	1.0	-51.8	-13.0	-38.8	
3.02	-62.6	V	3.0	-15.1	34.8	1.0	-48.9	-13.0	-35.9	
4.72	-64.0	V	3.0	-11.7	34.2	1.0	-45.0	-13.0	-32.0	
High Channel (822.75MHz)										
1.15	-59.3	H	3.0	-20.8	34.6	1.0	-54.4	-13.0	-41.4	
4.75	-60.6	H	3.0	-8.5	34.2	1.0	-41.7	-13.0	-28.7	
7.48	-68.2	H	3.0	-11.8	33.5	1.0	-44.3	-13.0	-31.3	
1.84	-62.8	V	3.0	-19.3	33.6	1.0	-51.9	-13.0	-38.9	
3.39	-63.0	V	3.0	-14.2	34.6	1.0	-47.8	-13.0	-34.8	
4.43	-65.2	V	3.0	-13.5	34.2	1.0	-46.7	-13.0	-33.7	

Rev. 03.19.15

10.4.3. UMTS

UMTS REL 99, 850MHz BAND 5

High Frequency Substitution Measurement

UL Fremont Radiated Chamber

Company:
Project #: 15U22428
Date: 12/07/15
Test Engineer: F. Guarnero
Configuration: EUT Only
Mode: REL 99, 850MHz

Test Equipment:
 Substitution: Horn T59 Substitution, and 8ft SMA Cable

Chamber
 3m Chamber D

Pre-amplifier
 3m Chamber D

Filter
 Filter

Limit
 EIRP

Frequency (GHz)	SA reading (dBm)	Ant. Pol. (H/V)	Distance	EIRP @ TX Ant End (dBm)	Preamp	Attenuator	EIRP	Limit	Delta	Notes
Low Channel (826.4MHz)										
1.08	-58.4	H	3.0	-19.1	34.2	1.0	-52.3	-13.0	-39.3	
3.89	-61.0	H	3.0	-12.5	33.6	1.0	-45.1	-13.0	-32.1	
4.75	-60.3	H	3.0	-10.3	33.2	1.0	-42.5	-13.0	-29.5	
1.18	-61.3	V	3.0	-21.5	34.4	1.0	-54.9	-13.0	-41.9	
2.42	-64.1	V	3.0	-20.0	34.3	1.0	-53.3	-13.0	-40.3	
4.47	-64.3	V	3.0	-15.0	33.4	1.0	-47.3	-13.0	-34.3	
Mid Channel (836.6MHz)										
1.73	-59.5	H	3.0	-17.4	35.0	1.0	-51.5	-13.0	-38.5	
4.27	-60.6	H	3.0	-11.4	33.5	1.0	-43.9	-13.0	-30.9	
6.76	-67.1	H	3.0	-13.7	31.2	1.0	-43.8	-13.0	-30.8	
1.74	-62.7	V	3.0	-20.5	35.0	1.0	-54.5	-13.0	-41.5	
2.96	-64.6	V	3.0	-18.7	33.1	1.0	-50.7	-13.0	-37.7	
5.08	-66.0	V	3.0	-15.9	32.9	1.0	-47.8	-13.0	-34.8	
High Channel (846.6MHz)										
1.08	-57.0	H	3.0	-17.7	34.2	1.0	-50.9	-13.0	-37.9	
2.29	-57.4	H	3.0	-13.9	34.6	1.0	-47.5	-13.0	-34.5	
4.76	-59.4	H	3.0	-9.4	33.2	1.0	-41.6	-13.0	-28.6	
1.12	-60.0	V	3.0	-20.6	34.3	1.0	-53.9	-13.0	-40.9	
2.65	-62.3	V	3.0	-17.4	33.5	1.0	-49.9	-13.0	-36.9	
5.13	-67.0	V	3.0	-16.8	32.9	1.0	-48.7	-13.0	-35.7	

Rev. 03.19.15

UMTS HSDPA, 850MHz BAND 5

High Frequency Substitution Measurement
UL Fremont Radiated Chamber

Company:
Project #: 15U22428
Date: 12/08/15
Test Engineer: F. Guamero
Configuration: EUT Only
Mode: HSDPA 850MHz

Test Equipment:
 Substitution: Horn T59 Substitution, and 8ft SMA Cable

Chamber

3m Chamber D

Pre-amplifier

3m Chamber D

Filter

Filter

Limit

EIRP

Frequency (GHz)	SA reading (dBm)	Ant. Pol. (H/V)	Distance	EIRP @ TX Ant End (dBm)	Preamp	Attenuator	EIRP	Limit	Delta	Notes
Low Channel (826.4MHz)										
1.55	-60.3	H	3.0	-18.8	35.0	1.0	-52.8	-13.0	-39.8	
3.34	-60.2	H	3.0	-13.4	33.3	1.0	-45.6	-13.0	-32.6	
5.80	-62.1	H	3.0	-10.4	32.2	1.0	-41.6	-13.0	-28.6	
1.19	-60.8	V	3.0	-20.9	34.4	1.0	-54.3	-13.0	-41.3	
3.62	-63.7	V	3.0	-16.0	33.4	1.0	-48.5	-13.0	-35.5	
4.50	-67.1	V	3.0	-17.8	33.4	1.0	-50.1	-13.0	-37.1	
Mid Channel (836.6MHz)										
1.15	-59.1	H	3.0	-19.5	34.4	1.0	-52.8	-13.0	-39.8	
3.36	-60.9	H	3.0	-14.0	33.3	1.0	-46.2	-13.0	-33.2	
5.81	-65.4	H	3.0	-13.7	32.2	1.0	-44.9	-13.0	-31.9	
1.14	-61.6	V	3.0	-22.1	34.3	1.0	-55.4	-13.0	-42.4	
3.63	-62.6	V	3.0	-14.8	33.5	1.0	-47.3	-13.0	-34.3	
5.36	-66.2	V	3.0	-15.6	32.7	1.0	-47.3	-13.0	-34.3	
High Channel (846.6MHz)										
1.29	-59.8	H	3.0	-19.4	34.6	1.0	-53.0	-13.0	-40.0	
3.58	-60.1	H	3.0	-12.5	33.4	1.0	-44.9	-13.0	-31.9	
6.65	-62.8	H	3.0	-9.6	31.3	1.0	-39.8	-13.0	-26.8	
1.68	-61.5	V	3.0	-19.5	35.0	1.0	-53.5	-13.0	-40.5	
3.89	-62.3	V	3.0	-13.8	33.6	1.0	-46.5	-13.0	-33.5	
5.16	-64.6	V	3.0	-14.4	32.9	1.0	-46.3	-13.0	-33.3	

Rev. 03.19.15

UMTS REL 99, 1900MHz BAND 2

**High Frequency Substitution Measurement
 UL Fremont Radiated Chamber**

Company:
Project #: 15U22428
Date: 12/07/15
Test Engineer: F. Guarnero
Configuration: EUT Only
Mode: REL 99, 1900MHz

Test Equipment:
 Substitution: Horn T59 Substitution, and 8ft SMA Cable

Chamber	Pre-amplifier	Filter	Limit
3m Chamber D	3m Chamber D	Filter	EIRP

Frequency (GHz)	SA reading (dBm)	Ant. Pol. (H/V)	Distance	EIRP @ TX Ant End (dBm)	Preamp	Attenuator	EIRP	Limit	Delta	Notes
Low Channel (1852.4MHz)										
2.95	-60.8	H	3.0	-15.1	33.1	1.0	-47.2	-13.0	-34.2	
4.58	-60.5	H	3.0	-10.8	33.3	1.0	-43.1	-13.0	-30.1	
6.06	-65.2	H	3.0	-13.0	31.9	1.0	-43.9	-13.0	-30.9	
2.96	-61.7	V	3.0	-15.7	33.1	1.0	-47.8	-13.0	-34.8	
4.02	-62.9	V	3.0	-14.1	33.7	1.0	-46.8	-13.0	-33.8	
5.45	-67.5	V	3.0	-16.7	32.6	1.0	-46.3	-13.0	-35.3	
Mid Channel (1880MHz)										
3.35	-60.9	H	3.0	-14.0	33.3	1.0	-46.2	-13.0	-33.2	
4.38	-60.5	H	3.0	-11.1	33.4	1.0	-43.5	-13.0	-30.5	
6.44	-64.3	H	3.0	-11.4	31.5	1.0	-41.9	-13.0	-28.9	
3.01	-62.8	V	3.0	-16.7	33.0	1.0	-48.7	-13.0	-35.7	
4.23	-62.9	V	3.0	-13.9	33.5	1.0	-46.4	-13.0	-33.4	
5.72	-67.3	V	3.0	-15.9	32.3	1.0	-47.2	-13.0	-34.2	
High Channel (1907.6MHz)										
3.82	-58.2	H	3.0	-9.9	33.6	1.0	-42.5	-13.0	-29.5	
4.87	-59.2	H	3.0	-9.0	33.1	1.0	-41.1	-13.0	-28.1	
7.25	-65.6	H	3.0	-11.4	30.6	1.0	-41.0	-13.0	-28.0	
2.68	-60.6	V	3.0	-15.6	33.5	1.0	-48.1	-13.0	-35.1	
3.82	-61.4	V	3.0	-13.1	33.6	1.0	-45.7	-13.0	-32.7	
4.95	-67.5	V	3.0	-17.6	33.0	1.0	-49.6	-13.0	-36.6	

Rev. 03.19.15

UMTS HSDPA, 1900MHz BAND 2

High Frequency Substitution Measurement
UL Fremont Radiated Chamber

Company:
Project #: 15U22428
Date: 12/08/15
Test Engineer: F. Guamero
Configuration: EUT Only
Mode: HSDPA 1900MHz

Test Equipment:
 Substitution: Horn T59 Substitution, and 8ft SMA Cable

Chamber

Pre-amplifier

Filter

Limit

3m Chamber D

3m Chamber D

Filter

EIRP

Frequency (GHz)	SA reading (dBm)	Ant. Pol. (H/V)	Distance	EIRP @ TX Ant End (dBm)	Preamp	Attenuator	EIRP	Limit	Delta	Notes
Low Channel (1852.4MHz)										
3.32	-59.3	H	3.0	-12.5	33.2	1.0	-44.7	-13.0	-31.7	
4.41	-59.1	H	3.0	-9.7	33.4	1.0	-42.1	-13.0	-29.1	
6.15	-60.0	H	3.0	-7.7	31.8	1.0	-38.5	-13.0	-25.5	
2.62	-62.6	V	3.0	-17.7	33.6	1.0	-50.3	-13.0	-37.3	
3.71	-63.6	V	3.0	-15.6	33.5	1.0	-48.1	-13.0	-35.1	
5.82	-66.9	V	3.0	-15.3	32.2	1.0	-46.5	-13.0	-33.5	
Mid Channel (1880MHz)										
2.90	-59.5	H	3.0	-13.9	33.2	1.0	-46.1	-13.0	-33.1	
4.38	-60.4	H	3.0	-11.0	33.4	1.0	-43.4	-13.0	-30.4	
5.72	-62.8	H	3.0	-11.2	32.3	1.0	-42.5	-13.0	-29.5	
2.90	-62.0	V	3.0	-16.3	33.2	1.0	-48.4	-13.0	-35.4	
3.76	-63.2	V	3.0	-15.1	33.5	1.0	-47.7	-13.0	-34.7	
4.83	-67.8	V	3.0	-18.0	33.1	1.0	-50.2	-13.0	-37.2	
High Channel (1907.6MHz)										
3.16	-59.3	H	3.0	-13.0	33.1	1.0	-45.1	-13.0	-32.1	
4.02	-60.3	H	3.0	-11.4	33.7	1.0	-44.1	-13.0	-31.1	
6.35	-63.0	H	3.0	-10.3	31.6	1.0	-40.9	-13.0	-27.9	
2.94	-61.0	V	3.0	-15.2	33.1	1.0	-47.3	-13.0	-34.3	
3.82	-63.5	V	3.0	-15.3	33.6	1.0	-47.8	-13.0	-34.8	
4.85	-65.9	V	3.0	-16.1	33.1	1.0	-48.2	-13.0	-35.2	

Rev. 03.19.15

UMTS REL 99, 1700MHz BAND 4

**High Frequency Substitution Measurement
 UL Fremont Radiated Chamber**

Company:
Project #: 15U22428
Date: 12/07/15
Test Engineer: F. Guarnero
Configuration: EUT Only
Mode: REL 99, 1700MHz

Test Equipment:
 Substitution: Horn T59 Substitution, and 8ft SMA Cable

Chamber	Pre-amplifier	Filter	Limit
3m Chamber D	3m Chamber D	Filter	EIRP

Frequency (GHz)	SA reading (dBm)	Ant. Pol. (H/V)	Distance	EIRP @ TX Ant End (dBm)	Preamp	Attenuator	EIRP	Limit	Delta	Notes
Low Channel (1712.4MHz)										
3.42	-57.8	H	3.0	-10.7	33.3	1.0	-43.0	-13.0	-30.0	
5.51	-61.0	H	3.0	-9.7	32.5	1.0	-41.3	-13.0	-28.3	
7.12	-61.4	H	3.0	-7.4	30.7	1.0	-37.2	-13.0	-24.2	
3.43	-61.0	V	3.0	-13.8	33.3	1.0	-46.1	-13.0	-33.1	
4.85	-64.3	V	3.0	-14.5	33.1	1.0	-46.6	-13.0	-33.6	
5.81	-66.7	V	3.0	-15.1	32.2	1.0	-46.3	-13.0	-33.3	
Mid Channel (1732.6MHz)										
3.47	-58.5	H	3.0	-11.2	33.3	1.0	-43.6	-13.0	-30.6	
5.47	-60.2	H	3.0	-9.0	32.6	1.0	-40.6	-13.0	-27.6	
7.11	-64.9	H	3.0	-10.9	30.8	1.0	-40.7	-13.0	-27.7	
3.47	-61.1	V	3.0	-13.8	33.3	1.0	-46.1	-13.0	-33.1	
4.84	-62.6	V	3.0	-12.8	33.1	1.0	-44.9	-13.0	-31.9	
7.16	-66.6	V	3.0	-12.3	30.7	1.0	-42.0	-13.0	-29.0	
High Channel (1752.6MHz)										
3.51	-59.6	H	3.0	-12.2	33.4	1.0	-44.6	-13.0	-31.6	
4.37	-61.4	H	3.0	-12.0	33.4	1.0	-44.5	-13.0	-31.5	
6.48	-64.3	H	3.0	-11.4	31.5	1.0	-41.8	-13.0	-28.8	
3.50	-60.2	V	3.0	-12.8	33.4	1.0	-45.2	-13.0	-32.2	
4.91	-64.1	V	3.0	-14.2	33.1	1.0	-46.3	-13.0	-33.3	
6.20	-66.6	V	3.0	-14.2	31.8	1.0	-44.9	-13.0	-31.9	

Rev. 03.19.15

UMTS HSDPA, 1700MHz BAND 4

**High Frequency Substitution Measurement
 UL Fremont Radiated Chamber**

Company:
Project #: 15U22428
Date: 12/08/15
Test Engineer: F. Guarnero
Configuration: EUT Only
Mode: HSDPA 1700MHz

Test Equipment:
 Substitution: Horn T59 Substitution, and 8ft SMA Cable

Chamber	Pre-amplifier	Filter	Limit
3m Chamber D	3m Chamber D	Filter	EIRP

Frequency (GHz)	SA reading (dBm)	Ant. Pol. (H/V)	Distance	EIRP @ TX Ant End (dBm)	Preamp	Attenuator	EIRP	Limit	Delta	Notes
Low Channel (1712.4MHz)										
3.42	-59.4	H	3.0	-12.3	33.3	1.0	-44.6	-13.0	-31.6	
4.89	-60.0	H	3.0	-9.8	33.1	1.0	-41.9	-13.0	-28.9	
6.06	-62.4	H	3.0	-10.2	31.9	1.0	-41.1	-13.0	-28.1	
3.42	-59.9	V	3.0	-12.7	33.3	1.0	-45.0	-13.0	-32.0	
4.42	-63.2	V	3.0	-13.9	33.4	1.0	-46.3	-13.0	-33.3	
5.26	-67.1	V	3.0	-16.7	32.8	1.0	-48.5	-13.0	-35.5	
Mid Channel (1732.6MHz)										
3.47	-60.4	H	3.0	-13.2	33.3	1.0	-45.5	-13.0	-32.5	
5.19	-61.5	H	3.0	-10.8	32.9	1.0	-42.7	-13.0	-29.7	
6.47	-60.4	H	3.0	-7.5	31.5	1.0	-38.0	-13.0	-25.0	
3.47	-62.9	V	3.0	-15.5	33.3	1.0	-47.9	-13.0	-34.9	
5.01	-64.4	V	3.0	-14.4	33.0	1.0	-46.4	-13.0	-33.4	
6.17	-65.0	V	3.0	-12.6	31.8	1.0	-43.4	-13.0	-30.4	
High Channel (1752.6MHz)										
2.75	-59.6	H	3.0	-14.5	33.4	1.0	-46.9	-13.0	-33.9	
3.50	-61.8	H	3.0	-14.5	33.4	1.0	-46.8	-13.0	-33.8	
4.92	-64.6	H	3.0	-14.3	33.1	1.0	-46.4	-13.0	-33.4	
2.75	-61.5	V	3.0	-16.2	33.4	1.0	-48.6	-13.0	-35.6	
3.50	-63.6	V	3.0	-16.2	33.4	1.0	-48.6	-13.0	-35.6	
4.92	-67.9	V	3.0	-18.0	33.1	1.0	-50.1	-13.0	-37.1	

Rev. 03.19.15

10.5. FIELD STRENGTH OF SPURIOUS RADIATION (ANTENNA - D)

10.5.1. GSM

GPRS, 850MHz BAND 5

High Frequency Substitution Measurement
 UL Fremont Radiated Chamber

Company:
Project #: 15U22428
Date: 12/09/15
Test Engineer: F. Guarnero
Configuration: EUT Only
Mode: GPRS 850MHz

Test Equipment:
 Substitution: Horn T59 Substitution, and 8ft SMA Cable

Chamber

3m Chamber D

Pre-amplifier

3m Chamber D

Filter

Filter

Limit

EIRP

Frequency (GHz)	SA reading (dBm)	Ant. Pol. (H/V)	Distance	EIRP @ TX Ant End (dBm)	Preamp	Attenuator	EIRP	Limit	Delta	Notes
Low Channel (824.2MHz)										
1.64	-53.5	H	3.0	-11.7	35.0	1.0	-45.8	-13.0	-32.8	
2.47	-64.3	H	3.0	-20.2	33.9	1.0	-53.1	-13.0	-40.1	
4.96	-67.1	H	3.0	-16.8	33.0	1.0	-48.8	-13.0	-35.8	
1.64	-53.0	V	3.0	-11.0	35.0	1.0	-45.0	-13.0	-32.0	
2.47	-65.8	V	3.0	-21.4	33.9	1.0	-54.4	-13.0	-41.4	
4.96	-71.2	V	3.0	-21.3	33.0	1.0	-53.3	-13.0	-40.3	
Mid Channel (836.6MHz)										
1.67	-52.2	H	3.0	-10.3	35.0	1.0	-44.4	-13.0	-31.4	
2.51	-62.4	H	3.0	-18.1	33.7	1.0	-50.8	-13.0	-37.8	
6.60	-69.2	H	3.0	-16.0	31.3	1.0	-46.4	-13.0	-33.4	
1.67	-56.1	V	3.0	-14.1	35.0	1.0	-48.1	-13.0	-35.1	
2.51	-64.4	V	3.0	-19.9	33.7	1.0	-52.6	-13.0	-39.6	
5.06	-68.3	V	3.0	-18.2	33.0	1.0	-50.1	-13.0	-37.1	
High Channel (848.8MHz)										
1.70	-56.3	H	3.0	-14.3	35.0	1.0	-48.3	-13.0	-35.3	
2.54	-63.7	H	3.0	-19.3	33.7	1.0	-52.0	-13.0	-39.0	
6.12	-68.4	H	3.0	-16.1	31.9	1.0	-47.0	-13.0	-34.0	
1.70	-59.3	V	3.0	-17.2	35.0	1.0	-51.2	-13.0	-38.2	
2.54	-64.5	V	3.0	-19.9	33.7	1.0	-52.6	-13.0	-39.6	
5.38	-68.8	V	3.0	-18.2	32.7	1.0	-49.8	-13.0	-36.8	

Rev. 03.19.15

EGPRS, 850MHz BAND 5

High Frequency Substitution Measurement UL Fremont Radiated Chamber

Company:
Project #: 15U22428
Date: 12/09/15
Test Engineer: F. Guarnero
Configuration: EUT Only
Mode: EGPRS 850MHz

Test Equipment:
 Substitution: Horn T59 Substitution, and 8ft SMA Cable

Chamber
 3m Chamber D

Pre-amplifier
 3m Chamber D

Filter
 Filter

Limit
 EIRP

Frequency (GHz)	SA reading (dBm)	Ant. Pol. (H/V)	Distance	EIRP @ TX Ant End (dBm)	Preamp	Attenuator	EIRP	Limit	Delta	Notes
Low Channel (824.2MHz)										
1.64	-56.2	H	3.0	-14.5	35.0	1.0	-48.5	-13.0	-35.5	
5.84	-67.8	H	3.0	-16.0	32.2	1.0	-47.2	-13.0	-34.2	
7.64	-69.8	H	3.0	-15.2	30.1	1.0	-44.3	-13.0	-31.3	
1.64	-61.5	V	3.0	-19.5	35.0	1.0	-53.5	-13.0	-40.5	
4.26	-67.0	V	3.0	-17.9	33.5	1.0	-50.4	-13.0	-37.4	
6.95	-69.7	V	3.0	-15.7	30.9	1.0	-45.6	-13.0	-32.6	
Mid Channel (836.6MHz)										
1.67	-59.0	H	3.0	-17.1	35.0	1.0	-51.2	-13.0	-38.2	
2.51	-58.3	H	3.0	-14.0	33.7	1.0	-46.8	-13.0	-33.8	
5.63	-67.9	H	3.0	-16.5	32.4	1.0	-47.9	-13.0	-34.9	
1.67	-55.1	V	3.0	-13.0	35.0	1.0	-47.1	-13.0	-34.1	
2.06	-57.7	V	3.0	-14.7	35.0	1.0	-48.7	-13.0	-35.7	
2.51	-59.5	V	3.0	-15.0	33.7	1.0	-47.7	-13.0	-34.7	
High Channel (848.8MHz)										
1.70	-55.8	H	3.0	-13.8	35.0	1.0	-47.8	-13.0	-34.8	
2.54	-57.6	H	3.0	-13.2	33.7	1.0	-45.9	-13.0	-32.9	
4.51	-67.5	H	3.0	-17.9	33.3	1.0	-50.2	-13.0	-37.2	
1.70	-57.5	V	3.0	-15.4	35.0	1.0	-49.4	-13.0	-36.4	
2.54	-56.2	V	3.0	-11.6	33.7	1.0	-44.3	-13.0	-31.3	
3.70	-66.7	V	3.0	-18.8	33.5	1.0	-51.3	-13.0	-38.3	

Rev. 03.19.15

GPRS, 1900MHz BAND 2

High Frequency Substitution Measurement
UL Fremont Radiated Chamber

Company:
 Project #: 15U22428
 Date: 12/09/15
 Test Engineer: F. Guamero
 Configuration: EUT Only
 Mode: GPRS 1900MHz

Test Equipment:
 Substitution: Horn T59 Substitution, and 8ft SMA Cable

Chamber

Pre-amplifier

Filter

Limit

3m Chamber D

3m Chamber D

Filter

EIRP

Frequency (GHz)	SA reading (dBm)	Ant. Pol. (H/V)	Distance	EIRP @ TX Ant End (dBm)	Preamp	Attenuator	EIRP	Limit	Delta	Notes
Low Channel (1850.2MHz)										
3.14	-67.2	H	3.0	-20.8	33.1	1.0	-53.0	-13.0	-40.0	
6.80	-69.3	H	3.0	-15.8	31.1	1.0	-45.9	-13.0	-32.9	
9.16	-71.1	H	3.0	-14.6	28.3	1.0	-41.8	-13.0	-28.8	
3.70	-66.3	V	3.0	-18.4	33.5	1.0	-50.9	-13.0	-37.9	
4.89	-67.6	V	3.0	-17.8	33.1	1.0	-49.8	-13.0	-36.8	
7.55	-69.6	V	3.0	-14.9	30.2	1.0	-44.1	-13.0	-31.1	
Mid Channel (1880.0)										
3.72	-66.6	H	3.0	-18.6	33.5	1.0	-51.1	-13.0	-38.1	
5.80	-68.4	H	3.0	-16.7	32.2	1.0	-47.9	-13.0	-34.9	
8.90	-71.0	H	3.0	-14.8	28.6	1.0	-42.4	-13.0	-29.4	
4.60	-67.6	V	3.0	-18.1	33.3	1.0	-50.4	-13.0	-37.4	
6.85	-69.6	V	3.0	-15.7	31.1	1.0	-45.8	-13.0	-32.8	
8.48	-70.7	V	3.0	-15.2	29.1	1.0	-43.3	-13.0	-30.3	
High Channel (1909.8MHz)										
3.65	-66.7	H	3.0	-18.9	33.5	1.0	-51.4	-13.0	-38.4	
6.28	-68.6	H	3.0	-16.1	31.7	1.0	-46.7	-13.0	-33.7	
9.11	-71.3	H	3.0	-14.8	28.3	1.0	-42.1	-13.0	-29.1	
3.69	-66.4	V	3.0	-18.5	33.5	1.0	-51.0	-13.0	-38.0	
7.72	-69.9	V	3.0	-15.0	30.0	1.0	-44.1	-13.0	-31.1	
9.13	-71.6	V	3.0	-15.4	28.3	1.0	-42.7	-13.0	-29.7	

Rev. 03.19.15

EGPRS, 1900MHz BAND 2

**High Frequency Substitution Measurement
 UL Fremont Radiated Chamber**

Company:
Project #: 15U22428
Date: 12/09/15
Test Engineer: F. Guarnero
Configuration: EUT Only
Mode: EGPRS 1900MHz

Test Equipment:
 Substitution: Horn T59 Substitution, and 8ft SMA Cable

Chamber

Pre-amplifier

Filter

Limit

3m Chamber D

3m Chamber D

Filter

EIRP

Frequency (GHz)	SA reading (dBm)	Ant. Pol. (H/V)	Distance	EIRP @ TX Ant End (dBm)	Preamp	Attenuator	EIRP	Limit	Delta	Notes
Low Channel (1850.2MHz)										
3.74	-66.9	H	3.0	-18.8	33.5	1.0	-51.4	-13.0	-38.4	
5.55	-68.7	H	3.0	-17.5	32.5	1.0	-48.9	-13.0	-35.9	
8.07	-71.9	H	3.0	-16.7	29.6	1.0	-45.3	-13.0	-32.3	
3.72	-66.6	V	3.0	-18.6	33.5	1.0	-51.2	-13.0	-38.2	
4.85	-67.4	V	3.0	-17.6	33.1	1.0	-49.7	-13.0	-36.7	
7.54	-70.1	V	3.0	-15.4	30.2	1.0	-44.6	-13.0	-31.6	
Mid Channel (1880.0)										
3.70	-66.3	H	3.0	-18.3	33.5	1.0	-50.8	-13.0	-37.8	
4.93	-67.7	H	3.0	-17.4	33.1	1.0	-49.5	-13.0	-36.5	
9.18	-71.1	H	3.0	-14.6	28.2	1.0	-41.8	-13.0	-28.8	
2.61	-67.0	V	3.0	-22.2	33.6	1.0	-54.8	-13.0	-41.8	
7.01	-69.7	V	3.0	-15.5	30.9	1.0	-45.4	-13.0	-32.4	
9.18	-71.7	V	3.0	-15.5	28.2	1.0	-42.7	-13.0	-29.7	
High Channel (1909.8MHz)										
3.70	-66.6	H	3.0	-18.6	33.5	1.0	-51.1	-13.0	-38.1	
7.44	-69.6	H	3.0	-15.3	30.4	1.0	-44.6	-13.0	-31.6	
9.60	-71.5	H	3.0	-14.4	27.7	1.0	-41.1	-13.0	-28.1	
5.17	-68.2	V	3.0	-18.0	32.9	1.0	-49.8	-13.0	-36.8	
8.12	-70.7	V	3.0	-15.5	29.5	1.0	-44.0	-13.0	-31.0	
9.60	-71.9	V	3.0	-15.3	27.7	1.0	-42.0	-13.0	-29.0	

Rev. 03.19.15

10.5.2. CDMA2000

CDMA2000 1xRTT, 850MHz BC0

High Frequency Substitution Measurement
UL Fremont Radiated Chamber

Company:
 Project #: 15U22428
 Date: 12/09/15
 Test Engineer: F. Guamero
 Configuration: EUT Only
 Mode: 1xRTT 850MHz

Test Equipment:
 Substitution: Horn T59 Substitution, and 8ft SMA Cable

Chamber

Pre-amplifier

Filter

Limit

3m Chamber D

3m Chamber D

Filter

EIRP

Frequency (GHz)	SA reading (dBm)	Ant. Pol. (H/V)	Distance	EIRP @ TX Ant End (dBm)	Preamp	Attenuator	EIRP	Limit	Delta	Notes
Low Channel (824.7MHz)										
1.56	-66.1	H	3.0	-24.6	35.0	1.0	-58.6	-13.0	-45.6	
3.76	-67.9	H	3.0	-19.8	33.5	1.0	-52.3	-13.0	-39.3	
6.89	-69.8	H	3.0	-16.2	31.0	1.0	-46.2	-13.0	-33.2	
3.97	-68.5	V	3.0	-19.9	33.7	1.0	-52.6	-13.0	-39.6	
5.70	-62.8	V	3.0	-11.4	32.3	1.0	-42.8	-13.0	-29.8	
7.51	-70.5	V	3.0	-15.9	30.3	1.0	-45.2	-13.0	-32.2	
Mid Channel (836.52MHz)										
1.15	-65.9	H	3.0	-26.2	34.4	1.0	-59.6	-13.0	-46.6	
2.75	-67.4	H	3.0	-22.3	33.4	1.0	-54.7	-13.0	-41.7	
4.84	-68.5	H	3.0	-18.4	33.1	1.0	-50.5	-13.0	-37.5	
1.41	-65.9	V	3.0	-24.8	34.8	1.0	-58.6	-13.0	-45.6	
4.98	-68.6	V	3.0	-18.6	33.0	1.0	-50.7	-13.0	-37.7	
7.48	-70.0	V	3.0	-15.4	30.3	1.0	-44.7	-13.0	-31.7	
High Channel (848.31MHz)										
1.15	-66.5	H	3.0	-26.8	34.4	1.0	-60.2	-13.0	-47.2	
4.86	-68.4	H	3.0	-18.2	33.1	1.0	-50.3	-13.0	-37.3	
6.80	-69.7	H	3.0	-16.2	31.1	1.0	-46.3	-13.0	-33.3	
1.54	-66.4	V	3.0	-24.6	35.0	1.0	-58.6	-13.0	-45.6	
4.14	-67.9	V	3.0	-19.0	33.6	1.0	-51.6	-13.0	-38.6	
6.15	-68.9	V	3.0	-16.6	31.8	1.0	-47.4	-13.0	-34.4	

Rev. 03.19.15

EVDO-Rev A, 850MHz BC0

High Frequency Substitution Measurement
UL Fremont Radiated Chamber

Company:
 Project #: 15U22428
 Date: 01/05/16
 Test Engineer: M. Hua
 Configuration: EUT Only
 Mode: Rev A 850MHz

Test Equipment:
 Substitution: Horn T59 Substitution, and 8ft SMA Cable

Chamber

Pre-amplifier

Filter

Limit

3m Chamber F

3m Chamber F

Filter

EIRP

Frequency (GHz)	SA reading (dBm)	Ant. Pol. (H/V)	Distance	EIRP @ TX Ant End (dBm)	Preamp	Attenuator	EIRP	Limit	Delta	Notes
Low Channel (824.7MHz)										
1.56	-65.3	H	3.0	-24.8	33.8	1.0	-57.5	-13.0	-44.5	
3.76	-66.8	H	3.0	-16.8	34.4	1.0	-50.2	-13.0	-37.2	
6.89	-68.6	H	3.0	-13.0	33.9	1.0	-45.9	-13.0	-32.9	
3.97	-67.5	V	3.0	-16.7	34.3	1.0	-50.0	-13.0	-37.0	
5.70	-61.7	V	3.0	-7.9	34.1	1.0	-41.0	-13.0	-28.0	
7.51	-69.3	V	3.0	-13.0	33.5	1.0	-45.6	-13.0	-32.6	
Mid Channel (836.52MHz)										
1.15	-64.9	H	3.0	-26.4	34.6	1.0	-60.0	-13.0	-47.0	
2.75	-66.3	H	3.0	-20.7	34.5	1.0	-54.1	-13.0	-41.1	
4.84	-67.5	H	3.0	-15.2	34.2	1.0	-48.4	-13.0	-35.4	
1.41	-64.8	V	3.0	-22.4	34.0	1.0	-55.4	-13.0	-42.4	
4.98	-67.6	V	3.0	-14.8	34.2	1.0	-48.0	-13.0	-35.0	
7.48	-69.1	V	3.0	-12.9	33.5	1.0	-45.4	-13.0	-32.4	
High Channel (848.31MHz)										
1.15	-65.3	H	3.0	-26.9	34.6	1.0	-60.4	-13.0	-47.4	
4.86	-67.5	H	3.0	-15.2	34.2	1.0	-48.4	-13.0	-35.4	
6.80	-68.6	H	3.0	-13.2	33.9	1.0	-46.1	-13.0	-33.1	
1.54	-65.1	V	3.0	-21.8	33.8	1.0	-54.5	-13.0	-41.5	
4.14	-66.0	V	3.0	-14.8	34.3	1.0	-48.1	-13.0	-35.1	
6.15	-67.3	V	3.0	-12.8	34.0	1.0	-45.9	-13.0	-32.9	

Rev. 03.19.15

CDMA2000 1xRTT, 1900MHz BC1

**High Frequency Substitution Measurement
 UL Fremont Radiated Chamber**

Company:
Project #: 15U22428
Date: 12/09/15
Test Engineer: F. Guamero
Configuration: EUT Only
Mode: 1xRTT 1900MHz

Test Equipment:
 Substitution: Horn T59 Substitution, and 8ft SMA Cable

Chamber	Pre-amplifier	Filter	Limit
3m Chamber D	3m Chamber D	Filter	EIRP

Frequency (GHz)	SA reading (dBm)	Ant. Pol. (H/V)	Distance	EIRP @ TX Ant End (dBm)	Preamp	Attenuator	EIRP	Limit	Delta	Notes
Low Channel (1851.25MHz)										
3.16	-67.4	H	3.0	-21.1	33.1	1.0	-53.2	-13.0	-40.2	
5.19	-68.2	H	3.0	-17.5	32.9	1.0	-49.4	-13.0	-36.4	
6.42	-70.7	H	3.0	-17.9	31.5	1.0	-48.4	-13.0	-35.4	
3.70	-66.3	V	3.0	-18.3	33.5	1.0	-50.8	-13.0	-37.8	
7.03	-68.8	V	3.0	-14.6	30.9	1.0	-44.5	-13.0	-31.5	
8.27	-70.7	V	3.0	-15.3	29.3	1.0	-43.7	-13.0	-30.7	
Mid Channel (1880MHz)										
2.90	-67.6	H	3.0	-22.0	33.2	1.0	-54.2	-13.0	-41.2	
5.49	-68.8	H	3.0	-17.6	32.5	1.0	-49.2	-13.0	-36.2	
8.32	-69.9	H	3.0	-14.4	29.3	1.0	-42.7	-13.0	-29.7	
3.76	-66.0	V	3.0	-17.9	33.5	1.0	-50.5	-13.0	-37.5	
6.47	-69.6	V	3.0	-16.5	31.5	1.0	-47.0	-13.0	-34.0	
8.49	-70.7	V	3.0	-15.2	29.1	1.0	-43.2	-13.0	-30.2	
High Channel (1908.75MHz)										
3.39	-66.9	H	3.0	-19.8	33.3	1.0	-52.1	-13.0	-39.1	
4.64	-67.9	H	3.0	-18.1	33.3	1.0	-50.4	-13.0	-37.4	
6.68	-70.0	H	3.0	-16.7	31.2	1.0	-46.9	-13.0	-33.9	
2.69	-67.5	V	3.0	-22.4	33.5	1.0	-54.9	-13.0	-41.9	
4.85	-68.0	V	3.0	-18.2	33.1	1.0	-50.3	-13.0	-37.3	
8.49	-71.3	V	3.0	-15.7	29.1	1.0	-43.8	-13.0	-30.8	

Rev. 03.19.15

EVDO-Rev A, 1900MHz BC1

High Frequency Substitution Measurement
UL Fremont Radiated Chamber

Company:
 Project #: 15U22428
 Date: 01/05/16
 Test Engineer: M. Hua
 Configuration: EUT Only
 Mode: Rev A 1900MHz

Test Equipment:
 Substitution: Horn T59 Substitution, and 8ft SMA Cable

Chamber

Pre-amplifier

Filter

Limit

3m Chamber F

3m Chamber F

Filter

EIRP

Frequency (GHz)	SA reading (dBm)	Ant. Pol. (H/V)	Distance	EIRP @ TX Ant End (dBm)	Preamp	Attenuator	EIRP	Limit	Delta	Notes
Low Channel (1851.25MHz)										
3.16	-66.3	H	3.0	-18.6	34.7	1.0	-52.3	-13.0	-39.3	
5.19	-67.5	H	3.0	-14.7	34.2	1.0	-47.8	-13.0	-34.8	
6.42	-69.4	H	3.0	-14.5	34.0	1.0	-47.5	-13.0	-34.5	
3.70	-65.1	V	3.0	-15.2	34.4	1.0	-48.7	-13.0	-35.7	
7.03	-67.8	V	3.0	-12.2	33.9	1.0	-45.1	-13.0	-32.1	
8.27	-69.4	V	3.0	-12.1	32.9	1.0	-44.0	-13.0	-31.0	
Mid Channel (1880MHz)										
2.90	-66.5	H	3.0	-20.0	34.7	1.0	-53.6	-13.0	-40.6	
5.49	-67.9	H	3.0	-14.5	34.1	1.0	-47.7	-13.0	-34.7	
8.32	-68.7	H	3.0	-11.1	32.9	1.0	-43.0	-13.0	-30.0	
3.76	-65.3	V	3.0	-15.2	34.4	1.0	-48.6	-13.0	-35.6	
6.47	-68.3	V	3.0	-13.5	34.0	1.0	-46.5	-13.0	-33.5	
8.49	-69.7	V	3.0	-12.1	32.8	1.0	-43.9	-13.0	-30.9	
High Channel (1908.75MHz)										
3.39	-65.8	H	3.0	-17.2	34.6	1.0	-50.8	-13.0	-37.8	
4.64	-66.4	H	3.0	-14.4	34.2	1.0	-47.6	-13.0	-34.6	
6.68	-69.1	H	3.0	-13.8	34.0	1.0	-46.8	-13.0	-33.8	
2.69	-66.3	V	3.0	-20.5	34.4	1.0	-53.9	-13.0	-40.9	
4.85	-67.2	V	3.0	-14.7	34.2	1.0	-47.9	-13.0	-34.9	
8.49	-69.9	V	3.0	-12.3	32.8	1.0	-44.0	-13.0	-31.0	

Rev. 03.19.15

CDMA2000 1xRTT, 1700MHz BC15

**High Frequency Substitution Measurement
 UL Fremont Radiated Chamber**

Company:
Project #: 15U22428
Date: 12/09/15
Test Engineer: F. Guamero
Configuration: EUT Only
Mode: 1xRTT 1700MHz

Test Equipment:
 Substitution: Horn T59 Substitution, and 8ft SMA Cable

Chamber	Pre-amplifier	Filter	Limit
3m Chamber D	3m Chamber D	Filter	EIRP

Frequency (GHz)	SA reading (dBm)	Ant. Pol. (H/V)	Distance	EIRP @ TX Ant End (dBm)	Preamp	Attenuator	EIRP	Limit	Delta	Notes
Low Channel (1711.25MHz)										
2.72	-67.0	H	3.0	-22.0	33.4	1.0	-54.4	-13.0	-41.4	
5.07	-68.4	H	3.0	-17.9	33.0	1.0	-49.9	-13.0	-36.9	
8.27	-70.7	H	3.0	-15.2	29.3	1.0	-43.6	-13.0	-30.6	
3.42	-67.0	V	3.0	-19.8	33.3	1.0	-52.2	-13.0	-39.2	
6.04	-69.3	V	3.0	-17.2	31.9	1.0	-48.2	-13.0	-35.2	
7.52	-70.5	V	3.0	-15.8	30.3	1.0	-45.1	-13.0	-32.1	
Mid Channel (1732.5MHz)										
3.46	-64.0	H	3.0	-16.8	33.3	1.0	-49.1	-13.0	-36.1	
4.29	-67.6	H	3.0	-18.3	33.5	1.0	-50.8	-13.0	-37.8	
6.75	-69.9	H	3.0	-16.5	31.2	1.0	-46.6	-13.0	-33.6	
3.46	-67.0	V	3.0	-19.7	33.3	1.0	-52.1	-13.0	-39.1	
4.89	-68.1	V	3.0	-18.2	33.1	1.0	-50.3	-13.0	-37.3	
7.62	-70.4	V	3.0	-15.7	30.1	1.0	-44.8	-13.0	-31.8	
High Channel (1753.75MHz)										
3.51	-65.6	H	3.0	-18.2	33.4	1.0	-50.6	-13.0	-37.6	
5.13	-68.6	H	3.0	-18.0	32.9	1.0	-49.9	-13.0	-36.9	
8.35	-71.3	H	3.0	-15.8	29.2	1.0	-44.0	-13.0	-31.0	
3.51	-66.0	V	3.0	-18.6	33.4	1.0	-50.9	-13.0	-37.9	
5.77	-69.1	V	3.0	-17.6	32.2	1.0	-48.9	-13.0	-35.9	
7.12	-69.6	V	3.0	-15.3	30.7	1.0	-45.1	-13.0	-32.1	

Rev. 03.19.15

EVDO-Rev A, 1700MHz BC15

High Frequency Substitution Measurement
UL Fremont Radiated Chamber

Company:
Project #: 15U22428
Date: 01/05/16
Test Engineer: M. Hua
Configuration: EUT Only
Mode: Rev A, 1700MHz

Test Equipment:
 Substitution: Horn T59 Substitution, and 8ft SMA Cable

Chamber

Pre-amplifier

Filter

Limit

3m Chamber F

3m Chamber F

Filter

EIRP

Frequency (GHz)	SA reading (dBm)	Ant. Pol. (H/V)	Distance	EIRP @ TX Ant End (dBm)	Preamp	Attenuator	EIRP	Limit	Delta	Notes
Low Channel (1711.25MHz)										
2.72	-66.3	H	3.0	-20.8	34.4	1.0	-54.2	-13.0	-41.2	
5.07	-67.3	H	3.0	-14.7	34.2	1.0	-47.8	-13.0	-34.8	
8.27	-69.1	H	3.0	-11.6	32.9	1.0	-43.6	-13.0	-30.6	
3.42	-66.2	V	3.0	-17.3	34.6	1.0	-50.9	-13.0	-37.9	
6.04	-68.1	V	3.0	-13.8	34.1	1.0	-46.9	-13.0	-33.9	
7.52	-69.4	V	3.0	-13.1	33.5	1.0	-45.6	-13.0	-32.6	
Mid Channel (1732.5MHz)										
3.46	-63.5	H	3.0	-14.6	34.6	1.0	-48.2	-13.0	-35.2	
4.29	-66.4	H	3.0	-15.0	34.3	1.0	-48.3	-13.0	-35.3	
6.75	-68.3	H	3.0	-13.0	34.0	1.0	-45.9	-13.0	-32.9	
3.46	-66.3	V	3.0	-17.3	34.6	1.0	-50.8	-13.0	-37.8	
4.89	-67.5	V	3.0	-14.9	34.2	1.0	-48.1	-13.0	-35.1	
7.62	-69.5	V	3.0	-13.1	33.4	1.0	-45.6	-13.0	-32.6	
High Channel (1753.75MHz)										
3.51	-64.4	H	3.0	-15.3	34.5	1.0	-48.9	-13.0	-35.9	
5.13	-67.6	H	3.0	-14.9	34.2	1.0	-48.0	-13.0	-35.0	
8.35	-69.9	H	3.0	-12.3	32.9	1.0	-44.2	-13.0	-31.2	
3.51	-65.8	V	3.0	-16.6	34.5	1.0	-50.1	-13.0	-37.1	
5.77	-68.2	V	3.0	-14.2	34.1	1.0	-47.3	-13.0	-34.3	
7.12	-68.3	V	3.0	-12.6	33.8	1.0	-45.4	-13.0	-32.4	

Rev. 03.19.15

CDMA2000 1xRTT, 800MHz BC10

**High Frequency Substitution Measurement
 UL Fremont Radiated Chamber**

Company:
Project #: 15U22428
Date: 12/09/15
Test Engineer: F. Guamero
Configuration: EUT Only
Mode: 1xRTT 800MHz

Test Equipment:
 Substitution: Horn T59 Substitution, and 8ft SMA Cable

Chamber	Pre-amplifier	Filter	Limit
3m Chamber D	3m Chamber D	Filter	EIRP

Frequency (GHz)	SA reading (dBm)	Ant. Pol. (H/V)	Distance	EIRP @ TX Ant End (dBm)	Preamp	Attenuator	EIRP	Limit	Delta	Notes
Low Channel (817.25MHz)										
1.78	-66.2	H	3.0	-24.0	35.0	1.0	-58.0	-13.0	-45.0	
3.41	-67.6	H	3.0	-20.5	33.3	1.0	-52.8	-13.0	-39.8	
6.17	-69.3	H	3.0	-16.9	31.8	1.0	-47.7	-13.0	-34.7	
1.15	-66.7	V	3.0	-27.0	34.4	1.0	-60.4	-13.0	-47.4	
3.00	-67.3	V	3.0	-21.2	33.0	1.0	-53.3	-13.0	-40.3	
6.53	-69.7	V	3.0	-16.5	31.4	1.0	-46.9	-13.0	-33.9	
Mid Channel (820MHz)										
1.20	-66.6	H	3.0	-26.7	34.4	1.0	-60.2	-13.0	-47.2	
4.51	-68.3	H	3.0	-18.7	33.3	1.0	-51.1	-13.0	-38.1	
7.59	-70.8	H	3.0	-16.2	30.2	1.0	-45.4	-13.0	-32.4	
1.53	-66.4	V	3.0	-24.7	35.0	1.0	-58.7	-13.0	-45.7	
3.02	-67.1	V	3.0	-20.9	33.0	1.0	-53.0	-13.0	-40.0	
4.72	-68.3	V	3.0	-18.7	33.2	1.0	-50.9	-13.0	-37.9	
High Channel (822.75MHz)										
1.15	-66.5	H	3.0	-26.8	34.4	1.0	-60.2	-13.0	-47.2	
4.75	-68.2	H	3.0	-18.2	33.2	1.0	-50.4	-13.0	-37.4	
7.48	-71.0	H	3.0	-16.5	30.3	1.0	-45.8	-13.0	-32.8	
1.84	-66.3	V	3.0	-23.9	35.0	1.0	-57.9	-13.0	-44.9	
3.39	-67.8	V	3.0	-20.6	33.3	1.0	-52.9	-13.0	-39.9	
4.43	-67.9	V	3.0	-18.6	33.4	1.0	-51.0	-13.0	-38.0	

Rev. 03.19.15

EVDO-Rev A, 800MHz BC10

High Frequency Substitution Measurement
UL Fremont Radiated Chamber

Company: 15U22428
 Project #: 15U22428
 Date: 01/05/16
 Test Engineer: M. Hua
 Configuration: EUT Only
 Mode: Rev A, 800MHz

Test Equipment:
 Substitution: Horn T59 Substitution, and 8ft SMA Cable

Chamber

Pre-amplifier

Filter

Limit

3m Chamber F

3m Chamber F

Filter

EIRP

Frequency (GHz)	SA reading (dBm)	Ant. Pol. (H/V)	Distance	EIRP @ TX Ant End (dBm)	Preamp	Attenuator	EIRP	Limit	Delta	Notes
Low Channel (817.25MHz)										
1.78	-65.3	H	3.0	-23.3	33.6	1.0	-55.9	-13.0	-42.9	
3.41	-66.9	H	3.0	-18.2	34.6	1.0	-51.8	-13.0	-38.8	
6.17	-68.1	H	3.0	-13.7	34.0	1.0	-46.7	-13.0	-33.7	
1.15	-65.4	V	3.0	-25.3	34.6	1.0	-58.9	-13.0	-45.9	
3.00	-65.4	V	3.0	-17.9	34.8	1.0	-51.8	-13.0	-38.8	
6.53	-68.3	V	3.0	-13.4	34.0	1.0	-46.3	-13.0	-33.3	
Mid Channel (820MHz)										
1.20	-65.4	H	3.0	-26.7	34.5	1.0	-60.2	-13.0	-47.2	
4.51	-67.4	H	3.0	-15.7	34.2	1.0	-48.9	-13.0	-35.9	
7.59	-69.6	H	3.0	-13.0	33.5	1.0	-45.4	-13.0	-32.4	
1.53	-65.3	V	3.0	-22.0	33.8	1.0	-54.8	-13.0	-41.8	
3.02	-66.0	V	3.0	-18.5	34.8	1.0	-52.3	-13.0	-39.3	
4.72	-67.5	V	3.0	-15.2	34.2	1.0	-48.5	-13.0	-35.5	
High Channel (822.75MHz)										
1.15	-65.3	H	3.0	-26.8	34.6	1.0	-60.4	-13.0	-47.4	
4.75	-67.6	H	3.0	-15.5	34.2	1.0	-48.7	-13.0	-35.7	
7.48	-70.2	H	3.0	-13.8	33.5	1.0	-46.3	-13.0	-33.3	
1.84	-65.8	V	3.0	-22.3	33.6	1.0	-54.9	-13.0	-41.9	
3.39	-66.8	V	3.0	-18.0	34.6	1.0	-51.6	-13.0	-38.6	
4.43	-66.8	V	3.0	-15.1	34.2	1.0	-48.3	-13.0	-35.3	

Rev. 03.19.15

10.5.3. UMTS

UMTS REL 99, 850MHz BAND 5

High Frequency Substitution Measurement
UL Fremont Radiated Chamber

Company:
Project #: 15U22428
Date: 12/09/15
Test Engineer: F. Guarnero
Configuration: EUT Only
Mode: REL 99, 850MHz

Test Equipment:
 Substitution: Horn T59 Substitution, and 8ft SMA Cable

Chamber

3m Chamber D

Pre-amplifier

3m Chamber D

Filter

Filter

Limit

EIRP

Frequency (GHz)	SA reading (dBm)	Ant. Pol. (H/V)	Distance	EIRP @ TX Ant End (dBm)	Preamp	Attenuator	EIRP	Limit	Delta	Notes
Low Channel (826.4MHz)										
1.24	-66.4	H	3.0	-26.3	34.5	1.0	-59.9	-13.0	-46.9	
4.25	-67.6	H	3.0	-18.4	33.5	1.0	-51.0	-13.0	-38.0	
4.82	-67.9	H	3.0	-17.8	33.1	1.0	-49.9	-13.0	-36.9	
1.07	-66.3	V	3.0	-27.2	34.2	1.0	-60.4	-13.0	-47.4	
4.54	-67.1	V	3.0	-17.7	33.3	1.0	-50.0	-13.0	-37.0	
6.12	-68.3	V	3.0	-16.0	31.9	1.0	-46.9	-13.0	-33.9	
Mid Channel (836.6MHz)										
1.22	-66.5	H	3.0	-26.5	34.5	1.0	-60.0	-13.0	-47.0	
3.66	-67.6	H	3.0	-19.8	33.5	1.0	-52.3	-13.0	-39.3	
8.46	-71.1	H	3.0	-15.4	29.1	1.0	-43.5	-13.0	-30.5	
3.67	-66.7	V	3.0	-18.8	33.5	1.0	-51.3	-13.0	-38.3	
5.62	-69.1	V	3.0	-17.9	32.4	1.0	-49.3	-13.0	-36.3	
7.61	-69.9	V	3.0	-15.2	30.2	1.0	-44.3	-13.0	-31.3	
High Channel (846.6MHz)										
1.28	-67.0	H	3.0	-26.8	34.6	1.0	-60.4	-13.0	-47.4	
2.89	-67.4	H	3.0	-21.9	33.2	1.0	-54.1	-13.0	-41.1	
4.42	-67.4	H	3.0	-17.9	33.4	1.0	-50.4	-13.0	-37.4	
1.20	-66.4	V	3.0	-26.5	34.4	1.0	-59.9	-13.0	-46.9	
5.38	-68.6	V	3.0	-17.9	32.7	1.0	-49.6	-13.0	-36.6	
6.85	-70.0	V	3.0	-16.1	31.1	1.0	-46.2	-13.0	-33.2	

Rev. 03.19.15

UMTS HSDPA, 850MHz BAND 5

**High Frequency Substitution Measurement
 UL Fremont Radiated Chamber**

Company:
Project #: 15U22428
Date: 12/09/15
Test Engineer: F. Guamero
Configuration: EUT Only
Mode: HSDPA 850MHz

Test Equipment:
 Substitution: Horn T59 Substitution, and 8ft SMA Cable

Chamber	Pre-amplifier	Filter	Limit
3m Chamber D	3m Chamber D	Filter	EIRP

Frequency (GHz)	SA reading (dBm)	Ant. Pol. (H/V)	Distance	EIRP @ TX Ant End (dBm)	Preamp	Attenuator	EIRP	Limit	Delta	Notes
Low Channel (826.4MHz)										
1.17	-66.9	H	3.0	-27.2	34.4	1.0	-60.6	-13.0	-47.6	
4.46	-68.2	H	3.0	-18.7	33.4	1.0	-51.1	-13.0	-38.1	
6.50	-69.1	H	3.0	-16.2	31.4	1.0	-46.6	-13.0	-33.6	
1.22	-65.8	V	3.0	-25.8	34.5	1.0	-59.2	-13.0	-46.2	
3.90	-67.7	V	3.0	-19.3	33.6	1.0	-51.9	-13.0	-38.9	
7.85	-70.1	V	3.0	-15.2	29.9	1.0	-44.0	-13.0	-31.0	
Mid Channel (836.6MHz)										
1.77	-66.1	H	3.0	-24.0	35.0	1.0	-58.0	-13.0	-45.0	
5.10	-67.9	H	3.0	-17.4	32.9	1.0	-49.3	-13.0	-36.3	
7.59	-70.4	H	3.0	-15.8	30.2	1.0	-45.0	-13.0	-32.0	
1.15	-65.6	V	3.0	-26.0	34.4	1.0	-59.4	-13.0	-46.4	
5.05	-68.6	V	3.0	-18.5	33.0	1.0	-50.5	-13.0	-37.5	
9.18	-71.2	V	3.0	-15.0	28.2	1.0	-42.3	-13.0	-29.3	
High Channel (846.6MHz)										
1.55	-66.8	H	3.0	-25.3	35.0	1.0	-59.3	-13.0	-46.3	
4.25	-67.1	H	3.0	-17.9	33.5	1.0	-50.5	-13.0	-37.5	
6.89	-69.8	H	3.0	-16.1	31.0	1.0	-46.1	-13.0	-33.1	
1.20	-66.5	V	3.0	-26.7	34.4	1.0	-60.1	-13.0	-47.1	
3.65	-68.3	V	3.0	-20.5	33.5	1.0	-53.0	-13.0	-40.0	
6.15	-69.6	V	3.0	-17.3	31.8	1.0	-48.1	-13.0	-35.1	

Rev. 03.19.15

UMTS REL 99, 1900MHz BAND 2

**High Frequency Substitution Measurement
 UL Fremont Radiated Chamber**

Company:
Project #: 15U22428
Date: 12/09/15
Test Engineer: F. Guarero
Configuration: EUT Only
Mode: REL 99, 1900MHz

Test Equipment:
 Substitution: Horn T59 Substitution, and 8ft SMA Cable

Chamber	Pre-amplifier	Filter	Limit
3m Chamber D	3m Chamber D	Filter	EIRP

Frequency (GHz)	SA reading (dBm)	Ant. Pol. (H/V)	Distance	EIRP @ TX Ant End (dBm)	Preamp	Attenuator	EIRP	Limit	Delta	Notes
Low Channel (1852.4MHz)										
2.74	-67.8	H	3.0	-22.8	33.4	1.0	-55.2	-13.0	-42.2	
4.86	-68.5	H	3.0	-18.4	33.1	1.0	-50.5	-13.0	-37.5	
7.15	-70.2	H	3.0	-16.1	30.7	1.0	-45.8	-13.0	-32.8	
3.70	-67.7	V	3.0	-19.7	33.5	1.0	-52.2	-13.0	-39.2	
4.91	-67.9	V	3.0	-18.0	33.1	1.0	-50.0	-13.0	-37.0	
8.98	-70.5	V	3.0	-14.5	28.5	1.0	-41.9	-13.0	-28.9	
Mid Channel (1880MHz)										
2.97	-67.9	H	3.0	-22.1	33.1	1.0	-54.1	-13.0	-41.1	
4.91	-67.5	H	3.0	-17.2	33.1	1.0	-49.3	-13.0	-36.3	
8.25	-71.3	H	3.0	-15.9	29.4	1.0	-44.2	-13.0	-31.2	
3.76	-66.8	V	3.0	-18.7	33.5	1.0	-51.2	-13.0	-38.2	
6.01	-68.9	V	3.0	-16.9	32.0	1.0	-47.8	-13.0	-34.8	
8.57	-71.3	V	3.0	-15.6	29.0	1.0	-43.6	-13.0	-30.6	
High Channel (1907.6MHz)										
3.66	-68.2	H	3.0	-20.4	33.5	1.0	-52.8	-13.0	-39.8	
6.35	-69.2	H	3.0	-16.5	31.6	1.0	-47.1	-13.0	-34.1	
8.48	-71.6	H	3.0	-15.9	29.1	1.0	-44.0	-13.0	-31.0	
3.70	-67.6	V	3.0	-19.7	33.5	1.0	-52.2	-13.0	-39.2	
6.26	-68.9	V	3.0	-16.4	31.7	1.0	-47.1	-13.0	-34.1	
8.91	-71.2	V	3.0	-15.3	28.6	1.0	-42.8	-13.0	-29.8	

Rev. 03.19.15

UMTS HSDPA, 1900MHz BAND 2

**High Frequency Substitution Measurement
 UL Fremont Radiated Chamber**

Company:
Project #: 15U22428
Date: 12/09/15
Test Engineer: F. Guarnero
Configuration: EUT Only
Mode: HSPA 1900MHz

Test Equipment:
 Substitution: Horn T59 Substitution, and 8ft SMA Cable

Chamber	Pre-amplifier	Filter	Limit
3m Chamber D	3m Chamber D	Filter	EIRP

Frequency (GHz)	SA reading (dBm)	Ant. Pol. (H/V)	Distance	EIRP @ TX Ant End (dBm)	Preamp	Attenuator	EIRP	Limit	Delta	Notes
Low Channel (1852.4MHz)										
3.39	-67.3	H	3.0	-20.3	33.3	1.0	-52.5	-13.0	-39.5	
4.91	-68.1	H	3.0	-17.9	33.1	1.0	-50.0	-13.0	-37.0	
8.27	-69.0	H	3.0	-13.6	29.3	1.0	-41.9	-13.0	-28.9	
3.70	-67.6	V	3.0	-19.6	33.5	1.0	-52.1	-13.0	-39.1	
6.15	-69.6	V	3.0	-17.2	31.8	1.0	-48.1	-13.0	-35.1	
8.63	-70.9	V	3.0	-15.2	28.9	1.0	-43.1	-13.0	-30.1	
Mid Channel (1880MHz)										
3.38	-67.5	H	3.0	-20.5	33.3	1.0	-52.8	-13.0	-39.8	
5.38	-68.4	H	3.0	-17.4	32.7	1.0	-49.0	-13.0	-36.0	
6.79	-69.8	H	3.0	-16.3	31.1	1.0	-46.4	-13.0	-33.4	
3.09	-67.4	V	3.0	-21.1	33.1	1.0	-53.2	-13.0	-40.2	
4.91	-68.2	V	3.0	-18.3	33.1	1.0	-50.4	-13.0	-37.4	
7.29	-70.8	V	3.0	-16.4	30.5	1.0	-45.9	-13.0	-32.9	
High Channel (1907.6MHz)										
2.92	-67.3	H	3.0	-21.7	33.1	1.0	-53.8	-13.0	-40.8	
4.39	-68.3	H	3.0	-18.9	33.4	1.0	-51.3	-13.0	-38.3	
5.89	-69.0	H	3.0	-17.1	32.1	1.0	-48.2	-13.0	-35.2	
2.89	-67.0	V	3.0	-21.3	33.2	1.0	-53.5	-13.0	-40.5	
4.35	-67.5	V	3.0	-18.3	33.5	1.0	-50.8	-13.0	-37.8	
5.76	-68.9	V	3.0	-17.4	32.3	1.0	-48.7	-13.0	-35.7	

Rev. 03.19.15

UMTS REL 99, 1700MHz BAND 4

**High Frequency Substitution Measurement
 UL Fremont Radiated Chamber**

Company:
Project #: 15U22428
Date: 12/09/15
Test Engineer: F. Guamero
Configuration: EUT Only
Mode: REL 99, 1700MHz

Test Equipment:
 Substitution: Horn T59 Substitution, and 8ft SMA Cable

Chamber	Pre-amplifier	Filter	Limit
3m Chamber D	3m Chamber D	Filter	EIRP

Frequency (GHz)	SA reading (dBm)	Ant. Pol. (H/V)	Distance	EIRP @ TX Ant End (dBm)	Preamp	Attenuator	EIRP	Limit	Delta	Notes
Low Channel (1712.4MHz)										
3.13	-67.8	H	3.0	-21.5	33.1	1.0	-53.6	-13.0	-40.6	
4.22	-68.0	H	3.0	-18.8	33.6	1.0	-51.4	-13.0	-38.4	
7.59	-70.4	H	3.0	-15.8	30.2	1.0	-45.0	-13.0	-32.0	
2.69	-67.0	V	3.0	-21.9	33.5	1.0	-54.4	-13.0	-41.4	
5.70	-68.3	V	3.0	-16.9	32.3	1.0	-48.3	-13.0	-35.3	
8.48	-70.7	V	3.0	-15.2	29.1	1.0	-43.3	-13.0	-30.3	
Mid Channel (1732.6MHz)										
4.16	-67.5	H	3.0	-18.4	33.6	1.0	-51.0	-13.0	-38.0	
6.38	-69.2	H	3.0	-16.4	31.6	1.0	-47.0	-13.0	-34.0	
9.79	-70.9	H	3.0	-13.6	27.5	1.0	-40.1	-13.0	-27.1	
2.95	-68.1	V	3.0	-22.2	33.1	1.0	-54.3	-13.0	-41.3	
4.36	-67.6	V	3.0	-18.4	33.5	1.0	-50.9	-13.0	-37.9	
5.44	-68.6	V	3.0	-17.8	32.6	1.0	-49.4	-13.0	-36.4	
High Channel (1752.6MHz)										
2.60	-66.0	H	3.0	-21.4	33.6	1.0	-54.0	-13.0	-41.0	
4.85	-68.4	H	3.0	-18.3	33.1	1.0	-50.4	-13.0	-37.4	
7.22	-70.3	H	3.0	-16.2	30.6	1.0	-45.8	-13.0	-32.8	
3.38	-67.2	V	3.0	-20.1	33.3	1.0	-52.4	-13.0	-39.4	
5.02	-68.1	V	3.0	-18.1	33.0	1.0	-50.1	-13.0	-37.1	
8.32	-70.6	V	3.0	-15.2	29.3	1.0	-43.5	-13.0	-30.5	

Rev. 03.19.15

UMTS HSDPA, 1700MHz BAND 4

**High Frequency Substitution Measurement
 UL Fremont Radiated Chamber**

Company:
Project #: 15U22428
Date: 12/09/15
Test Engineer: F. Guarnero
Configuration: EUT Only
Mode: HSDPA 1700MHz

Test Equipment:
 Substitution: Horn T59 Substitution, and 8ft SMA Cable

Chamber	Pre-amplifier	Filter	Limit
3m Chamber D	3m Chamber D	Filter	EIRP

Frequency (GHz)	SA reading (dBm)	Ant. Pol. (H/V)	Distance	EIRP @ TX Ant End (dBm)	Preamp	Attenuator	EIRP	Limit	Delta	Notes
Low Channel (1712.4MHz)										
2.95	-67.4	H	3.0	-21.7	33.1	1.0	-53.8	-13.0	-40.8	
4.89	-68.0	H	3.0	-17.8	33.1	1.0	-49.9	-13.0	-36.9	
7.16	-70.4	H	3.0	-16.3	30.7	1.0	-46.0	-13.0	-33.0	
2.72	-67.2	V	3.0	-22.0	33.4	1.0	-54.4	-13.0	-41.4	
6.21	-68.2	V	3.0	-15.7	31.8	1.0	-46.5	-13.0	-33.5	
7.15	-72.1	V	3.0	-17.8	30.7	1.0	-47.5	-13.0	-34.5	
Mid Channel (1732.6MHz)										
2.61	-67.4	H	3.0	-22.8	33.6	1.0	-55.4	-13.0	-42.4	
3.16	-66.5	H	3.0	-20.1	33.1	1.0	-52.2	-13.0	-39.2	
4.88	-68.4	H	3.0	-18.2	33.1	1.0	-50.3	-13.0	-37.3	
3.07	-66.9	V	3.0	-20.6	33.1	1.0	-52.7	-13.0	-39.7	
4.89	-68.2	V	3.0	-18.3	33.1	1.0	-50.4	-13.0	-37.4	
6.21	-69.7	V	3.0	-17.2	31.8	1.0	-48.0	-13.0	-35.0	
High Channel (1752.6MHz)										
4.16	-67.6	H	3.0	-18.5	33.6	1.0	-51.1	-13.0	-38.1	
5.76	-68.8	H	3.0	-17.2	32.3	1.0	-48.4	-13.0	-35.4	
8.70	-71.6	H	3.0	-15.6	28.8	1.0	-43.4	-13.0	-30.4	
3.51	-67.5	V	3.0	-20.1	33.4	1.0	-52.5	-13.0	-39.5	
6.14	-68.6	V	3.0	-16.3	31.8	1.0	-47.2	-13.0	-34.2	
9.15	-71.9	V	3.0	-15.7	28.3	1.0	-43.0	-13.0	-30.0	

Rev. 03.19.15