



**FCC 47 CFR PART 15 SUBPART C
INDUSTRY CANADA RSS-247 ISSUE 1**

CERTIFICATION TEST REPORT

FOR

TABLET DEVICE

MODEL NUMBER: A1673

FCC ID: BCGA1673

IC: 579C-A1673

REPORT NUMBER: 15U22427-E1V2

ISSUE DATE: FEBRUARY 16, 2016

Prepared for

APPLE, INC.

1 INFINITE LOOP

CUPERTINO, CA 95014, U.S.A.

Prepared by

UL VERIFICATION SERVICES INC.

47173 BENICIA STREET

FREMONT, CA 94538, U.S.A.

TEL: (510) 771-1000

FAX: (510) 661-0888

NVLAP[®]

NVLAP LAB CODE 200065-0

Revision History

<u>Rev.</u>	<u>Issue Date</u>	<u>Revisions</u>	<u>Revised By</u>
V1	02/03/2016	Initial Review	M. Mekuria
V2	02/16/2016	Revised report to address TCB's questions	T. Chu

TABLE OF CONTENTS

1. ATTESTATION OF TEST RESULTS	6
2. TEST METHODOLOGY	7
3. FACILITIES AND ACCREDITATION	7
4. CALIBRATION AND UNCERTAINTY	8
4.1. <i>MEASURING INSTRUMENT CALIBRATION</i>	<i>8</i>
4.2. <i>SAMPLE CALCULATION</i>	<i>8</i>
4.3. <i>MEASUREMENT UNCERTAINTY.....</i>	<i>8</i>
5. EQUIPMENT UNDER TEST	9
5.1. <i>DESCRIPTION OF EUT</i>	<i>9</i>
5.2. <i>MAXIMUM OUTPUT POWER.....</i>	<i>9</i>
5.3. <i>DESCRIPTION OF AVAILABLE ANTENNAS</i>	<i>9</i>
5.4. <i>SOFTWARE AND FIRMWARE.....</i>	<i>9</i>
5.5. <i>WORST-CASE CONFIGURATION AND MODE.....</i>	<i>10</i>
5.6. <i>DESCRIPTION OF TEST SETUP.....</i>	<i>11</i>
6. TEST AND MEASUREMENT EQUIPMENT	18
7. ANTENNA PORT TEST RESULTS	19
7.1. <i>ON TIME AND DUTY CYCLE.....</i>	<i>19</i>
7.2. <i>ANTENNA B HIGH POWER BASIC DATA RATE GFSK MODULATION.....</i>	<i>24</i>
7.2.1. <i>20 dB AND 99% BANDWIDTH</i>	<i>24</i>
7.2.2. <i>HOPPING FREQUENCY SEPARATION</i>	<i>27</i>
7.2.3. <i>NUMBER OF HOPPING CHANNELS.....</i>	<i>28</i>
7.2.4. <i>AVERAGE TIME OF OCCUPANCY</i>	<i>31</i>
7.2.5. <i>OUTPUT POWER</i>	<i>35</i>
7.2.6. <i>AVERAGE POWER.....</i>	<i>36</i>
7.2.7. <i>CONDUCTED SPURIOUS EMISSIONS.....</i>	<i>37</i>
7.3. <i>ANTENNA B HIGH POWER ENHANCED DATA RATE QPSK MODULATION</i>	<i>42</i>
7.3.1. <i>OUTPUT POWER</i>	<i>42</i>
7.3.2. <i>AVERAGE POWER.....</i>	<i>43</i>
7.4. <i>ANTENNA B HIGH POWER ENHANCED DATA RATE 8PSK MODULATION.....</i>	<i>44</i>
7.4.1. <i>20 dB AND 99% BANDWIDTH</i>	<i>44</i>
7.4.2. <i>HOPPING FREQUENCY SEPARATION</i>	<i>47</i>
7.4.3. <i>NUMBER OF HOPPING CHANNELS.....</i>	<i>48</i>
7.4.4. <i>AVERAGE TIME OF OCCUPANCY</i>	<i>51</i>
7.4.5. <i>OUTPUT POWER</i>	<i>55</i>
7.4.6. <i>AVERAGE POWER.....</i>	<i>56</i>
7.4.7. <i>CONDUCTED SPURIOUS EMISSIONS.....</i>	<i>57</i>
7.5. <i>ANTENNA B LOW POWER BASIC DATA RATE GFSK MODULATION</i>	<i>62</i>
7.5.1. <i>20 dB AND 99% BANDWIDTH</i>	<i>62</i>
7.5.2. <i>HOPPING FREQUENCY SEPARATION</i>	<i>65</i>

7.5.3.	NUMBER OF HOPPING CHANNELS.....	66
7.5.4.	AVERAGE TIME OF OCCUPANCY	69
7.5.5.	OUTPUT POWER	73
7.5.6.	AVERAGE POWER.....	74
7.5.7.	CONDUCTED SPURIOUS EMISSIONS.....	75
7.6.	<i>ANTENNA B LOW POWER ENHANCED DATA RATE QPSK MODULATION.....</i>	<i>80</i>
7.6.1.	OUTPUT POWER	80
7.6.2.	AVERAGE POWER.....	81
7.7.	<i>ANTENNA B LOW POWER ENHANCED DATA RATE 8PSK MODULATION.....</i>	<i>82</i>
7.7.1.	20 dB AND 99% BANDWIDTH	82
7.7.2.	HOPPING FREQUENCY SEPARATION	85
7.7.3.	NUMBER OF HOPPING CHANNELS.....	86
7.7.4.	AVERAGE TIME OF OCCUPANCY	89
7.7.5.	OUTPUT POWER	93
7.7.6.	AVERAGE POWER.....	94
7.7.7.	CONDUCTED SPURIOUS EMISSIONS.....	95
7.8.	<i>ANTENNA C HIGH POWER BASIC DATA RATE GFSK MODULATION</i>	<i>100</i>
7.8.1.	20 dB AND 99% BANDWIDTH	100
7.8.2.	HOPPING FREQUENCY SEPARATION	103
7.8.3.	NUMBER OF HOPPING CHANNELS.....	104
7.8.4.	AVERAGE TIME OF OCCUPANCY	107
7.8.5.	OUTPUT POWER	111
7.8.6.	AVERAGE POWER.....	112
7.8.7.	CONDUCTED SPURIOUS EMISSIONS.....	113
7.9.	<i>ANTENNA C HIGH POWER ENHANCED DATA RATE QPSK MODULATION</i>	<i>118</i>
7.9.1.	OUTPUT POWER	118
7.9.2.	AVERAGE POWER.....	119
7.10.	<i>ANTENNA C HIGH POWER ENHANCED DATA RATE 8PSK MODULATION</i>	<i>120</i>
7.10.1.	20 dB AND 99% BANDWIDTH.....	120
7.10.2.	HOPPING FREQUENCY SEPARATION.....	123
7.10.3.	NUMBER OF HOPPING CHANNELS	124
7.10.4.	AVERAGE TIME OF OCCUPANCY	127
7.10.5.	OUTPUT POWER.....	131
7.10.6.	AVERAGE POWER	132
7.10.7.	CONDUCTED SPURIOUS EMISSIONS	133
7.11.	<i>ANTENNA C LOW POWER BASIC DATA RATE GFSK MODULATION.....</i>	<i>138</i>
7.11.1.	20 dB AND 99% BANDWIDTH.....	138
7.11.2.	HOPPING FREQUENCY SEPARATION.....	141
7.11.3.	NUMBER OF HOPPING CHANNELS	142
7.11.4.	AVERAGE TIME OF OCCUPANCY	145
7.11.5.	OUTPUT POWER.....	149
7.11.6.	AVERAGE POWER	150
7.11.7.	CONDUCTED SPURIOUS EMISSIONS	151
7.12.	<i>ANTENNA C LOW POWER ENHANCED DATA RATE QPSK MODULATION</i>	<i>156</i>
7.12.1.	OUTPUT POWER.....	156
7.12.2.	AVERAGE POWER	157
7.13.	<i>ANTENNA C LOW POWER ENHANCED DATA RATE 8PSK MODULATION</i>	<i>158</i>
7.13.1.	20 dB AND 99% BANDWIDTH.....	158
7.13.2.	HOPPING FREQUENCY SEPARATION.....	161

7.13.3.	NUMBER OF HOPPING CHANNELS	162
7.13.4.	AVERAGE TIME OF OCCUPANCY	165
7.13.5.	OUTPUT POWER.....	169
7.13.6.	AVERAGE POWER	170
7.13.7.	CONDUCTED SPURIOUS EMISSIONS	171
8.	RADIATED TEST RESULTS.....	176
8.1.	<i>LIMITS AND PROCEDURE.....</i>	<i>176</i>
8.2.	<i>TRANSMITTER ABOVE 1 GHz.....</i>	<i>177</i>
8.2.1.	ANTENNA B HIGH POWER BASIC DATA RATE GFSK MODULATION.....	177
8.2.2.	ANTENNA B, HIGH POWER ENHANCED DATA RATE 8PSK MODULATION ...	187
8.2.3.	ANTENNA B, LOW POWER BASIC DATA RATE GFSK MODULATION	197
8.2.4.	ANTENNA B, LOW POWER ENHANCED DATA RATE 8PSK MODULATION	207
8.2.5.	ANTENNA C, HIGH POWER BASIC DATA RATE GFSK MODULATION	217
8.2.6.	ANTENNA C, HIGH POWER ENHANCED DATA RATE 8PSK MODULATION ...	227
8.2.7.	ANTENNA C, LOW POWER BASIC DATA RATE GFSK MODULATION	237
8.2.8.	ANTENNA C, LOW POWER ENHANCED DATA RATE 8PSK MODULATION....	247
8.3.	<i>WORST-CASE BELOW 1 GHz.....</i>	<i>257</i>
8.4.	<i>WORST-CASE ABOVE 18 GHz</i>	<i>259</i>
9.	AC POWER LINE CONDUCTED EMISSIONS.....	261
9.1.	<i>EUT POWERED BY AC/DC ADAPTER VIA USB CABLE</i>	<i>262</i>
9.2.	<i>EUT POWERED BY HOST PC VIA USB CABLE</i>	<i>264</i>
10.	SETUP PHOTOS	266

1. ATTESTATION OF TEST RESULTS

COMPANY NAME: APPLE, INC.
1 INFINITE LOOP
CUPERTINO, CA 95014, U.S.A.

EUT DESCRIPTION: TABLET DEVICE

MODEL: A1673

SERIAL NUMBER: DLXQT001H35T (Conducted); DLXQT004H369 (Radiated)

DATE TESTED: NOVEMBER 12, 2015 – FEBRUARY 16, 2016

APPLICABLE STANDARDS	
STANDARD	TEST RESULTS
CFR 47 Part 15 Subpart C	Pass
INDUSTRY CANADA RSS-247 Issue 1	Pass
INDUSTRY CANADA RSS-GEN Issue 4	Pass

UL Verification Services Inc. tested the above equipment in accordance with the requirements set forth in the above standards. All indications of Pass/Fail in this report are opinions expressed by UL Verification Services Inc. based on interpretations and/or observations of test results. Measurement Uncertainties were not taken into account and are published for informational purposes only. The test results show that the equipment tested is capable of demonstrating compliance with the requirements as documented in this report.

Note: The results documented in this report apply only to the tested sample, under the conditions and modes of operation as described herein. This document may not be altered or revised in any way unless done so by UL Verification Services Inc. and all revisions are duly noted in the revisions section. Any alteration of this document not carried out by UL Verification Services Inc. will constitute fraud and shall nullify the document. This report must not be used by the client to claim product certification, approval, or endorsement by NVLAP, NIST, any agency of the Federal Government, or any agency of any government.

Approved & Released For
UL Verification Services Inc. By:

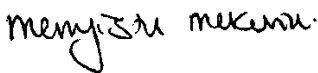

MENGISTU MEKURIA
SENIOR ENGINEER
UL VERIFICATION SERVICES INC.

Tested By:



ERIC YU
EMC ENGINEER
UL VERIFICATION SERVICES INC.

2. TEST METHODOLOGY

The tests documented in this report were performed in accordance with FCC CFR 47 Part 2, FCC CFR 47 Part 15, ANSI C63.10-2013, RSS-GEN Issue 4, and RSS-247 Issue 1.

3. FACILITIES AND ACCREDITATION

The test sites and measurement facilities used to collect data are located at 47173 and 47266 Benicia Street, Fremont, California, USA. Line conducted emissions are measured only at the 47173 address. The following table identifies which facilities were utilized for radiated emission measurements documented in this report. Specific facilities are also identified in the test results sections.

47173 Benicia Street	47266 Benicia Street
<input type="checkbox"/> Chamber A	<input checked="" type="checkbox"/> Chamber D
<input type="checkbox"/> Chamber B	<input checked="" type="checkbox"/> Chamber E
<input type="checkbox"/> Chamber C	<input checked="" type="checkbox"/> Chamber F
	<input type="checkbox"/> Chamber G
	<input type="checkbox"/> Chamber H

The above test sites and facilities are covered under FCC Test Firm Registration # 208313. Chambers A through H are covered under Industry Canada company address code 2324B with site numbers 2324B -1 through 2324B-8, respectively.

UL Verification Services Inc. is accredited by NVLAP, Laboratory Code 200065-0. The full scope of accreditation can be viewed at <http://ts.nist.gov/standards/scopes/2000650.htm>.

4. CALIBRATION AND UNCERTAINTY

4.1. MEASURING INSTRUMENT CALIBRATION

The measuring equipment utilized to perform the tests documented in this report has been calibrated in accordance with the manufacturer's recommendations, and is traceable to recognized national standards.

4.2. SAMPLE CALCULATION

Where relevant, the following sample calculation is provided:

$$\begin{aligned} \text{Field Strength (dBuV/m)} &= \text{Measured Voltage (dBuV)} + \text{Antenna Factor (dB/m)} + \\ &\text{Cable Loss (dB)} - \text{Preamp Gain (dB)} \\ 36.5 \text{ dBuV} + 18.7 \text{ dB/m} + 0.6 \text{ dB} - 26.9 \text{ dB} &= 28.9 \text{ dBuV/m} \end{aligned}$$

4.3. MEASUREMENT UNCERTAINTY

Where relevant, the following measurement uncertainty levels have been estimated for tests performed on the apparatus:

PARAMETER	UNCERTAINTY
Conducted Disturbance, 0.15 to 30 MHz	±3.52 dB
Radiated Disturbance, 30 to 1000 MHz	±4.94 dB

Uncertainty figures are valid to a confidence level of 95%.

5. EQUIPMENT UNDER TEST

5.1. DESCRIPTION OF EUT

The EUT is a tablet with multimedia functions (music, application support, and video), IEEE 802.11a/b/g/n/ac radio, and Bluetooth radio. The rechargeable battery is not user accessible.

5.2. MAXIMUM OUTPUT POWER

The transmitter has a maximum peak conducted output power as follows:

Frequency Range (MHz)	Mode	Output Power (dBm)	Output Power (mW)
2402 - 2480	Basic GFSK Ant. B High Power Mode	17.14	51.76
	Enhanced 8PSK Ant. B High Power Mode	17.03	50.47
	Basic GFSK Ant. B Low Power Mode	10.50	11.22
	Enhanced 8PSK Ant. B Low Power Mode	10.27	10.64
	Basic GFSK Ant. C High Power Mode	15.63	36.56
	Enhanced 8PSK Ant. C High Power Mode	17.04	50.58
	Basic GFSK Ant. C Low Power Mode	9.50	8.91
	Enhanced 8PSK Ant. C Low Power Mode	10.27	10.64

5.3. DESCRIPTION OF AVAILABLE ANTENNAS

Frequency Band (GHz)	Antenna Gain (dBi)	
	Antenna B	Antenna C
2.4	-1.75	1.06

5.4. SOFTWARE AND FIRMWARE

The software installed in the EUT during testing was 13E31820k.

5.5. WORST-CASE CONFIGURATION AND MODE

Radiated emission and power line conducted emission were performed with the EUT set to transmit at the channel with highest output power as worst-case scenario.

The fundamental of the EUT was investigated in three orthogonal orientations X/Y/Z, it was determined that Y orientation was worst-case orientation. Therefore, all final radiated testing was performed with the EUT in Y orientation.

Worst-case data rates were:

GFSK mode: DH5
8PSK mode: 3-DH5

DQPSK mode has been verified to have the lowest power.

For simultaneous transmission of multiple channels from the same antenna in the 2.4GHz and 5GHz bands, tests were conducted for various configurations having the highest power. No noticeable new emission was found.

There are two vendors of the WiFi/Bluetooth radio modules: variant 1 and variant 2. The WiFi/Bluetooth radio modules have the same mechanical outline (e.g., the same package dimension and pin-out layout), use the same on-board antenna matching circuit, have an identical antenna structure, and are built and tested to conform to the same specifications and to operate within the same tolerances.

Baseline testing was performed on the two variants to determine the worst case on all conducted power and radiated emissions.

5.6. DESCRIPTION OF TEST SETUP

SUPPORT EQUIPMENT

Description	Manufacturer	Model	Serial Number	FCC ID
Laptop	Dell	Latitude 3540	6LNG802	N/A
Laptop AC/DC adapter	Dell	FA90PE1-00	CN-0CM889-73245-95L-4954-A00	N/A
Earphone	Apple	NA	NA	N/A
EUT AC/DC adapter	Apple	A1385	D293062F3WVDHLHCF	N/A

I/O CABLES (CONDUCTED TEST)

I/O Cable List						
Cable No	Port	# of identical ports	Connector Type	Cable Type	Cable Length (m)	Remarks
1	Antenna	1	SMA	Un-Shielded	0.2	To spectrum Analyzer
2	USB	1	USB	Shielded	1	N/A
3	AC	1	AC	Un-shielded	3	N/A

I/O CABLES (RADIATED ABOVE 1 GHZ)

I/O Cable List						
Cable No	Port	# of identical ports	Connector Type	Cable Type	Cable Length (m)	Remarks
None Used						

I/O CABLES (RADAITED BELOW 1 GHZ)

I/O Cable List						
Cable No	Port	# of identical	Connector Type	Cable Type	Cable Length (m)	Remarks
1	Headphones Jack	1	3.5mm Audio	Shielded	0.9	N/A
2	AC	1	AC	Un-shielded	3	N/A

I/O CABLES (AC LINE CONDUCTED: AC/DC ADAPTER)

I/O Cable List						
Cable No	Port	# of identical	Connector Type	Cable Type	Cable Length (m)	Remarks
1	Headphones Jack	1	3.5mm Audio	Shielded	0.9	N/A
2	AC	1	AC	Un-shielded	3	N/A

I/O CABLES (AC LINE CONDUCTED: LAPTOP CONFIGUARTION)

I/O Cable List						
Cable No	Port	# of identical	Connector Type	Cable Type	Cable Length (m)	Remarks
1	Headphones Jack	1	3.5mm Audio	Shielded	0.9	N/A
2	USB	1	USB	Shielded	1	N/A
3	AC	1	AC	Un-shielded	3	N/A

TEST SETUP - CONDUCTED TESTS

The EUT was tested connected to a host Laptop via USB cable adapter and spectrum analyzer to antenna port. Test software exercised the EUT.

SETUP DIAGRAM

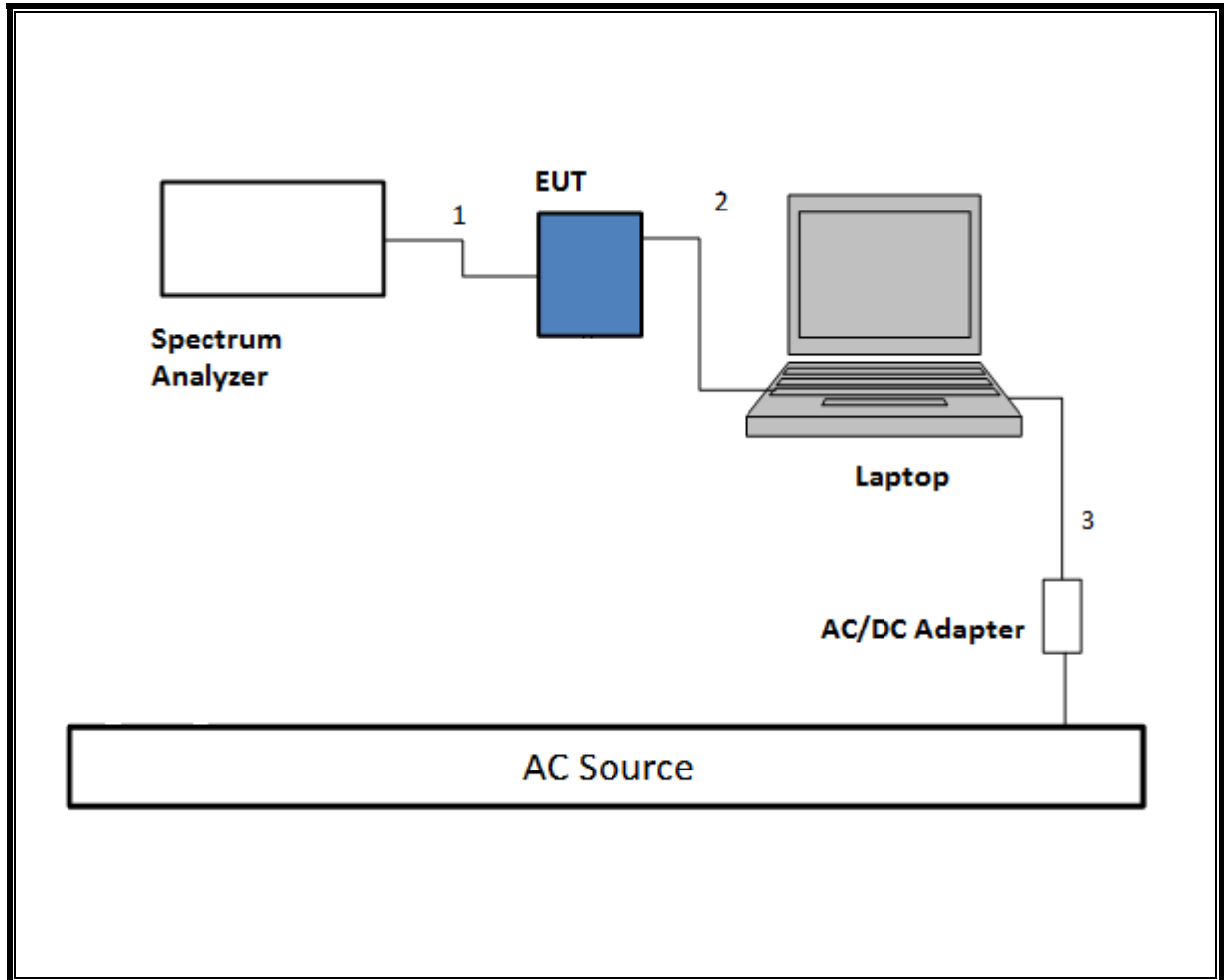

TEST SETUP- RADIATED-ABOVE 1 GHZ

The EUT was tested battery powered. Test software exercised the EUT.

SETUP DIAGRAM

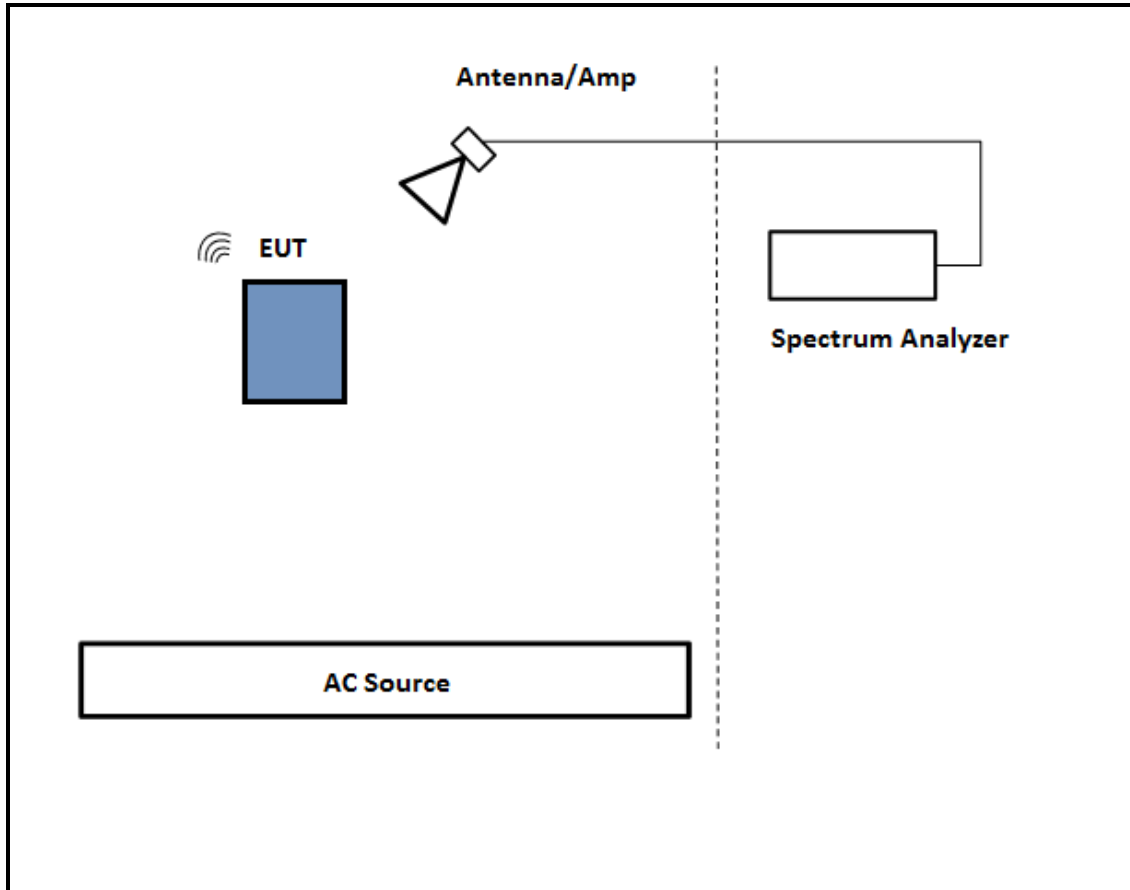

TEST SETUP- BELOW 1GHz

The EUT was tested with earphone connected and powered by AC adapter. Test software exercised the EUT.

SETUP DIAGRAM

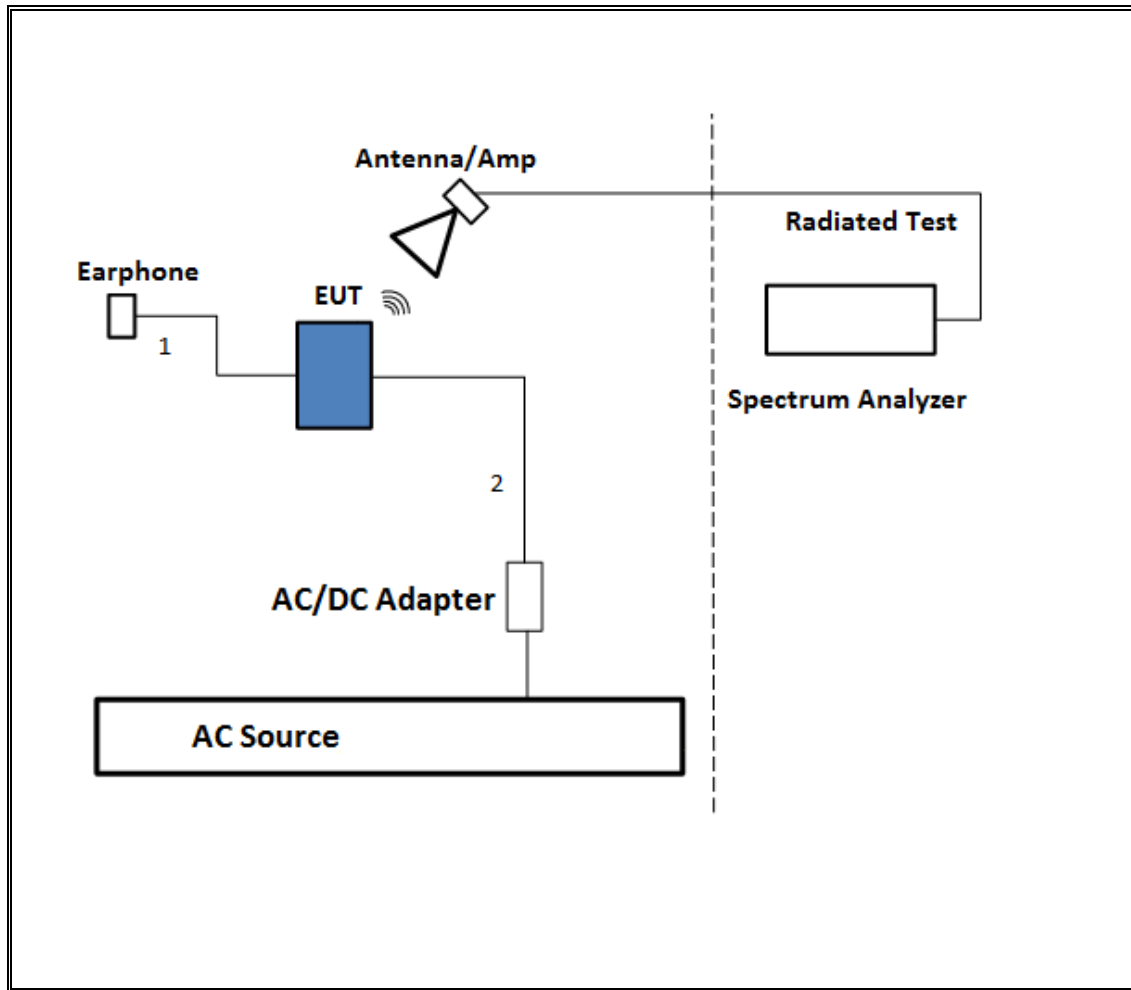

TEST SETUP- AC LINE CONDUCTED: AC/DC ADAPTER

The EUT was tested with earphone connected and powered by AC/DC adapter via USB cable. Test software exercised the EUT.

SETUP DIAGRAM

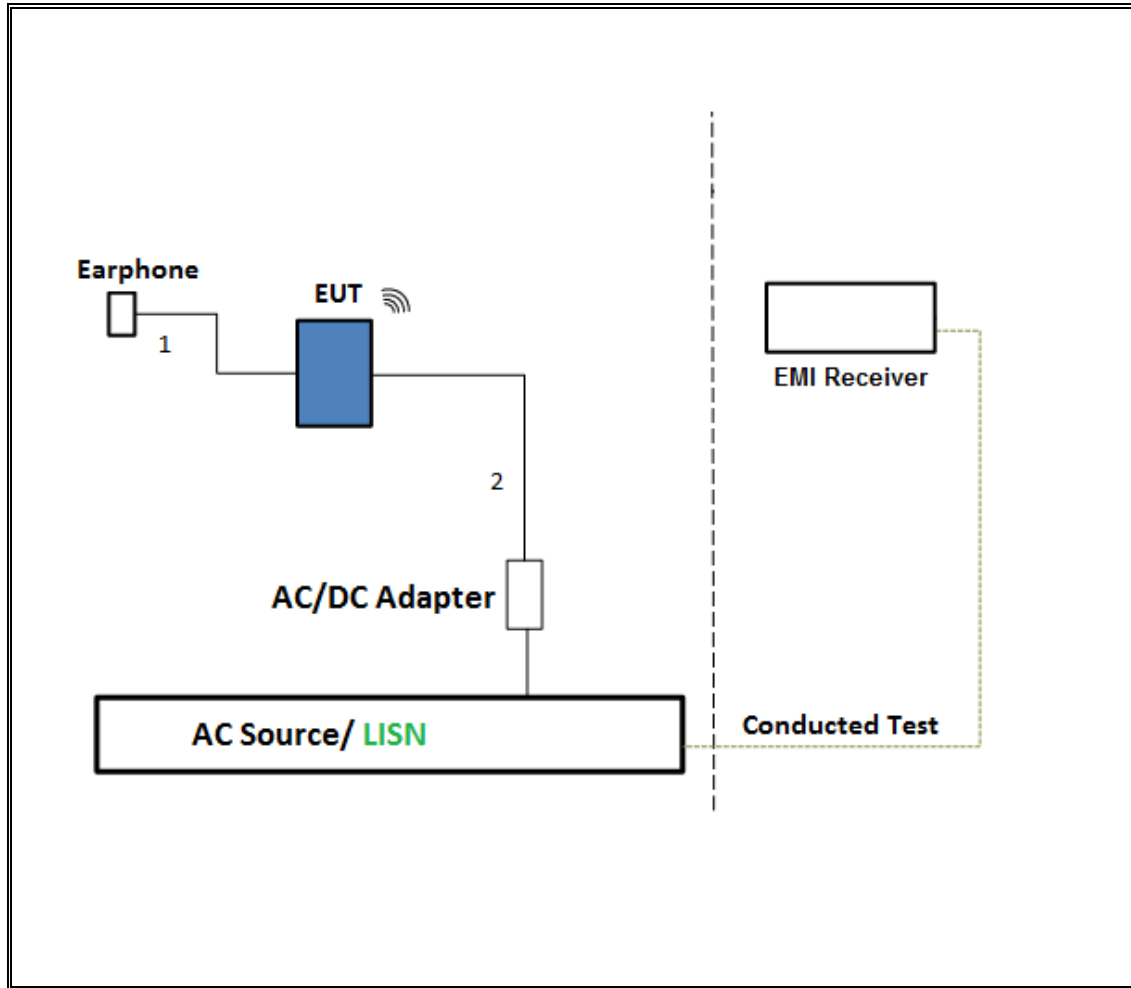

TEST SETUP- AC LINE CONDUCTED: LAPTOP CONFIGURATION

The EUT was tested with earphone connected and powered by host PC via USB cable. Test software exercised the EUT.

SETUP DIAGRAM

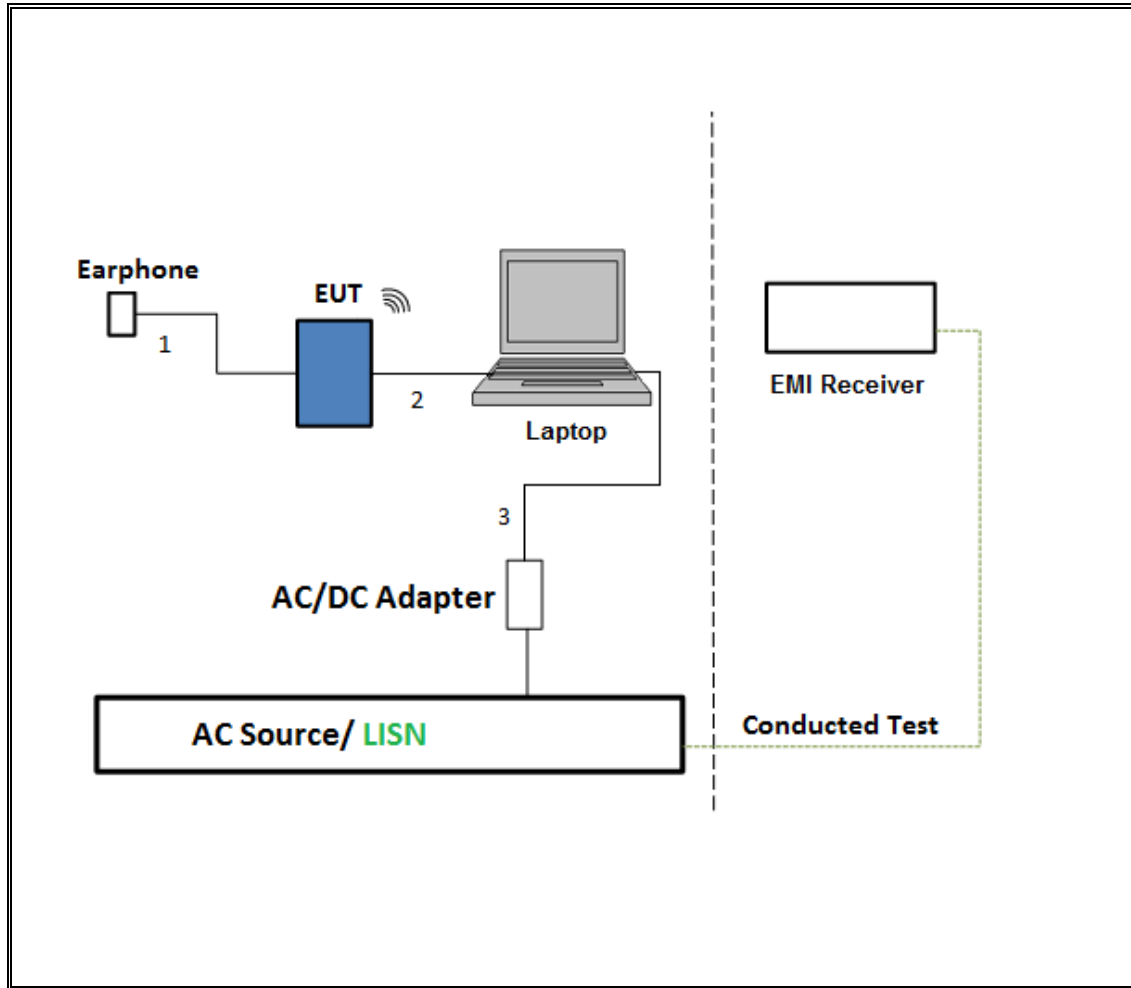

6. TEST AND MEASUREMENT EQUIPMENT

The following test and measurement equipment was utilized for the tests documented in this report:

Test Equipment List				
Description	Manufacturer	Model	Cal Date	Cal Due
Antenna, Horn 1-18GHz	ETS Lindgren	3117	2/10/2015	**2/10/2016
Antenna, Broadband Hybrid, 30MHz to 2000MHz	Sunol Sciences	JB1	3/5/2015	3/5/2016
**Amplifier, 1 - 18GHz	Miteq	AFS42-00101800-25-S-42	1/26/2015	1/26/2016
Amplifier, 10KHz to 1GHz, 32dB	Sonoma	310N	5/7/2015	5/7/2016
Antenna, Horn 1-18GHz	ETS Lindgren	3117	1/12/2016	1/12/2017
Amplifier, 1 - 18GHz	Miteq	AFS42-00101800-25-S-42	8/12/2015	8/12/2016
Spectrum Analyzer, PXA, 3Hz to 44GHz	Keysight	N9030A	6/2/2015	3/31/2016
Spectrum Analyzer, PXA, 3Hz to 44GHz	Agilent	N9030A	11/16/2015	11/16/2016
Spectrum Analyzer, PXA, 3Hz to 44GHz	Agilent	N9030A	11/19/2015	11/19/2016
Power Meter, P-series single channel	Agilent	N1911A	4/7/2015	4/7/2016
Power Sensor, P - series, 50MHz to 18GHz, Wideband	Agilent	N1921A	2/27/2015	2/27/2016
Antenna, Horn 18 to 26.5GHz	ARA	MWH-1826	5/12/2015	5/12/2016
Spectrum Analyzer, 40 GHz	Agilent	8564E	8/14/2015	8/14/2016
Amplifier, 1 to 26.5GHz, 23.5dB Gain minimum	Agilent	8449B	6/29/2015	6/29/2016
AC Line Conducted				
EMI Test Receiver 9Khz-7GHz	ohde & Schwa	ECSI7	08/07/15	08/07/16
**LISN for Conducted Emissions CISPR-16	FCC	50/250-25-2	01/16/15	01/16/16
LISN for Conducted Emissions CISPR-16	Fisher	50/250-2-01	09/16/15	09/16/16
Power Cable, Line Conducted Emissions	UL	PG1	7/28/2015	7/28/2016
UL SOFTWARE				
* Radiated Software	UL	UL EMC	Ver 9.5, July 22, 2014	
* Conducted Software	UL	UL EMC	Ver 2.2, March 31, 2015	
* AC Line Conducted Software	UL	UL EMC	Ver 9.5, April 3, 2015	

Note: * indicates automation software version used in the compliance certification testing
 ** Testing is completed before equipment calibration expiration date.

7. ANTENNA PORT TEST RESULTS

7.1. ON TIME AND DUTY CYCLE

LIMITS

None; for reporting purposes only.

PROCEDURE

KDB 558074 Zero-Span Spectrum Analyzer Method.

ON TIME AND DUTY CYCLE RESULTS

Mode	ON Time B (msec)	Period (msec)	Duty Cycle x (linear)	Duty Cycle (%)	Duty Cycle Correction Factor (dB)	1/B Minimum VBW (kHz)
BT GFSK Ant. B High Power	100.000	100.000	1.000	100.00%	0.00	0.010
BT GFSK Ant. B Low Power	100.000	100.000	1.000	100.00%	0.00	0.010
BT 8PSK Ant. B High Power	100.000	100.000	1.000	100.00%	0.00	0.010
BT 8PSK Ant. B Low Power	100.000	100.000	1.000	100.00%	0.00	0.010
BT GFSK Ant. C High Power	100.000	100.000	1.000	100.00%	0.00	0.010
BT GFSK Ant. C Low Power	100.000	100.000	1.000	100.00%	0.00	0.010
BT 8PSK Ant. C High Power	100.000	100.000	1.000	100.00%	0.00	0.010
BT GFSK Ant. C Low Power	100.000	100.000	1.000	100.00%	0.00	0.010

DUTY CYCLE PLOTS

HOPPING OFF

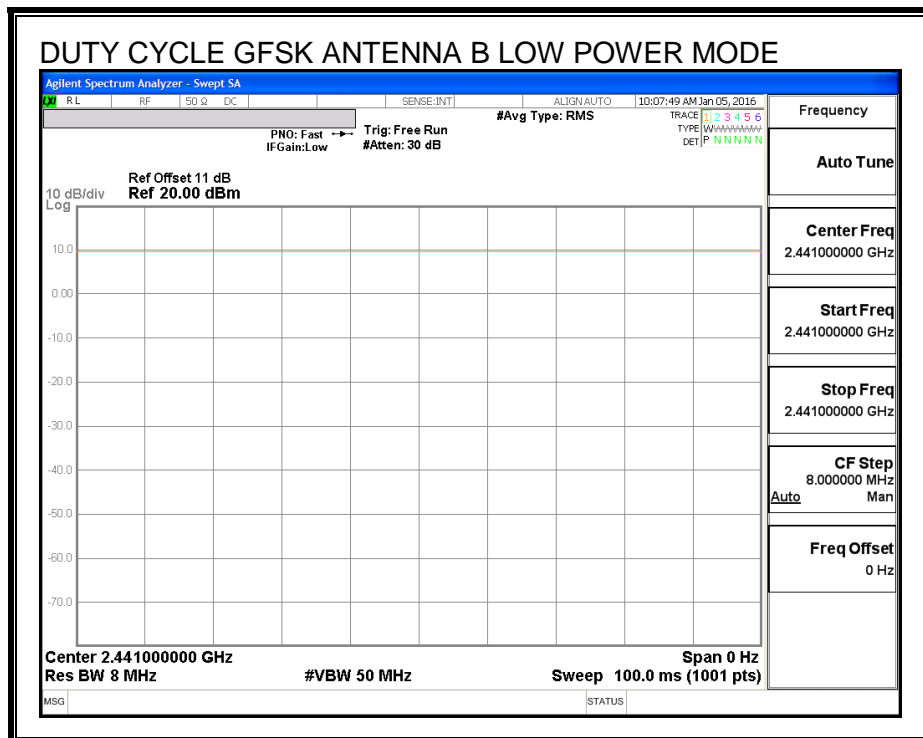
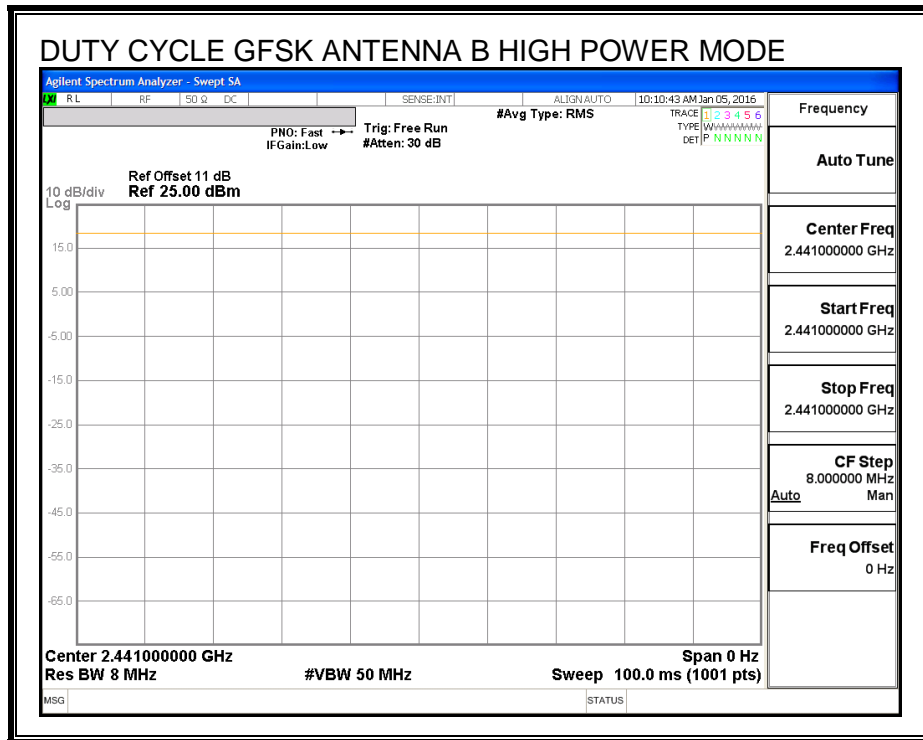

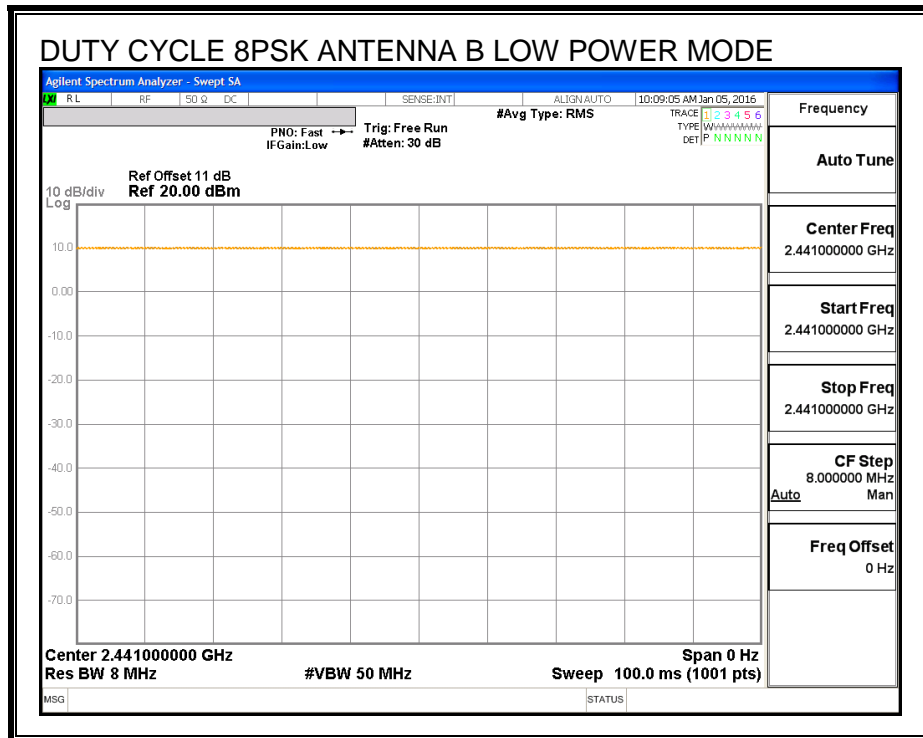
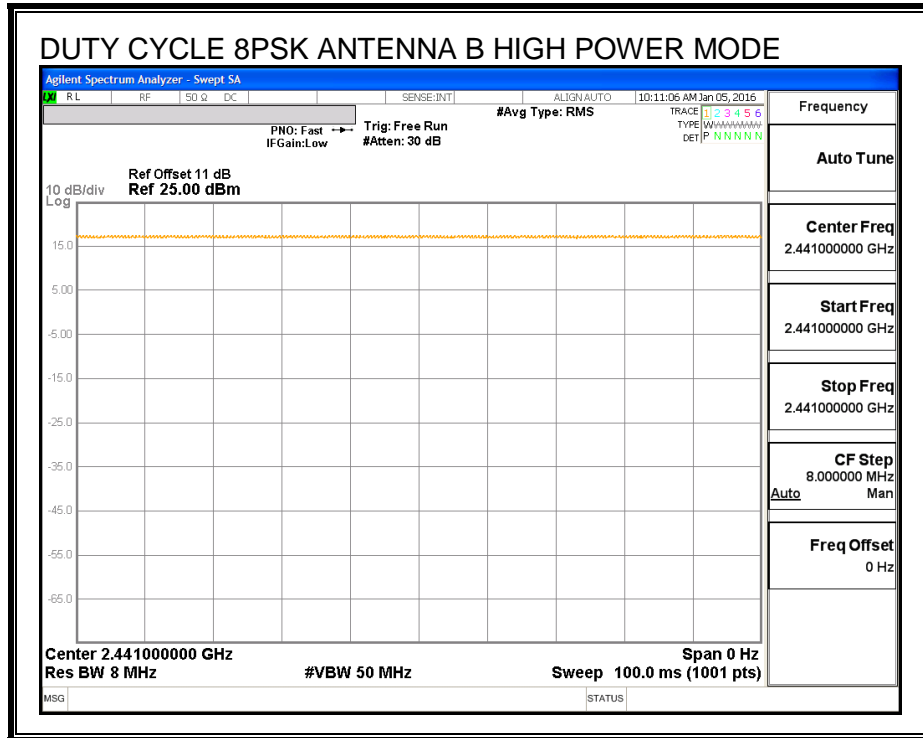

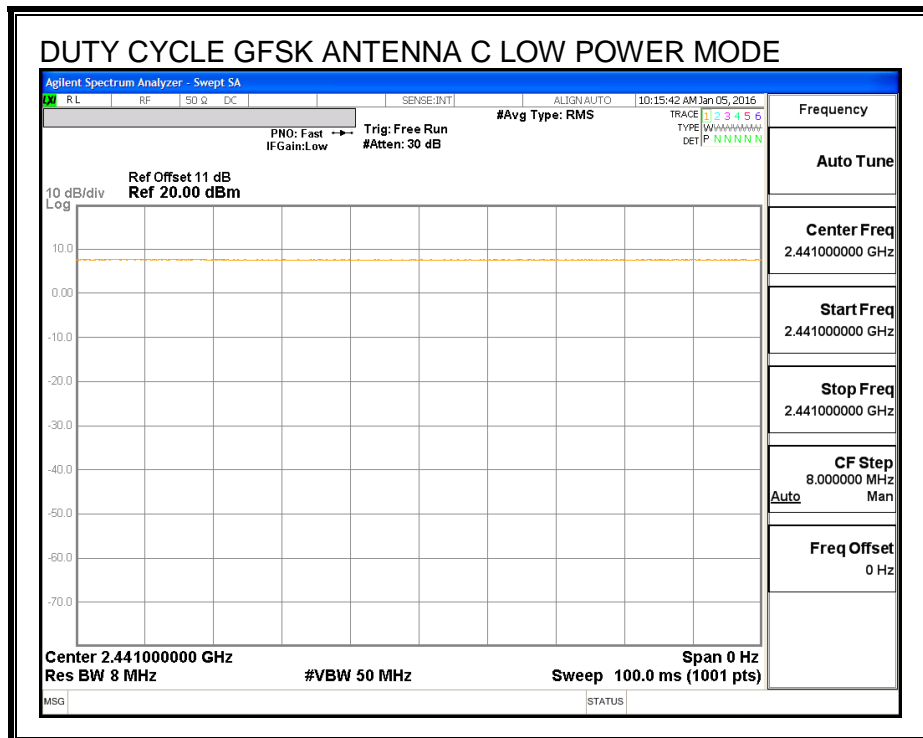
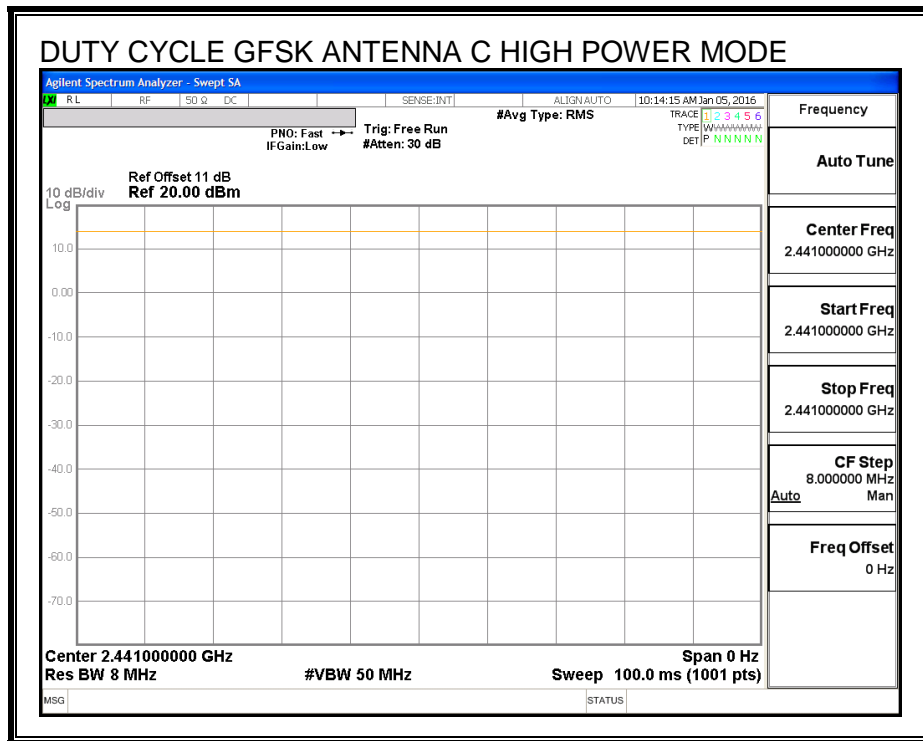

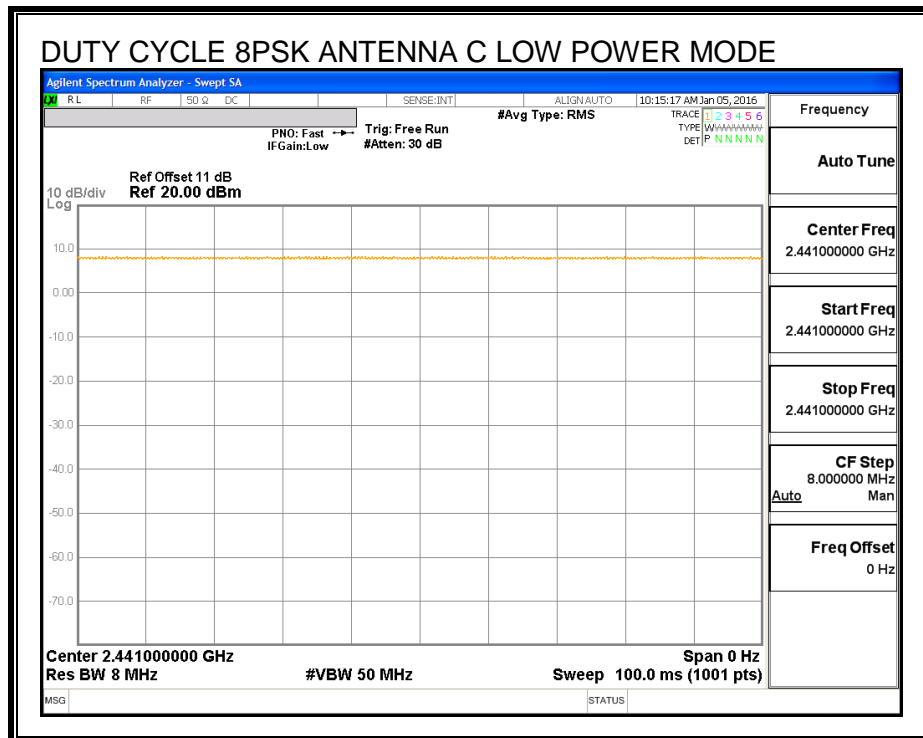
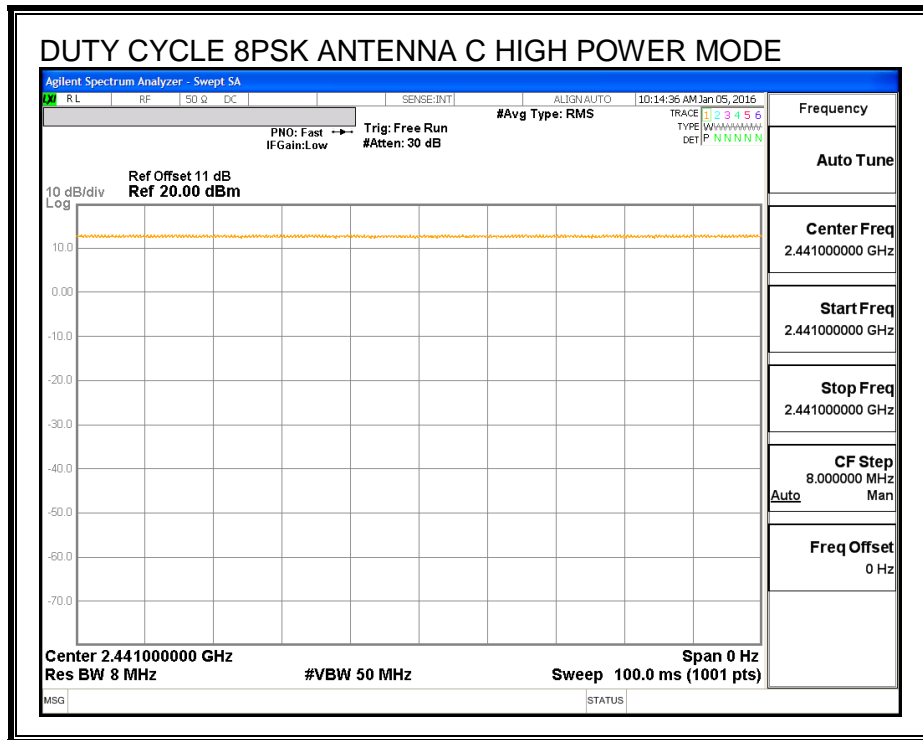

7.2. ANTENNA B HIGH POWER BASIC DATA RATE GFSK MODULATION

7.2.1. 20 dB AND 99% BANDWIDTH

LIMIT

None; for reporting purposes only.

TEST PROCEDURE

The transmitter output is connected to a spectrum analyzer. The RBW is set to $\geq 1\%$ of the 20 dB bandwidth. The VBW is set to \geq RBW. The sweep time is coupled.

RESULTS

Channel	Frequency (MHz)	20 dB Bandwidth (KHz)	99% Bandwidth (KHz)
Low	2402	880.9	885.26
Middle	2441	874.7	886.33
High	2480	881.8	883.42

20 dB AND 99% BANDWIDTH

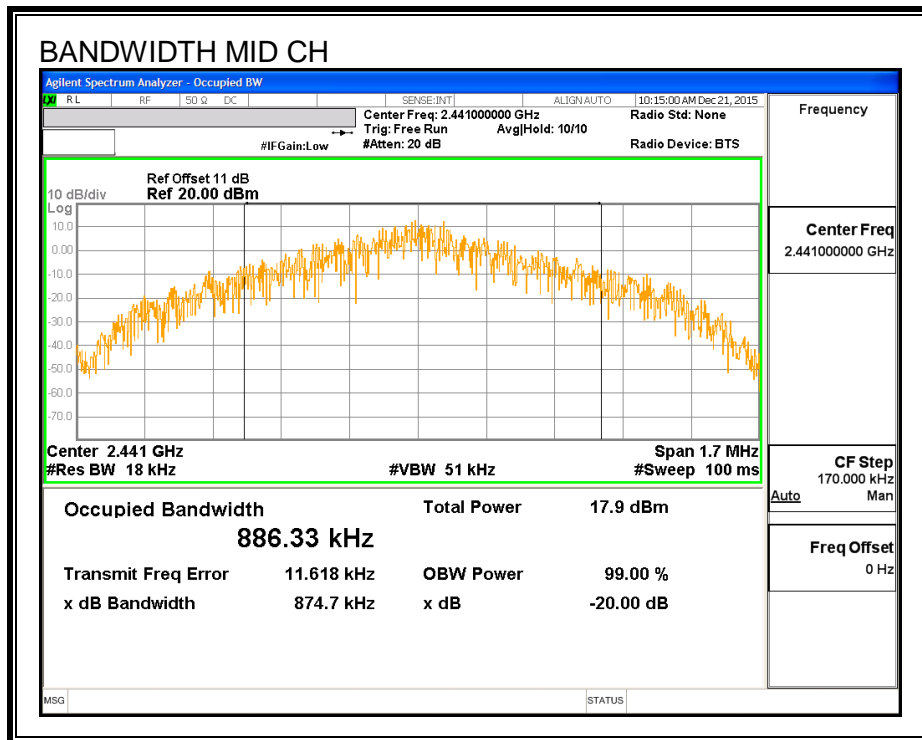
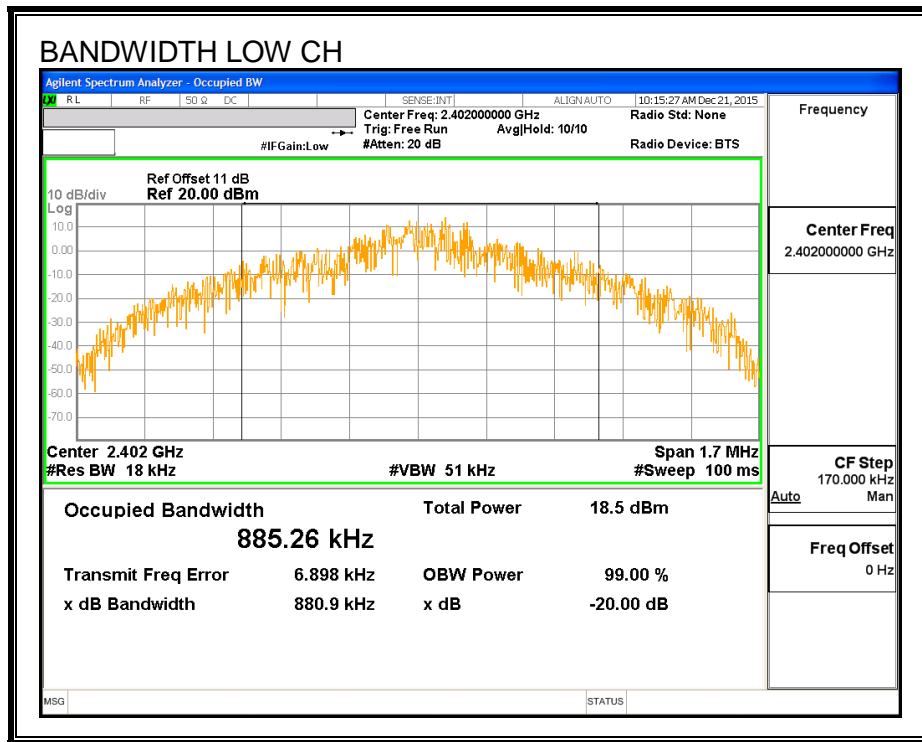

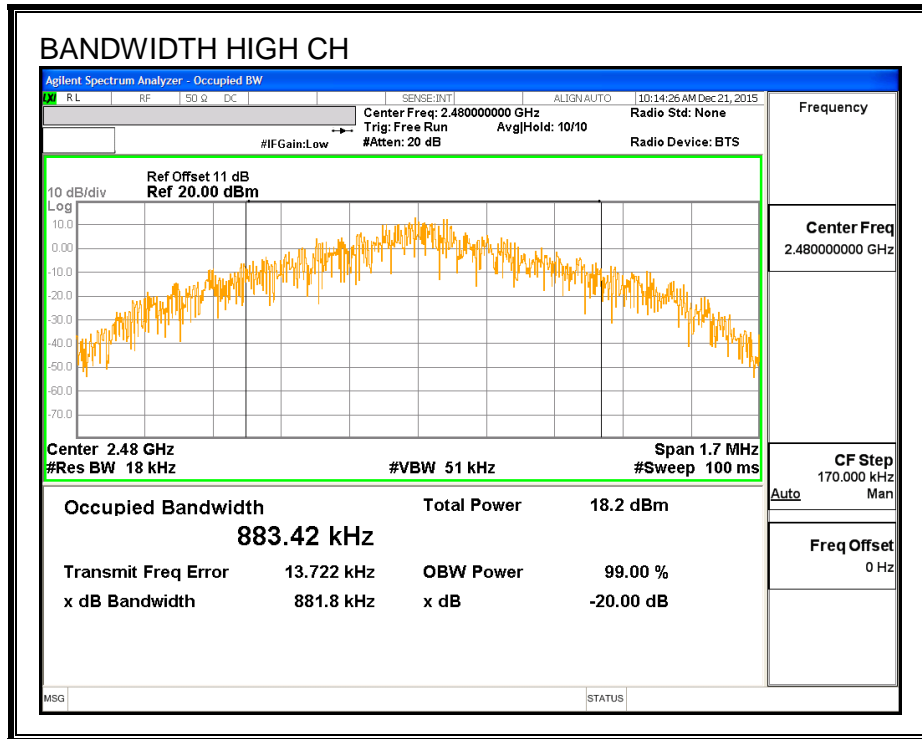

7.2.2. HOPPING FREQUENCY SEPARATION

LIMIT

FCC §15.247 (a) (1)

IC RSS-247 (5.1) (2)

Frequency hopping systems shall have hopping channel carrier frequencies separated by a minimum of 25 kHz or the 20 dB bandwidth of the hopping channel, whichever is greater.

Alternatively, frequency hopping systems operating in the 2400-2483.5 MHz band may have hopping channel carrier frequencies that are separated by 25 kHz or two-thirds of the 20 dB bandwidth of the hopping channel, whichever is greater, provided the systems operate with an output power no greater than 125 mW.

TEST PROCEDURE

The transmitter output is connected to a spectrum analyzer. The RBW is set to 300 kHz and the VBW is set to 910 kHz. The sweep time is coupled.

RESULTS

HOPPING FREQUENCY SEPARATION

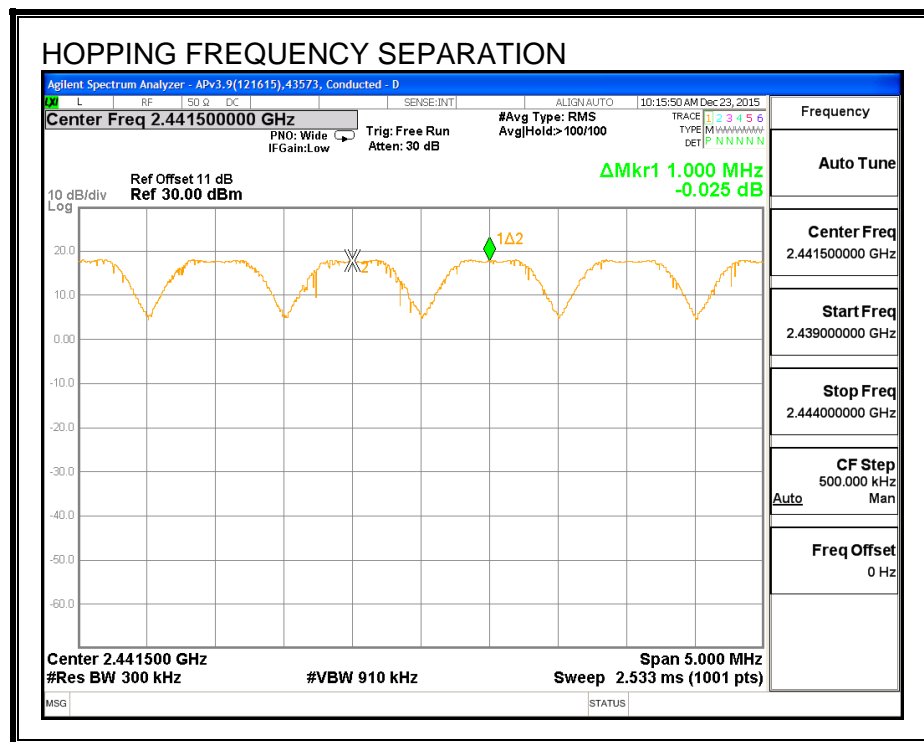

7.2.3. NUMBER OF HOPPING CHANNELS

LIMIT

FCC §15.247 (a) (1) (iii)

IC RSS-247 (5.1) (4)

Frequency hopping systems in the 2400 – 2483.5 MHz band shall use at least 15 non-overlapping channels.

TEST PROCEDURE

The transmitter output is connected to a spectrum analyzer. The span is set to cover the entire authorized band, in either a single sweep or in multiple contiguous sweeps. The RBW is set to a maximum of 1 % of the span. The analyzer is set to Max Hold.

RESULTS

Normal Mode: 79 Channels observed.

NUMBER OF HOPPING CHANNELS

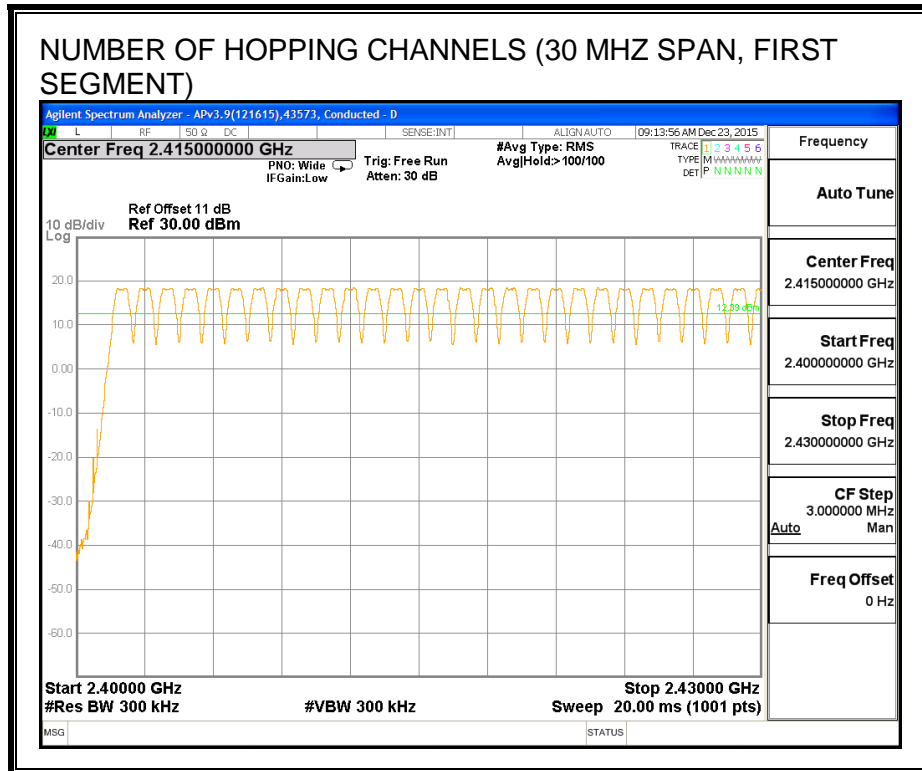
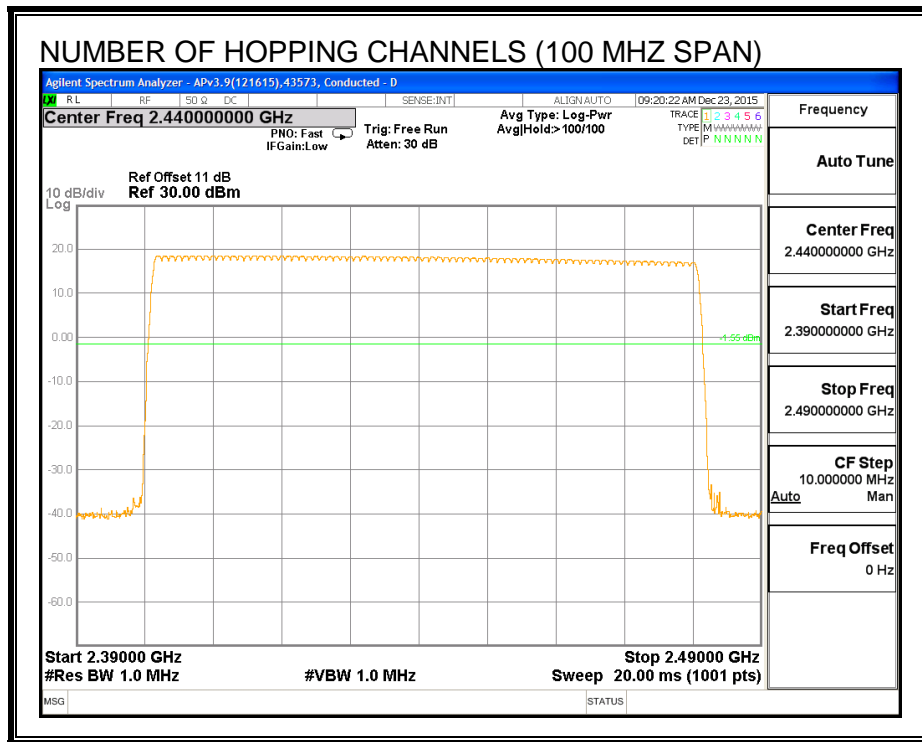

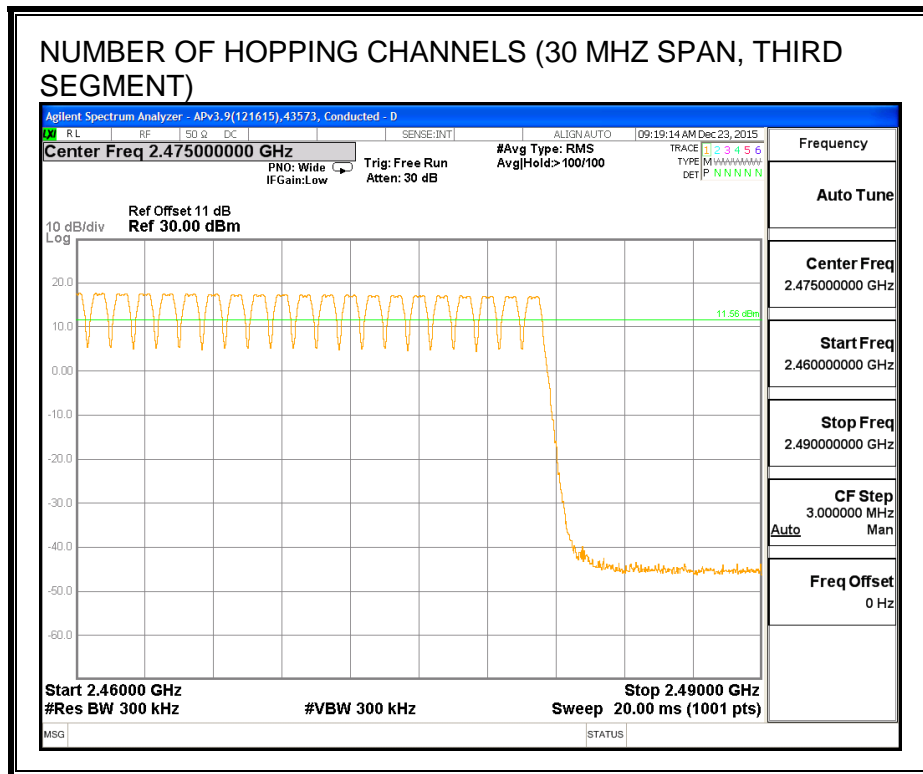
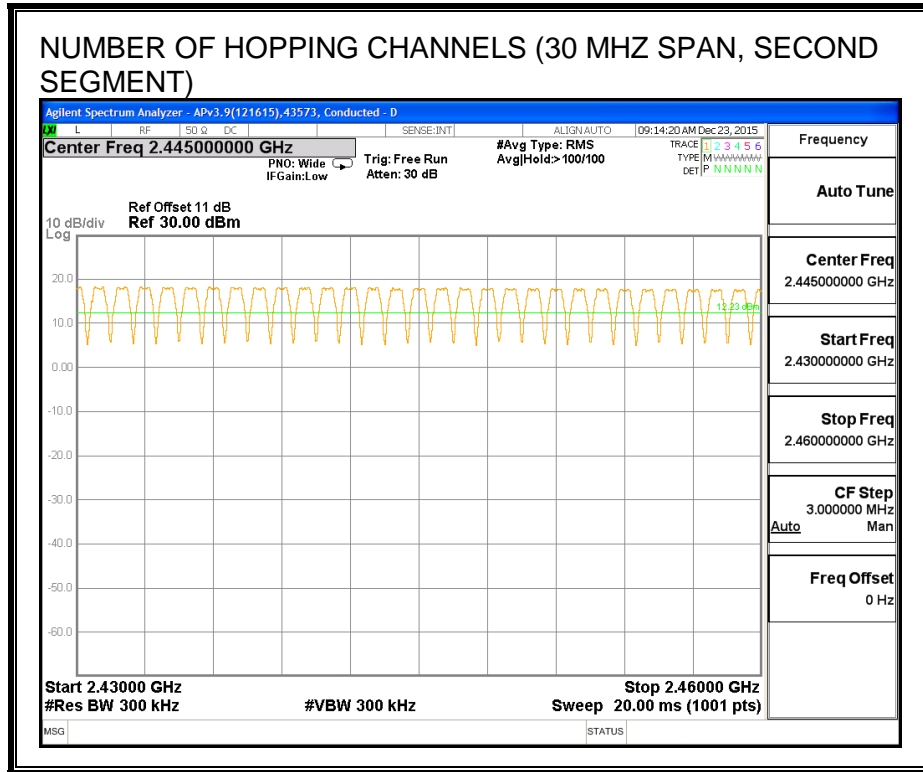

7.2.4. AVERAGE TIME OF OCCUPANCY

LIMIT

FCC §15.247 (a) (1) (iii)

IC RSS-247 (5.1) (4)

The average time of occupancy on any channel shall not be greater than 0.4 seconds within a period of 0.4 seconds multiplied by the number of hopping channels employed.

TEST PROCEDURE

The transmitter output is connected to a spectrum analyzer. The span is set to 0 Hz, centered on a single, selected hopping channel. The width of a single pulse is measured in a fast scan. The number of pulses is measured in a 3.16 second scan, to enable resolution of each occurrence.

The average time of occupancy in the specified 31.6 second period (79 channels * 0.4 s) is equal to $10 * (\# \text{ of pulses in } 3.16 \text{ s}) * \text{ pulse width}$.

For AFH mode, the average time of occupancy in the specified 8 second period (20 channels * 0.4 seconds) is equal to $10 * (\# \text{ of pulses in } 0.8 \text{ s}) * \text{ pulse width}$.

RESULTS

DH Packet	Pulse Width (msec)	Number of Pulses in 3.16 seconds	Average Time of Occupancy (sec)	Limit (sec)	Margin (sec)
GFSK Normal Mode					
DH1	0.394	32	0.126	0.4	-0.274
DH3	1.650	19	0.314	0.4	-0.087
DH5	2.896	12	0.348	0.4	-0.052

PULSE WIDTH - DH1

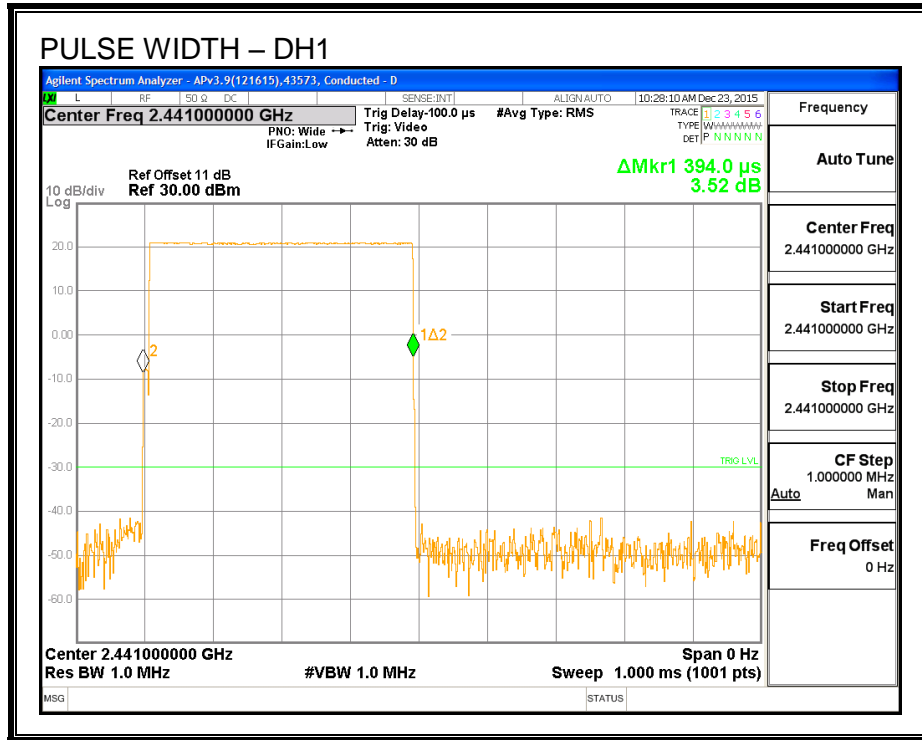

NUMBER OF PULSES IN 3.16 SECOND OBSERVATION PERIOD – DH1

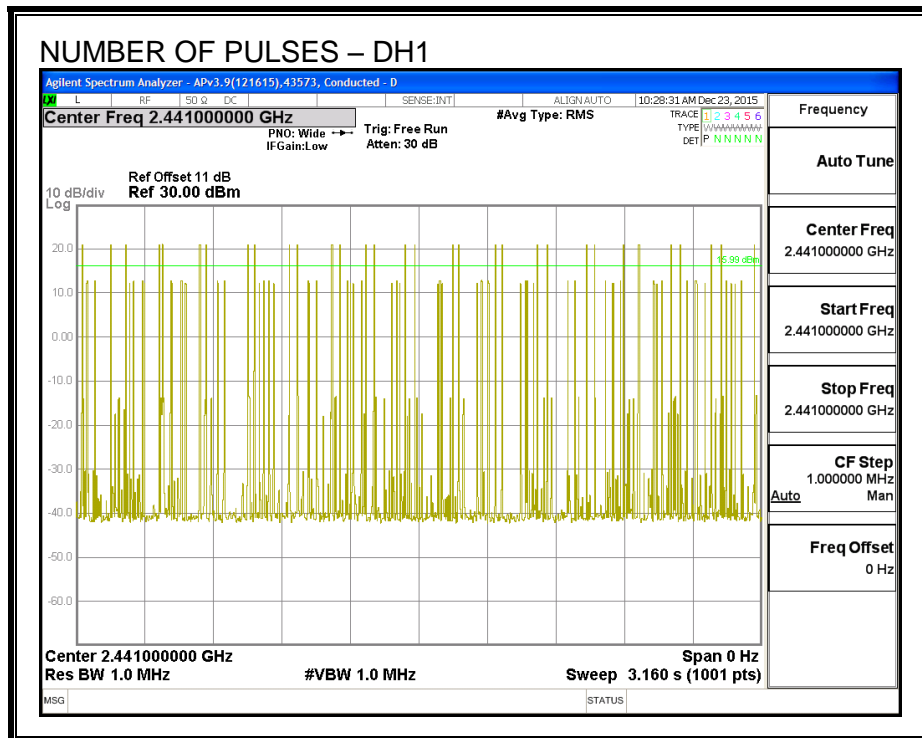

PULSE WIDTH – DH3

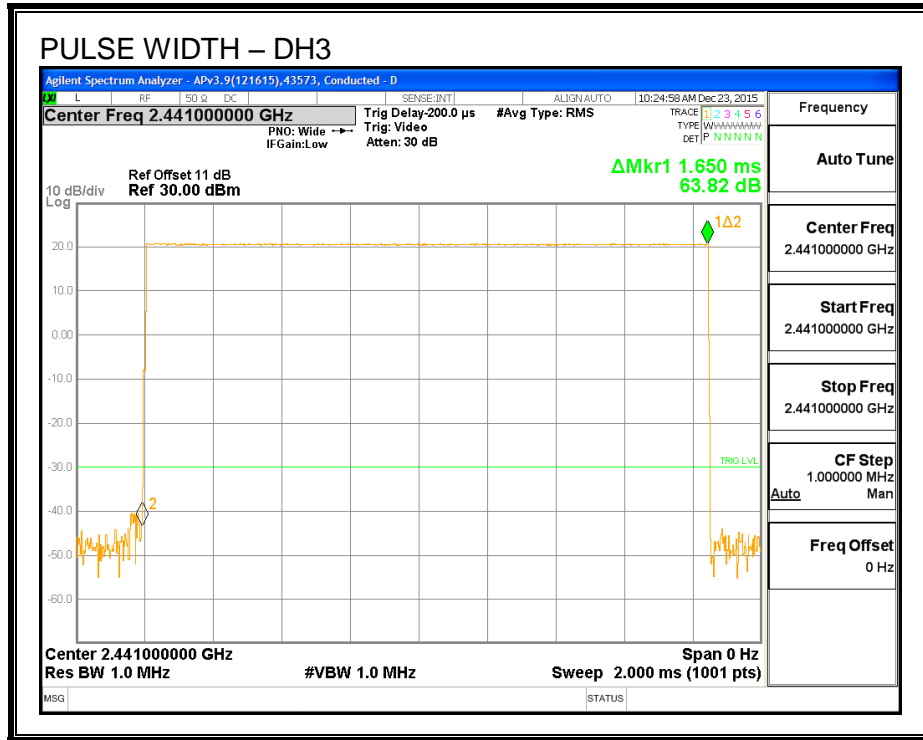

NUMBER OF PULSES IN 3.16 SECOND OBSERVATION PERIOD – DH3

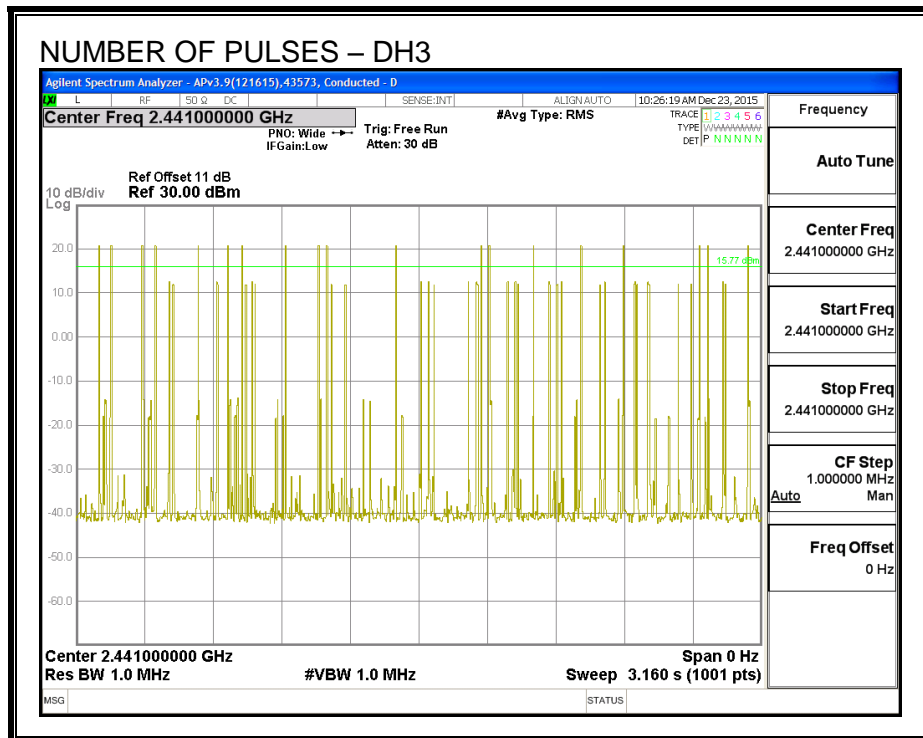

PULSE WIDTH – DH5

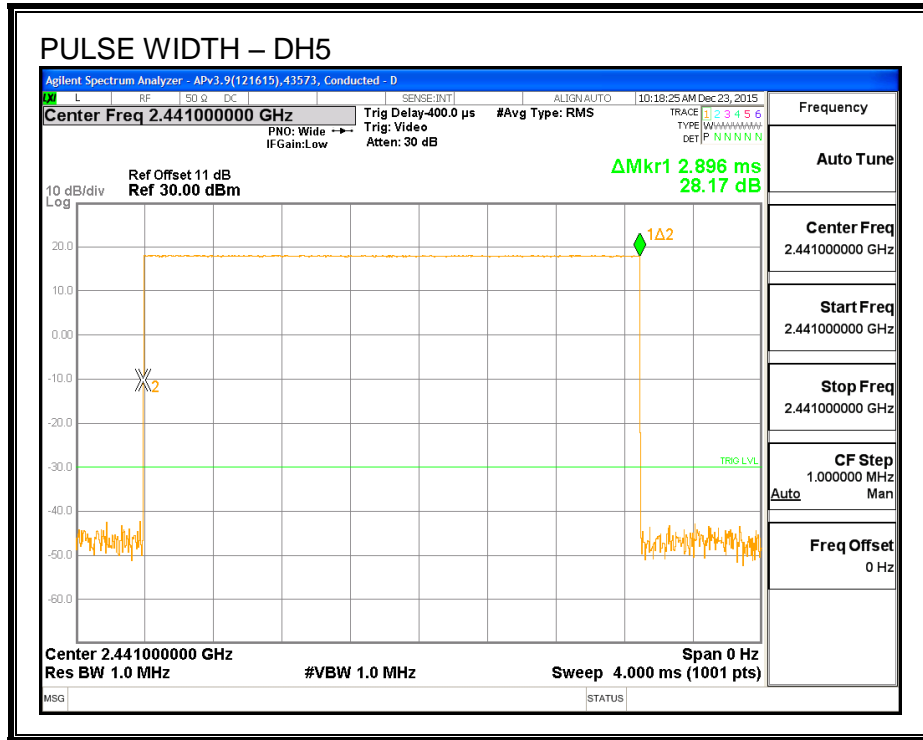

NUMBER OF PULSES IN 3.16 SECOND OBSERVATION PERIOD – DH5

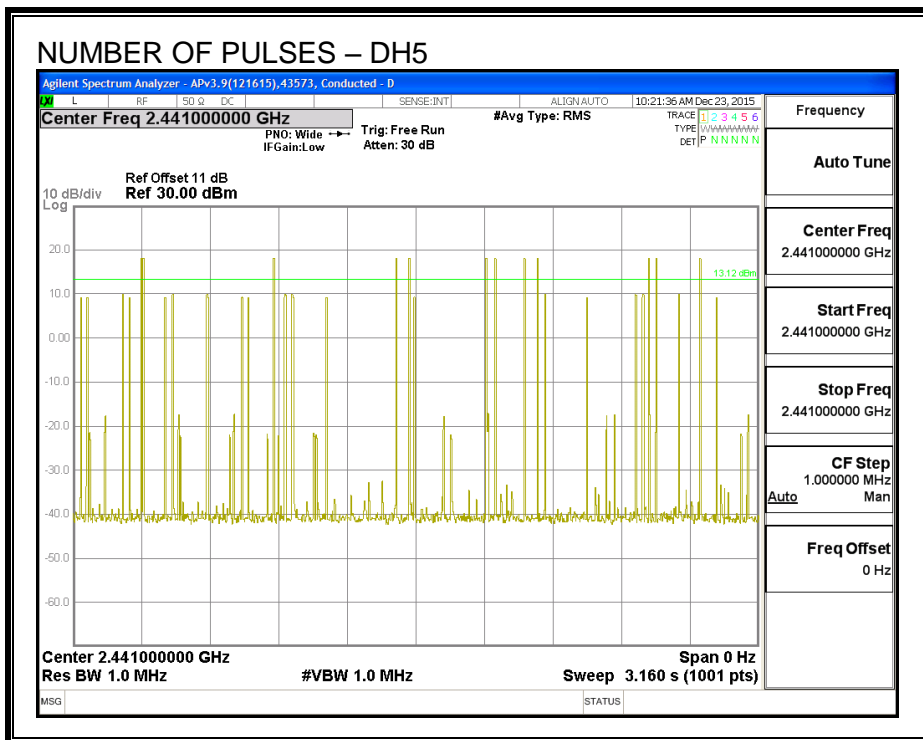

7.2.5. OUTPUT POWER

LIMIT

§15.247 (b) (1)

RSS-247 (5.4) (2)

The maximum antenna gain is less than 6 dBi, therefore the limit is 30 dBm.

TEST PROCEDURE

The transmitter output is connected to a wideband peak and average power meter.

RESULTS

Channel	Frequency (MHz)	Output Power (dBm)	Limit (dBm)	Margin (dB)
Low	2402	17.14	30	-12.86
Middle	2441	16.91	30	-13.09
High	2480	16.69	30	-13.31

7.2.6. AVERAGE POWER

LIMIT

None; for reporting purposes only.

TEST PROCEDURE

The transmitter output is connected to a power meter.

RESULTS

The cable assembly insertion loss of 11 dB (including 10 dB pad and 1 dB cable) was entered as an offset in the power meter to allow for direct reading of power.

Channel	Frequency (MHz)	Average Power (dBm)
Low	2402	16.88
Middle	2441	16.63
High	2480	16.37

7.2.7. CONDUCTED SPURIOUS EMISSIONS

LIMITS

FCC §15.247 (d)

IC RSS-247 (5.5)

Limit = -20 dBc

TEST PROCEDURE

The transmitter output is connected to a spectrum analyzer. The resolution bandwidth is set to 100 kHz. The video bandwidth is set to 300 kHz.

The spectrum from 30 MHz to 26 GHz is investigated with the transmitter set to the lowest, middle, and highest channels.

The bandedges at 2.4 and 2.4835 GHz are investigated with the transmitter set to the normal hopping mode.

RESULTS

SPURIOUS EMISSIONS, LOW CHANNEL

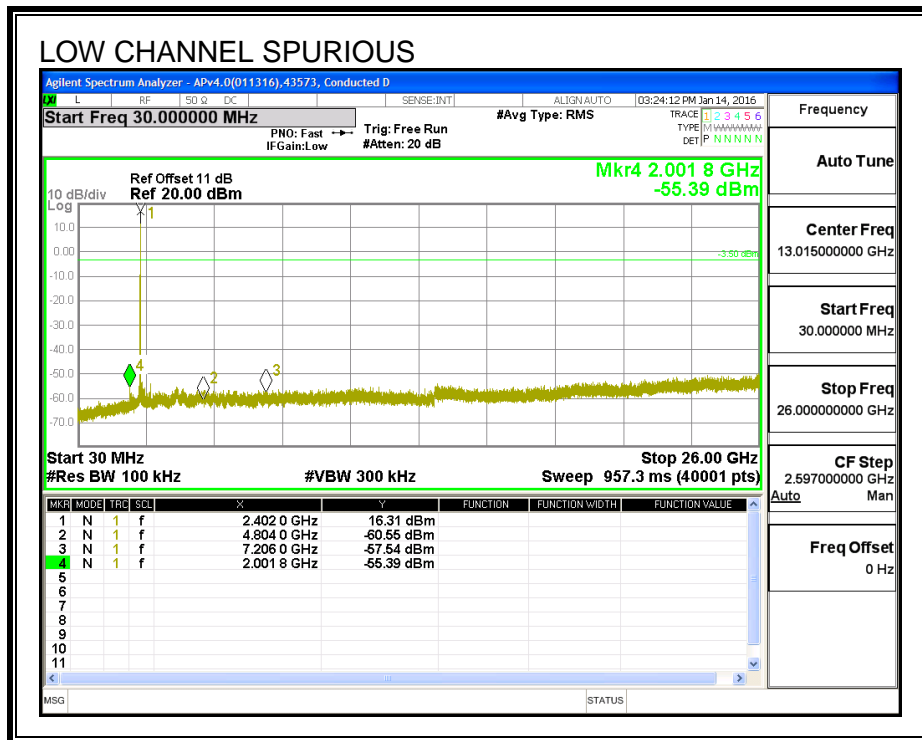
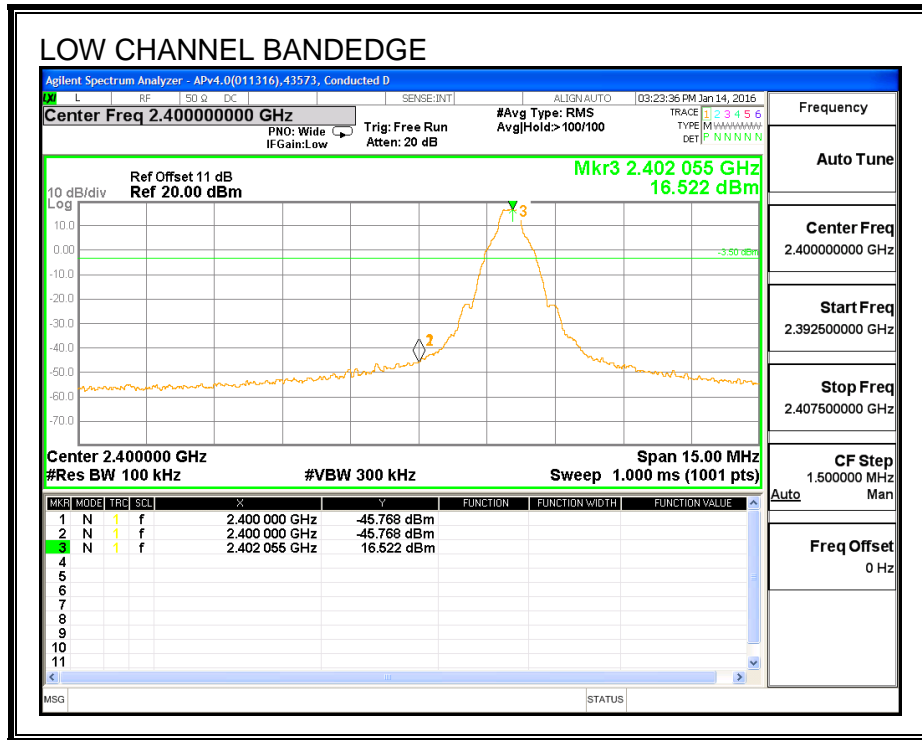

SPURIOUS EMISSIONS, MID CHANNEL

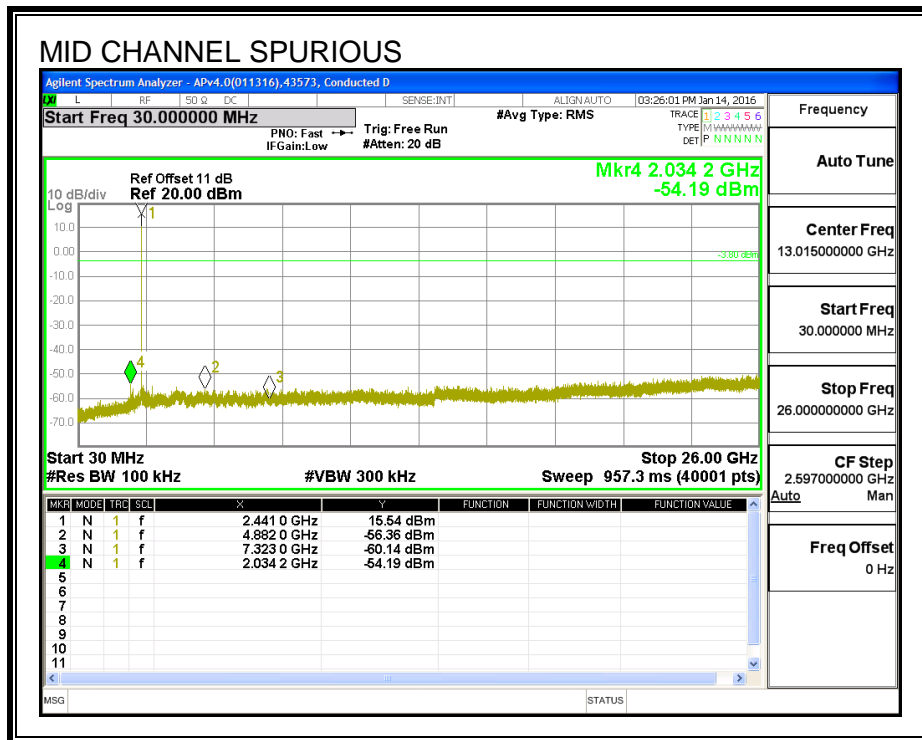
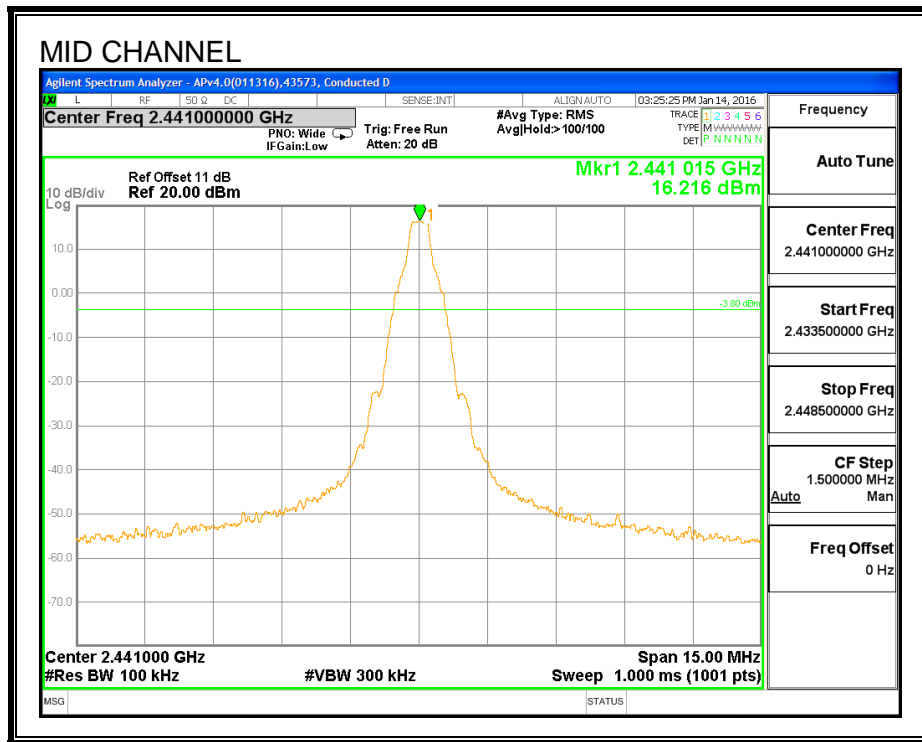

SPURIOUS EMISSIONS, HIGH CHANNEL

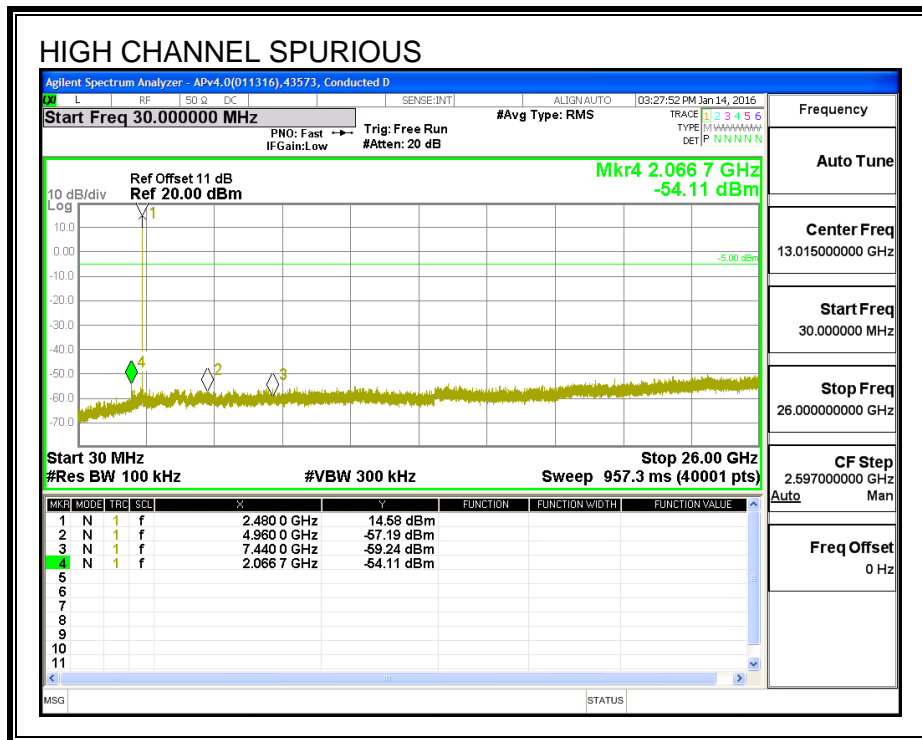
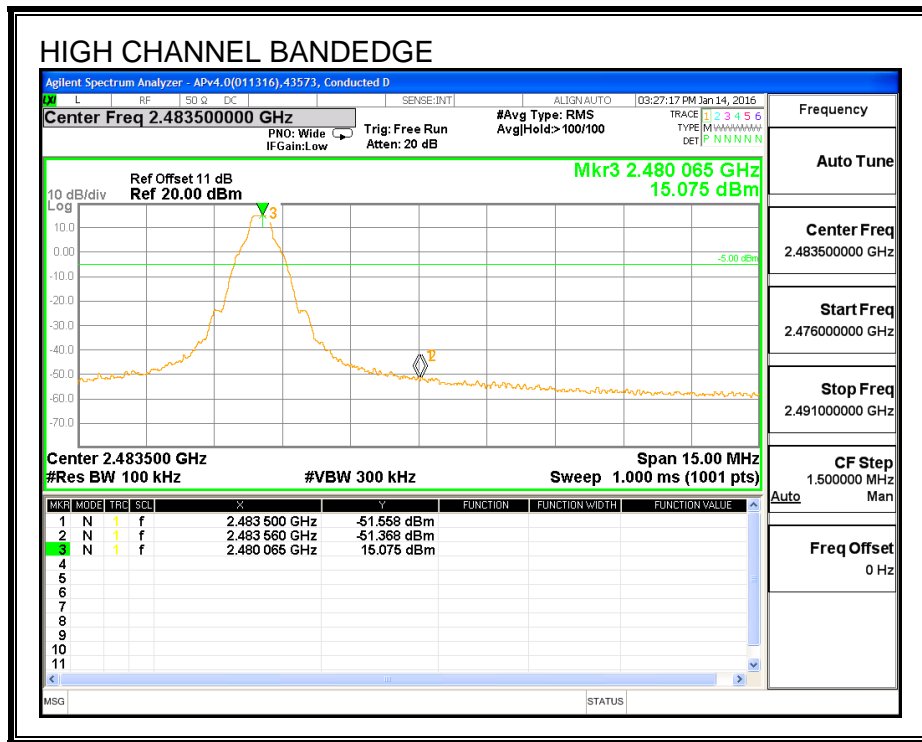

SPURIOUS BANDEDGE EMISSIONS WITH HOPPING ON

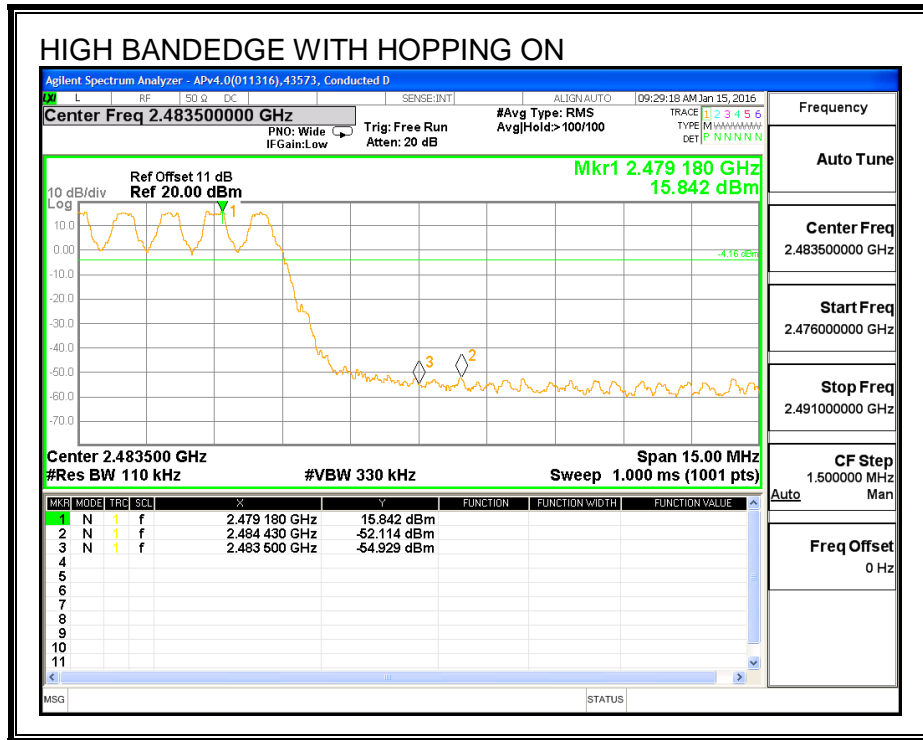
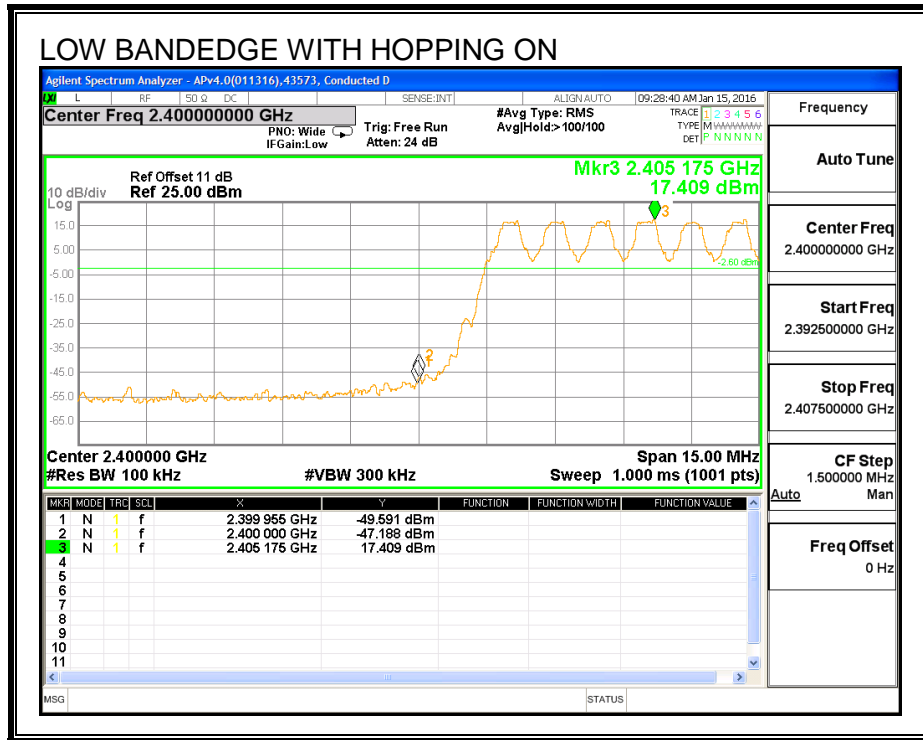

7.3. ANTENNA B HIGH POWER ENHANCED DATA RATE QPSK MODULATION

7.3.1. OUTPUT POWER

LIMIT

§15.247 (b) (1)

RSS-247 (5.4) (2)

The maximum antenna gain is less than 6 dBi, therefore the limit is 30 dBm.

Alternatively, frequency hopping systems operating in the 2400-2483.5 MHz band may have hopping channel carrier frequencies that are separated by 25 kHz or two-thirds of the 20 dB bandwidth of the hopping channel, whichever is greater, provided the systems operate with an output power no greater than 125 mW.

TEST PROCEDURE

The transmitter output is connected to a wideband peak and average power meter.

RESULTS

Channel	Frequency (MHz)	Output Power (dBm)	Limit (dBm)	Margin (dB)
Low	2402	16.73	21	-4.24
Middle	2441	16.46	21	-4.51
High	2480	16.18	21	-4.79

7.3.2. AVERAGE POWER

LIMIT

None; for reporting purposes only.

TEST PROCEDURE

The transmitter output is connected to a power meter.

RESULTS

The cable assembly insertion loss of 11 dB (including 10 dB pad and 1 dB cable) was entered as an offset in the power meter to allow for direct reading of power.

Channel	Frequency (MHz)	Average Power (dBm)
Low	2402	13.99
Middle	2441	13.65
High	2480	13.45

7.4. ANTENNA B HIGH POWER ENHANCED DATA RATE 8PSK MODULATION

7.4.1. 20 dB AND 99% BANDWIDTH

LIMIT

None; for reporting purposes only.

TEST PROCEDURE

The transmitter output is connected to a spectrum analyzer. The RBW is set to $\geq 1\%$ of the 20 dB bandwidth. The VBW is set to \geq RBW. The sweep time is coupled.

RESULTS

Channel	Frequency (MHz)	20 dB Bandwidth (MHz)	99% Bandwidth (MHz)
Low	2402	1.3230	1.2085
Middle	2441	1.3230	1.2072
High	2480	1.3140	1.2052

20 dB AND 99% BANDWIDTH

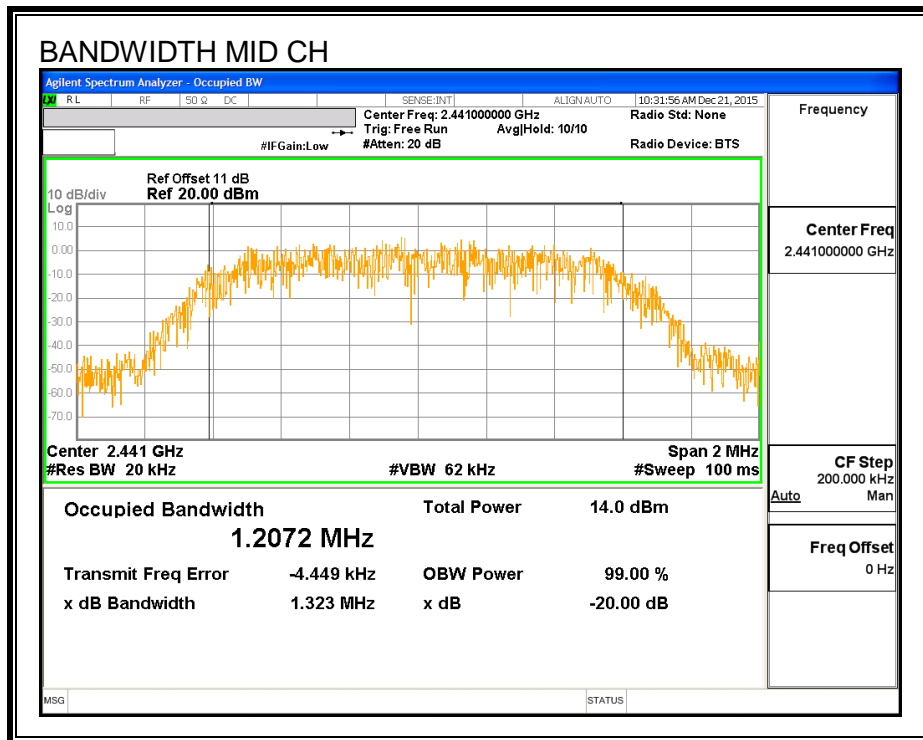
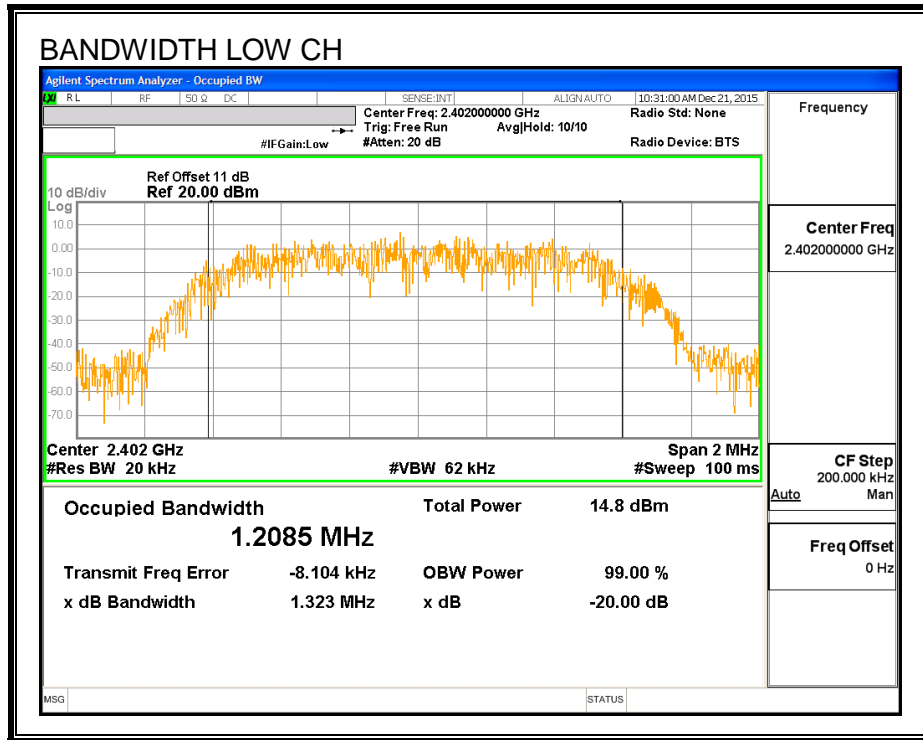

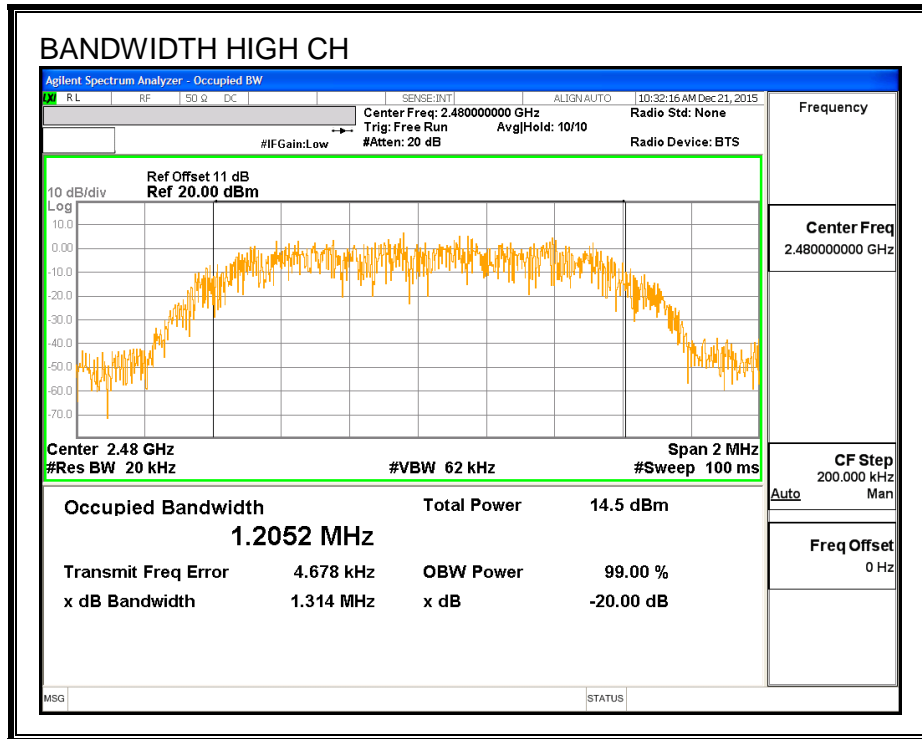

7.4.2. HOPPING FREQUENCY SEPARATION

LIMIT

FCC §15.247 (a) (1)

IC RSS-247 (5.1) (2)

Frequency hopping systems shall have hopping channel carrier frequencies separated by a minimum of 25 kHz or the 20 dB bandwidth of the hopping channel, whichever is greater.

Alternatively, frequency hopping systems operating in the 2400-2483.5 MHz band may have hopping channel carrier frequencies that are separated by 25 kHz or two-thirds of the 20 dB bandwidth of the hopping channel, whichever is greater, provided the systems operate with an output power no greater than 125 mW.

TEST PROCEDURE

The transmitter output is connected to a spectrum analyzer. The RBW is set to 300 kHz and the VBW is set to 910 kHz. The sweep time is coupled.

RESULTS

HOPPING FREQUENCY SEPARATION

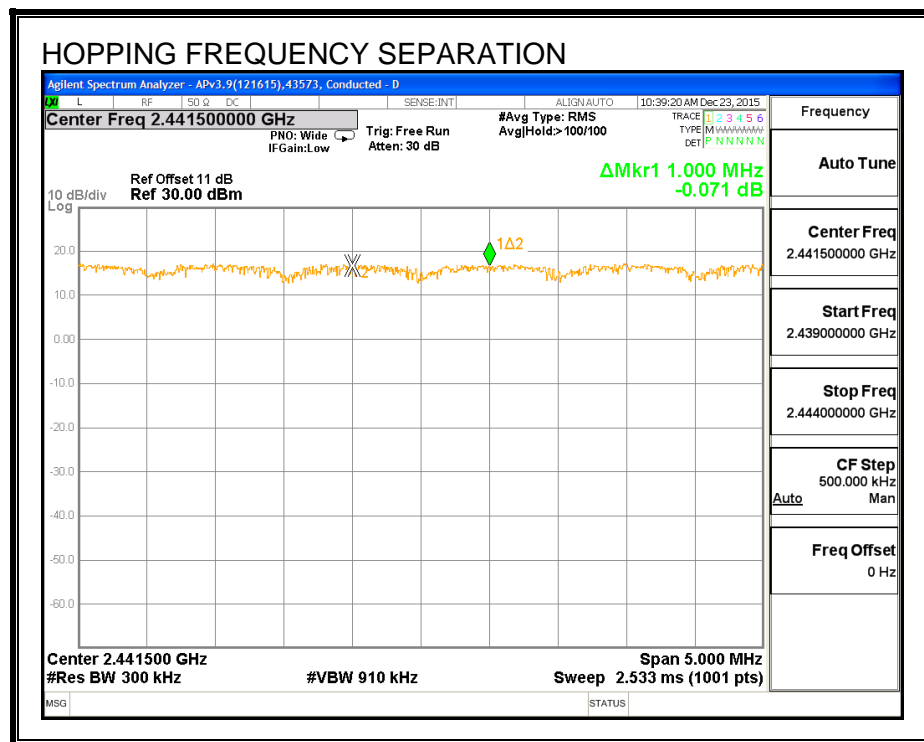

7.4.3. NUMBER OF HOPPING CHANNELS

LIMIT

FCC §15.247 (a) (1) (iii)

IC RSS-247 (5.1) (4)

Frequency hopping systems in the 2400 – 2483.5 MHz band shall use at least 15 non-overlapping channels.

TEST PROCEDURE

The transmitter output is connected to a spectrum analyzer. The span is set to cover the entire authorized band, in either a single sweep or in multiple contiguous sweeps. The RBW is set to a maximum of 1 % of the span. The analyzer is set to Max Hold.

RESULTS

Normal Mode: 79 Channels observed.

NUMBER OF HOPPING CHANNELS

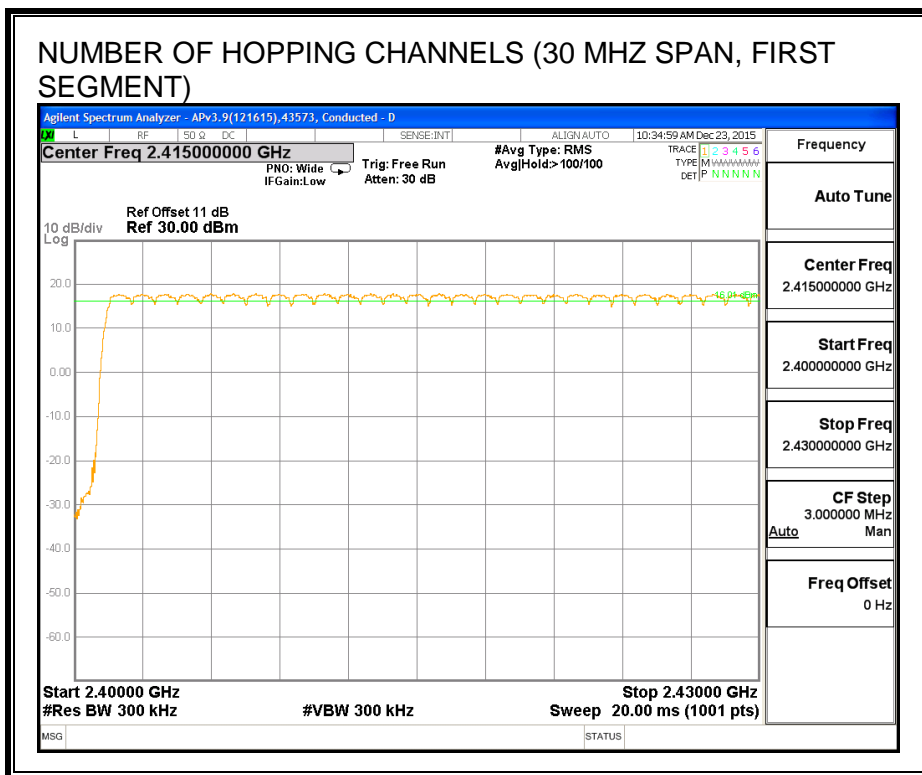
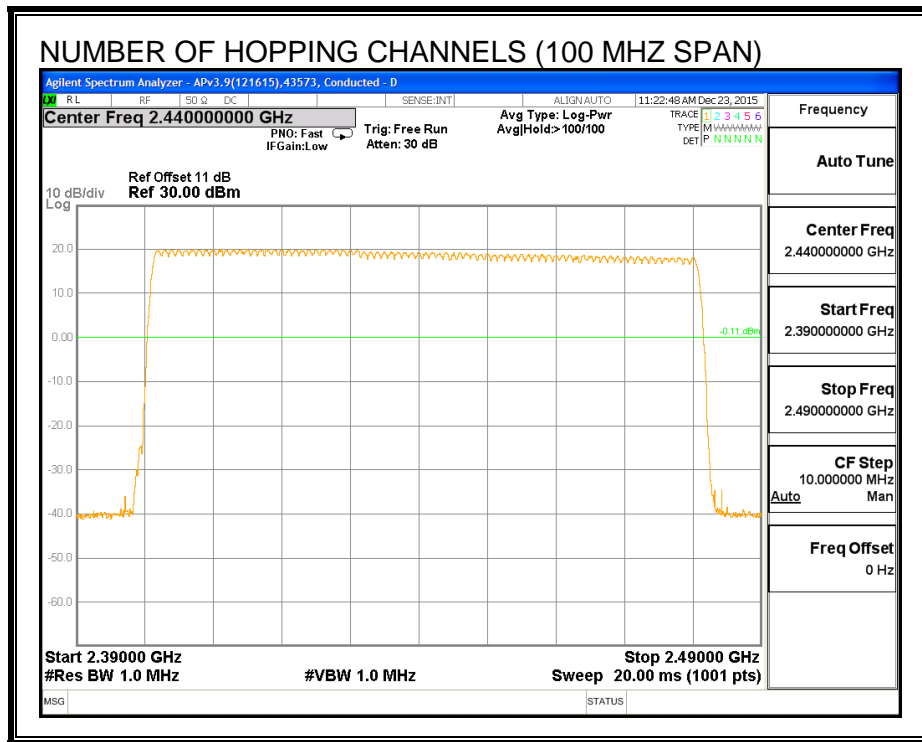

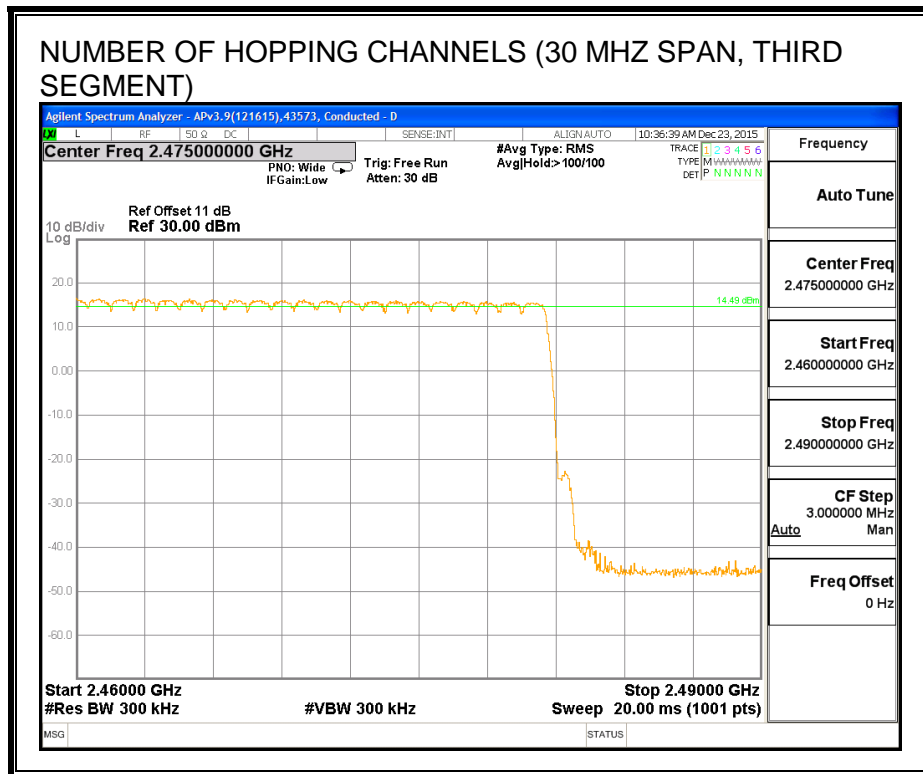
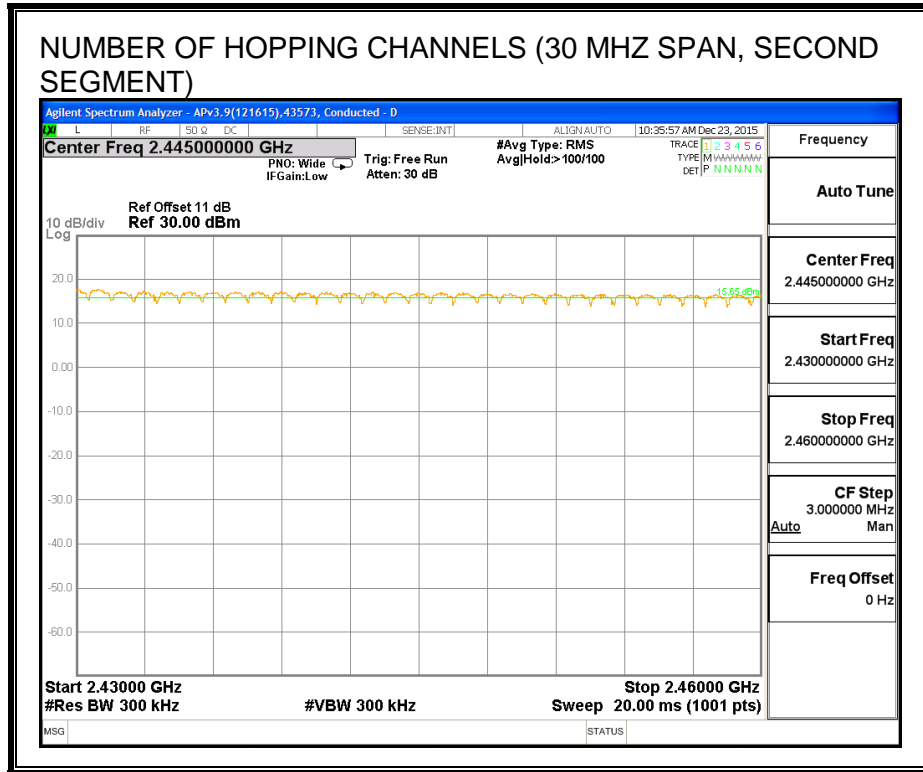

7.4.4. AVERAGE TIME OF OCCUPANCY

LIMIT

FCC §15.247 (a) (1) (iii)

IC RSS-247 (5.1) (4)

The average time of occupancy on any channel shall not be greater than 0.4 seconds within a period of 0.4 seconds multiplied by the number of hopping channels employed.

TEST PROCEDURE

The transmitter output is connected to a spectrum analyzer. The span is set to 0 Hz, centered on a single, selected hopping channel. The width of a single pulse is measured in a fast scan. The number of pulses is measured in a 3.16 second scan, to enable resolution of each occurrence.

The average time of occupancy in the specified 31.6 second period (79 channels * 0.4 s) is equal to $10 * (\# \text{ of pulses in } 3.16 \text{ s}) * \text{ pulse width}$.

RESULTS

8PSK (EDR) Mode

DH Packet	Pulse Width (msec)	Number of Pulses in 3.16 seconds	Average Time of (sec)	Limit (sec)	Margin (sec)
3DH1	0.402	32	0.129	0.4	-0.271
3DH3	1.644	18	0.296	0.4	-0.104
3DH5	2.900	13	0.377	0.4	-0.023

PULSE WIDTH - 3DH1

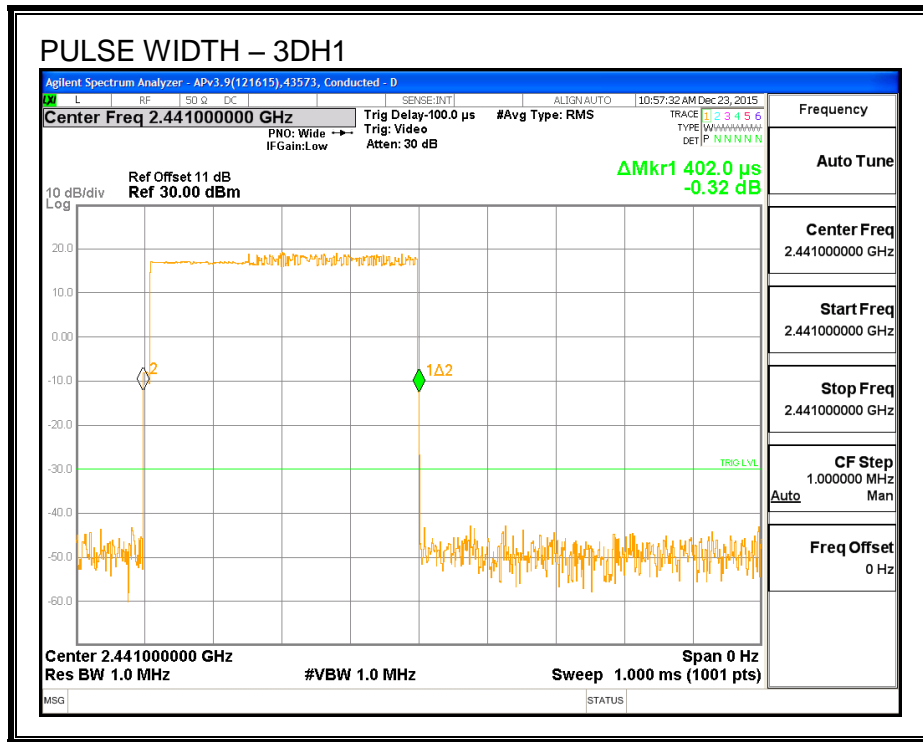

NUMBER OF PULSES IN 3.16 SECOND OBSERVATION PERIOD – 3DH1

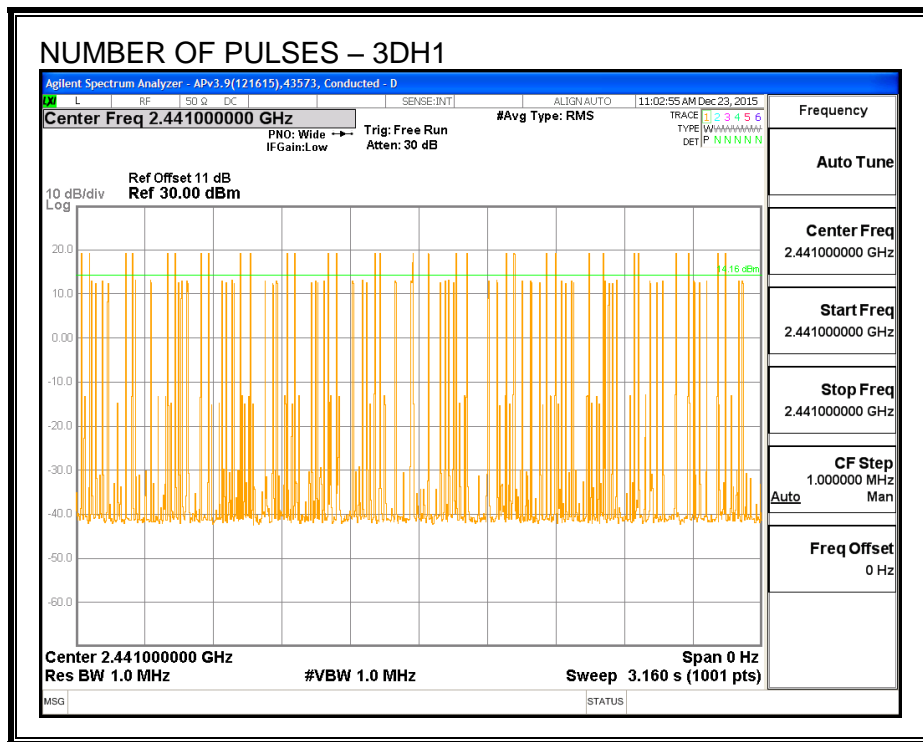

PULSE WIDTH – 3DH3

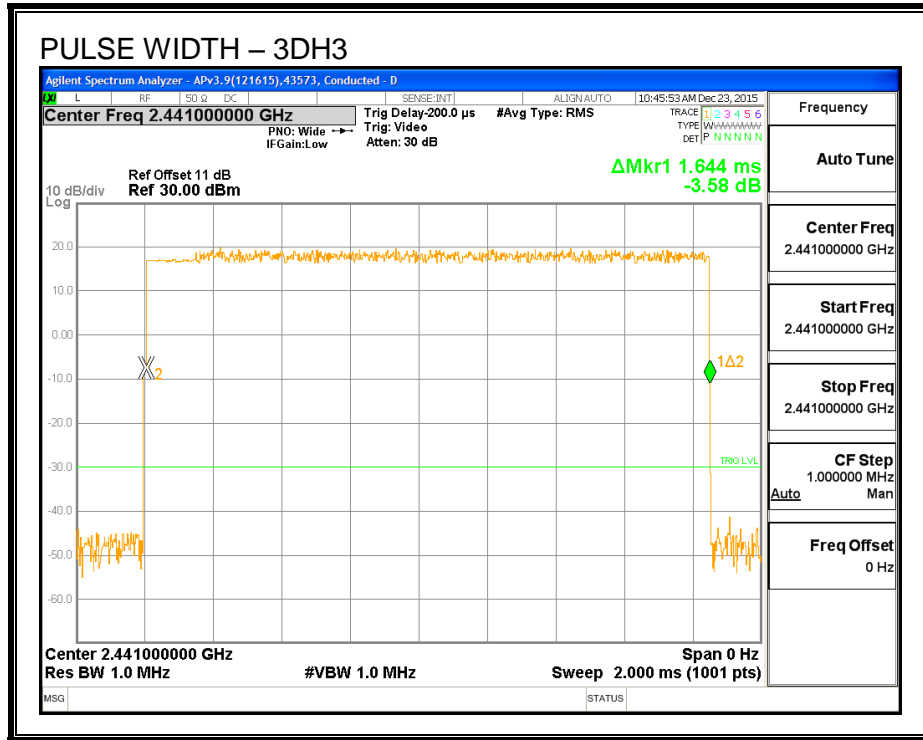

NUMBER OF PULSES IN 3.16 SECOND OBSERVATION PERIOD – 3DH3

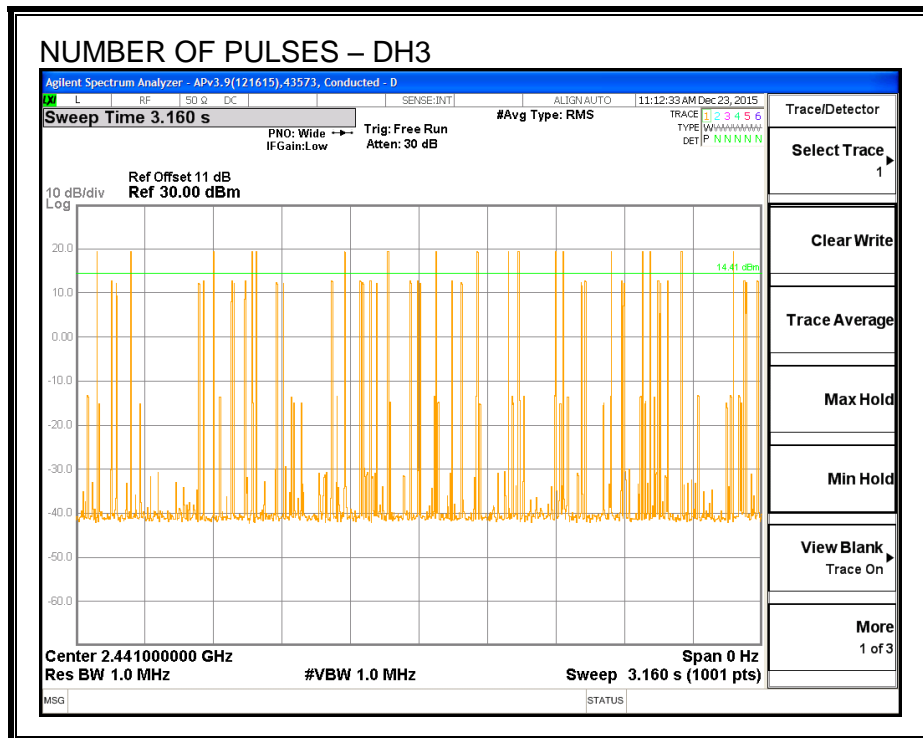

PULSE WIDTH – 3DH5

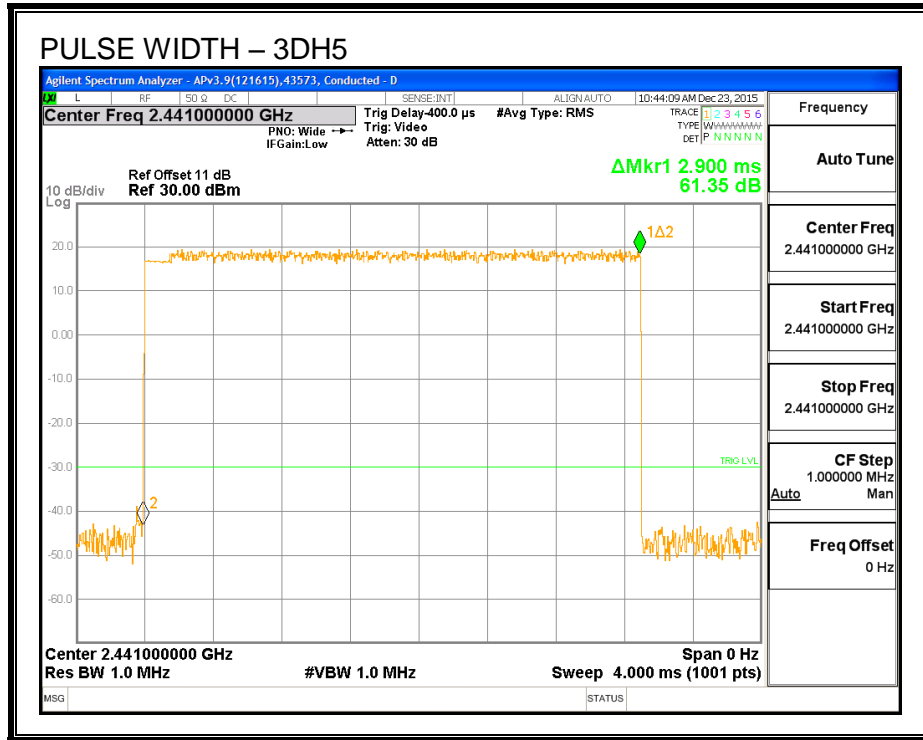

NUMBER OF PULSES IN 3.16 SECOND OBSERVATION PERIOD – 3DH5

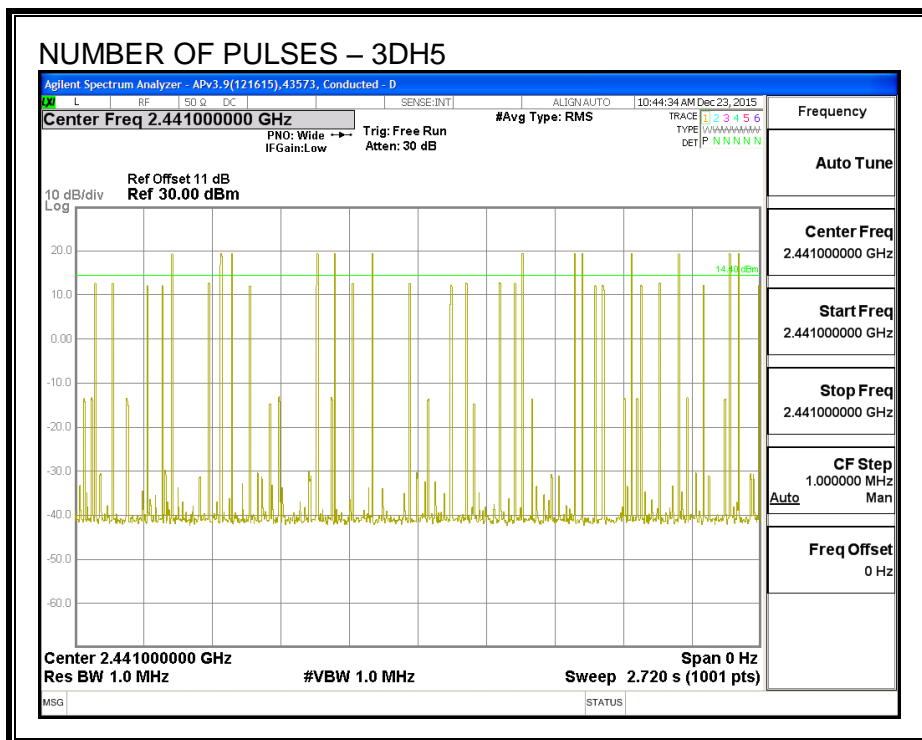

7.4.5. OUTPUT POWER

LIMIT

§15.247 (b) (1)

RSS-247 (5.4) (2)

The maximum antenna gain is less than 6 dBi, therefore the limit is 30 dBm.

Alternatively, frequency hopping systems operating in the 2400-2483.5 MHz band may have hopping channel carrier frequencies that are separated by 25 kHz or two-thirds of the 20 dB bandwidth of the hopping channel, whichever is greater, provided the systems operate with an output power no greater than 125 mW.

TEST PROCEDURE

The transmitter output is connected to a wideband peak and average power meter.

RESULTS

Channel	Frequency (MHz)	Output Power (dBm)	Limit (dBm)	Margin (dB)
Low	2402	17.03	21	-3.94
Middle	2441	16.57	21	-4.40
High	2480	16.41	21	-4.56

7.4.6. AVERAGE POWER

LIMIT

None; for reporting purposes only.

TEST PROCEDURE

The transmitter output is connected to a power meter.

RESULTS

The cable assembly insertion loss of 11 dB (including 10 dB pad and 1 dB cable) was entered as an offset in the power meter to allow for direct reading of power.

Channel	Frequency (MHz)	Average Power (dBm)
Low	2402	14.00
Middle	2441	13.67
High	2480	13.47

7.4.7. CONDUCTED SPURIOUS EMISSIONS

LIMITS

FCC §15.247 (d)

IC RSS-247 (5.5)

Limit = -20 dBc

TEST PROCEDURE

The transmitter output is connected to a spectrum analyzer. The resolution bandwidth is set to 100 kHz. The video bandwidth is set to 300 kHz.

The spectrum from 30 MHz to 26 GHz is investigated with the transmitter set to the lowest, middle, and highest channels.

The bandedges at 2.4 and 2.4835 GHz are investigated with the transmitter set to the normal hopping mode.

RESULTS

SPURIOUS EMISSIONS, LOW CHANNEL

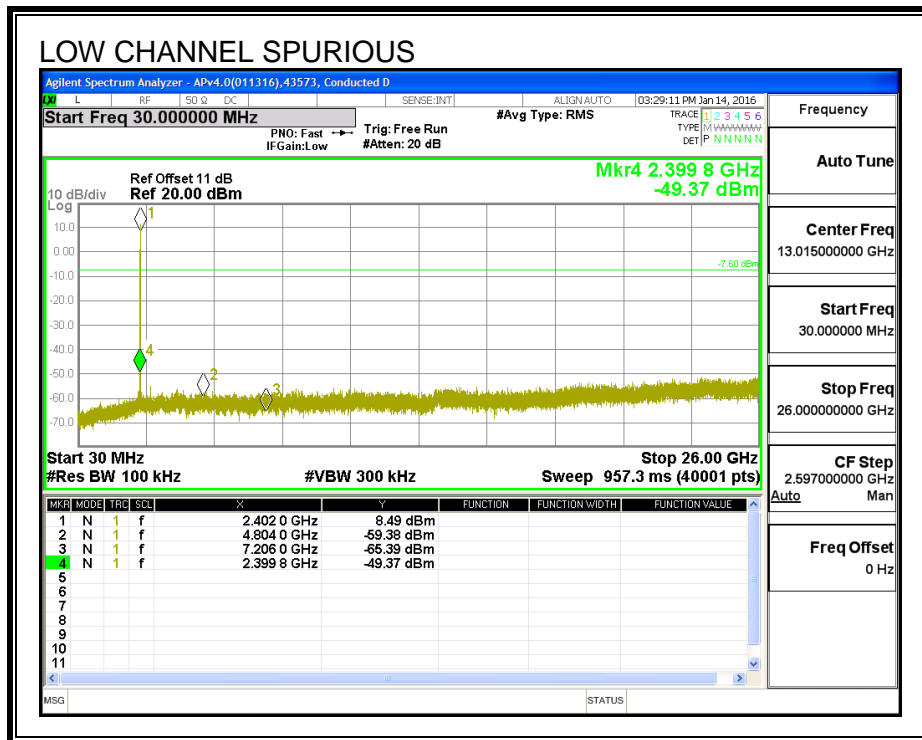
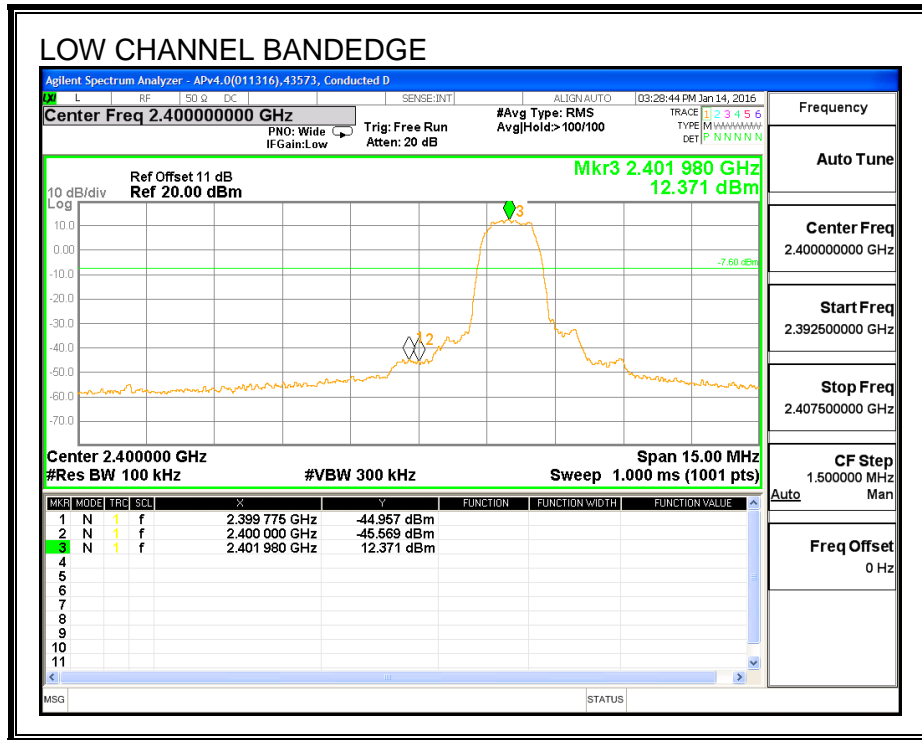

SPURIOUS EMISSIONS, MID CHANNEL

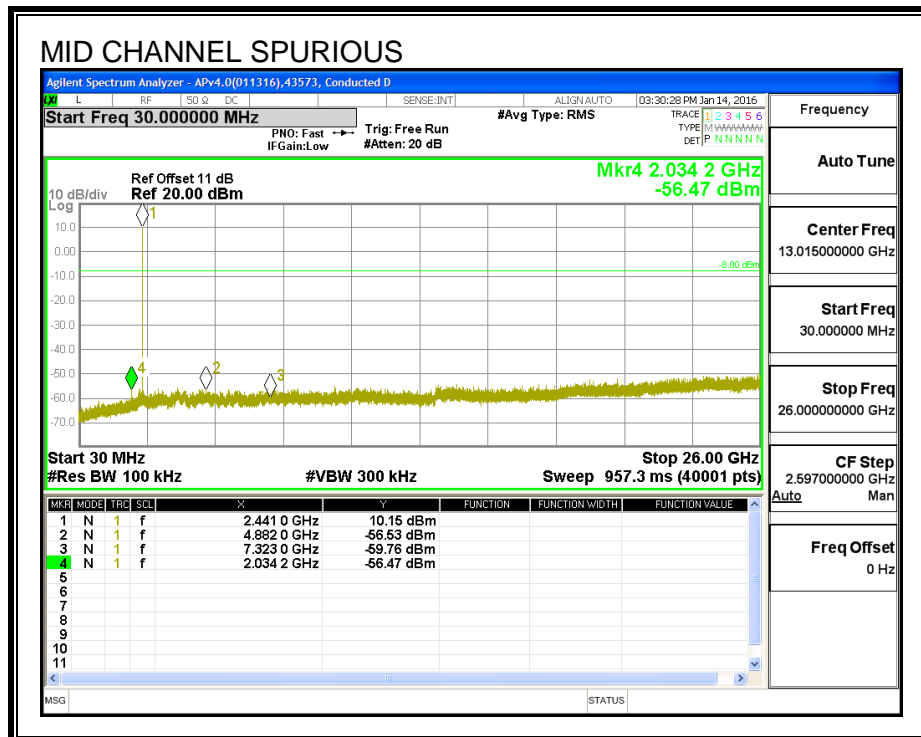
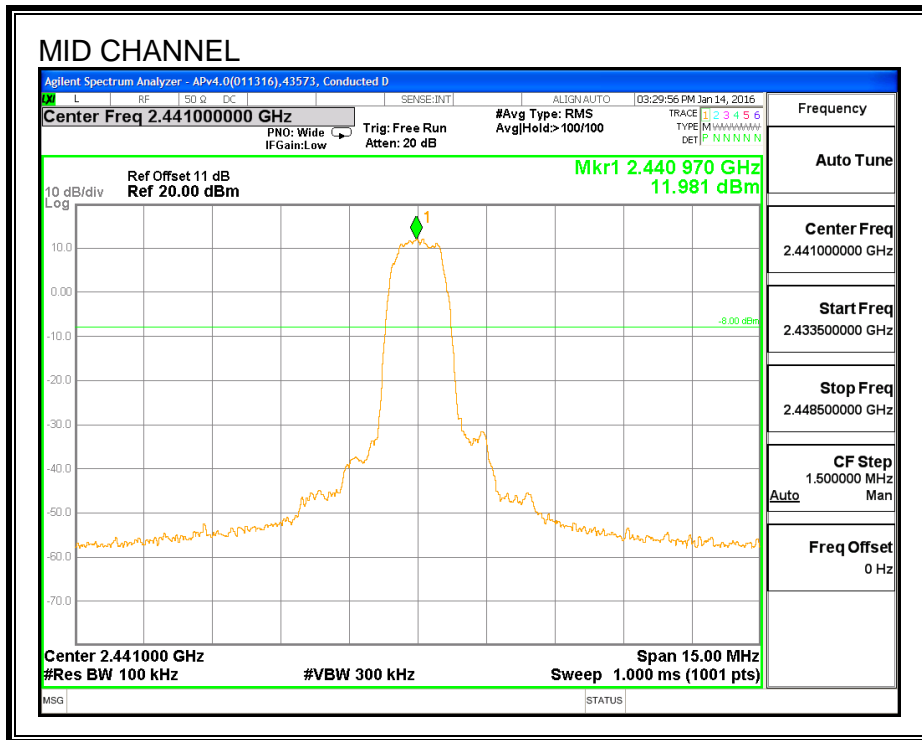

SPURIOUS EMISSIONS, HIGH CHANNEL

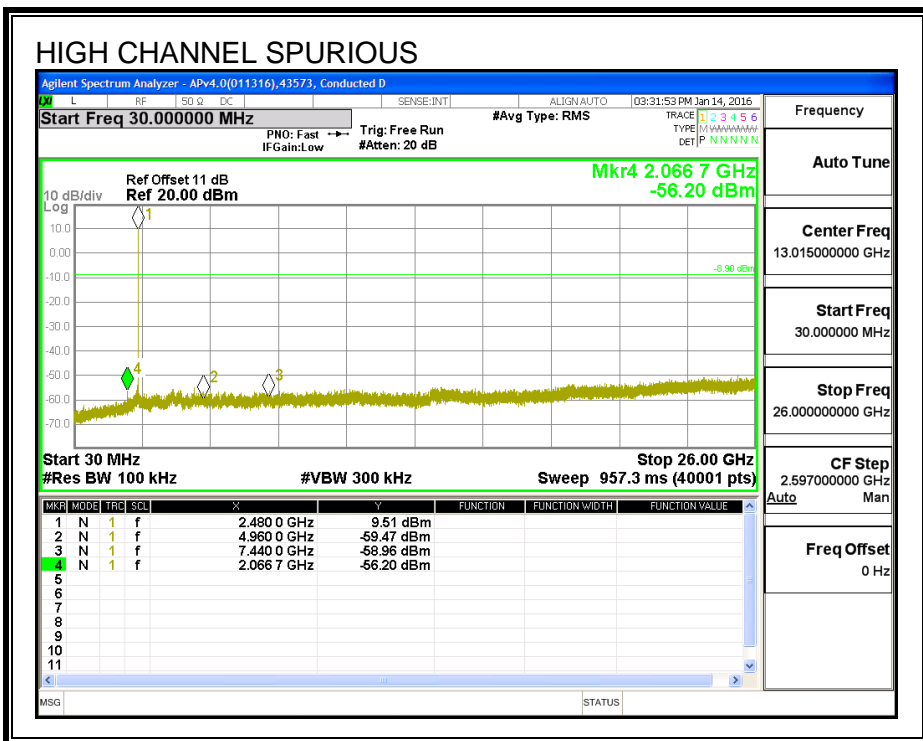
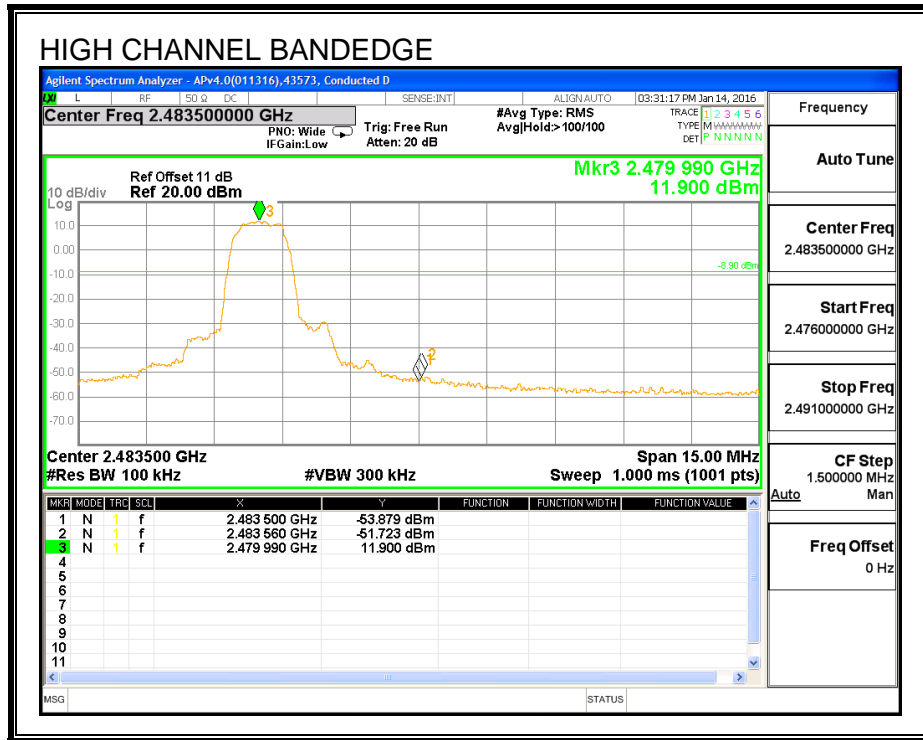

SPURIOUS BANDEGE EMISSIONS WITH HOPPING ON

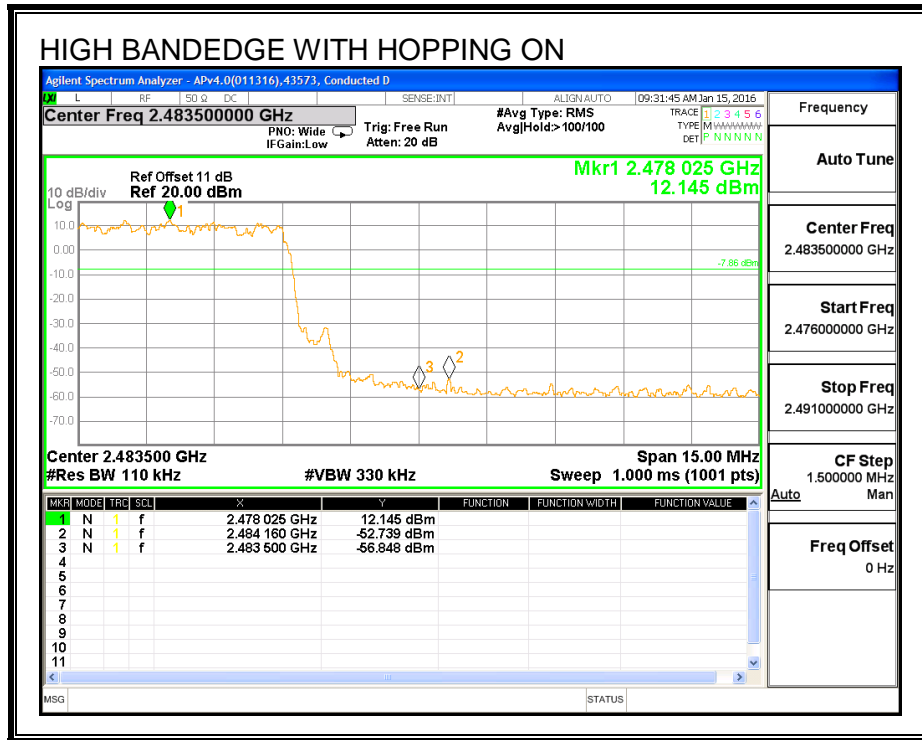
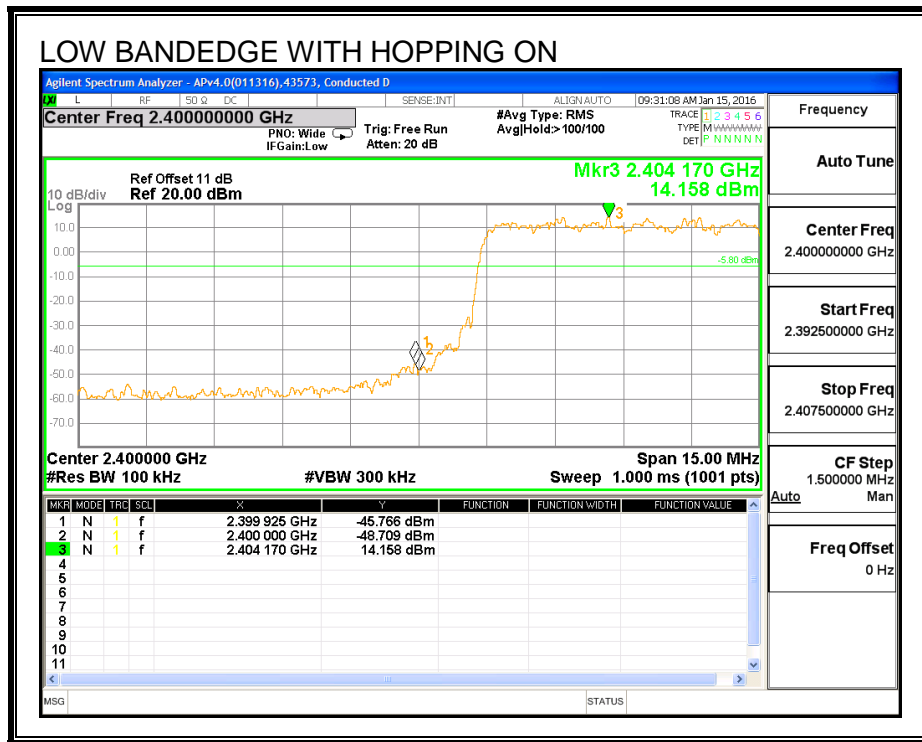

7.5. ANTENNA B LOW POWER BASIC DATA RATE GFSK MODULATION

7.5.1. 20 dB AND 99% BANDWIDTH

LIMIT

None; for reporting purposes only.

TEST PROCEDURE

The transmitter output is connected to a spectrum analyzer. The RBW is set to $\geq 1\%$ of the 20 dB bandwidth. The VBW is set to \geq RBW. The sweep time is coupled.

RESULTS

Channel	Frequency (MHz)	20 dB Bandwidth (KHz)	99% Bandwidth (KHz)
Low	2402	874.7	893.61
Middle	2441	916.5	885.51
High	2480	874.4	886.87

20 dB AND 99% BANDWIDTH

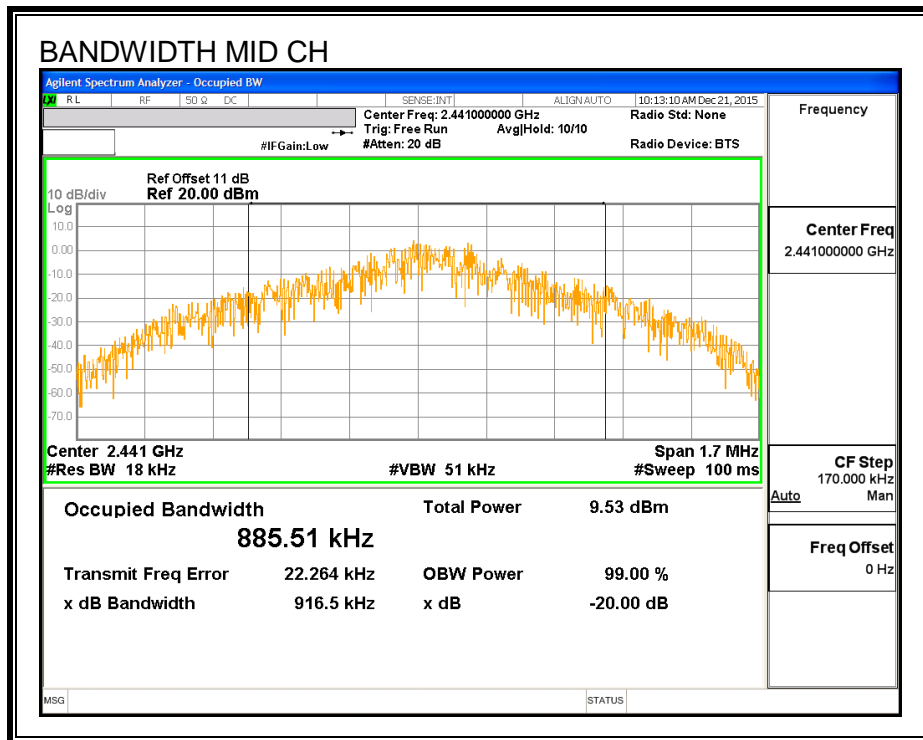
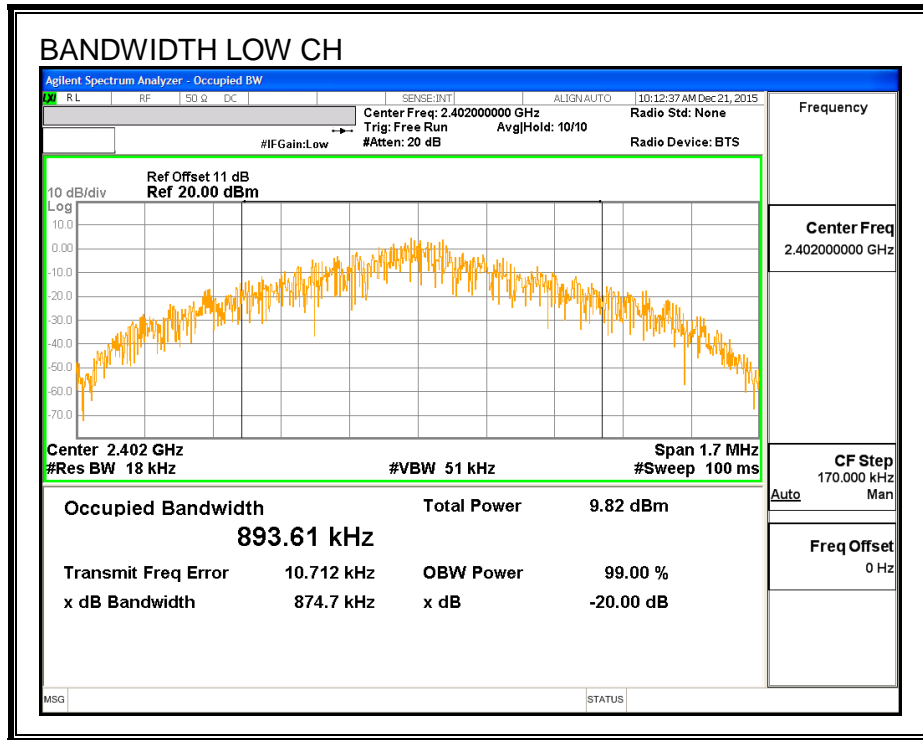

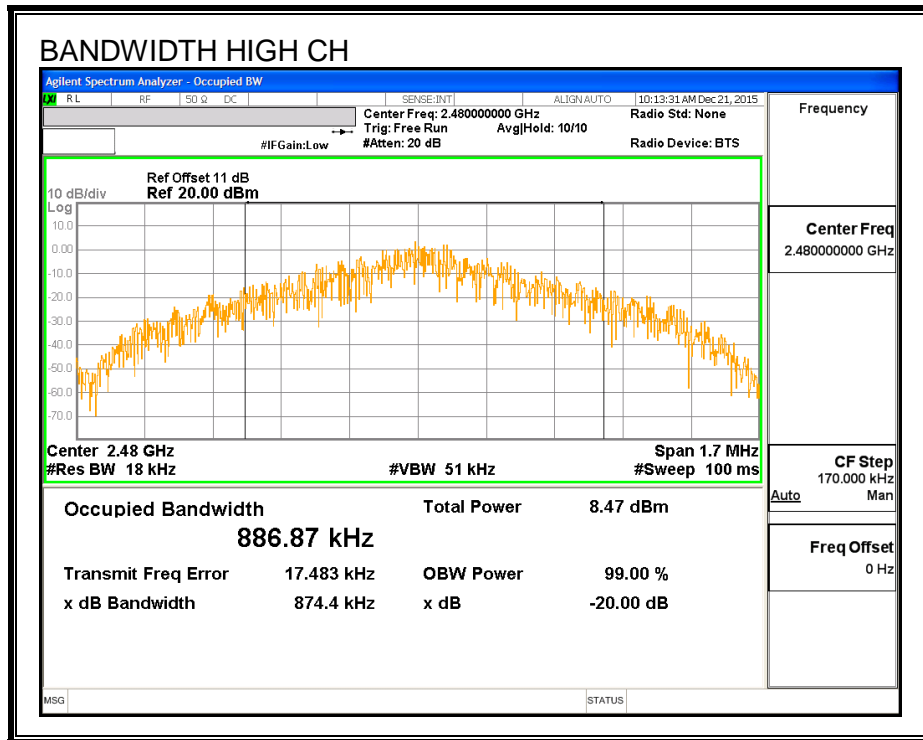

7.5.2. HOPPING FREQUENCY SEPARATION

LIMIT

FCC §15.247 (a) (1)

IC RSS-247 (5.1) (2)

Frequency hopping systems shall have hopping channel carrier frequencies separated by a minimum of 25 kHz or the 20 dB bandwidth of the hopping channel, whichever is greater.

Alternatively, frequency hopping systems operating in the 2400-2483.5 MHz band may have hopping channel carrier frequencies that are separated by 25 kHz or two-thirds of the 20 dB bandwidth of the hopping channel, whichever is greater, provided the systems operate with an output power no greater than 125 mW.

TEST PROCEDURE

The transmitter output is connected to a spectrum analyzer. The RBW is set to 300 kHz and the VBW is set to 910 kHz. The sweep time is coupled.

RESULTS

HOPPING FREQUENCY SEPARATION

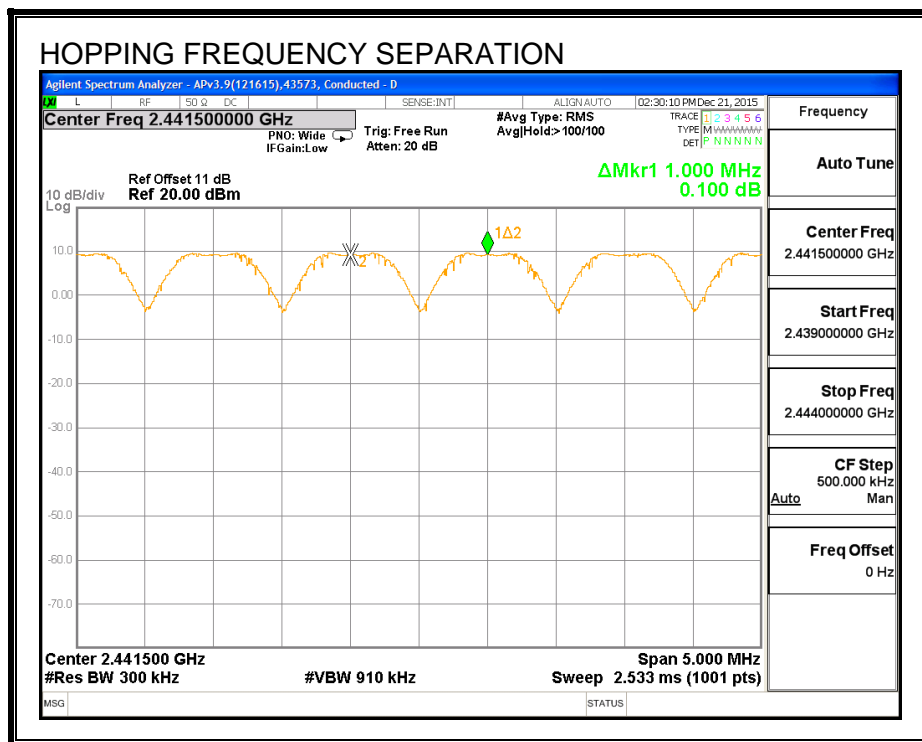

7.5.3. NUMBER OF HOPPING CHANNELS

LIMIT

FCC §15.247 (a) (1) (iii)

IC RSS-247 (5.1) (4)

Frequency hopping systems in the 2400 – 2483.5 MHz band shall use at least 15 non-overlapping channels.

TEST PROCEDURE

The transmitter output is connected to a spectrum analyzer. The span is set to cover the entire authorized band, in either a single sweep or in multiple contiguous sweeps. The RBW is set to a maximum of 1 % of the span. The analyzer is set to Max Hold.

RESULTS

Normal Mode: 79 Channels observed.

NUMBER OF HOPPING CHANNELS

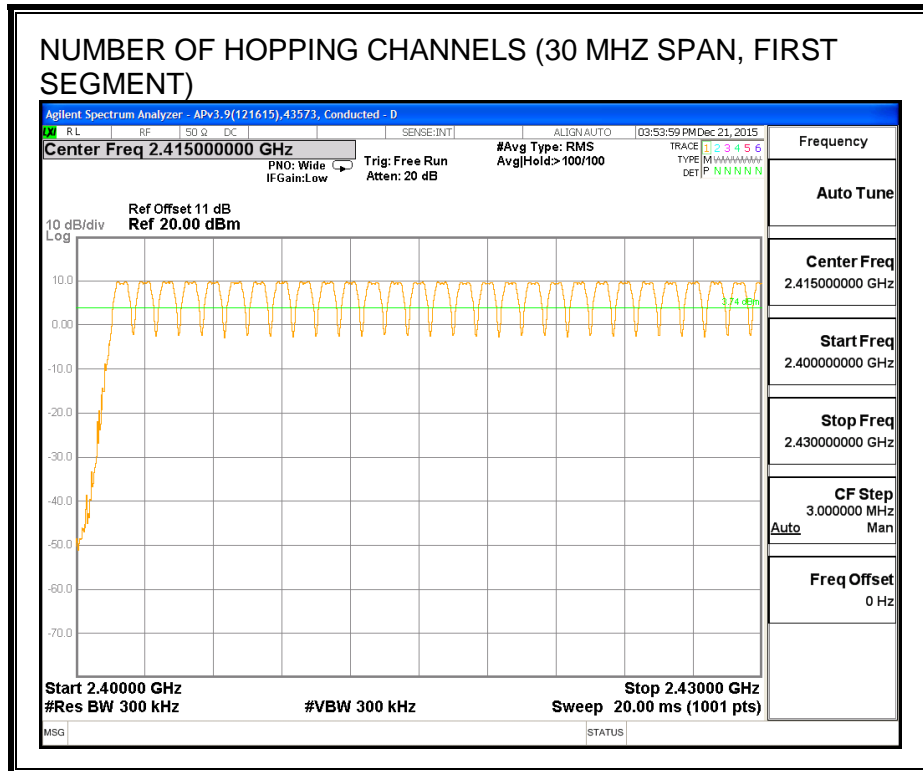
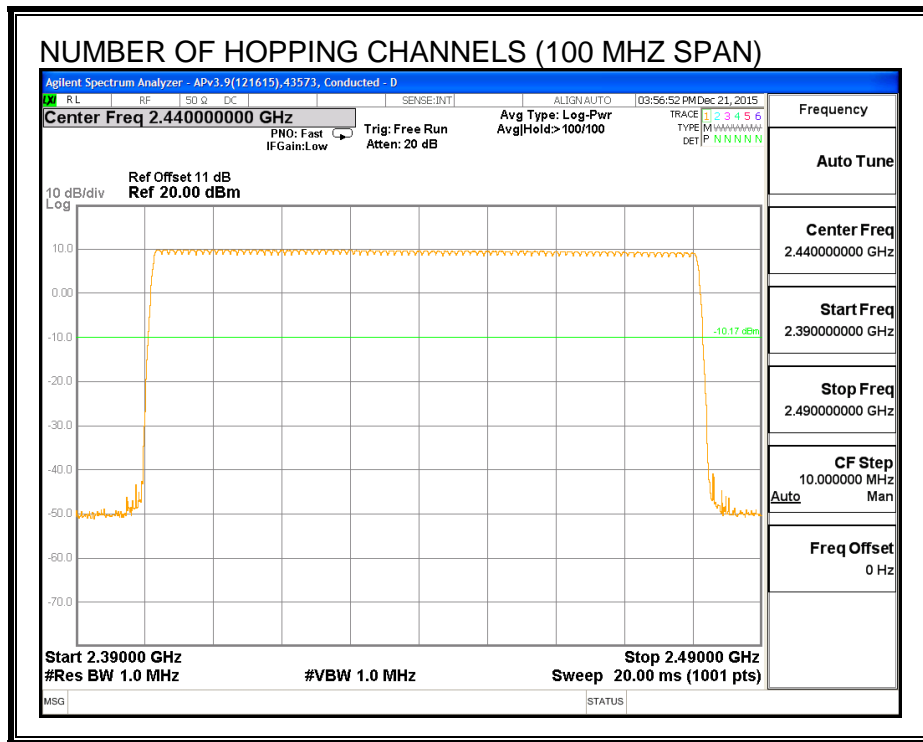

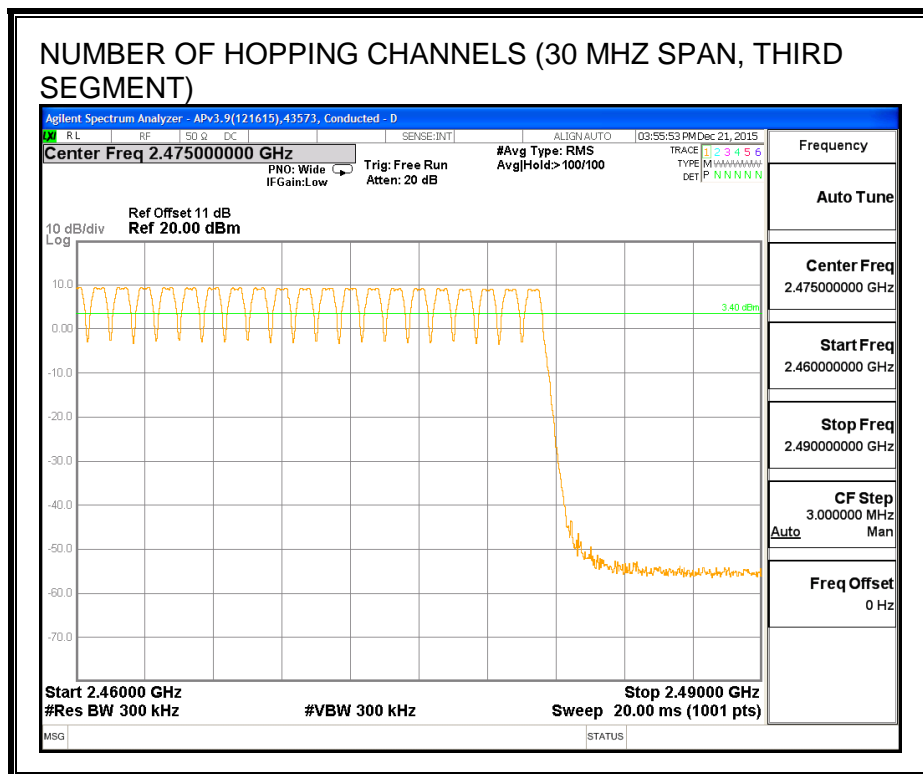
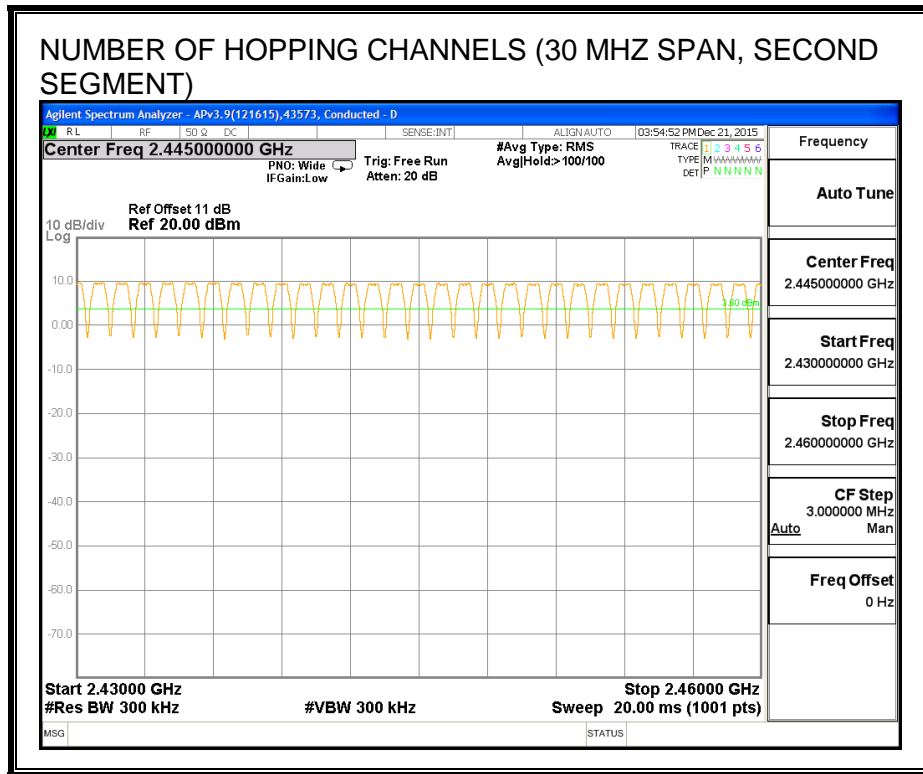

7.5.4. AVERAGE TIME OF OCCUPANCY

LIMIT

FCC §15.247 (a) (1) (iii)

IC RSS-247 (5.1) (4)

The average time of occupancy on any channel shall not be greater than 0.4 seconds within a period of 0.4 seconds multiplied by the number of hopping channels employed.

TEST PROCEDURE

The transmitter output is connected to a spectrum analyzer. The span is set to 0 Hz, centered on a single, selected hopping channel. The width of a single pulse is measured in a fast scan. The number of pulses is measured in a 3.16 second scan, to enable resolution of each occurrence.

The average time of occupancy in the specified 31.6 second period (79 channels * 0.4 s) is equal to $10 * (\# \text{ of pulses in } 3.16 \text{ s}) * \text{ pulse width}$.

For AFH mode, the average time of occupancy in the specified 8 second period (20 channels * 0.4 seconds) is equal to $10 * (\# \text{ of pulses in } 0.8 \text{ s}) * \text{ pulse width}$.

RESULTS

DH Packet	Pulse Width (msec)	Number of Pulses in 3.16 seconds	Average Time of Occupancy (sec)	Limit (sec)	Margin (sec)
GFSK Normal Mode					
DH1	0.396	32	0.127	0.4	-0.273
DH3	1.652	21	0.347	0.4	-0.053
DH5	2.912	13	0.379	0.4	-0.021

PULSE WIDTH - DH1

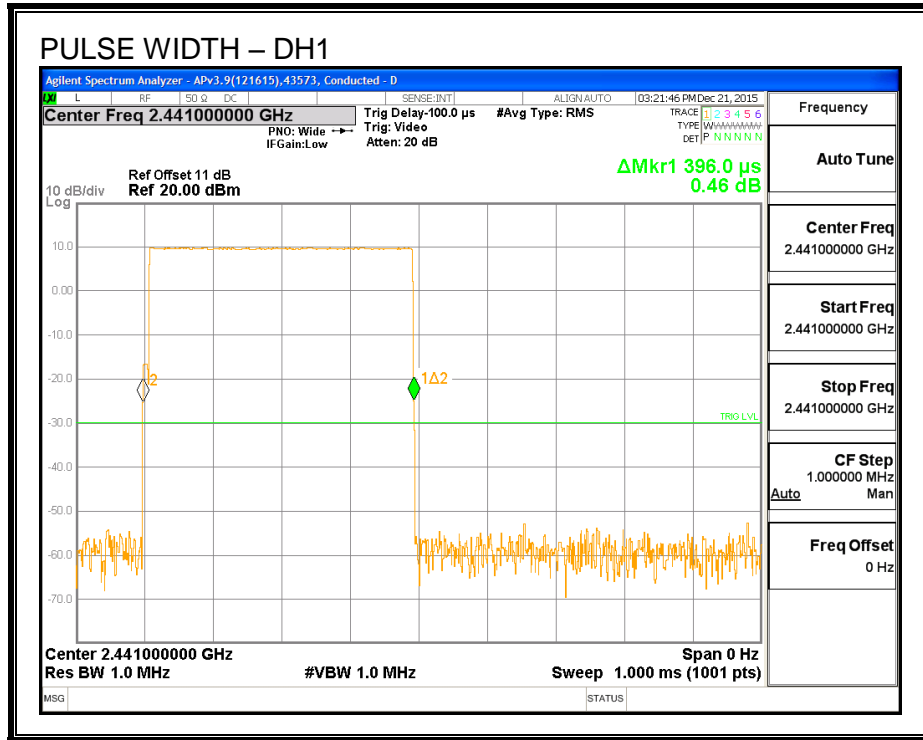

NUMBER OF PULSES IN 3.16 SECOND OBSERVATION PERIOD - DH1

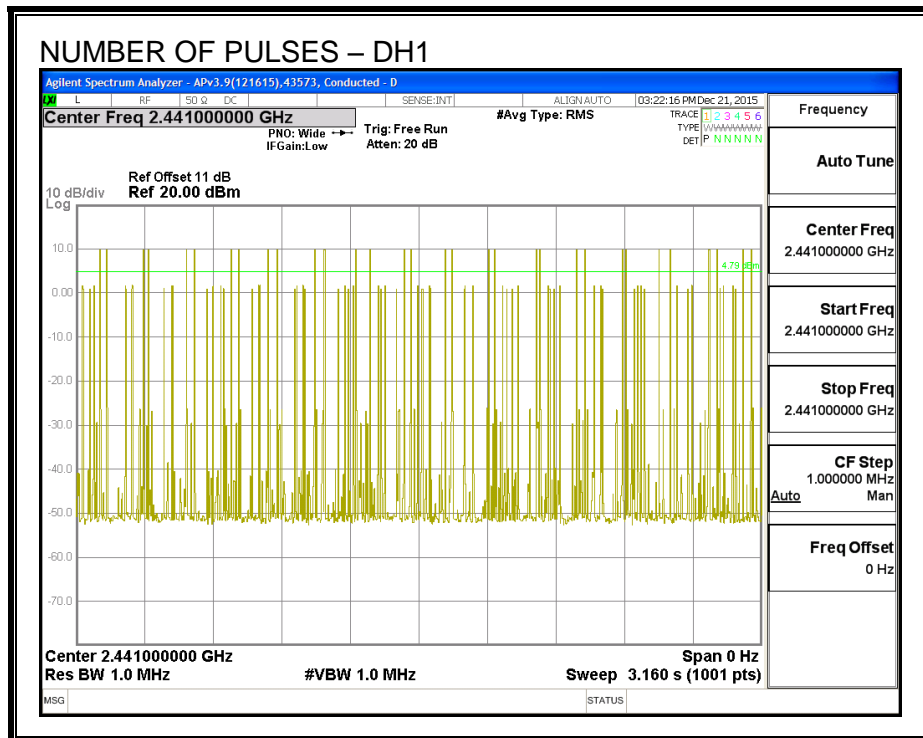

PULSE WIDTH – DH3

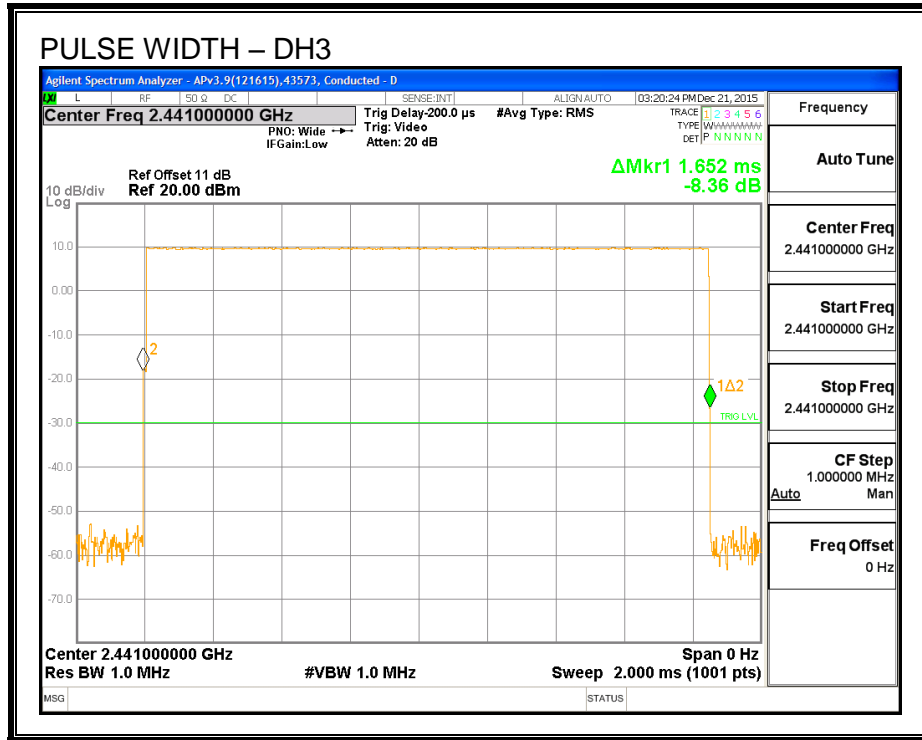

NUMBER OF PULSES IN 3.16 SECOND OBSERVATION PERIOD – DH3

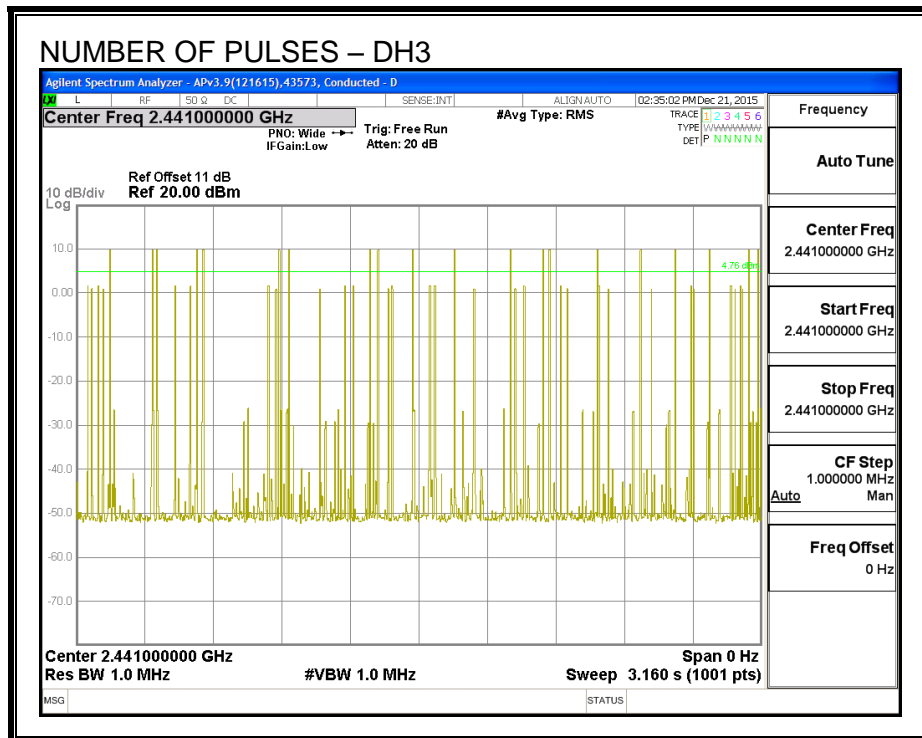

PULSE WIDTH – DH5

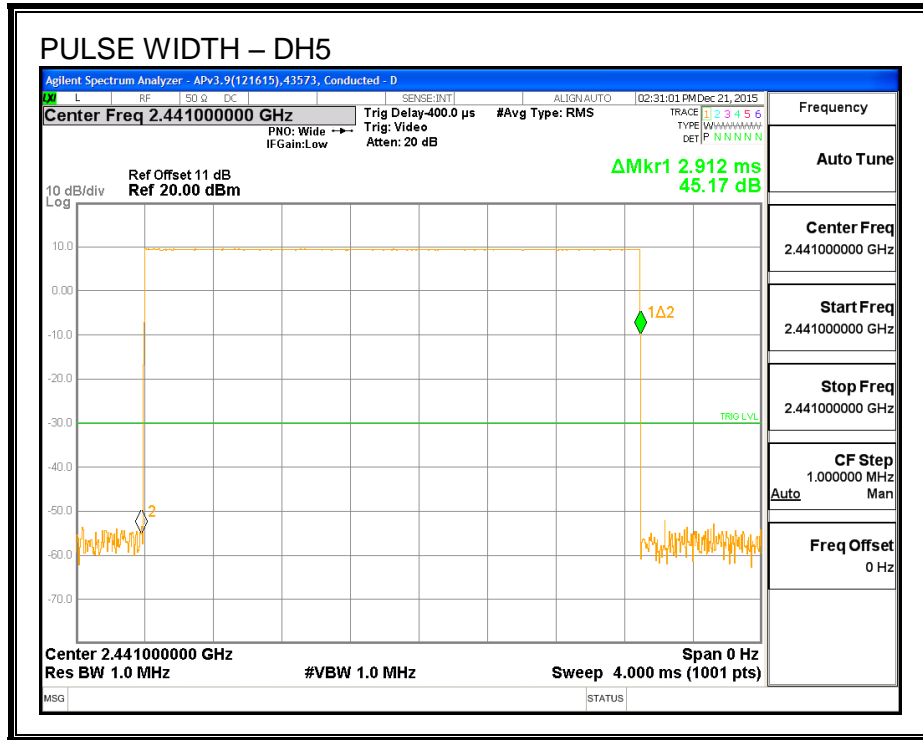

NUMBER OF PULSES IN 3.16 SECOND OBSERVATION PERIOD – DH5

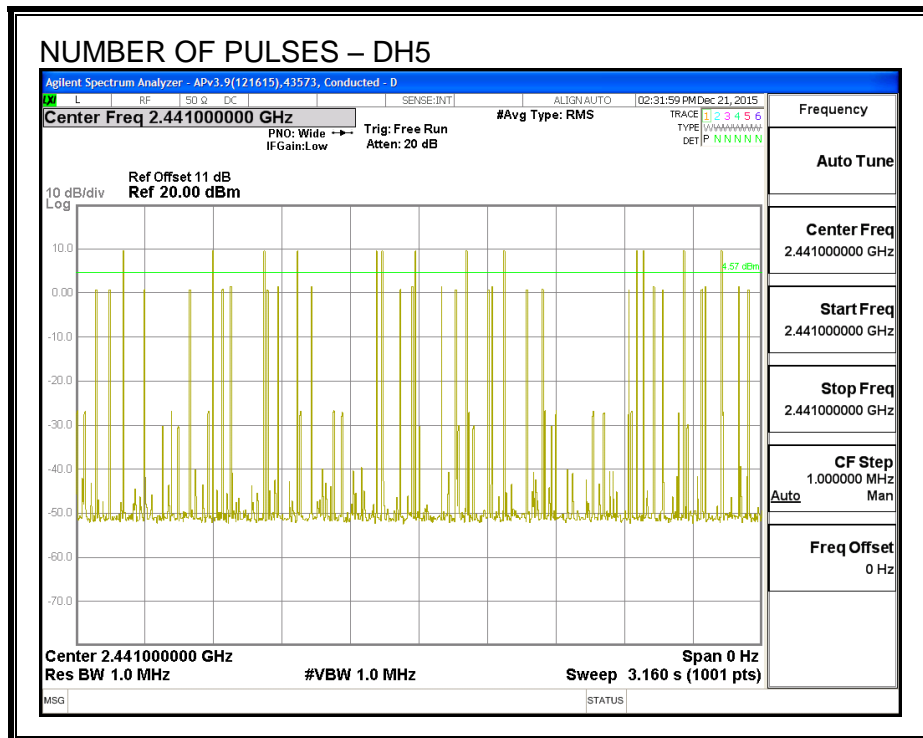

7.5.5. OUTPUT POWER

LIMIT

§15.247 (b) (1)

RSS-247 (5.4) (2)

The maximum antenna gain is less than 6 dBi, therefore the limit is 30 dBm.

TEST PROCEDURE

The transmitter output is connected to a wideband peak and average power meter.

RESULTS

Channel	Frequency (MHz)	Output Power (dBm)	Limit (dBm)	Margin (dB)
Low	2402	10.50	30	-19.50
Middle	2441	10.50	30	-19.50
High	2480	10.14	30	-19.86

7.5.6. AVERAGE POWER

LIMIT

None; for reporting purposes only.

TEST PROCEDURE

The transmitter output is connected to a power meter.

RESULTS

The cable assembly insertion loss of 11 dB (including 10 dB pad and 1 dB cable) was entered as an offset in the power meter to allow for direct reading of power.

Channel	Frequency (MHz)	Average Power (dBm)
Low	2402	10.40
Middle	2441	10.41
High	2480	9.98

7.5.7. CONDUCTED SPURIOUS EMISSIONS

LIMITS

FCC §15.247 (d)

IC RSS-247 (5.5)

Limit = -20 dBc

TEST PROCEDURE

The transmitter output is connected to a spectrum analyzer. The resolution bandwidth is set to 100 kHz. The video bandwidth is set to 300 kHz.

The spectrum from 30 MHz to 26 GHz is investigated with the transmitter set to the lowest, middle, and highest channels.

The bandedges at 2.4 and 2.4835 GHz are investigated with the transmitter set to the normal hopping mode.

RESULTS

SPURIOUS EMISSIONS, LOW CHANNEL

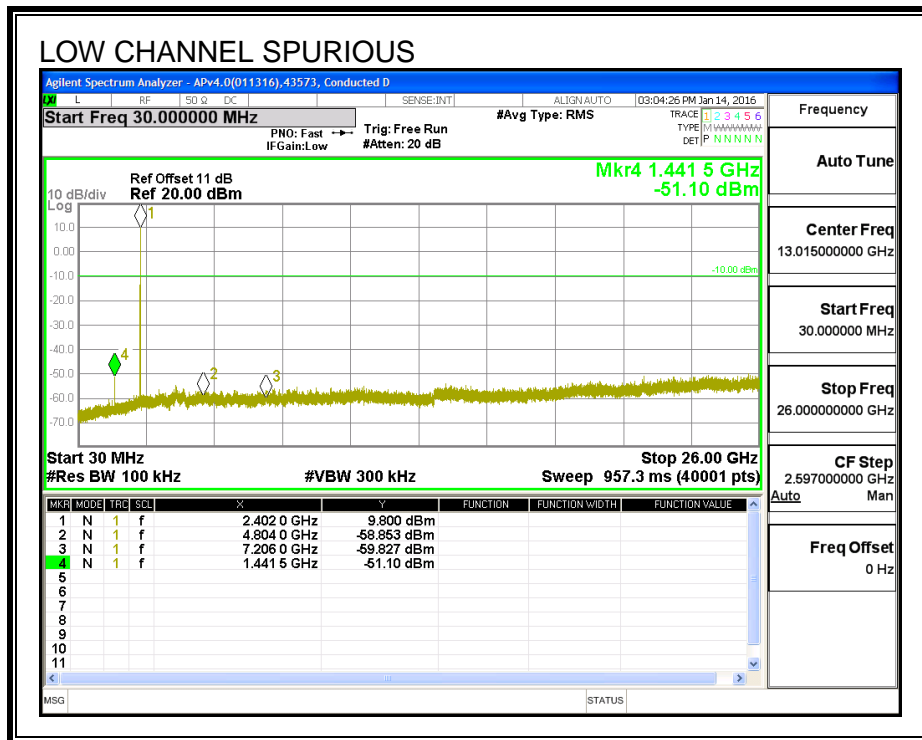
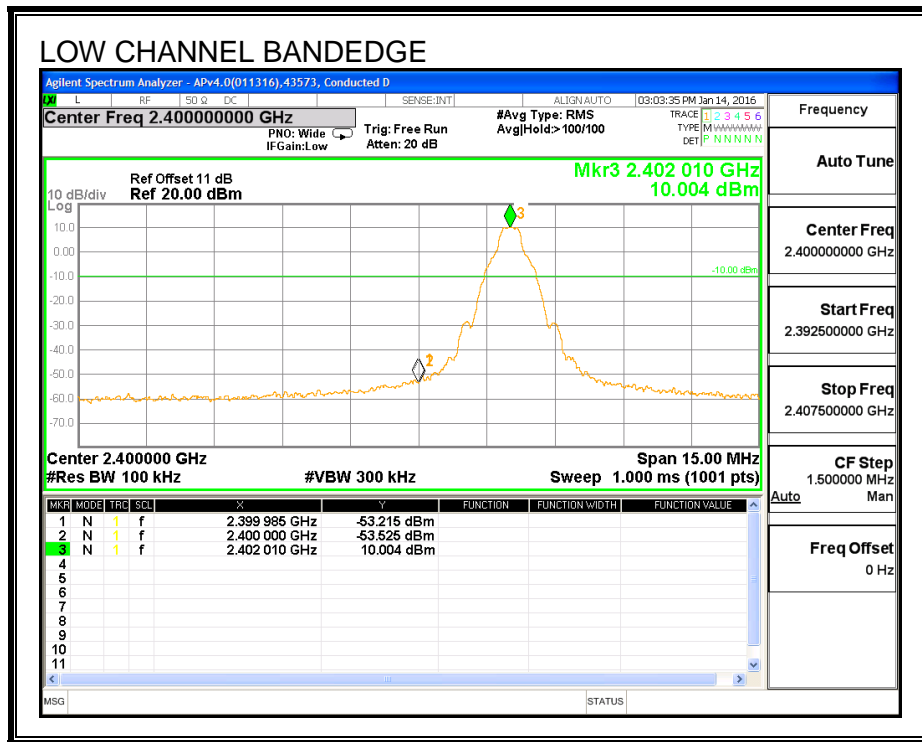

SPURIOUS EMISSIONS, MID CHANNEL

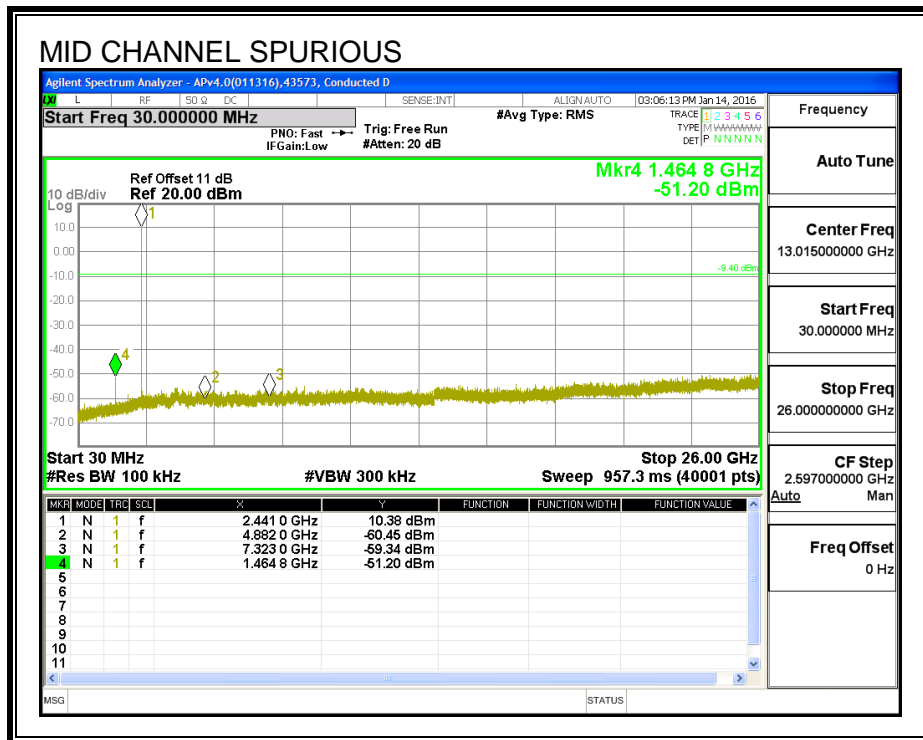
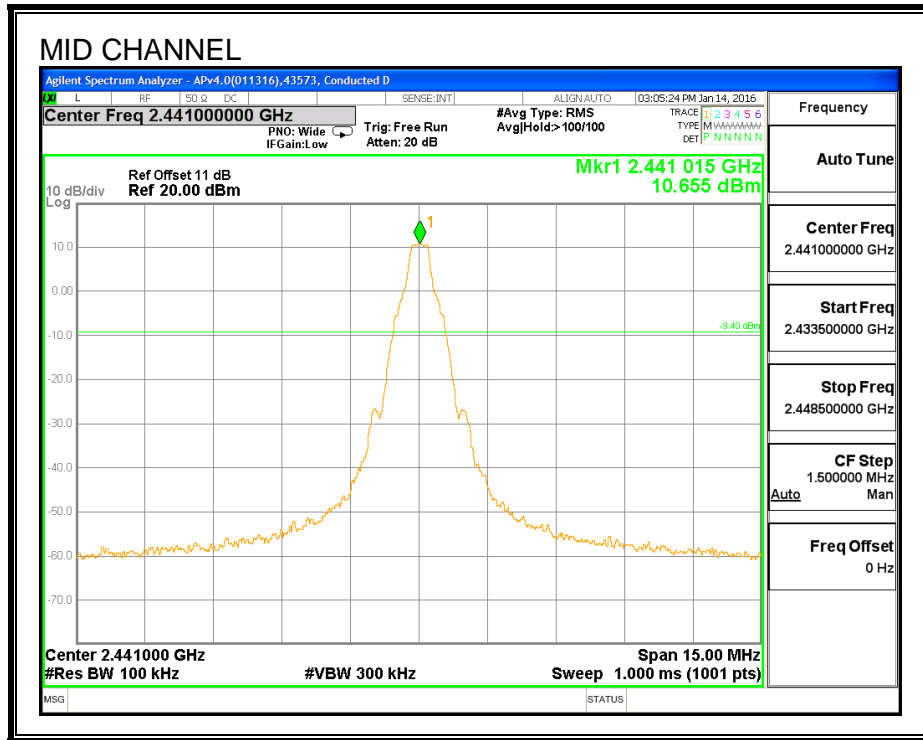

SPURIOUS EMISSIONS, HIGH CHANNEL

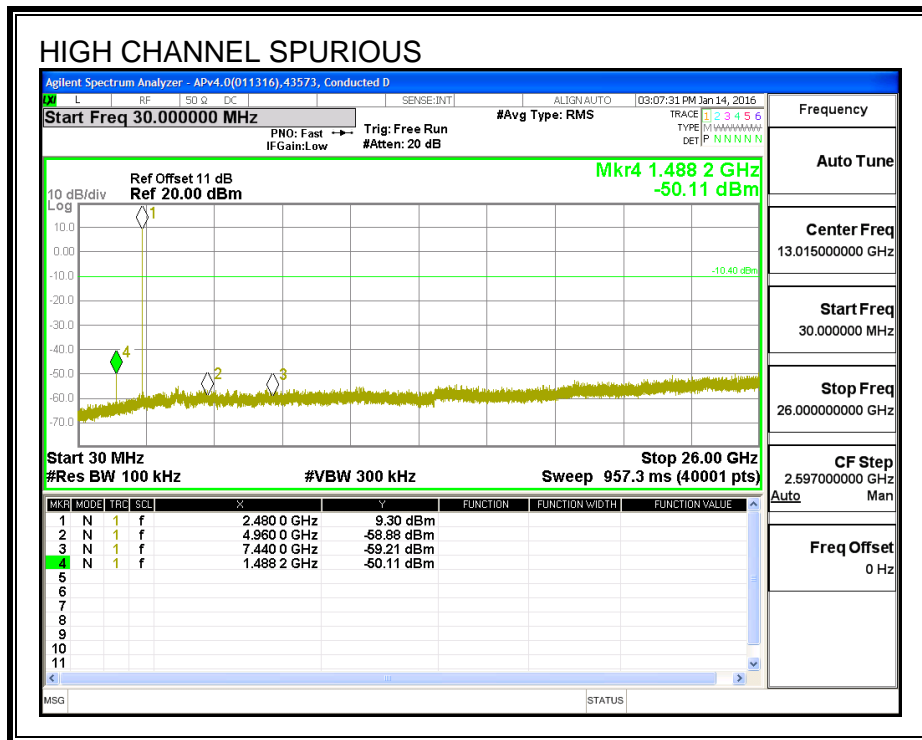
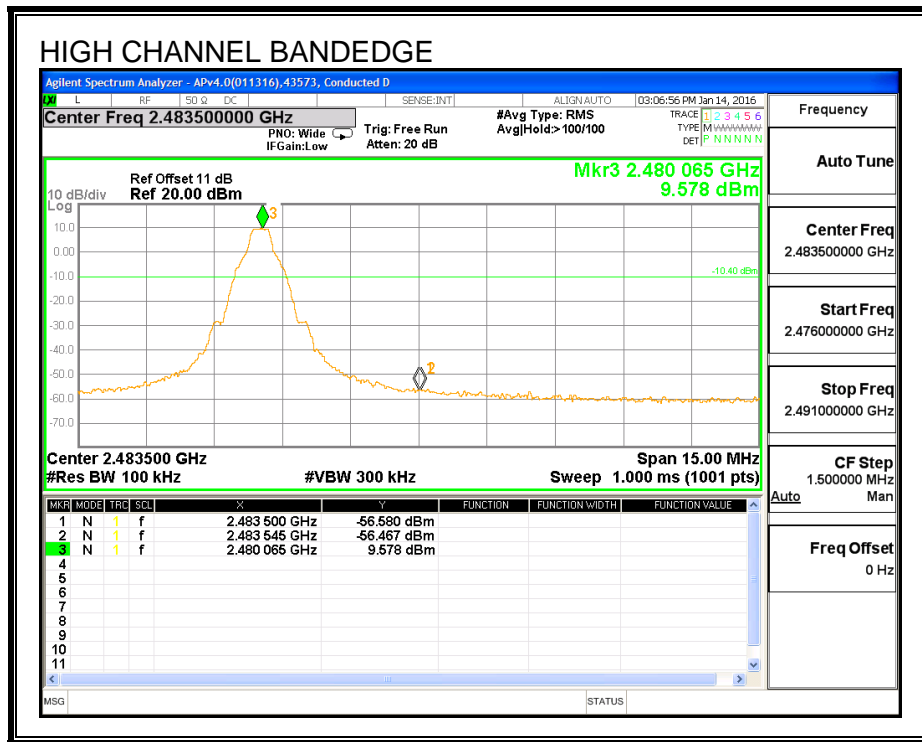

SPURIOUS BANDEGE EMISSIONS WITH HOPPING ON

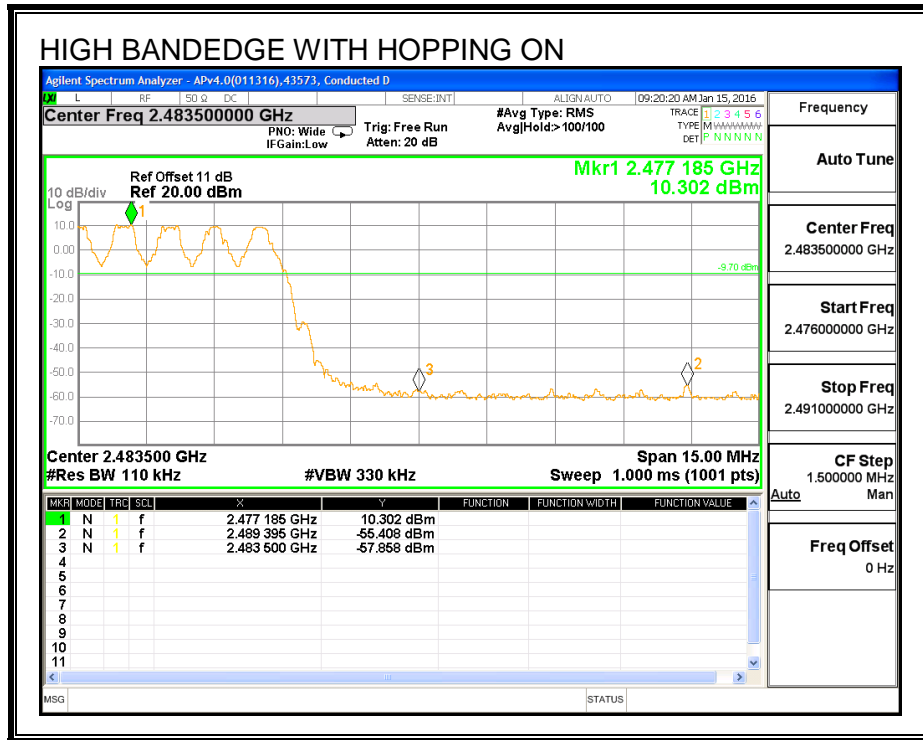
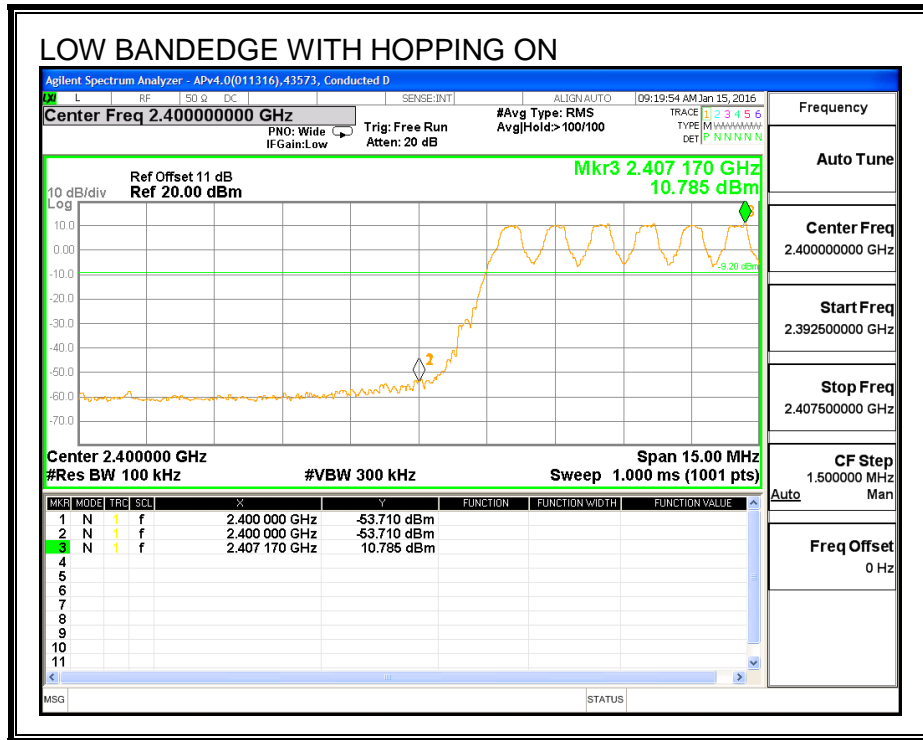

7.6. ANTENNA B LOW POWER ENHANCED DATA RATE QPSK MODULATION

7.6.1. OUTPUT POWER

LIMIT

§15.247 (b) (1)

RSS-247 (5.4) (2)

The maximum antenna gain is less than 6 dBi, therefore the limit is 30 dBm.

Alternatively, frequency hopping systems operating in the 2400-2483.5 MHz band may have hopping channel carrier frequencies that are separated by 25 kHz or two-thirds of the 20 dB bandwidth of the hopping channel, whichever is greater, provided the systems operate with an output power no greater than 125 mW.

TEST PROCEDURE

The transmitter output is connected to a wideband peak and average power meter.

RESULTS

Channel	Frequency (MHz)	Output Power (dBm)	Limit (dBm)	Margin (dB)
Low	2402	9.83	21	-11.14
Middle	2441	9.93	21	-11.04
High	2480	9.32	21	-11.65

7.6.2. AVERAGE POWER

LIMIT

None; for reporting purposes only.

TEST PROCEDURE

The transmitter output is connected to a power meter.

RESULTS

The cable assembly insertion loss of 11 dB (including 10 dB pad and 1 dB cable) was entered as an offset in the power meter to allow for direct reading of power.

Channel	Frequency (MHz)	Average Power (dBm)
Low	2402	7.66
Middle	2441	7.73
High	2480	7.11

7.7. ANTENNA B LOW POWER ENHANCED DATA RATE 8PSK MODULATION

7.7.1. 20 dB AND 99% BANDWIDTH

LIMIT

None; for reporting purposes only.

TEST PROCEDURE

The transmitter output is connected to a spectrum analyzer. The RBW is set to $\geq 1\%$ of the 20 dB bandwidth. The VBW is set to \geq RBW. The sweep time is coupled.

RESULTS

Channel	Frequency (MHz)	20 dB Bandwidth (MHz)	99% Bandwidth (MHz)
Low	2402	1.3690	1.2191
Middle	2441	1.3540	1.2191
High	2480	1.3430	1.2107

20 dB AND 99% BANDWIDTH

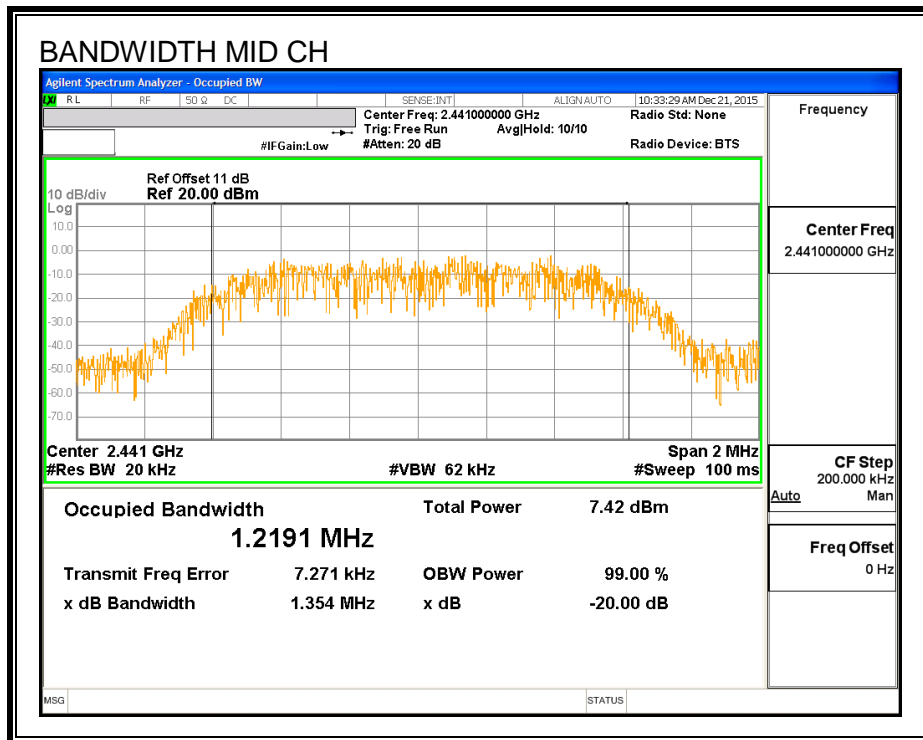
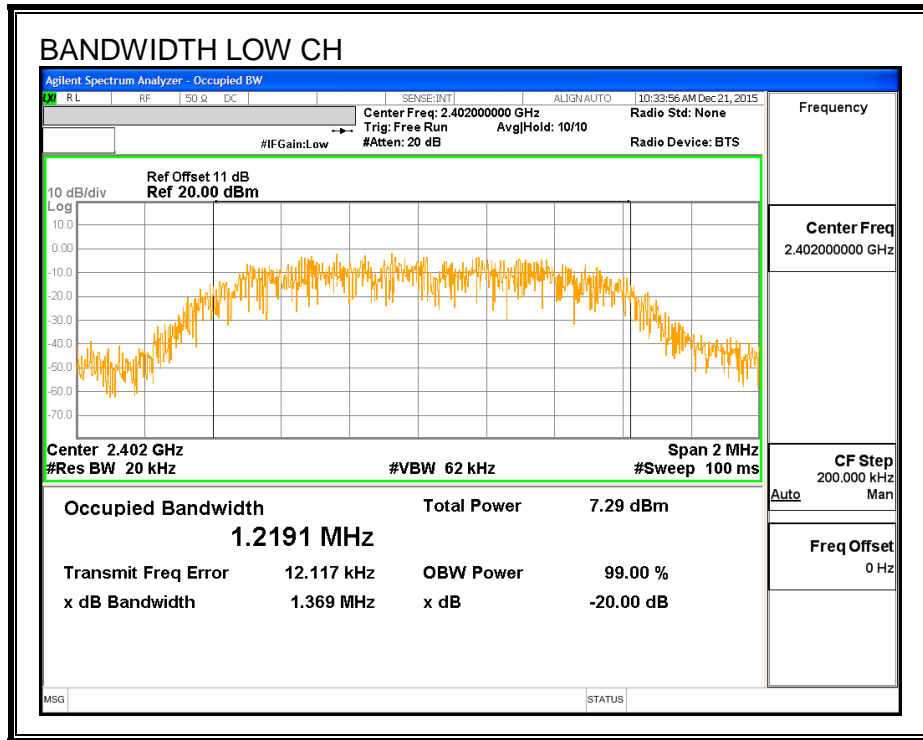

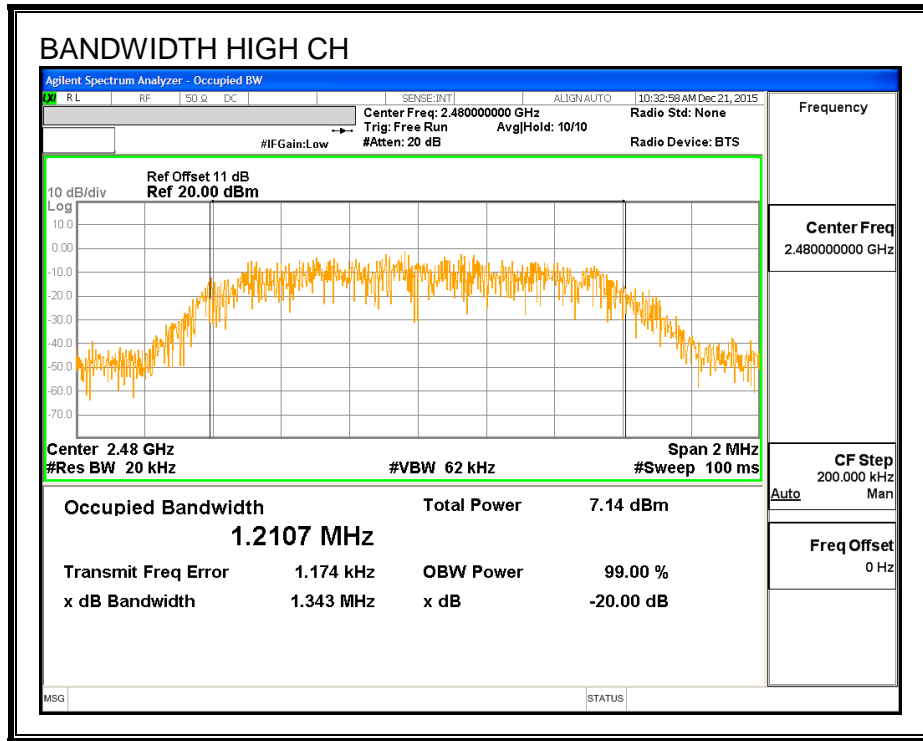

7.7.2. HOPPING FREQUENCY SEPARATION

LIMIT

FCC §15.247 (a) (1)

IC RSS-247 (5.1) (2)

Frequency hopping systems shall have hopping channel carrier frequencies separated by a minimum of 25 kHz or the 20 dB bandwidth of the hopping channel, whichever is greater.

Alternatively, frequency hopping systems operating in the 2400-2483.5 MHz band may have hopping channel carrier frequencies that are separated by 25 kHz or two-thirds of the 20 dB bandwidth of the hopping channel, whichever is greater, provided the systems operate with an output power no greater than 125 mW.

TEST PROCEDURE

The transmitter output is connected to a spectrum analyzer. The RBW is set to 300 kHz and the VBW is set to 910 kHz. The sweep time is coupled.

RESULTS

HOPPING FREQUENCY SEPARATION

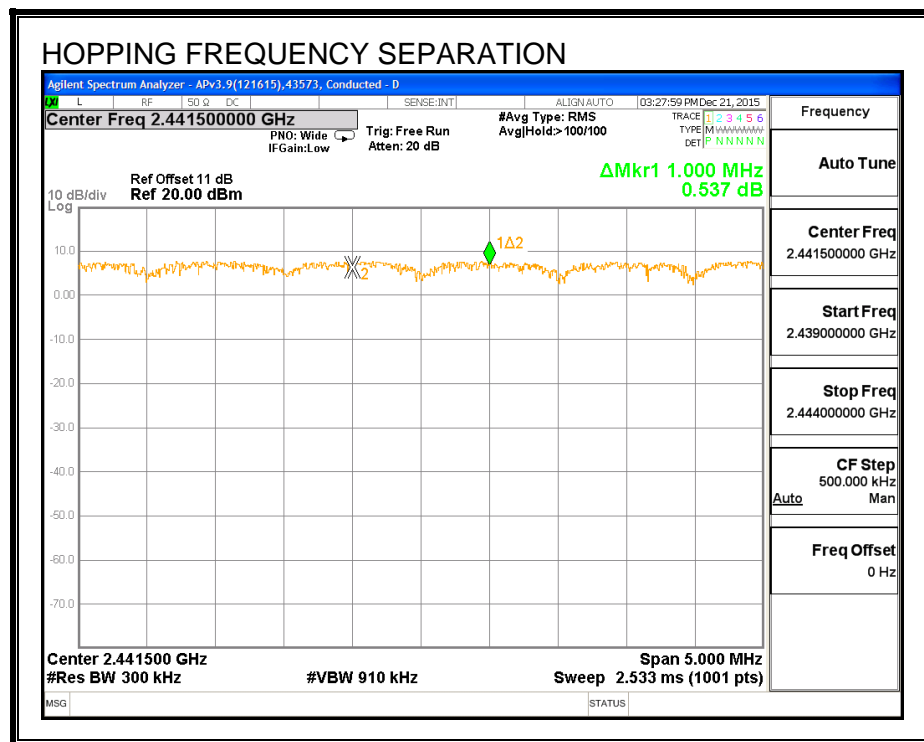

7.7.3. NUMBER OF HOPPING CHANNELS

LIMIT

FCC §15.247 (a) (1) (iii)

IC RSS-247 (5.1) (4)

Frequency hopping systems in the 2400 – 2483.5 MHz band shall use at least 15 non-overlapping channels.

TEST PROCEDURE

The transmitter output is connected to a spectrum analyzer. The span is set to cover the entire authorized band, in either a single sweep or in multiple contiguous sweeps. The RBW is set to a maximum of 1 % of the span. The analyzer is set to Max Hold.

RESULTS

Normal Mode: 79 Channels observed.

NUMBER OF HOPPING CHANNELS

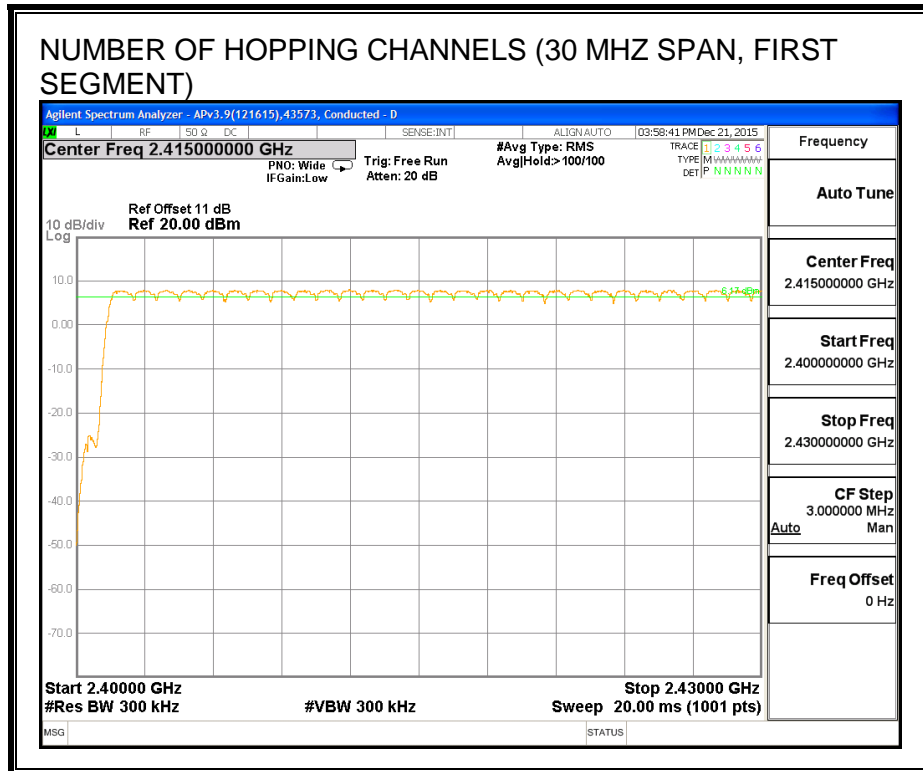
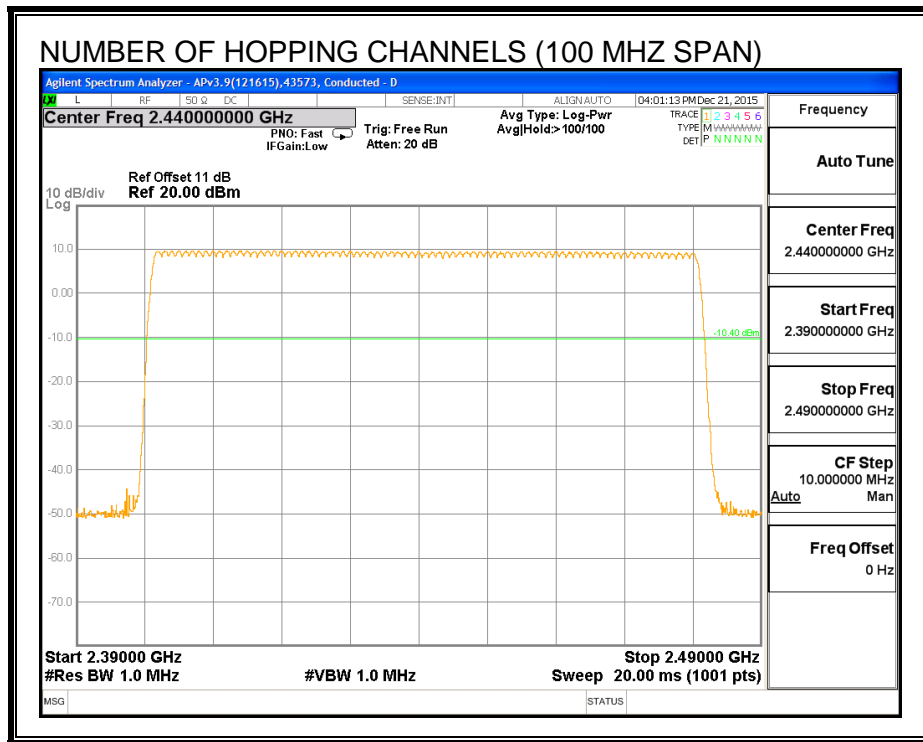

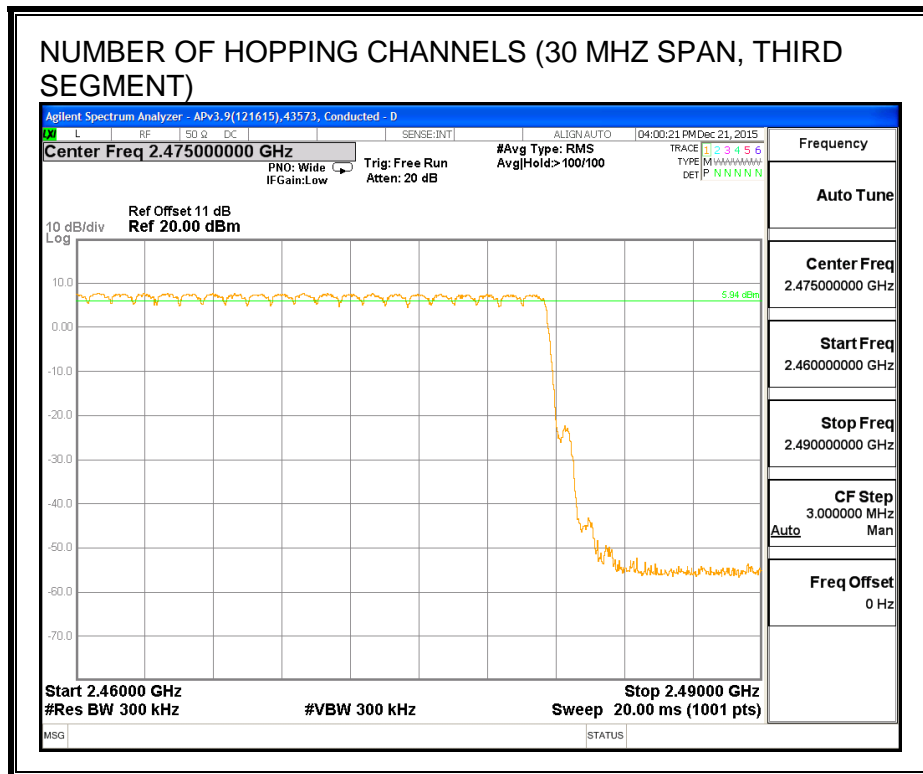
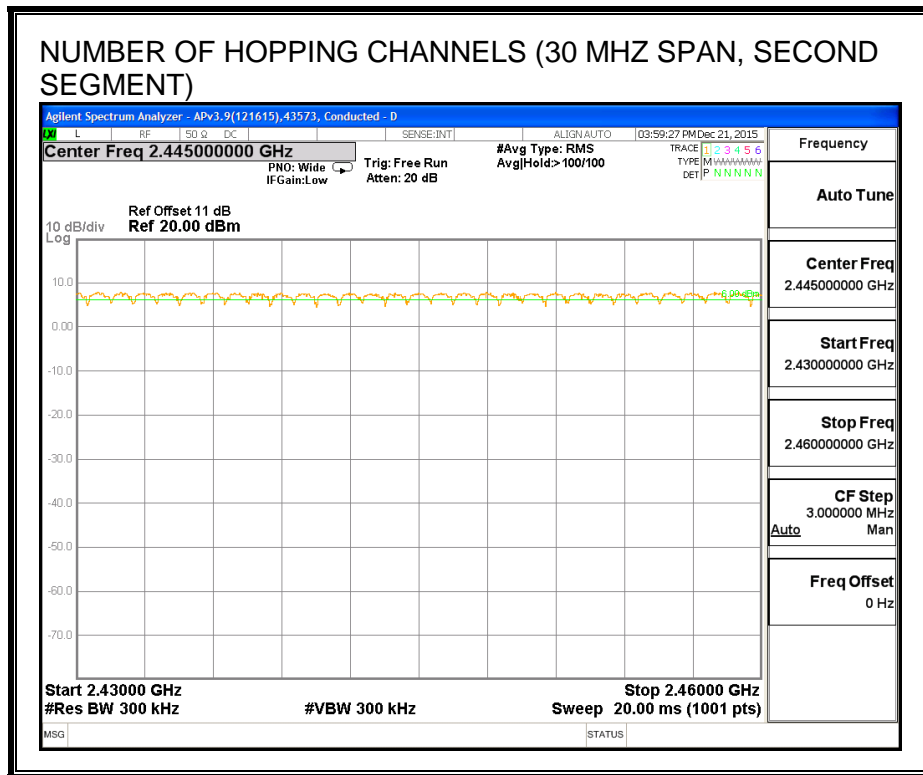

7.7.4. AVERAGE TIME OF OCCUPANCY

LIMIT

FCC §15.247 (a) (1) (iii)

IC RSS-247 (5.1) (4)

The average time of occupancy on any channel shall not be greater than 0.4 seconds within a period of 0.4 seconds multiplied by the number of hopping channels employed.

TEST PROCEDURE

The transmitter output is connected to a spectrum analyzer. The span is set to 0 Hz, centered on a single, selected hopping channel. The width of a single pulse is measured in a fast scan. The number of pulses is measured in a 3.16 second scan, to enable resolution of each occurrence.

The average time of occupancy in the specified 31.6 second period (79 channels * 0.4 s) is equal to $10 * (\# \text{ of pulses in } 3.16 \text{ s}) * \text{ pulse width}$.

RESULTS

8PSK (EDR) Mode

DH Packet	Pulse Width (msec)	Number of Pulses in 3.16 seconds	Average Time of (sec)	Limit (sec)	Margin (sec)
3DH1	0.391	32	0.125	0.4	-0.275
3DH3	1.658	20	0.332	0.4	-0.068
3DH5	2.904	12	0.348	0.4	-0.052

PULSE WIDTH - 3DH1

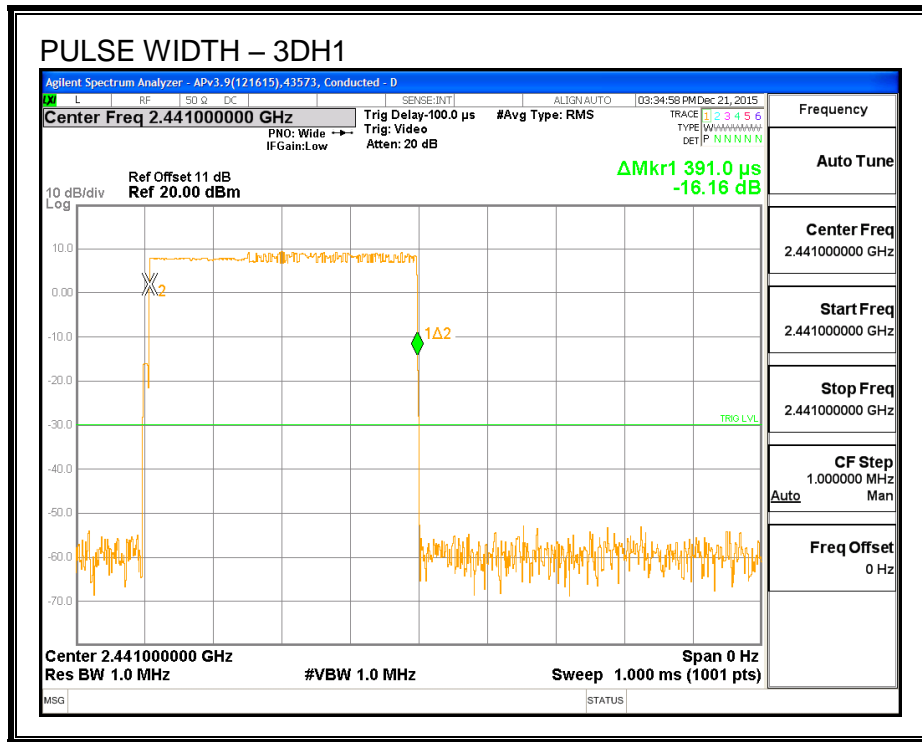

NUMBER OF PULSES IN 3.16 SECOND OBSERVATION PERIOD – 3DH1

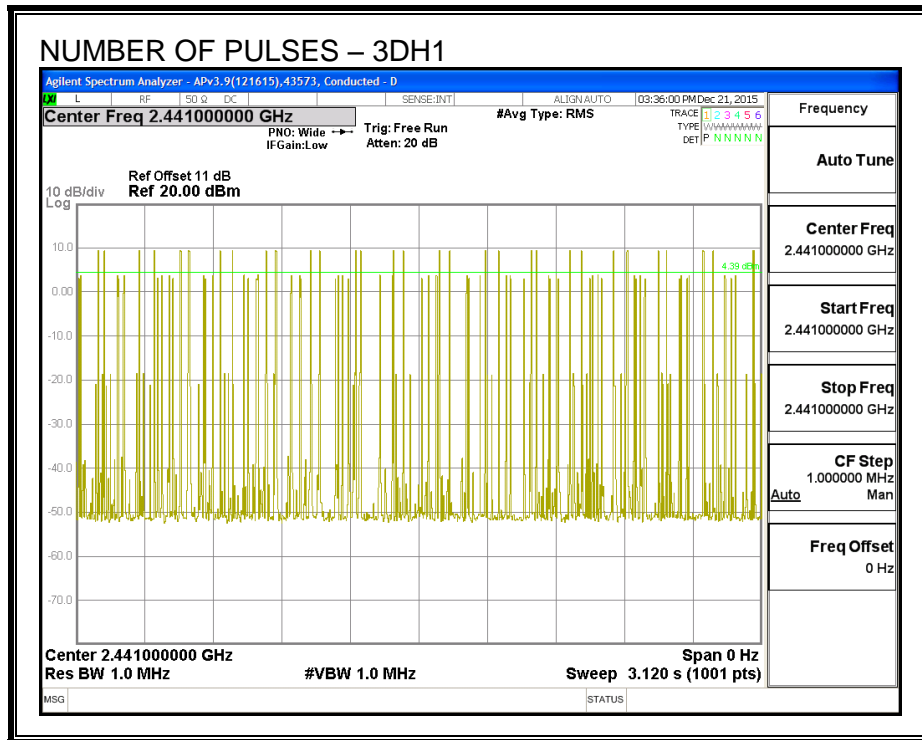

PULSE WIDTH – 3DH3

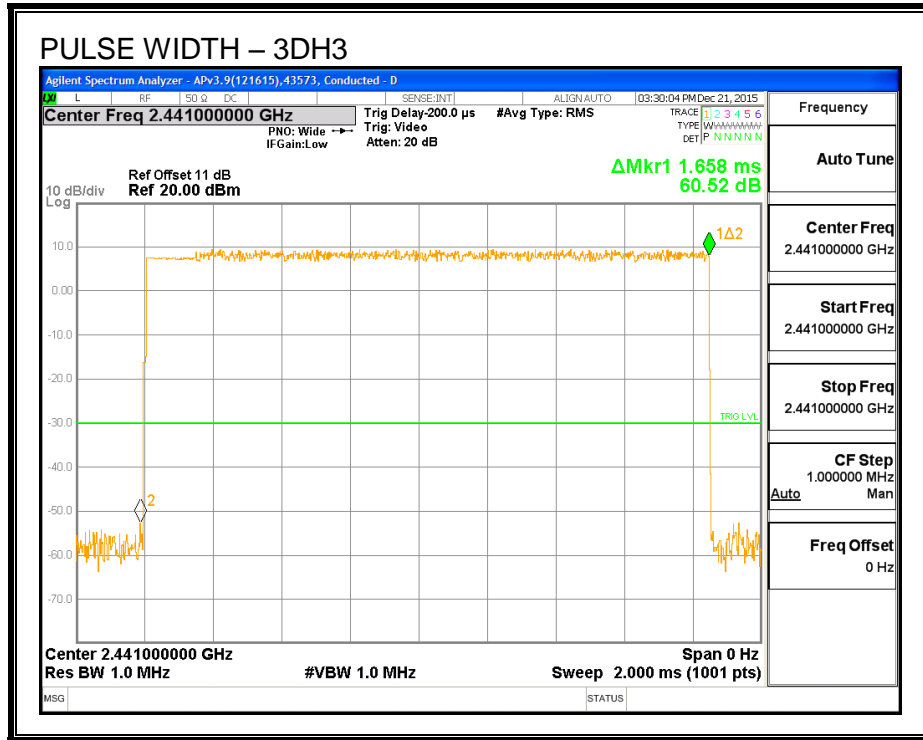

NUMBER OF PULSES IN 3.16 SECOND OBSERVATION PERIOD – 3DH3

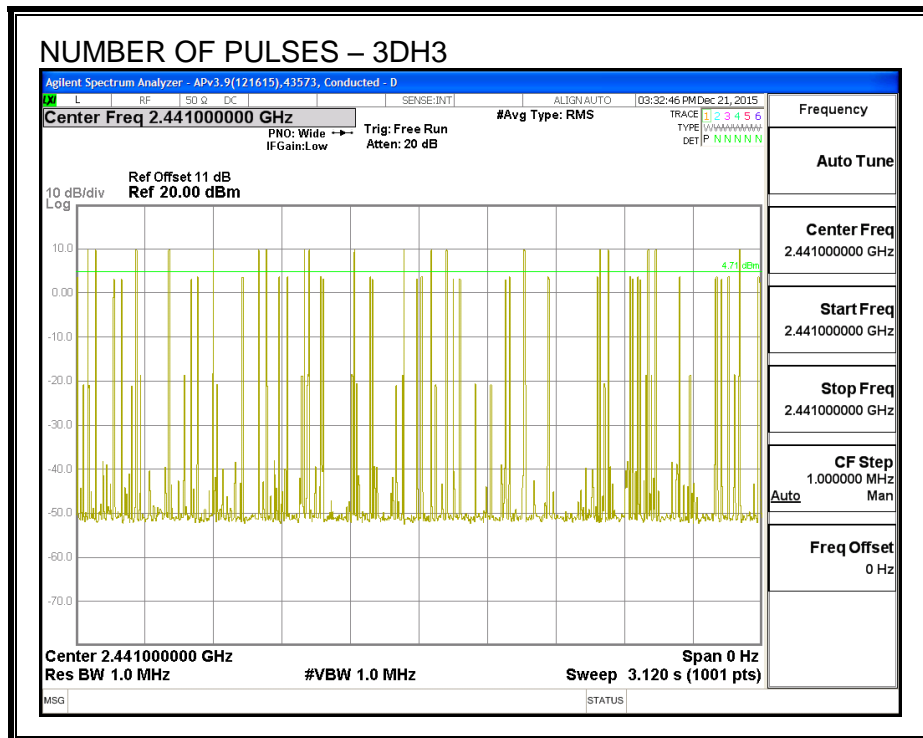

PULSE WIDTH – 3DH5

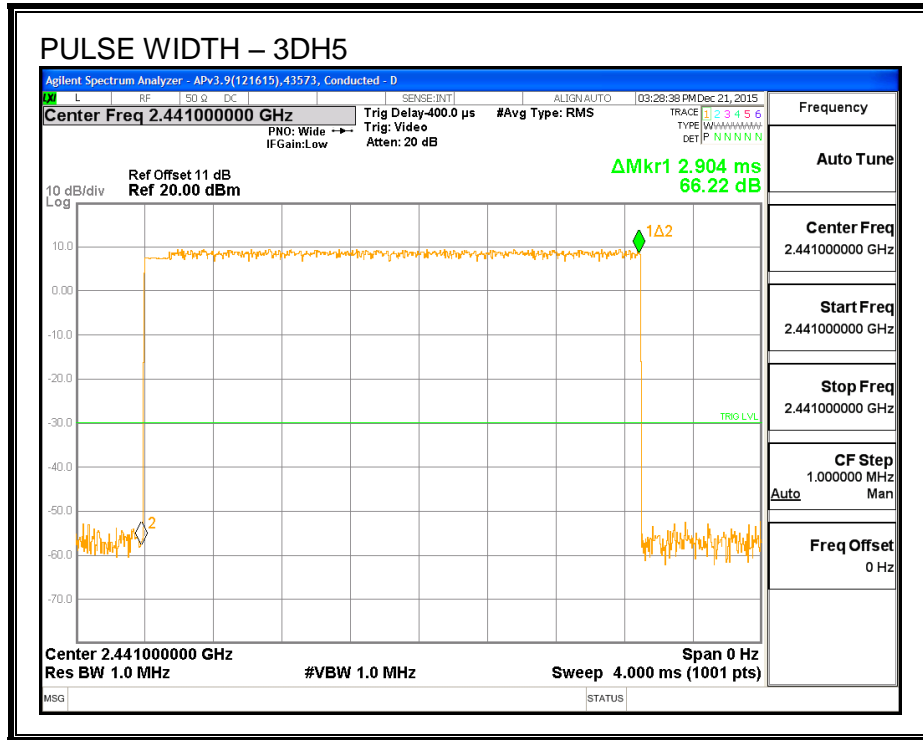

NUMBER OF PULSES IN 3.16 SECOND OBSERVATION PERIOD – 3DH5

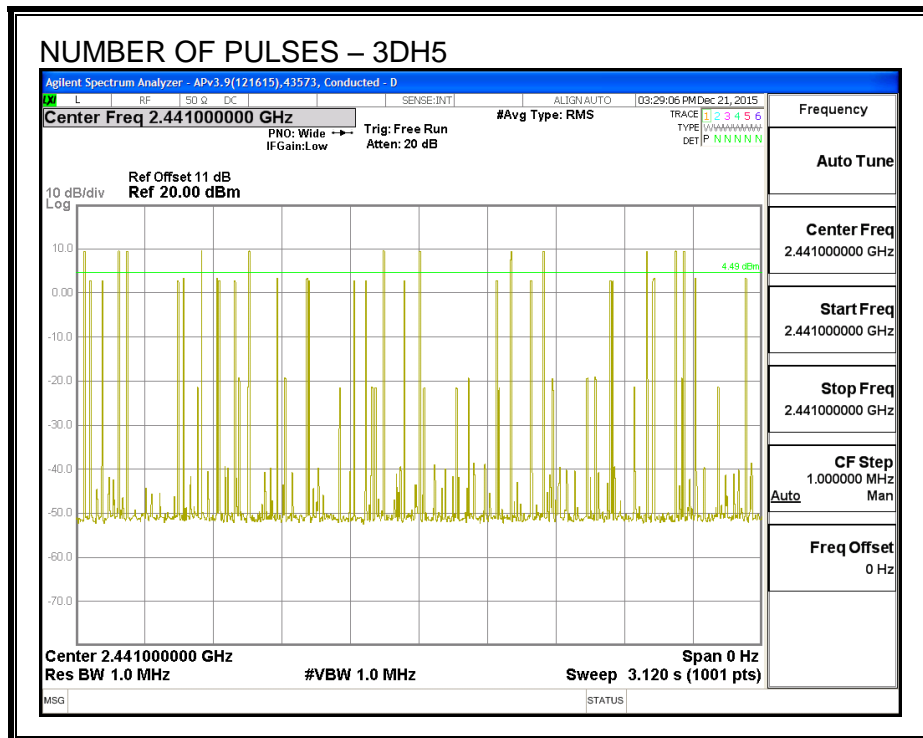

7.7.5. OUTPUT POWER

LIMIT

§15.247 (b) (1)

RSS-247 (5.4) (2)

The maximum antenna gain is less than 6 dBi, therefore the limit is 30 dBm.

Alternatively, frequency hopping systems operating in the 2400-2483.5 MHz band may have hopping channel carrier frequencies that are separated by 25 kHz or two-thirds of the 20 dB bandwidth of the hopping channel, whichever is greater, provided the systems operate with an output power no greater than 125 mW.

TEST PROCEDURE

The transmitter output is connected to a wideband peak and average power meter.

RESULTS

Channel	Frequency (MHz)	Output Power (dBm)	Limit (dBm)	Margin (dB)
Low	2402	10.19	21	-10.78
Middle	2441	10.27	21	-10.70
High	2480	9.43	21	-11.54

7.7.6. AVERAGE POWER

LIMIT

None; for reporting purposes only.

TEST PROCEDURE

The transmitter output is connected to a power meter.

RESULTS

The cable assembly insertion loss of 11 dB (including 10 dB pad and 1 dB cable) was entered as an offset in the power meter to allow for direct reading of power.

Channel	Frequency (MHz)	Average Power (dBm)
Low	2402	7.67
Middle	2441	7.74
High	2480	7.12

7.7.7. CONDUCTED SPURIOUS EMISSIONS

LIMITS

FCC §15.247 (d)

IC RSS-247 (5.5)

Limit = -20 dBc

TEST PROCEDURE

The transmitter output is connected to a spectrum analyzer. The resolution bandwidth is set to 100 kHz. The video bandwidth is set to 300 kHz.

The spectrum from 30 MHz to 26 GHz is investigated with the transmitter set to the lowest, middle, and highest channels.

The bandedges at 2.4 and 2.4835 GHz are investigated with the transmitter set to the normal hopping mode.

RESULTS