



CERTIFICATION TEST REPORT

Report Number. : 16U23816-E3V3

Applicant : APPLE, INC.
1 INFINITE LOOP
CUPERTINO, CA 95014, U.S.A.

Model : A1671, A1821

FCC ID : BCGA1671

IC : 579C-A1671

EUT Description : TABLET DEVICE

Test Standard(s) : FCC 47 CFR PART 15 SUBPART C
INDUSTRY CANADA RSS - 247 ISSUE 1

Date Of Issue:
March 09, 2017

Prepared by:
UL Verification Services Inc.
47173 Benicia Street
Fremont, CA 94538, U.S.A.
TEL: (510) 771-1000
FAX: (510) 661-0888



NVLAP LAB CODE 200065-0

Revision History

<u>Rev.</u>	<u>Issue Date</u>	<u>Revisions</u>	<u>Revised By</u>
V1	02/21/2017	Initial Issue	Chin Pang
V2	02/28/2017	Address TCB Questions	Chin Pang
V3	03/09/2017	Address TCB Questions	Mengistu Mekuria

TABLE OF CONTENTS

1. ATTESTATION OF TEST RESULTS	5
2. TEST METHODOLOGY	6
3. FACILITIES AND ACCREDITATION	6
4. CALIBRATION AND UNCERTAINTY	6
4.1. <i>MEASURING INSTRUMENT CALIBRATION</i>	<i>6</i>
4.2. <i>SAMPLE CALCULATION</i>	<i>6</i>
4.3. <i>MEASUREMENT UNCERTAINTY.....</i>	<i>7</i>
5. EQUIPMENT UNDER TEST	8
5.1. <i>DESCRIPTION OF EUT</i>	<i>8</i>
5.1. <i>DESCRIPTION OF MODELS DIFFERENCES.....</i>	<i>8</i>
5.2. <i>MAXIMUM OUTPUT POWER.....</i>	<i>8</i>
5.3. <i>DESCRIPTION OF AVAILABLE ANTENNAS</i>	<i>8</i>
5.4. <i>SOFTWARE AND FIRMWARE.....</i>	<i>8</i>
5.5. <i>WORST-CASE CONFIGURATION AND MODE.....</i>	<i>9</i>
5.6. <i>DESCRIPTION OF TEST SETUP.....</i>	<i>10</i>
6. TEST AND MEASUREMENT EQUIPMENT	16
7. MEASUREMENT METHODS	17
8. ANTENNA PORT TEST RESULTS	18
8.1. <i>11b ANTENNA A SISO MODE IN THE 2.4GHz BAND</i>	<i>21</i>
8.1.1. <i>6 dB BANDWIDTH.....</i>	<i>21</i>
8.1.2. <i>99% BANDWIDTH.....</i>	<i>25</i>
8.1.3. <i>AVERAGE POWER.....</i>	<i>29</i>
8.1.4. <i>OUTPUT POWER</i>	<i>30</i>
8.1.5. <i>POWER SPECTRAL DENSITY</i>	<i>32</i>
8.1.6. <i>CONDUCTED BANDEDGE AND SPURIOUS EMISSIONS.....</i>	<i>36</i>
8.2. <i>11b ANTENNA B SISO MODE IN THE 2.4GHz BAND</i>	<i>42</i>
8.2.1. <i>6 dB BANDWIDTH.....</i>	<i>42</i>
8.2.2. <i>99% BANDWIDTH.....</i>	<i>46</i>
8.2.3. <i>AVERAGE POWER.....</i>	<i>50</i>
8.2.4. <i>OUTPUT POWER</i>	<i>51</i>
8.2.5. <i>POWER SPECTRAL DENSITY</i>	<i>53</i>
8.2.6. <i>CONDUCTED BANDEDGE AND SPURIOUS EMISSIONS.....</i>	<i>57</i>
8.3. <i>11n HT20 ANTENNA A SISO MODE IN THE 2.4GHz BAND</i>	<i>63</i>
8.3.1. <i>6 dB BANDWIDTH.....</i>	<i>63</i>
8.3.2. <i>99% BANDWIDTH.....</i>	<i>67</i>

- 8.3.3. AVERAGE POWER71
- 8.3.4. OUTPUT POWER72
- 8.3.5. POWER SPECTRAL DENSITY74
- 8.3.6. CONDUCTED BANDEDGE AND SPURIOUS EMISSIONS.....78
- 8.4. *11n HT20 ANTENNA B SISO MODE IN THE 2.4GHz BAND*84
 - 8.4.1. 6 dB BANDWIDTH.....84
 - 8.4.2. 99% BANDWIDTH.....88
 - 8.4.3. AVERAGE POWER.....92
 - 8.4.4. OUTPUT POWER93
 - 8.4.5. POWER SPECTRAL DENSITY95
 - 8.4.6. CONDUCTED BANDEDGE AND SPURIOUS EMISSIONS.....99
- 8.5. *11n HT20 2TX CDD MIMO MODE IN THE 2.4GHz BAND* 105
 - 8.5.1. 6 dB BANDWIDTH.....105
 - 8.5.2. 99% BANDWIDTH.....112
 - 8.5.3. AVERAGE POWER.....119
 - 8.5.4. OUTPUT POWER120
 - 8.5.5. POWER SPECTRAL DENSITY122
 - 8.5.6. CONDUCTED BANDEDGE AND SPURIOUS EMISSIONS.....129
- 9. RADIATED TEST RESULTS..... 140**
 - 9.1. *LIMITS AND PROCEDURE*..... 140
 - 9.2. *TRANSMITTER ABOVE 1 GHz*..... 141
 - 9.2.1. 11b ANTENNA A SISO MODE IN THE 2.4GHz BAND141
 - 9.2.2. 11b ANTENNA B SISO MODE IN THE 2.4GHz BAND155
 - 9.2.3. 11n HT20 ANTENNA A SISO MODE IN THE 2.4GHz BAND169
 - 9.2.4. 11n HT20 ANTENNA B SISO MODE IN THE 2.4GHz BAND185
 - 9.2.5. 11n HT20 2TX CDD MIMO MODE IN THE 2.4GHz BAND201
 - 9.3. *WORST-CASE BELOW 1 GHz*.....217
 - 9.4. *WORST-CASE 18 to 26 GHz*.....219
- 10. AC POWER LINE CONDUCTED EMISSIONS221**
 - 10.1. *EUT POWERED BY AC/DC ADAPTER VIA USB CABLE*.....222
 - 10.2. *EUT POWERED BY HOST PC VIA USB CABLE*.....224
- 11. SETUP PHOTOS226**

1. ATTESTATION OF TEST RESULTS

COMPANY NAME: APPLE, INC.
1 INFINITE LOOP
CUPERTINO, CA 95014, U.S.A.

EUT DESCRIPTION: TABLET DEVICE

MODEL: A1671, A1821

SERIAL NUMBER: CONDUCTED (DLXSP00BHPJV), RADIATED (DLXSN00CHPJJK)

DATE TESTED: DECEMBER 06, 2016 – FEBRUARY 08, 2017

APPLICABLE STANDARDS	
STANDARD	TEST RESULTS
CFR 47 Part 15 Subpart C	Pass
INDUSTRY CANADA RSS-247 Issue 1	Pass
INDUSTRY CANADA RSS-GEN Issue 4	Pass

UL Verification Services Inc. tested the above equipment in accordance with the requirements set forth in the above standards. All indications of Pass/Fail in this report are opinions expressed by UL Verification Services Inc. based on interpretations and/or observations of test results. Measurement Uncertainties were not taken into account and are published for informational purposes only. The test results show that the equipment tested is capable of demonstrating compliance with the requirements as documented in this report.

Note: The results documented in this report apply only to the tested sample, under the conditions and modes of operation as described herein. This document may not be altered or revised in any way unless done so by UL Verification Services Inc. and all revisions are duly noted in the revisions section. Any alteration of this document not carried out by UL Verification Services Inc. will constitute fraud and shall nullify the document. This report must not be used by the client to claim product certification, approval, or endorsement by NVLAP, NIST, any agency of the Federal Government, or any agency of any government.

Approved & Released For
UL Verification Services Inc. By:

Prepared By:

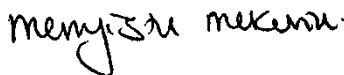

MENGISTU MEKURIA
SENIOR ENGINEER
UL VERIFICATION SERVICES INC.

ERIC YU
LAB ENGINEER
UL VERIFICATION SERVICES INC.

2. TEST METHODOLOGY

The tests documented in this report were performed in accordance with FCC CFR 47 Part 2, FCC CFR 47 Part 15, KDB 558074 D01 v03r05, ANSI C63.10-2013, RSS-GEN Issue 4, and RSS-247 Issue 1.

3. FACILITIES AND ACCREDITATION

The test sites and measurement facilities used to collect data are located at 47173 and 47266 Benicia Street, Fremont, California, USA. Line conducted emissions are measured only at the 47173 address. The following table identifies which facilities were utilized for radiated emission measurements documented in this report. Specific facilities are also identified in the test results sections.

47173 Benicia Street	47266 Benicia Street
<input type="checkbox"/> Chamber A (IC:2324B-1)	<input checked="" type="checkbox"/> Chamber D (IC:2324B-4)
<input type="checkbox"/> Chamber B (IC:2324B-2)	<input checked="" type="checkbox"/> Chamber E (IC:2324B-5)
<input type="checkbox"/> Chamber C (IC:2324B-3)	<input checked="" type="checkbox"/> Chamber F (IC:2324B-6)
	<input type="checkbox"/> Chamber G (IC:2324B-7)
	<input checked="" type="checkbox"/> Chamber H (IC:2324B-8)

The above test sites and facilities are covered under FCC Test Firm Registration # 208313.

UL Verification Services Inc. is accredited by NVLAP, Laboratory Code 200065-0. The full scope of accreditation can be viewed at <http://ts.nist.gov/standards/scopes/2000650.htm>.

4. CALIBRATION AND UNCERTAINTY

4.1. MEASURING INSTRUMENT CALIBRATION

The measuring equipment utilized to perform the tests documented in this report has been calibrated in accordance with the manufacturer's recommendations, and is traceable to recognized national standards.

4.2. SAMPLE CALCULATION

Where relevant, the following sample calculation is provided:

$$\begin{aligned} \text{Field Strength (dBuV/m)} &= \text{Measured Voltage (dBuV)} + \text{Antenna Factor (dB/m)} + \\ &\text{Cable Loss (dB)} - \text{Preamp Gain (dB)} \\ 36.5 \text{ dBuV} + 18.7 \text{ dB/m} + 0.6 \text{ dB} - 26.9 \text{ dB} &= 28.9 \text{ dBuV/m} \end{aligned}$$

4.3. MEASUREMENT UNCERTAINTY

Where relevant, the following measurement uncertainty levels have been estimated for tests performed on the apparatus:

Parameter	Uncertainty
Worst Case Conducted Disturbance, 9KHz to 0.15 MHz	3.84 dB
Worst Case Conducted Disturbance, 0.15 to 30 MHz	3.65 dB
Worst Case Radiated Disturbance, 9KHz to 30 MHz	3.15 dB
Worst Case Radiated Disturbance, 30 to 1000 MHz	5.36 dB
Worst Case Radiated Disturbance, 1000 to 18000 MHz	4.32 dB
Worst Case Radiated Disturbance, 18000 to 26000 MHz	4.45 dB
Worst Case Radiated Disturbance, 26000 to 40000 MHz	5.24 dB

Uncertainty figures are valid to a confidence level of 95%.

5. EQUIPMENT UNDER TEST

5.1. DESCRIPTION OF EUT

The EUT, model number A1671, A1821 is a tablet with multimedia functions (music, application support, and video), Cellular GSM/GPRS/EGPRS/CDMA2000 1xRTT/1x Advanced/EVDO Rev.A/WCDMA /HSPA+/DC- HSDPA/LTE FDD & Carrier Aggregation/TDD/TD-SCDMA radio, IEEE 802.11a/b/g/n/ac radio, and Bluetooth radio. The rechargeable battery is not user accessible.

5.1. DESCRIPTION OF MODELS DIFFERENCES

Both Model A1671 and A1821 have identical PCB layout, design and functionality, except that A1671 supports second electronic-UICC based SIM or “soft SIM” (called eSIM) beside the regular UICC based SIM and A1821 will come with eSIM removed. RF and electromagnetic characteristic are independent of the eSIM element. Both Models have exactly same technology and band support. Model A1671 is used for EMC/RSE Testing and that data will be used for both Models

5.2. MAXIMUM OUTPUT POWER

The transmitter has a maximum conducted peak output power as follows:

Frequency Range (MHz)	Mode	Output Power (dBm)	Output Power (mW)
2412 - 2472	802.11b 1TX	19.97	99.31
2412 - 2472	802.11g 1TX	Covered by HT20 1TX	
2412 - 2472	802.11g 2TX	Covered by HT20 2TX CDD	
2412 - 2472	802.11n HT20 1TX	20.02	100.46
2412 - 2472	802.11n HT20 2TX CDD	22.09	161.81

5.3. DESCRIPTION OF AVAILABLE ANTENNAS

Frequency Band (GHz)	Antenna Gain (dBi)	
	Ant A	Ant B
2.4	-0.48	-0.99

5.4. SOFTWARE AND FIRMWARE

The firmware installed in the EUT during testing was 14E232.

5.5. WORST-CASE CONFIGURATION AND MODE

For below 1G radiated emission and power line conducted emission were performed with the EUT set to transmit at the channel with highest output power as worst-case scenario.

For g and HT20 modes, radiated harmonics spurious and power line conducted emissions were performed with the EUT set at the CDD mode at highest power setting among the CDD/STBC/SDM/Beamforming modes as worst-case scenario.

The fundamental of the EUT was investigated in three orthogonal orientations X/Y/Z, it was determined that Y-Landscape orientation was worst-case orientation. Therefore, all final radiated testing was performed with the EUT in Y-Landscape orientation.

Worst-case data rates as provided by the client were:

802.11b mode: 1 Mbps
802.11g mode: 6 Mbps
802.11n HT20mode: MCS0

The following modes have the same target power and use the same modulation (OFDM). Therefore, 802.11g 1TX and 802.11g 2TX are covered by 802.11n HT20 1TX and 802.11n HT20 2TX CDD respectively.

- 802.11g and 802.11n HT20 1TX
- 802.11g 2TX and 802.11n HT20 2TX CDD

For simultaneous transmission of multiple channels from the same antenna in the 2.4GHz and 5GHz bands, tests were conducted for various configurations having the highest power. No noticeable new emission was found.

There are two vendors of the WiFi/Bluetooth radio modules: variant 1 and variant 2. The WiFi/Bluetooth radio modules have the same mechanical outline (e.g., the same package dimension and pin-out layout), use the same on-board antenna matching circuit, have an identical antenna structure, and are built and tested to conform to the same specifications and to operate within the same tolerances.

Baseline testing was performed on the two variants to determine the worst case on all conducted power and radiated emissions.

5.6. DESCRIPTION OF TEST SETUP

SUPPORT EQUIPMENT

Description	Manufacturer	Model	Serial Number	FCC ID
Laptop	Apple	A1286	7313700NAGW	N/A
Laptop AC/DC adapter	Apple	A1343	C062172045DDJ94A6	N/A
Earphone	Apple	NA	NA	N/A
EUT AC/DC adapter	Apple	A1357	W010A051	N/A

I/O CABLES (CONDUCTED TEST)

I/O Cable List						
Cable No	Port	# of identical ports	Connector Type	Cable Type	Cable Length (m)	Remarks
1	Antenna	1	SMA	Un-Shielded	0.2	To spectrum Analyzer
2	USB	1	USB	Shielded	1	N/A
3	AC	1	AC	Un-shielded	2	N/A

I/O CABLES (RADIATED ABOVE 1 GHZ)

I/O Cable List						
Cable No	Port	# of identical ports	Connector Type	Cable Type	Cable Length (m)	Remarks
None Used						

I/O CABLES (RADIATED BELOW 1 GHZ AND AC LINE CONDUCTED: AC/DC ADAPTER)

I/O Cable List						
Cable No	Port	# of identical	Connector Type	Cable Type	Cable Length (m)	Remarks
1	Headphones Jack	1	3.5mm Audio	Shielded	0.9	N/A
2	AC	1	AC	Un-shielded	2	N/A

I/O CABLES (AC LINE CONDUCTED: LAPTOP CONFIGURATION)

I/O Cable List						
Cable No	Port	# of identical	Connector Type	Cable Type	Cable Length (m)	Remarks
1	Headphones Jack	1	3.5mm Audio	Shielded	0.9	N/A
2	USB	1	USB	Shielded	1	N/A
3	AC	1	AC	Un-shielded	2	N/A

TEST SETUP CONDUCTED

The EUT was tested connected to a host Laptop via USB cable adapter and spectrum analyzer to antenna port. Test software exercised the EUT.

SETUP DIAGRAM

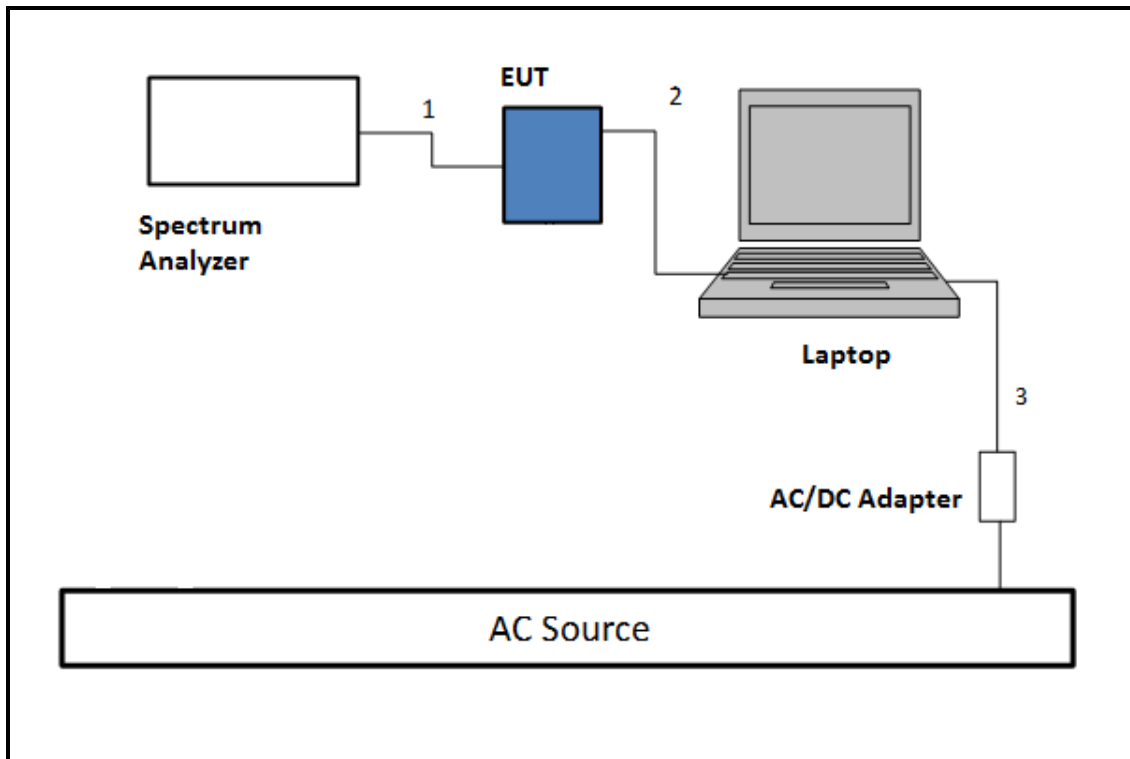

TEST SETUP- RADIATED-ABOVE 1 GHZ

The EUT was tested battery powered. Test software exercised the EUT.

SETUP DIAGRAM

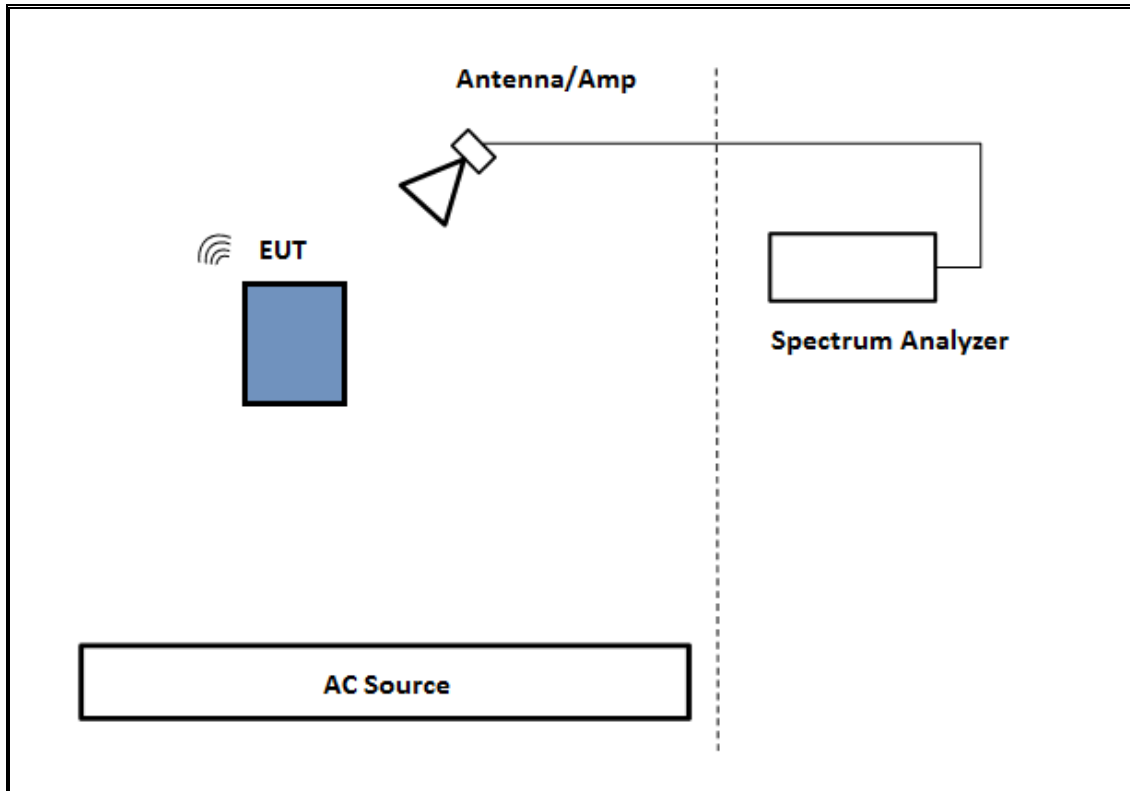

TEST SETUP- BELOW 1GHZ

The EUT was tested with earphone connected and powered by AC adapter. Test software exercised the EUT.

SETUP DIAGRAM

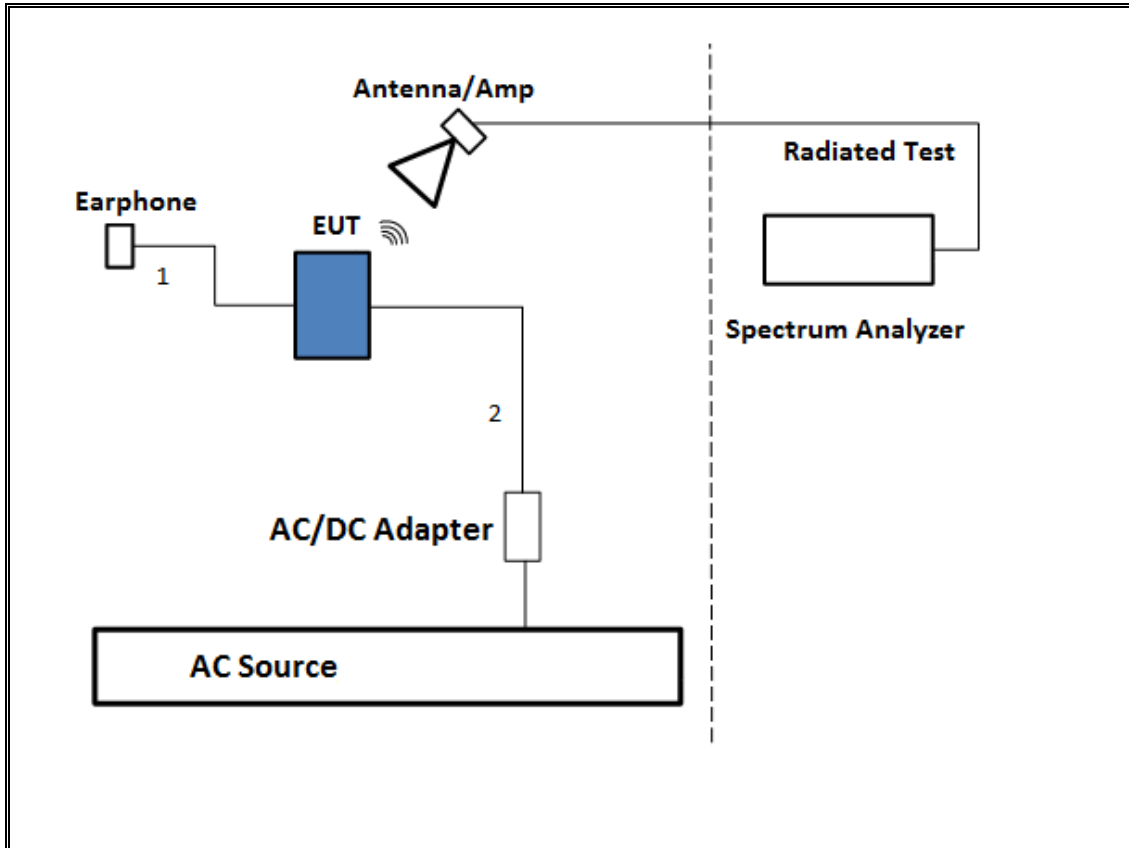

TEST SETUP - AC LINE CONDUCTED TESTS

The EUT was tested with earphone connected and powered by AC adapter. Test software exercised the EUT.

SETUP DIAGRAM

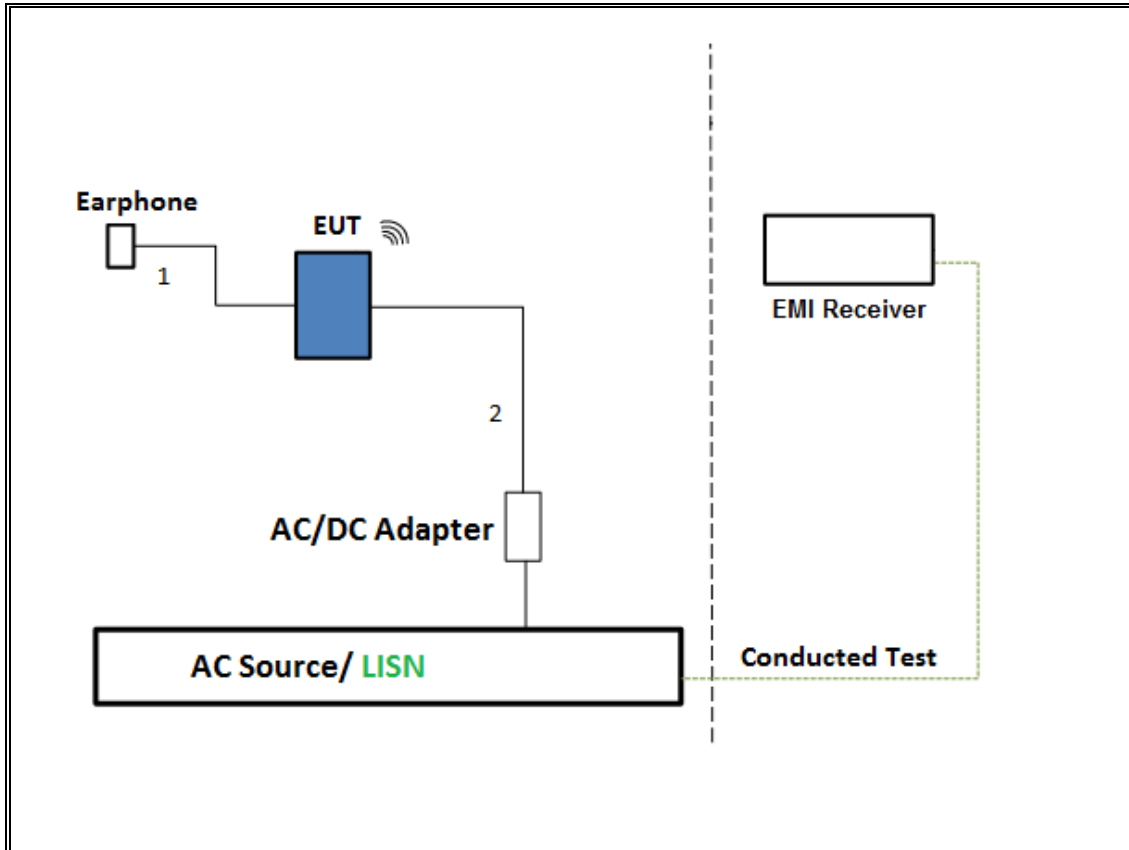

TEST SETUP- AC LINE CONDUCTED: LAPTOP CONFIGURATION

The EUT was tested with earphone connected and powered by host PC via USB cable. Test software exercised the EUT.

SETUP DIAGRAM

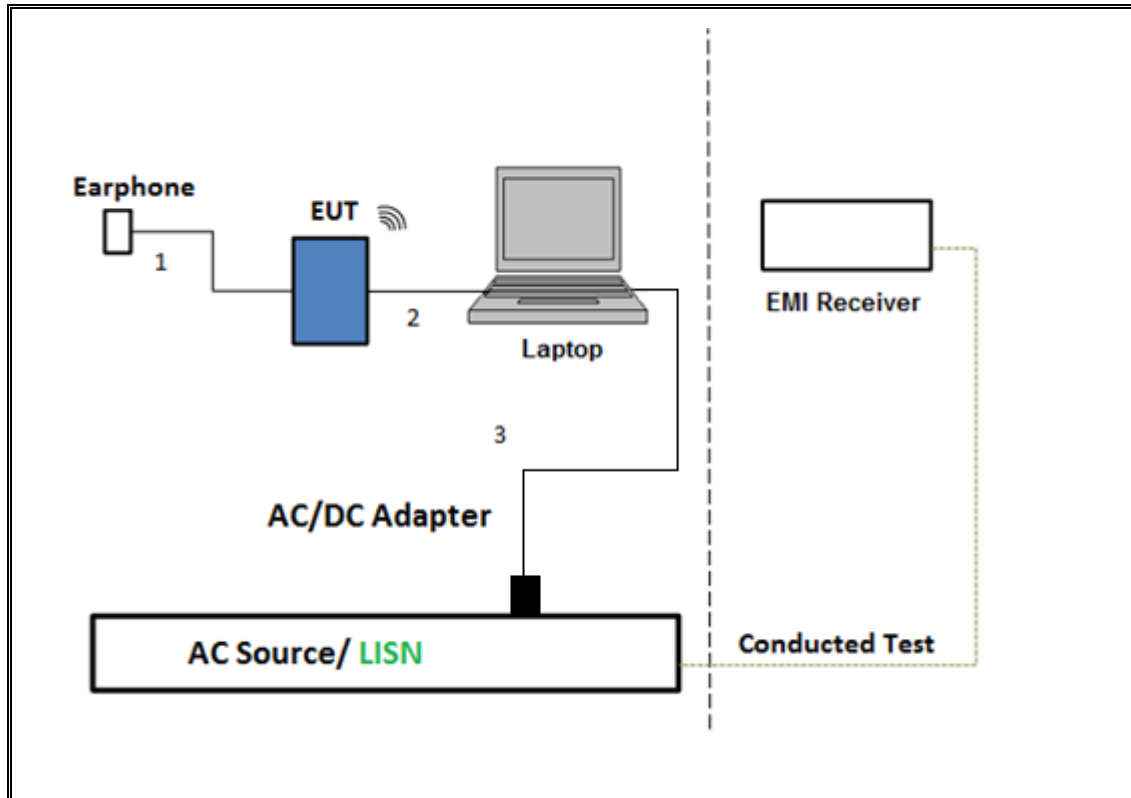

6. TEST AND MEASUREMENT EQUIPMENT

The following test and measurement equipment was utilized for the tests documented in this report:

TEST EQUIPMENT LIST				
Description	Manufacturer	Model	Asset	Cal Due
* Antenna, Horn 1-18GHz	ETS Lindgren	3117	T344	2/22/2017
Antenna, Broadband Hybrid, 30MHz to 2000MHz	Sunol Sciences	JB3	T407	4/4/2017
Amplifier, 10KHz to 1GHz, 32dB	Sonoma	310N	T286	5/4/2017
Amplifier, 1 to 18GHz	Miteq	AFS42-00101800-25-S-42	T740	11/29/17
Spectrum Analyzer, PXA 3Hz to 44GHz	Keysight	N9030A	T340	12/14/2017
Antenna, Horn 1-18GHz	ETS Lindgren	3117	T300	11/10/17
Antenna, Broadband Hybrid, 30MHz to 2000MHz	Sunol Sciences	JB3	T426	9/23/2017
Amplifier, 1 to 18GHz	Miteq	AFS42-00101800-25-S-42	T243	10/11/2017
Amplifier, 10KHz to 1GHz, 32dB	Sonoma	310N	T285	6/20/2017
Spectrum Analyzer, PXA 3Hz to 44GHz	Keysight	N9030A	T1613	9/23/2017
Antenna, Horn 1-18GHz	ETS Lindgren	3117	T120	4/5/2017
* Antenna, Broadband Hybrid, 30MHz to 2000MHz	Sunol Sciences	JB3	T122	1/29/2017
Amplifier, 1 to 18GHz	Miteq	AFS42-00101800-25-S-42	T742	11/29/2017
Amplifier, 10KHz to 1GHz, 32dB	Sonoma	310N	T173	6/17/2017
Spectrum Analyzer, PXA 3Hz to 44GHz	Keysight	N9030A	T341	10/25/2017
Filter, HPF 3.0GHz	MICRO-TRONICS	HPM17543	T898	05/31/2017
Filter, HPF 6.0HPF	MICRO-TRONICS	HPS17542	T893	05/31/2017
Power Meter, P-series single channel	Agilent (Keysight) Technologies	N1911A	T227	10/11/2017
Power Meter, P-series single channel	Agilent (Keysight) Technologies	N1912A	T1244	05/03/2017
Power Meter, RF	Anritsu Corporation	ML2495A	T1413	12/19/2017
Power Sensor	Keysight	N1921A	T1224	03/22/2017
Antenna Horn, 18 to 26GHz	ARA	MWH-1826	T447	6/16/2017
Spectrum Analyzer, 40GHz	Agilent	8564E	T106	9/7/2017
AC Line Conducted				
* EMI Test Receiver 9Khz-7GHz	Rohde & Schwarz	ESC17	T1436	12/19/2016
LISN for Conducted Emissions CISPR-16	Fischer	50/250-25-2-01	T1310	06/08/2017
Power Cable, Line Conducted Emissions	UL	PG1	T861	9/1/2017
UL AUTOMATION SOFTWARE				
Radiated Software	UL	UL EMC	Ver 9.5, April 26, 2016	
Conducted Software	UL	UL EMC	Ver 5.4, October 13, 2016	
AC Line Conducted Software	UL	UL EMC	Ver 9.5, May 26, 2015	

NOTE: *testing is completed before equipment calibration expiration date.

7. MEASUREMENT METHODS

6 dB BW: KDB 558074 D01 v03r05, Section 8.1.

Output Power: KDB 558074 D01 v03r05, Section 9.1.2.

Power Spectral Density: KDB 558074 D01 v03r05, Section 10.2.

Out-of-band emissions in non-restricted bands: KDB 558074 D01 v03r05, Section 11.0.

Out-of-band emissions in restricted bands: KDB 558074 D01 v03r05, Section 12.1.

Band-edge: KDB 558074 D01 v03r05, Section 12.1.

8. ANTENNA PORT TEST RESULTS

ON TIME AND DUTY CYCLE

LIMITS

None; for reporting purposes only.

PROCEDURE

KDB 558074 Zero-Span Spectrum Analyzer Method.

ON TIME AND DUTY CYCLE RESULTS

Mode	ON Time B (msec)	Period (msec)	Duty Cycle x (linear)	Duty Cycle (%)	Duty Cycle Correction Factor (dB)	1/B Minimum VBW (khz)
11b 2.4GHz 1TX	1	1	1	100%	0	0.01
11n HT20 2.4GHz 1TX	1.920	1.945	0.987	98.7%	0	0.01
11n HT20 2.4GHz CDD	1.920	1.945	0.987	98.7%	0	0.01

DUTY CYCLE PLOTS

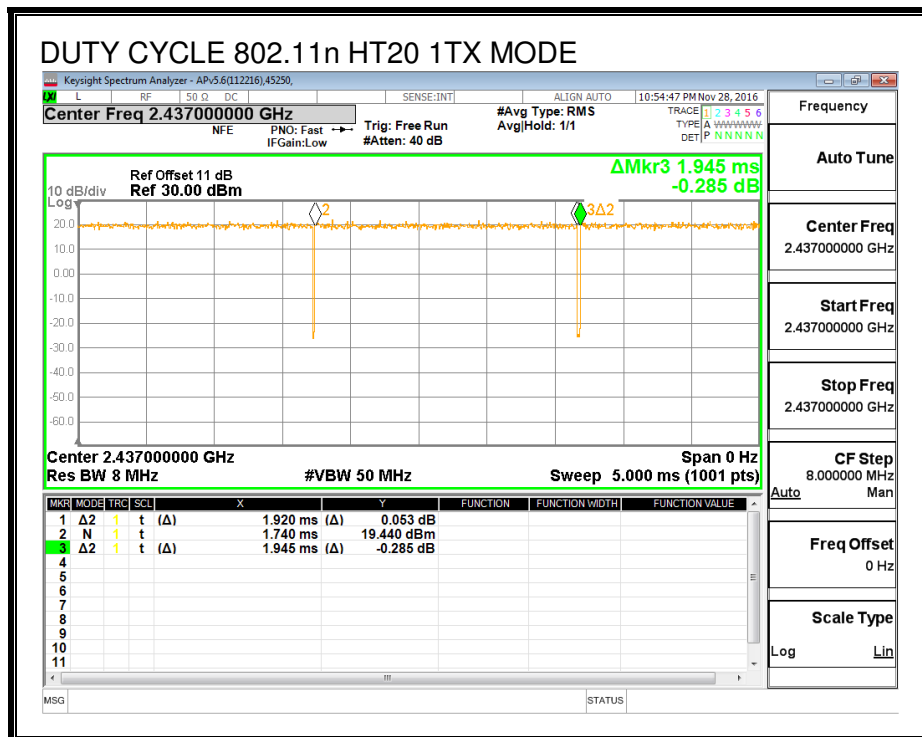
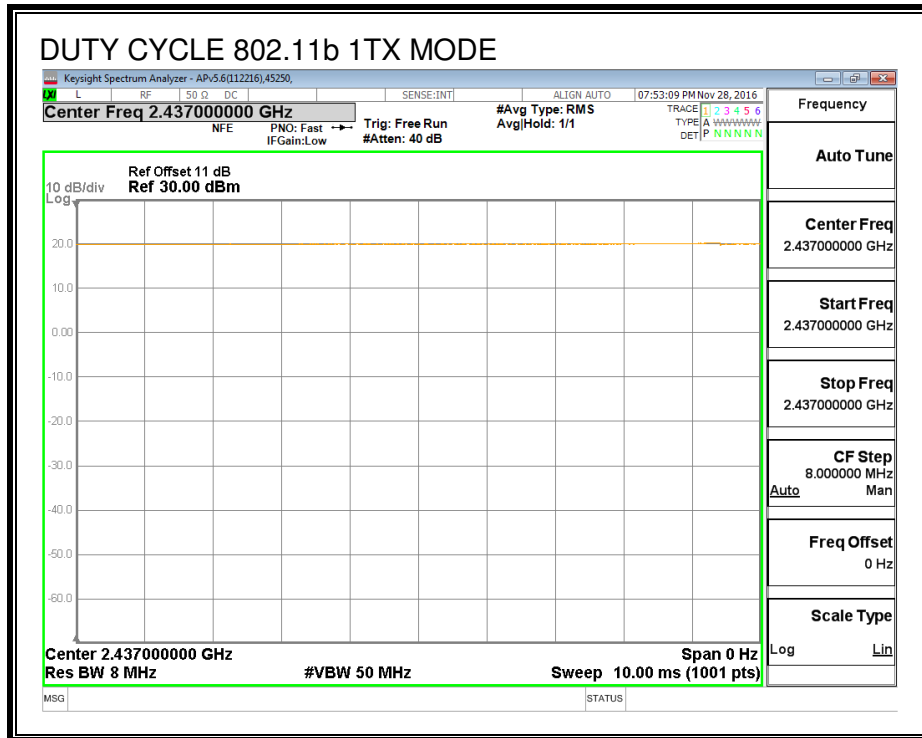

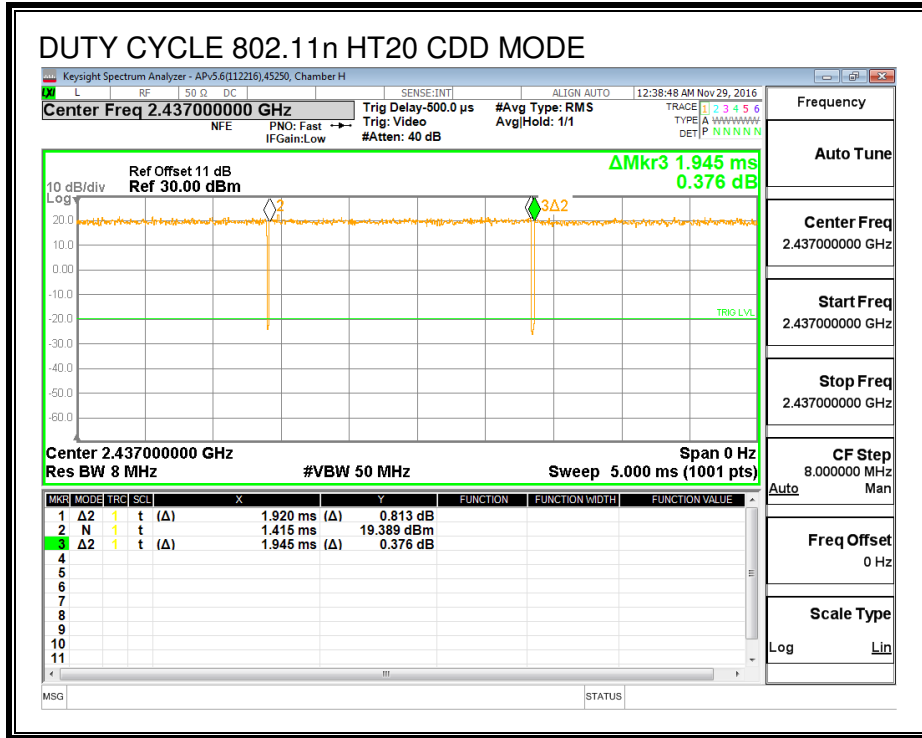

8.1. 11b ANTENNA A SISO MODE IN THE 2.4GHz BAND

8.1.1. 6 dB BANDWIDTH

LIMITS

FCC §15.247 (a) (2)

IC RSS-247 (5.2) (1)

The minimum 6 dB bandwidth shall be at least 500 kHz.

RESULTS

Channel	Frequency	6 dB BW Ant A (MHz)	Minimum Limit (MHz)
Low_1	2412	7.585	0.5
Middle_6	2437	8.060	0.5
High_11	2462	7.965	0.5
High_12	2467	7.595	0.5
High_13	2472	8.550	0.5

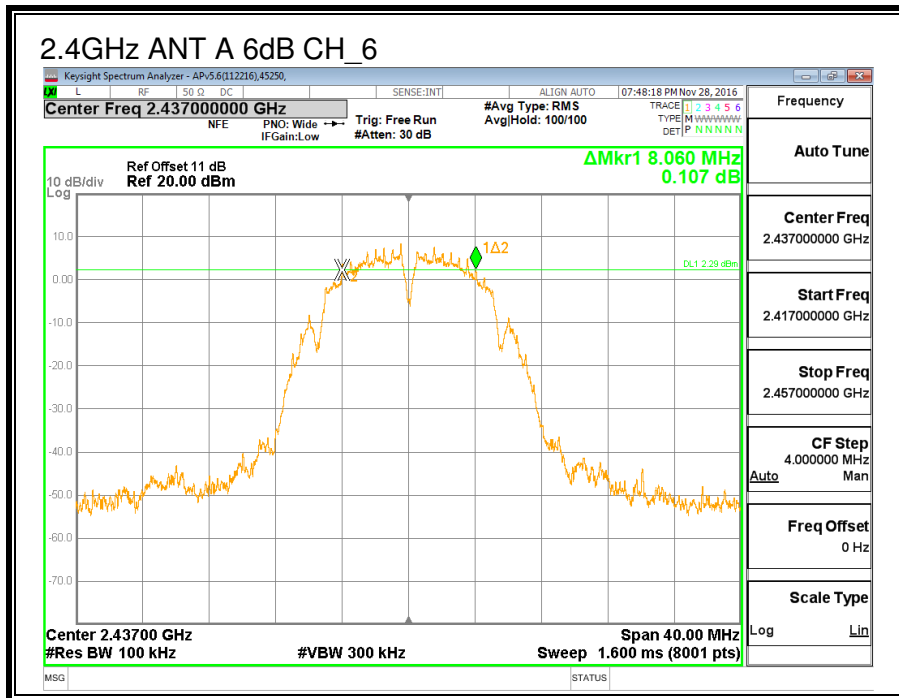
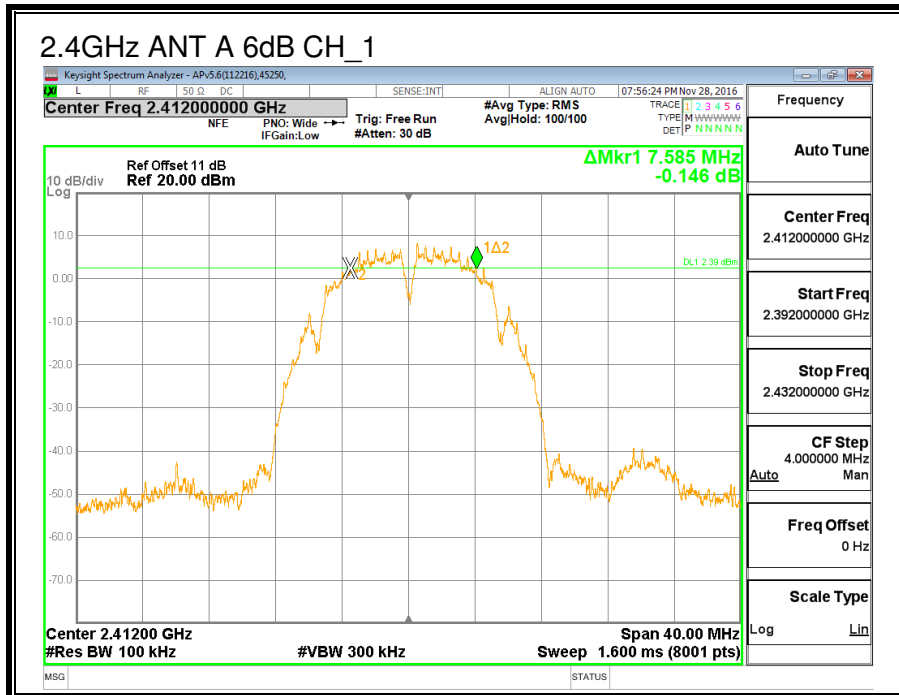

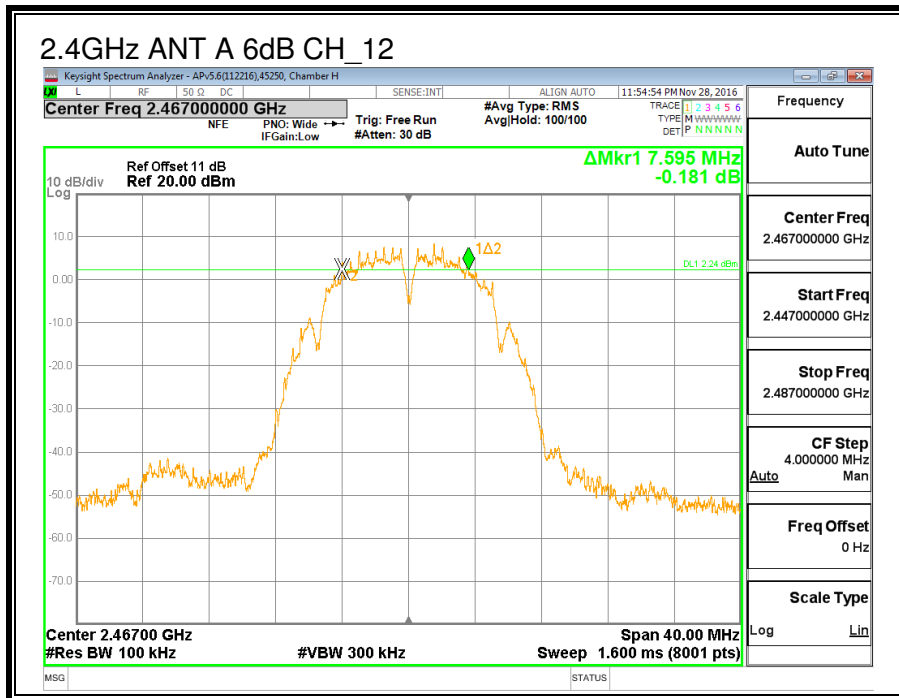
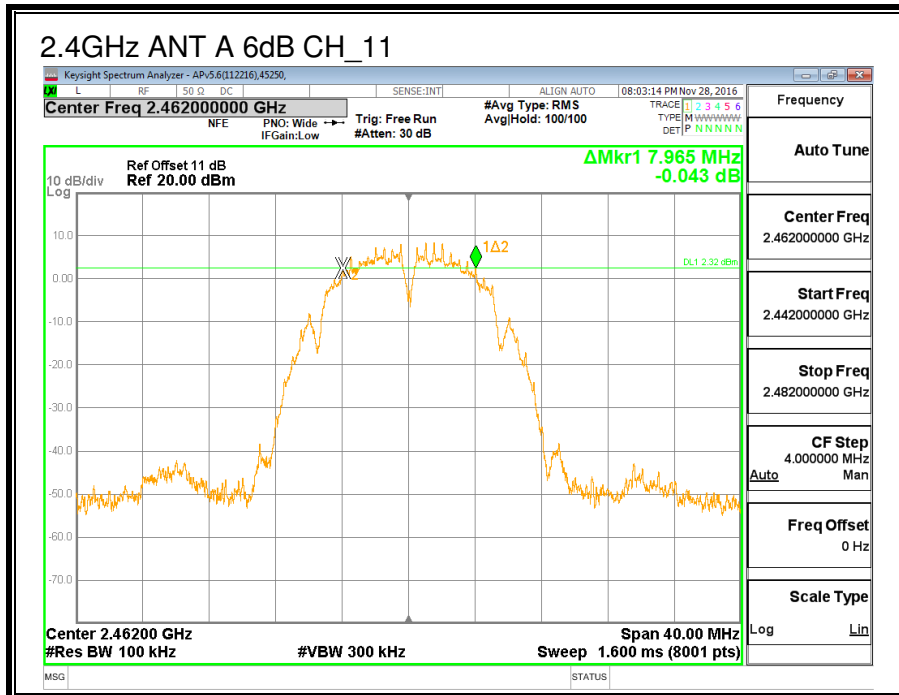

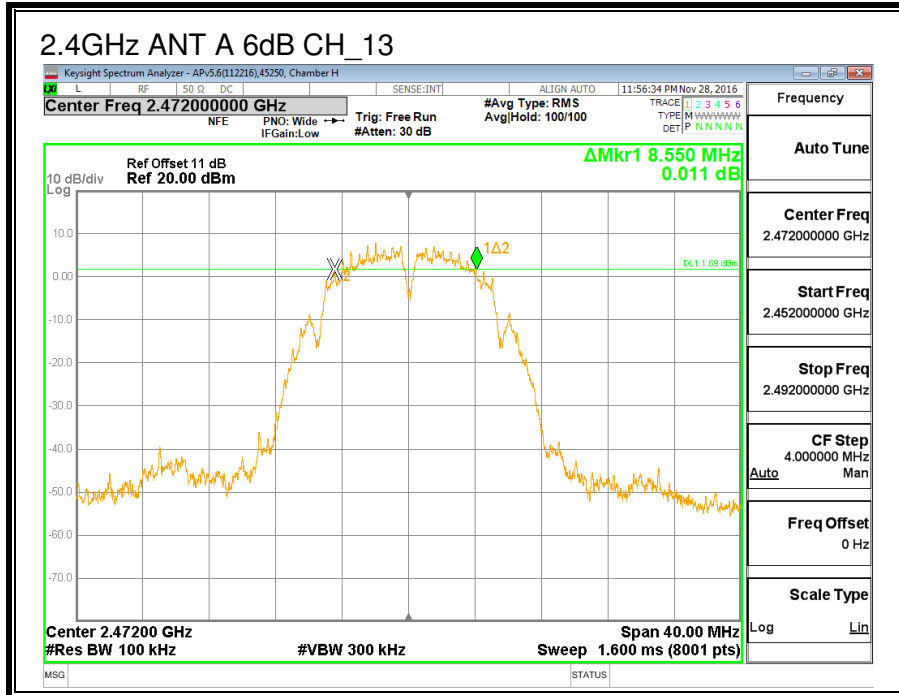

8.1.2. 99% BANDWIDTH

LIMITS

None; for reporting purposes only.

RESULTS

Channel	Frequency (MHz)	99% Bandwidth Ant A (MHz)
Low_1	2412	10.262
Middle_6	2437	10.293
High_11	2462	10.277
High_12	2467	10.101
High_13	2472	10.448

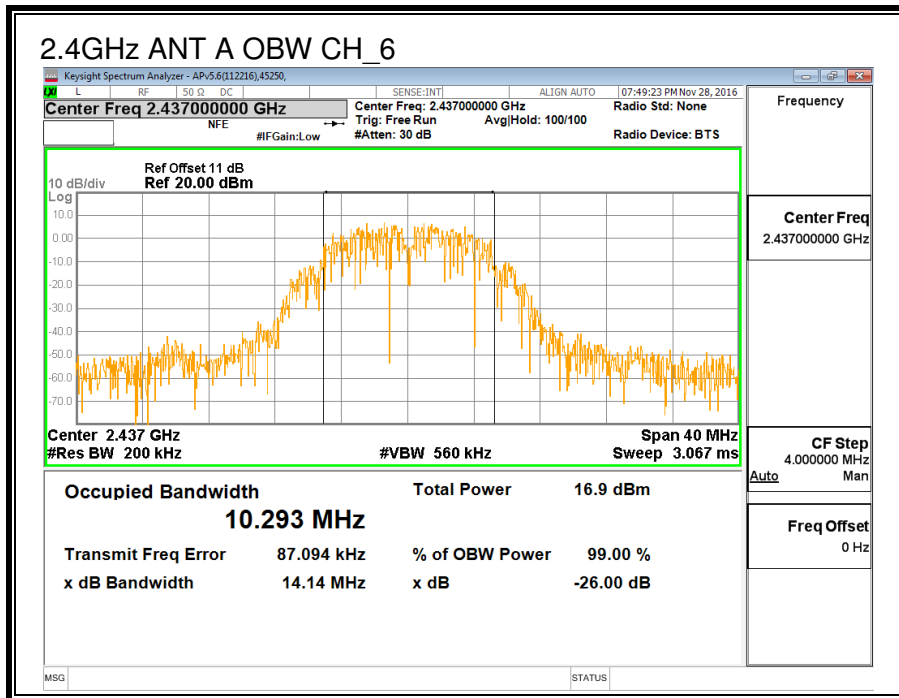
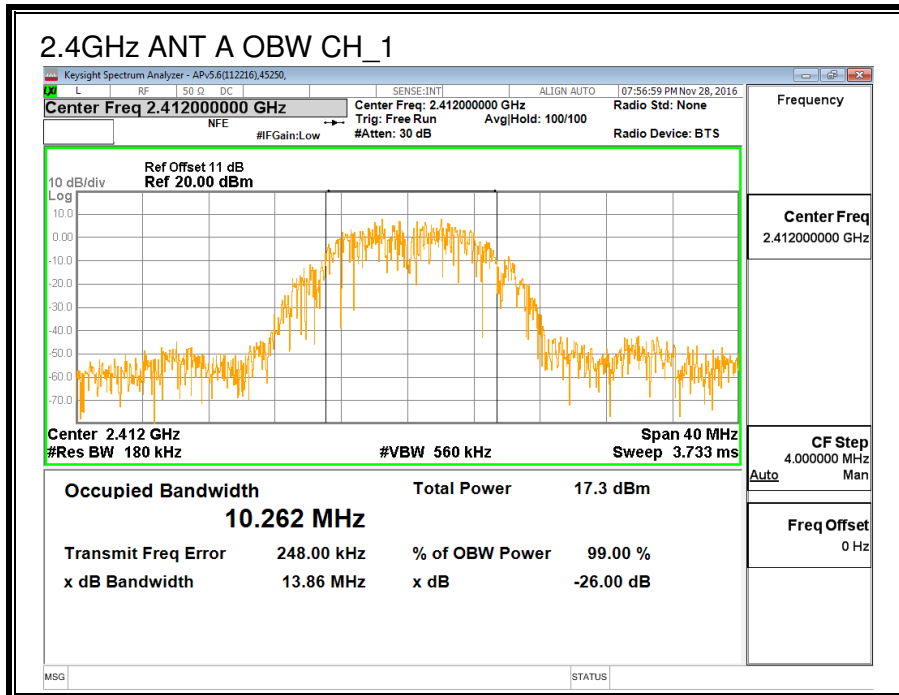

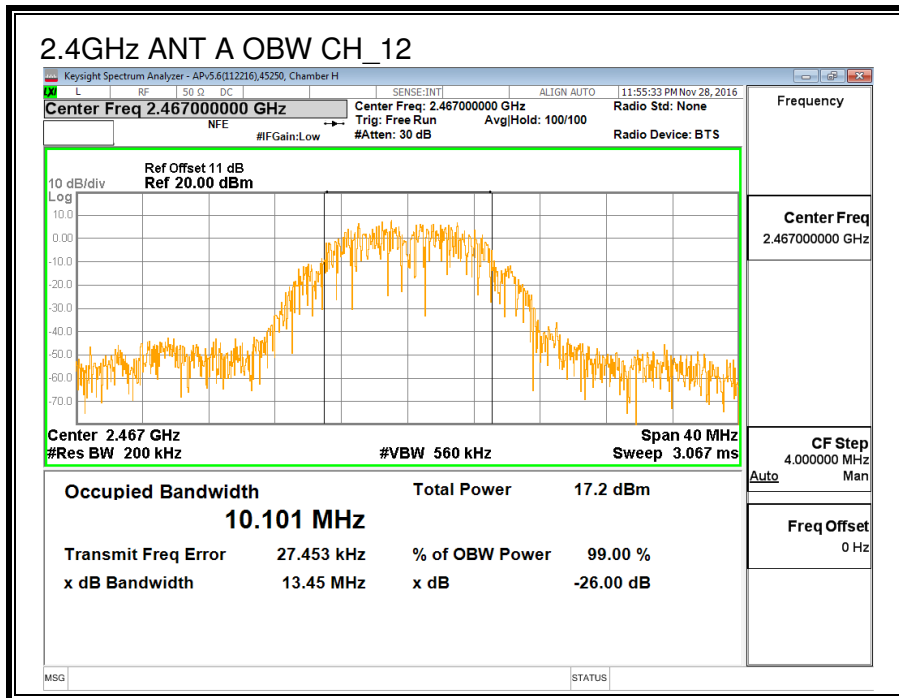
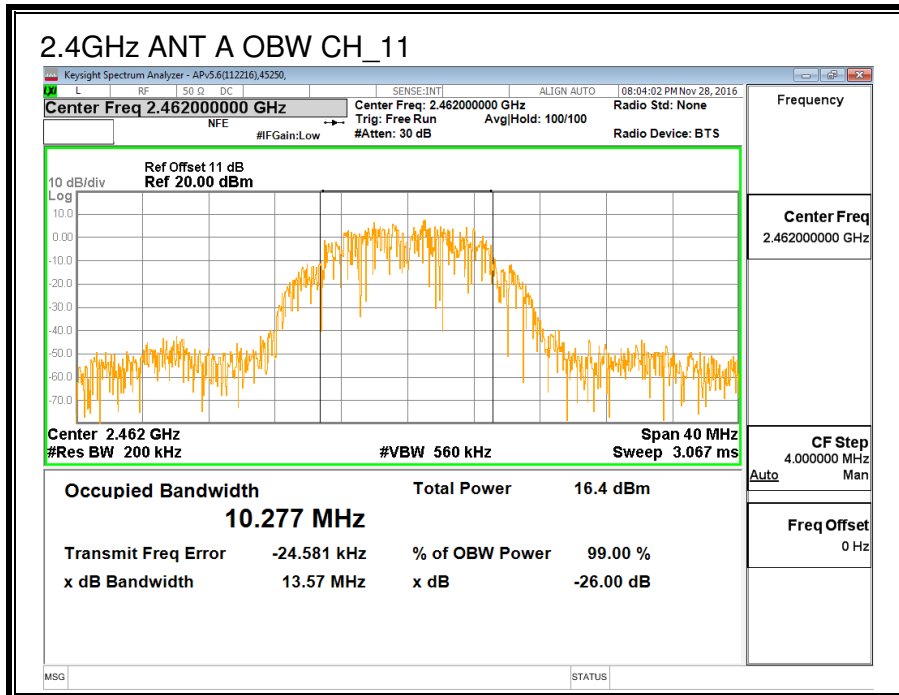

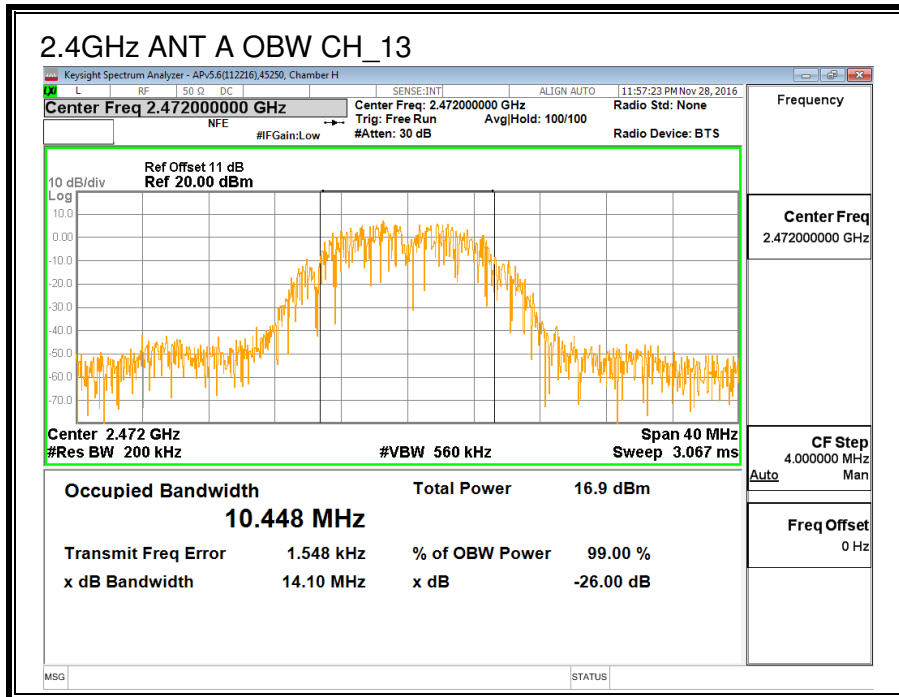

8.1.3. AVERAGE POWER

ID:	38602	Date:	2-2-2017
------------	-------	--------------	----------

LIMITS

None; for reporting purposes only.

RESULTS

Channel	Frequency (MHz)	Power Ant A(MHz)
Low_1	2412	15.81
Middle_6	2437	15.92
High_11	2462	15.97
High_12	2467	15.75
High_13	2472	14.48

8.1.4. OUTPUT POWER

ID:	38602	Date:	2-2-2017
------------	-------	--------------	----------

LIMITS

FCC §15.247

IC RSS-247 (5.4) (4)

For systems using digital modulation in the 2400–2483.5 MHz, and 5725–5850 MHz bands: 1 Watt, based on the use of antennas with directional gains that do not exceed 6 dBi. If transmitting antennas of directional gain greater than 6 dBi are used, the conducted output power from the intentional radiator shall be reduced by the amount in dB that the directional gain of the antenna exceeds 6 dBi.

DIRECTIONAL ANTENNA GAIN

There is only one transmitter output therefore the directional gain is equal to the antenna gain.

RESULTS

Limits

Channel	Frequency (MHz)	Directional Gain (dBi)	FCC Power Limit (dBm)	IC Power Limit (dBm)	IC EIRP Limit (dBm)	Max Power (dBm)
Low	2412	-0.48	30.00	30	36	30.00
Mid	2437	-0.48	30.00	30	36	30.00
High_11	2462	-0.48	30.00	30	36	30.00
High_12	2467	-0.48	30.00	30	36	30.00
High_13	2472	-0.48	30.00	30	36	30.00

Duty Cycle CF (dB)	0.00	Included in Calculations of Corr'd Power
---------------------------	------	---

Results

Channel	Frequency (MHz)	Meas Power (dBm)	Total Corr'd Power (dBm)	Power Limit (dBm)	Margin (dB)
Low	2412	19.88	19.88	30.00	-10.12
Mid	2437	19.94	19.94	30.00	-10.06
High_11	2462	19.91	19.91	30.00	-10.09
High_12	2467	19.85	19.85	30.00	-10.15
High_13	2472	17.55	17.55	30.00	-12.45

8.1.5. POWER SPECTRAL DENSITY

LIMITS

FCC §15.247

IC RSS-247 (5.2) (2)

For digitally modulated systems, the power spectral density conducted from the intentional radiator to the antenna shall not be greater than 8 dBm in any 3 KHz band during any time interval of continuous transmissions.

RESULTS

Duty Cycle CF (dB)	0.00	Included in Calculations of Corr'd PSD
---------------------------	------	---

PSD Results

Channel	Frequency (MHz)	Meas (dBm)	Total Corr'd PSD (dBm)	Limit (dBm)	Margin (dB)
Low	2412	-6.932	-6.93	8.0	-14.9
Mid	2437	-4.480	-4.48	8.0	-12.5
High_11	2462	-6.084	-6.08	8.0	-14.1
High_12	2467	-7.731	-7.73	8.0	-15.7
High_13	2472	-4.388	-4.39	8.0	-12.4

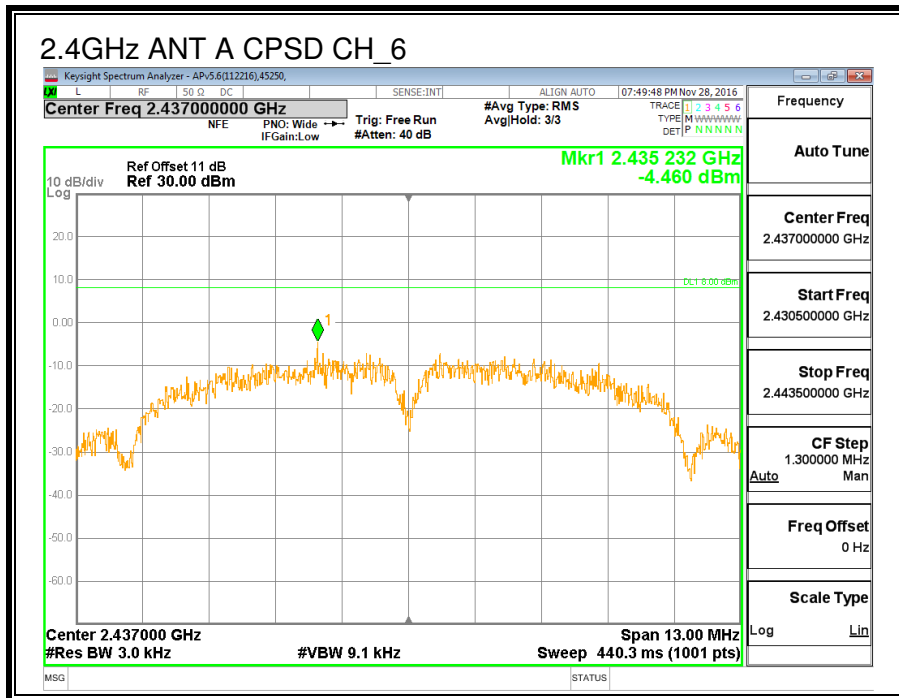
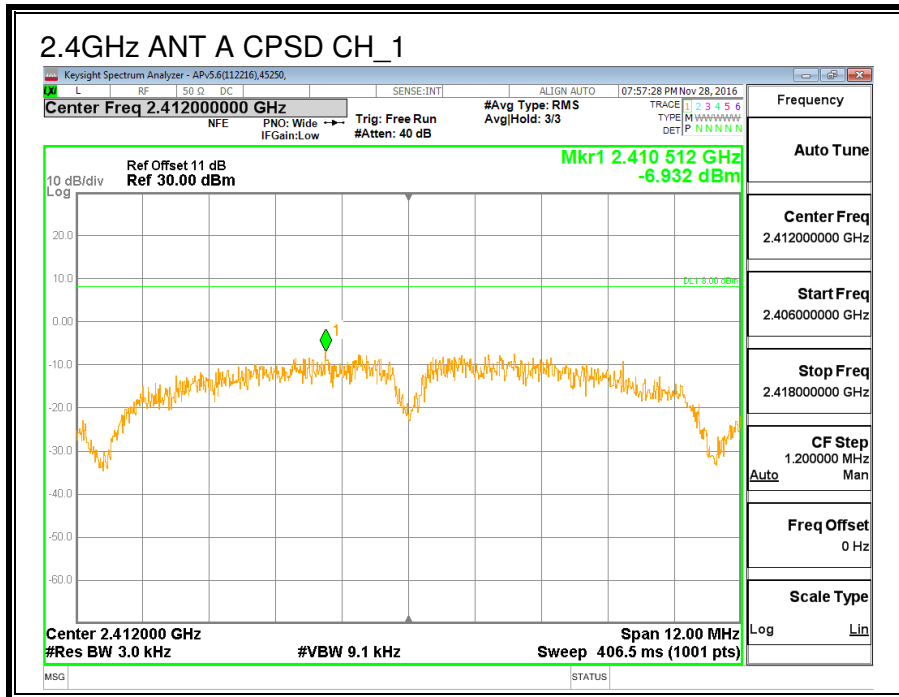

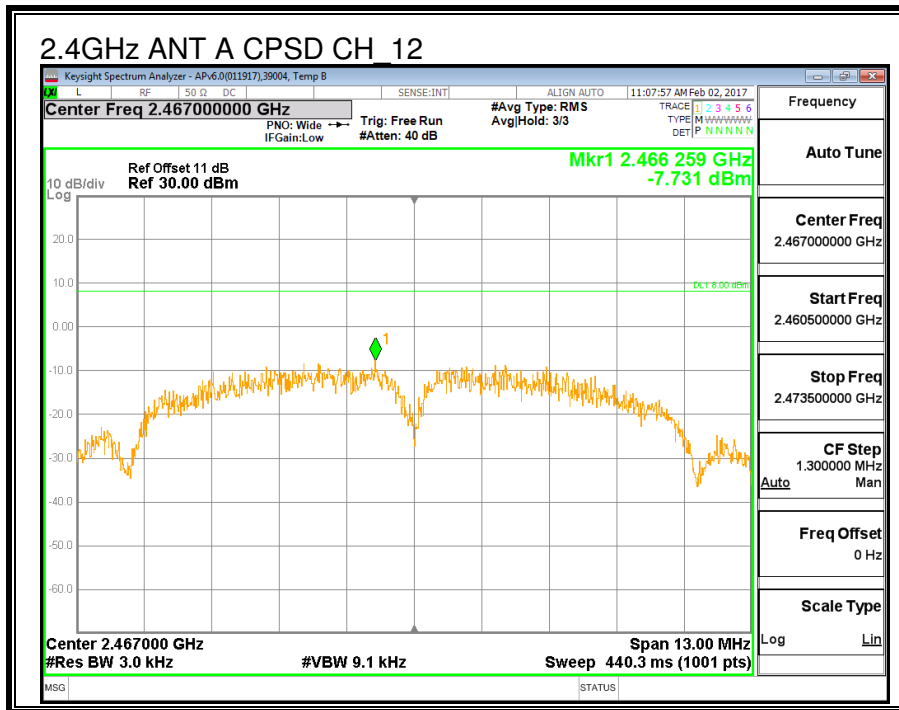
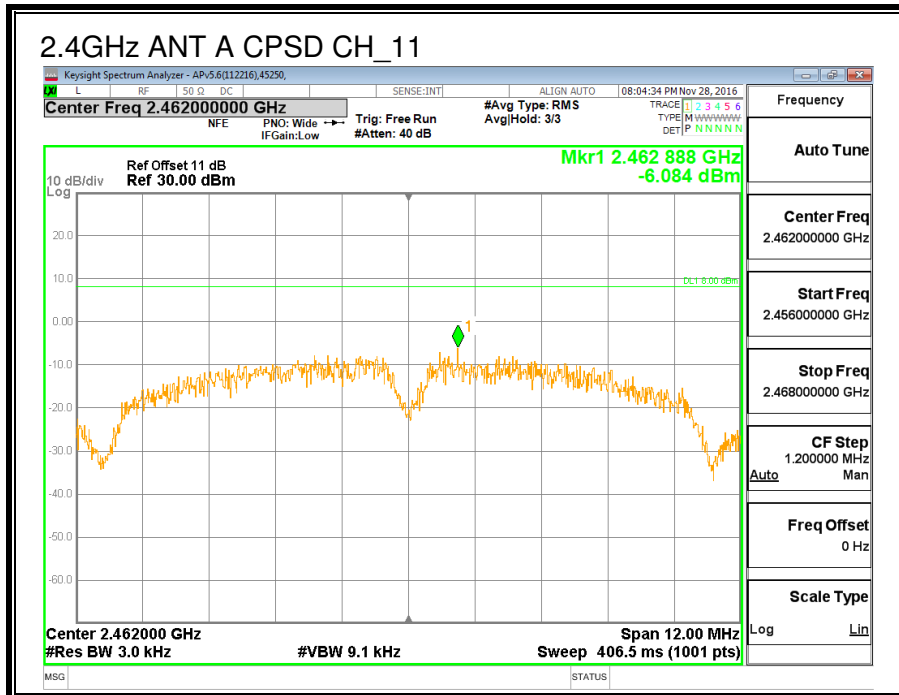

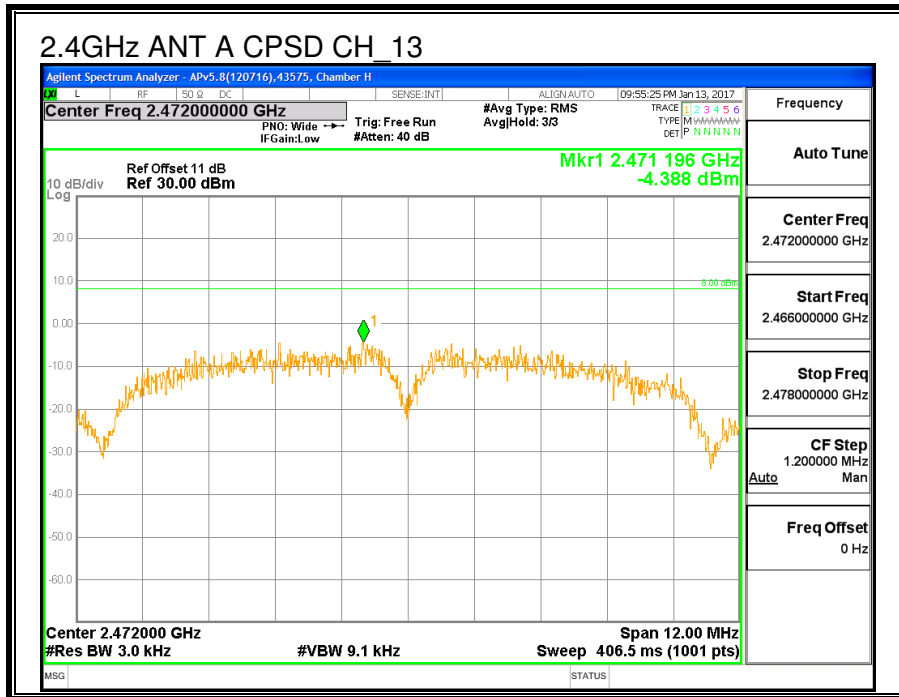

8.1.6. CONDUCTED BANDEDGE AND SPURIOUS EMISSIONS

LIMITS

FCC §15.247 (d)

IC RSS-247 (5.5)

In any 100 kHz bandwidth outside the frequency band in which the spread spectrum or digitally modulated intentional radiator is operating, the radio frequency power that is produced by the intentional radiator shall be at least 20 dB below that in the 100 kHz bandwidth within the band that contains the highest level of the desired power, based on either an RF conducted or a radiated measurement, provided the transmitter demonstrates compliance with the peak conducted power limits. If the transmitter complies with the conducted power limits based on the use of RMS averaging over a time interval, as permitted under paragraph (b)(3) of this section, the attenuation required under this paragraph shall be 30 dB instead of 20 dB. Attenuation below the general limits specified in §15.209(a) is not required.

RESULTS

LOW CHANNEL BANDEDGE

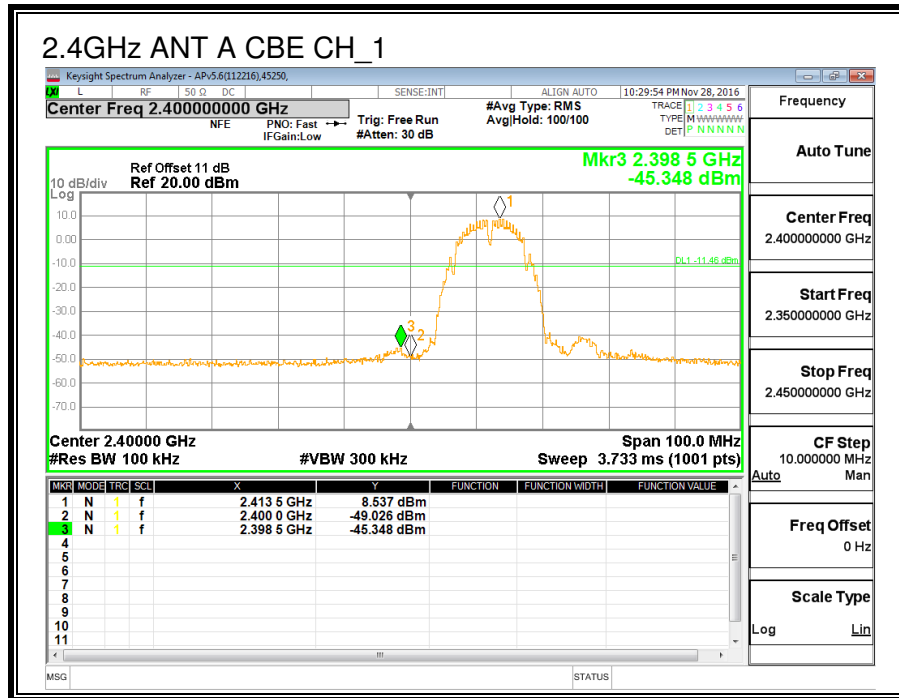

MID CHANNEL REFERENCE

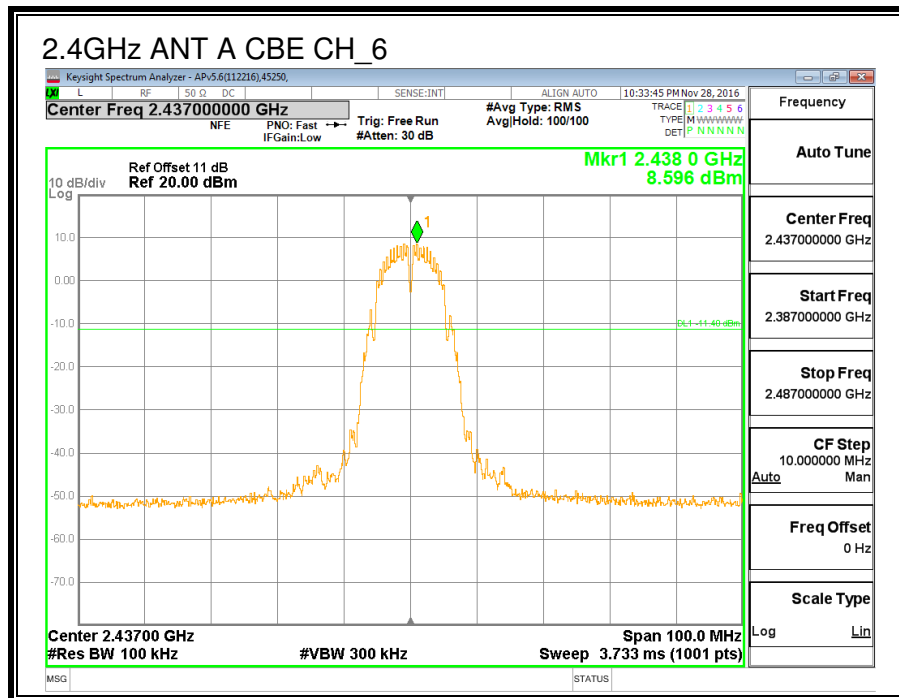

HIGH CHANNEL BANDEDGE

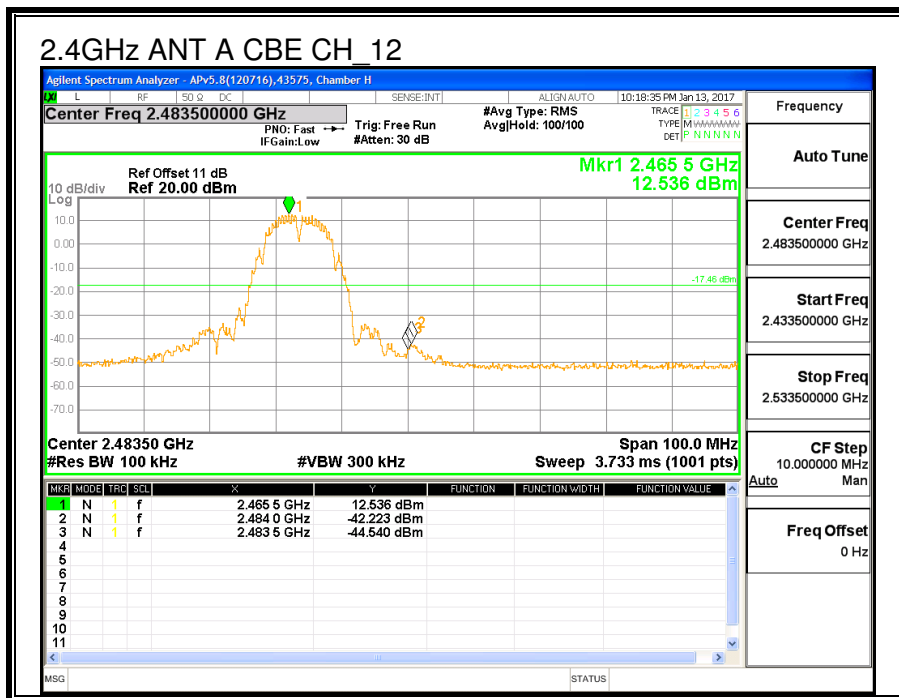
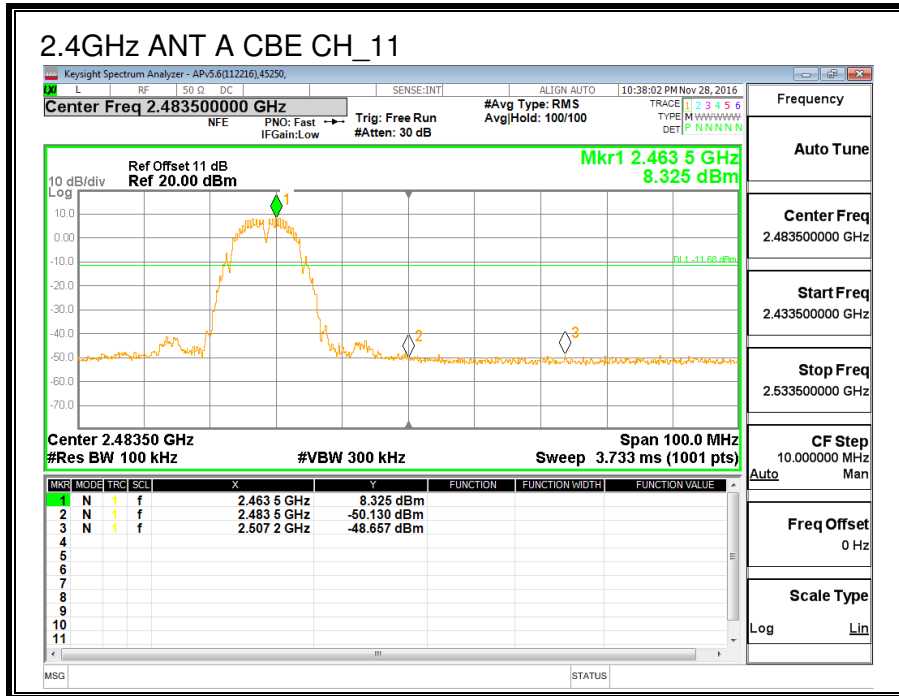

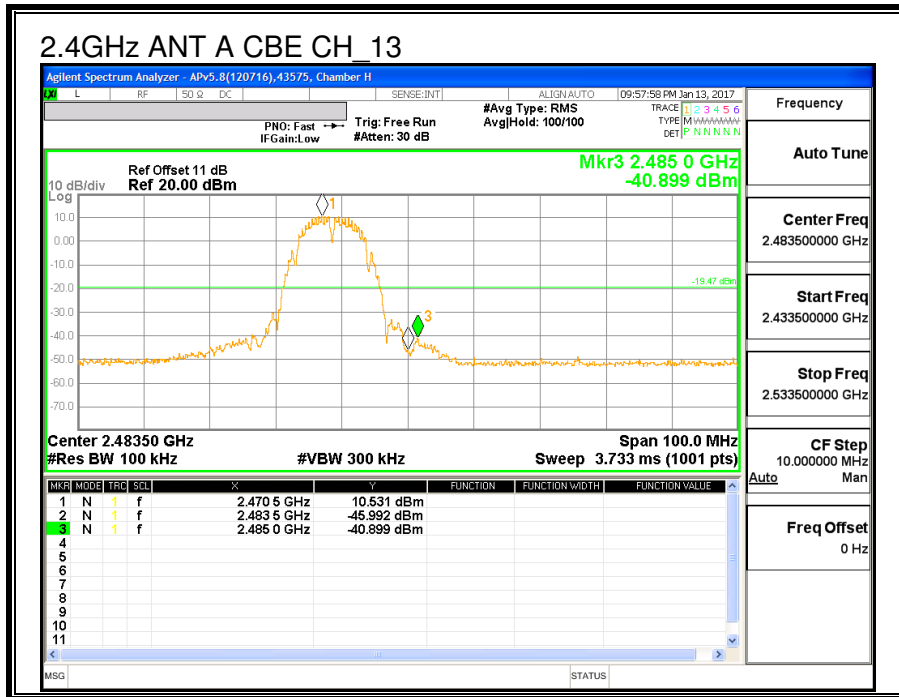

OUT-OF-BAND EMISSIONS

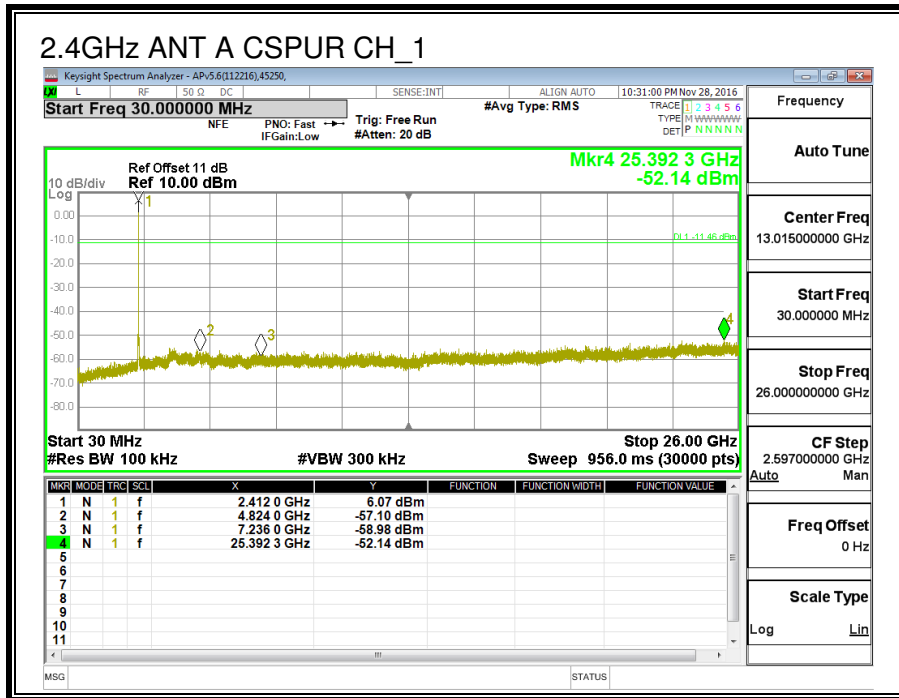

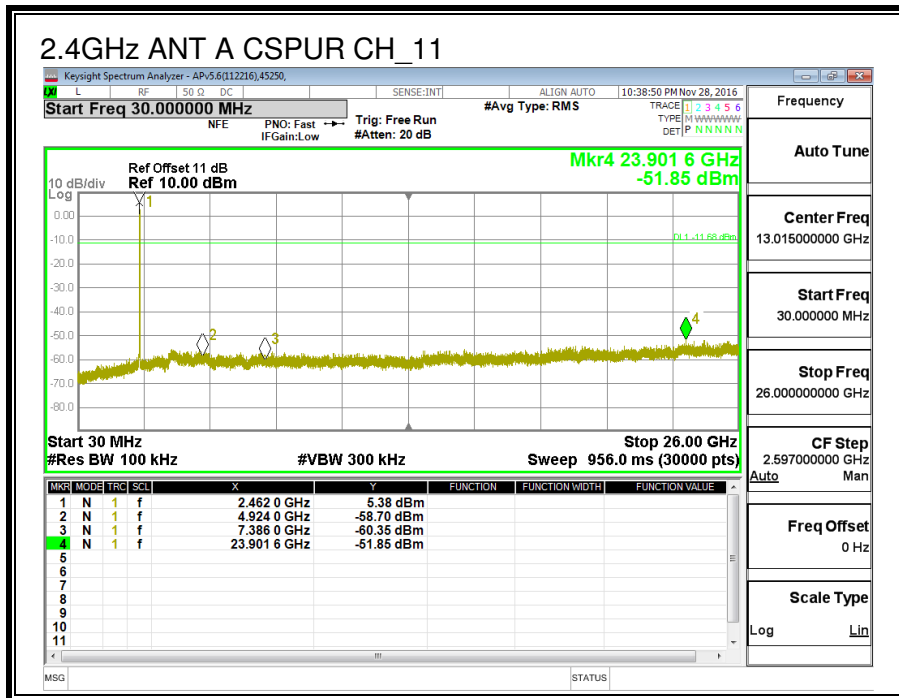
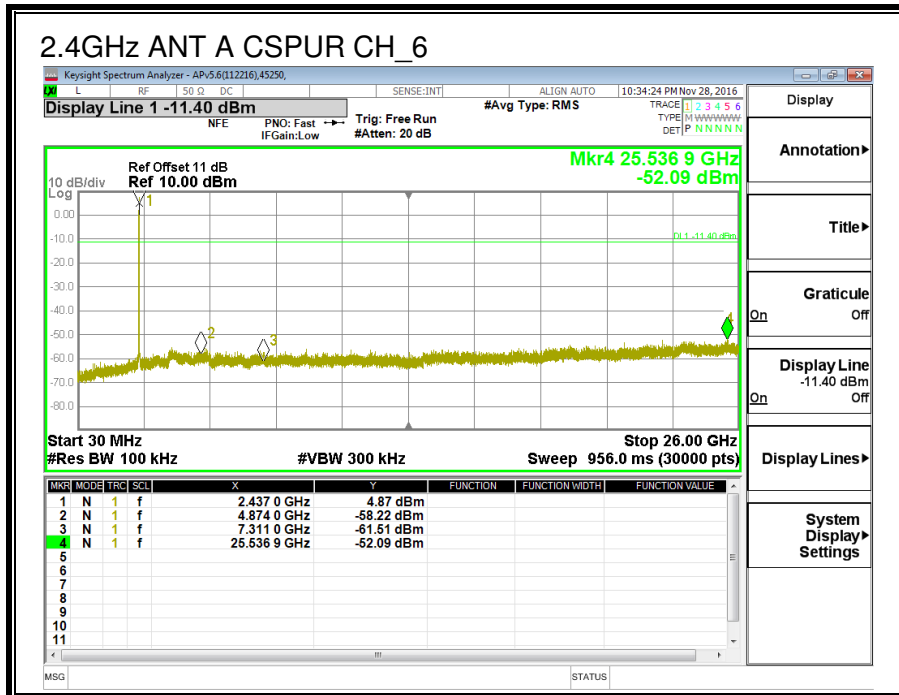

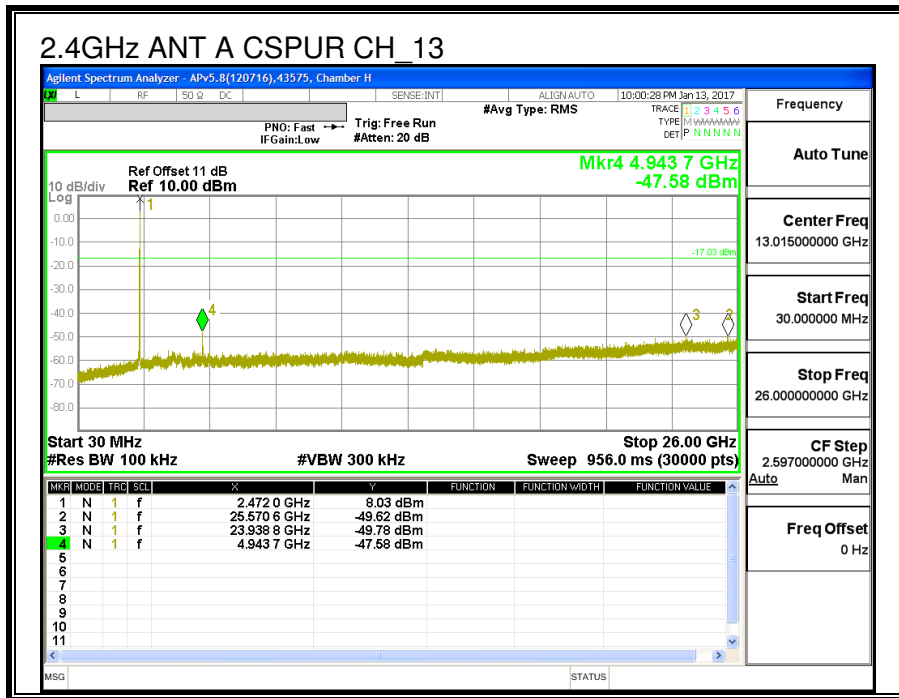
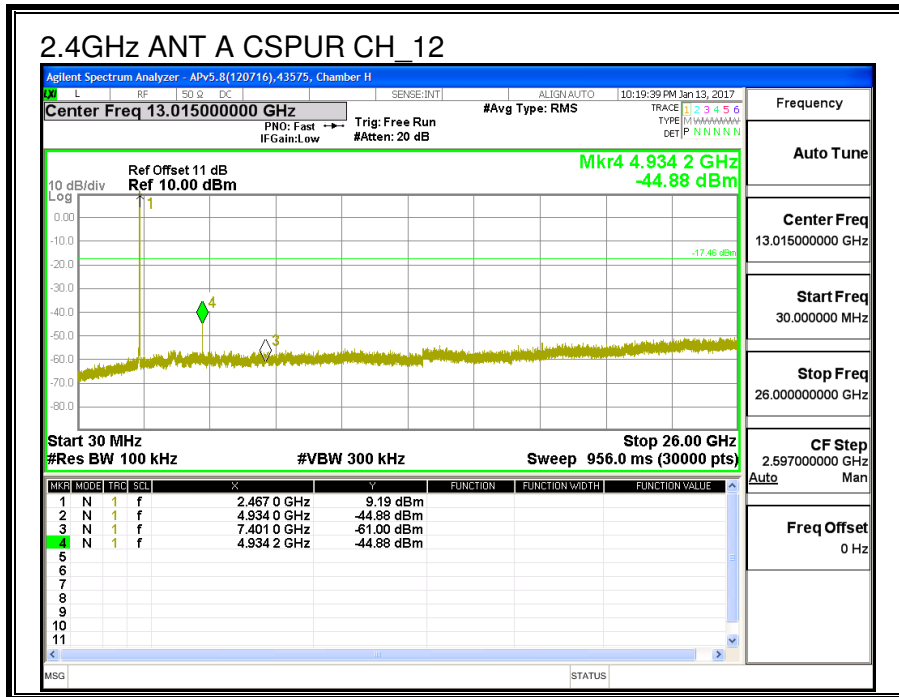

8.2. 11b ANTENNA B SISO MODE IN THE 2.4GHz BAND

8.2.1. 6 dB BANDWIDTH

LIMITS

FCC §15.247 (a) (2)

IC RSS-247 (5.2) (1)

The minimum 6 dB bandwidth shall be at least 500 kHz.

RESULTS

Channel	Frequency	6 dB BW ANT B (MHz)	Minimum Limit (MHz)
Low_1	2412	8.500	0.5
Middle_6	2437	7.900	0.5
High_11	2462	8.085	0.5
High_12	2467	8.570	0.5
High_13	2472	8.080	0.5

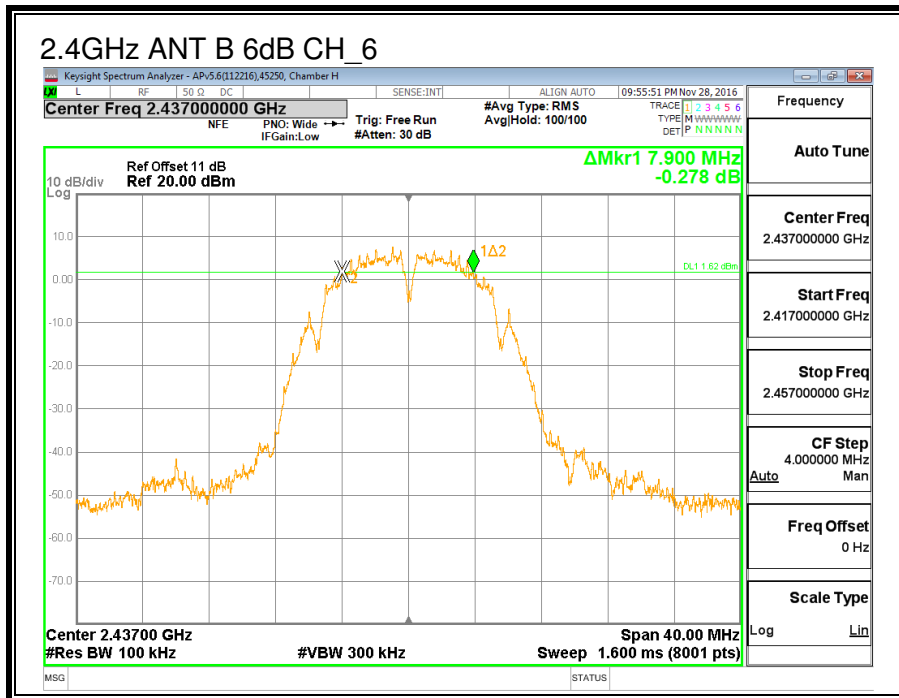
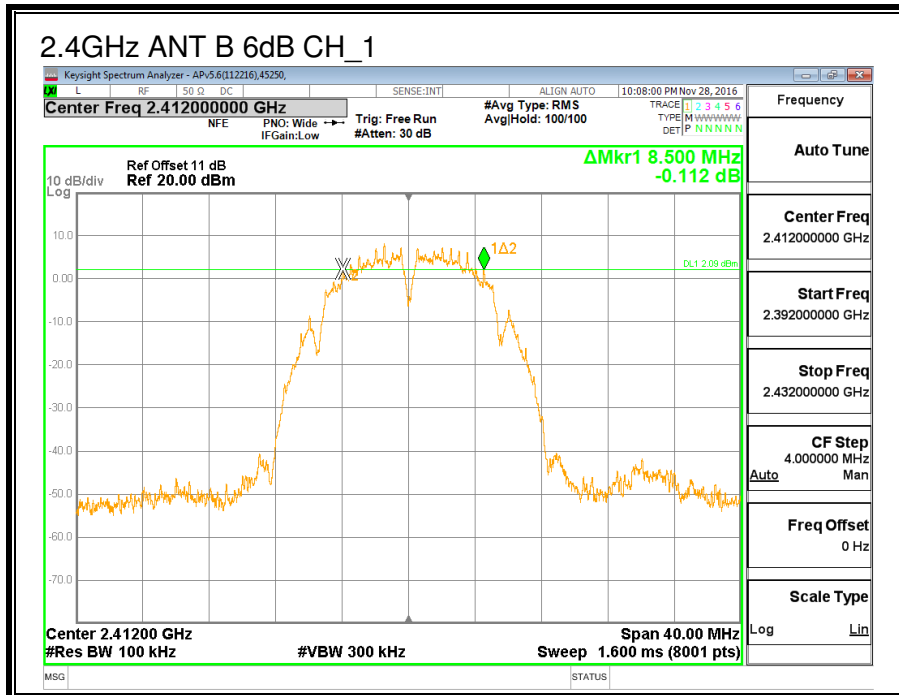

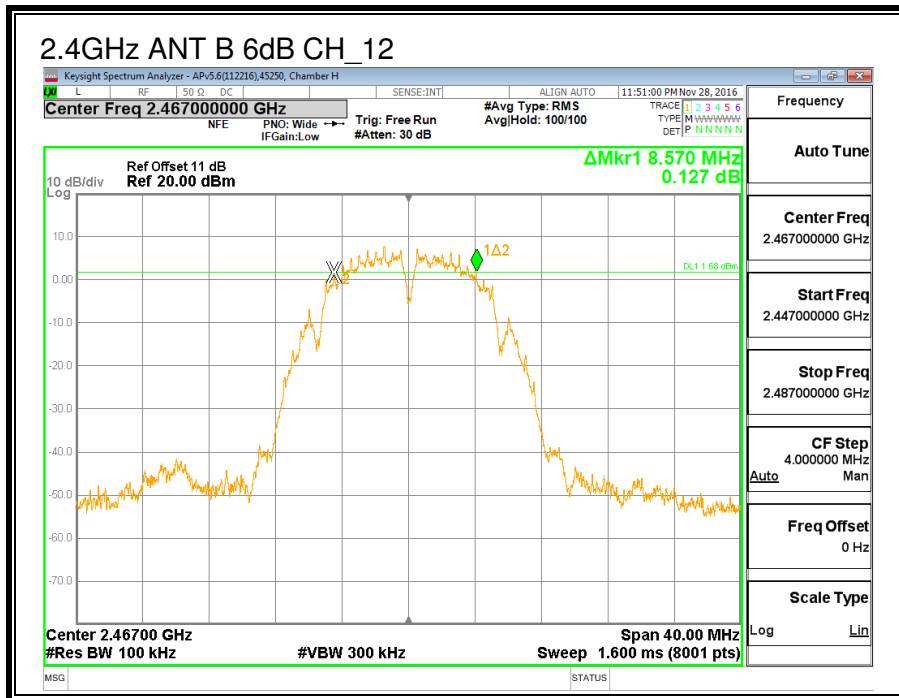
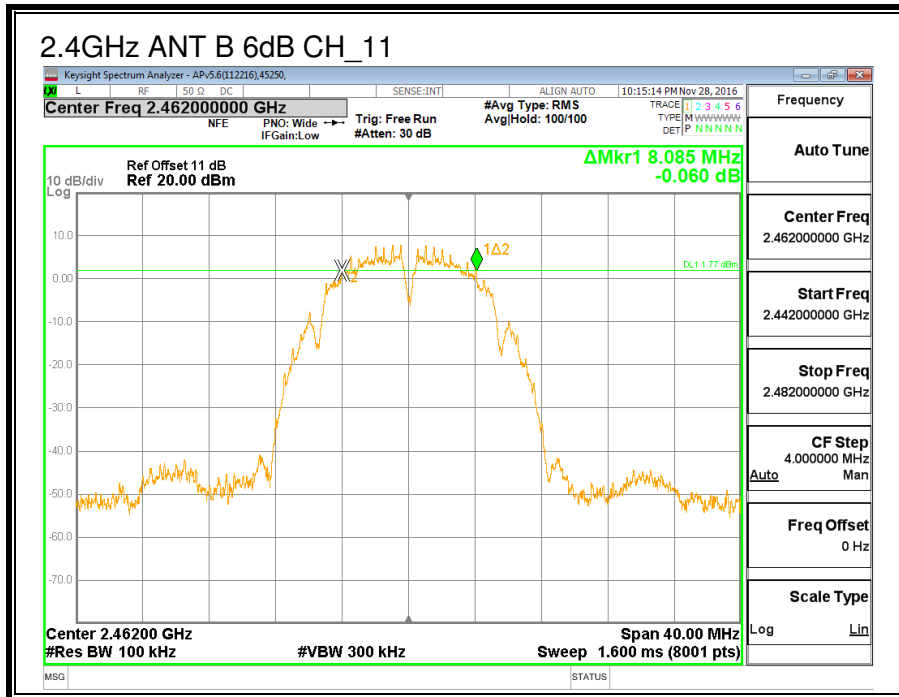

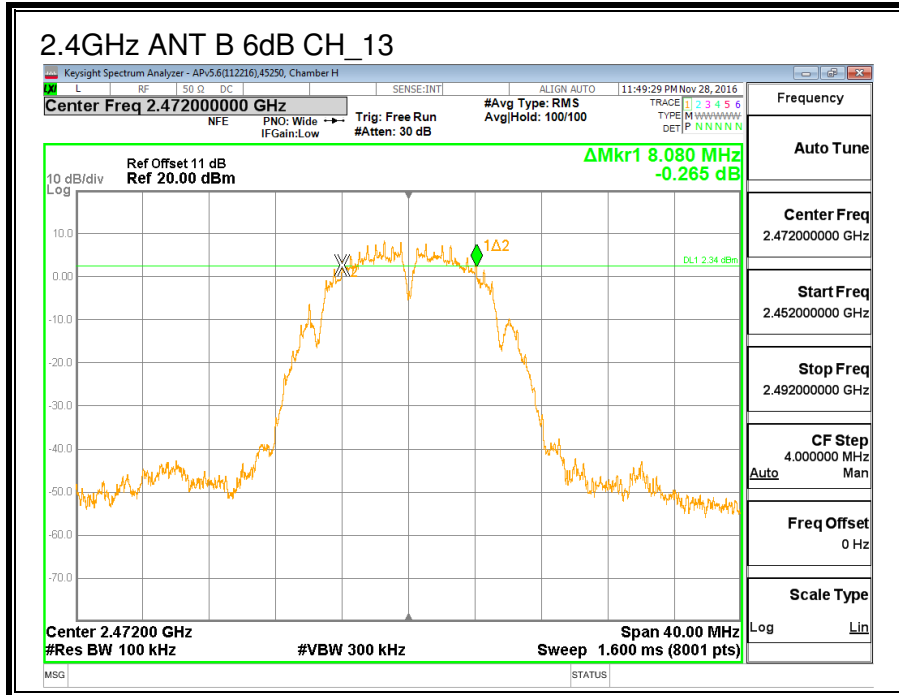

8.2.2. 99% BANDWIDTH

LIMITS

None; for reporting purposes only.

RESULTS

Channel	Frequency (MHz)	99% Bandwidth ANT B (MHz)
Low_1	2412	10.297
Middle_6	2437	10.324
High_11	2462	10.482
High_12	2467	10.426
High_13	2472	10.378

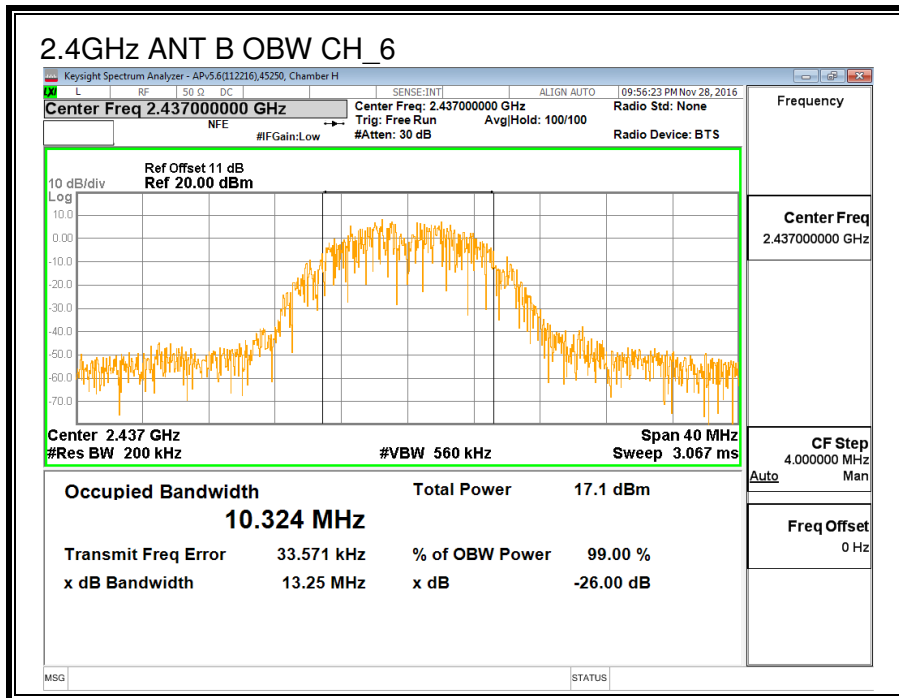
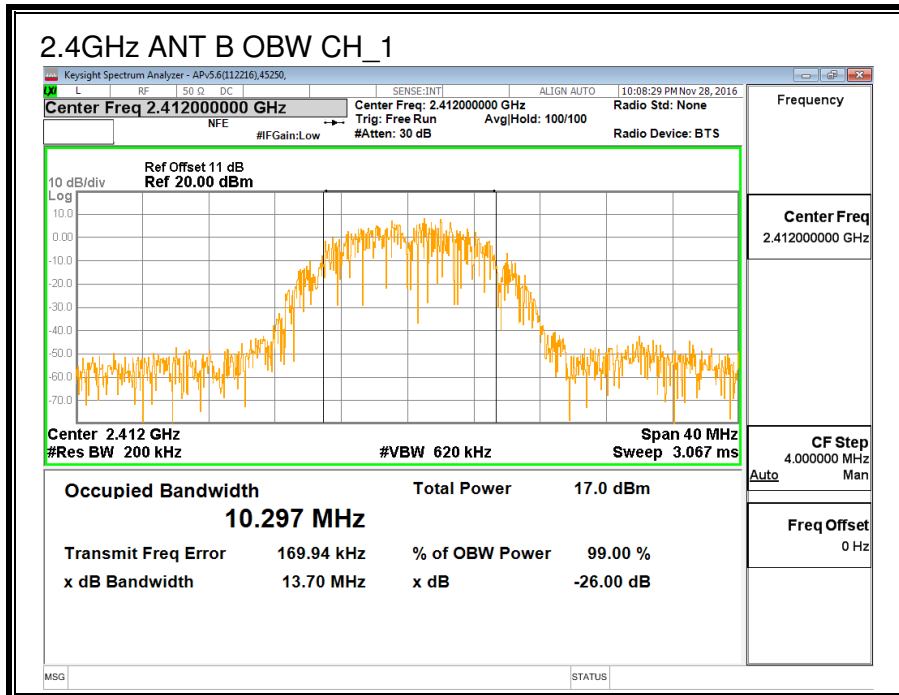

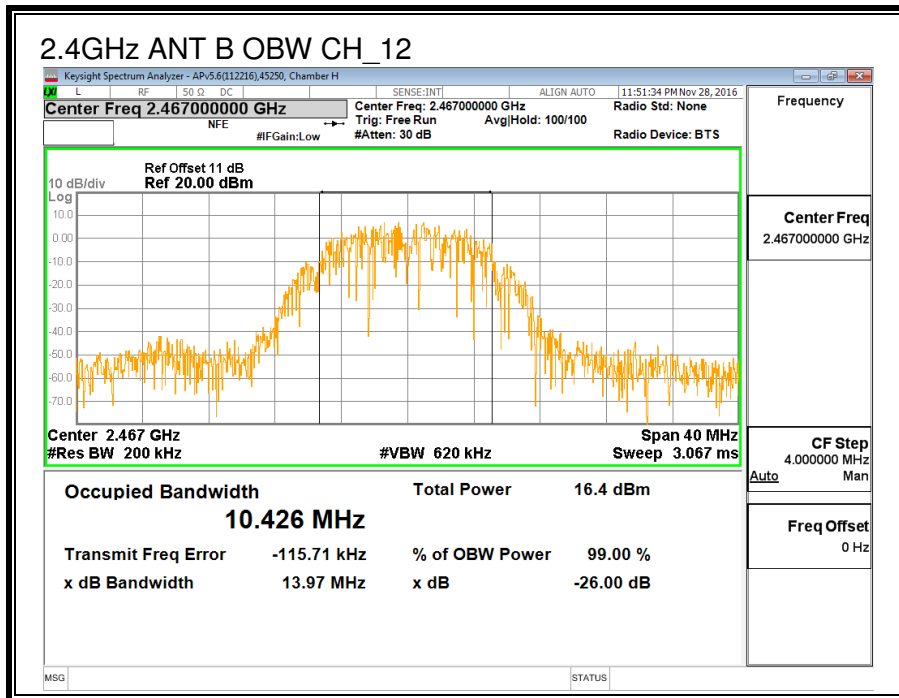
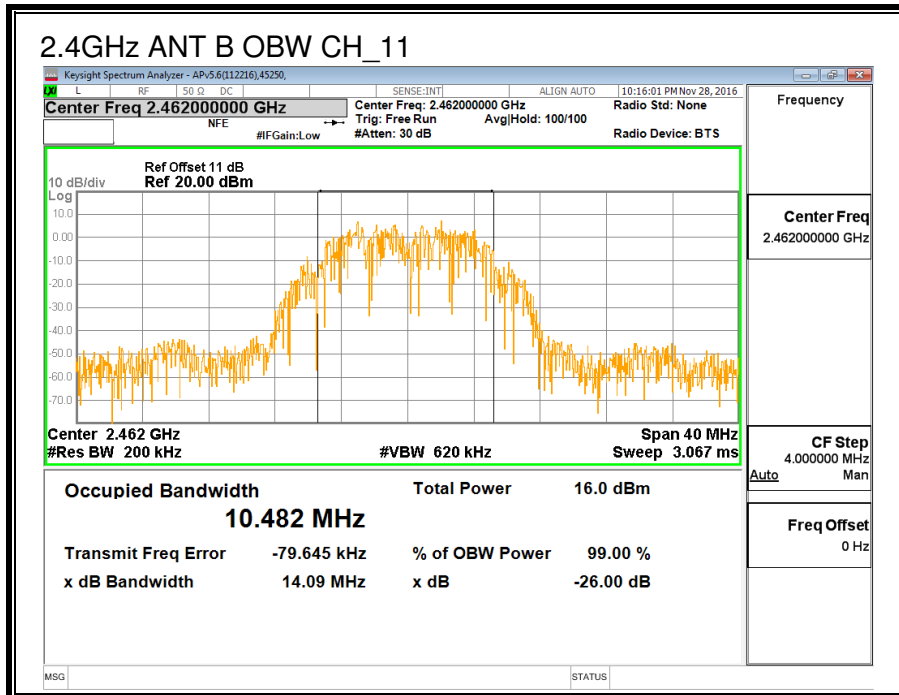

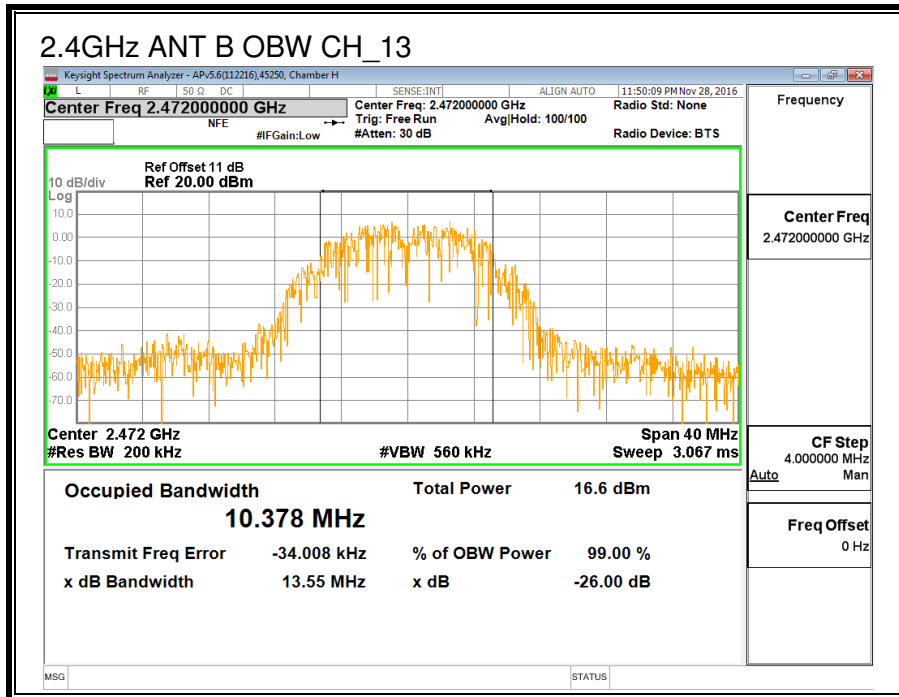

8.2.3. AVERAGE POWER

ID:	38602	Date:	2-2-2017
------------	-------	--------------	----------

LIMITS

None; for reporting purposes only.

RESULTS

Channel	Frequency (MHz)	Power ANT B (MHz)
Low_1	2412	15.93
Middle_6	2437	15.93
High_11	2462	15.85
High_12	2467	15.96
High_13	2472	14.32

8.2.4. OUTPUT POWER

ID:	38602	Date:	2-2-2017
------------	-------	--------------	----------

LIMITS

FCC §15.247

IC RSS-247 (5.4) (4)

For systems using digital modulation in the 2400–2483.5 MHz, and 5725–5850 MHz bands: 1 Watt, based on the use of antennas with directional gains that do not exceed 6 dBi. If transmitting antennas of directional gain greater than 6 dBi are used, the conducted output power from the intentional radiator shall be reduced by the amount in dB that the directional gain of the antenna exceeds 6 dBi.

DIRECTIONAL ANTENNA GAIN

There is only one transmitter output therefore the directional gain is equal to the antenna gain.

RESULTS

Limits

Channel	Frequency (MHz)	Directional Gain (dBi)	FCC Power Limit (dBm)	IC Power Limit (dBm)	IC EIRP Limit (dBm)	Max Power (dBm)
Low	2412	-0.99	30.00	30	36	30.00
Mid	2437	-0.99	30.00	30	36	30.00
High_11	2462	-0.99	30.00	30	36	30.00
High_12	2467	-0.99	30.00	30	36	30.00
High_13	2472	-0.99	30.00	30	36	30.00

Duty Cycle CF (dB)	0.00	Included in Calculations of Corr'd Power
---------------------------	------	---

Results

Channel	Frequency (MHz)	Meas Power (dBm)	Total Corr'd Power (dBm)	Power Limit (dBm)	Margin (dB)
Low	2412	19.91	19.91	30.00	-10.09
Mid	2437	19.97	19.97	30.00	-10.03
High_11	2462	19.89	19.89	30.00	-10.11
High_12	2467	19.92	19.92	30.00	-10.08
High_13	2472	17.48	17.48	30.00	-12.52

8.2.5. POWER SPECTRAL DENSITY

LIMITS

FCC §15.247

IC RSS-247 (5.2) (2)

For digitally modulated systems, the power spectral density conducted from the intentional radiator to the antenna shall not be greater than 8 dBm in any 3 KHz band during any time interval of continuous transmissions.

RESULTS

Duty Cycle CF (dB)	0.00	Included in Calculations of Corr'd PSD
---------------------------	------	---

PSD Results

Channel	Frequency (MHz)	Meas (dBm)	Total Corr'd PSD (dBm)	Limit (dBm)	Margin (dB)
Low	2412	-6.721	-6.72	8.0	-14.7
Mid	2437	-5.322	-5.32	8.0	-13.3
High_11	2462	-7.021	-7.02	8.0	-15.0
High_12	2467	-6.893	-6.89	8.0	-14.9
High_13	2472	-8.677	-8.68	8.0	-16.7

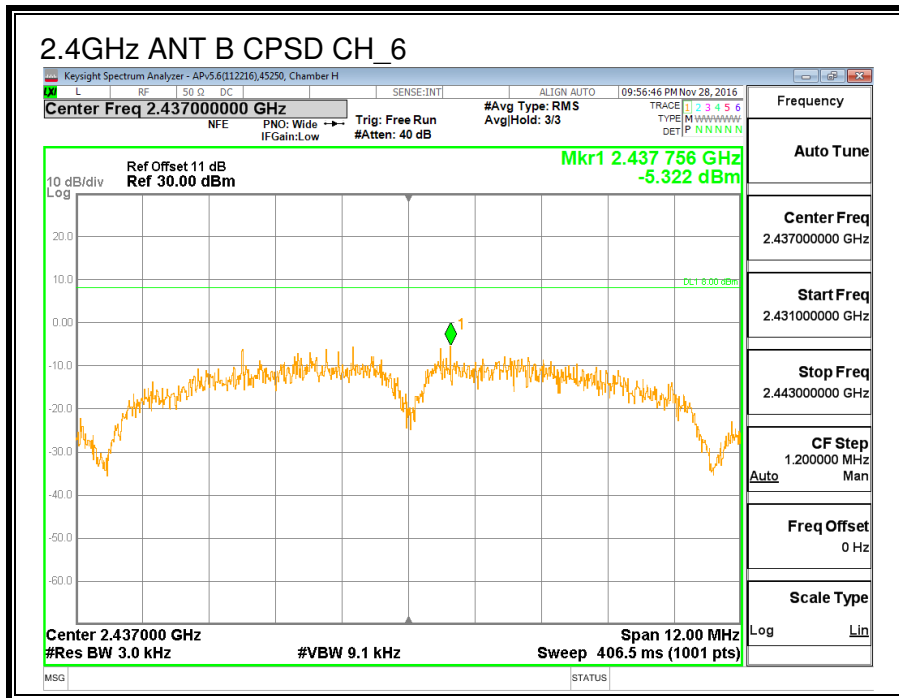
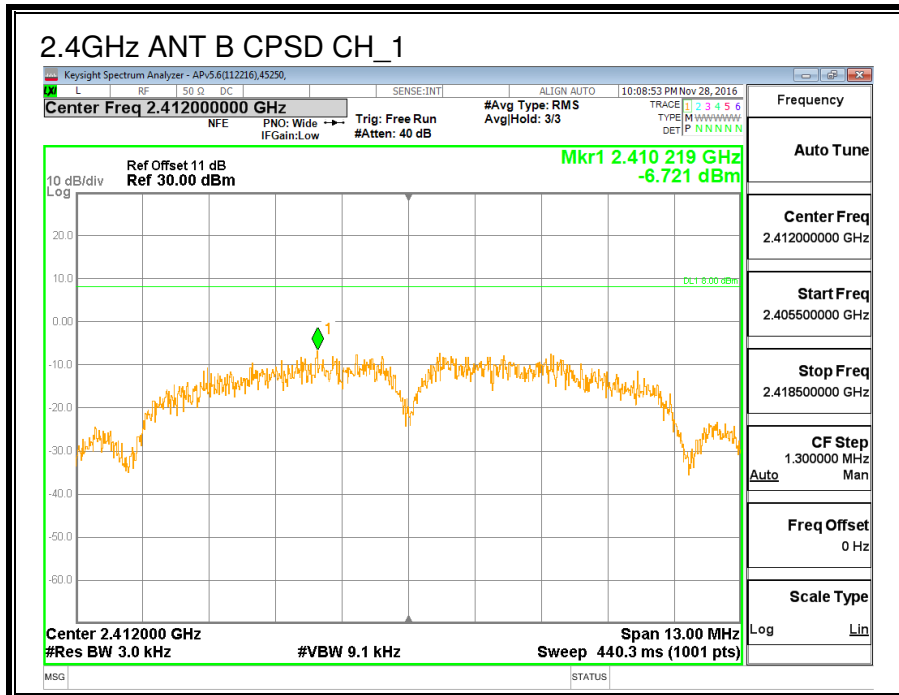

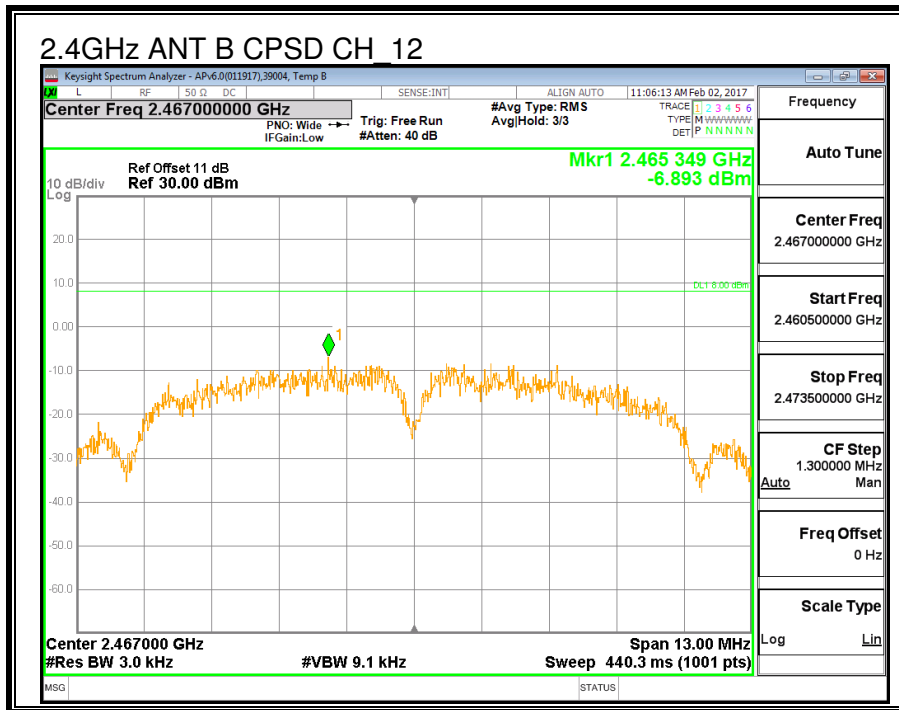
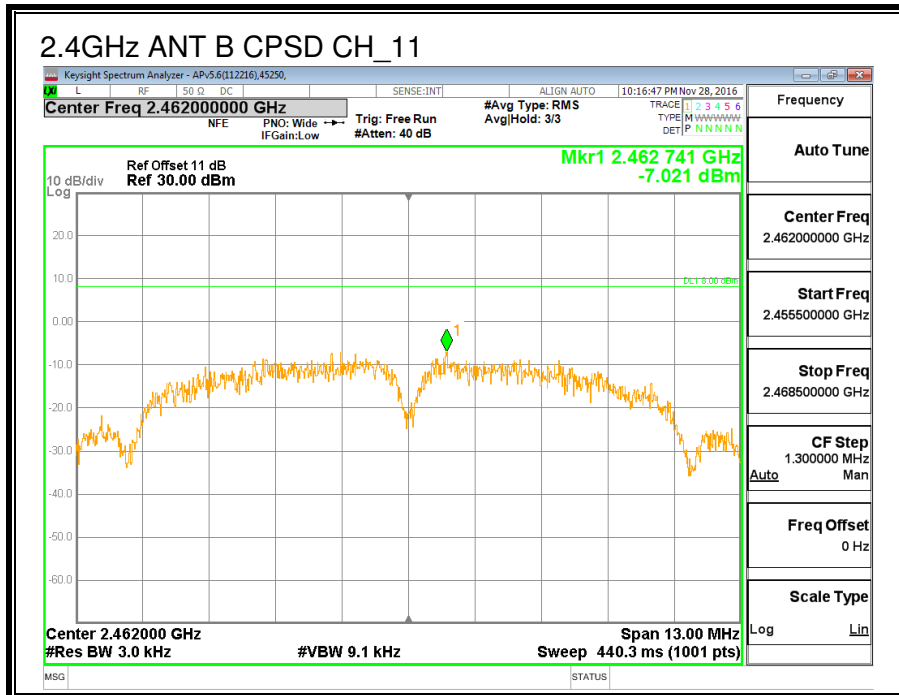

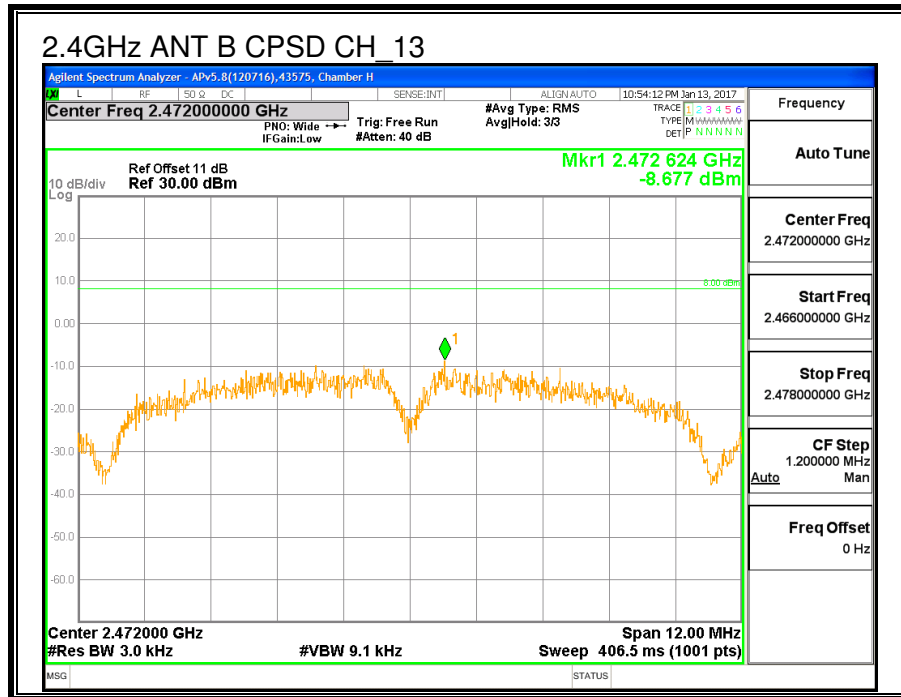

8.2.6. CONDUCTED BANDEDGE AND SPURIOUS EMISSIONS

LIMITS

FCC §15.247 (d)

IC RSS-247 (5.5)

In any 100 kHz bandwidth outside the frequency band in which the spread spectrum or digitally modulated intentional radiator is operating, the radio frequency power that is produced by the intentional radiator shall be at least 20 dB below that in the 100 kHz bandwidth within the band that contains the highest level of the desired power, based on either an RF conducted or a radiated measurement, provided the transmitter demonstrates compliance with the peak conducted power limits. If the transmitter complies with the conducted power limits based on the use of RMS averaging over a time interval, as permitted under paragraph (b)(3) of this section, the attenuation required under this paragraph shall be 30 dB instead of 20 dB. Attenuation below the general limits specified in §15.209(a) is not required.

RESULTS

LOW CHANNEL BANDEDGE

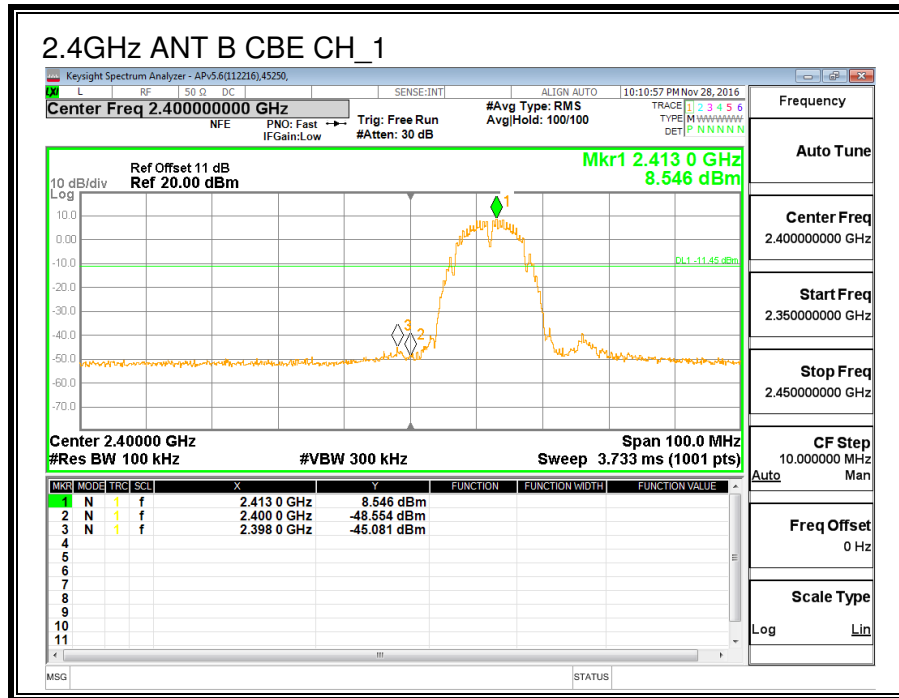

MID CHANNEL REFERENCE

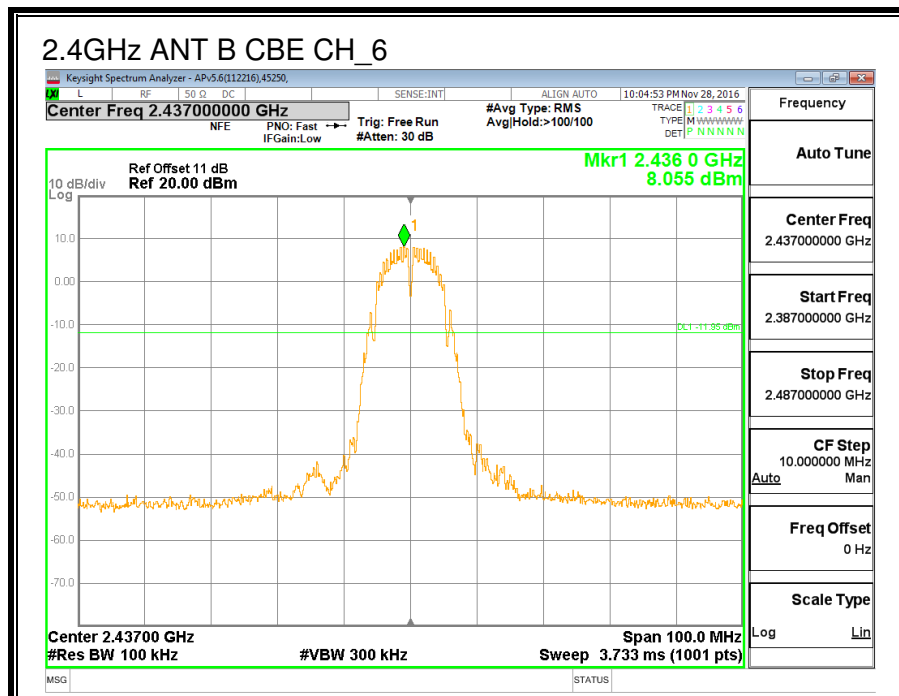

HIGH CHANNEL BANDEDGE

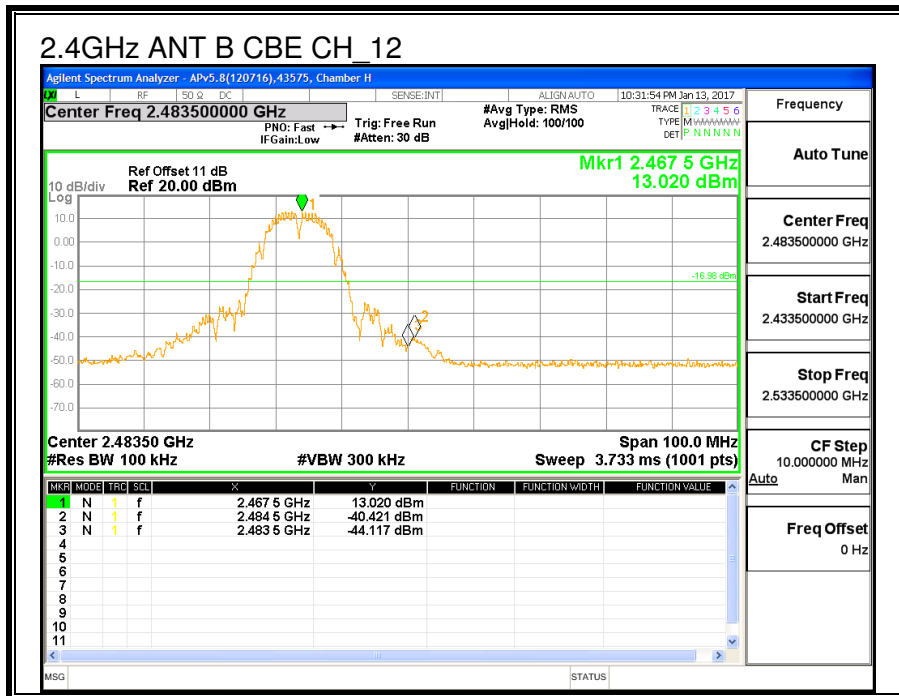
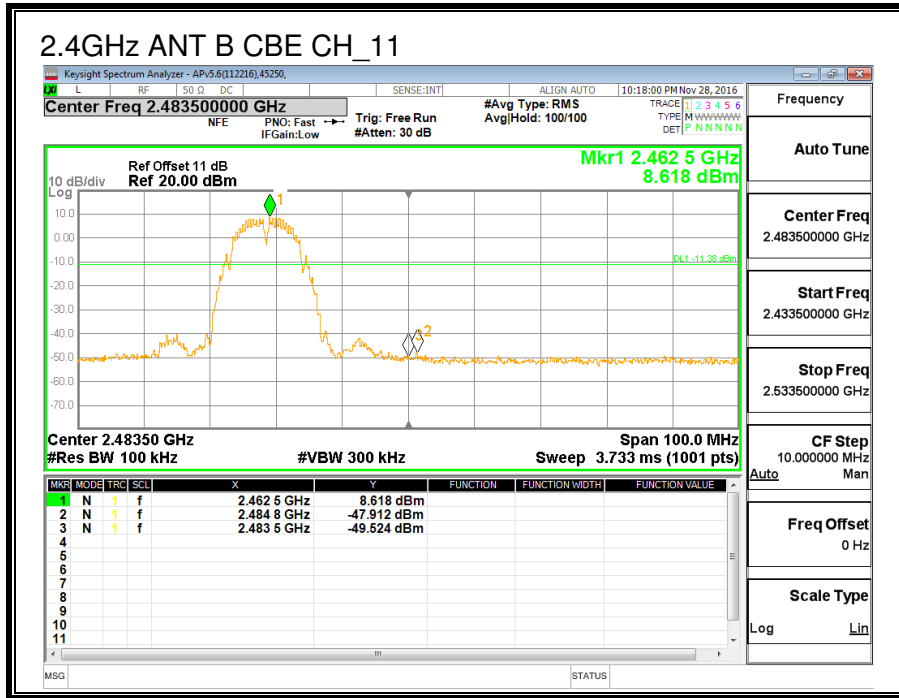

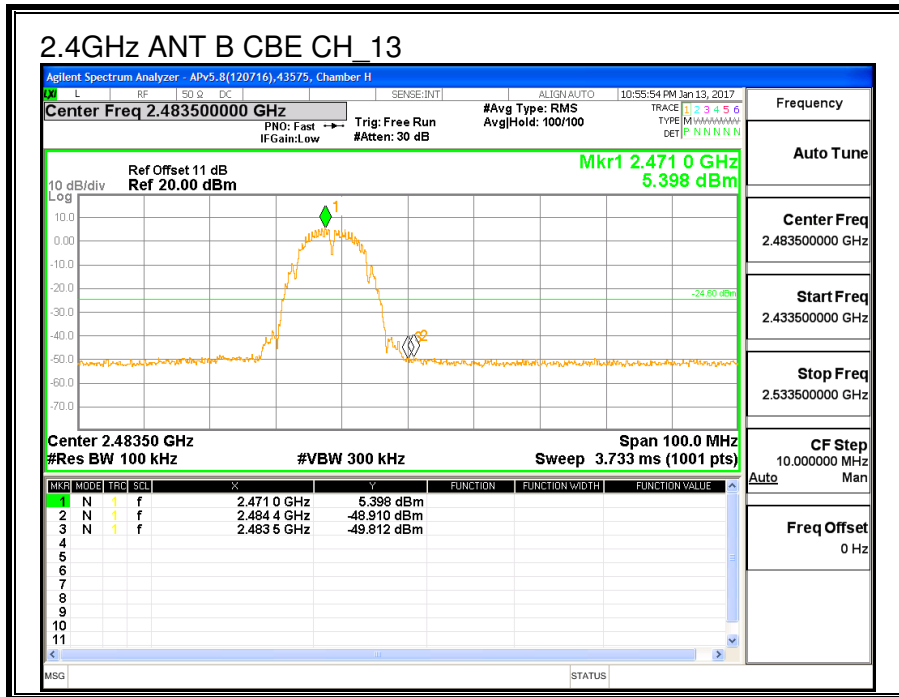

OUT-OF-BAND EMISSIONS

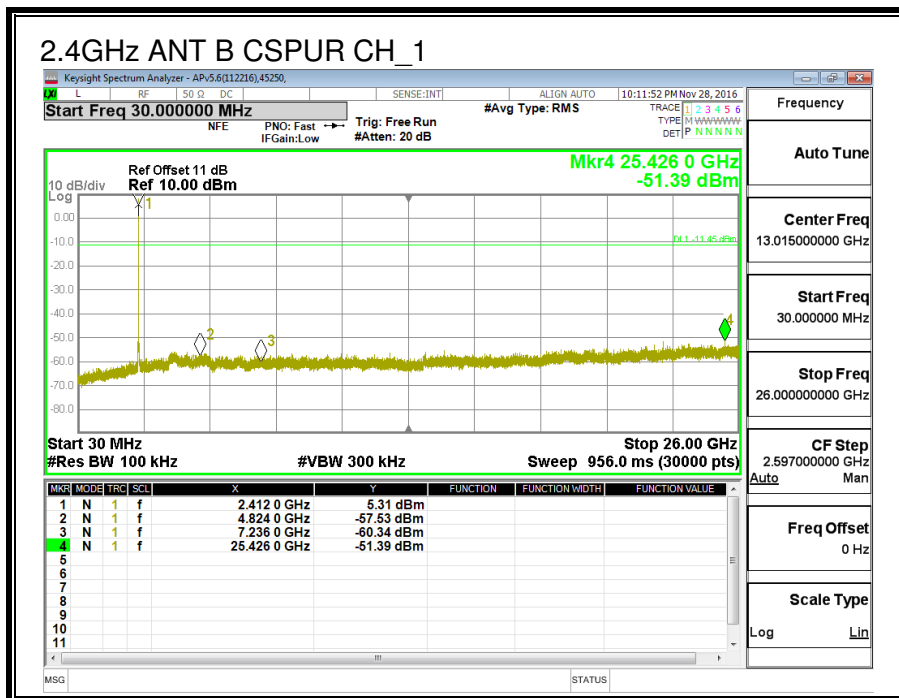

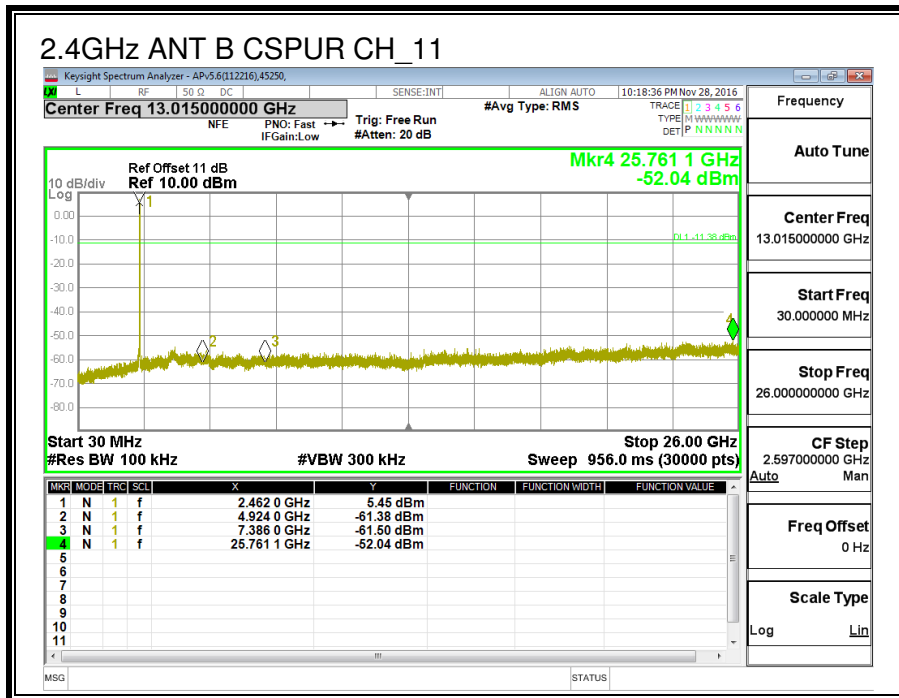
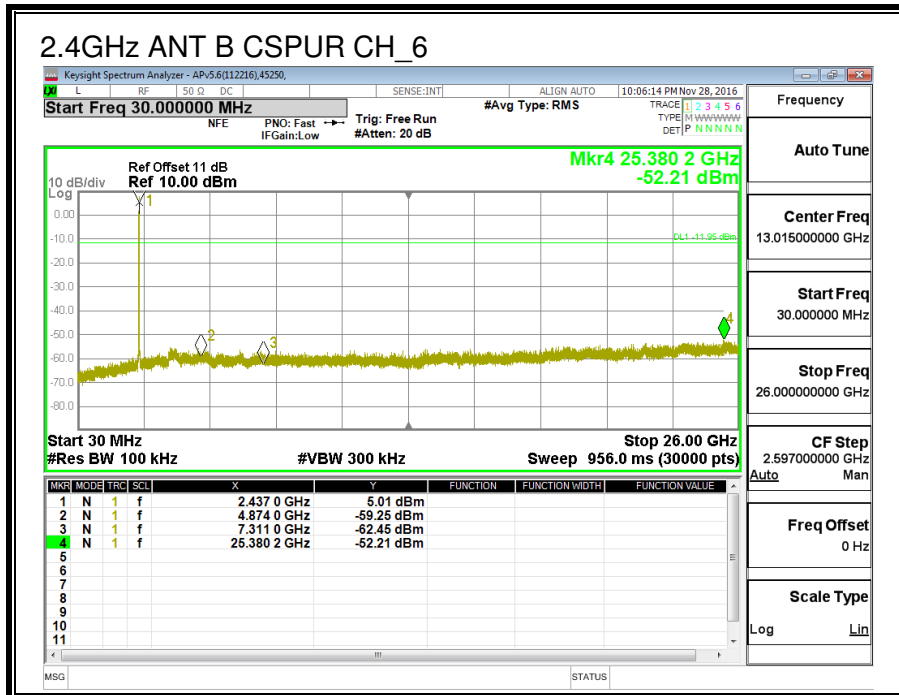

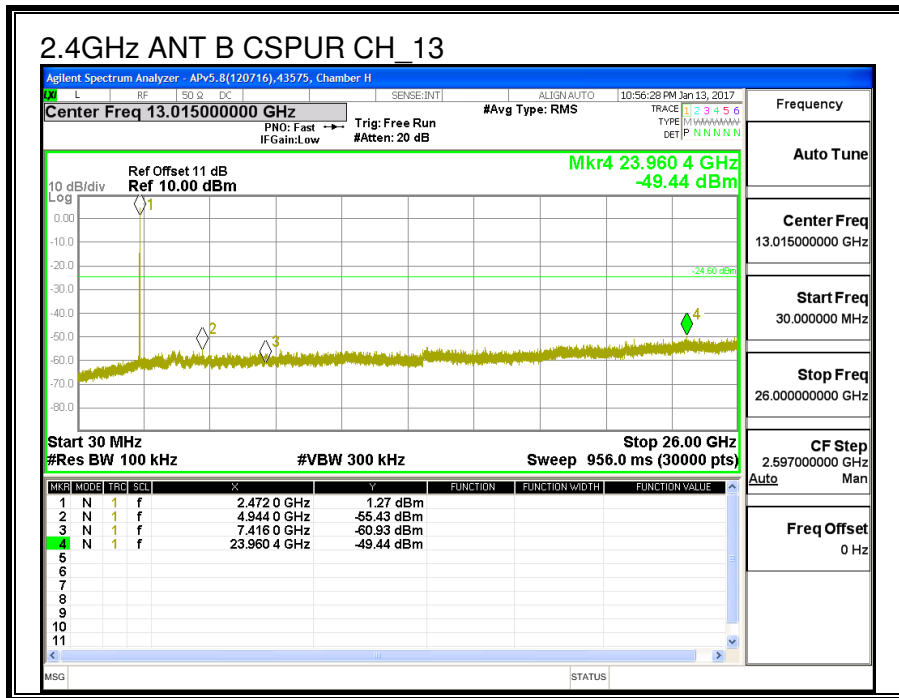
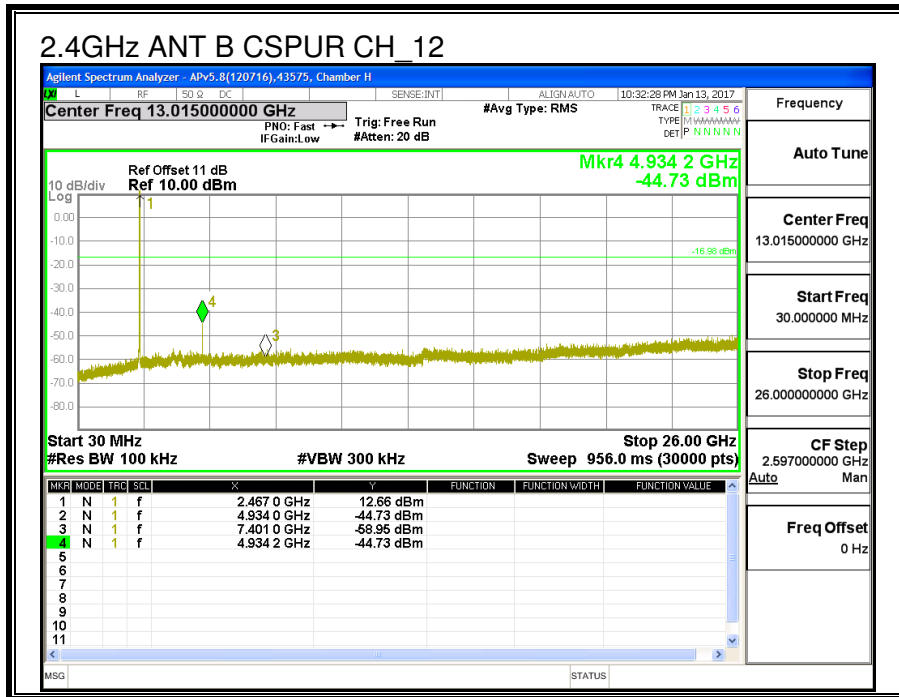

8.3. 11n HT20 ANTENNA A SISO MODE IN THE 2.4GHz BAND

8.3.1. 6 dB BANDWIDTH

LIMITS

FCC §15.247 (a) (2)

IC RSS-247 (5.2) (1)

The minimum 6 dB bandwidth shall be at least 500 kHz.

RESULTS

Channel	Frequency	6 dB BW Ant A (MHz)	Minimum Limit (MHz)
Low_1	2412	16.050	0.5
Middle_6	2437	17.175	0.5
High_10	2457	16.92	0.5
High_11	2462	17.210	0.5
High_12	2467	16.930	0.5
High_13	2472	17.560	0.5

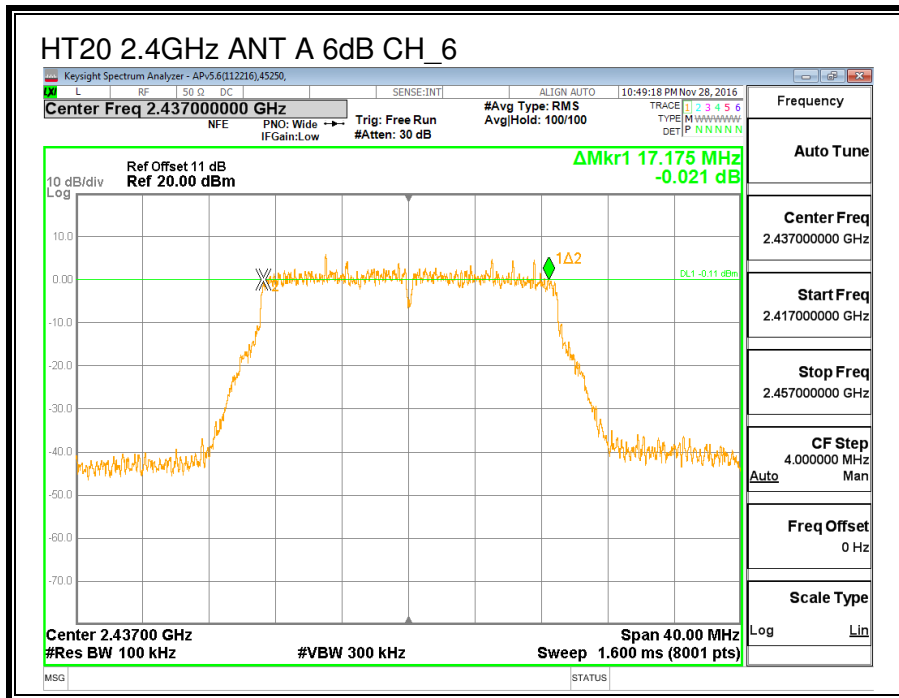
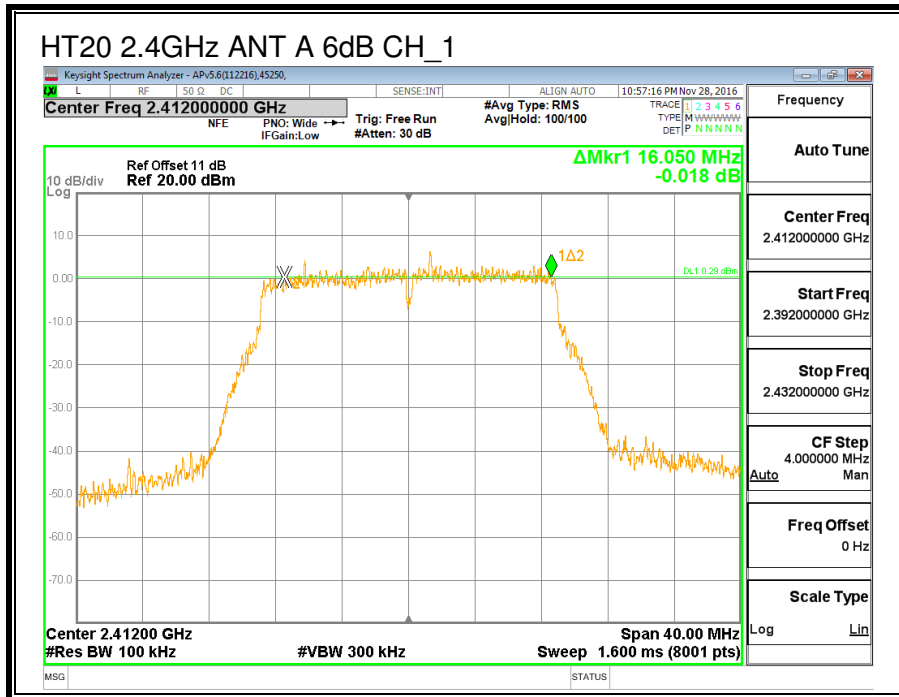

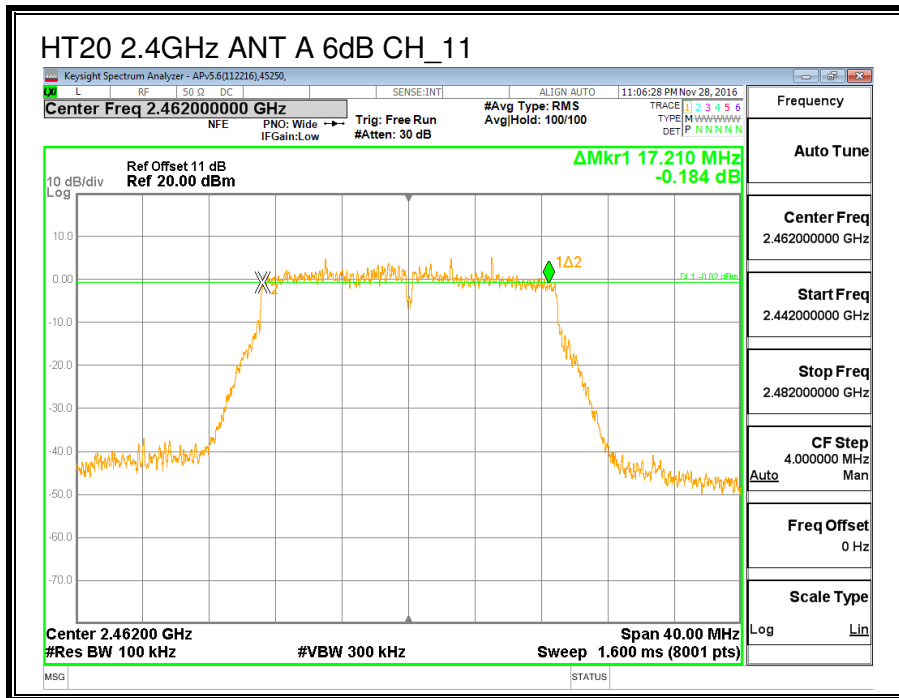
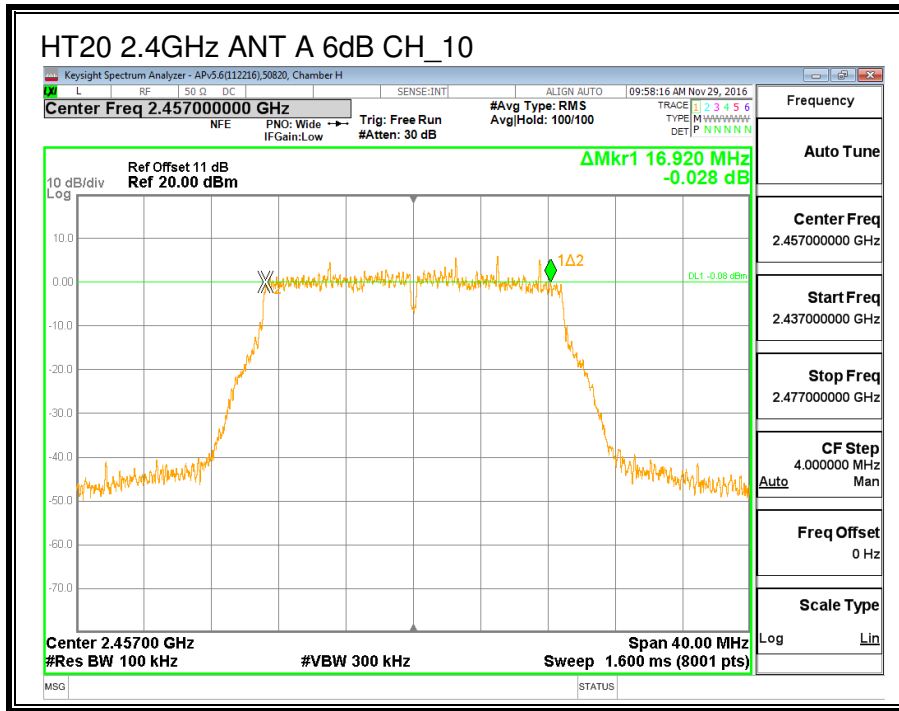

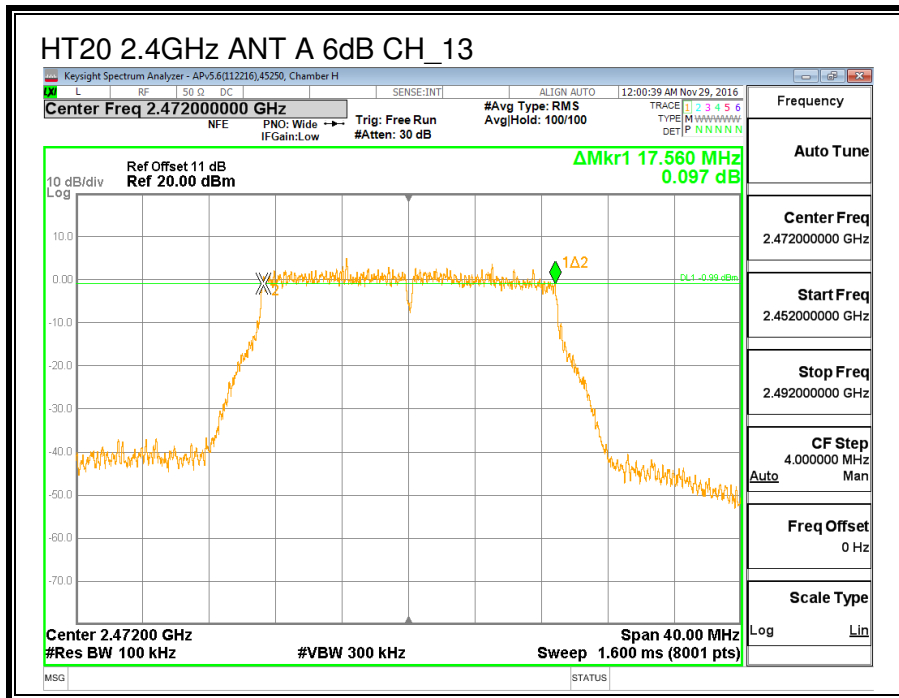
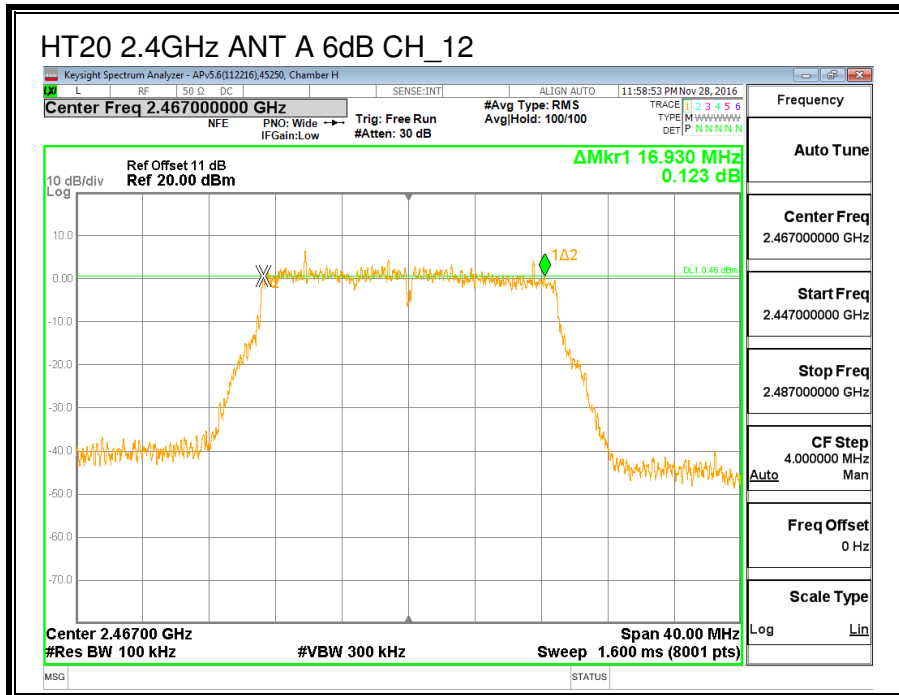

8.3.2. 99% BANDWIDTH

LIMITS

None; for reporting purposes only.

RESULTS

Channel	Frequency (MHz)	99% Bandwidth Ant A (MHz)
Low_1	2412	17.812
Middle_6	2437	17.830
High_10	2457	17.839
High_11	2462	17.783
High_12	2467	17.805
High_13	2472	17.705

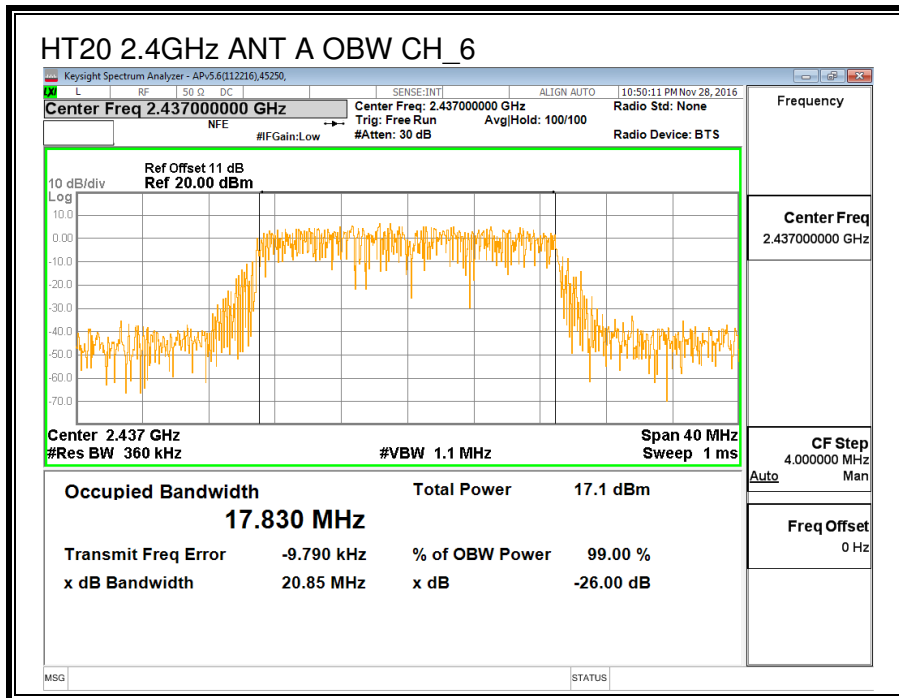
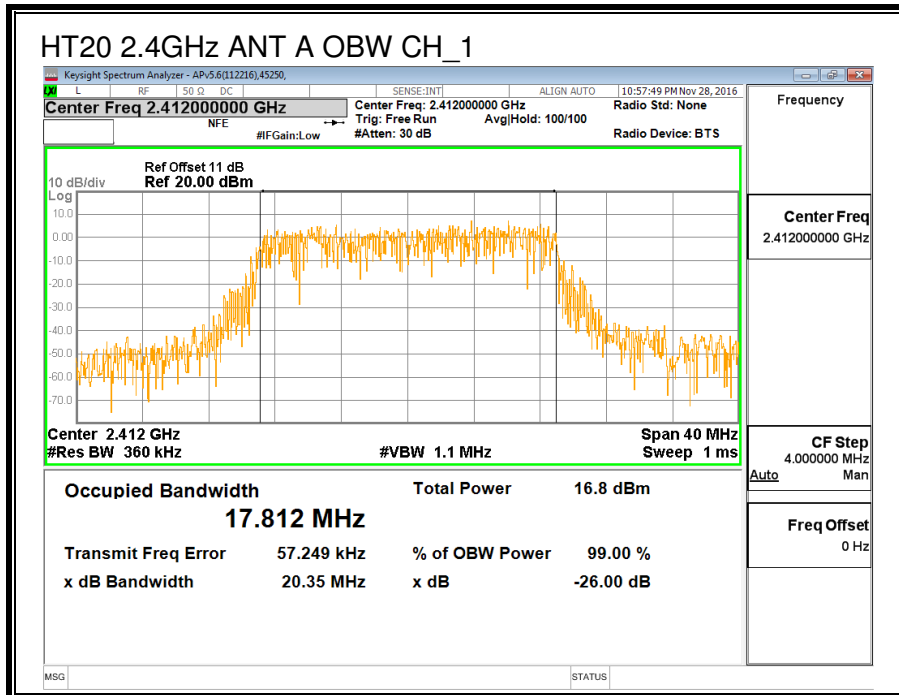

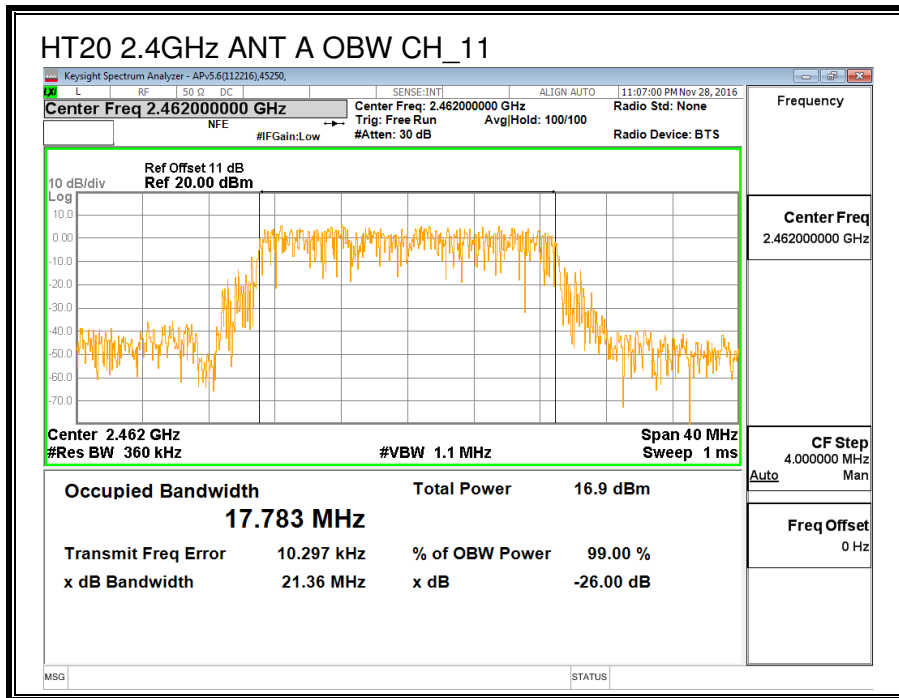
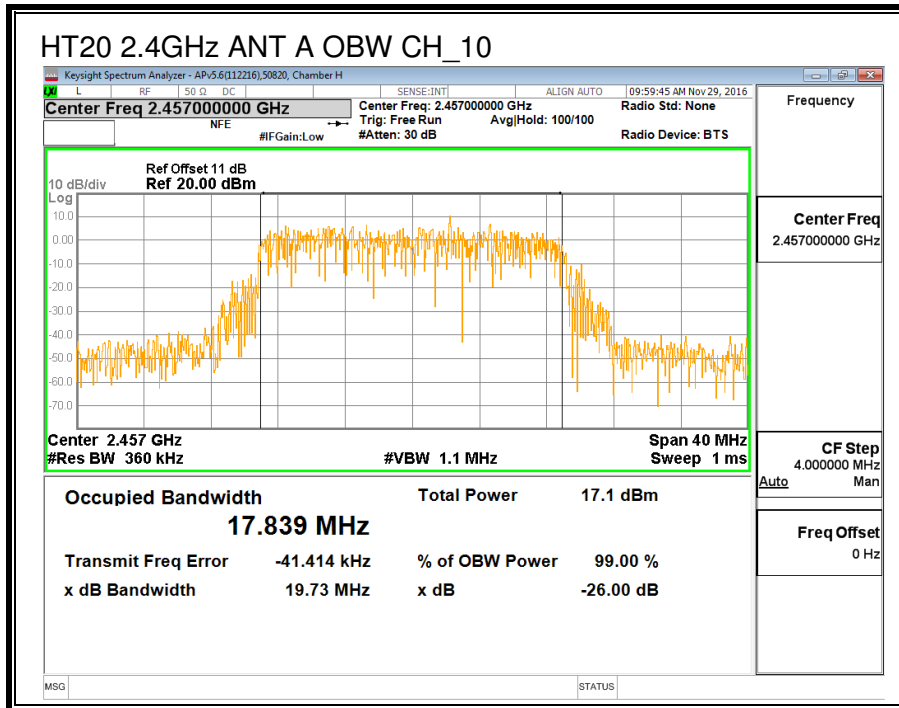

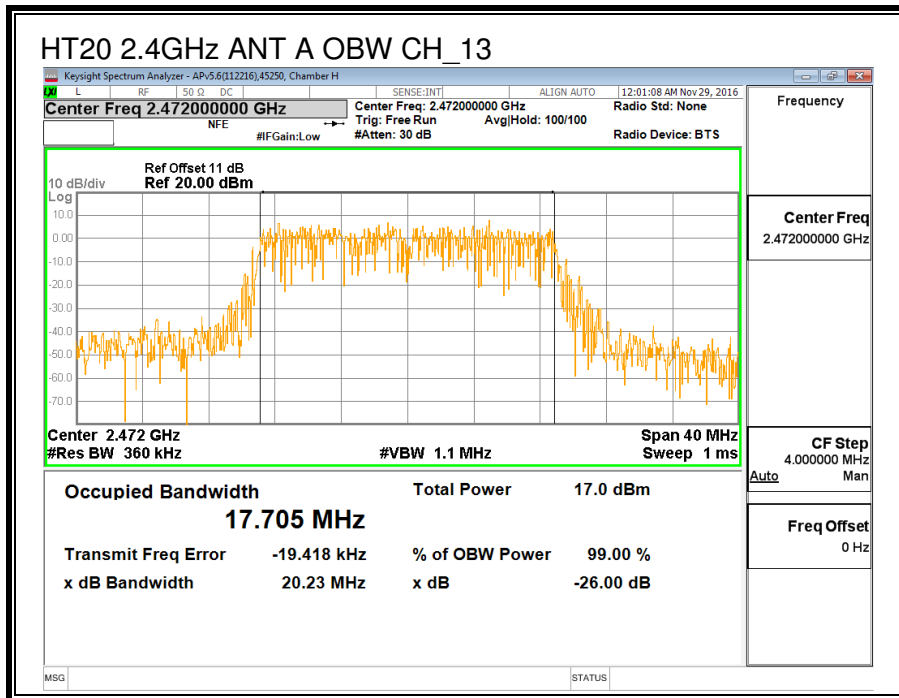
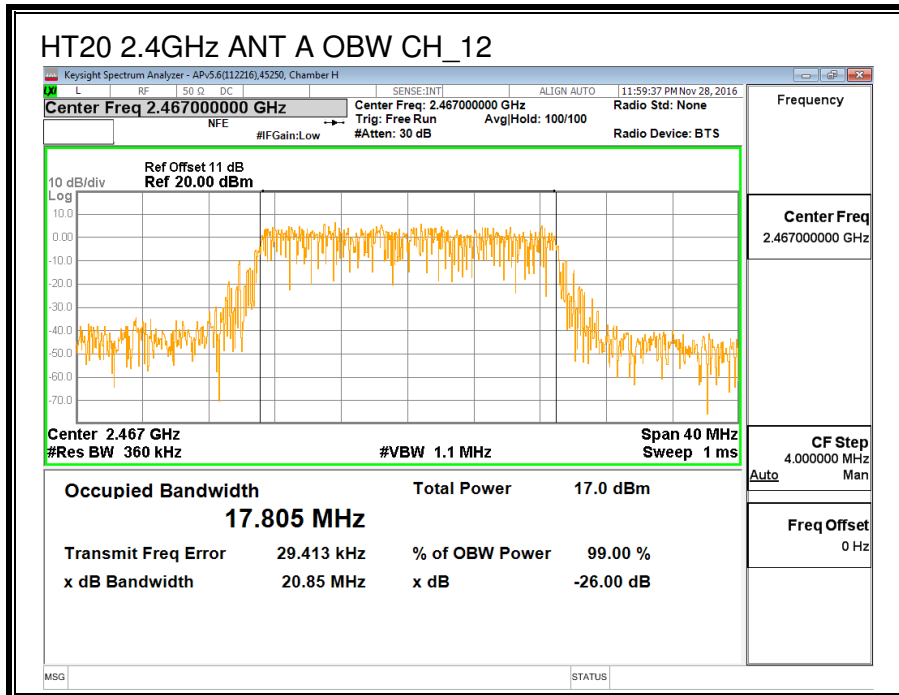

8.3.3. AVERAGE POWER

ID:	38602	Date:	2-2-2017
------------	-------	--------------	----------

LIMITS

None; for reporting purposes only.

RESULTS

Channel	Frequency (MHz)	Power Ant A (MHz)
Low_1	2412	15.95
Middle_6	2437	15.90
High_10	2457	15.80
High_11	2462	13.48
High_12	2467	11.32
High_13	2472	1.27

8.3.4. OUTPUT POWER

ID:	38602	Date:	2-2-2017
------------	-------	--------------	----------

LIMITS

FCC §15.247

IC RSS-247 (5.4) (4)

For systems using digital modulation in the 2400–2483.5 MHz, and 5725–5850 MHz bands: 1 Watt, based on the use of antennas with directional gains that do not exceed 6 dBi. If transmitting antennas of directional gain greater than 6 dBi are used, the conducted output power from the intentional radiator shall be reduced by the amount in dB that the directional gain of the antenna exceeds 6 dBi.

DIRECTIONAL ANTENNA GAIN

There is only one transmitter output therefore the directional gain is equal to the antenna gain.

RESULTS

Limits

Channel	Frequency (MHz)	Directional Gain (dBi)	FCC Power Limit (dBm)	IC Power Limit (dBm)	IC EIRP Limit (dBm)	Max Power (dBm)
Low	2412	-0.48	30.00	30	36	30.00
Mid	2437	-0.48	30.00	30	36	30.00
High_10	2457	-0.48	30.00	30	36	30.00
High_11	2462	-0.48	30.00	30	36	30.00
High_12	2467	-0.48	30.00	30	36	30.00
High_13	2472	-0.48	30.00	30	36	30.00

Duty Cycle CF (dB)	0.00	Included in Calculations of Corr'd Power
---------------------------	------	---

Results

Channel	Frequency (MHz)	Meas Power (dBm)	Total Corr'd Power (dBm)	Power Limit (dBm)	Margin (dB)
Low	2412	19.98	19.98	30.00	-10.02
Mid	2437	20.02	20.02	30.00	-9.98
High_10	2457	19.94	19.94	30.00	-10.06
High_11	2462	16.55	16.55	30.00	-13.45
High_12	2467	14.45	14.45	30.00	-15.55
High_13	2472	4.41	4.41	30.00	-25.59

8.3.5. POWER SPECTRAL DENSITY

LIMITS

FCC §15.247

IC RSS-247 (5.2) (2)

For digitally modulated systems, the power spectral density conducted from the intentional radiator to the antenna shall not be greater than 8 dBm in any 3 KHz band during any time interval of continuous transmissions.

RESULTS

Duty Cycle CF (dB)	0.00	Included in Calculations of Corr'd PSD
---------------------------	------	---

PSD Results

Channel	Frequency (MHz)	Meas (dBm)	Total Corr'd PSD (dBm)	Limit (dBm)	Margin (dB)
Low	2412	-9.197	-9.20	8.0	-17.2
Mid	2437	-9.404	-9.40	8.0	-17.4
High_10	2457	-9.893	-9.89	8.0	-17.9
High_11	2462	-9.389	-9.39	8.0	-17.4
High_12	2467	-11.167	-11.17	8.0	-19.2
High_13	2472	-23.788	-23.79	8.0	-31.8

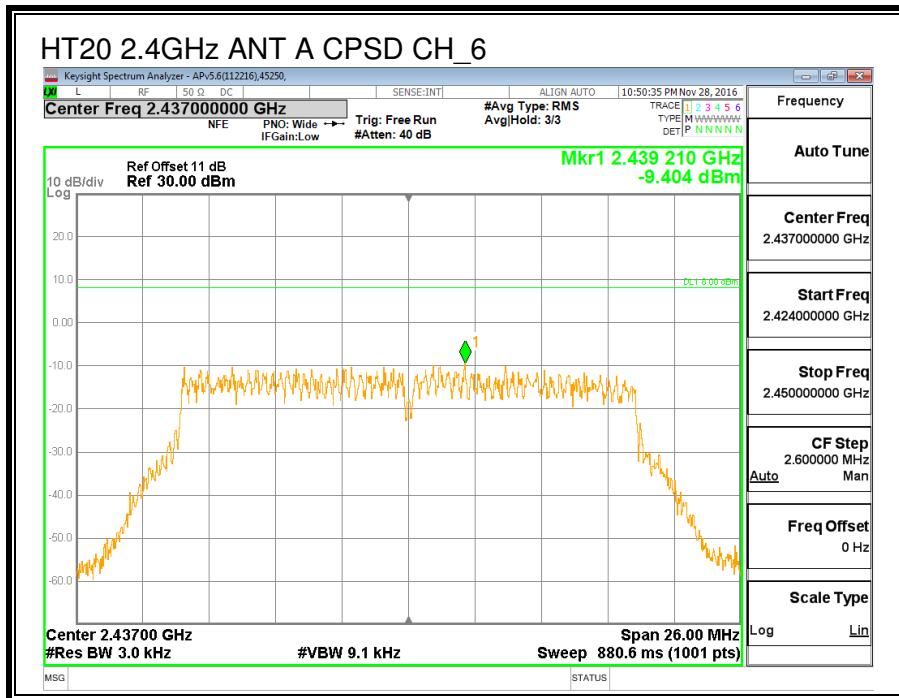
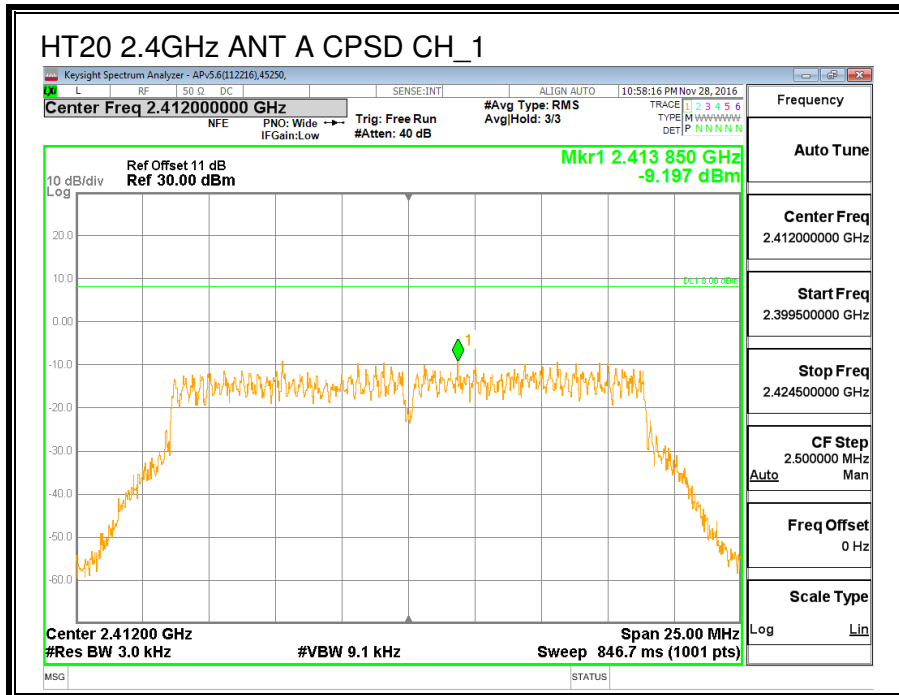

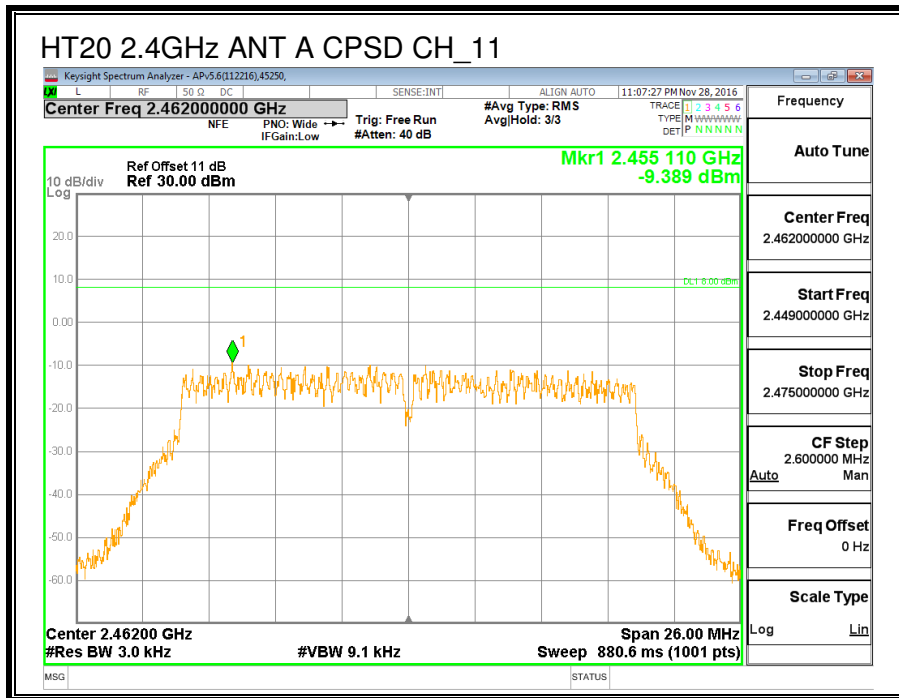
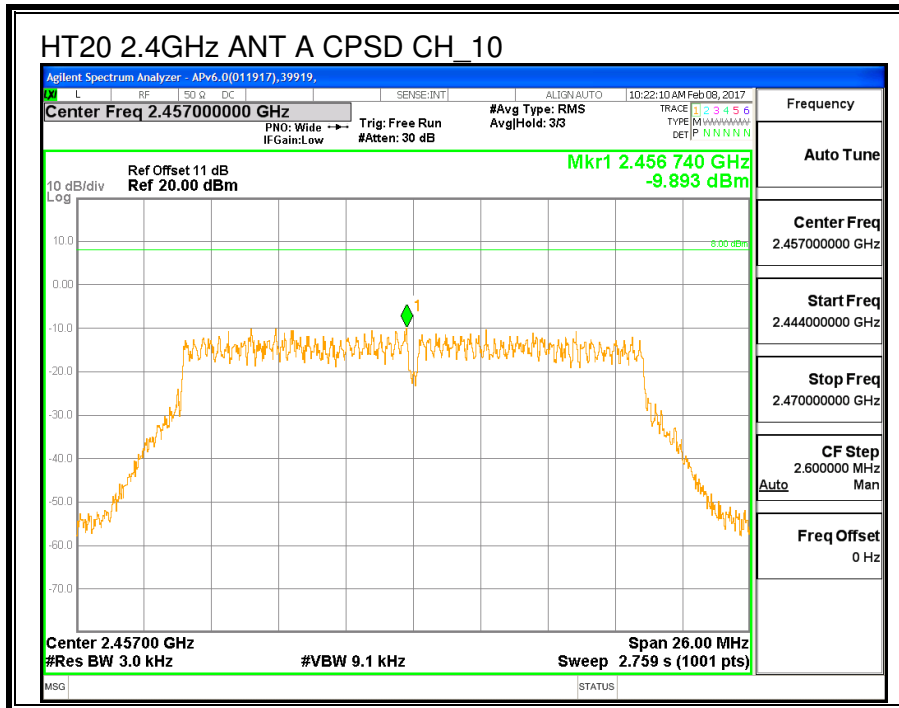

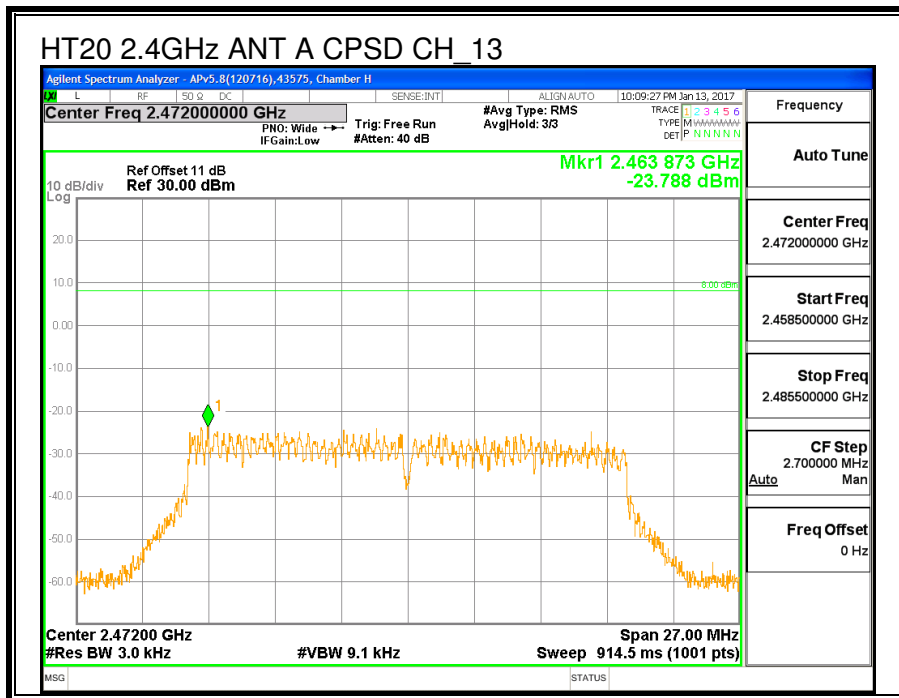
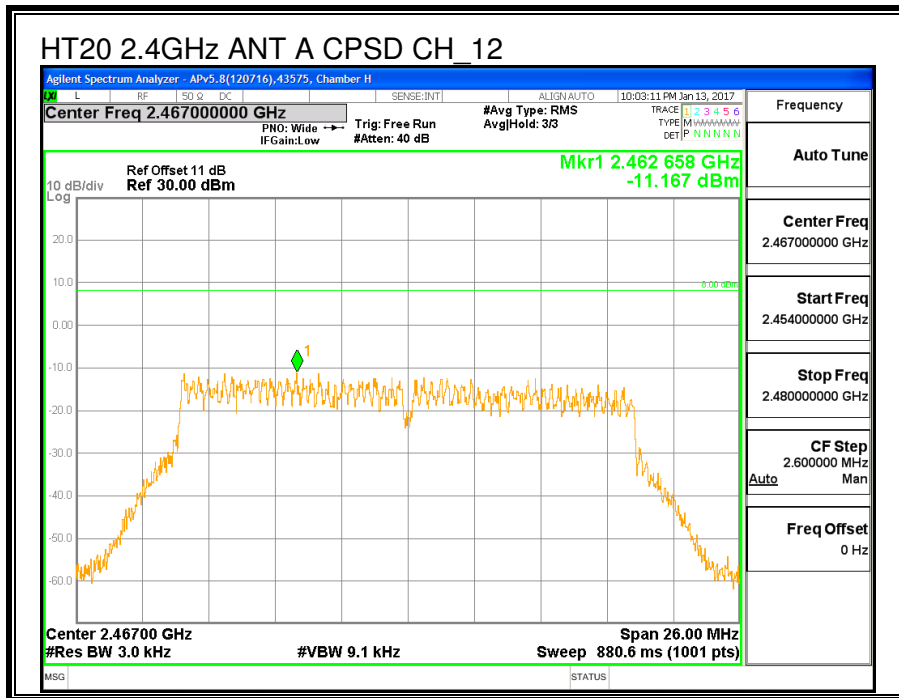

8.3.6. CONDUCTED BANDEdge AND SPURIOUS EMISSIONS

LIMITS

FCC §15.247 (d)

IC RSS-247 (5.5)

In any 100 kHz bandwidth outside the frequency band in which the spread spectrum or digitally modulated intentional radiator is operating, the radio frequency power that is produced by the intentional radiator shall be at least 20 dB below that in the 100 kHz bandwidth within the band that contains the highest level of the desired power, based on either an RF conducted or a radiated measurement, provided the transmitter demonstrates compliance with the peak conducted power limits. If the transmitter complies with the conducted power limits based on the use of RMS averaging over a time interval, as permitted under paragraph (b)(3) of this section, the attenuation required under this paragraph shall be 30 dB instead of 20 dB. Attenuation below the general limits specified in §15.209(a) is not required.

RESULTS

LOW CHANNEL BANDEDGE

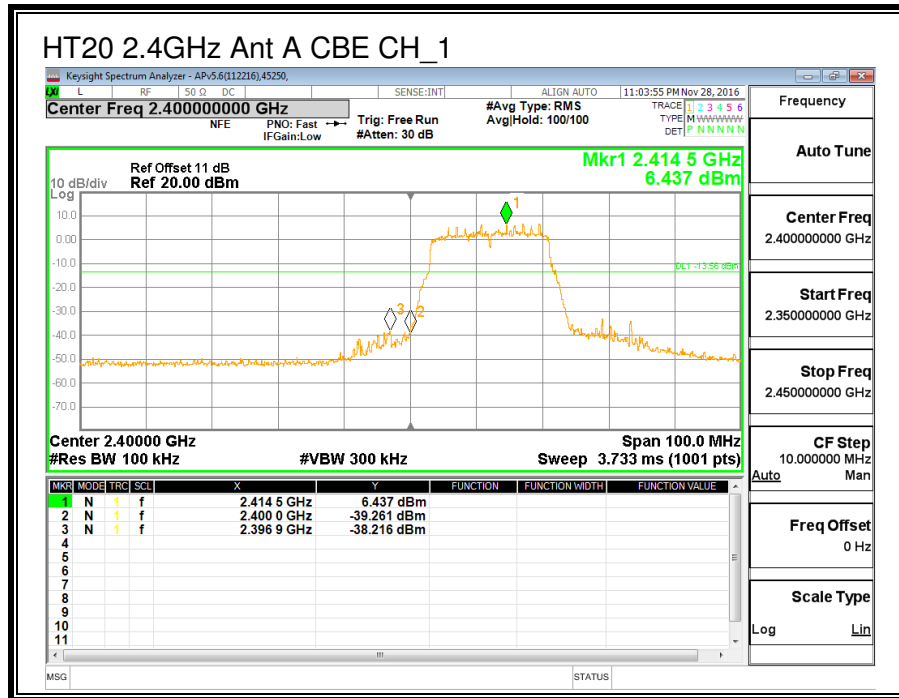

MID CHANNEL REFERENCE

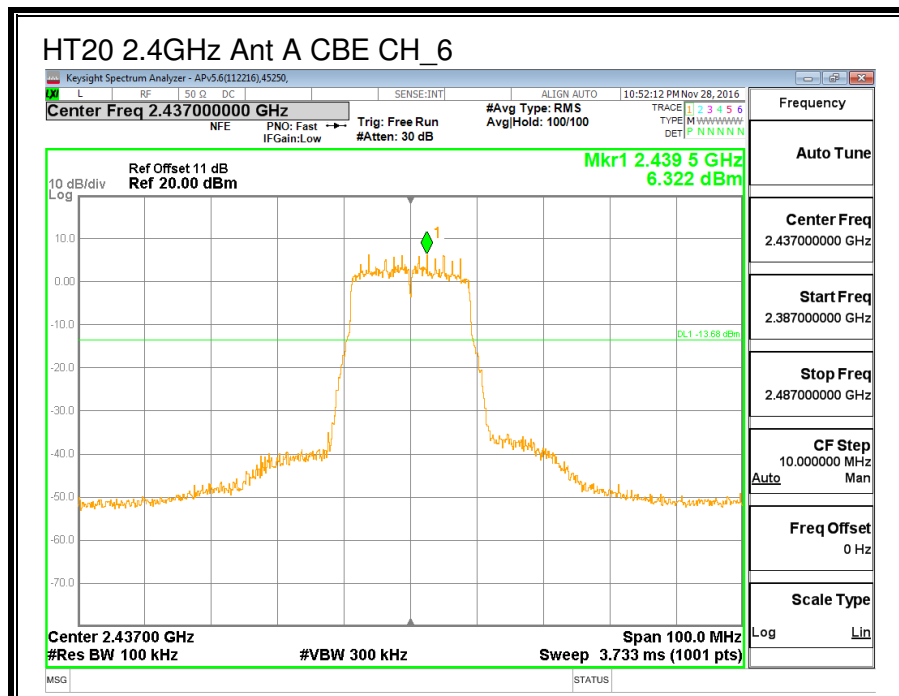

HIGH CHANNEL BANDEDGE

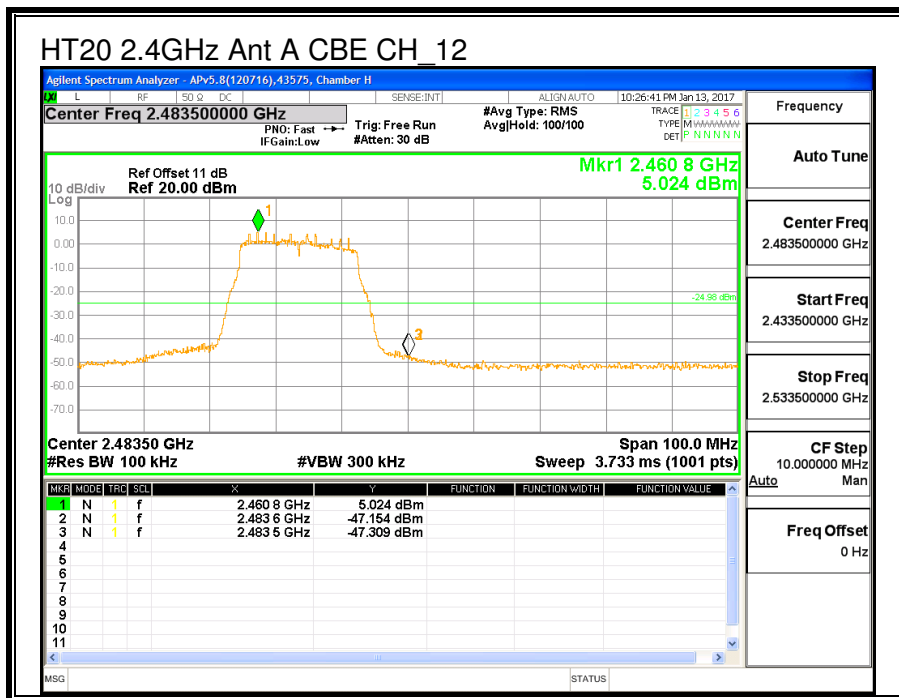
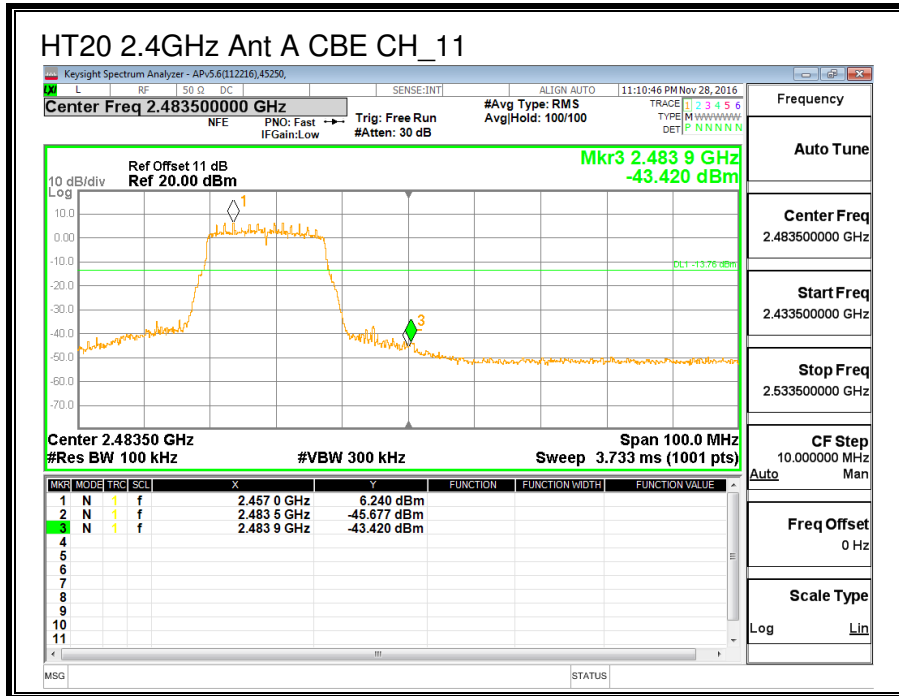

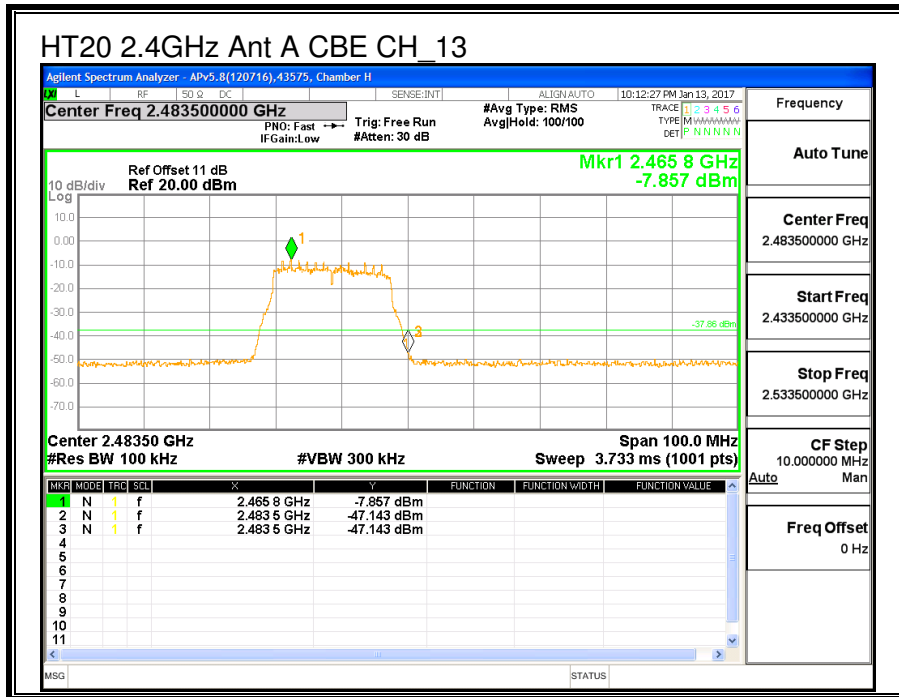

OUT-OF-BAND EMISSIONS

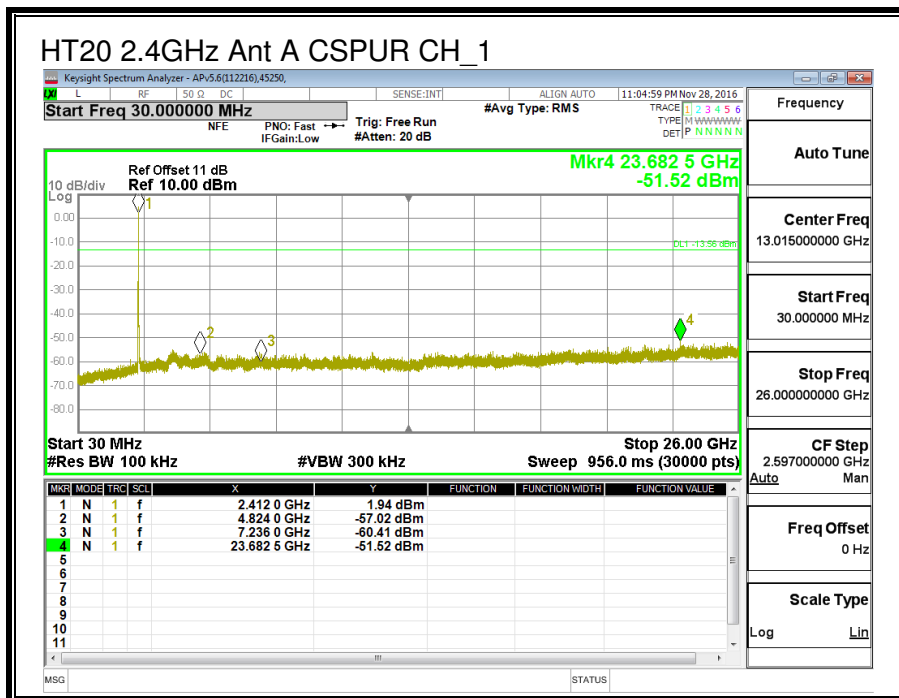

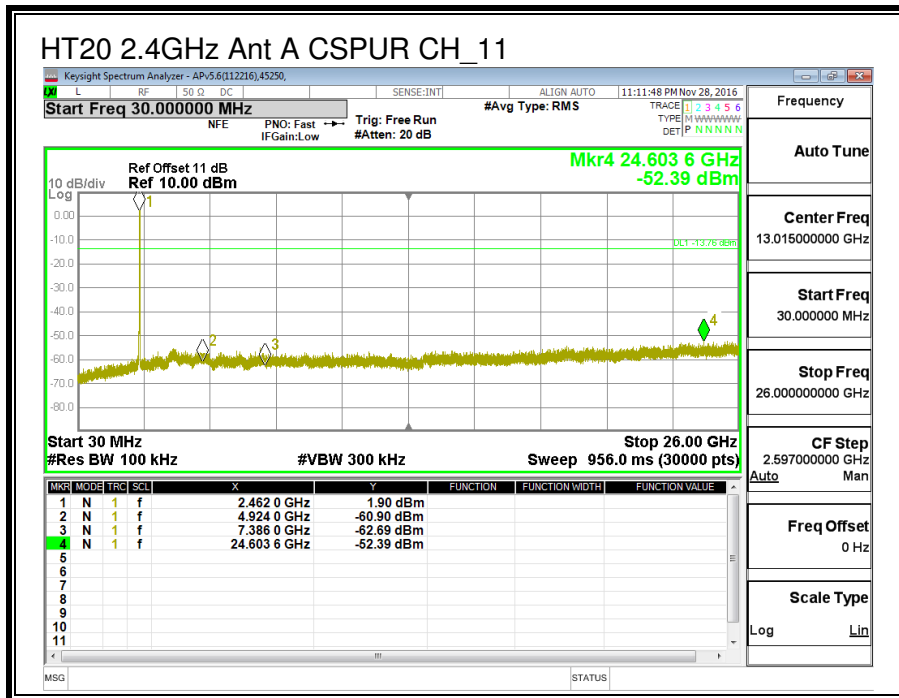
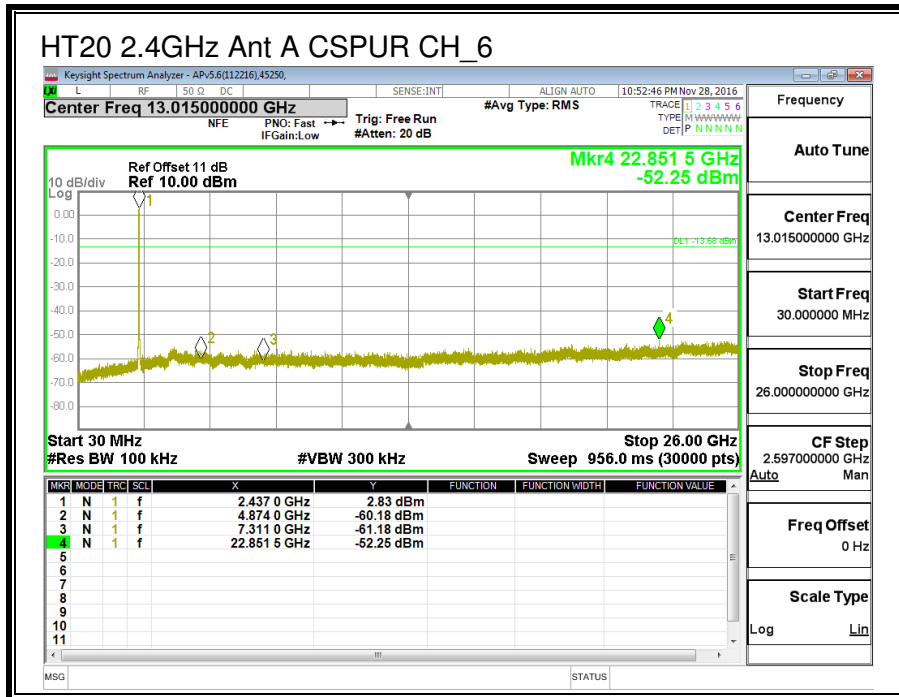

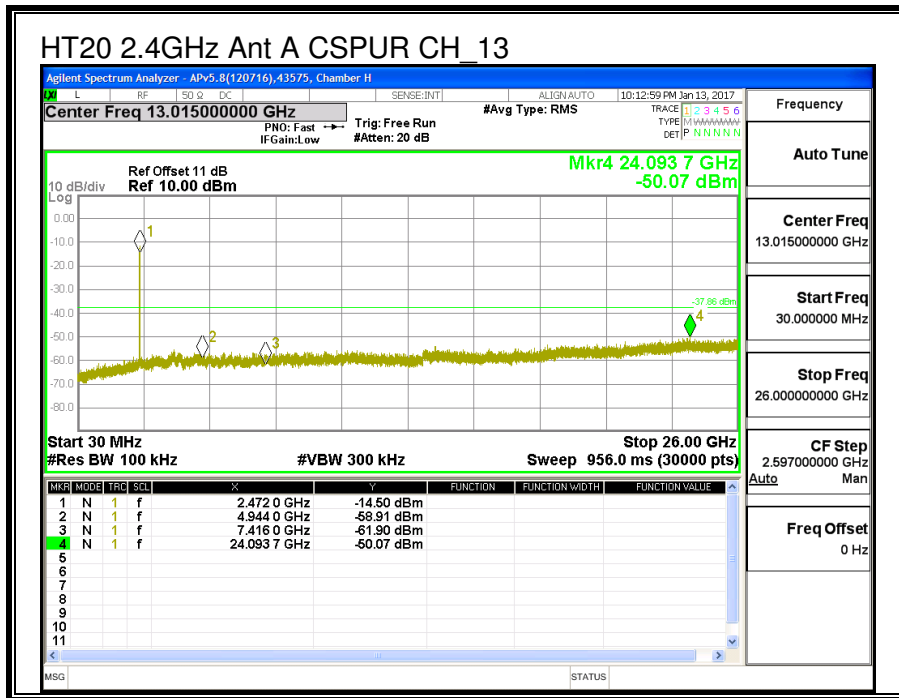
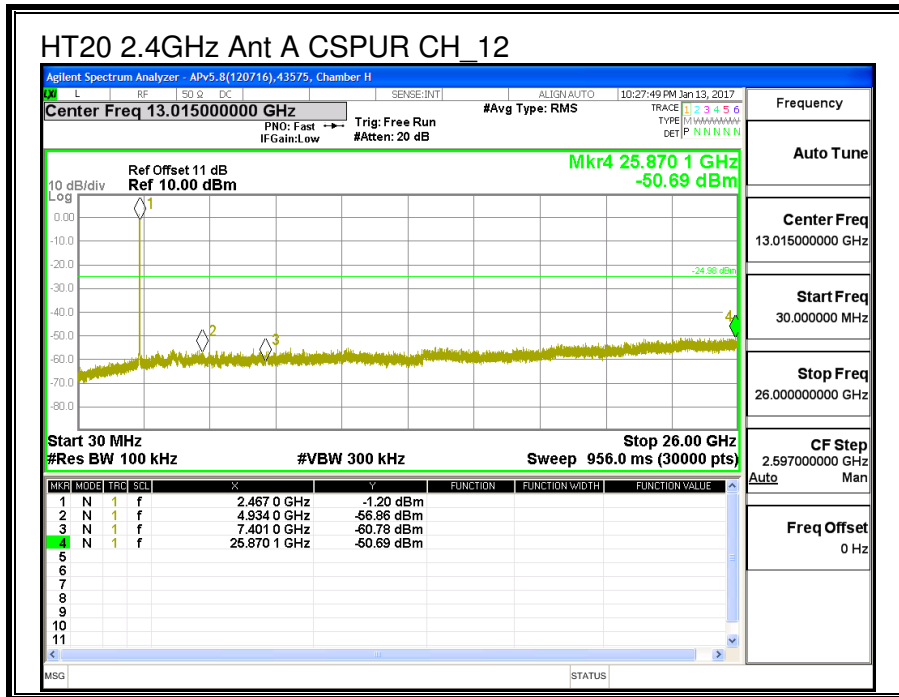

8.4. 11n HT20 ANTENNA B SISO MODE IN THE 2.4GHz BAND

8.4.1. 6 dB BANDWIDTH

LIMITS

FCC §15.247 (a) (2)

IC RSS-247 (5.2) (1)

The minimum 6 dB bandwidth shall be at least 500 kHz.

RESULTS

Channel	Frequency	6 dB BW ANT B (MHz)	Minimum Limit (MHz)
Low_1	2412	15.635	0.5
Middle_6	2437	17.170	0.5
High_10	2457	17.555	0.5
High_11	2462	16.925	0.5
High_12	2467	16.330	0.5
High_13	2472	17.565	0.5

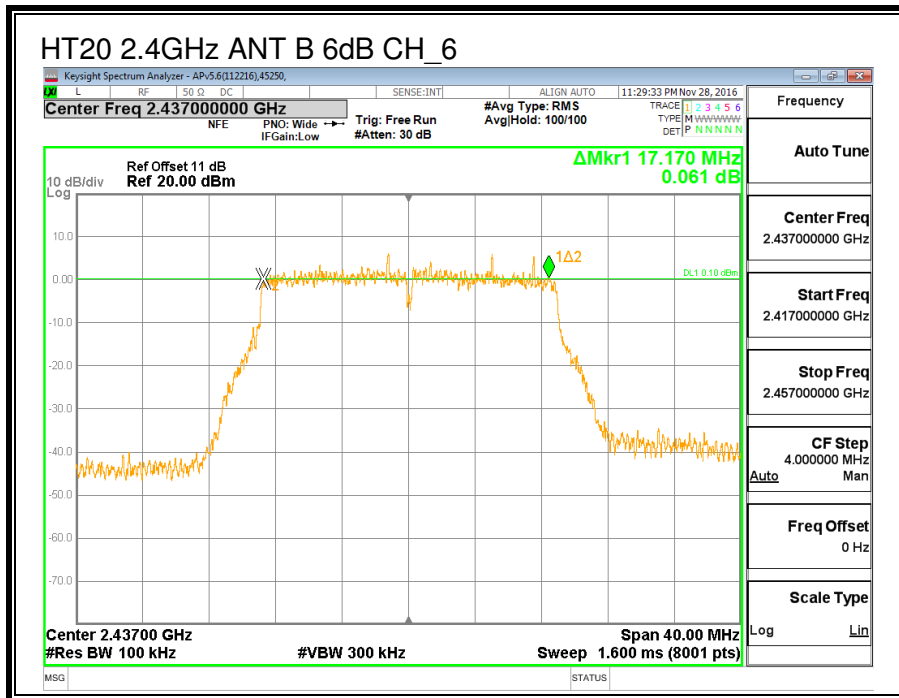
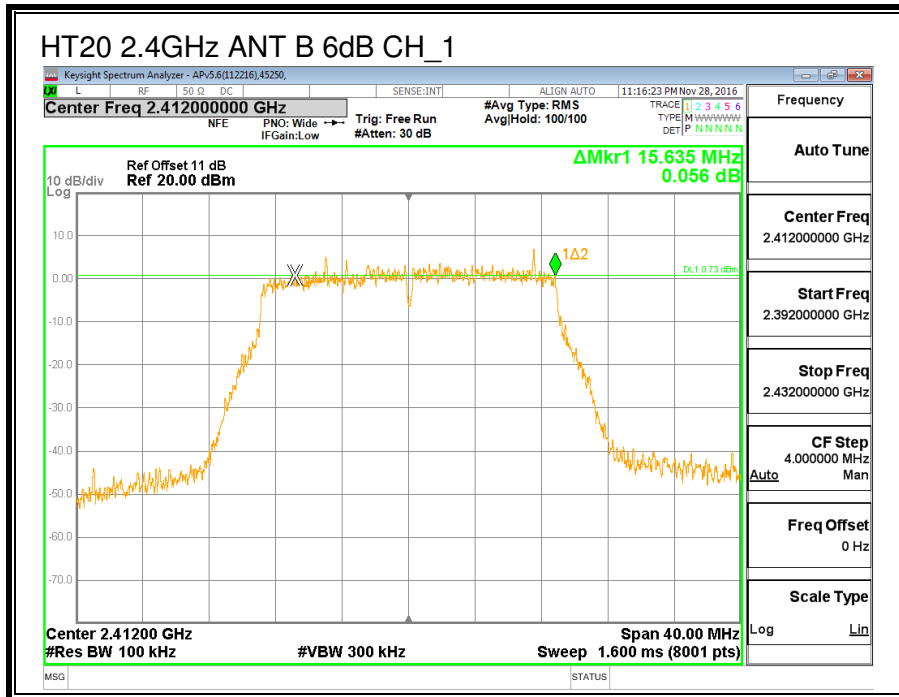

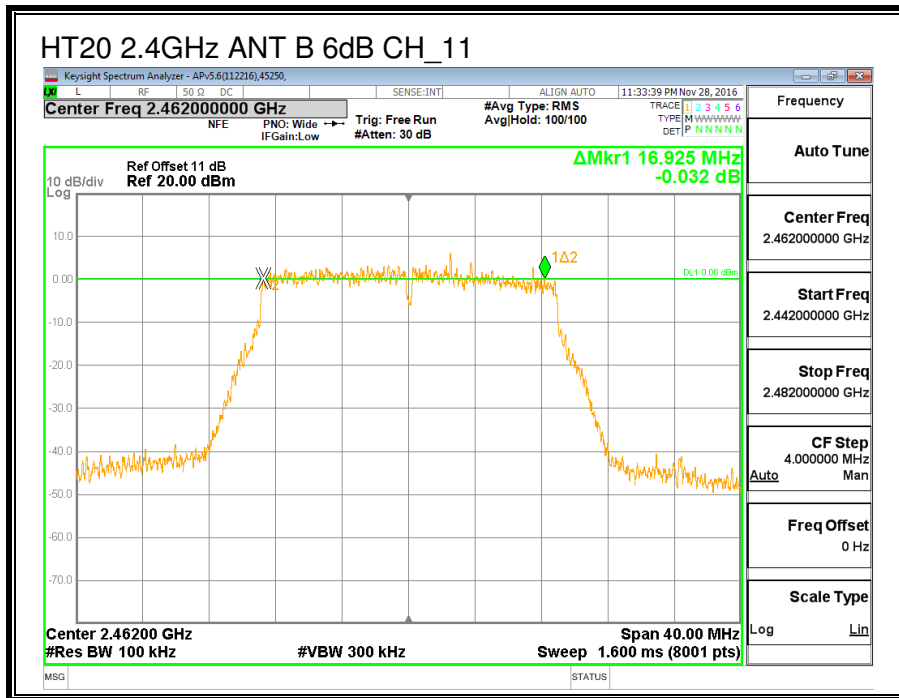
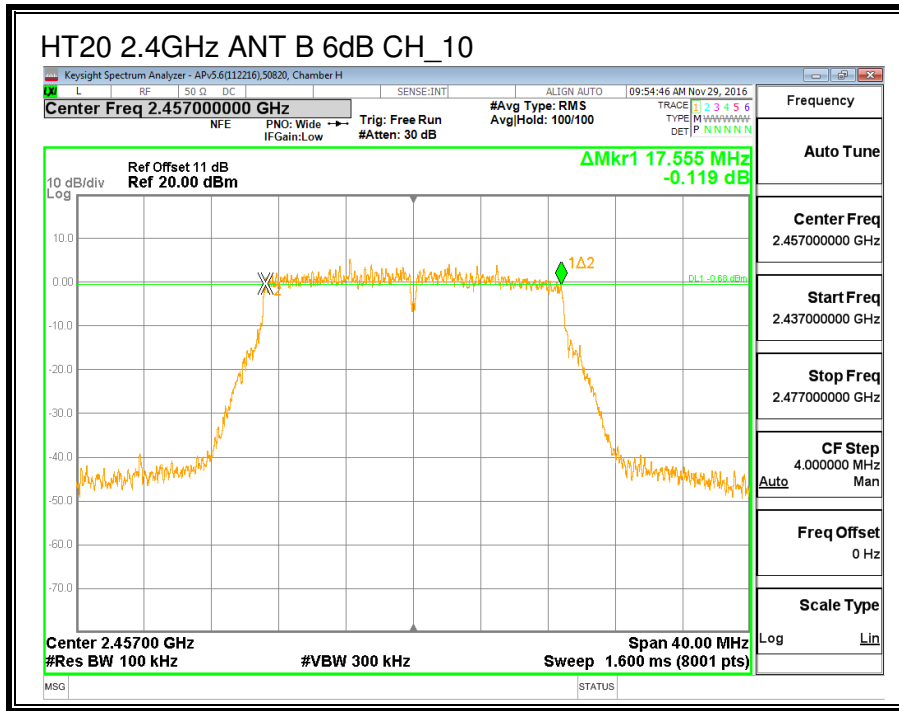

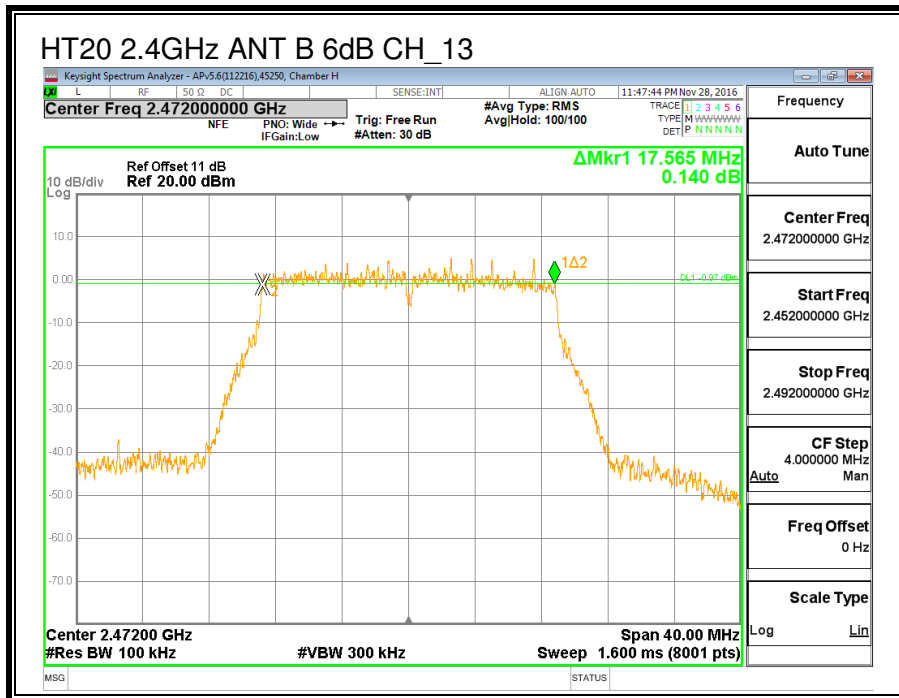
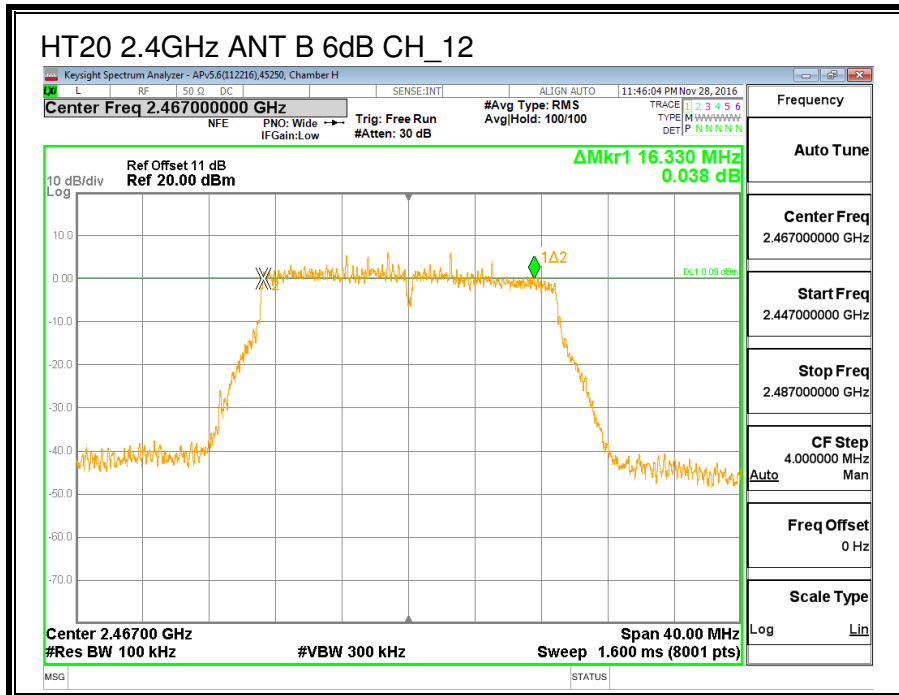

8.4.2. 99% BANDWIDTH

LIMITS

None; for reporting purposes only.

RESULTS

Channel	Frequency (MHz)	99% Bandwidth ANT B (MHz)
Low_1	2412	17.692
Middle_6	2437	17.805
High_10	2457	17.729
High_11	2462	17.786
High_12	2467	17.682
High_13	2472	17.737

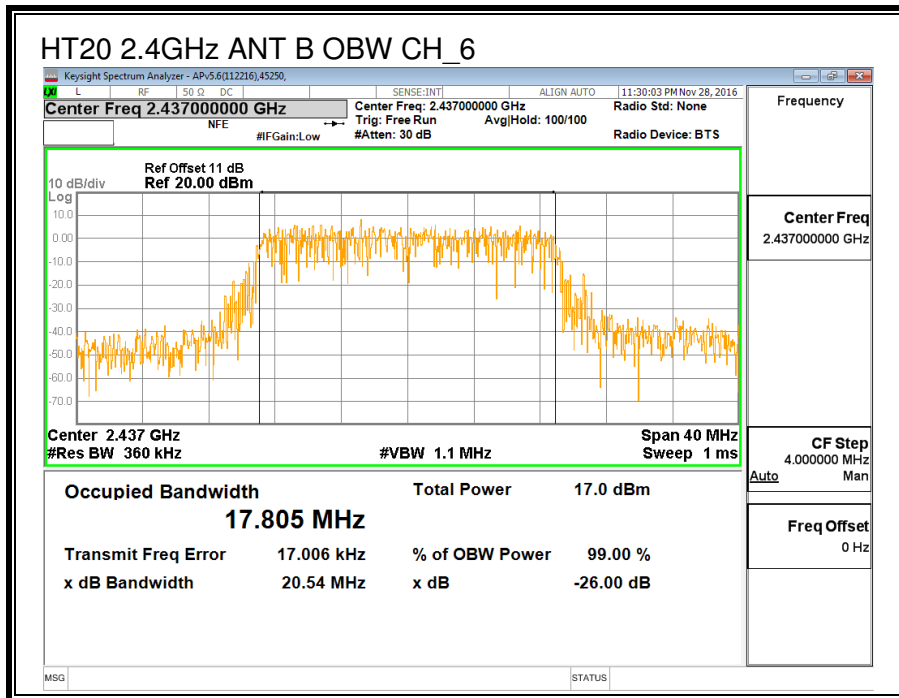
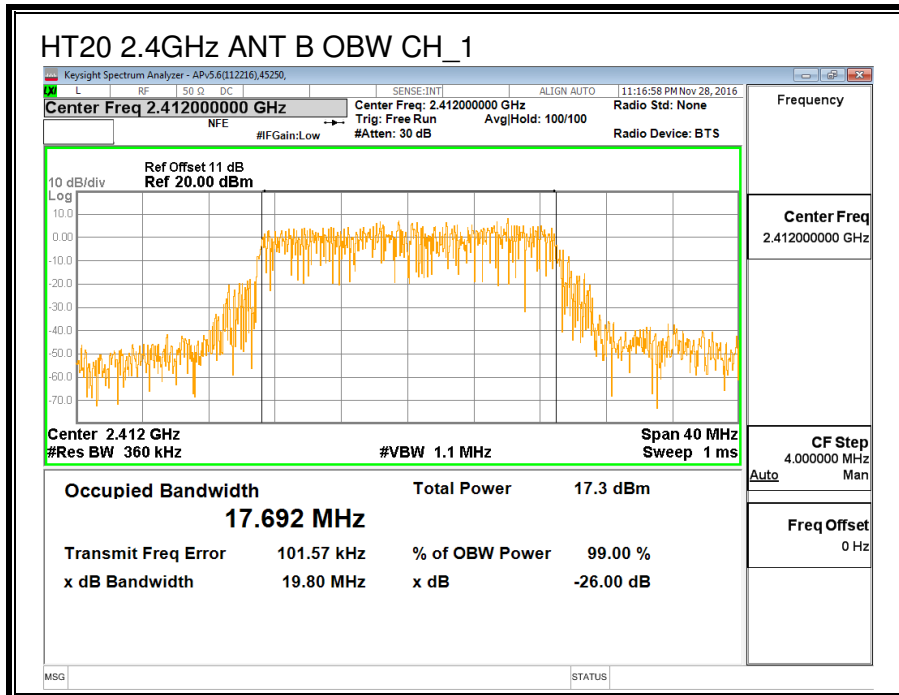

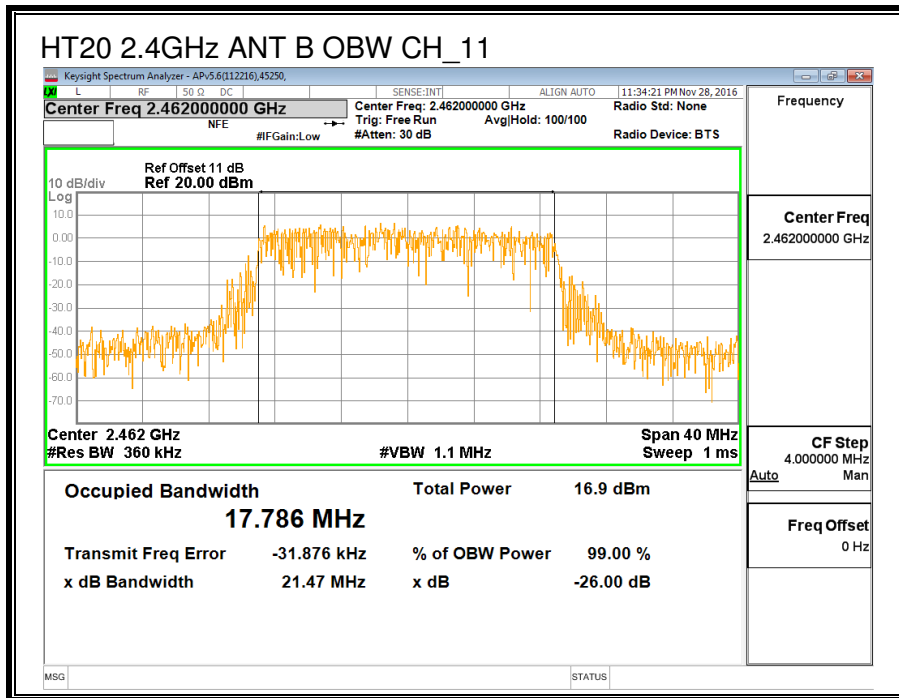
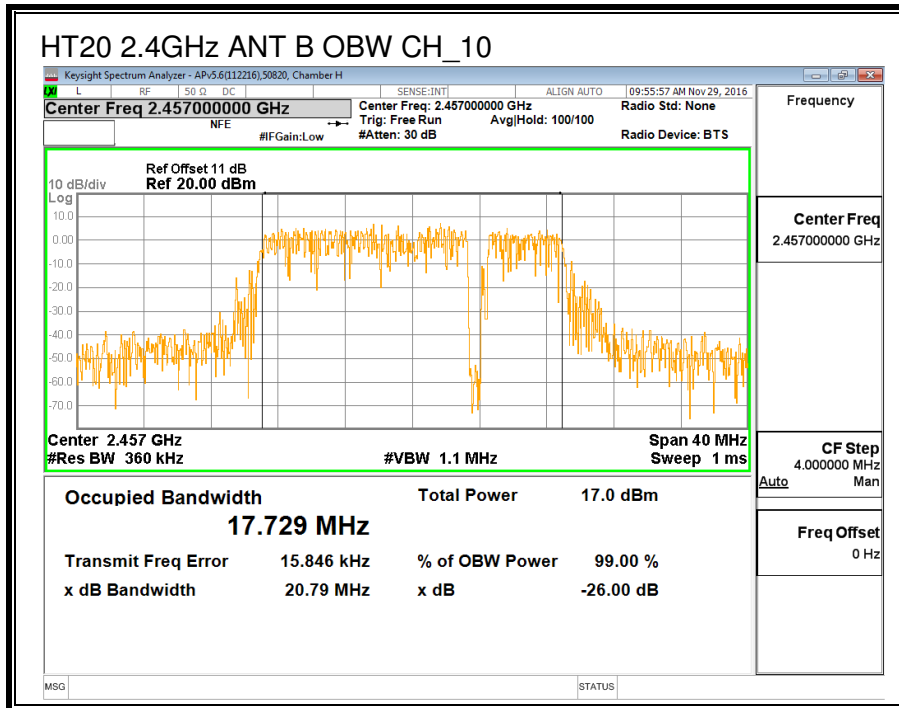

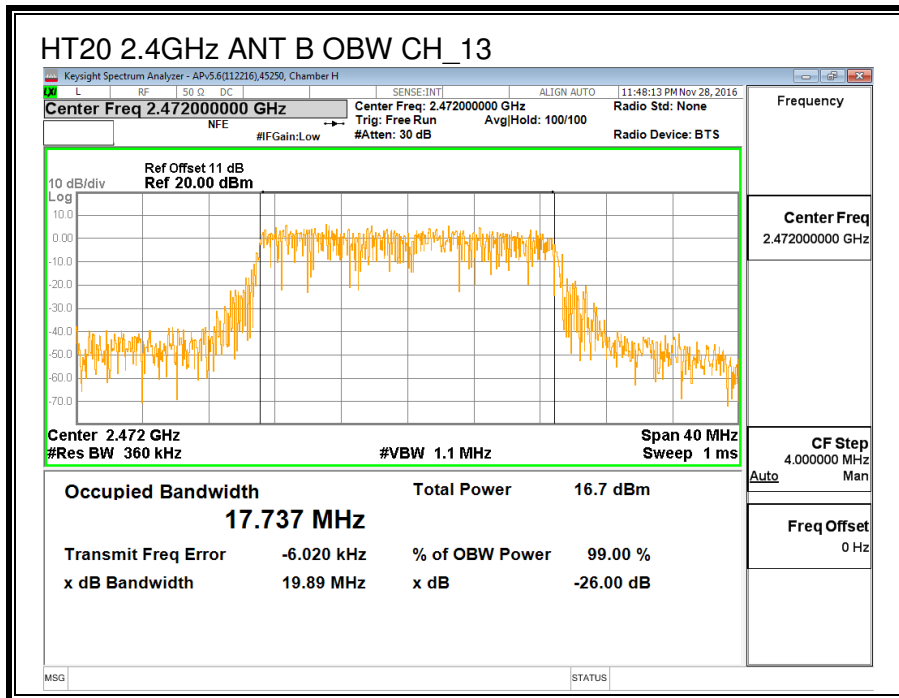
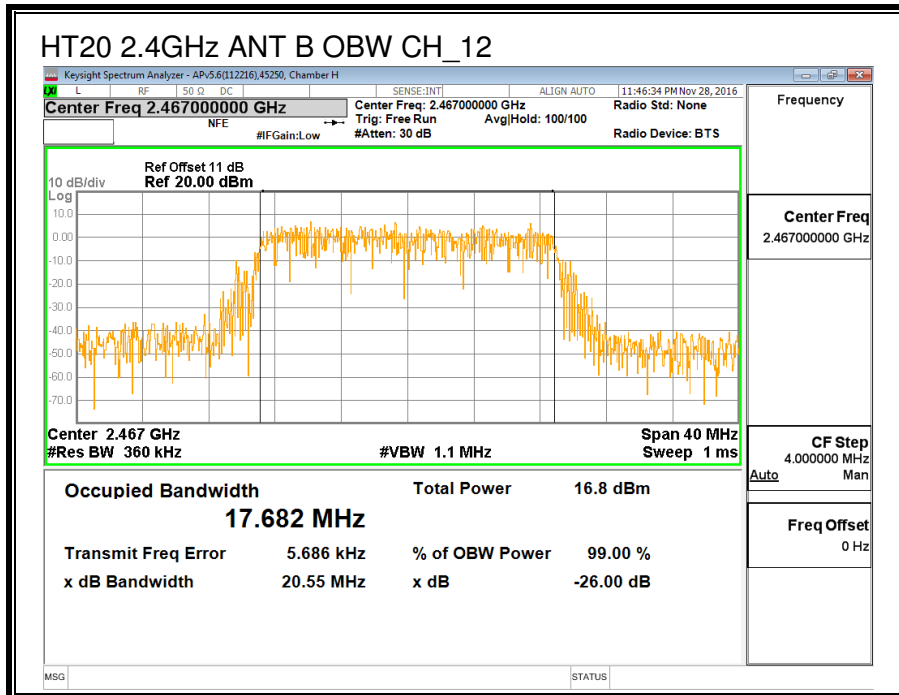

8.4.3. AVERAGE POWER

ID:	38602	Date:	2-2-2017
------------	-------	--------------	----------

LIMITS

None; for reporting purposes only.

RESULTS

Channel	Frequency (MHz)	Power ANT B (MHz)
Low_1	2412	15.92
Middle_6	2437	15.93
High_10	2457	15.76
High_11	2462	13.28
High_12	2467	11.30
High_13	2472	1.34

8.4.4. OUTPUT POWER

ID:	38602	Date:	2-2-2017
------------	-------	--------------	----------

LIMITS

FCC §15.247

IC RSS-247 (5.4) (4)

For systems using digital modulation in the 2400–2483.5 MHz, and 5725–5850 MHz bands: 1 Watt, based on the use of antennas with directional gains that do not exceed 6 dBi. If transmitting antennas of directional gain greater than 6 dBi are used, the conducted output power from the intentional radiator shall be reduced by the amount in dB that the directional gain of the antenna exceeds 6 dBi.

DIRECTIONAL ANTENNA GAIN

There is only one transmitter output therefore the directional gain is equal to the antenna gain.

RESULTS

Limits

Channel	Frequency (MHz)	Directional Gain (dBi)	FCC Power Limit (dBm)	IC Power Limit (dBm)	IC EIRP Limit (dBm)	Max Power (dBm)
Low	2412	-0.99	30.00	30	36	30.00
Mid	2437	-0.99	30.00	30	36	30.00
High_10	2457	-0.99	30.00	30	36	30.00
High_11	2462	-0.99	30.00	30	36	30.00
High_12	2467	-0.99	30.00	30	36	30.00
High_13	2472	-0.99	30.00	30	36	30.00

Duty Cycle CF (dB)	0.00	Included in Calculations of Corr'd Power
---------------------------	------	---

Results

Channel	Frequency (MHz)	Meas Power (dBm)	Total Corr'd Power (dBm)	Power Limit (dBm)	Margin (dB)
Low	2412	19.93	19.93	30.00	-10.07
Mid	2437	19.97	19.97	30.00	-10.03
High_10	2457	19.86	19.86	30.00	-10.14
High_11	2462	16.36	16.36	30.00	-13.64
High_12	2467	14.42	14.42	30.00	-15.58
High_13	2472	4.39	4.39	30.00	-25.61

8.4.5. POWER SPECTRAL DENSITY

LIMITS

FCC §15.247

IC RSS-247 (5.2) (2)

For digitally modulated systems, the power spectral density conducted from the intentional radiator to the antenna shall not be greater than 8 dBm in any 3 KHz band during any time interval of continuous transmissions.

RESULTS

Duty Cycle CF (dB)	0.00	Included in Calculations of Corr'd PSD
---------------------------	------	---

PSD Results

Channel	Frequency (MHz)	Meas (dBm)	Total Corr'd PSD (dBm)	Limit (dBm)	Margin (dB)
Low	2412	-7.723	-7.72	8.0	-15.7
Mid	2437	-9.578	-9.58	8.0	-17.6
High_10	2457	-9.939	-9.94	8.0	-17.9
High_11	2462	-8.862	-8.86	8.0	-16.9
High_12	2467	-9.940	-9.94	8.0	-17.9
High_13	2472	-22.355	-22.36	8.0	-30.4

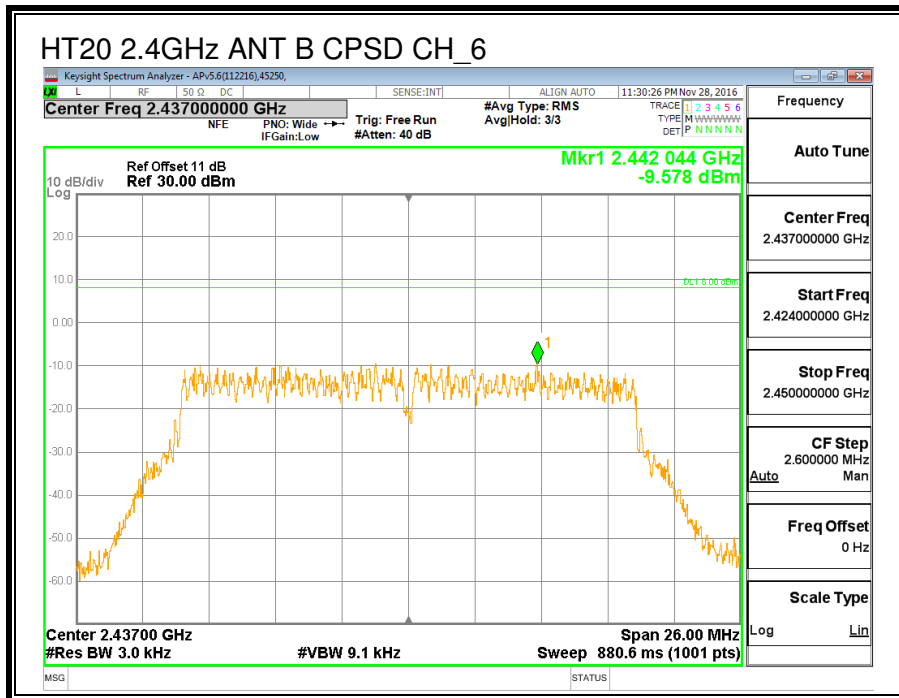
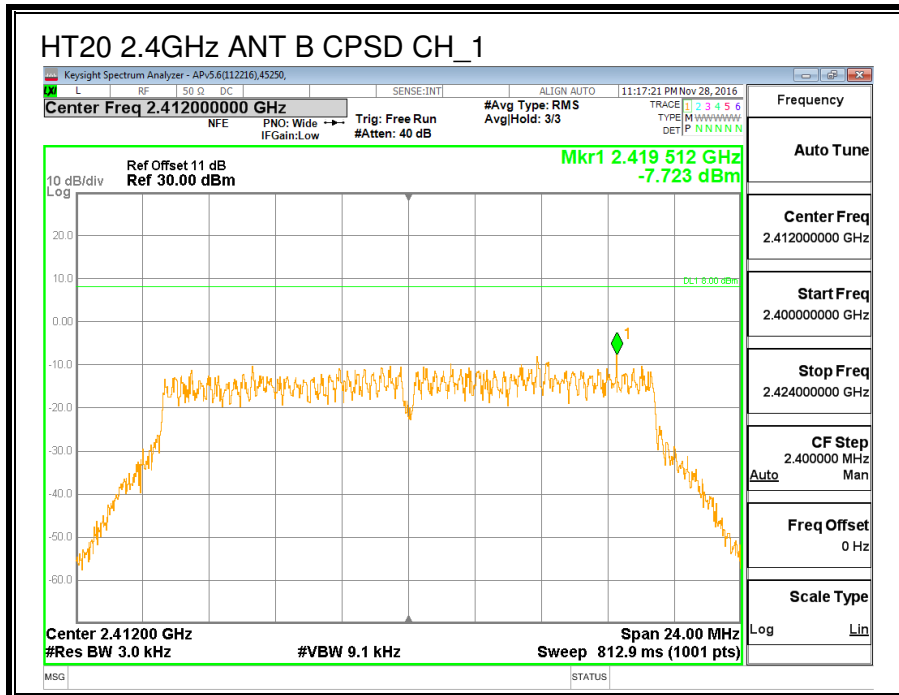

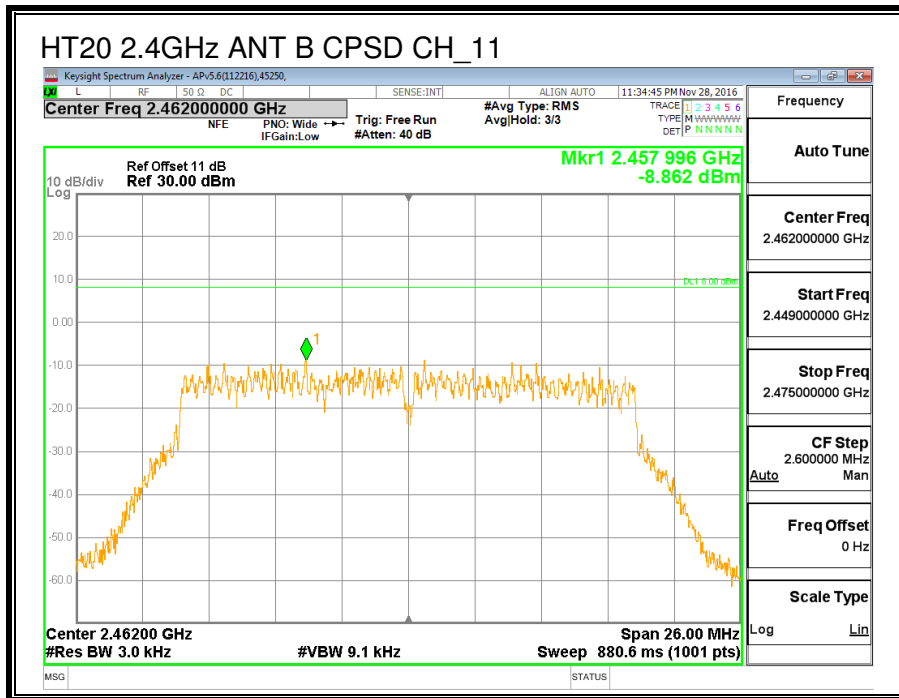
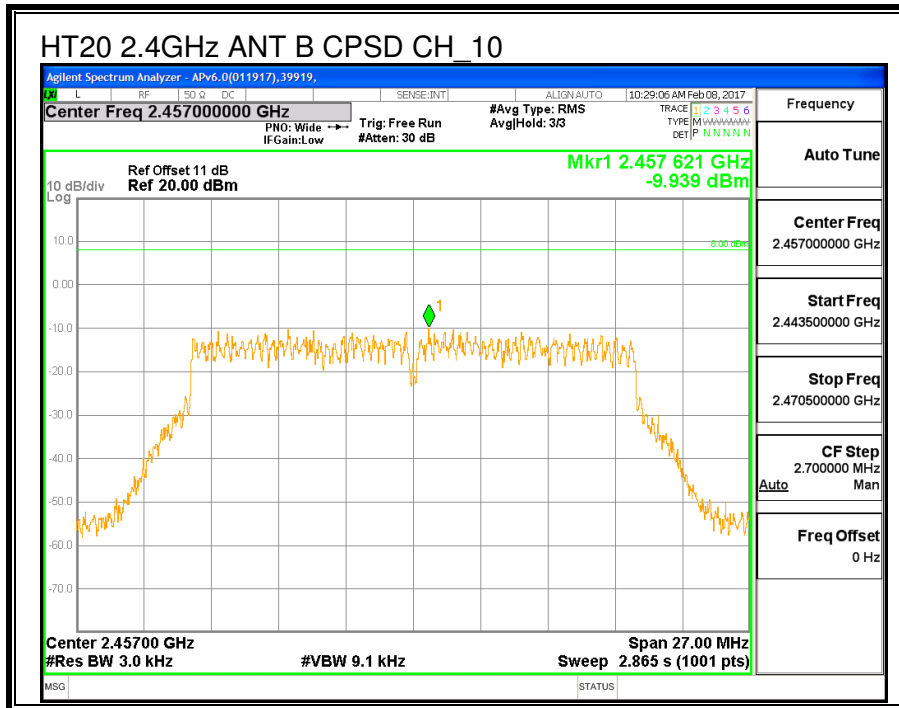

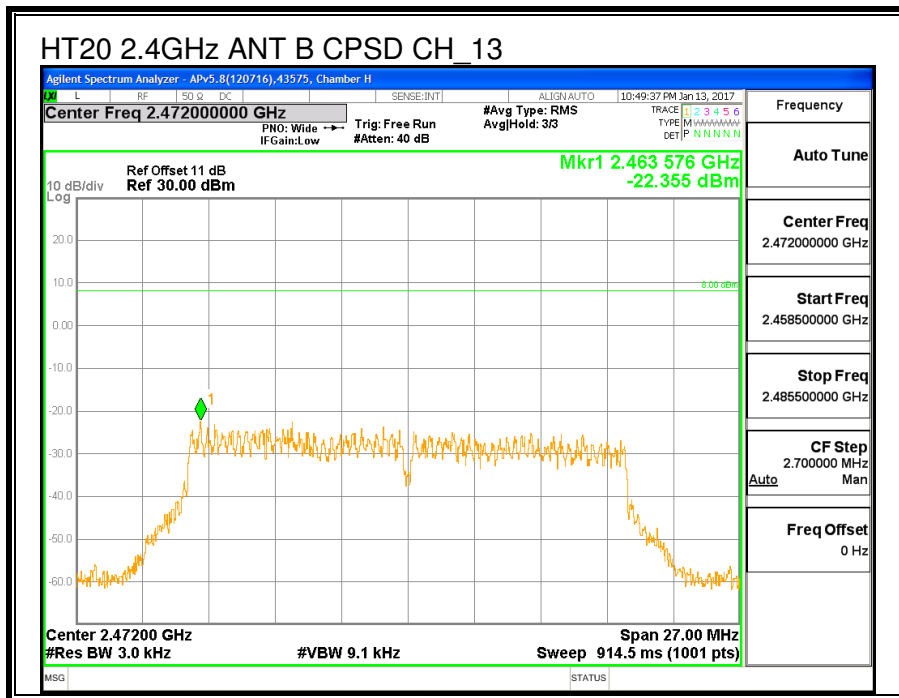
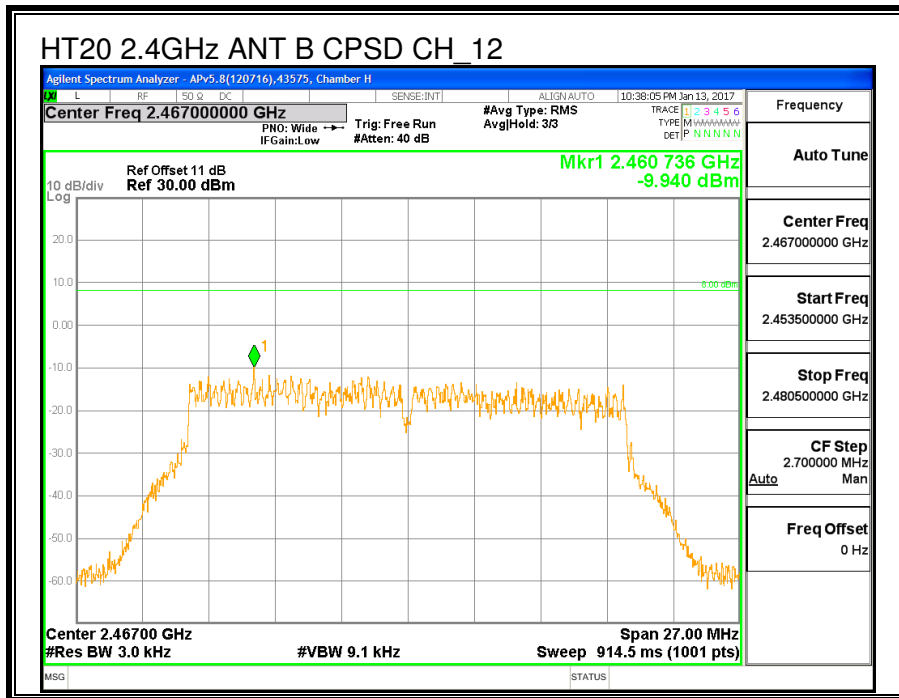

8.4.6. CONDUCTED BANDEDGE AND SPURIOUS EMISSIONS

LIMITS

FCC §15.247 (d)

IC RSS-247 (5.5)

In any 100 kHz bandwidth outside the frequency band in which the spread spectrum or digitally modulated intentional radiator is operating, the radio frequency power that is produced by the intentional radiator shall be at least 20 dB below that in the 100 kHz bandwidth within the band that contains the highest level of the desired power, based on either an RF conducted or a radiated measurement, provided the transmitter demonstrates compliance with the peak conducted power limits. If the transmitter complies with the conducted power limits based on the use of RMS averaging over a time interval, as permitted under paragraph (b)(3) of this section, the attenuation required under this paragraph shall be 30 dB instead of 20 dB. Attenuation below the general limits specified in §15.209(a) is not required.

RESULTS

LOW CHANNEL BANDEDGE

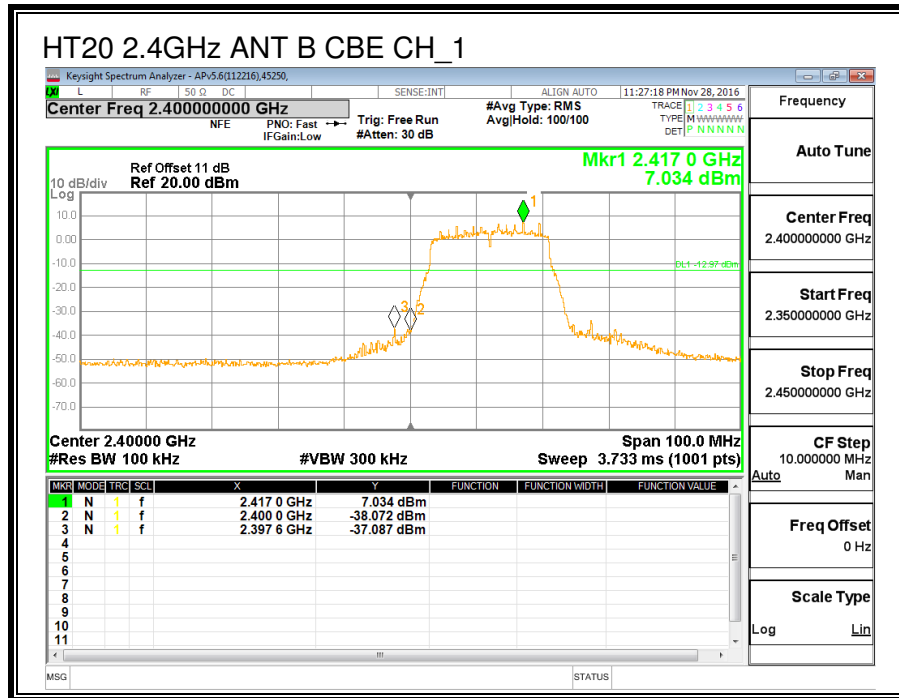

MID CHANNEL REFERENCE

