



CERTIFICATION TEST REPORT

Report Number. : 16U23816-E1V1

Applicant : APPLE, INC
1 INFINITE LOOP
CUPERTINO, CA 95014, U.S.A.

Model : A1671, A1821

FCC ID : BCGA1671

IC : 579C-A1671

EUT Description : TABLET DEVICE

Test Standard(s) : FCC 47 CFR PART 15 SUBPART C
INDUSTRY CANADA RSS - 247 ISSUE 1

Date Of Issue:
February 21, 2017

Prepared by:
UL Verification Services Inc.
47173 Benicia Street
Fremont, CA 94538, U.S.A.
TEL: (510) 771-1000
FAX: (510) 661-0888

NVLAP[®]
TESTING
NVLAP LAB CODE 200065-0

Revision History

<u>Rev.</u>	<u>Issue Date</u>	<u>Revisions</u>	<u>Revised By</u>
V1	02/21/2017	Initial Issue	Chin Pang

TABLE OF CONTENTS

1. ATTESTATION OF TEST RESULTS	5
2. TEST METHODOLOGY	6
3. FACILITIES AND ACCREDITATION	6
4. CALIBRATION AND UNCERTAINTY	7
4.1. MEASURING INSTRUMENT CALIBRATION	7
4.2. SAMPLE CALCULATION	7
4.3. MEASUREMENT UNCERTAINTY.....	7
5. EQUIPMENT UNDER TEST	8
5.1. DESCRIPTION OF EUT	8
5.2. DESCRIPTION OF MODELS DIFFERENCES.....	8
5.3. MAXIMUM OUTPUT POWER.....	8
5.4. DESCRIPTION OF AVAILABLE ANTENNAS	8
5.5. SOFTWARE AND FIRMWARE.....	8
5.6. WORST-CASE CONFIGURATION AND MODE.....	9
5.7. DESCRIPTION OF TEST SETUP.....	10
6. TEST AND MEASUREMENT EQUIPMENT	16
7. ANTENNA PORT TEST RESULTS	17
7.1. MEASUREMENT METHODS	17
7.2. ON TIME, DUTY CYCLE	18
7.3. HIGH POWER MODE.....	20
7.3.1. 6 dB BANDWIDTH.....	20
7.3.2. 99% BANDWIDTH.....	23
7.3.3. AVERAGE POWER	26
7.3.4. OUTPUT POWER	27
7.3.5. POWER SPECTRAL DENSITY	30
7.3.6. CONDUCTED BANDEDGE AND SPURIOUS EMISSIONS.....	33
7.4. LOW POWER MODE	37
7.4.1. 6 dB BANDWIDTH.....	37
7.4.2. 99% BANDWIDTH.....	40
7.4.3. AVERAGE POWER.....	43
7.4.4. OUTPUT POWER	44
7.4.5. POWER SPECTRAL DENSITY	45
7.4.6. CONDUCTED BANDEDGE AND SPURIOUS EMISSIONS.....	48
8. RADIATED TEST RESULTS.....	52
8.1. LIMITS AND PROCEDURE.....	52

8.2.	<i>HIGH POWER MODE</i>	53
8.2.1.	RESTRICTED BANDEDGE (LOW CHANNEL).....	53
8.2.2.	AUTHORIZED BANDEDGE (HIGH CHANNEL).....	55
8.2.3.	HARMONICS AND SPURIOUS EMISSIONS	57
8.3.	<i>LOW POWER MODE</i>	63
8.3.1.	RESTRICTED BANDEDGE (LOW CHANNEL).....	63
8.3.2.	AUTHORIZED BANDEDGE (HIGH CHANNEL).....	65
8.3.3.	HARMONICS AND SPURIOUS EMISSIONS	67
8.4.	<i>WORST-CASE CO-LOCATION</i>	73
8.5.	<i>WORST-CASE BELOW 1 GHz</i>	75
8.6.	<i>WORST-CASE ABOVE 18 GHz</i>	77
9.	AC POWER LINE CONDUCTED EMISSIONS	79
9.1.	<i>EUT POWERED BY AC/DC ADAPTER VIA USB CABLE</i>	80
9.2.	<i>EUT POWERED BY HOST PC VIA USB CABLE</i>	82
10.	SETUP PHOTOS	84

1. ATTESTATION OF TEST RESULTS

COMPANY NAME: APPLE
1 INFINITE LOOP
CUPERTINO, CA 95014, U.S.A.

EUT DESCRIPTION: TABLET DEVICE

MODEL: A1671, A1821

SERIAL NUMBER: DLXST016HPJQ (Conducted), DLXST00NHPJQ (Radiated)

DATE TESTED: NOVEMBER 28, 2016 – FEBRUARY 03, 2017

APPLICABLE STANDARDS	
STANDARD	TEST RESULTS
CFR 47 Part 15 Subpart C	Pass
INDUSTRY CANADA RSS-247 Issue 1	Pass
INDUSTRY CANADA RSS-GEN Issue 4	Pass

UL Verification Services Inc. tested the above equipment in accordance with the requirements set forth in the above standards. All indications of Pass/Fail in this report are opinions expressed by UL Verification Services Inc. based on interpretations and/or observations of test results. Measurement Uncertainties were not taken into account and are published for informational purposes only. The test results show that the equipment tested is capable of demonstrating compliance with the requirements as documented in this report.

Note: The results documented in this report apply only to the tested sample, under the conditions and modes of operation as described herein. This document may not be altered or revised in any way unless done so by UL Verification Services Inc. and all revisions are duly noted in the revisions section. Any alteration of this document not carried out by UL Verification Services Inc. will constitute fraud and shall nullify the document. This report must not be used by the client to claim product certification, approval, or endorsement by NVLAP, NIST, any agency of the Federal Government, or any agency of any government.

Approved & Released For
UL Verification Services Inc. By:

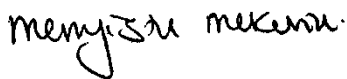

MENGISTU MEKURIA
SENIOR ENGINEER
UL VERIFICATION SERVICES INC.

Prepared By:

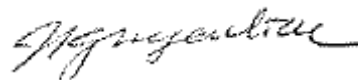

LIEU NGUYEN
TEST ENGINEER
UL VERIFICATION SERVICES INC.

2. TEST METHODOLOGY

The tests documented in this report were performed in accordance with FCC CFR 47 Part 2, FCC CFR 47 Part 15, KDB 558074 D01 v03r05, ANSI C63.10-2013, RSS-GEN Issue 4, and RSS-247 Issue 1.

3. FACILITIES AND ACCREDITATION

The test sites and measurement facilities used to collect data are located at 47173 and 47266 Benicia Street, Fremont, California, USA. Line conducted emissions are measured only at the 47173 address. The following table identifies which facilities were utilized for radiated emission measurements documented in this report. Specific facilities are also identified in the test results sections.

47173 Benicia Street	47266 Benicia Street
<input type="checkbox"/> Chamber A (IC:2324B-1)	<input checked="" type="checkbox"/> Chamber D (IC:2324B-4)
<input type="checkbox"/> Chamber B (IC:2324B-2)	<input type="checkbox"/> Chamber E (IC:2324B-5)
<input type="checkbox"/> Chamber C (IC:2324B-3)	<input checked="" type="checkbox"/> Chamber F (IC:2324B-6)
	<input type="checkbox"/> Chamber G (IC:2324B-7)
	<input type="checkbox"/> Chamber H (IC:2324B-8)

The above test sites and facilities are covered under FCC Test Firm Registration # 208313.

UL Verification Services Inc. is accredited by NVLAP, Laboratory Code 200065-0. The full scope of accreditation can be viewed at <http://ts.nist.gov/standards/scopes/2000650.htm>.

4. CALIBRATION AND UNCERTAINTY

4.1. MEASURING INSTRUMENT CALIBRATION

The measuring equipment utilized to perform the tests documented in this report has been calibrated in accordance with the manufacturer's recommendations, and is traceable to recognized national standards.

4.2. SAMPLE CALCULATION

Where relevant, the following sample calculation is provided:

$$\begin{aligned} \text{Field Strength (dBuV/m)} &= \text{Measured Voltage (dBuV)} + \text{Antenna Factor (dB/m)} + \\ &\text{Cable Loss (dB)} - \text{Preamp Gain (dB)} \\ 36.5 \text{ dBuV} + 18.7 \text{ dB/m} + 0.6 \text{ dB} - 26.9 \text{ dB} &= 28.9 \text{ dBuV/m} \end{aligned}$$

4.3. MEASUREMENT UNCERTAINTY

Where relevant, the following measurement uncertainty levels have been estimated for tests performed on the apparatus:

Parameter	Uncertainty
Worst Case Conducted Disturbance, 9KHz to 0.15 MHz	3.84 dB
Worst Case Conducted Disturbance, 0.15 to 30 MHz	3.65 dB
Worst Case Radiated Disturbance, 9KHz to 30 MHz	3.15 dB
Worst Case Radiated Disturbance, 30 to 1000 MHz	5.36 dB
Worst Case Radiated Disturbance, 1000 to 18000 MHz	4.32 dB
Worst Case Radiated Disturbance, 18000 to 26000 MHz	4.45 dB
Worst Case Radiated Disturbance, 26000 to 40000 MHz	5.24 dB

Uncertainty figures are valid to a confidence level of 95%.

5. EQUIPMENT UNDER TEST

5.1. DESCRIPTION OF EUT

The EUT, model number, A1670, A1821 is a tablet with multimedia functions (music, application support, and video), Cellular GSM/GPRS/EGPRS/CDMA2000 1xRTT/1x Advanced/EVDO Rev.A /WCDMA /HSPA+/DC- HSDPA/LTE FDD & Carrier Aggregation/TDD/TD-SCDMA radio, IEEE 802.11a/b/g/n/ac radio, and Bluetooth radio. The rechargeable battery is not user accessible.

5.2. DESCRIPTION OF MODELS DIFFERENCES

Both Model A1671 and A1821 have identical PCB layout, design and functionality, except that A1671 supports second electronic-UICC based SIM or “soft SIM” (called eSIM) beside the regular UICC based SIM and A1821 will come with eSIM removed. RF and electromagnetic characteristic are independent of the eSIM element. Both Models have exactly same technology and band support. Model A1671 is used for EMC/RSE Testing and that data will be used for both Models

5.3. MAXIMUM OUTPUT POWER

The transmitter has a maximum peak conducted output power as follows:

Frequency Range (MHz)	Mode	Output Power (dBm)	Output Power (mW)
2402 - 2480	BLE	17.40	54.95

5.4. DESCRIPTION OF AVAILABLE ANTENNAS

Frequency Band (GHz)	Antenna Gain (dBi)
2.4	-0.48

5.5. SOFTWARE AND FIRMWARE

The firmware installed in the EUT during testing was 14E232.

5.6. WORST-CASE CONFIGURATION AND MODE

For below 1G, 18-26GHz radiated emission, and power line conducted emissions were performed with the EUT set to transmit at the channel with highest output power as worst-case scenario.

The fundamental of the EUT was investigated in three orthogonal orientations X/Y/Z, it was determined that Y (Landscape) orientation was worst-case orientation. Therefore, all final radiated testing was performed with the EUT in Y orientation.

Worst-case data rates as provided by the client were:
Based on the baseline scan, the worst-case data rates were:

BLE: 1 Mbps.

There are two vendors of the WiFi/Bluetooth radio modules: variant 1 and variant 2. The WiFi/Bluetooth radio modules have the same mechanical outline (e.g., the same package dimension and pin-out layout), use the same on-board antenna matching circuit, have an identical antenna structure, and are built and tested to conform to the same specifications and to operate within the same tolerances.

Baseline testing was performed on the two variants to determine the worst case on all conducted power and radiated emissions.

5.7. DESCRIPTION OF TEST SETUP

SUPPORT EQUIPMENT

Support Equipment List				
Description	Manufacturer	Model	Serial Number	FCC ID
Laptop	Apple	A1286	7313700NAGW	N/A
Laptop AC/DC adapter	Apple	A1343	C062172045DDJ94A6	N/A
Earphone	Apple	NA	NA	N/A
EUT AC/DC adapter	Apple	A1357	W010A051	N/A

I/O CABLES (CONDUCTED TEST)

I/O Cable List						
Cable No	Port	# of identical ports	Connector Type	Cable Type	Cable Length (m)	Remarks
1	Antenna	1	SMA	Un-Shielded	0.2	To spectrum Analyzer
2	USB	1	USB	Shielded	1	N/A
3	AC	1	AC	Un-shielded	2	N/A

I/O CABLES (RADIATED ABOVE 1 GHZ)

I/O Cable List						
Cable No	Port	# of identical ports	Connector Type	Cable Type	Cable Length (m)	Remarks
None Used						

I/O CABLES (RADIATED BELOW 1 GHZ AND AC LINE CONDUCTED: AC/DC ADAPTER CONFIGURATION)

I/O Cable List						
Cable No	Port	# of identical	Connector Type	Cable Type	Cable Length (m)	Remarks
1	Earphone Jack	1	3.5mm Audio	Shielded	0.9	N/A
2	USB	1	USB	shielded	1	N/A

I/O CABLES (AC LINE CONDUCTED: LAPTOP CONFIGUARTION)

I/O Cable List						
Cable No	Port	# of identical	Connector Type	Cable Type	Cable Length (m)	Remarks
1	Earphone Jack	1	3.5mm Audio	Shielded	0.9	N/A
2	USB	1	USB	Shielded	1	N/A
3	AC	1	AC	Un-shielded	2	N/A

TEST SETUP - CONDUCTED TESTS

The EUT was connected to a host Laptop via USB cable adapter and spectrum analyzer to antenna port. Test software exercised the EUT.

SETUP DIAGRAM

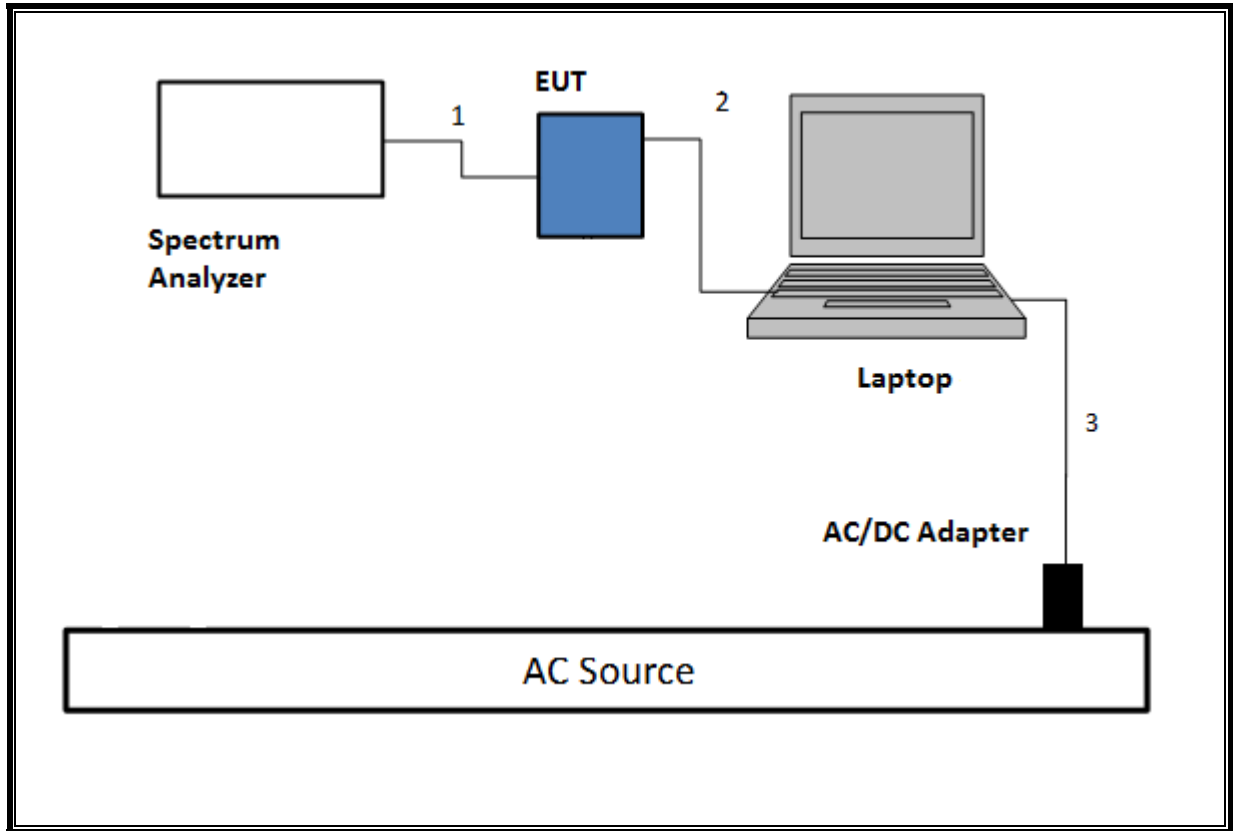

TEST SETUP- RADIATED-ABOVE 1 GHZ

The EUT was powered by battery. Test software exercised the EUT.

SETUP DIAGRAM

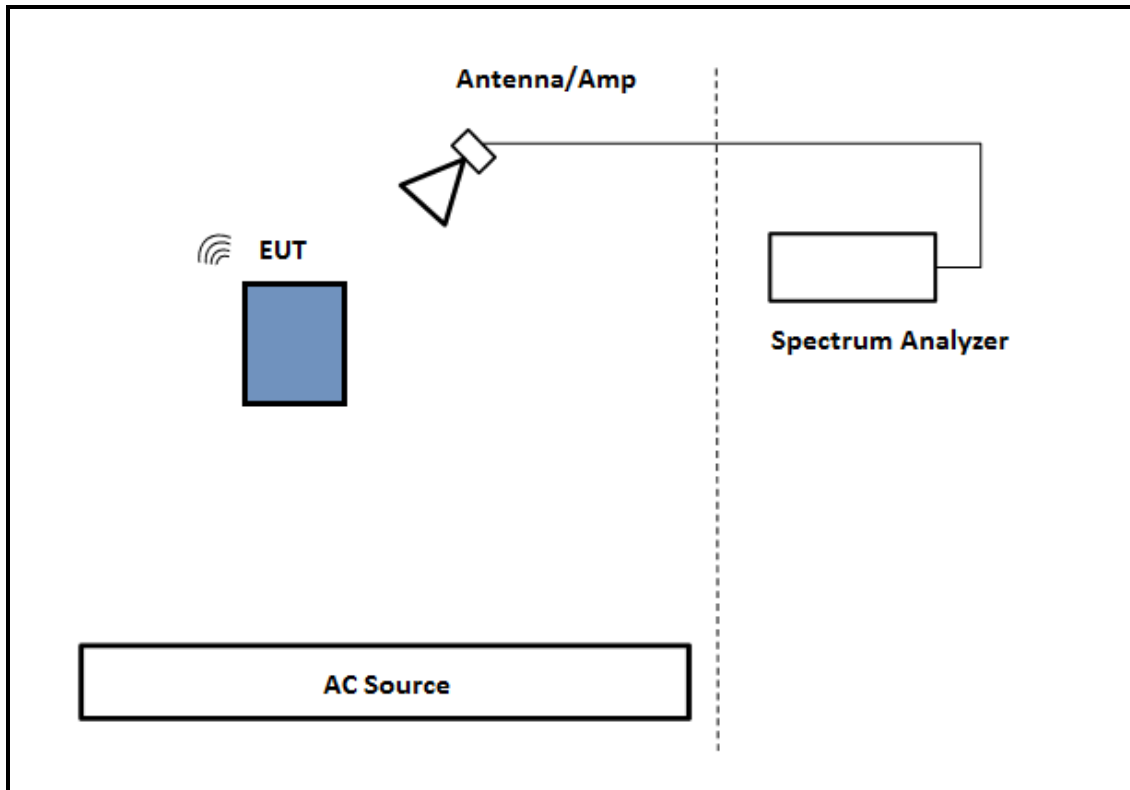

TEST SETUP- BELOW 1GHz

The EUT was powered by AC/DC adapter and connected with earphone. Test software exercised the EUT.

SETUP DIAGRAM

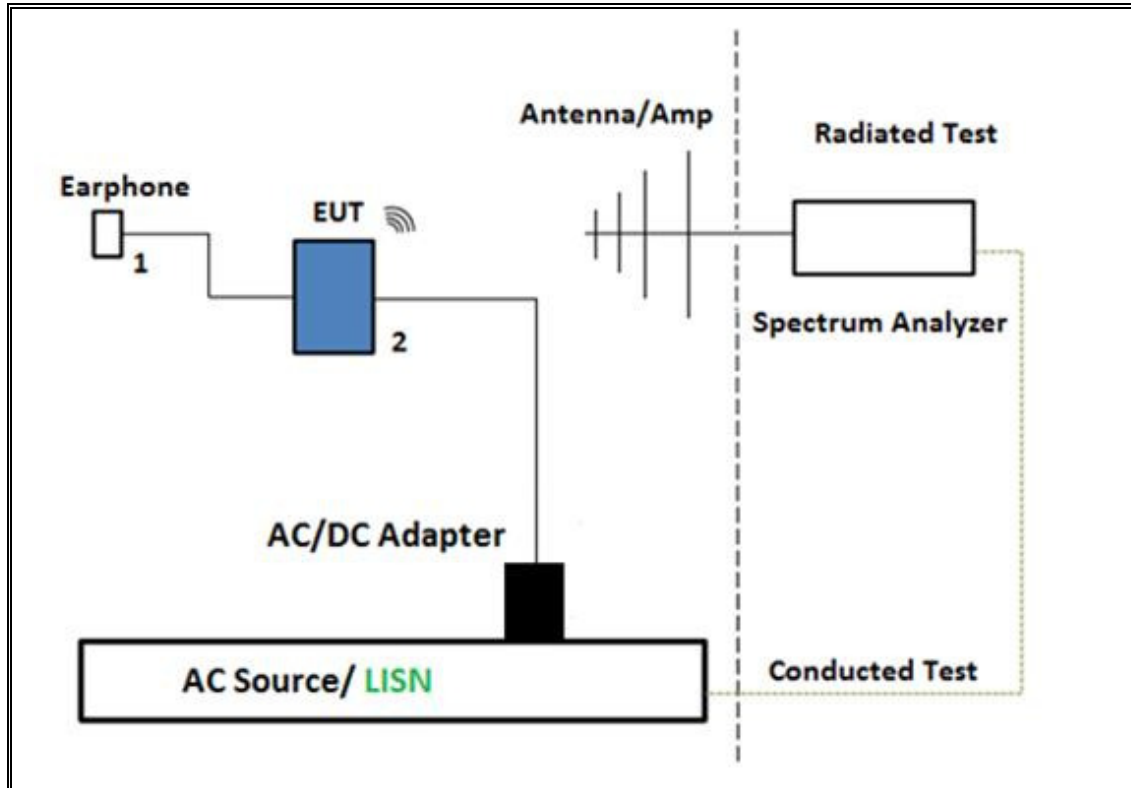

TEST SETUP- AC LINE CONDUCTED: AC/DC ADAPTER CONFIGURATION

The EUT was tested with earphone connected and powered by AC/DC adapter via USB cable. Test software exercised the EUT.

SETUP DIAGRAM

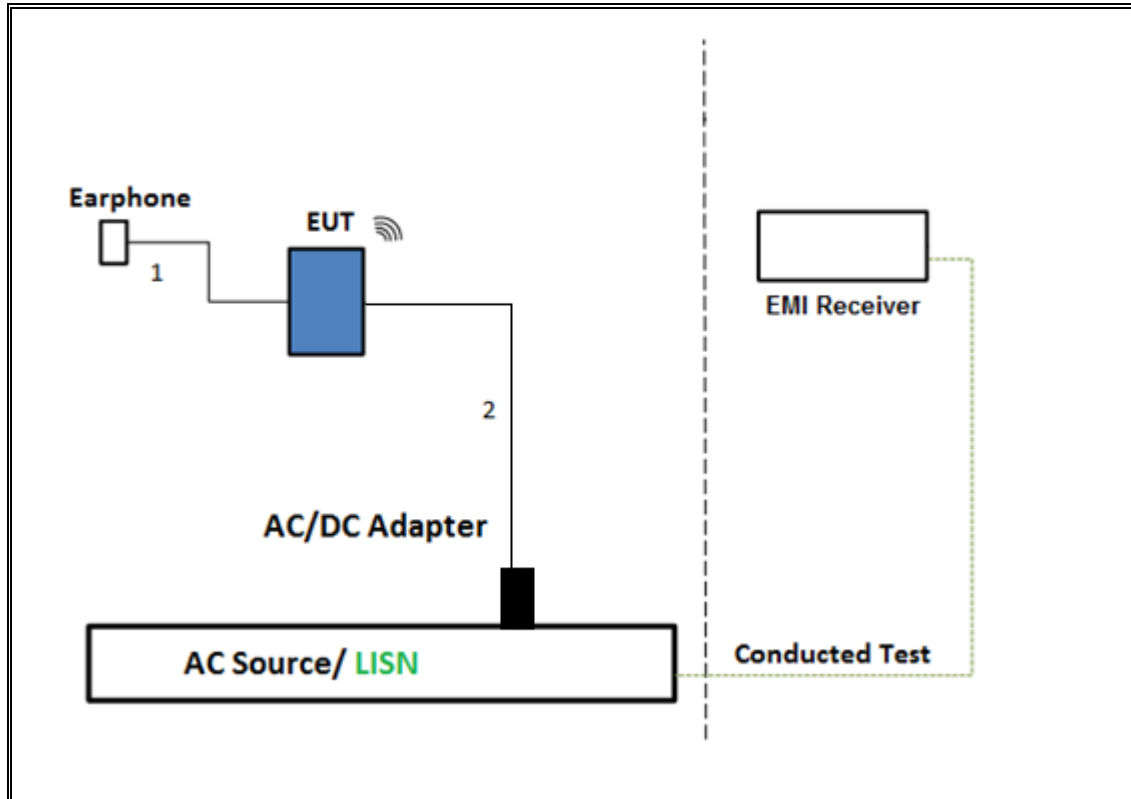

TEST SETUP- AC LINE CONDUCTED: LAPTOP CONFIGURATION

The EUT was tested with earphone connected and powered by host PC via USB cable. Test software exercised the EUT.

SETUP DIAGRAM

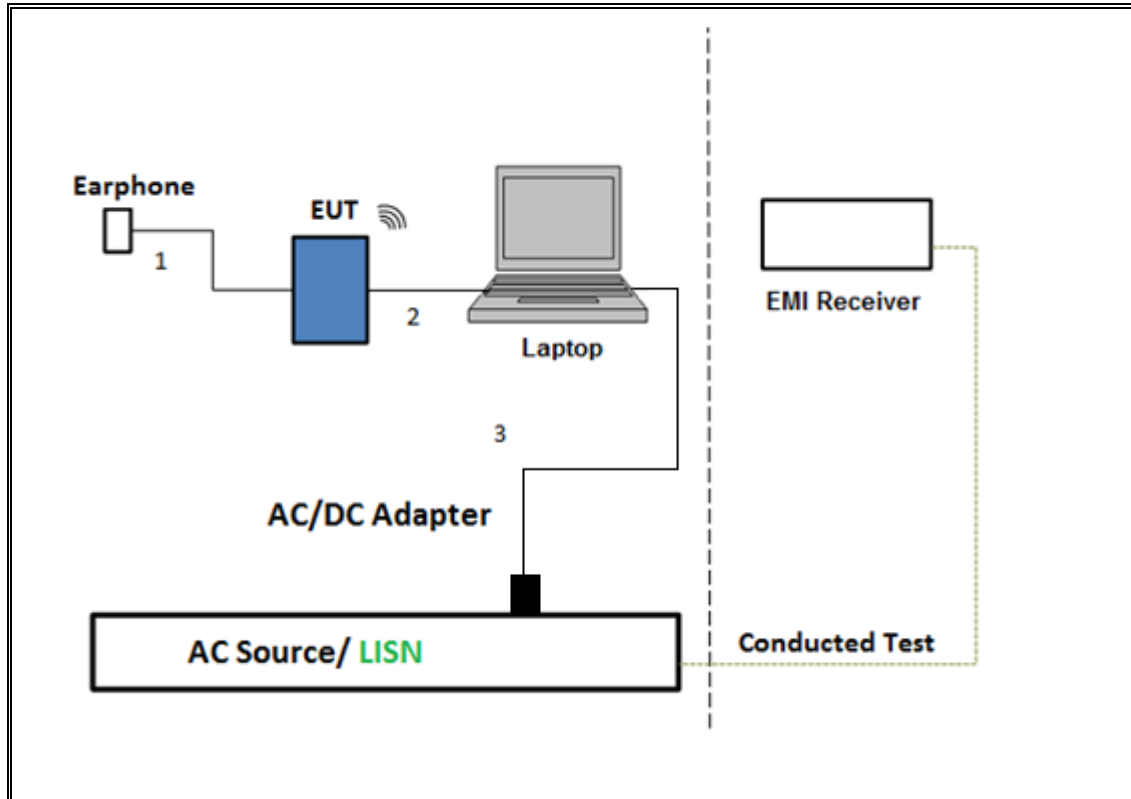

6. TEST AND MEASUREMENT EQUIPMENT

The following test and measurement equipment was utilized for the tests documented in this report:

TEST EQUIPMENT LIST				
Description	Manufacturer	Model	Asset	Cal Due
Antenna, Horn 1-18GHz	ETS Lindgren	3117	T344	2/22/2017
Antenna, Broadband Hybrid, 30MHz to 2000MHz	Sunol Sciences	JB3	T407	4/4/2017
Amplifier, 10KHz to 1GHz, 32dB	Sonoma	310N	T286	5/4/2017
Amplifier, 1 to 18GHz	Miteq	AFS42-00101800-25-S-42	T740	11/29/2017
Spectrum Analyzer, PXA 3Hz to 44GHz	Keysight	N9030A	T340	12/14/2017
Antenna, Horn 1-18GHz	ETS Lindgren	3117	T120	04/5/2017
Amplifier, 1 to 18GHz	Miteq	AFS42-00101800-25-S-42	T742	11/29/2017
Spectrum Analyzer, PXA 3Hz to 44GHz	Keysight	N9030A	T341	10/25/2017
Antenna, Broadband Hybrid, 30MHz to 2000MHz	Sunol Sciences	JB3	T899	05/26/2017
Amplifier, 10KHz to 1GHz, 32dB	Sonoma	310N	T834	06/17/2017
Spectrum Analyzer, PXA 3Hz to 44GHz	Keysight	N9030A-544	T1210	06/30/2017
Power Meter, P-series single channel	Keysight	N1912A	T1244	05/03/2017
Power Sensor	ETS LINDGREN	7002-006	T1126	02/10/2017
Power Sensor, Peak and average, 50 MHz to 18 GHz, 5 MHz BW	HEWLET PACKARD	8481A	T246	06/24/2017
Spectrum Analyzer, PXA, 3Hz to 44GHz	Keysight	N9030A	T339	09/22/2017
Spectrum Analyzer	Keysight	8564E	T106	09/07/2017
Antenna, Horn 18 to 26.5GHz	ARA	MWH-1826/B	T447	06/16/2017
Amplifier, 1 to 26.5GHz, 23.5dB Gain minimum	Keysight	8449B	T402	07/5/2017
AC Line Conducted				
*EMI Test Receiver 9KHz-7GHz	Rohde & Schwarz	ESCI7	T1436	12/19/2016
LISN for Conducted Emissions CISPR-16	Fischer	50/250-25-2-01	T1310	06/08/2017
Power Cable, Line Conducted Emissions	UL	PG1	T861	9/1/2017
UL AUTOMATION SOFTWARE				
Radiated Software	UL	UL EMC	Ver 9.5, April 26, 2016	
Conducted Software	UL	UL EMC	Ver 5.4, October 13, 2016	
AC Line Conducted Software	UL	UL EMC	Ver 9.5, May 26, 2015	

NOTE: *testing is completed before equipment calibration expiration date.

7. ANTENNA PORT TEST RESULTS

7.1. MEASUREMENT METHODS

6 dB BW: KDB 558074 D01 v03r05, Section 8.1.

Output Power: KDB 558074 D01 v03r05, Section 9.1.2.

Power Spectral Density: KDB 558074 D01 v03r05, Section 10.2.

Out-of-band emissions in non-restricted bands: KDB 558074 D01 v03r05, Section 11.0.

Out-of-band emissions in restricted bands: KDB 558074 D01 v03r05, Section 12.1.

Band-edge: KDB 558074 D01 v03r05, Section 12.1.

7.2. ON TIME, DUTY CYCLE

LIMITS

None; for reporting purposes only.

PROCEDURE

KDB 558074 Zero-Span Spectrum Analyzer Method.

ON TIME AND DUTY CYCLE RESULTS

Mode	ON Time B (msec)	Period (msec)	Duty Cycle x (linear)	Duty Cycle (%)	Duty Cycle Correction Factor (dB)	1/B Minimum VBW (khz)
BLE High Power	1.000	1.000	1.000	100%	0.00	0.010
BLE Low Power	1.000	1.000	1.000	100%	0.00	0.010

DUTY CYCLE PLOTS

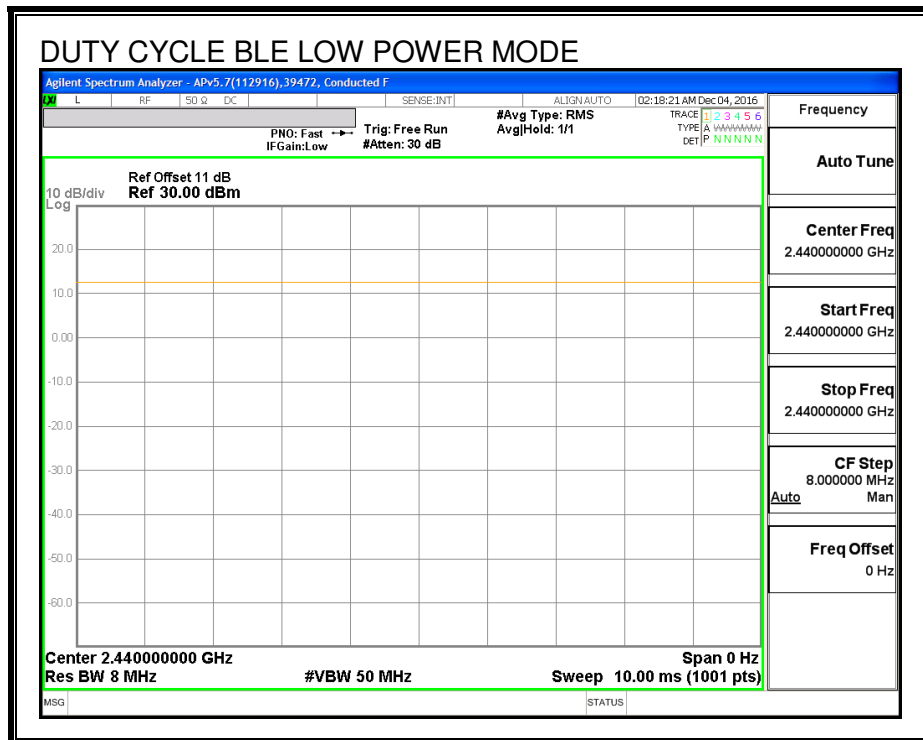
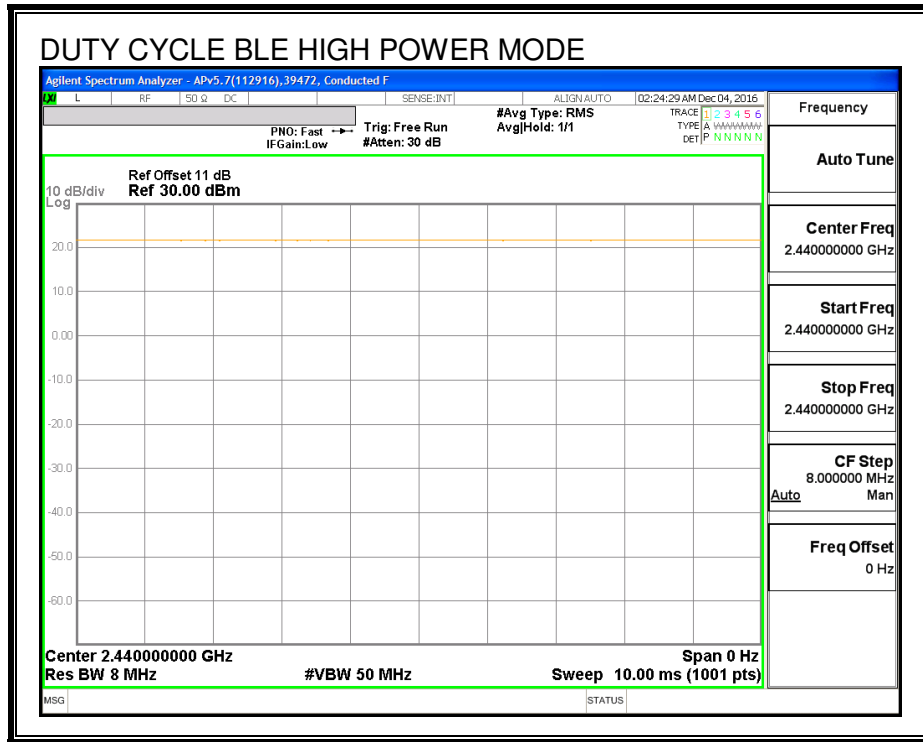

7.3. HIGH POWER MODE

7.3.1. 6 dB BANDWIDTH

LIMITS

FCC §15.247 (a) (2)

IC RSS-247 (5.2) (1)

The minimum 6 dB bandwidth shall be at least 500 kHz.

RESULTS

Channel	Frequency	6 dB Bandwidth (MHz)	Minimum Limit (MHz)
Low	2402	0.686	0.5
Middle	2440	0.688	0.5
High	2480	0.716	0.5

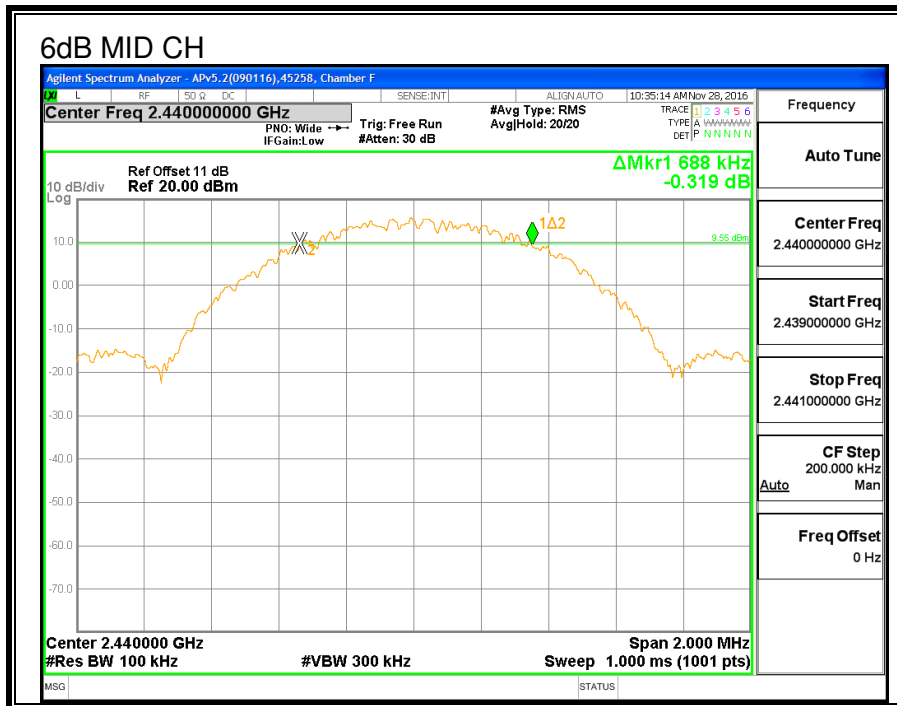
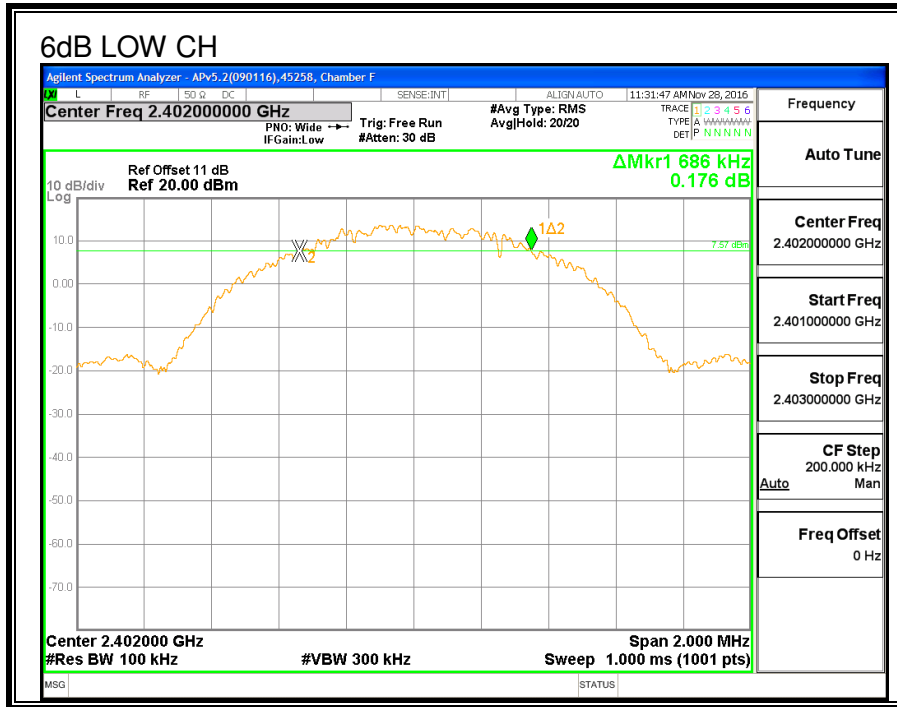

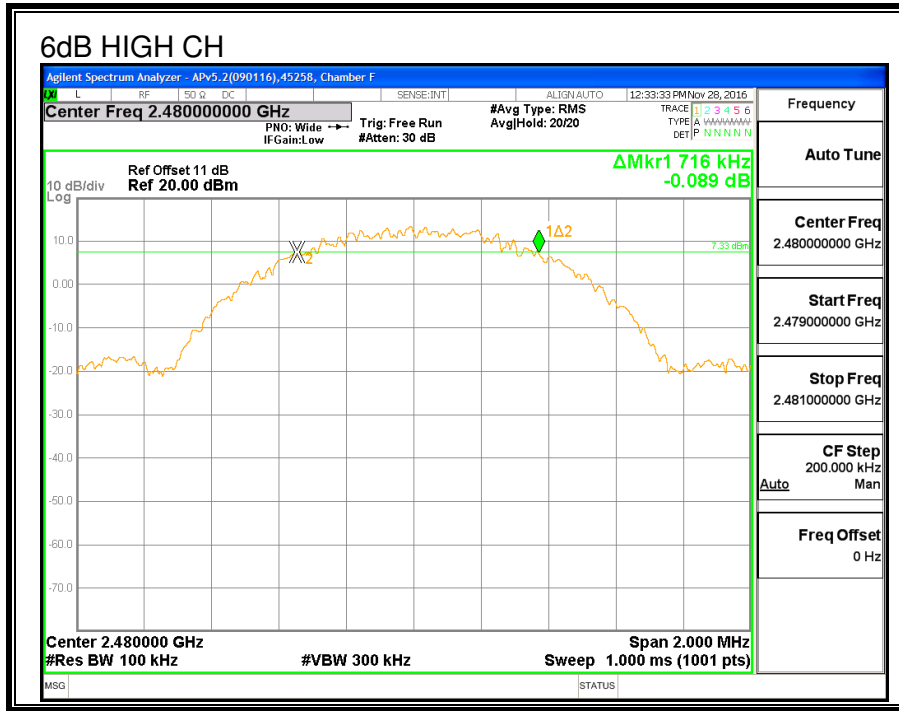

7.3.2. 99% BANDWIDTH

LIMITS

None; for reporting purposes only.

Test Procedure

The transmitter output is connected to the spectrum analyzer. The RBW is set to 1% to 3% of the 99 % bandwidth and to 1% of the span. The VBW is set to 3 times the RBW. The sweep time is coupled. The spectrum analyzer internal 99% bandwidth function is utilized.

RESULTS

Channel	Frequency (MHz)	99% Bandwidth (MHz)
Low	2402	1.0596
Middle	2440	1.0574
High	2480	1.0579

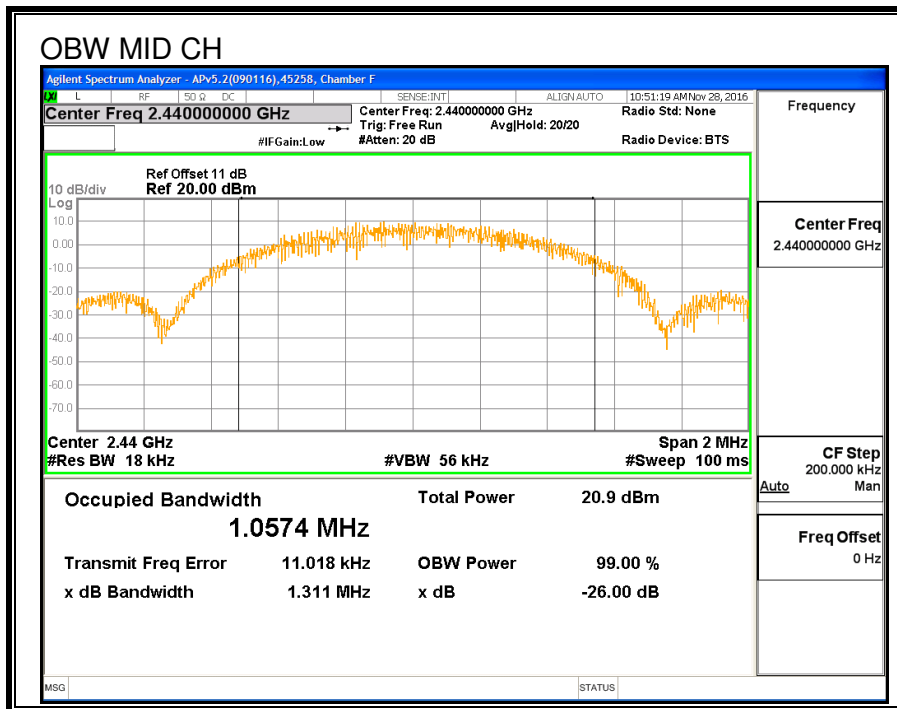
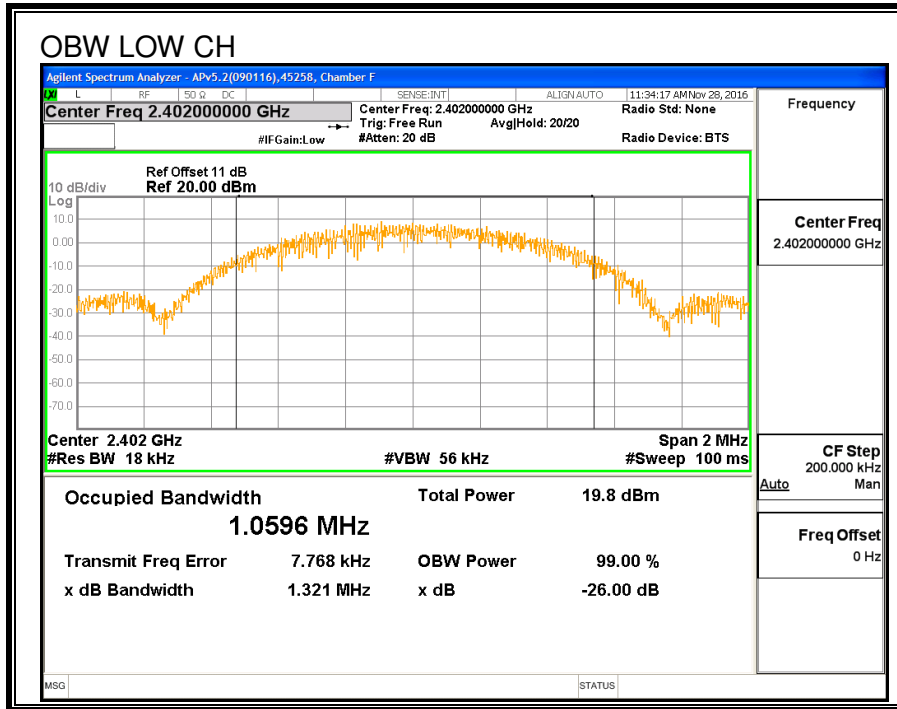

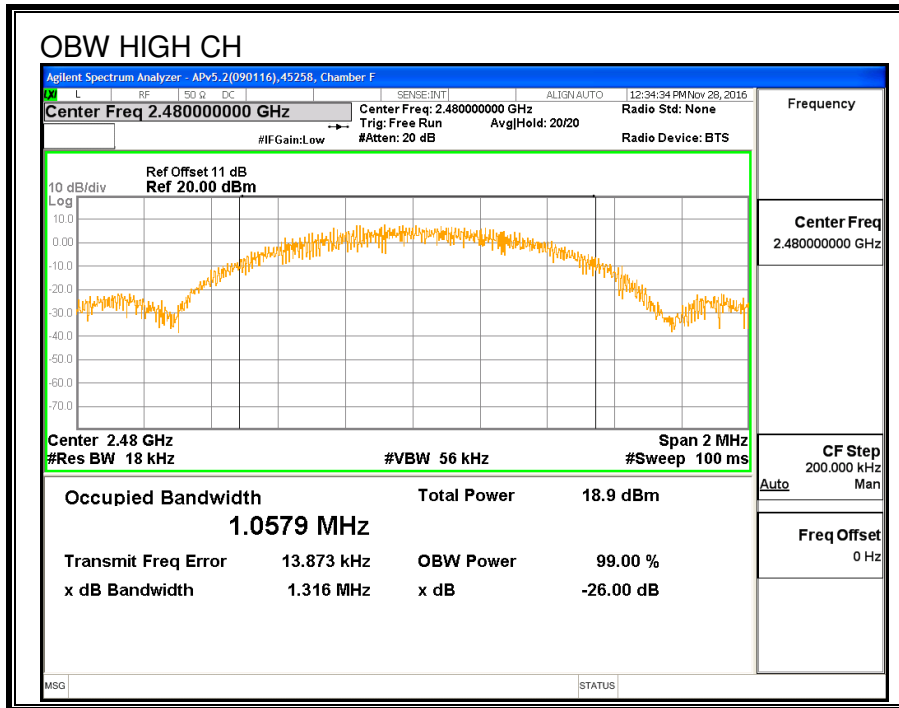

7.3.3. AVERAGE POWER

ID:	39316	Date:	2/03/2017
------------	-------	--------------	-----------

LIMITS

None; for reporting purposes only.

The cable assembly insertion loss of 11 dB (including 10 dB pad and 1 dB cable) was entered as an offset in the power meter to allow for direct reading of power.

RESULTS

Channel	Frequency (MHz)	AV Power (dBm)
Low	2402	16.80
Middle	2440	16.81
High	2480	16.54

7.3.4. OUTPUT POWER

ID:	39316	Date:	2/03/2017
------------	-------	--------------	-----------

LIMITS

FCC §15.247 (b)

IC RSS-247 (5.4) (4)

The maximum antenna gain is less than or equal to 6 dBi, therefore the limit is 30 dBm.

RESULTS

Channel	Frequency (MHz)	Peak Power Reading (dBm)	Limit (dBm)	Margin (dB)
Low	2402	17.30	30	-10.15
Middle	2440	17.40	30	-9.90
High	2480	17.00	30	-12.99

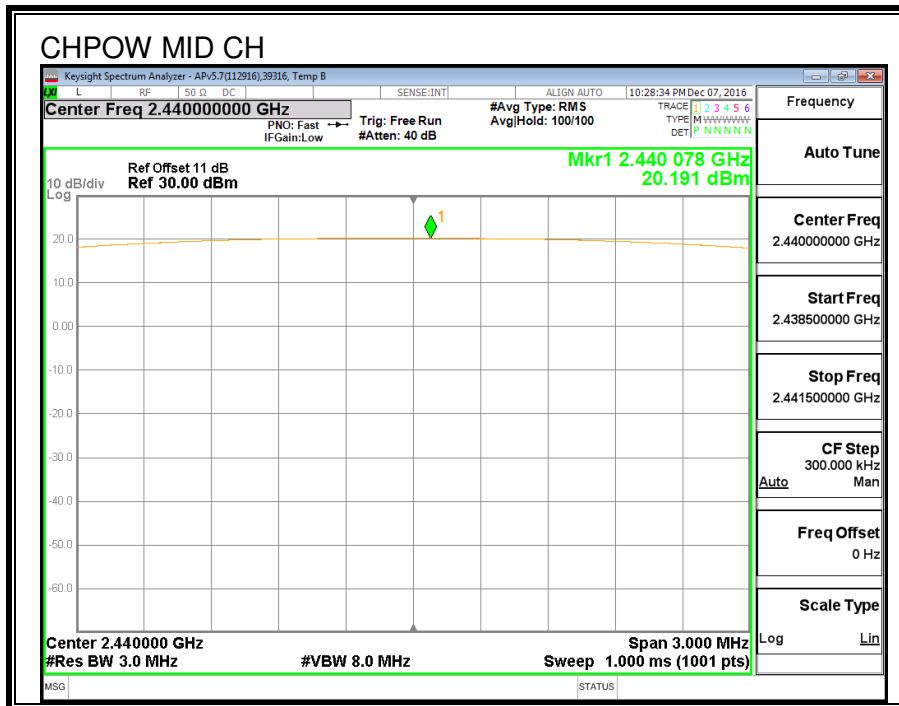
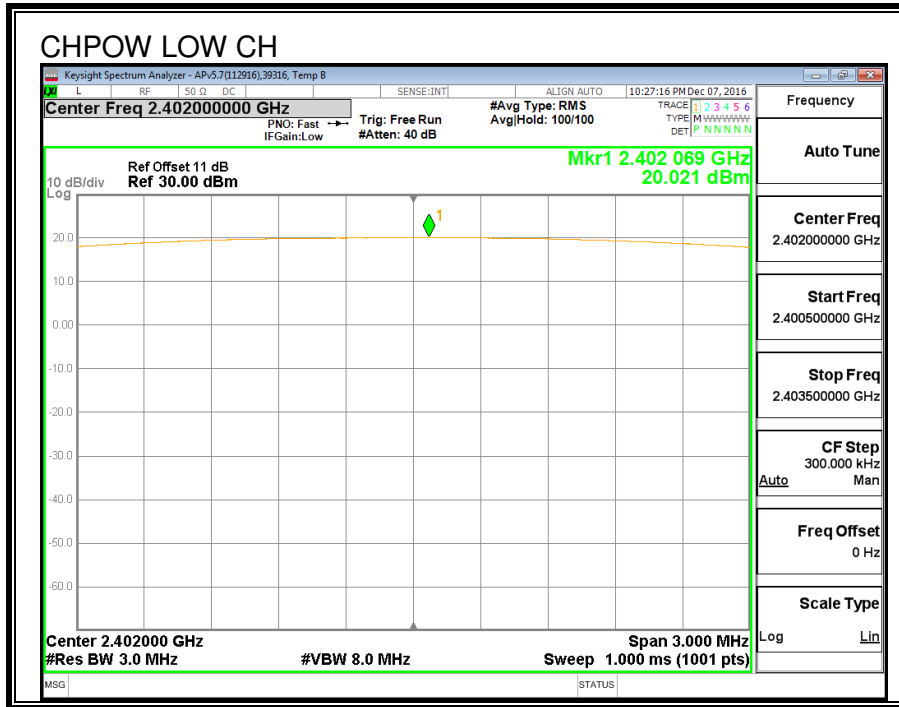

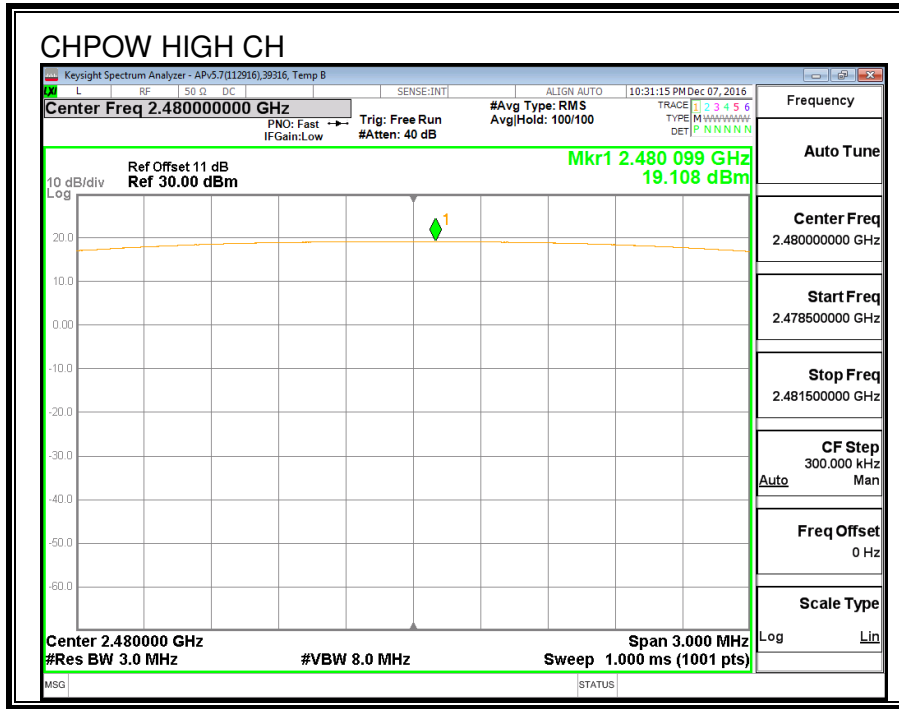

7.3.5. POWER SPECTRAL DENSITY

LIMITS

FCC §15.247 (e)

IC RSS-247 (5.2) (2)

The power spectral density conducted from the transmitter to the antenna shall not be greater than 8 dBm in any 3 kHz band during any time interval of continuous transmission.

RESULTS

Channel	Frequency (MHz)	PSD (dBm)	Limit (dBm)	Margin (dB)
Low	2402	3.289	8	-4.711
Middle	2440	4.491	8	-3.509
High	2480	2.548	8	-5.452

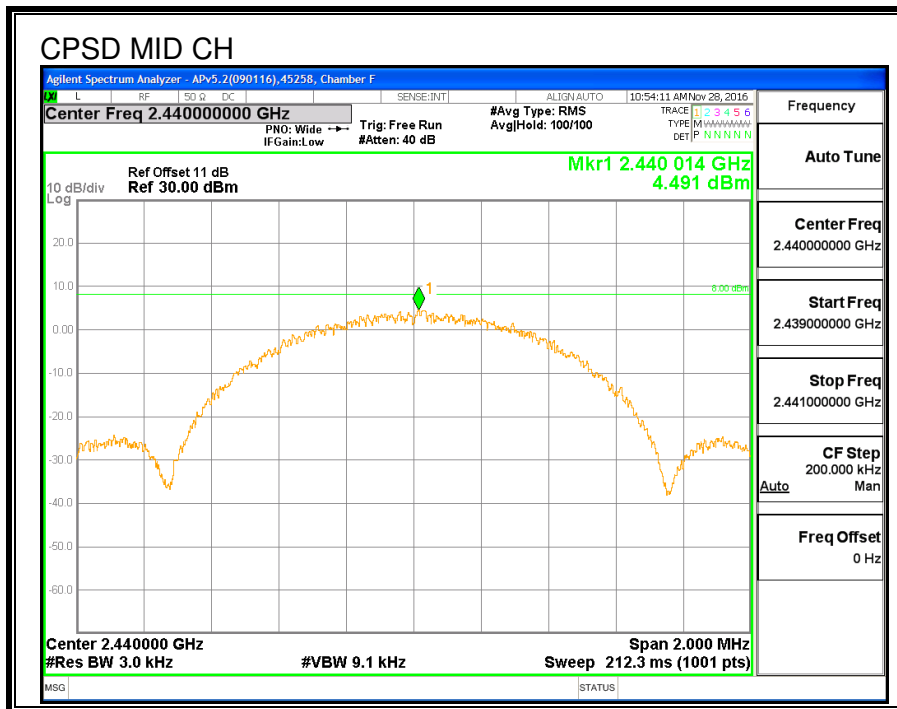
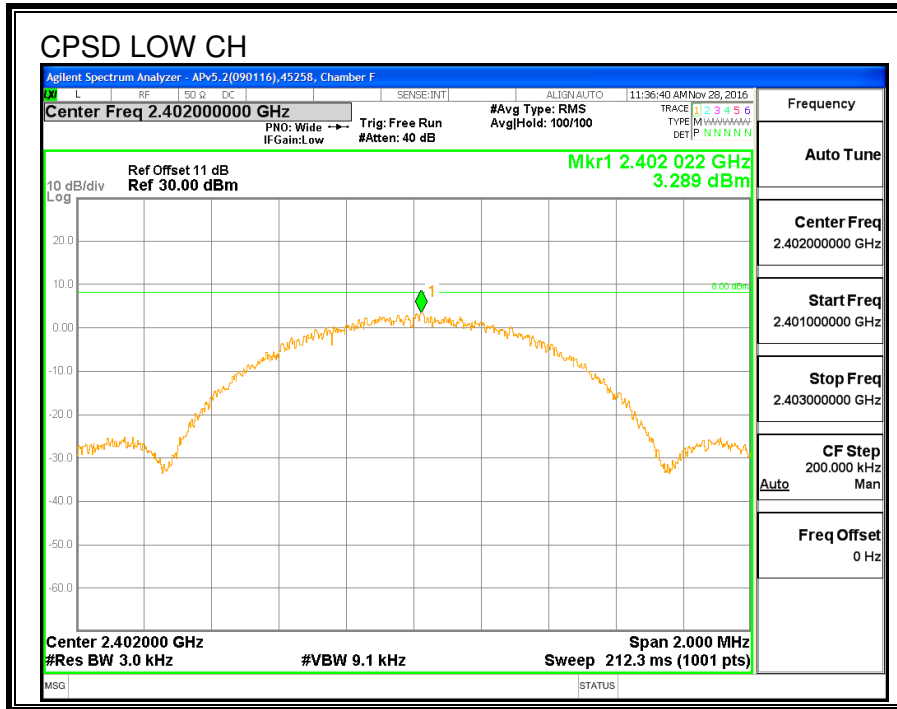

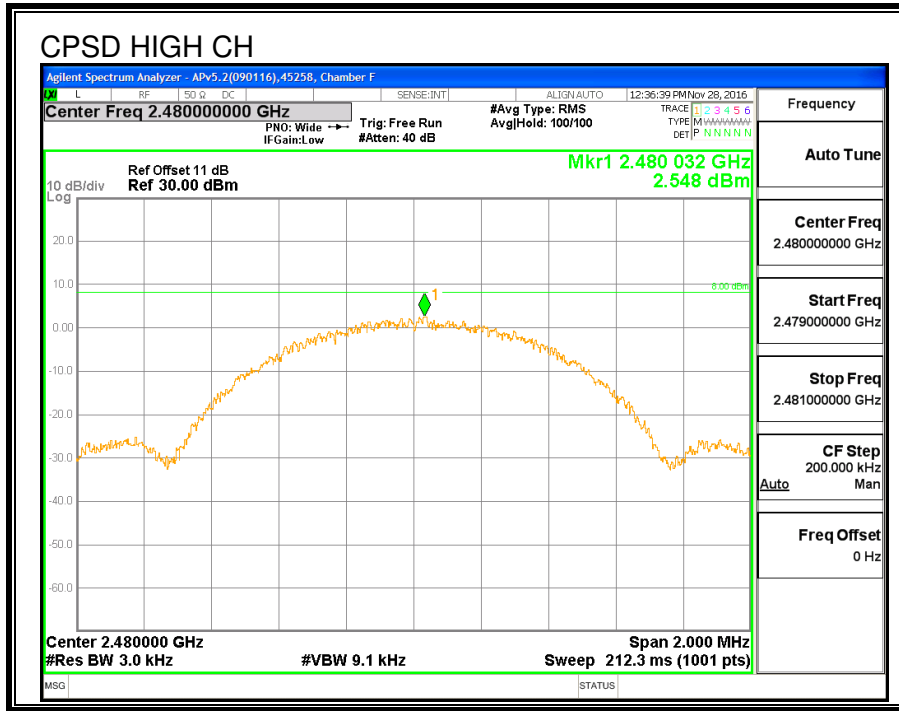

7.3.6. CONDUCTED BANDEGE AND SPURIOUS EMISSIONS

LIMITS

FCC §15.247 (d)

IC RSS-247 (5.5)

Output power was measured based on the use of a peak measurement, therefore the required attenuation is 20 dB.

RESULTS

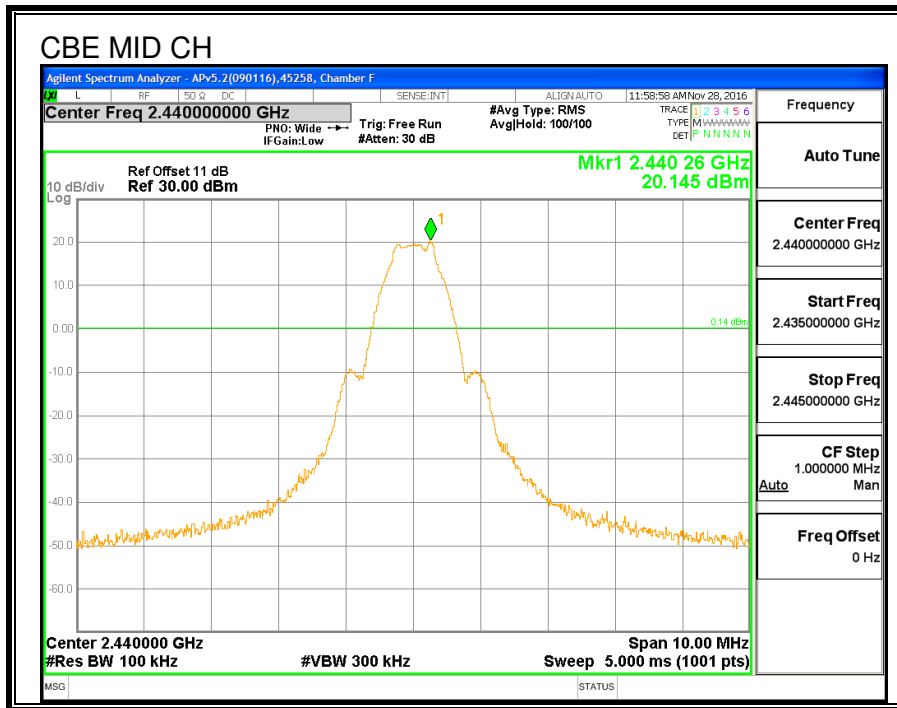
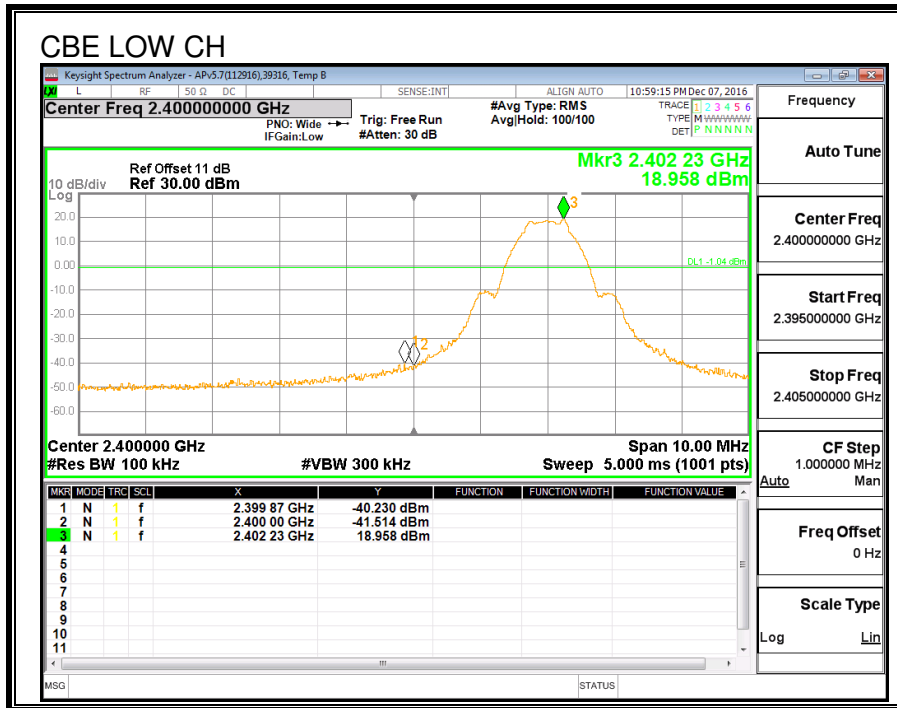

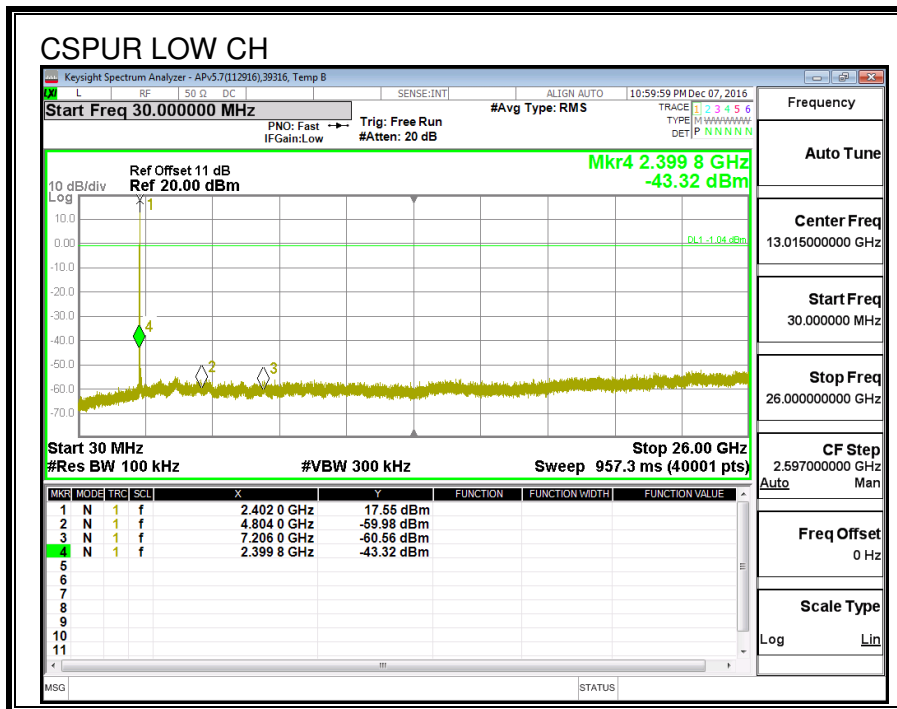
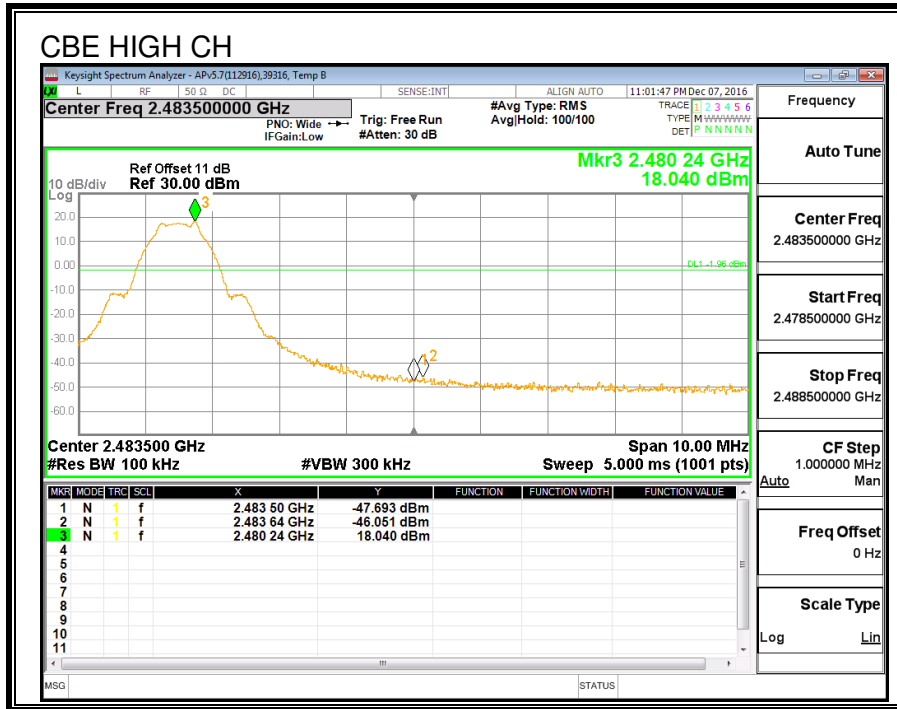

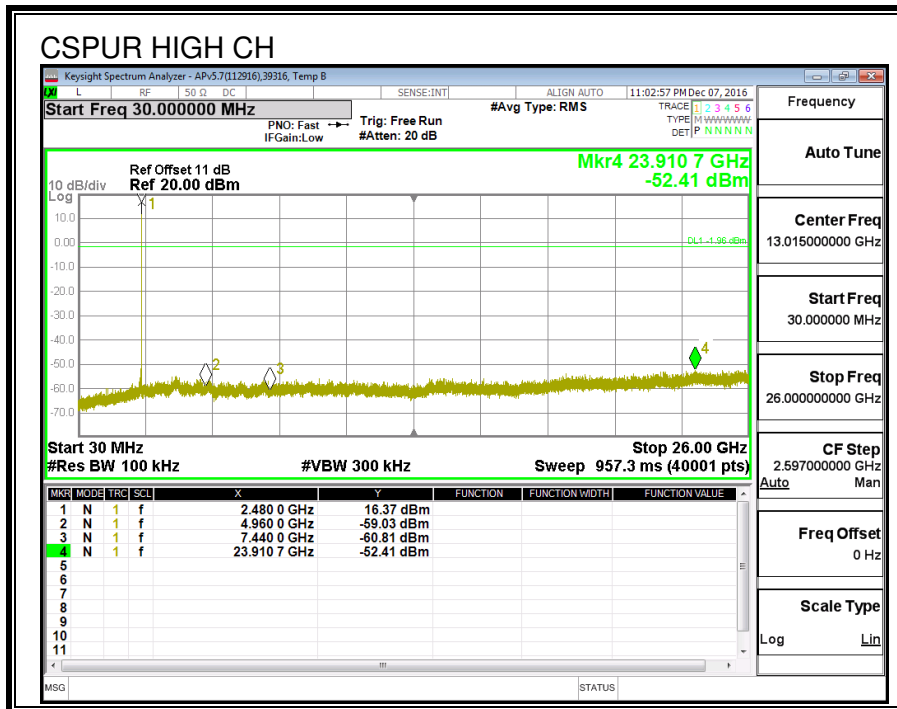
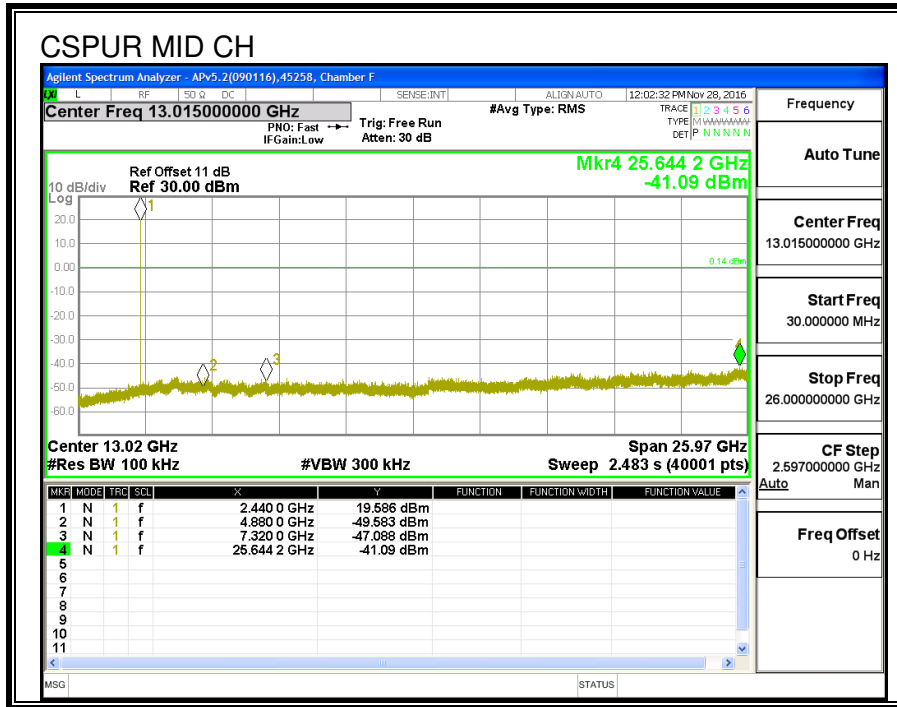

7.4. LOW POWER MODE

7.4.1. 6 dB BANDWIDTH

LIMITS

FCC §15.247 (a) (2)

IC RSS-247 (5.2) (1)

The minimum 6 dB bandwidth shall be at least 500 kHz.

RESULTS

Channel	Frequency	6 dB Bandwidth (MHz)	Minimum Limit (MHz)
Low	2402	0.726	0.5
Middle	2440	0.688	0.5
High	2480	0.728	0.5

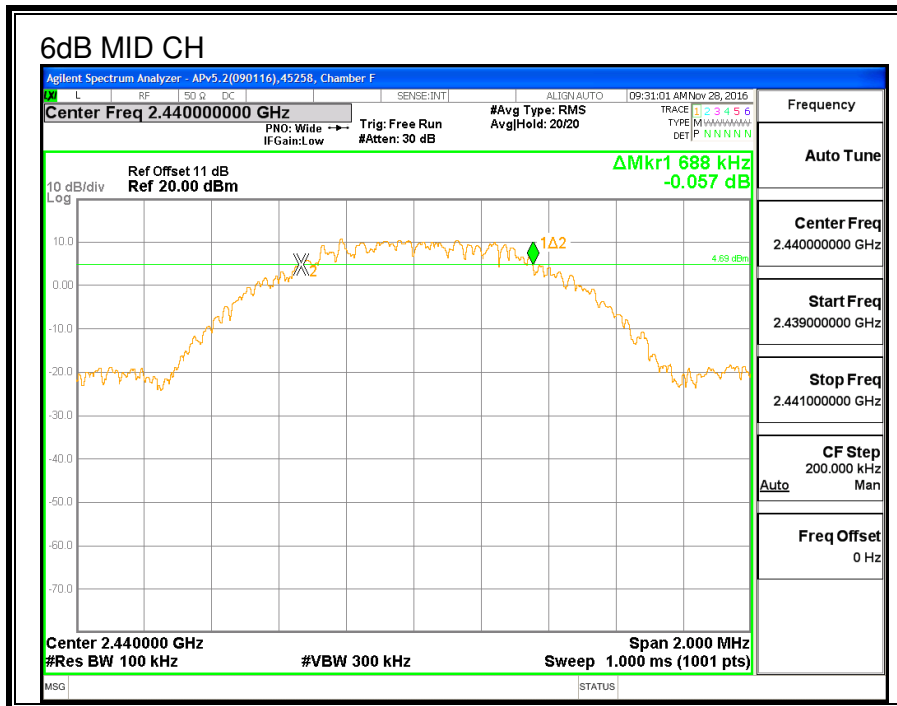
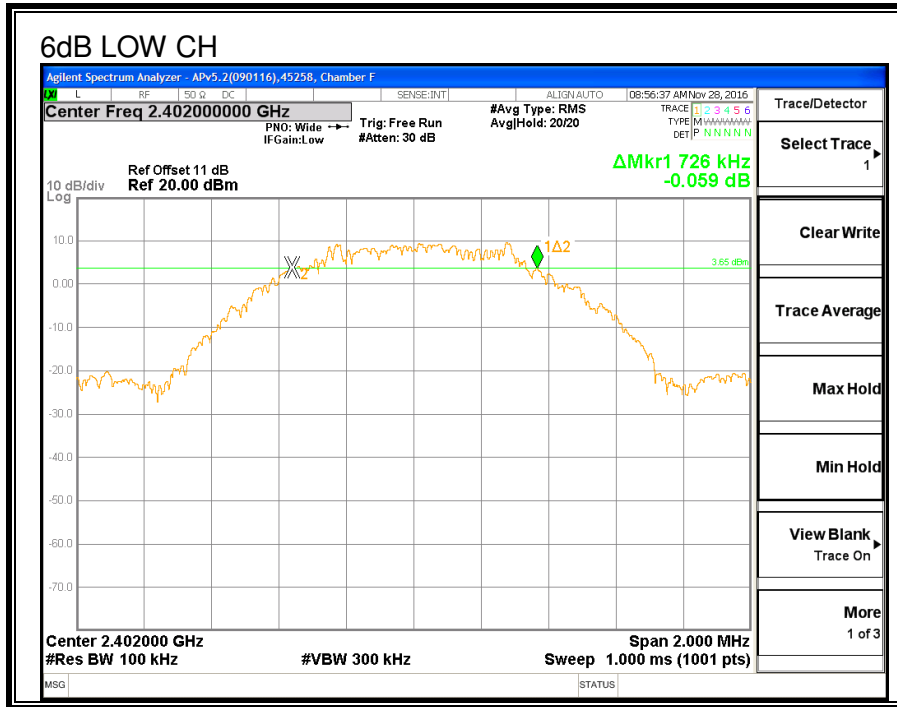

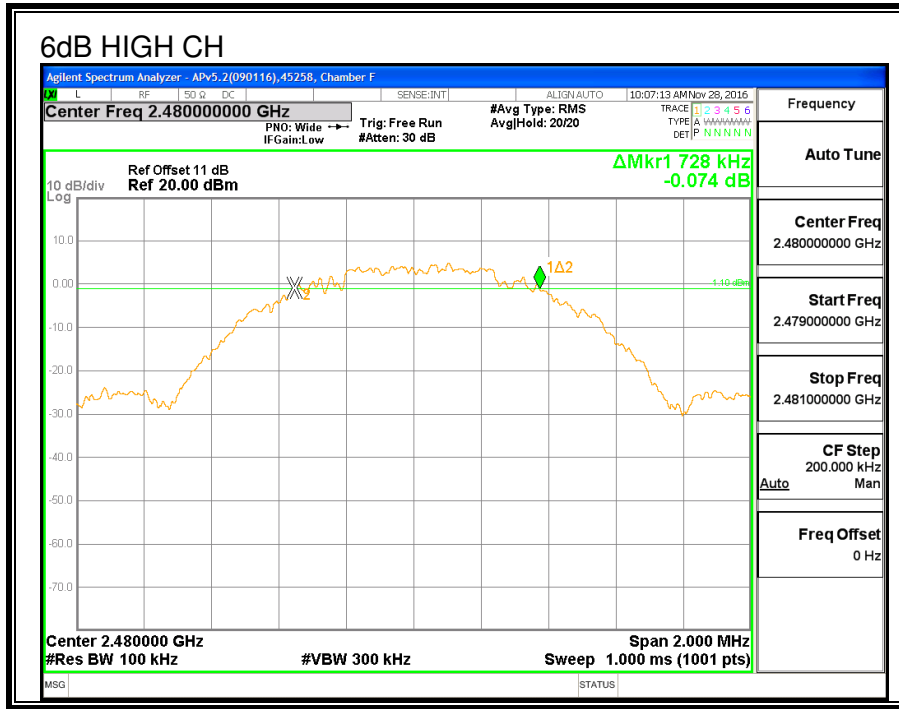

7.4.2. 99% BANDWIDTH

LIMITS

None; for reporting purposes only.

Test Procedure

The transmitter output is connected to the spectrum analyzer. The RBW is set to 1% to 3% of the 99 % bandwidth and to 1% of the span. The VBW is set to 3 times the RBW. The sweep time is coupled. The spectrum analyzer internal 99% bandwidth function is utilized.

RESULTS

Channel	Frequency (MHz)	99% Bandwidth (MHz)
Low	2402	1.0586
Middle	2440	1.0627
High	2480	1.0630

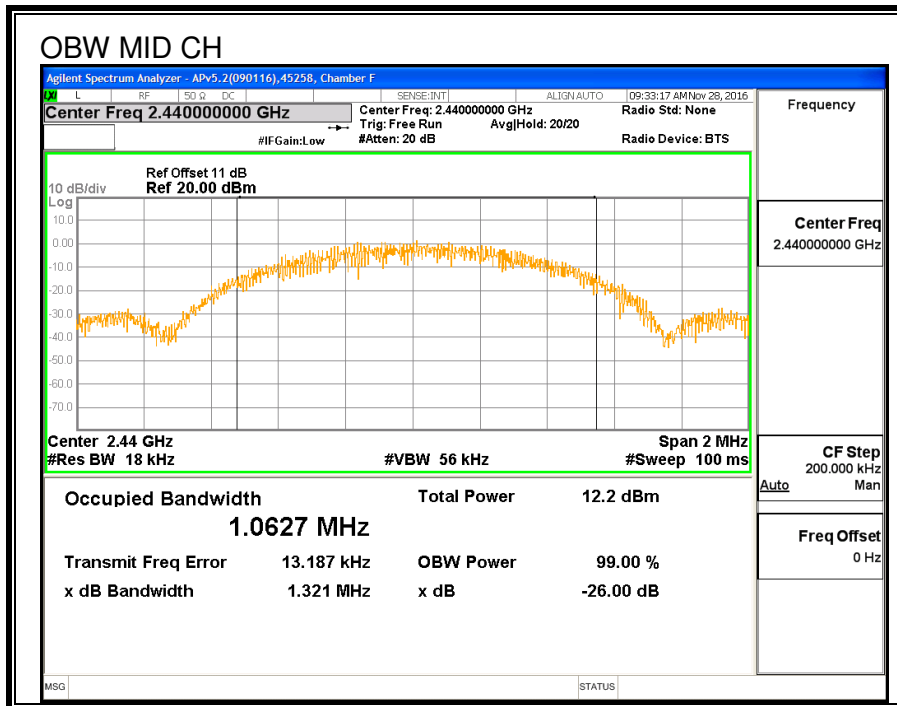
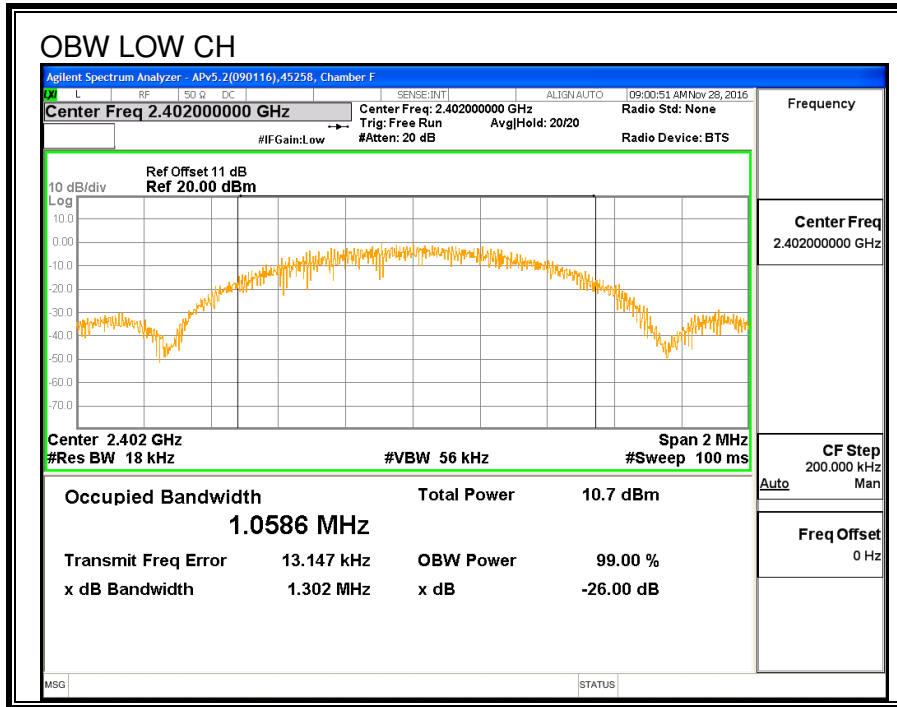

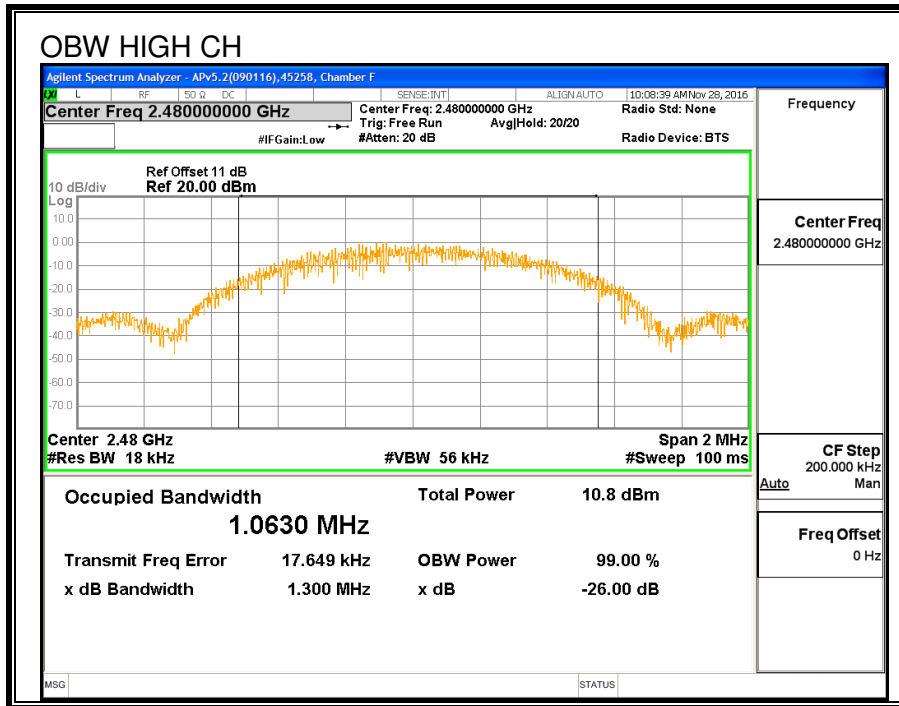

7.4.3. AVERAGE POWER

ID:	39316	Date:	2/03/2017
------------	-------	--------------	-----------

LIMITS

None; for reporting purposes only.

The cable assembly insertion loss of 11 dB (including 10 dB pad and 1 dB cable) was entered as an offset in the power meter to allow for direct reading of power.

TEST PROCEDURE

The transmitter output is connected to a wideband peak and average power meter.

RESULTS

Channel	Frequency (MHz)	AV Power (dBm)
Low	2402	9.39
Middle	2440	9.50
High	2480	9.31

7.4.4. OUTPUT POWER

ID:	39316	Date:	2/03/2017
------------	-------	--------------	-----------

LIMITS

FCC §15.247 (b)

IC RSS-247 (5.4) (4)

The maximum antenna gain is less than or equal to 6 dBi, therefore the limit is 30 dBm.

TEST PROCEDURE

The transmitter output is connected to a wideband peak and average power meter.

RESULTS

Channel	Frequency (MHz)	Peak Power Reading (dBm)	Limit (dBm)	Margin (dB)
Low	2402	9.53	30	-20.47
Middle	2440	9.90	30	-19.88
High	2480	9.46	30	-20.54

7.4.5. POWER SPECTRAL DENSITY

LIMITS

FCC §15.247 (e)

IC RSS-247 (5.2) (2)

The power spectral density conducted from the transmitter to the antenna shall not be greater than 8 dBm in any 3 kHz band during any time interval of continuous transmission.

RESULTS

Channel	Frequency (MHz)	PSD (dBm)	Limit (dBm)	Margin (dB)
Low	2402	-5.548	8	-13.548
Middle	2440	-3.941	8	-11.941
High	2480	-5.269	8	-13.269

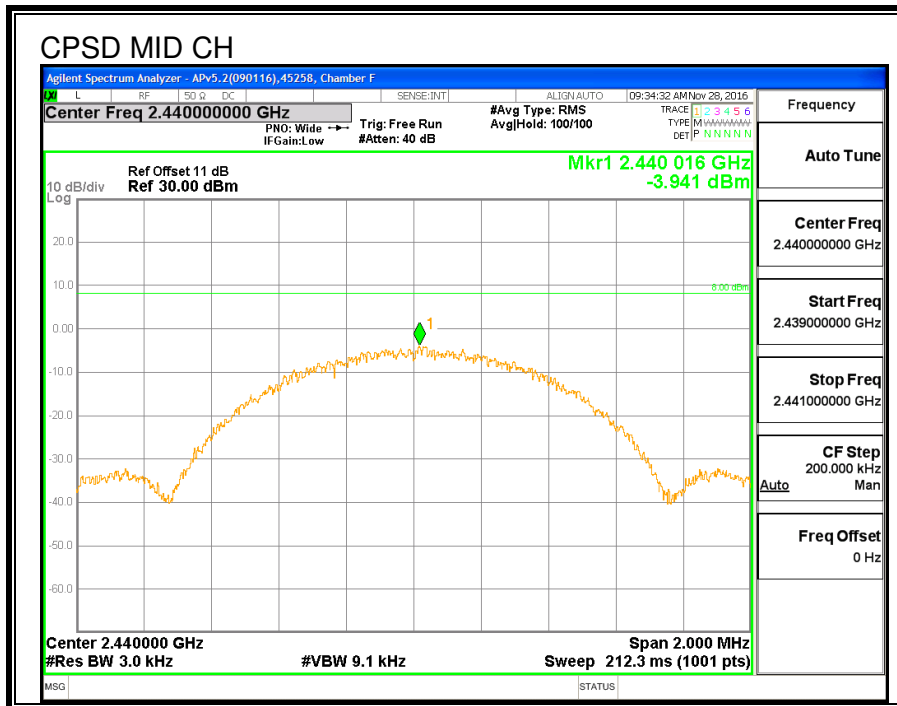
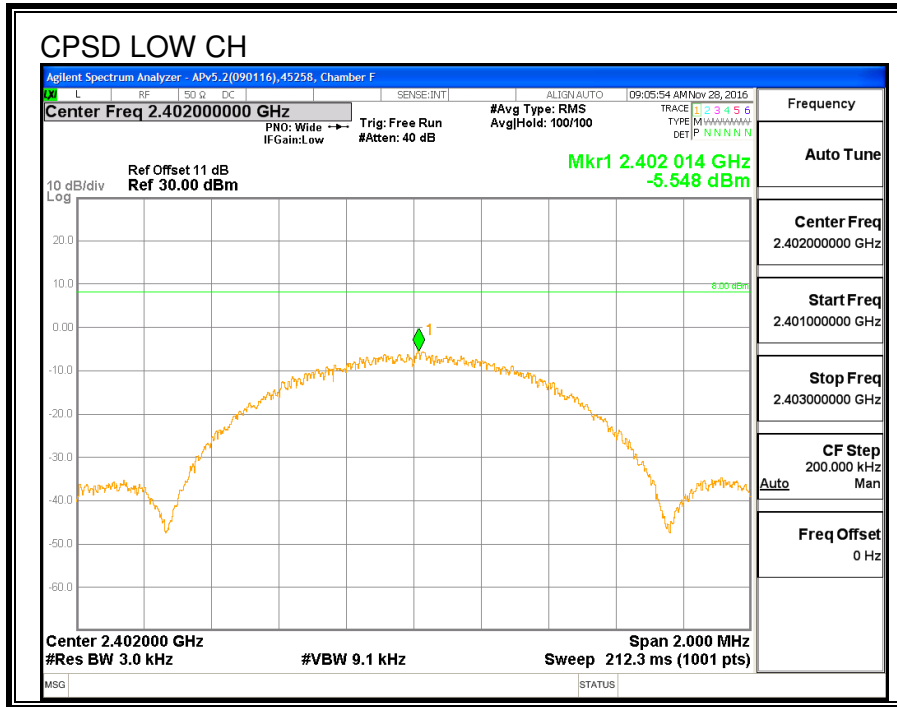

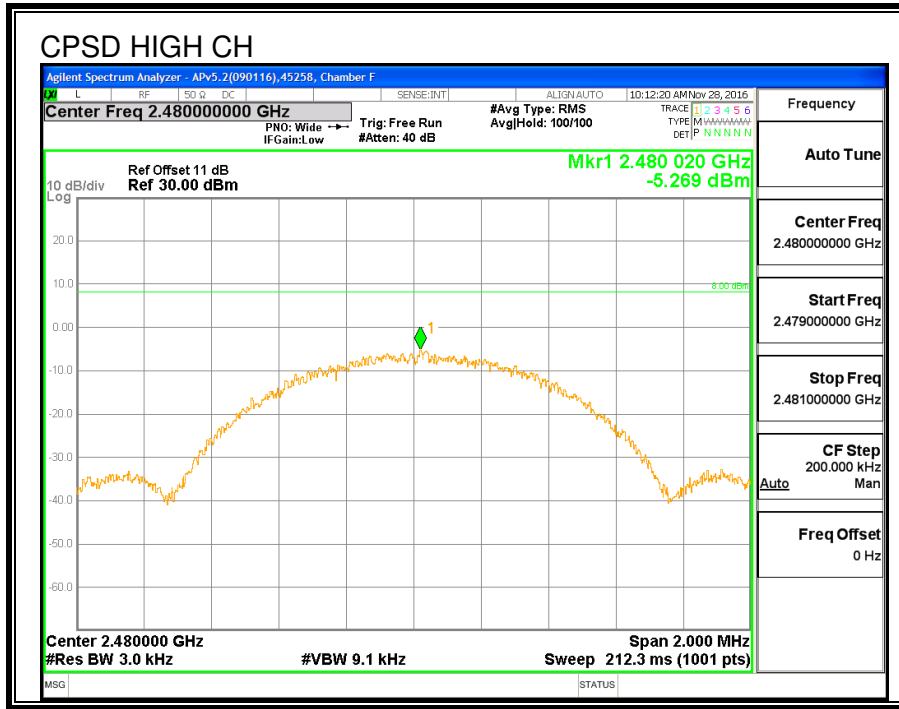

7.4.6. CONDUCTED BANDEGE AND SPURIOUS EMISSIONS

LIMITS

FCC §15.247 (d)

IC RSS-247 (5.5)

Output power was measured based on the use of a peak measurement, therefore the required attenuation is 20 dB.

RESULTS

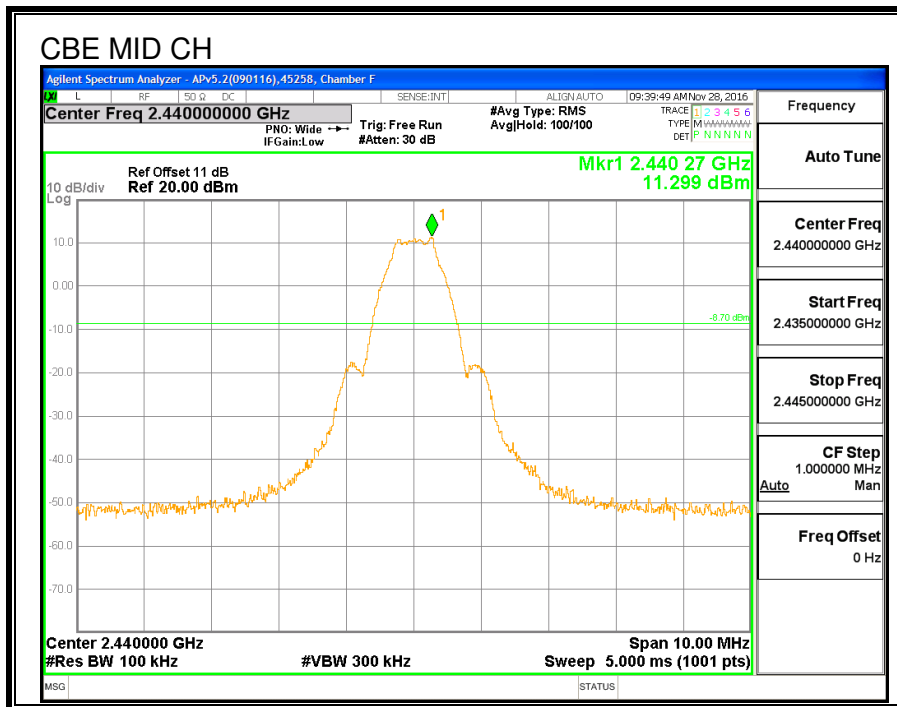
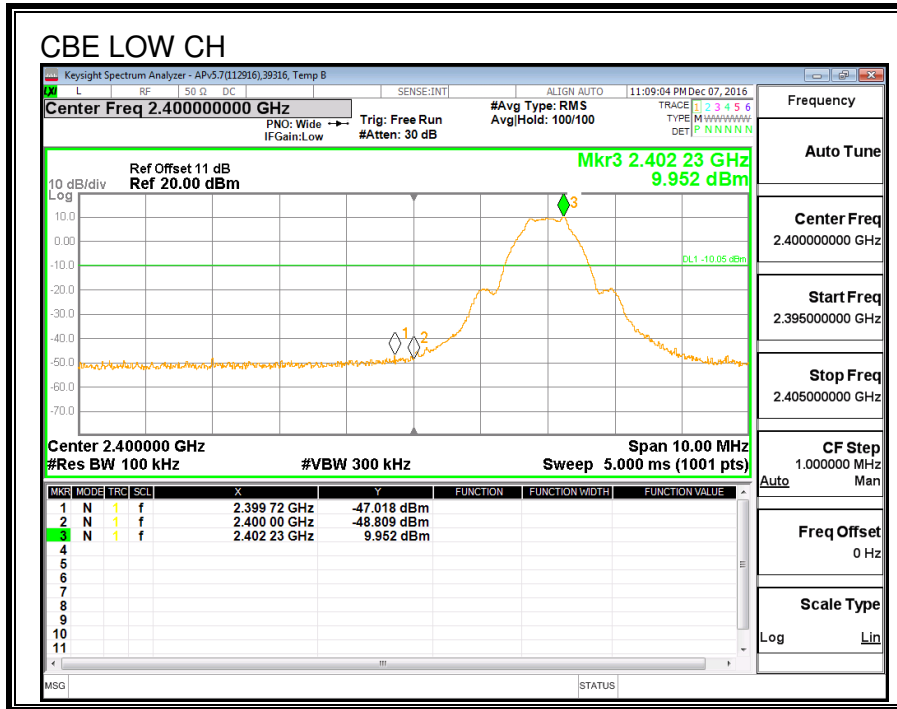

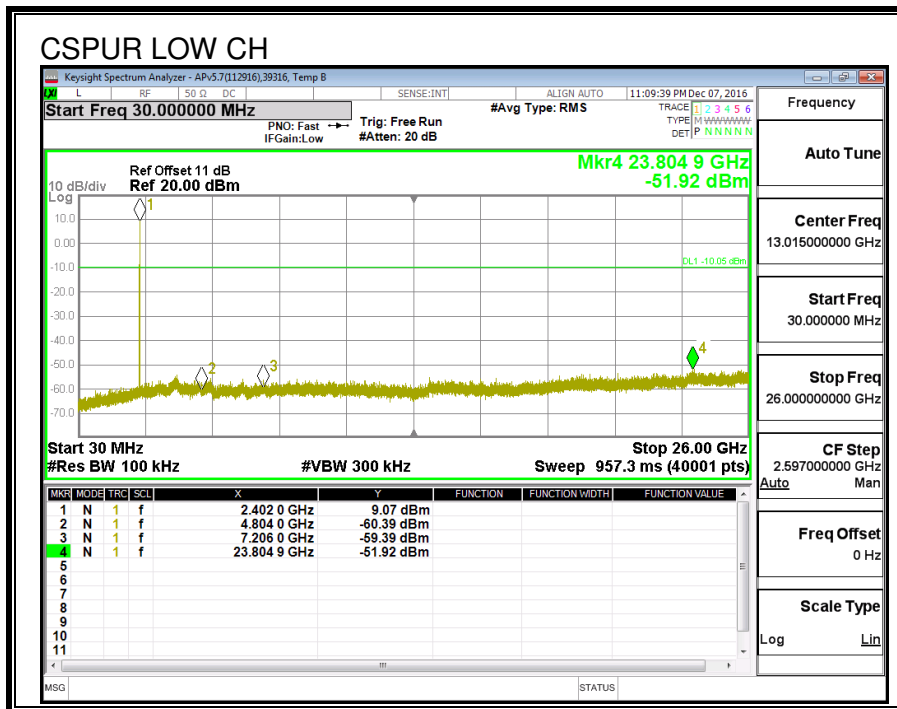
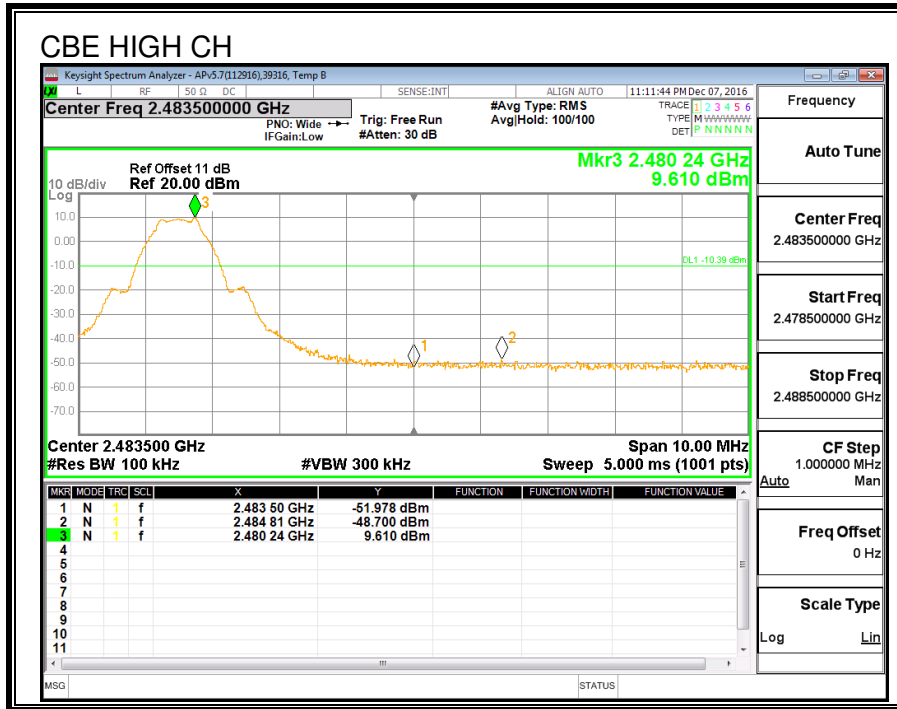

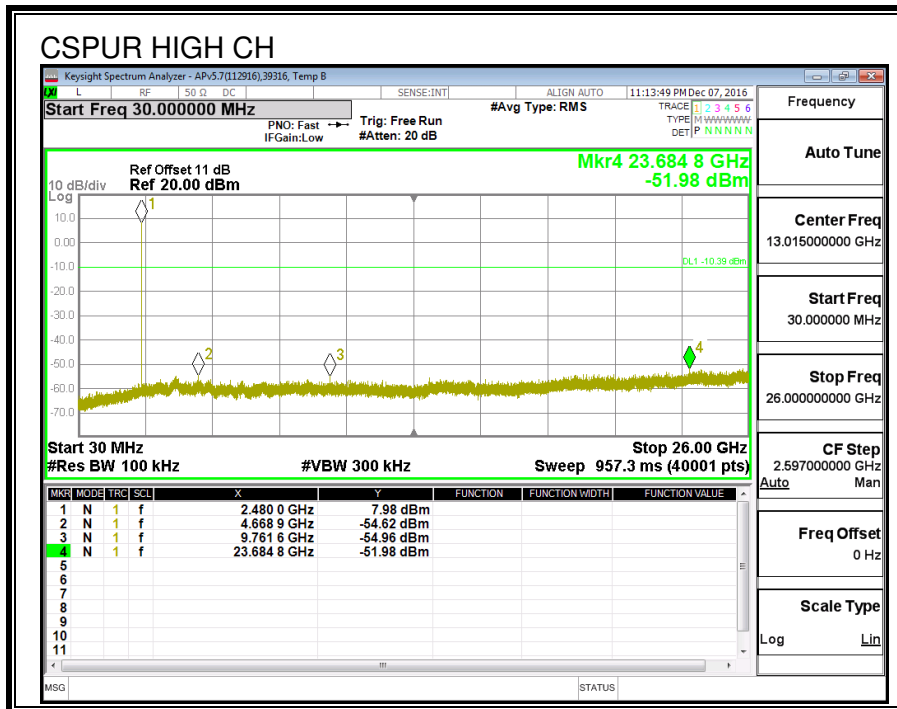
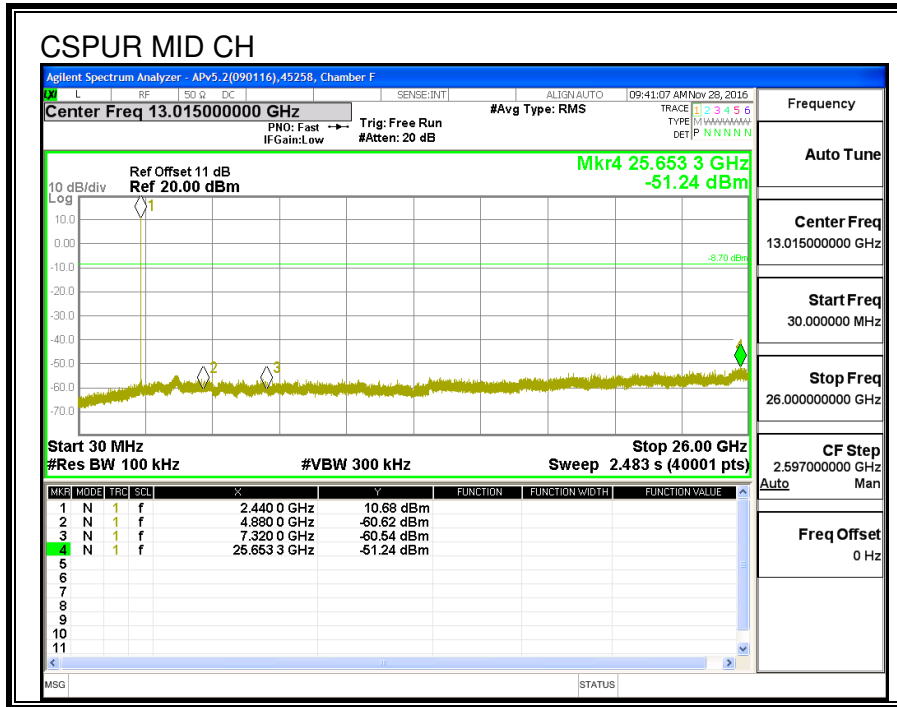

8. RADIATED TEST RESULTS

8.1. LIMITS AND PROCEDURE

LIMITS

FCC §15.205 and §15.209

IC RSS-GEN, Section 8.9 and 8.10.

Frequency Range (MHz)	Field Strength Limit (uV/m) at 3 m	Field Strength Limit (dBuV/m) at 3 m
30 - 88	100	40
88 - 216	150	43.5
216 - 960	200	46
Above 960	500	54

TEST PROCEDURE

The EUT is placed on a non-conducting table 80 cm above the ground plane for measurement below 1GHz; 1.5 m above the ground plane for measurement above 1GHz. The antenna to EUT distance is 3 meters. The EUT is configured in accordance with ANSI C63.10. The EUT is set to transmit in a continuous mode.

For measurements below 1 GHz the resolution bandwidth is set to 100 kHz for peak detection measurements or 120 kHz for quasi-peak detection measurements. Peak detection is used unless otherwise noted as quasi-peak.

For pre-scans above 1 GHz the resolution bandwidth is set to 1 MHz; the video bandwidth is set to 30 KHz for peak measurements.

For final measurements above 1 GHz the resolution bandwidth is set to 1 MHz; the video bandwidth is set to 3 MHz for peak measurements and as applicable for average measurements.

The frequency range of interest is monitored at a fixed antenna height and EUT azimuth. The EUT is rotated through 360 degrees to maximize emissions received. The antenna is scanned from 1 to 4 meters above the ground plane to further maximize the emission. Measurements are made with the antenna polarized in both the vertical and the horizontal positions.

8.2. HIGH POWER MODE

8.2.1. RESTRICTED BANDEDGE (LOW CHANNEL)

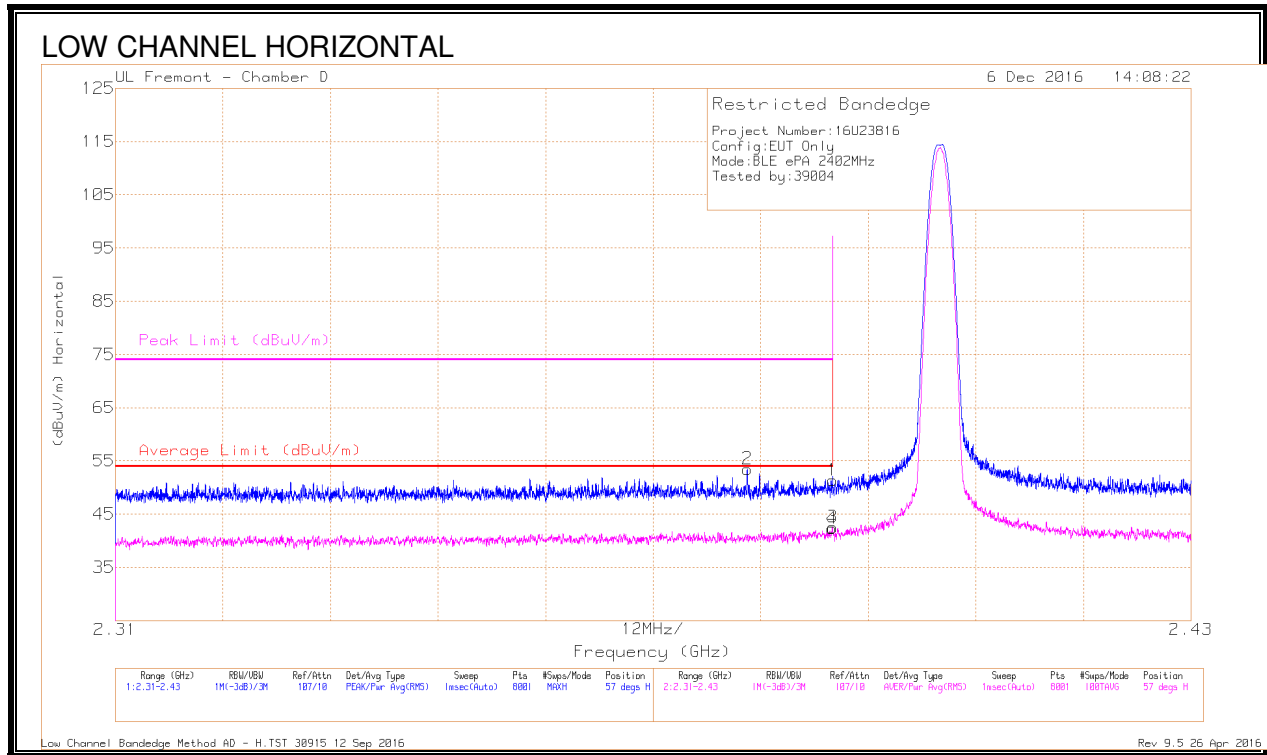

Marker	Frequency (GHz)	Meter Reading (dBuV)	Det	AF T712 (dB/m)	Amp/Cbl /Ftr/Par d (dB)	Corrected Reading (dBuV/m)	Average Limit (dBuV/m)	Margin (dB)	Peak Limit (dBuV/m)	PK Margin (dB)	Azimuth (Degs)	Height (cm)	Polarity
2	* 2.381	42.28	Pk	32	-20.8	53.48	-	-	74	-20.52	57	356	H
1	* 2.39	39.94	Pk	32.1	-20.7	51.34	-	-	74	-22.66	57	356	H
3	* 2.39	31.12	RMS	32.1	-20.7	42.52	54	-11.48	-	-	57	356	H
4	* 2.39	30.92	RMS	32.1	-20.7	42.32	54	-11.68	-	-	57	356	H

* - indicates frequency in CFR47 Pt 15 / IC RSS-Restricted Band

Pk - Peak detector

RMS - RMS detection

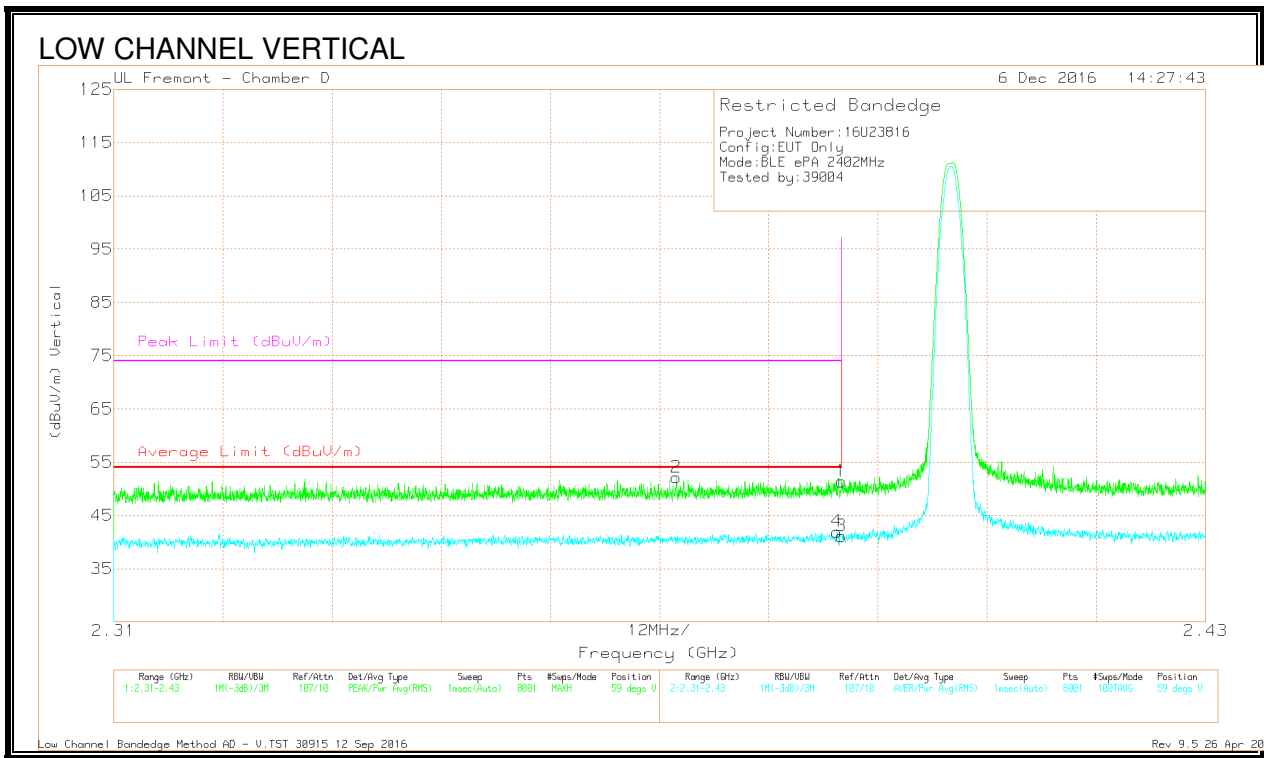

Marker	Frequency (GHz)	Meter Reading (dBuV)	Det	AF T712 (dB/m)	Amp/Cbl/Filtr/Pad (dB)	Corrected Reading (dBuV/m)	Average Limit (dBuV/m)	Margin (dB)	Peak Limit (dBuV/m)	PK Margin (dB)	Azimuth (Degs)	Height (cm)	Polarity
2	* 2.372	40.96	Pk	32	-20.8	52.16	-	-	74	-21.84	59	142	V
4	* 2.389	30.65	RMS	32.1	-20.8	41.95	54	-12.05	-	-	59	142	V
1	* 2.39	39.98	Pk	32.1	-20.7	51.38	-	-	74	-22.62	59	142	V
3	* 2.39	29.71	RMS	32.1	-20.7	41.11	54	-12.89	-	-	59	142	V

* - indicates frequency in CFR47 Pt 15 / IC RSS-Restricted Band

Pk - Peak detector

RMS - RMS detection

8.2.2. AUTHORIZED BANDEDGE (HIGH CHANNEL)

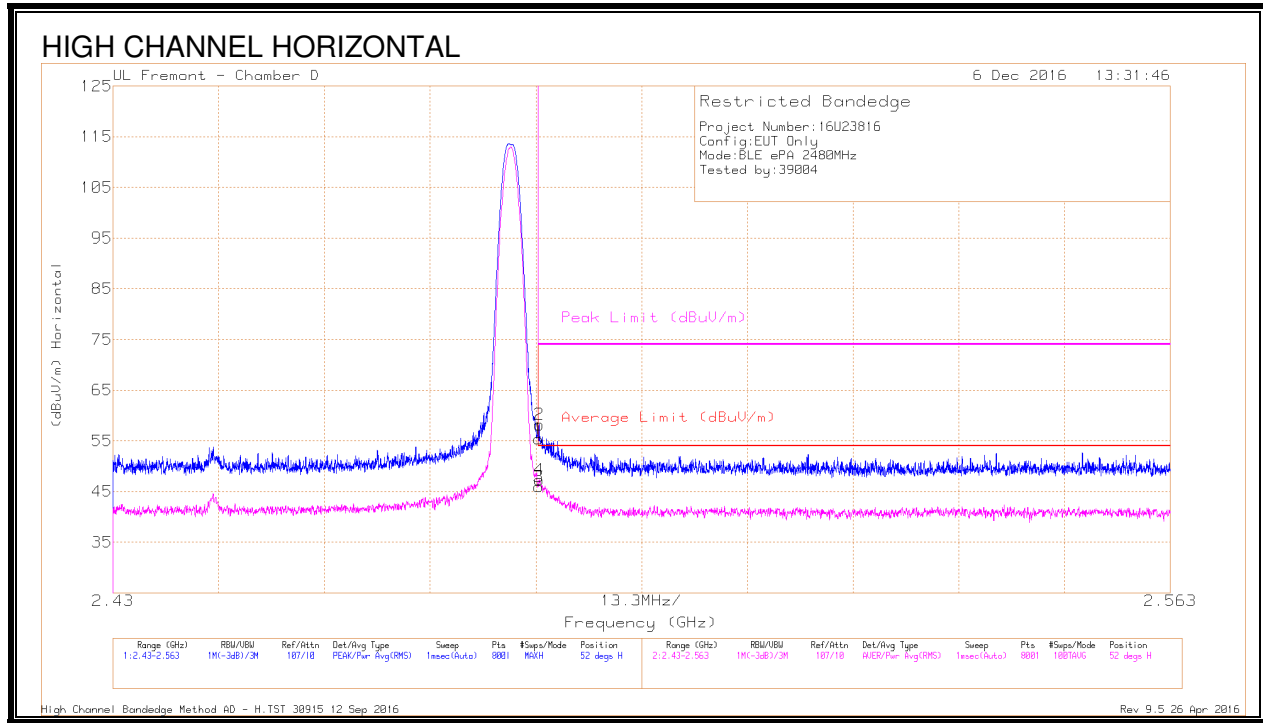

Marker	Frequency (GHz)	Meter Reading (dBuV)	Det	AF T712 (dB/m)	Amp/Cbl/Filtr /Pad (dB)	Corrected Reading (dBuV/m)	Average Limit (dBuV/m)	Margin (dB)	Peak Limit (dBuV/m)	PK Margin (dB)	Azimuth (Degs)	Height (cm)	Polarity
1	* 2.484	43.87	Pk	32.3	-20.8	55.37	-	-	74	-18.63	52	102	H
2	* 2.484	46.68	Pk	32.3	-20.8	58.18	-	-	74	-15.82	52	102	H
3	* 2.484	34.42	RMS	32.3	-20.8	45.92	54	-8.08	-	-	52	102	H
4	* 2.484	35.79	RMS	32.3	-20.8	47.29	54	-6.71	-	-	52	102	H

* - indicates frequency in CFR47 Pt 15 / IC RSS-Restricted Band
 Pk - Peak detector
 RMS - RMS detection

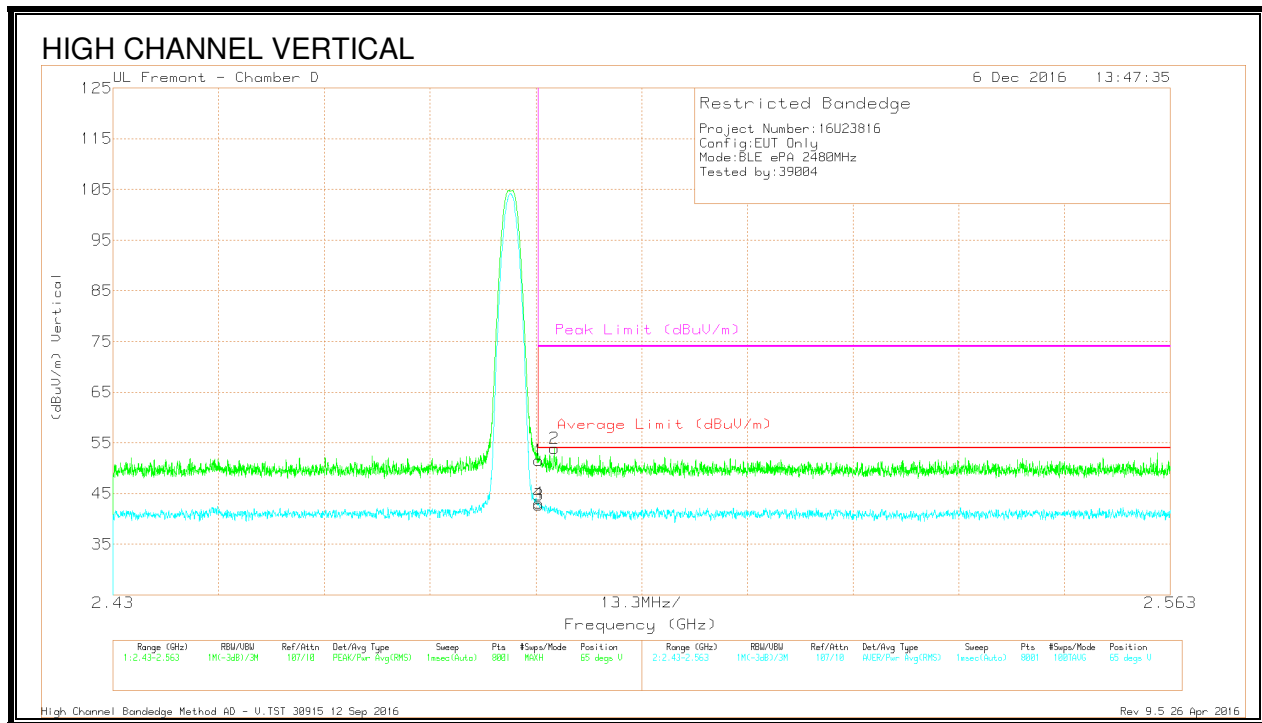

Marker	Frequency (GHz)	Meter Reading (dBuV)	Det	AF T712 (dB/m)	Amp/Cbl /Filtr/Pad (dB)	Corrected Reading (dBuV/m)	Average Limit (dBuV/m)	Margin (dB)	Peak Limit (dBuV/m)	PK Margin (dB)	Azimuth (Degs)	Height (cm)	Polarity
1	* 2.484	39.98	Pk	32.3	-20.8	51.48	-	-	74	-22.52	65	336	V
2	* 2.486	42.43	Pk	32.3	-20.8	53.93	-	-	74	-20.07	65	336	V
3	* 2.484	31.26	RMS	32.3	-20.8	42.76	54	-11.24	-	-	65	336	V
4	* 2.484	31.56	RMS	32.3	-20.8	43.06	54	-10.94	-	-	65	336	V

* - indicates frequency in CFR47 Pt 15 / IC RSS-Restricted Band

Pk - Peak detector

RMS - RMS detection

8.2.3. HARMONICS AND SPURIOUS EMISSIONS

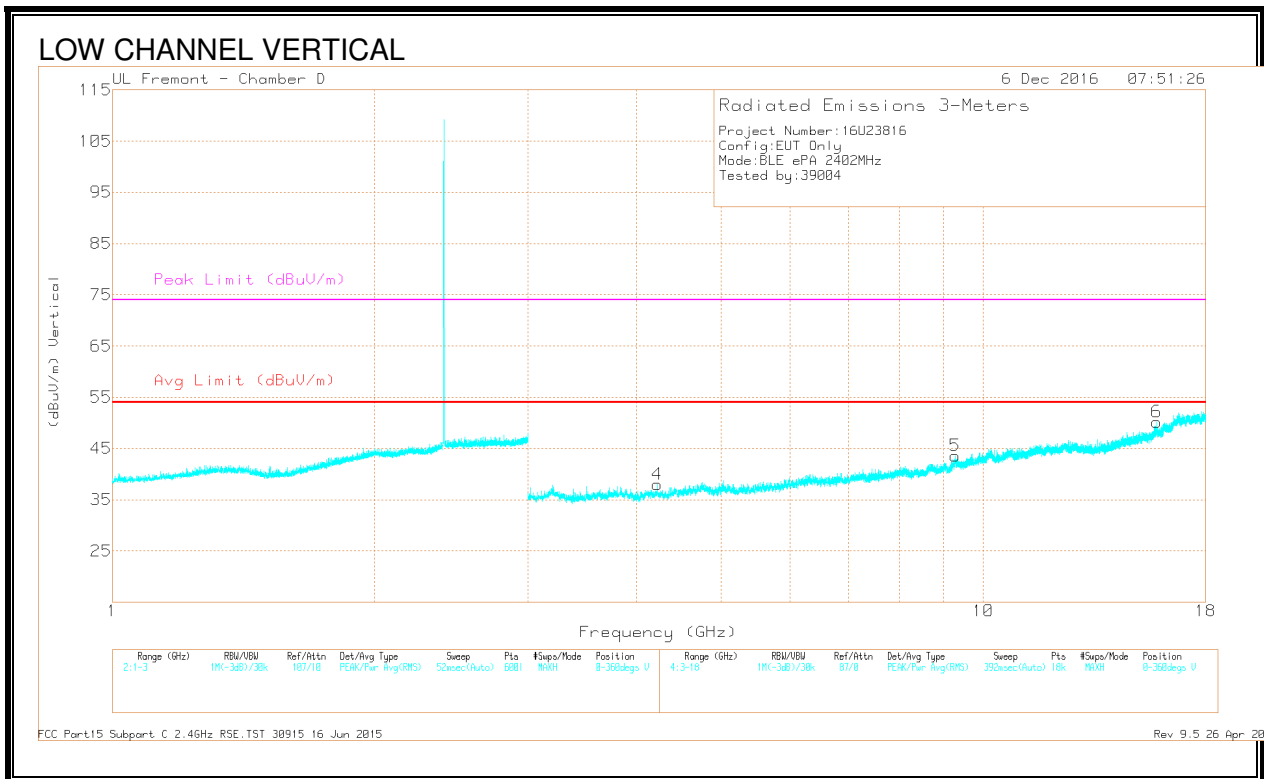
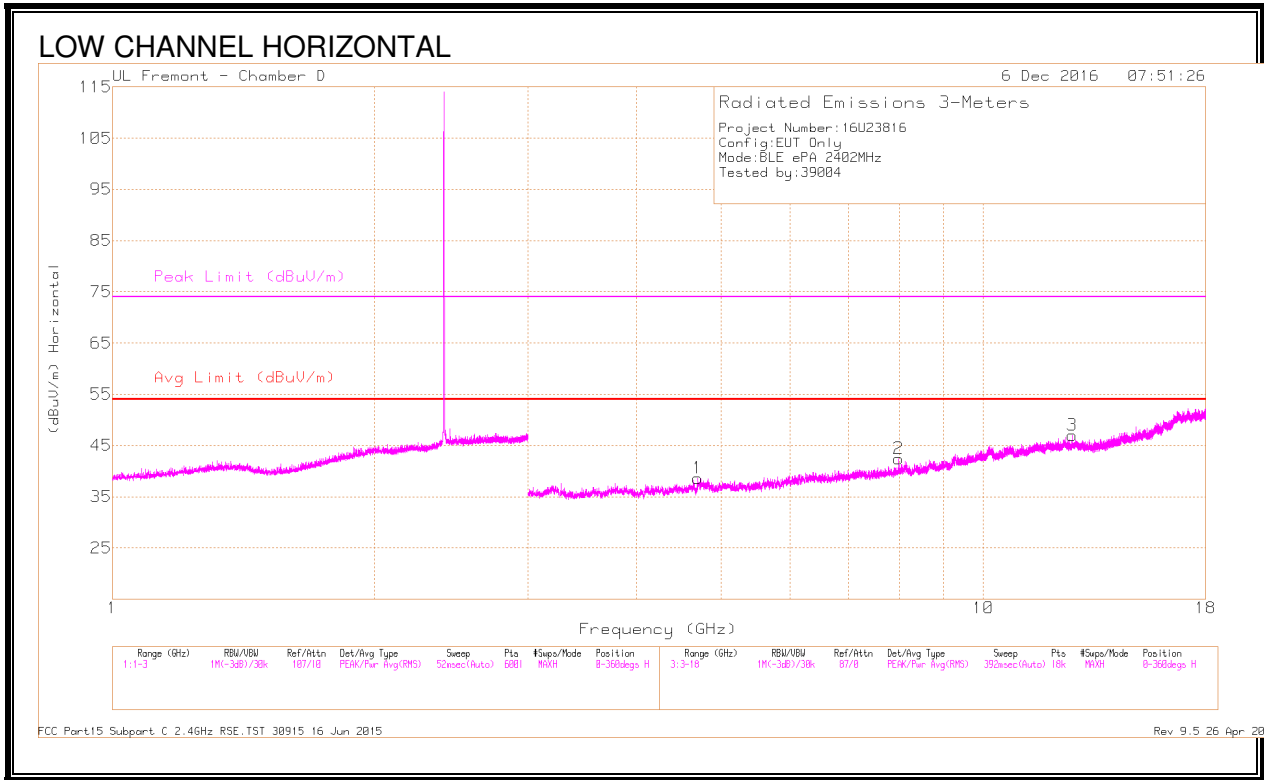

Marker	Frequen cy (GHz)	Meter Readin g (dBuV)	Det	AF T712 (dB/m)	Amp/Cbl/Flt r/Pad (dB)	DC Corr (dB)	Correct ed Reading (dBuV/ m)	Avg Limit (dBuV/m)	Margi n (dB)	Peak Limit (dBuV/m)	PK Margin (dB)	Azimu t (Degs)	Heigh t (cm)	Polarit y
1	* 4.703	38.35	PK2	34	-27.3	0	45.05	-	-	74	-28.95	7	138	H
	* 4.703	27.75	MAv1	34	-27.2	0	34.55	54	-19.45	-	-	7	138	H
3	* 12.639	34.2	PK2	39.1	-21	0	52.3	-	-	74	-21.7	202	118	H
	* 12.641	23.87	MAv1	39.1	-21.1	0	41.87	54	-12.13	-	-	202	118	H
4	* 4.225	36.8	PK2	33.5	-27.3	0	43	-	-	74	-31	356	365	V
	* 4.224	26.88	MAv1	33.5	-27.3	0	33.08	54	-20.92	-	-	356	365	V
6	* 15.81	34.04	PK2	40.3	-19	0	55.34	-	-	74	-18.66	357	307	V
	* 15.811	23.87	MAv1	40.3	-19	0	45.17	54	-8.83	-	-	357	307	V
2	7.999	35.85	PK2	35.9	-23.9	0	47.85	-	-	-	-	269	369	H
5	9.283	33.77	PK2	36.3	-20.4	0	49.67	-	-	-	-	305	102	V

* - indicates frequency in CFR47 Pt 15 / IC RSS-Restricted Band

PK2 - KDB558074 Method: Maximum Peak

MAv1 - KDB558074 Option 1 Maximum RMS Average

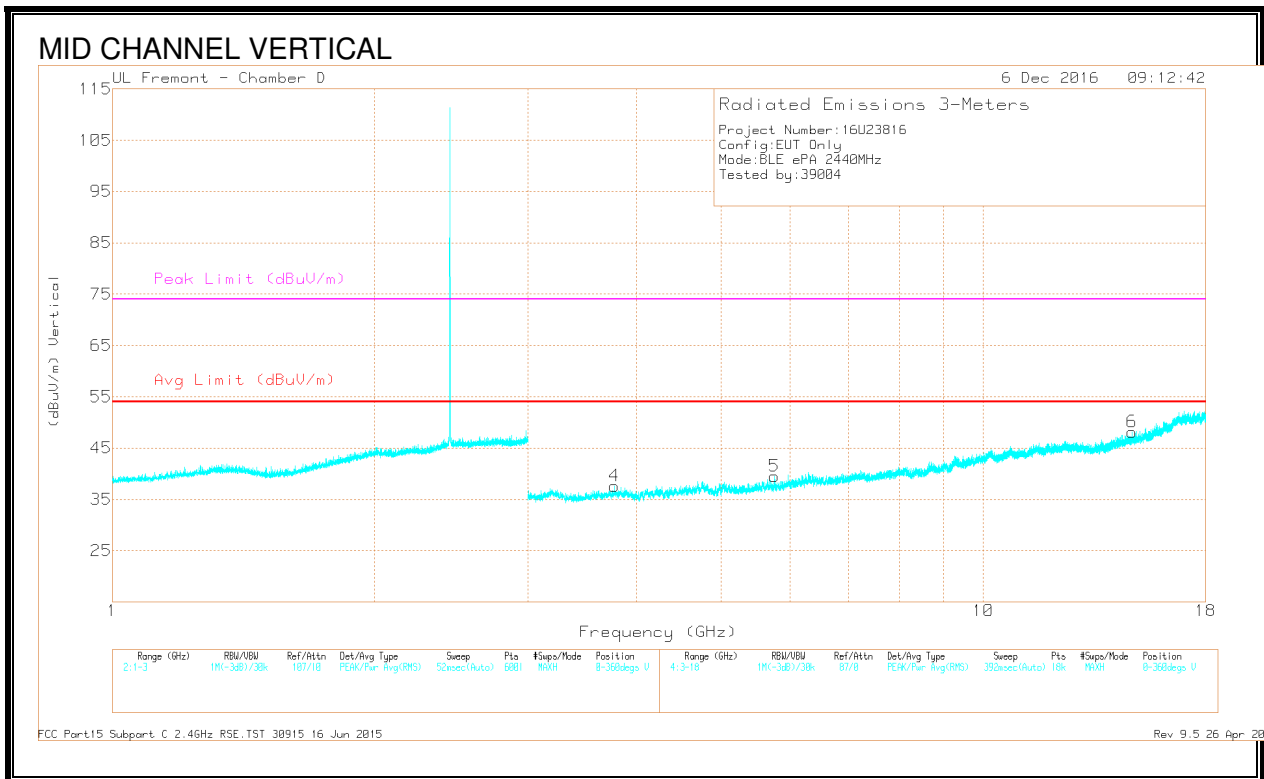
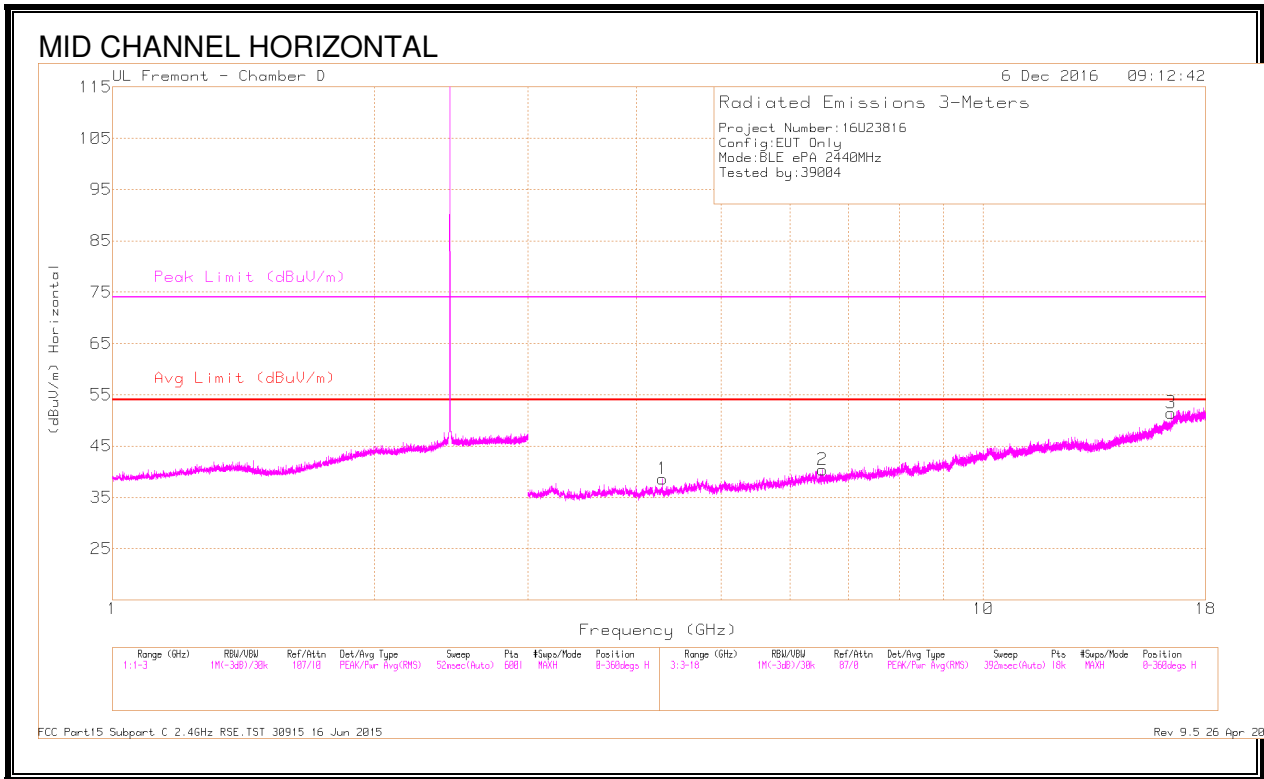

Marker	Frequen cy (GHz)	Meter Readin g (dBuV)	Det	AF T712 (dB/m)	Amp/Cbl/Flt r/Pad (dB)	DC Corr (dB)	Correct ed Reading (dBuV/ m)	Avg Limit (dBuV/m)	Margi n (dB)	Peak Limit (dBuV/m)	PK Margin (dB)	Azimu t (Degs)	Heigh t (cm)	Polarit y
1	* 4.278	37.79	PK2	33.5	-28	0	43.29	-	-	74	-30.71	200	344	H
	* 4.279	27.46	MAv1	33.5	-28	0	32.96	54	-21.04	-	-	200	344	H
4	* 3.774	38.45	PK2	33.5	-28.1	0	43.85	-	-	74	-30.15	18	172	V
	* 3.772	27.32	MAv1	33.5	-28.1	0	32.72	54	-21.28	-	-	18	172	V
5	5.758	37.39	PK2	34.8	-27	0	45.19	-	-	-	-	178	236	V
2	6.539	36.43	PK2	35.6	-25.8	0	46.23	-	-	-	-	47	229	H
6	14.813	36.83	PK2	39.7	-21.6	0	54.93	-	-	-	-	261	347	V
3	16.433	34.31	PK2	41	-18.5	0	56.81	-	-	-	-	5	391	H

* - indicates frequency in CFR47 Pt 15 / IC RSS-Restricted Band

PK2 - KDB558074 Method: Maximum Peak

MAv1 - KDB558074 Option 1 Maximum RMS Average

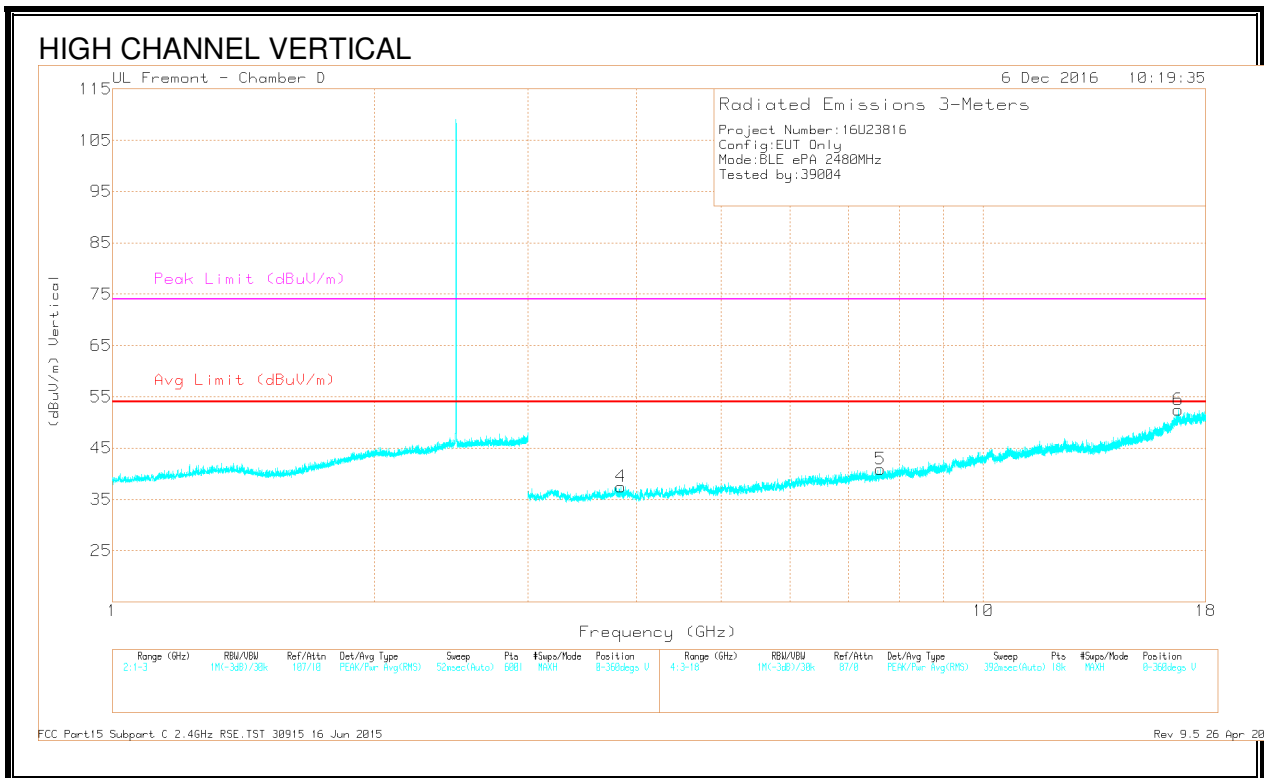
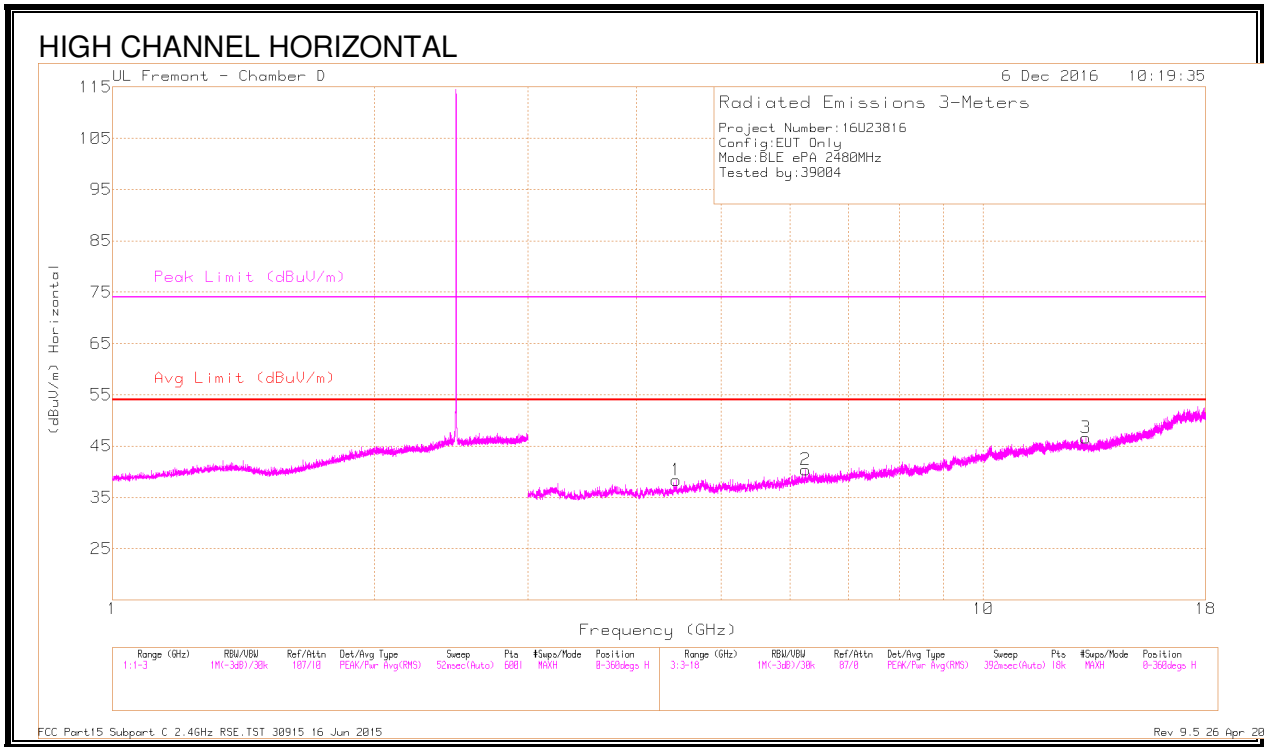

Marker	Frequenc y (GHz)	Meter Reading (dBuV)	Det	AF T712 (dB/m)	Amp/Cbl /Filtr/Pad (dB)	DC Corr (dB)	Correcte d Reading (dBuV/m)	Avg Limit (dBuV/m)	Margin (dB)	Peak Limit (dBuV/m)	PK Margin (dB)	Azimuth (Degs)	Height (cm)	Polarity
4	* 3.836	38.94	PK2	33.5	-28.6	0	43.84	-	-	74	-30.16	212	339	V
	* 3.835	28.12	MAv1	33.5	-28.6	0	33.02	54	-20.98	-	-	212	339	V
5	* 7.618	35.77	PK2	35.8	-24.7	0	46.87	-	-	74	-27.13	267	157	V
	* 7.618	25.16	MAv1	35.8	-24.7	0	36.26	54	-17.74	-	-	267	157	V
1	4.439	37.68	PK2	33.9	-27.4	0	44.18	-	-	-	-	252	368	H
2	6.247	37.05	PK2	35.6	-26.2	0	46.45	-	-	-	-	180	108	H
3	13.113	34.51	PK2	39	-21.5	0	52.01	-	-	-	-	229	232	H
6	16.749	34.01	PK2	41.8	-17.4	0	58.41	-	-	-	-	118	334	V

* - indicates frequency in CFR47 Pt 15 / IC RSS-Restricted Band

PK2 - KDB558074 Method: Maximum Peak

MAv1 - KDB558074 Option 1 Maximum RMS Average

8.3. LOW POWER MODE

8.3.1. RESTRICTED BANDEGE (LOW CHANNEL)

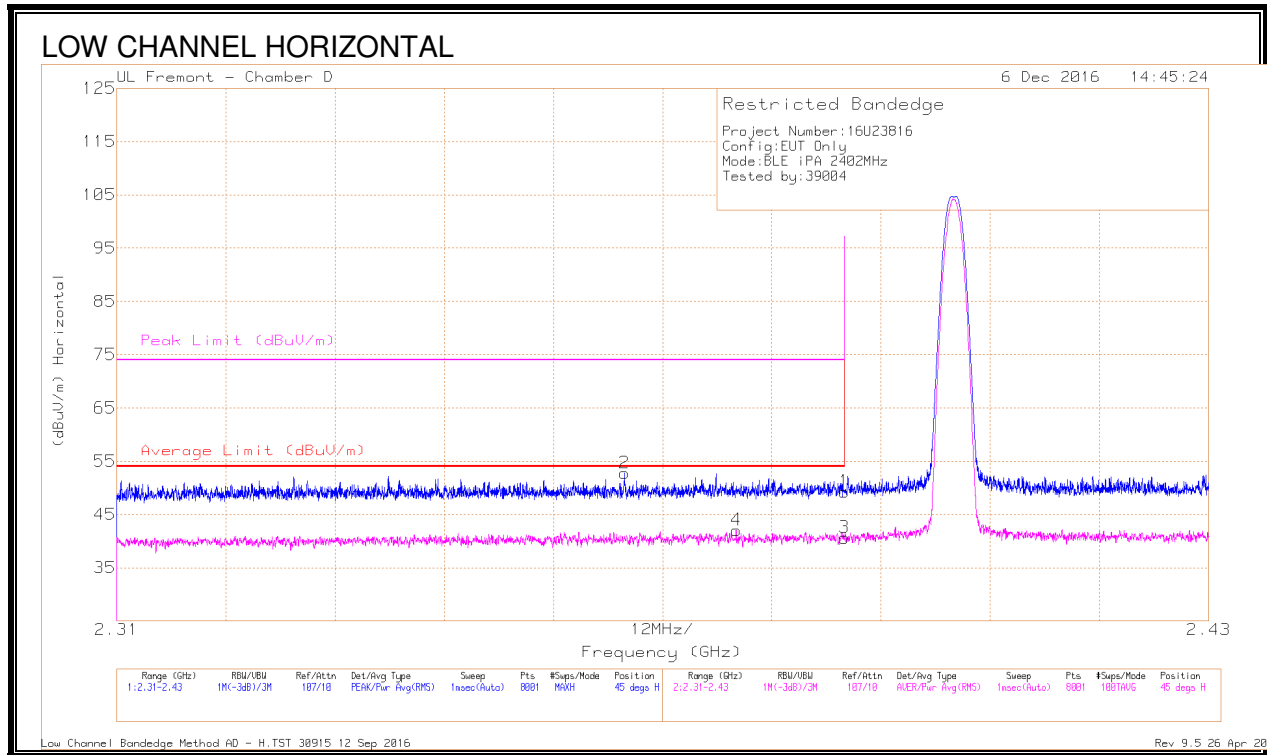

Marker	Frequency (GHz)	Meter Reading (dBuV)	Det	AF T712 (dB/m)	Amp/Cbl/Filter/Pad (dB)	Corrected Reading (dBuV/m)	Average Limit (dBuV/m)	Margin (dB)	Peak Limit (dBuV/m)	PK Margin (dB)	Azimuth (Degs)	Height (cm)	Polarity
2	* 2.366	41.64	Pk	31.9	-20.8	52.74	-	-	74	-21.26	45	132	H
4	* 2.378	30.85	RMS	32	-20.8	42.05	54	-11.95	-	-	45	132	H
1	* 2.39	37.86	Pk	32.1	-20.7	49.26	-	-	74	-24.74	45	132	H
3	* 2.39	29.24	RMS	32.1	-20.7	40.64	54	-13.36	-	-	45	132	H

* - indicates frequency in CFR47 Pt 15 / IC RSS-Restricted Band

Pk - Peak detector

RMS - RMS detection

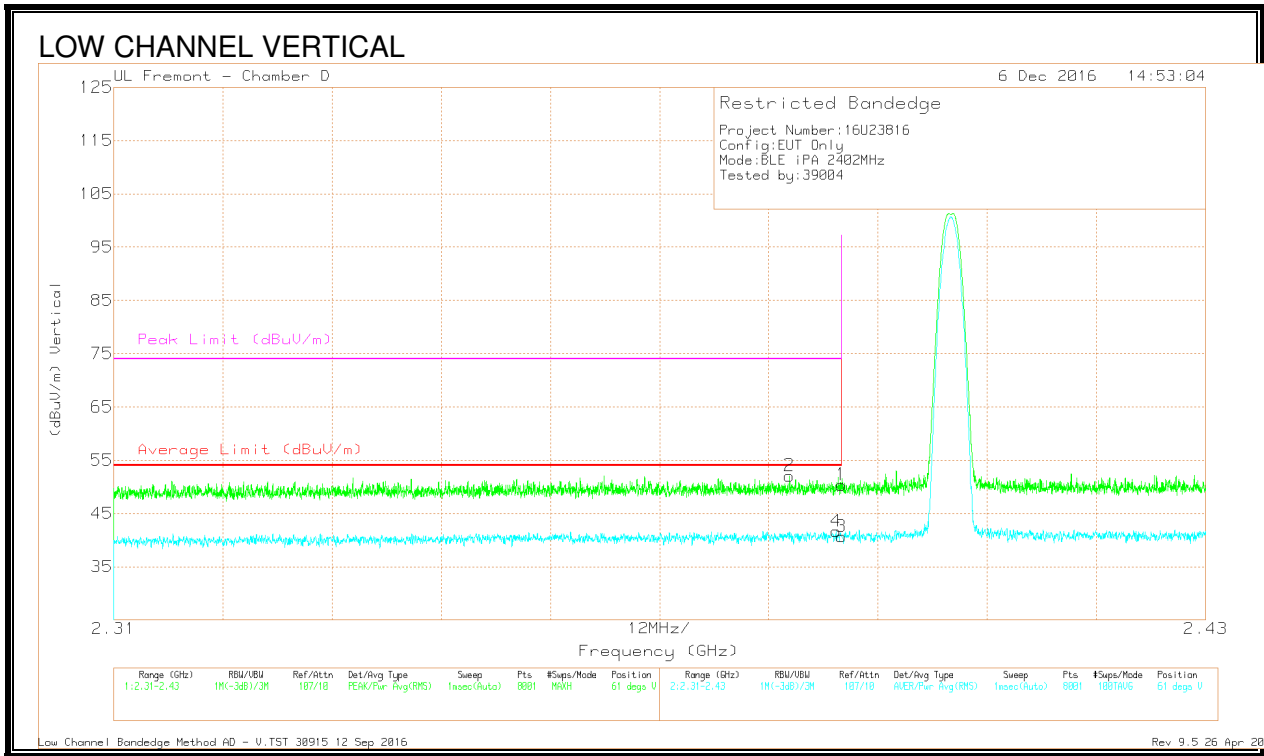

Marker	Frequency (GHz)	Meter Reading (dBuV)	Det	AF T712 (dB/m)	Amp/Cbl/Filtr/Pad (dB)	Corrected Reading (dBuV/m)	Average Limit (dBuV/m)	Margin (dB)	Peak Limit (dBuV/m)	PK Margin (dB)	Azimuth (Degs)	Height (cm)	Polarity
2	* 2.384	40.77	Pk	32.1	-20.8	52.07	-	-	74	-21.93	61	148	V
4	* 2.389	30.36	RMS	32.1	-20.8	41.66	54	-12.34	-	-	61	148	V
1	* 2.39	38.95	Pk	32.1	-20.7	50.35	-	-	74	-23.65	61	148	V
3	* 2.39	29.25	RMS	32.1	-20.7	40.65	54	-13.35	-	-	61	148	V

* - indicates frequency in CFR47 Pt 15 / IC RSS-Restricted Band
 Pk - Peak detector
 RMS - RMS detection

8.3.2. AUTHORIZED BANDEDGE (HIGH CHANNEL)

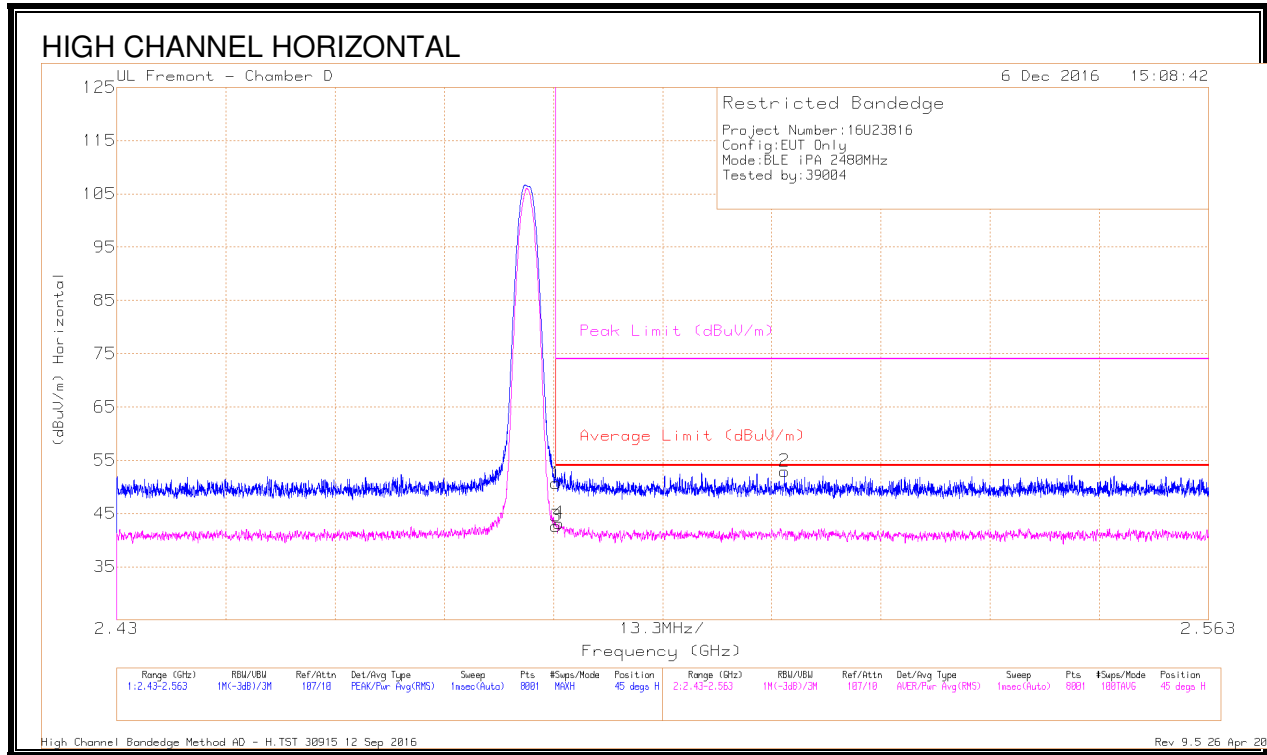

Marker	Frequency (GHz)	Meter Reading (dBuV)	Det	AF T712 (dB/m)	Amp/Cbl/Filter/Pad (dB)	Corrected Reading (dBuV/m)	Average Limit (dBuV/m)	Margin (dB)	Peak Limit (dBuV/m)	PK Margin (dB)	Azimuth (Degs)	Height (cm)	Polarity
1	* 2.484	39.16	Pk	32.3	-20.8	50.66	-	-	74	-23.34	45	104	H
3	* 2.484	31.11	RMS	32.3	-20.8	42.61	54	-11.39	-	-	45	104	H
4	* 2.484	31.67	RMS	32.3	-20.8	43.17	54	-10.83	-	-	45	104	H
2	2.511	41.23	Pk	32.3	-20.6	52.93	-	-	74	-21.07	45	104	H

* - indicates frequency in CFR47 Pt 15 / IC RSS-Restricted Band
 Pk - Peak detector
 RMS - RMS detection

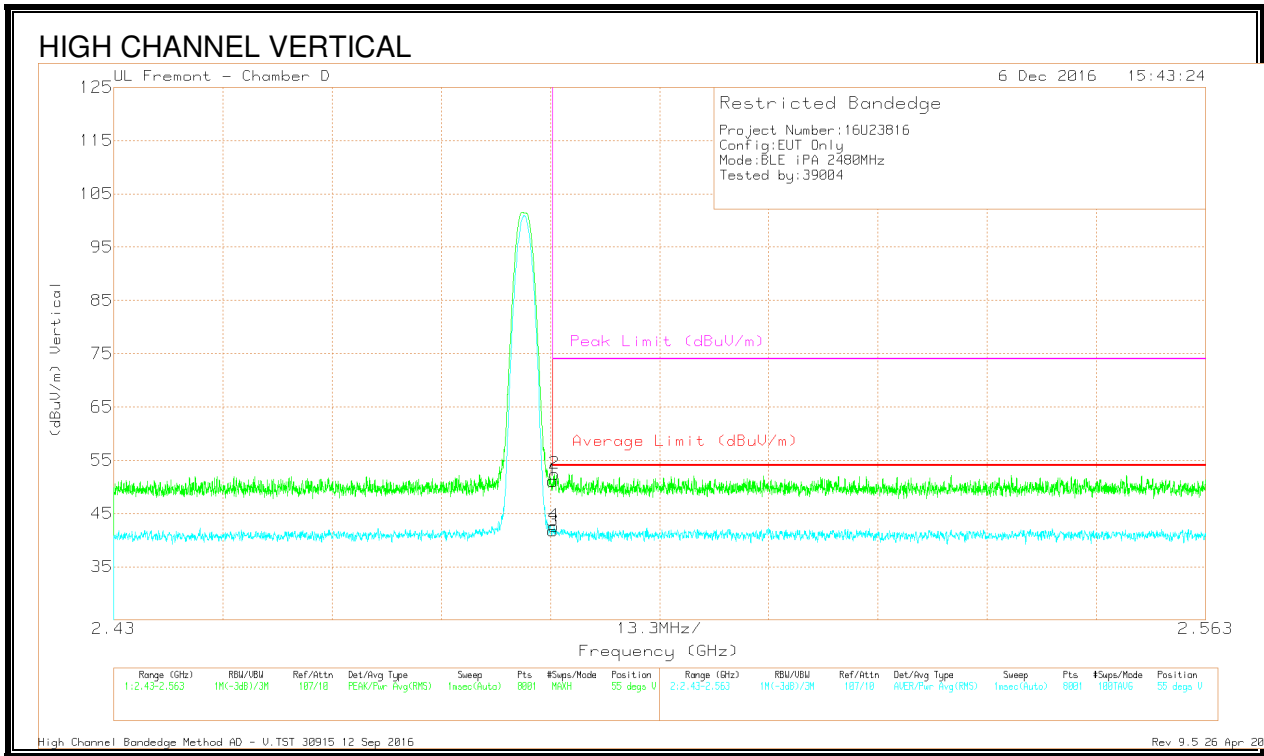

Marker	Frequency (GHz)	Meter Reading (dBuV)	Det	AFT12 (dB/m)	Amp/Cbl/Filtr/Pad (dB)	Corrected Reading (dBuV/m)	Average Limit (dBuV/m)	Margin (dB)	Peak Limit (dBuV/m)	PK Margin (dB)	Azimuth (Degs)	Height (cm)	Polarity
1	* 2.484	39.63	Pk	32.3	-20.8	51.13	-	-	74	-22.87	55	114	V
2	* 2.484	40.96	Pk	32.3	-20.8	52.46	-	-	74	-21.54	55	114	V
3	* 2.484	30.24	RMS	32.3	-20.8	41.74	54	-12.26	-	-	55	114	V
4	* 2.484	31.17	RMS	32.3	-20.8	42.67	54	-11.33	-	-	55	114	V

* - indicates frequency in CFR47 Pt 15 / IC RSS-Restricted Band
 Pk - Peak detector
 RMS - RMS detection

8.3.3. HARMONICS AND SPURIOUS EMISSIONS

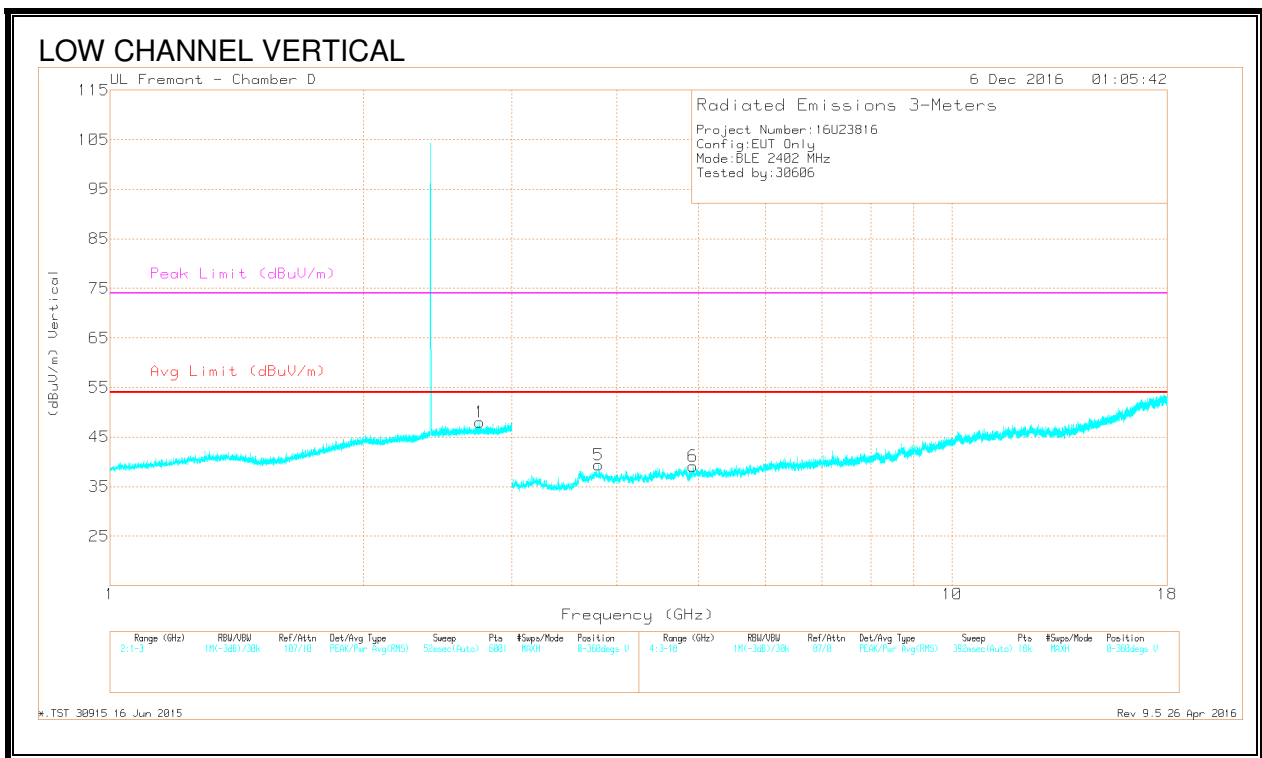
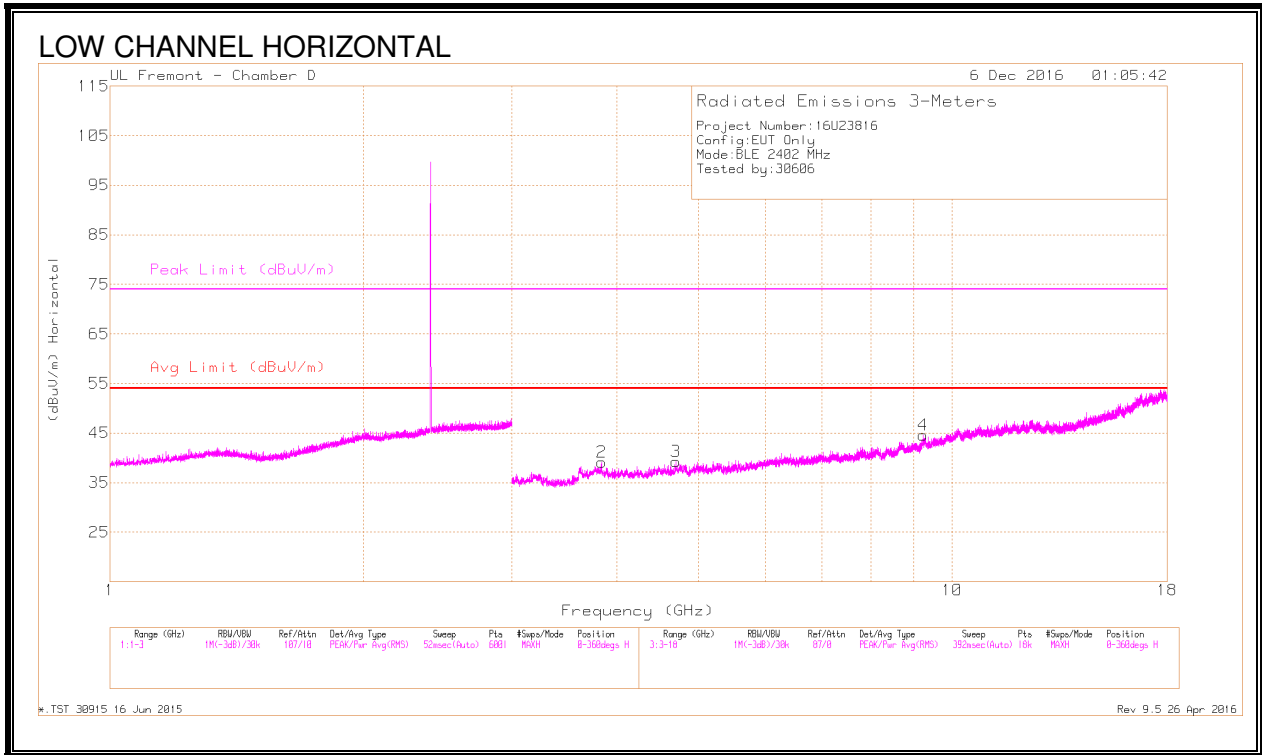

Marker	Frequenc y (GHz)	Meter Reading (dBuV)	Det	AF T712 (dB/m)	Amp/Cbl /Fitr/Pad (dB)	Corrected Reading (dBuV/m)	Avg Limit (dBuV/m)	Margin (dB)	Peak Limit (dBuV/m)	PK Margin (dB)	Azimuth (Degs)	Height (cm)	Polarity
1	* 2.748	41.28	PK2	32.4	-20.4	53.28	-	-	74	-20.72	36	121	V
	* 2.748	30.33	MAv1	32.4	-20.4	42.33	54	-11.67	-	-	36	121	V
2	* 3.832	39.57	PK2	33.5	-28.6	44.47	-	-	74	-29.53	224	130	H
	* 3.833	29.2	MAv1	33.5	-28.6	34.1	54	-19.9	-	-	224	130	H
3	* 4.696	38.17	PK2	34	-27.3	44.87	-	-	74	-29.13	316	131	H
	* 4.697	27.72	MAv1	34	-27.3	34.42	54	-19.58	-	-	316	131	H
5	* 3.804	39.96	PK2	33.6	-28.3	45.26	-	-	74	-28.74	327	153	V
	* 3.804	28.74	MAv1	33.6	-28.3	34.04	54	-19.96	-	-	327	153	V
6	* 4.924	38.52	PK2	34.1	-27.9	44.72	-	-	74	-29.28	46	391	V
	* 4.925	28.25	MAv1	34.1	-27.8	34.55	54	-19.45	-	-	46	391	V
4	9.242	35.09	PK2	36.3	-20.5	50.89	-	-	-	-	127	370	H

* - indicates frequency in CFR47 Pt 15 / IC RSS-Restricted Band

PK2 - KDB558074 Method: Maximum Peak

MAv1 - KDB558074 Option 1 Maximum RMS Average

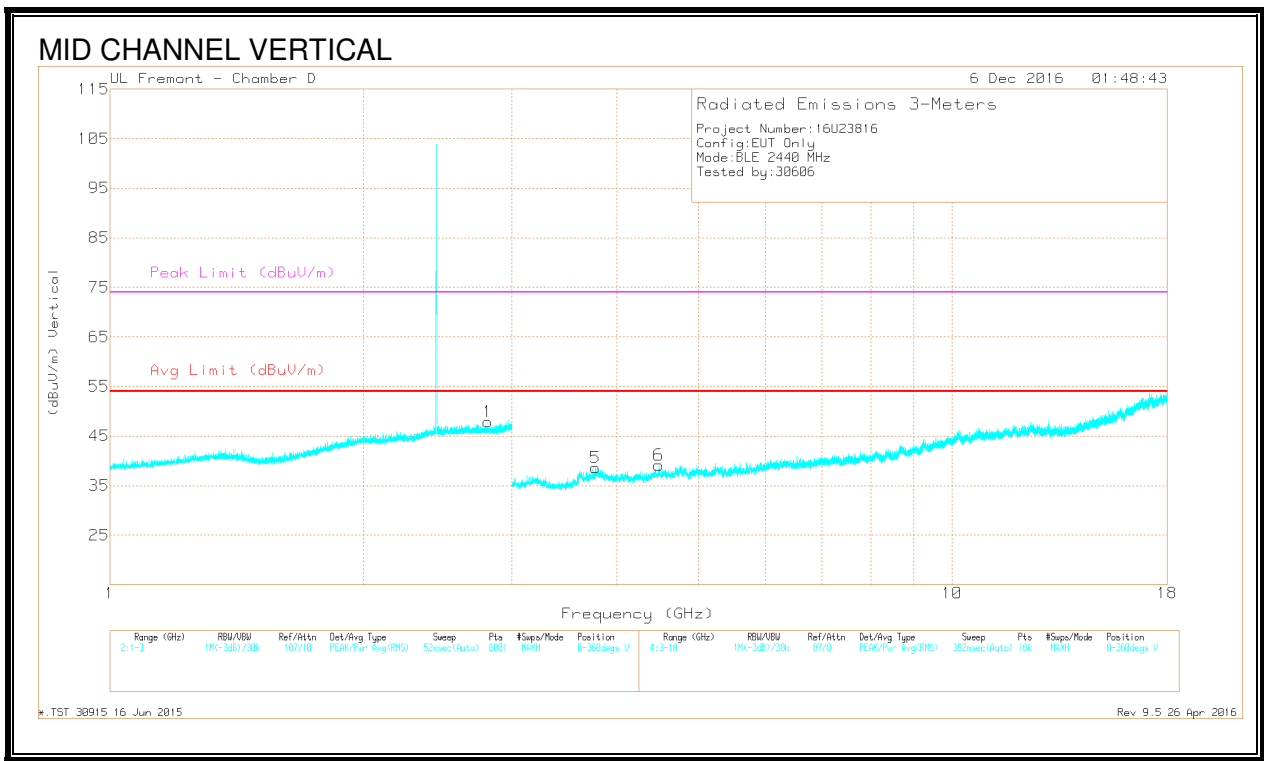
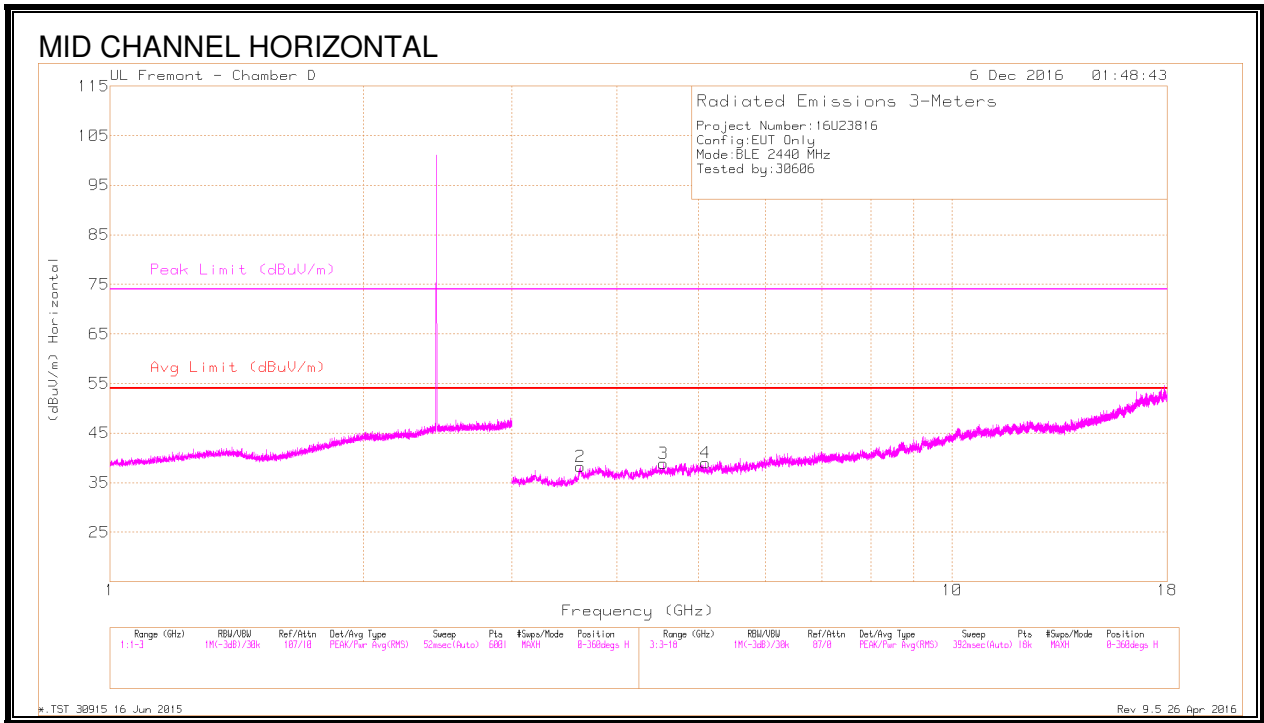

Marker	Frequenc y (GHz)	Meter Reading (dBuV)	Det	AF T712 (dB/m)	Amp/Cbl/ Filtr/Pad (dB)	Corrected Reading (dBuV/m)	Avg Limit (dBuV/m)	Margin (dB)	Peak Limit (dBuV/m)	PK Margin (dB)	Azimuth (Degs)	Height (cm)	Polarity
1	* 2.81	41.43	PK2	32.3	-20.3	53.43	-	-	74	-20.57	312	271	V
	* 2.81	30.2	MAv1	32.3	-20.3	42.2	54	-11.8	-	-	312	271	V
2	* 3.615	39.83	PK2	33.3	-28.4	44.73	-	-	74	-29.27	309	102	H
	* 3.617	29.01	MAv1	33.3	-28.4	33.91	54	-20.09	-	-	309	102	H
3	* 4.544	39.09	PK2	34	-27.8	45.29	-	-	74	-28.71	139	201	H
	* 4.544	28.35	MAv1	34	-27.8	34.55	54	-19.45	-	-	139	201	H
4	* 5.092	37.73	PK2	34	-26.7	45.03	-	-	74	-28.97	181	201	H
	* 5.094	27.15	MAv1	34	-26.8	34.35	54	-19.65	-	-	181	201	H
5	* 3.771	39.58	PK2	33.5	-28.1	44.98	-	-	74	-29.02	271	246	V
	* 3.773	28.61	MAv1	33.5	-28.1	34.01	54	-19.99	-	-	271	246	V
6	4.481	38.22	PK2	33.9	-27.6	44.52	-	-	-	-	147	399	V

* - indicates frequency in CFR47 Pt 15 / IC RSS-Restricted Band

PK2 - KDB558074 Method: Maximum Peak

MAv1 - KDB558074 Option 1 Maximum RMS Average

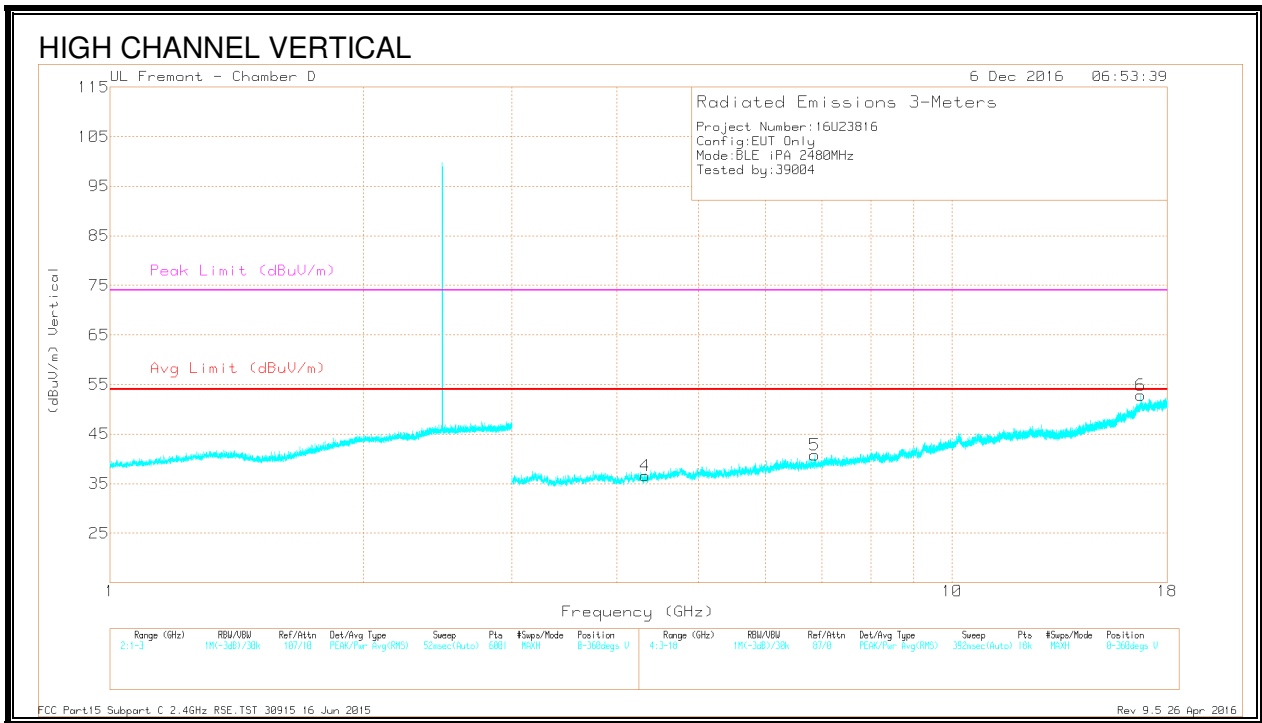
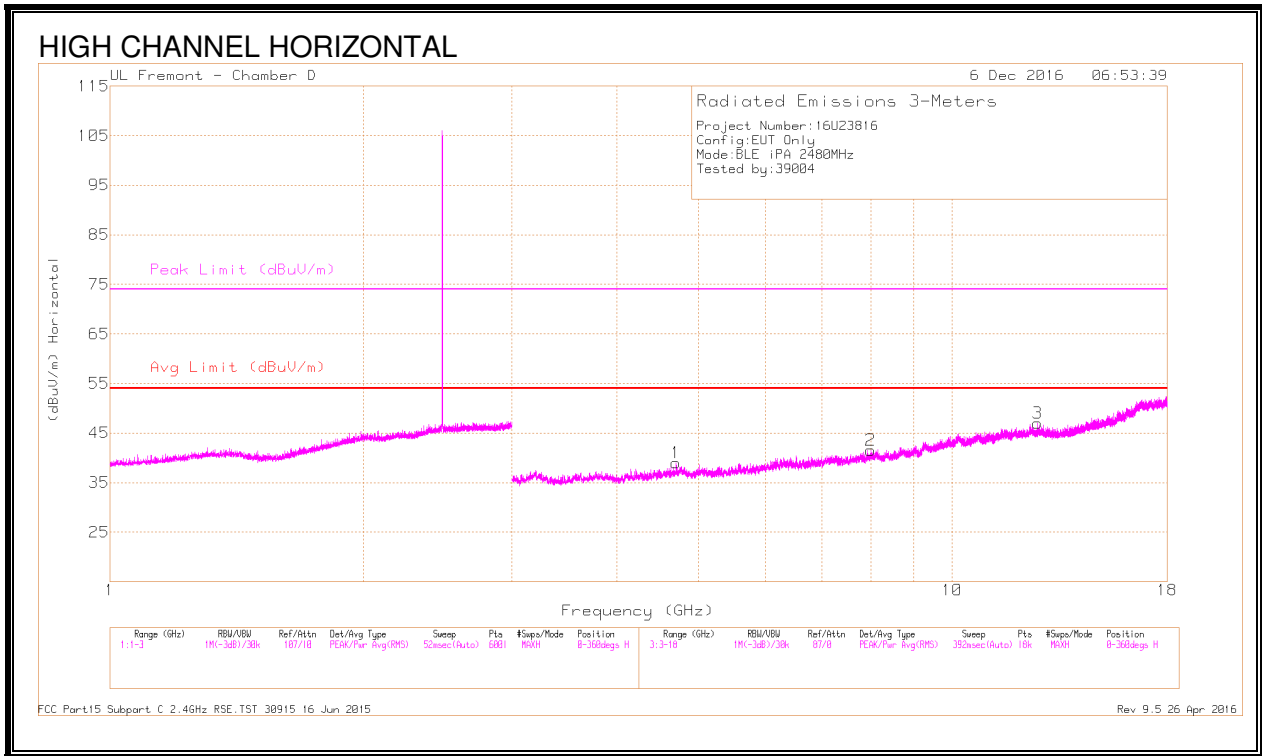

Marker	Frequen cy (GHz)	Meter Readin g (dBuV)	Det	AF T712 (dB/m)	Amp/Cb/FI tr/Pad (dB)	DC Corr (dB)	Correcte d Reading (dBuV/ m)	Avg Limit (dBuV/m)	Margi n (dB)	Peak Limit (dBuV/m)	PK Margin (dB)	Azimet h (Degs)	Heigh t (cm)	Polarit y
1	* 4.696	38.04	PK2	34	-27.3	0	44.74	-	-	74	-29.26	243	316	H
	* 4.695	27.59	MAv1	34	-27.3	0	34.29	54	-19.71	-	-	243	316	H
3	* 12.632	35.22	PK2	39.1	-21.2	0	53.12	-	-	74	-20.88	229	249	H
	* 12.629	23.97	MAv1	39.1	-21.4	0	41.67	54	-12.33	-	-	229	249	H
4	* 4.324	38.56	PK2	33.6	-28.5	0	43.66	-	-	74	-30.34	227	191	V
	* 4.321	27.65	MAv1	33.6	-28.4	0	32.85	54	-21.15	-	-	227	191	V
5	6.865	37.05	PK2	35.7	-25.8	0	46.95	-	-	-	-	335	266	V
2	8.002	35.53	PK2	35.8	-23.9	0	47.43	-	-	-	-	310	101	H
6	16.749	34.17	PK2	41.8	-17.4	0	58.57	-	-	-	-	51	264	V

* - indicates frequency in CFR47 Pt 15 / IC RSS-Restricted Band

PK2 - KDB558074 Method: Maximum Peak

MAv1 - KDB558074 Option 1 Maximum RMS Average

8.4. WORST-CASE CO-LOCATION

BLUETOOTH LOW ENERGY AND 802.11 HT20 2Tx CDD MODE IN THE 5.6GHz BAND

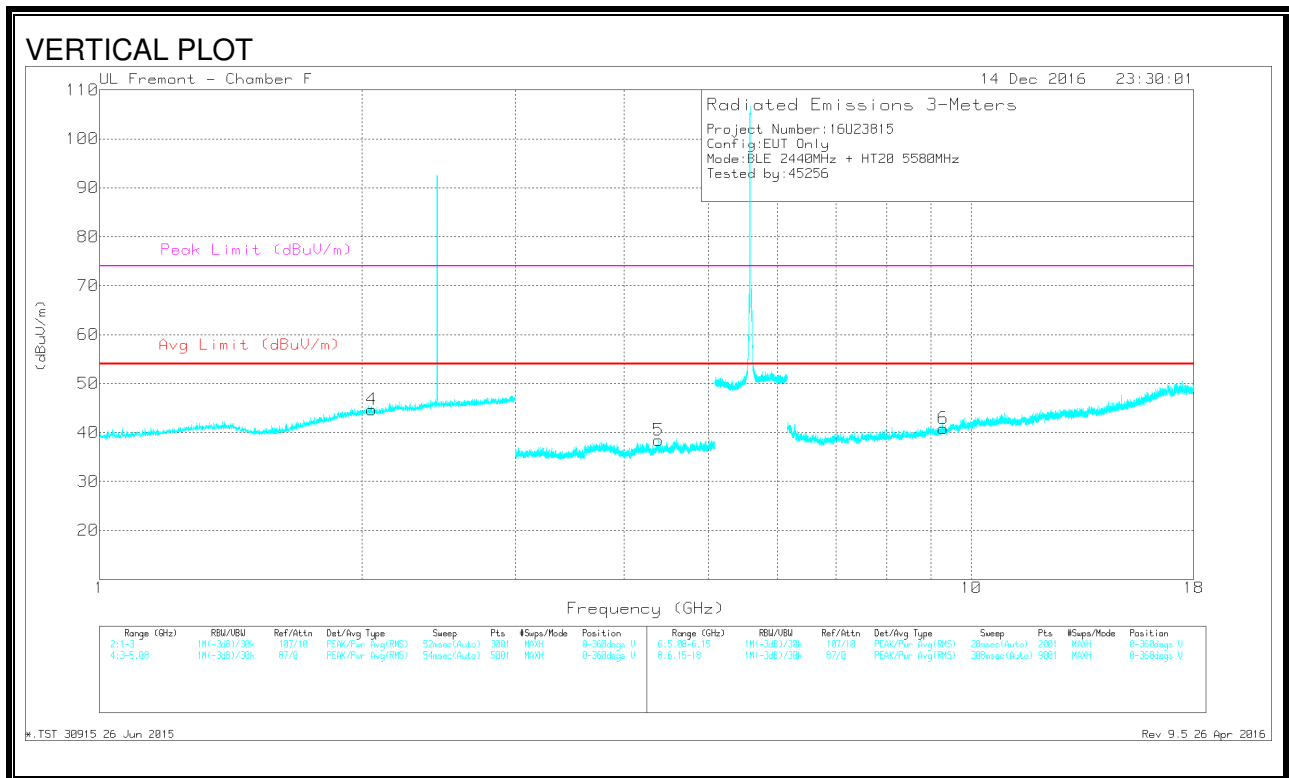
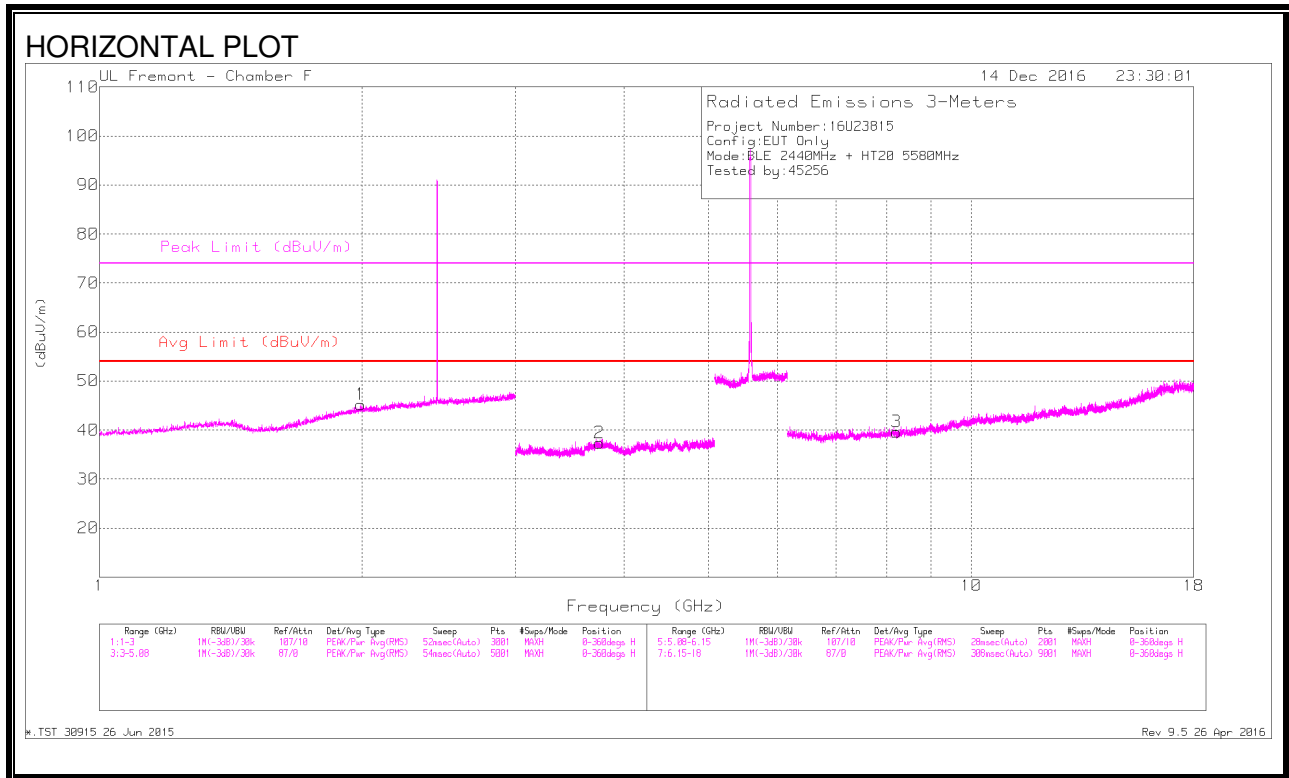

DATA

	Meter Reading (dBuV)	Det	AF T344 (dB/m)	Amp/Cbl /Ftr/Pad (dB)	DC Corr (dB)	Corrected Reading (dBuV/m)	Avg Limit (dBuV/m)	Margin (dB)	Peak Limit (dBuV/m)	Margin (dB)	Azimuth (Degs)	Height (cm)	Polarity
1.993	41.56	PK-U	31.5	-21.4	0	51.66			74	-22.34	148	200	H
1.992	30.44	ADR	31.5	-21.4	0	40.54	53.97	-13.43	-	-	148	200	H
2.053	42.44	PK-U	31.5	-21.4	0	52.54			74	-21.46	27	172	V
2.054	30.56	ADR	31.5	-21.4	0	40.66	53.97	-13.31	-	-	27	172	V
* 3.747	37.93	PK-U	33.4	-29.1	0	42.23			74	-31.77	167	301	H
* 3.746	27.75	ADR	33.4	-29.1	0	32.05	53.97	-21.92	-	-	167	301	H
* 4.38	38.94	PK-U	34	-28.9	0	44.04			74	-29.96	343	293	V
* 4.38	28.04	ADR	34	-28.9	0	33.14	53.97	-20.83	-	-	343	293	V
* 8.207	34.89	PK-U	35.8	-24.7	0	45.99			74	-28.01	39	254	H
* 8.205	24.69	ADR	35.8	-24.6	0	35.89	53.97	-18.08	-	-	39	254	H
9.29	34.28	PK-U	36.3	-22.6	0	47.98			74	-26.02	228	168	V
9.29	23.18	ADR	36.3	-22.6	0	36.88	53.97	-17.09	-	-	228	168	V

8.5. WORST-CASE BELOW 1 GHz

SPURIOUS EMISSIONS 30 TO 1000 MHz (WORST-CASE CONFIGURATION)

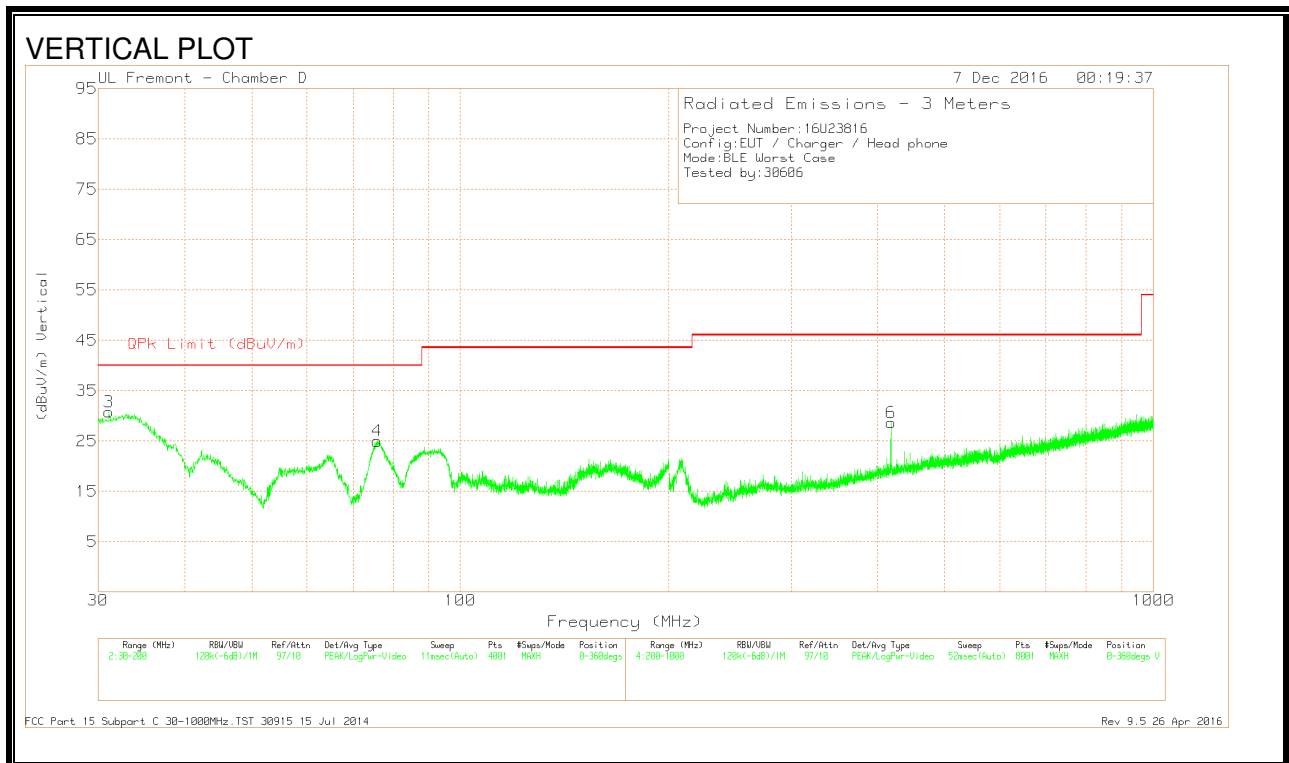
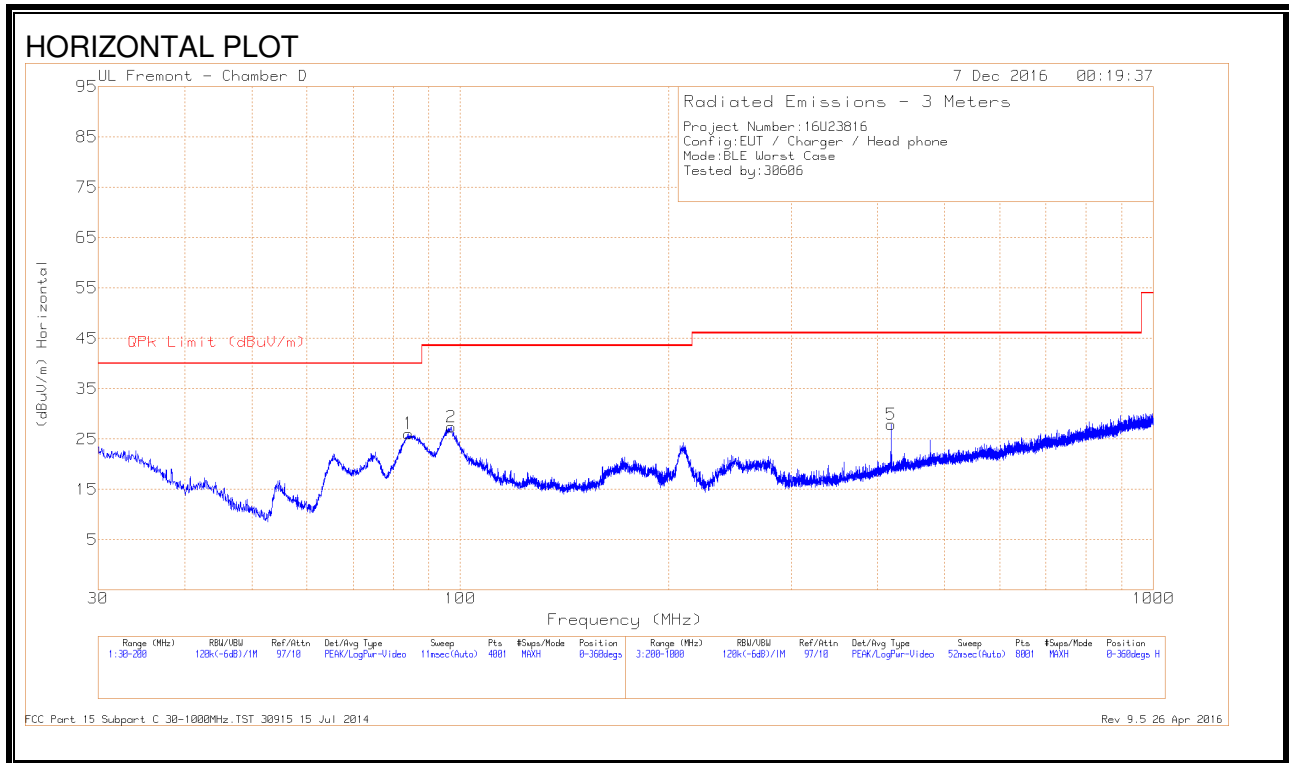

DATA

Marker	Frequenc y (MHz)	Meter Reading (dBuV)	Det	AF T243 (dB/m)	Amp/Cbl (dB)	Correcte d Reading (dBuV/m)	QPk Limit (dBuV/m)	Margin (dB)	Azimuth (Degs)	Height (cm)	Polarity
3	31.105	38.17	Pk	24.5	-31.9	30.77	40	-9.23	0-360	100	V
4	75.9	44.59	Pk	11.9	-31.5	24.99	40	-15.01	0-360	100	V
1	84.23	46.17	Pk	11.3	-31.4	26.07	40	-13.93	0-360	299	H
2	96.98	45.5	Pk	13.3	-31.4	27.4	43.52	-16.12	0-360	299	H
5	418.25	37.38	Pk	20.4	-29.9	27.88	46.02	-18.14	0-360	299	H
6	418.4	38.13	Pk	20.4	-29.9	28.63	46.02	-17.39	0-360	201	V

Pk - Peak detector

8.6. WORST-CASE ABOVE 18 GHz

SPURIOUS EMISSIONS 18 TO 26 GHz (WORST-CASE CONFIGURATION)

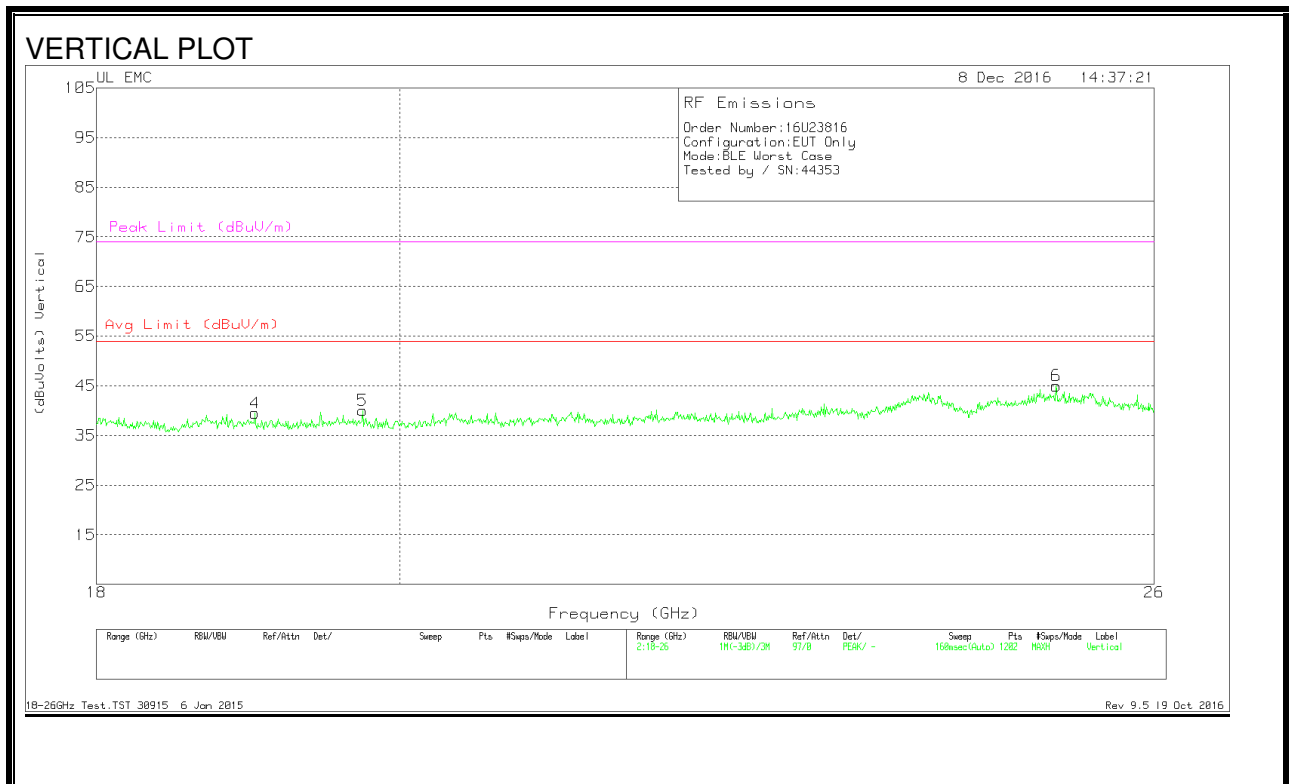
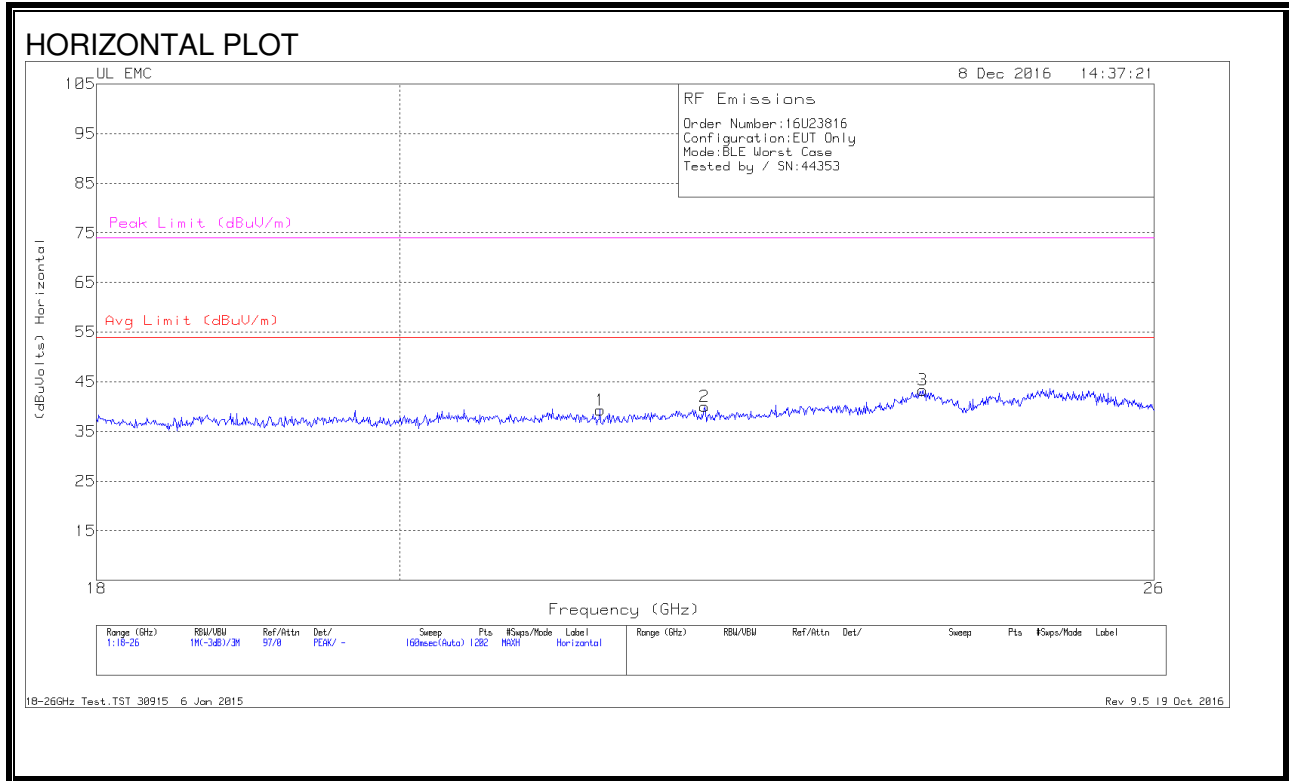

Data

Marker	Frequenc y (GHz)	Meter Reading (dBuV)	Det	AF T449 (dB/m)	Amp/Cbl (dB)	Dist Corr (dB)	Correcte d Reading (dBuVOLT s)	Avg Limit (dBuV/m)	Margin (dB)	Peak Limit (dBuV/m)	PK Margin (dB)
1	21.444	41.13	Pk	33.2	-25.5	-9.5	39.33	54	-14.67	74	-34.67
2	22.236	40.7	Pk	33.5	-24.7	-9.5	40	54	-14	74	-34
3	23.988	43.13	Pk	34	-24.3	-9.5	43.33	54	-10.67	74	-30.67
4	19.019	41.1	Pk	32.6	-24.7	-9.5	39.5	54	-14.5	74	-34.5
5	19.745	41.7	Pk	32.7	-24.9	-9.5	40	54	-14	74	-34
6	25.127	44.8	Pk	34.3	-24.6	-9.5	45	54	-9	74	-29

Pk - Peak detector

9. AC POWER LINE CONDUCTED EMISSIONS

LIMITS

FCC §15.207 (a)

RSS-Gen 8.8

Frequency of Emission (MHz)	Conducted Limit (dB μ V)	
	Quasi-peak	Average
0.15-0.5	66 to 56 *	56 to 46 *
0.5-5	56	46
5-30	60	50

*Decreases with the logarithm of the frequency.

TEST PROCEDURE

The EUT is placed on a non-conducting table 40 cm from the vertical ground plane and 80 cm above the horizontal ground plane. The EUT is configured in accordance with ANSI C63.10.

The receiver is set to a resolution bandwidth of 9 kHz. Peak detection is used unless otherwise noted as quasi-peak or average.

Line conducted data is recorded for both NEUTRAL and HOT lines.

RESULTS

9.1. EUT POWERED BY AC/DC ADAPTER VIA USB CABLE

LINE RESULTS

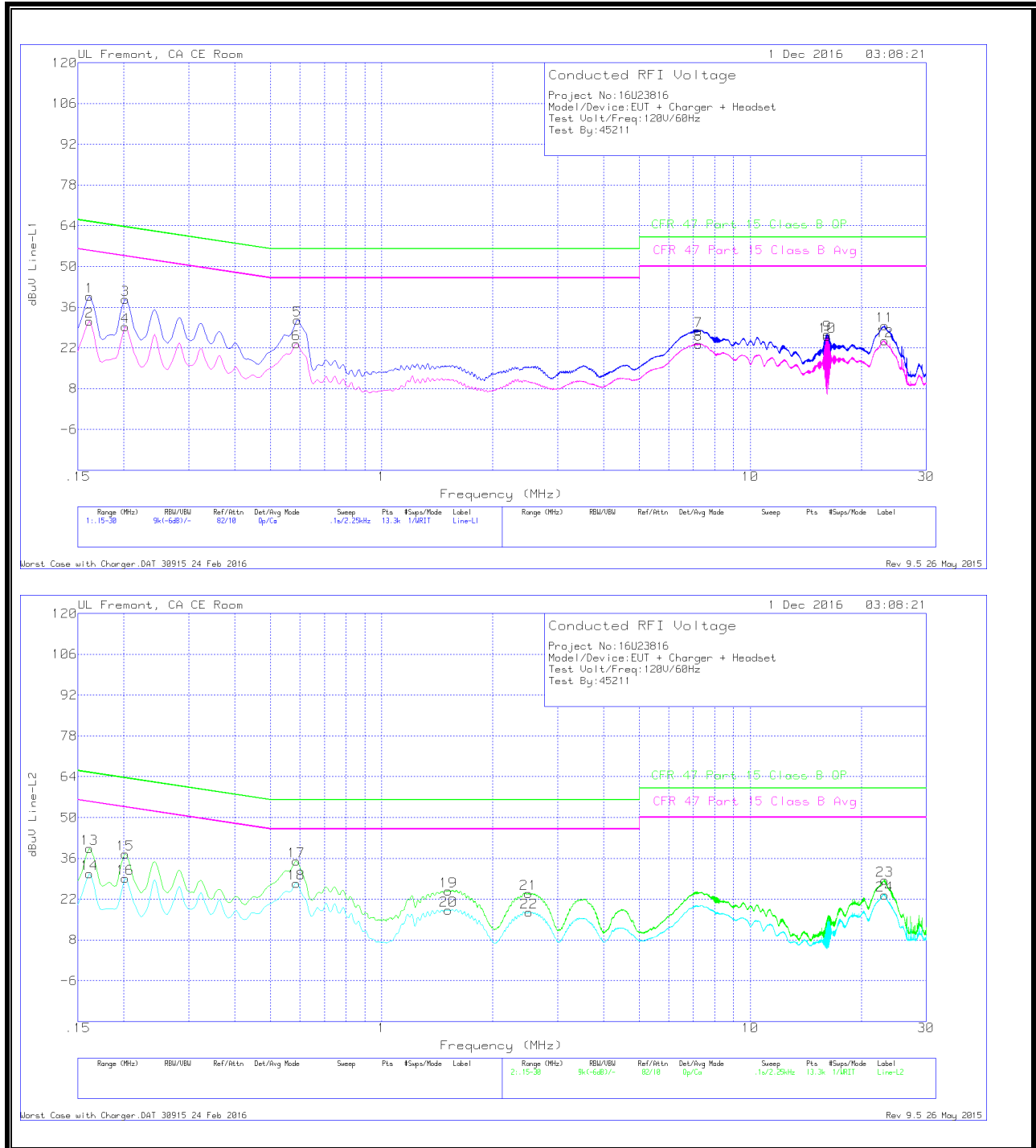

WORST EMISSIONS

Range 1: Line-L1 .15 - 30MHz											
Marker	Frequency (MHz)	Meter Reading (dBuV)	Det	LISN L1	LC Cables 1&3	Limiter (dB)	Corrected Reading dBuV	CFR 47 Part 15 Class B QP	QP Margin (dB)	CFR 47 Part 15 Class B Avg	Av(CISPR) Margin (dB)
1	.16125	29.67	Qp	0	0	10.1	39.77	65.4	-25.63	-	-
2	.16125	21.06	Ca	0	0	10.1	31.16	-	-	55.4	-24.24
3	.20175	28.66	Qp	0	0	10.1	38.76	63.54	-24.78	-	-
4	.20175	19.16	Ca	0	0	10.1	29.26	-	-	53.54	-24.28
5	.591	21.49	Qp	0	0	10.1	31.59	56	-24.41	-	-
6	.5865	13.27	Ca	0	0	10.1	23.37	-	-	46	-22.63
7	7.24425	17.65	Qp	0	.1	10.2	27.95	60	-32.05	-	-
8	7.23525	12.88	Ca	0	.1	10.2	23.18	-	-	50	-26.82
9	16.1588	16.26	Qp	0	.2	10.3	26.76	60	-33.24	-	-
10	16.1588	15.55	Ca	0	.2	10.3	26.05	-	-	50	-23.95
11	23.1315	18.96	Qp	.1	.2	10.4	29.66	60	-30.34	-	-
12	23.1293	13.79	Ca	.1	.2	10.4	24.49	-	-	50	-25.51
Range 2: Line-L2 .15 - 30MHz											
Marker	Frequency (MHz)	Meter Reading (dBuV)	Det	LISN L2	LC Cables 2&3	Limiter (dB)	Corrected Reading dBuV	CFR 47 Part 15 Class B QP	QP Margin (dB)	CFR 47 Part 15 Class B Avg	Av(CISPR) Margin (dB)
13	.16125	29.22	Qp	0	0	10.1	39.32	65.4	-26.08	-	-
14	.16125	20.54	Ca	0	0	10.1	30.64	-	-	55.4	-24.76
15	.20175	27.39	Qp	0	0	10.1	37.49	63.54	-26.05	-	-
16	.20175	18.97	Ca	0	0	10.1	29.07	-	-	53.54	-24.47
17	.5865	24.93	Qp	0	0	10.1	35.03	56	-20.97	-	-
18	.5865	17.35	Ca	0	0	10.1	27.45	-	-	46	-18.55
19	1.518	14.57	Qp	0	.1	10.1	24.77	56	-31.23	-	-
20	1.518	8.03	Ca	0	.1	10.1	18.23	-	-	46	-27.77
21	2.499	13.76	Qp	0	.1	10.1	23.96	56	-32.04	-	-
22	2.5125	7.24	Ca	0	.1	10.1	17.44	-	-	46	-28.56
23	23.1675	17.76	Qp	.1	.2	10.4	28.46	60	-31.54	-	-
24	23.1495	12.71	Ca	.1	.2	10.4	23.41	-	-	50	-26.59

Qp - Quasi-Peak detector

Ca - CISPR average detection

9.2. EUT POWERED BY HOST PC VIA USB CABLE

LINE RESULTS

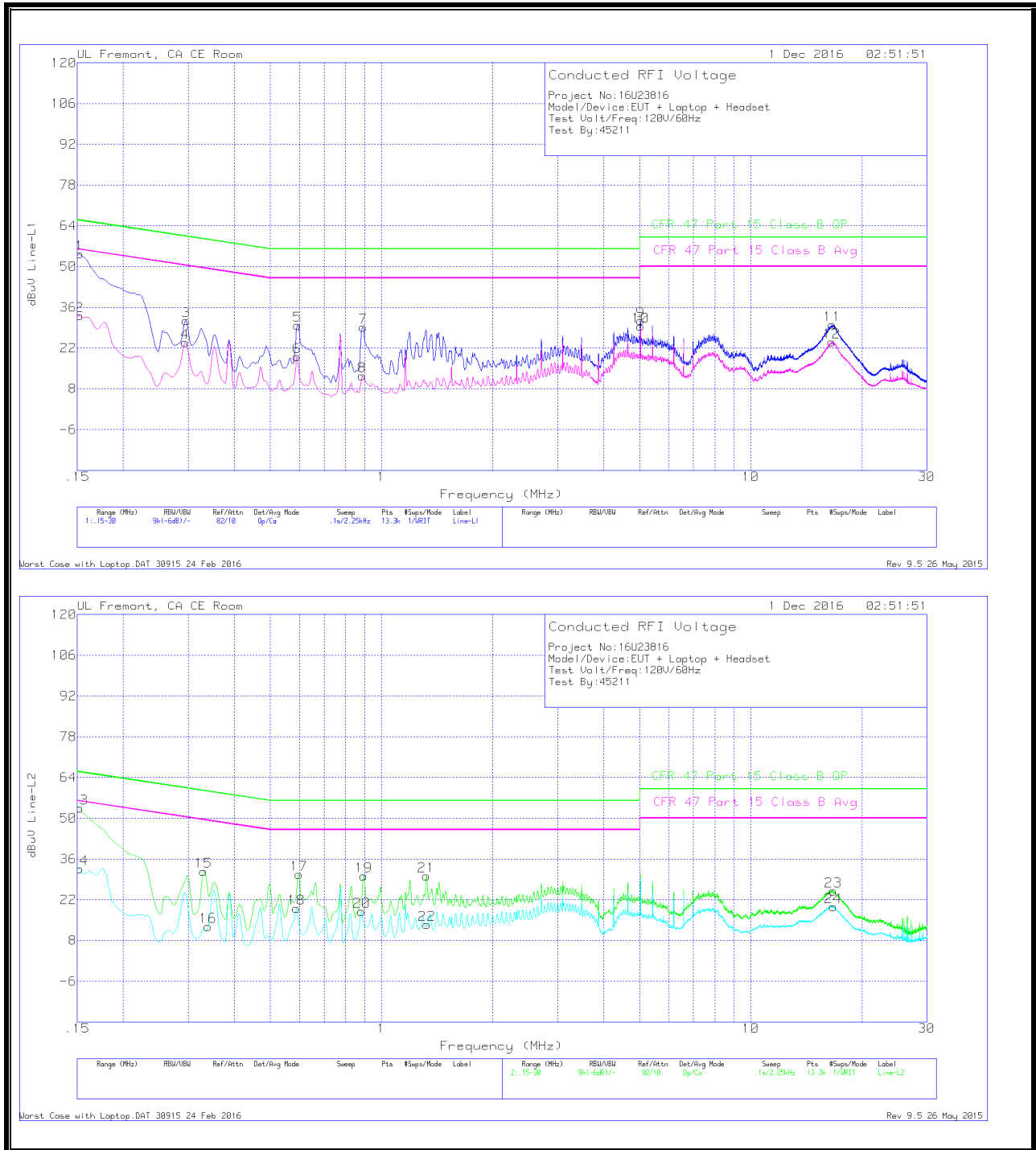

WORST EMISSIONS

Range 1: Line-L1 .15 - 30MHz											
Marker	Frequency (MHz)	Meter Reading (dBuV)	Det	LISN L1	LC Cables 1&3	Limiter (dB)	Corrected Reading dBuV	CFR 47 Part 15 Class B QP	QP Margin (dB)	CFR 47 Part 15 Class B Avg	Av(CISPR) Margin (dB)
1	.15225	44.18	Qp	.1	0	10.1	54.38	65.88	-11.5	-	-
2	.15225	22.94	Ca	.1	0	10.1	33.14	-	-	55.88	-22.74
3	.29625	21.36	Qp	0	0	10.1	31.46	60.35	-28.89	-	-
4	.294	13.8	Ca	0	0	10.1	23.9	-	-	50.41	-26.51
5	.59325	19.76	Qp	0	0	10.1	29.86	56	-26.14	-	-
6	.591	8.91	Ca	0	0	10.1	19.01	-	-	46	-26.99
7	.8925	19.11	Qp	0	0	10.1	29.21	56	-26.79	-	-
8	.888	2.33	Ca	0	0	10.1	12.43	-	-	46	-33.57
9	5.03025	21.19	Qp	0	.1	10.1	31.39	60	-28.61	-	-
10	5.03025	19.32	Ca	0	.1	10.1	29.52	-	-	50	-20.48
11	16.63125	19.49	Qp	0	.2	10.3	29.99	60	-30.01	-	-
12	16.5705	13.6	Ca	0	.2	10.3	24.1	-	-	50	-25.9
Range 2: Line-L2 .15 - 30MHz											
Marker	Frequency (MHz)	Meter Reading (dBuV)	Det	LISN L2	LC Cables 2&3	Limiter (dB)	Corrected Reading dBuV	CFR 47 Part 15 Class B QP	QP Margin (dB)	CFR 47 Part 15 Class B Avg	Av(CISPR) Margin (dB)
13	.15225	43.42	Qp	0	0	10.1	53.52	65.88	-12.36	-	-
14	.15225	22.5	Ca	0	0	10.1	32.6	-	-	55.88	-23.28
15	.33	21.71	Qp	0	0	10.1	31.81	59.45	-27.64	-	-
16	.339	2.67	Ca	0	0	10.1	12.77	-	-	49.23	-36.46
17	.59775	20.53	Qp	0	0	10.1	30.63	56	-25.37	-	-
18	.58875	9.02	Ca	0	0	10.1	19.12	-	-	46	-26.88
19	.89475	20.06	Qp	0	0	10.1	30.16	56	-25.84	-	-
20	.8835	7.96	Ca	0	0	10.1	18.06	-	-	46	-27.94
21	1.3245	20.06	Qp	0	.1	10.1	30.26	56	-25.74	-	-
22	1.32675	3.27	Ca	0	.1	10.1	13.47	-	-	46	-32.53
23	16.73475	14.54	Qp	0	.2	10.3	25.04	60	-34.96	-	-
24	16.73588	9.12	Ca	0	.2	10.3	19.62	-	-	50	-30.38

Qp - Quasi-Peak detector

Ca - CISPR average detection