



CERTIFICATION TEST REPORT

Report Number. : 16U23815-E4V6

Applicant : APPLE, INC
1 INFINITE LOOP
CUPERTINO, CA 95014, U.S.A.

Model : A1670

FCC ID : BCGA1670

EUT Description : TABLET DEVICE

Test Standard(s) : FCC 47 CFR PART 15 SUBPART E

Date Of Issue:

March 07, 2017

Prepared by:

UL Verification Services Inc.
47173 Benicia Street
Fremont, CA 94538, U.S.A.
TEL: (510) 771-1000
FAX: (510) 661-0888



Revision History

<u>Rev.</u>	<u>Issue Date</u>	<u>Revisions</u>	<u>Revised By</u>
V1	2/22/2017	Initial Review	Chin Pang
V2	2/27/2017	Revised report to address TCB's questions	Tina Chu
V3	2/28/2017	Revised report to address TCB's questions	Chin Pang
V4	03/02/2017	Revised report to address TCB's questions	Mengisut Mekuria
V5	03/03/2017	Address TCB's Question	Chin Pang
V6	03/07/2017	Update STBC power	Chin Pang

TABLE OF CONTENTS

1. ATTESTATION OF TEST RESULTS	12
2. TEST METHODOLOGY	13
3. FACILITIES AND ACCREDITATION	13
4. CALIBRATION AND UNCERTAINTY	14
4.1. MEASURING INSTRUMENT CALIBRATION.....	14
4.2. SAMPLE CALCULATION.....	14
4.3. MEASUREMENT UNCERTAINTY	14
5. EQUIPMENT UNDER TEST.....	15
5.1. DESCRIPTION OF EUT.....	15
5.2. MAXIMUM OUTPUT POWER.....	15
5.3. DESCRIPTION OF AVAILABLE ANTENNAS.....	19
5.4. SOFTWARE AND FIRMWARE	19
5.5. WORST-CASE CONFIGURATION AND MODE.....	20
5.6. DESCRIPTION OF TEST SETUP	21
6. TEST AND MEASUREMENT EQUIPMENT.....	27
7. ON TIME, DUTY CYCLE AND MEASUREMENT METHODS.....	28
7.1. ON TIME AND DUTY CYCLE.....	28
7.2. MEASUREMENT METHODS.....	32
8. ANTENNA PORT TEST RESULTS.....	33
8.1. 802.11n HT20 ANTENNA A MODE IN THE 5.2 GHz BAND.....	33
8.1.1. 26 dB BANDWIDTH	33
8.1.2. 99% BANDWIDTH.....	36
8.1.3. AVERAGE POWER.....	39
8.1.4. OUTPUT POWER AND PSD	40
8.2. 802.11n HT20 ANTENNA B MODE IN THE 5.2 GHz BAND.....	44
8.2.1. 26 dB BANDWIDTH	44
8.2.2. 99% BANDWIDTH.....	47
8.2.3. AVERAGE POWER.....	50
8.2.4. OUTPUT POWER AND PSD	51
8.3. 802.11n HT20 2Tx (ANTENNA A + ANTENNA B) CDD MODE IN THE 5.2 GHz BAND.....	55
8.3.1. 26 dB BANDWIDTH	55
8.3.2. 99% BANDWIDTH.....	59
8.3.3. AVERAGE POWER.....	63
8.3.4. OUTPUT POWER AND PSD	64
8.4. 802.11n HT20 2Tx (ANTENNA A + ANTENNA B) STBC MODE IN THE 5.2 GHz BAND.....	70
8.4.1. 26 dB BANDWIDTH	70
8.4.2. 99% BANDWIDTH.....	74

8.4.3.	AVERAGE POWER.....	78
8.4.4.	OUTPUT POWER AND PSD	79
8.5.	<i>802.11n HT40 ANTENNA A MODE IN THE 5.2 GHz BAND.....</i>	<i>85</i>
8.5.1.	26 dB BANDWIDTH	85
8.5.2.	99% BANDWIDTH.....	87
8.5.3.	AVERAGE POWER.....	89
8.5.4.	OUTPUT POWER AND PSD	90
8.6.	<i>802.11n HT40 ANTENNA B MODE IN THE 5.2 GHz BAND.....</i>	<i>93</i>
8.6.1.	26 dB BANDWIDTH	93
8.6.2.	99% BANDWIDTH.....	95
8.6.3.	AVERAGE POWER.....	97
8.6.4.	OUTPUT POWER AND PSD	98
8.7.	<i>802.11n HT40 2Tx (ANTENNA A + ANTENNA B) CDD MODE IN THE 5.2 GHz BAND.....</i>	<i>101</i>
8.7.1.	26 dB BANDWIDTH	101
8.7.2.	99% BANDWIDTH.....	104
8.7.3.	AVERAGE POWER.....	107
8.7.4.	OUTPUT POWER AND PSD	108
8.8.	<i>802.11n HT40 2Tx (ANTENNA A + ANTENNA B) STBC MODE IN THE 5.2 GHz BAND... </i>	<i>113</i>
8.9.	<i>802.11ac VHT80 ANTENNA A MODE IN THE 5.2 GHz BAND.....</i>	<i>114</i>
8.9.1.	26 dB BANDWIDTH	114
8.9.2.	99% BANDWIDTH.....	115
8.9.3.	AVERAGE POWER.....	116
8.9.4.	OUTPUT POWER AND PSD	117
8.10.	<i>802.11ac VHT80 ANTENNA B MODE IN THE 5.2 GHz BAND.....</i>	<i>120</i>
8.10.1.	26 dB BANDWIDTH.....	120
8.10.2.	99% BANDWIDTH.....	121
8.10.3.	AVERAGE POWER.....	122
8.10.4.	OUTPUT POWER AND PSD	123
8.11.	<i>802.11ac VHT80 2Tx (ANTENNA A + ANTENNA B) CDD MODE IN THE 5.2 GHz BAND 126</i>	
8.11.1.	26 dB BANDWIDTH.....	126
8.11.2.	99% BANDWIDTH.....	128
8.11.3.	AVERAGE POWER.....	130
8.11.4.	OUTPUT POWER AND PSD.....	131
8.12.	<i>802.11ac VHT80 2Tx (ANTENNA A + ANTENNA B) STBC MODE IN THE 5.2 GHz BAND 135</i>	
8.13.	<i>802.11n HT20 ANTENNA A MODE IN THE 5.3 GHz BAND.....</i>	<i>136</i>
8.13.1.	26 dB BANDWIDTH.....	136
8.13.2.	99% BANDWIDTH.....	139
8.13.3.	AVERAGE POWER.....	142
8.13.4.	OUTPUT POWER AND PSD	143
8.14.	<i>802.11n HT20 ANTENNA B MODE IN THE 5.3 GHz BAND.....</i>	<i>147</i>
8.14.1.	26 dB BANDWIDTH.....	147
8.14.2.	99% BANDWIDTH.....	150
8.14.3.	AVERAGE POWER.....	153
8.14.4.	OUTPUT POWER AND PSD	154
8.15.	<i>802.11n HT20 2Tx (ANTENNA A + ANTENNA B) CDD MODE IN THE 5.3 GHz BAND. </i>	<i>158</i>
8.15.1.	26 dB BANDWIDTH.....	158

8.15.2.	99% BANDWIDTH.....	162
8.15.3.	AVERAGE POWER.....	166
8.15.4.	OUTPUT POWER AND PSD.....	167
8.16.	<i>802.11n HT20 2Tx (ANTENNA A + ANTENNA B) STBC MODE IN THE 5.3 GHz BAND</i>	172
8.16.1.	26 dB BANDWIDTH.....	172
8.16.2.	99% BANDWIDTH.....	176
8.16.3.	AVERAGE POWER.....	180
8.16.4.	OUTPUT POWER AND PSD.....	181
8.17.	<i>802.11n HT40 ANTENNA A MODE IN THE 5.3 GHz BAND</i>	186
8.17.1.	26 dB BANDWIDTH.....	186
8.17.2.	99% BANDWIDTH.....	188
8.17.3.	AVERAGE POWER.....	190
8.17.4.	OUTPUT POWER AND PSD.....	191
8.18.	<i>802.11n HT40 ANTENNA B MODE IN THE 5.3 GHz BAND</i>	194
8.18.1.	26 dB BANDWIDTH.....	194
8.18.2.	99% BANDWIDTH.....	196
8.18.3.	AVERAGE POWER.....	198
8.18.4.	OUTPUT POWER AND PSD.....	199
8.19.	<i>802.11n HT40 2Tx (ANTENNA A + ANTENNA B) CDD MODE IN THE 5.3 GHz BAND</i>	202
8.19.1.	26 dB BANDWIDTH.....	202
8.19.2.	99% BANDWIDTH.....	205
8.19.3.	AVERAGE POWER.....	208
8.19.4.	OUTPUT POWER AND PSD.....	209
8.20.	<i>802.11n HT40 2Tx (ANTENNA A + ANTENNA B) STBC MODE IN THE 5.3 GHz BAND</i>	213
8.21.	<i>802.11ac VHT80 ANTENNA A MODE IN THE 5.3 GHz BAND</i>	214
8.21.1.	26 dB BANDWIDTH.....	214
8.21.2.	99% BANDWIDTH.....	215
8.21.3.	AVERAGE POWER.....	216
8.21.4.	OUTPUT POWER AND PSD.....	217
8.22.	<i>802.11ac VHT80 ANTENNA B MODE IN THE 5.3 GHz BAND</i>	220
8.22.1.	26 dB BANDWIDTH.....	220
8.22.2.	99% BANDWIDTH.....	221
8.22.3.	AVERAGE POWER.....	222
8.22.4.	OUTPUT POWER AND PSD.....	223
8.23.	<i>802.11ac VHT80 2Tx (ANTENNA A + ANTENNA B) CDD MODE IN THE 5.3 GHz BAND</i>	226
8.23.1.	26 dB BANDWIDTH.....	226
8.23.2.	99% BANDWIDTH.....	228
8.23.3.	AVERAGE POWER.....	230
8.23.4.	OUTPUT POWER AND PSD.....	231
8.24.	<i>802.11ac VHT80 2Tx (ANTENNA A + ANTENNA B) STBC MODE IN THE 5.3 GHz BAND</i>	234
8.25.	<i>802.11n HT20 ANTENNA A MODE IN THE 5.6 GHz BAND</i>	235
8.25.1.	26 dB BANDWIDTH.....	235
8.25.2.	99% BANDWIDTH.....	238
8.25.3.	AVERAGE POWER.....	241
8.25.4.	OUTPUT POWER AND PSD.....	242
8.26.	<i>802.11ac VHT20 ANTENNA A STRADDLE CHANNEL 144 RESULTS</i>	246

8.26.1.	OUTPUT POWER AND PSD	246
8.26.2.	6 dB BANDWIDTH.....	250
8.27.	<i>802.11n HT20 ANTENNA B MODE IN THE 5.6 GHz BAND</i>	<i>251</i>
8.27.1.	26 dB BANDWIDTH.....	251
8.27.2.	99% BANDWIDTH.....	254
8.27.3.	AVERAGE POWER.....	257
8.27.4.	OUTPUT POWER AND PSD.....	258
8.28.	<i>802.11ac VHT20 ANTENNA B STRADDLE CHANNEL 144 RESULTS</i>	<i>262</i>
8.28.1.	OUTPUT POWER AND PSD	262
8.28.2.	6 dB BANDWIDTH.....	266
8.29.	<i>802.11n HT20 2Tx (ANTENNA A + ANTENNA B) CDD MODE IN THE 5.6 GHz BAND ..</i>	<i>267</i>
8.29.1.	26 dB BANDWIDTH.....	267
8.29.2.	99% BANDWIDTH.....	272
8.29.3.	AVERAGE POWER.....	277
8.29.4.	OUTPUT POWER AND PSD.....	278
8.30.	<i>802.11ac VHT20 2Tx (ANTENNA A + ANTENNA B) CDD STRADDLE CHANNEL 144 RESULTS</i>	<i>284</i>
8.30.1.	OUTPUT POWER AND PSD	284
8.30.2.	6 dB BANDWIDTH.....	290
8.31.	<i>802.11n HT20 2Tx (ANTENNA A + ANTENNA B) STBC MODE IN THE 5.6 GHz BAND</i>	<i>292</i>
8.31.1.	26 dB BANDWIDTH.....	292
8.31.2.	99% BANDWIDTH.....	297
8.31.3.	AVERAGE POWER.....	302
8.31.4.	OUTPUT POWER AND PSD.....	303
8.32.	<i>802.11ac VHT20 2Tx (ANTENNA A + ANTENNA B) STBC STRADDLE CHANNEL 144 RESULTS</i>	<i>309</i>
8.32.1.	OUTPUT POWER AND PSD	309
8.32.2.	6 dB BANDWIDTH.....	315
8.33.	<i>802.11n HT40 ANTENNA A MODE IN THE 5.6 GHz BAND</i>	<i>317</i>
8.33.1.	26 dB BANDWIDTH.....	317
8.33.2.	99% BANDWIDTH.....	320
8.33.3.	AVERAGE POWER.....	323
8.33.4.	OUTPUT POWER AND PSD.....	324
8.34.	<i>802.11ac VHT40 ANTENNA A STRADDLE CH 142 RESULTS.....</i>	<i>328</i>
8.34.1.	OUTPUT POWER AND PSD	328
8.34.2.	6 dB BANDWIDTH.....	332
8.35.	<i>802.11n HT40 ANTENNA B MODE IN THE 5.6 GHz BAND</i>	<i>333</i>
8.35.1.	26 dB BANDWIDTH.....	333
8.35.2.	99% BANDWIDTH.....	336
8.35.3.	AVERAGE POWER.....	339
8.35.4.	OUTPUT POWER AND PSD.....	340
8.36.	<i>802.11ac VHT40 ANTENNA B STRADDLE CH 142 RESULTS.....</i>	<i>344</i>
8.36.1.	OUTPUT POWER AND PSD	344
8.36.2.	6 dB BANDWIDTH.....	348
8.37.	<i>802.11n HT40 2Tx (ANTENNA A + ANTENNA B) CDD MODE IN THE 5.6 GHz BAND ..</i>	<i>349</i>
8.37.1.	26 dB BANDWIDTH.....	349
8.37.2.	99% BANDWIDTH.....	354
8.37.3.	AVERAGE POWER.....	359

8.37.4. OUTPUT POWER AND PSD 360

8.38. 802.11ac VHT40 2Tx (ANTENNA A + ANTENNA B) CDD STRADDLE CHANNEL 142
RESULTS 366

8.38.1. OUTPUT POWER AND PSD 366

8.38.2. 6 dB BBANDWIDTH 372

8.39. 802.11n HT40 2Tx (ANTENNA A + ANTENNA B) STBC MODE IN THE 5.6 GHz BAND 374

8.40. 802.11ac VHT40 2Tx (ANTENNA A + ANTENNA B) STBC STRADDLE CHANNEL 142
RESULTS 375

8.41. 802.11ac VHT80 ANTENNA A MODE IN THE 5.6 GHz BAND 376

8.41.1. 26 dB BANDWIDTH..... 376

8.41.2. 99% BANDWIDTH..... 379

8.41.3. AVERAGE POWER..... 382

8.41.4. OUTPUT POWER AND PSD 383

8.41.5. STRADDLE CHANNEL 138 RESULTS..... 386

8.41.6. 6 dB BANDWIDTH..... 390

8.42. 802.11ac VHT80 ANTENNA B MODE IN THE 5.6 GHz BAND 391

8.42.1. 26 dB BANDWIDTH..... 391

8.42.2. 99% BANDWIDTH..... 394

8.42.3. AVERAGE POWER..... 397

8.42.4. OUTPUT POWER AND PSD 398

8.42.5. STRADDLE CHANNEL 138 RESULTS..... 401

8.42.6. 6 dB BANDWIDTH..... 405

8.43. 802.11ac VHT80 2Tx (ANTENNA A + ANTENNA B) CDD MODE IN THE 5.6 GHz BAND
(5610MHz for FCC only) 406

8.43.1. 26 dB BANDWIDTH..... 406

8.43.2. 99% BANDWIDTH..... 410

8.43.3. AVERAGE POWER..... 414

8.43.4. OUTPUT POWER AND PSD 415

8.43.5. STRADDLE CHANNEL 138 RESULTS..... 420

8.43.6. 6 dB BANDWIDTH..... 426

8.44. 802.11ac VHT80 2Tx (ANTENNA A + ANTENNA B) STBC MODE IN THE 5.6 GHz BAND
(5610MHz for FCC only) 428

8.45. 802.11n HT20 ANTENNA A MODE IN THE 5.8 GHz BAND 429

8.45.1. 6 dB BANDWIDTH..... 429

8.45.2. 26 dB BANDWIDTH..... 432

8.45.3. 99% BANDWIDTH..... 435

8.45.4. AVERAGE POWER..... 438

8.45.5. OUTPUT POWER..... 439

8.45.6. PSD 441

8.46. 802.11n HT20 ANTENNA B MODE IN THE 5.8 GHz BAND 444

8.46.1. 6 dB BANDWIDTH..... 444

8.46.2. 26 dB BANDWIDTH..... 447

8.46.3. 99% BANDWIDTH..... 450

8.46.4. AVERAGE POWER..... 453

8.46.5. OUTPUT POWER..... 454

8.46.6. PSD 456

8.47. 802.11n HT20 2Tx (ANTENNA A + ANTENNA B) CDD MODE IN THE 5.8 GHz BAND . 459

8.47.1. 6 dB BANDWIDTH..... 459

8.47.2.	26 dB BANDWIDTH.....	463
8.47.3.	99% BANDWIDTH.....	467
8.47.4.	AVERAGE POWER.....	471
8.47.5.	OUTPUT POWER.....	472
8.47.6.	PSD.....	474
8.48.	<i>802.11n HT20 2Tx (ANTENNA A + ANTENNA B) STBC MODE IN THE 5.8 GHz BAND</i>	479
8.49.	<i>802.11n HT40 ANTENNA A MODE IN THE 5.8 GHz BAND</i>	480
8.49.1.	6 dB BANDWIDTH.....	480
8.49.2.	26 dB BANDWIDTH.....	482
8.49.3.	99% BANDWIDTH.....	484
8.49.4.	AVERAGE POWER.....	486
8.49.5.	OUTPUT POWER.....	487
8.49.6.	PSD.....	489
8.50.	<i>802.11n HT40 ANTENNA B MODE IN THE 5.8 GHz BAND</i>	492
8.50.1.	6 dB BANDWIDTH.....	492
8.50.2.	26 dB BANDWIDTH.....	494
8.50.3.	99% BANDWIDTH.....	496
8.50.4.	AVERAGE POWER.....	498
8.50.5.	OUTPUT POWER.....	499
8.50.6.	PSD.....	501
8.51.	<i>802.11n HT40 2Tx (ANTENNA A + ANTENNA B) CDD MODE IN THE 5.8 GHz BAND</i> .	504
8.51.1.	6 dB BANDWIDTH.....	504
8.51.2.	26 dB BANDWIDTH.....	507
8.51.3.	99% BANDWIDTH.....	510
8.51.4.	AVERAGE POWER.....	513
8.51.5.	OUTPUT POWER.....	514
8.51.6.	PSD.....	516
8.52.	<i>802.11n HT40 2Tx (ANTENNA A + ANTENNA B) STBC MODE IN THE 5.8 GHz BAND</i>	520
8.53.	<i>802.11ac VHT80 ANTENNA A MODE IN THE 5.8 GHz BAND</i>	521
8.53.1.	6 dB BANDWIDTH.....	521
8.53.2.	26 dB BANDWIDTH.....	522
8.53.3.	99% BANDWIDTH.....	523
8.53.4.	AVERAGE POWER.....	524
8.53.5.	OUTPUT POWER.....	525
8.53.6.	PSD.....	527
8.54.	<i>802.11ac VHT80 ANTENNA B MODE IN THE 5.8 GHz BAND</i>	529
8.54.1.	6 dB BANDWIDTH.....	529
8.54.2.	26 dB BANDWIDTH.....	530
8.54.3.	99% BANDWIDTH.....	531
8.54.4.	AVERAGE POWER.....	532
8.54.5.	OUTPUT POWER.....	533
8.54.6.	PSD.....	535
8.55.	<i>802.11ac VHT80 2Tx (ANTENNA A + ANTENNA B) CDD MODE IN THE 5.8 GHz BAND</i> <i>537</i>	
8.55.1.	6 dB BANDWIDTH.....	537
8.55.2.	26 dB BANDWIDTH.....	539
8.55.3.	99% BANDWIDTH.....	541
8.55.4.	AVERAGE POWER.....	543
8.55.5.	OUTPUT POWER.....	544

8.55.6. PSD 546

8.56. 802.11ac VHT80 2Tx (ANTENNA A + ANTENNA B) STBC MODE IN THE 5.8 GHz BAND
549

9. RADIATED RESULTS 550

9.1. LIMITS AND PROCEDURE..... 550

9.2. TRANSMITTER ABOVE 1 GHz..... 551

9.2.1. 11n HT20 ANTENNA A SISO MODE IN THE 5.2GHz BAND 551
9.2.2. 11n HT20 ANTENNA B SISO MODE IN THE 5.2GHz BAND 559
9.2.3. 11n HT20 2TX CDD MIMO MODE IN THE 5.2GHz BAND 567
9.2.4. 11n HT40 ANTENNA A SISO MODE IN THE 5.2GHz BAND 575
9.2.5. 11n HT40 ANTENNA B SISO MODE IN THE 5.2GHz BAND 581
9.2.6. 11n HT40 2TX CDD MIMO MODE IN THE 5.2GHz BAND 587
9.2.7. 11ac HT80 ANTENNA A SISO MODE IN THE 5.2GHz BAND 593
9.2.8. 11ac HT80 ANTENNA B SISO MODE IN THE 5.2GHz BAND 597
9.2.9. 11ac HT80 2TX CDD MIMO MODE IN THE 5.2GHz BAND 601
9.2.10. 11n HT20 ANTENNA A SISO MODE IN THE 5.3GHz BAND..... 605
9.2.11. 11n HT20 ANTENNA B SISO MODE IN THE 5.3GHz BAND..... 613
9.2.12. 11n HT20 2TX CDD MIMO MODE IN THE 5.3GHz BAND 621
9.2.13. 11n HT40 ANTENNA A SISO MODE IN THE 5.3GHz BAND..... 629
9.2.14. 11n HT40 ANTENNA B SISO MODE IN THE 5.3GHz BAND..... 635
9.2.15. 11n HT40 2TX CDD MIMO MODE IN THE 5.3GHz BAND 641
9.2.16. 11ac HT80 ANTENNA A SISO MODE IN THE 5.3GHz BAND..... 647
9.2.17. 11ac HT80 ANTENNA B SISO MODE IN THE 5.3GHz BAND..... 651
9.2.18. 11ac HT80 2TX CDD MIMO MODE IN THE 5.3GHz BAND..... 655
9.2.19. 11n HT20 ANTENNA A SISO MODE IN THE 5.6GHz BAND..... 659
9.2.20. 11ac HT20 ANTENNA A SISO STRADDLE CHANNEL 144 669
9.2.21. 11n HT20 ANTENNA B SISO MODE IN THE 5.6GHz BAND..... 671
9.2.22. 11ac HT20 ANTENNA B SISO STRADDLE CHANNEL 144 681
9.2.23. 11n HT20 2TX CDD MIMO MODE IN THE 5.6GHz BAND 683
9.2.24. 11ac HT20 2TX CDD MIMO STRADDLE CHANNEL 144 693
9.2.25. 11n HT40 ANTENNA A SISO MODE IN THE 5.6GHz BAND..... 695
9.2.26. 11ac HT40 ANTENNA A SISO STRADDLE CHANNEL 142 705
9.2.27. 11n HT40 ANTENNA B SISO MODE IN THE 5.6GHz BAND..... 707
9.2.28. 11ac HT40 ANTENNA B SISO STRADDLE CHANNEL 142 717
9.2.29. 11n HT40 2TX CDD MIMO MODE IN THE 5.6GHz BAND 719
9.2.30. 11ac HT40 2TX CDD MIMO STRADDLE CHANNEL 142 729
9.2.31. 11ac HT80 ANTENNA A SISO MODE IN THE 5.6GHz BAND..... 731
9.2.32. 11ac HT80 ANTENNA A SISO STRADDLE CHANNEL 138 737
9.2.33. 11ac HT80 ANTENNA B SISO MODE IN THE 5.6GHz BAND..... 739
9.2.34. 11ac HT80 ANTENNA B SISO STRADDLE CHANNEL 138 745
9.2.35. 11ac HT80 2TX CDD MIMO MODE IN THE 5.6GHz BAND..... 747
9.2.36. 11ac HT80 2TX CDD MIMO STRADDLE CHANNEL 138..... 753
9.2.37. 11n HT20 ANTENNA A SISO MODE IN THE 5.8GHz BAND..... 755
9.2.38. 11n HT20 ANTENNA B SISO MODE IN THE 5.8GHz BAND..... 765
9.2.39. 11n HT20 2TX CDD MIMO MODE IN THE 5.8GHz BAND 775
9.2.40. 11n HT40 ANTENNA A SISO MODE IN THE 5.8GHz BAND..... 785
9.2.41. 11n HT40 ANTENNA B SISO MODE IN THE 5.8GHz BAND..... 793
9.2.42. 11n HT40 2TX CDD MIMO MODE IN THE 5.8GHz BAND 801
9.2.43. 11ac HT80 ANTENNA A SISO MODE IN THE 5.8GHz BAND..... 809
9.2.44. 11ac HT80 ANTENNA B SISO MODE IN THE 5.8GHz BAND..... 815
9.2.45. 11ac HT80 2TX CDD MIMO MODE IN THE 5.8GHz BAND..... 821

9.3.	WORST-CASE CO-LOCATION.....	827
9.4.	WORST-CASE BELOW 1 GHz.....	831
9.5.	WORST-CASE 18 to 26 GHz.....	833
9.6.	WORST-CASE 26 to 40 GHz.....	835
10.	AC POWER LINE CONDUCTED EMISSIONS.....	837
10.1.	EUT POWERED BY AC/DC ADAPTER VIA USB CABLE.....	838
10.2.	EUT POWERED BY HOST PC VIA USB CABLE.....	840
11.	DYNAMIC FREQUENCY SELECTION.....	842
11.1.	OVERVIEW.....	842
11.1.1.	LIMITS.....	842
11.1.2.	TEST AND MEASUREMENT SYSTEM.....	846
11.1.3.	TEST AND MEASUREMENT SOFTWARE.....	848
11.1.4.	SETUP OF EUT (CLIENT MODE).....	849
11.1.5.	SETUP OF EUT (CLIENT-TO-CLIENT COMMUNICATIONS MODE).....	850
11.1.6.	DESCRIPTION OF EUT.....	851
11.2.	CLIENT MODE RESULTS FOR 20 MHz BANDWIDTH.....	853
11.2.1.	TEST CHANNEL.....	853
11.2.2.	RADAR WAVEFORM AND TRAFFIC.....	853
11.2.3.	OVERLAPPING CHANNEL TESTS.....	856
11.2.4.	MOVE AND CLOSING TIME.....	856
11.3.	CLIENT MODE RESULTS FOR 40 MHz BANDWIDTH.....	860
11.3.1.	TEST CHANNEL.....	860
11.3.2.	RADAR WAVEFORM AND TRAFFIC.....	860
11.3.3.	OVERLAPPING CHANNEL TESTS.....	863
11.3.4.	MOVE AND CLOSING TIME.....	863
11.4.	CLIENT MODE RESULTS FOR 80 MHz BANDWIDTH.....	867
11.4.1.	TEST CHANNEL.....	867
11.4.2.	RADAR WAVEFORM AND TRAFFIC.....	867
11.4.3.	OVERLAPPING CHANNEL TESTS.....	870
11.4.4.	MOVE AND CLOSING TIME.....	870
11.4.5.	10-MINUTE CLIENT Tx MONITORING PERIOD.....	874
11.5.	CLIENT-TO-CLIENT COMMUNICATIONS MODE RESULTS FOR 20 MHz BANDWIDTH 875	
11.5.1.	TEST CHANNEL.....	875
11.5.2.	RADAR WAVEFORM AND TRAFFIC.....	875
11.5.3.	OVERLAPPING CHANNEL TESTS.....	878
11.5.4.	MOVE AND CLOSING TIME.....	878
11.6.	CLIENT-TO-CLIENT COMMUNICATIONS MODE RESULTS FOR 40 MHz BANDWIDTH 882	
11.6.1.	TEST CHANNEL.....	882
11.6.2.	RADAR WAVEFORM AND TRAFFIC.....	882
11.6.3.	OVERLAPPING CHANNEL TESTS.....	885
11.6.4.	MOVE AND CLOSING TIME.....	885
11.7.	CLIENT-TO-CLIENT COMMUNICATIONS MODE RESULTS FOR 80 MHz BANDWIDTH 889	

11.7.1.	TEST CHANNEL.....	889
11.7.2.	RADAR WAVEFORM AND TRAFFIC.....	889
11.7.3.	OVERLAPPING CHANNEL TESTS.....	892
11.7.4.	MOVE AND CLOSING TIME	892
11.7.5.	10-MINUTE CLIENT Tx MONITORING PERIOD.....	896
12.	SETUP PHOTOS.....	897

1. ATTESTATION OF TEST RESULTS

COMPANY NAME: APPLE, INC.
1 INFINITE LOOP
CUPERTINO, CA 95014, U.S.A.

EUT DESCRIPTION: TABLET DEVICE

MODEL: A1670

SERIAL NUMBER: DLXST01UHPK9 (CONDUCTED), DLXST01WHPK9 (RADIATED),
DLXST011HPK5 (DFS)

DATE TESTED: NOVEMBER 28, 2016 – FEBRUARY 28, 2017

APPLICABLE STANDARDS	
STANDARD	TEST RESULTS
CFR 47 Part 15 Subpart E	Pass

UL Verification Services Inc. tested the above equipment in accordance with the requirements set forth in the above standards. All indications of Pass/Fail in this report are opinions expressed by UL Verification Services Inc. based on interpretations and/or observations of test results. Measurement Uncertainties were not taken into account and are published for informational purposes only. The test results show that the equipment tested is capable of demonstrating compliance with the requirements as documented in this report.

Note: The results documented in this report apply only to the tested sample, under the conditions and modes of operation as described herein. This document may not be altered or revised in any way unless done so by UL Verification Services Inc. and all revisions are duly noted in the revisions section. Any alteration of this document not carried out by UL Verification Services Inc. will constitute fraud and shall nullify the document. This report must not be used by the client to claim product certification, approval, or endorsement by NVLAP, NIST, any agency of the Federal Government, or any agency of any government.

Approved & Released For
UL Verification Services Inc. By:

Prepared By:

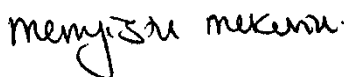

MENGISTU MEKURIA
SENIOR ENGINEER
UL VERIFICATION SERVICES INC.

FRANCISCO GUARNERO
EMC LAB ENGINEER
UL VERIFICATION SERVICES INC.

2. TEST METHODOLOGY

FCC: The tests documented in this report were performed in accordance with FCC CFR 47 Part 2, FCC CFR 47 Part 15, FCC 14-30, FCC KDB 662911 D01 v02r01, FCC KDB 905462 D02 v02/D03 v01r02/D06 v02/ D07 v02, FCC KDB 789033 D02 v01r03, FCC KDB 644545 D03 v01, ANSI C63.10-2013.

3. FACILITIES AND ACCREDITATION

The test sites and measurement facilities used to collect data are located at 47173 and 47266 Benicia Street, Fremont, California, USA. Line conducted emissions are measured only at the 47173 address. The following table identifies which facilities were utilized for radiated emission measurements documented in this report. Specific facilities are also identified in the test results sections.

47173 Benicia Street	47266 Benicia Street
<input type="checkbox"/> Chamber A (IC:2324B-1)	<input checked="" type="checkbox"/> Chamber D (IC:2324B-4)
<input type="checkbox"/> Chamber B (IC:2324B-2)	<input checked="" type="checkbox"/> Chamber E (IC:2324B-5)
<input type="checkbox"/> Chamber C (IC:2324B-3)	<input type="checkbox"/> Chamber F (IC:2324B-6)
	<input type="checkbox"/> Chamber G (IC:2324B-7)
	<input type="checkbox"/> Chamber H (IC:2324B-8)

The above test sites and facilities are covered under FCC Test Firm Registration # 208313.

UL Verification Services Inc. is accredited by NVLAP, Laboratory Code 200065-0. The full scope of accreditation can be viewed at <http://ts.nist.gov/standards/scopes/2000650.htm>.

4. CALIBRATION AND UNCERTAINTY

4.1. MEASURING INSTRUMENT CALIBRATION

The measuring equipment utilized to perform the tests documented in this report has been calibrated in accordance with the manufacturer's recommendations, and is traceable to recognized national standards.

4.2. SAMPLE CALCULATION

Where relevant, the following sample calculation is provided:

$$\begin{aligned} \text{Field Strength (dBuV/m)} &= \text{Measured Voltage (dBuV)} + \text{Antenna Factor (dB/m)} + \text{Cable} \\ &\text{Loss (dB)} - \text{Preamp Gain (dB)} \\ 36.5 \text{ dBuV} + 18.7 \text{ dB/m} + 0.6 \text{ dB} - 26.9 \text{ dB} &= 28.9 \text{ dBuV/m} \end{aligned}$$

4.3. MEASUREMENT UNCERTAINTY

Where relevant, the following measurement uncertainty levels have been estimated for tests performed on the apparatus:

PARAMETER	UNCERTAINTY
Conducted Disturbance, 9KHz to 0.15 MHz	3.84 dB
Conducted Disturbance, 0.15 to 30 MHz	3.65 dB
Radiated Disturbance, 9KHz to 30 MHz	3.15 dB
Radiated Disturbance, 30 to 1000 MHz	5.36 dB
Radiated Disturbance, 1000 to 18000 MHz	4.32 dB
Radiated Disturbance, 18000 to 26000 MHz	4.45 dB
Radiated Disturbance, 26000 to 40000 MHz	5.24 dB

Uncertainty figures are valid to a confidence level of 95%.

5. EQUIPMENT UNDER TEST

5.1. DESCRIPTION OF EUT

The EUT is a tablet with multimedia functions (music, application support, and video), IEEE 802.11a/b/g/n/ac radio, and Bluetooth radio. The rechargeable battery is not user accessible.

5.2. MAXIMUM OUTPUT POWER

The transmitter has a maximum average conducted output power as follows:

NOTE: Covered modes are test reduction modes. The output powers on the “covered modes are equal to or less than the mode referenced and use the same modulation.

5.2GHz Band FCC

Frequency Range (MHz)	Mode	Output Power (dBm)	Output Power (mW)
5180 - 5240	802.11a	Covered by 802.11n HT20 SISO	
	802.11n HT20 SISO	16.90	48.98
	802.11a 2TX CDD	Covered by 802.11n HT20 2TX CDD	
	802.11n HT20 2TX CDD	18.44	69.82
	802.11n HT20 2TX STBC	19.46	88.31
	802.11n HT20 2TX SDM	Covered by 802.11n HT20 2TX STBC	
	802.11a VHT20 2TX SDM	Covered by 802.11n HT20 2TX STBC	
5190 - 5230	802.11n HT40 SISO	16.94	49.43
	802.11n HT40 2TX CDD	19.51	89.33
	802.11n HT40 2TX STBC	Covered by 802.11n HT40 2TX CDD	
	802.11a VHT40 2TX STBC	Covered by 802.11n HT40 2TX CDD	
	802.11n HT40 2TX SDM	Covered by 802.11n HT40 2TX CDD	
	802.11a VHT40 2TX SDM	Covered by 802.11n HT40 2TX CDD	
5210	802.11a VHT80 SISO	13.48	22.28
	802.11a VHT80 2TX CDD	14.89	30.83
	802.11a VHT80 2TX STBC	Covered by 802.11a VHT80 2TX CDD	
	802.11a VHT80 2TX SDM	Covered by 802.11a VHT80 2TX CDD	

5.3GHz Band

Frequency Range (MHz)	Mode	Output Power (dBm)	Output Power (mW)
5260 - 5320	802.11a	Covered by 802.11n HT20 SISO	
	802.11n HT20 SISO	15.99	39.72
	802.11a 2TX CDD	Covered by 802.11n HT20 2TX CDD	
	802.11n HT20 2TX CDD	17.97	62.66
	802.11n HT20 2TX STBC	18.96	78.70
	802.11n HT20 2TX SDM	Covered by 802.11n HT20 2TX STBC	
	802.11ac VHT20 2TX SDM	Covered by 802.11n HT20 2TX STBC	
5270 - 5310	802.11n HT40 SISO	15.91	38.99
	802.11n HT40 2TX CDD	18.99	79.25
	802.11n HT40 2TX STBC	Covered by 802.11n HT40 2TX CDD	
	802.11acV HT40 2TX STBC	Covered by 802.11n HT40 2TX CDD	
	802.11n HT40 2TX SDM	Covered by 802.11n HT40 2TX CDD	
	802.11ac VHT40 2TX SDM	Covered by 802.11n HT40 2TX CDD	
5290	802.11ac VHT80 SISO	13.50	22.39
	802.11ac VHT80 2TX CDD	14.42	27.67
	802.11ac VHT80 2TX STBC	Covered by 802.11ac VHT80 2TX CDD	
	802.11ac VHT80 2TX SDM	Covered by 802.11ac VHT80 2TX CDD	

5.6GHz Band FCC

Frequency Range (MHz)	Mode	Output Power (dBm)	Output Power (mW)
5500 - 5700	802.11a	Covered by 802.11n HT20 SISO	
5500 - 5700	802.11n HT20 SISO	14.99	31.55
5720	802.11ac VHT20 SISO (based on UNII-2C band output power)	14.00	25.12
5500 - 5700	802.11a 2TX CDD	Covered by 802.11n HT20 2TX CDD	
5500 - 5700	802.11n HT20 2TX CDD	16.96	49.66
5720	802.11ac VHT20 2TX CDD (based on UNII-2C band output power)	15.88	38.73
5500 - 5700	802.11n HT20 2TX STBC	17.94	62.23
5720	802.11ac VHT20 2TX STBC (based on UNII-2C band output power)	16.28	42.46
5500 - 5700	802.11n HT20 2TX SDM	Covered by 802.11n HT20 2TX STBC	
5500 - 5700	802.11ac VHT20 2TX SDM	Covered by 802.11n HT20 2TX STBC	
5720	802.11ac VHT20 2TX SDM (based on UNII-2C band output power)	Covered by 802.11n HT20 2TX STBC	
5510 - 5670	802.11n HT40 SISO	14.95	31.26
5710	802.11ac VHT40 SISO (based on UNII-2C band output power)	14.04	25.35
5510 - 5670	802.11n HT40 2TX CDD	17.99	62.95
5710	802.11ac VHT40 2TX CDD (based on UNII-2C band output power)	16.99	50.00
5510 - 5670	802.11n HT40 2TX STBC	Covered by 802.11n HT40 2TX CDD	
5510 - 5670	802.11ac VHT40 2TX STBC	Covered by 802.11n HT40 2TX CDD	
5710	802.11ac VHT40 2TX STBC (based on UNII-2C band output power)	Covered by 802.11n HT40 2TX CDD	
5510 - 5670	802.11n HT40 2TX SDM	Covered by 802.11n HT40 2TX CDD	
5510 - 5670	802.11ac VHT40 2TX SDM	Covered by 802.11n HT40 2TX CDD	
5710	802.11ac VHT40 2TX SDM (based on UNII-2C band output power)	Covered by 802.11n HT40 2TX CDD	
5530-5610	802.11ac VHT80 SISO	14.98	31.48
5690	802.11ac VHT80 SISO (based on UNII-2C band output power)	14.12	25.82
5530-5610	802.11ac VHT80 2TX CDD	17.94	62.23
5690	802.11ac VHT80 2TX CDD (based on UNII-2C band output power)	17.28	53.46
5530-5610	802.11ac VHT80 2TX STBC	Covered by 802.11ac VHT80 2TX CDD	
5690	802.11ac VHT80 2TX STBC(based on UNII-2C band output power)	Covered by 802.11ac VHT80 2TX CDD	
5530-5610	802.11ac VHT80 2TX SDM	Covered by 802.11ac VHT80 2TX CDD	
5690	802.11ac VHT80 2TX SDM (based on UNII-2C band output power)	Covered by 802.11ac VHT80 2TX CDD	

5.8GHz Band FCC

Frequency Range (MHz)	Mode	Output Power (dBm)	Output Power (mW)
5745 - 5825	802.11a	Covered by 802.11n HT20 SISO	
	802.11n HT20 SISO	15.49	35.40
	802.11a 2TX CDD	Covered by 802.11n HT20 2TX CDD	
	802.11n HT20 2TX CDD	18.24	66.68
	802.11n HT20 2TX STBC	Covered by 802.11n HT20 2TX CDD	
	802.11ac VHT20 2TX STBC	Covered by 802.11n HT20 2TX CDD	
	802.11n HT20 2TX SDM	Covered by 802.11n HT20 2TX CDD	
5755 - 5795	802.11ac VHT20 2TX SDM	Covered by 802.11n HT20 2TX CDD	
	802.11n HT40 SISO	15.49	35.40
	802.11n HT40 2TX CDD	18.25	66.83
	802.11n HT40 2TX STBC	Covered by 802.11n HT40 2TX CDD	
	802.11ac VHT40 2TX STBC	Covered by 802.11n HT40 2TX CDD	
	802.11n HT40 2TX SDM	Covered by 802.11n HT40 2TX CDD	
5775	802.11ac VHT40 2TX SDM	Covered by 802.11n HT40 2TX CDD	
	802.11ac VHT80 SISO	15.48	35.32
	802.11ac VHT80 2TX CDD	18.20	66.07
	802.11ac VHT80 2TX STBC	Covered by 802.11ac VHT80 2TX CDD	
	802.11ac VHT80 2TX SDM	Covered by 802.11ac VHT80 2TX CDD	

5.3. DESCRIPTION OF AVAILABLE ANTENNAS

Frequency Band (GHz)	Antenna Gain (dBi)	
	Antenna A	Antenna B
5.2	3.48	3.33
5.3	4.11	3.36
5.5	5.41	5.17
5.8	4.20	4.32

5.4. SOFTWARE AND FIRMWARE

The firmware installed in the EUT during testing was 14E232.

5.5. WORST-CASE CONFIGURATION AND MODE

For radiated harmonics spurious below 1GHz, 18-40GHz and power line conducted emissions were performed with the EUT set at the CDD mode at highest power setting among the CDD/STBC/SDM modes as worst-case scenario.

The output power for PSD and spurious tests was set higher than maximum for the purposes of testing only.

For SISO modes, there are two transmission antennas. The antenna used in any given time can be either ANTENNA A, or ANTENNA B All antenna ports have the same power; output power and PSD measurement for SISO modes on both antennas are reported. For 2TX MIMO modes, ANTENNA A/ANTENNA B, used at the same time.

The fundamental of the EUT was investigated in three orthogonal orientations X (Flatbed), Y (Landscape), Z (Portrait), it was determined that (see table below) was worst-case orientations. Therefore, all final radiated testing was performed with the EUT in (see table below) orientation.

Frequency Band (GHz)	Mode	Antenna Port	Worst-case Orientation
5.2-5.8	1TX SISO	Ant A	Z (Portrait)
		Ant B	Z (Portrait)
	2TX MIMO	Ant A + Ant B	Z (Portrait)

Worst-case data rates as provided by the client were:

- 802.11a mode: 6 Mbps
- 802.11n HT20 mode: MCS0
- 802.11n HT40 mode: MCS0
- 802.11ac VHT20 mode: MCS0
- 802.11ac VHT40 mode: MCS0
- 802.11ac VHT80 mode: MCS0

802.11ac VHT20 and VHT40 mode are different from 802.11nHT20 and HT40 only in control messages and have the same power settings.

There are two vendors of the WiFi/Bluetooth radio modules: variant 1 and variant 2. The WiFi/Bluetooth radio modules have the same mechanical outline (e.g., the same package dimension and pin-out layout), use the same on-board antenna matching circuit, have an identical antenna structure, and are built and tested to conform to the same specifications and to operate within the same tolerances.

Baseline testing was performed on the two variants to determine the worst case on all conducted power and radiated emissions.

For simultaneous transmission of multiple channels from the same antenna in BT/BLE and WLAN 5 GHz bands. Baseline testing was performed on various configurations to determine the worst case on radiated emissions.

5.6. DESCRIPTION OF TEST SETUP

SUPPORT EQUIPMENT

Support Equipment List				
Description	Manufacturer	Model	Serial Number	FCC ID
Laptop	Apple	A1286	7313700NAGW	N/A
Laptop AC/DC adapter	Apple	A1343	C062172045DDJ94A6	N/A
Earphone	Apple	NA	NA	N/A
EUT AC/DC adapter	Apple	A1357	W010A051	N/A

I/O CABLES (CONDUCTED TEST)

I/O Cable List						
Cable No	Port	# of identical ports	Connector Type	Cable Type	Cable Length (m)	Remarks
1	Antenna	1	SMA	Un-Shielded	0.2	To spectrum Analyzer
2	USB	1	USB	Shielded	1	N/A
3	AC	1	AC	Un-shielded	2	N/A

I/O CABLES (RADIATED ABOVE 1 GHZ)

I/O Cable List						
Cable No	Port	# of identical ports	Connector Type	Cable Type	Cable Length (m)	Remarks
None Used						

I/O CABLES (RADIATED BELOW 1 GHZ AND AC LINE CONDUCTED: AC/DC ADAPTER CONFIGURATION)

I/O Cable List						
Cable No	Port	# of identical	Connector Type	Cable Type	Cable Length (m)	Remarks
1	Earphone Jack	1	3.5mm Audio	Shielded	0.9	N/A
2	USB	1	USB	shielded	1	N/A

I/O CABLES (AC LINE CONDUCTED: LAPTOP CONFIGURATION)

I/O Cable List						
Cable No	Port	# of identical	Connector Type	Cable Type	Cable Length (m)	Remarks
1	Earphone Jack	1	3.5mm Audio	Shielded	0.9	N/A
2	USB	1	USB	Shielded	1	N/A
3	AC	1	AC	Un-shielded	2	N/A

TEST SETUP - CONDUCTED TESTS

The EUT was connected to a host Laptop via USB cable adapter and spectrum analyzer to antenna port. Test software exercised the EUT.

SETUP DIAGRAM

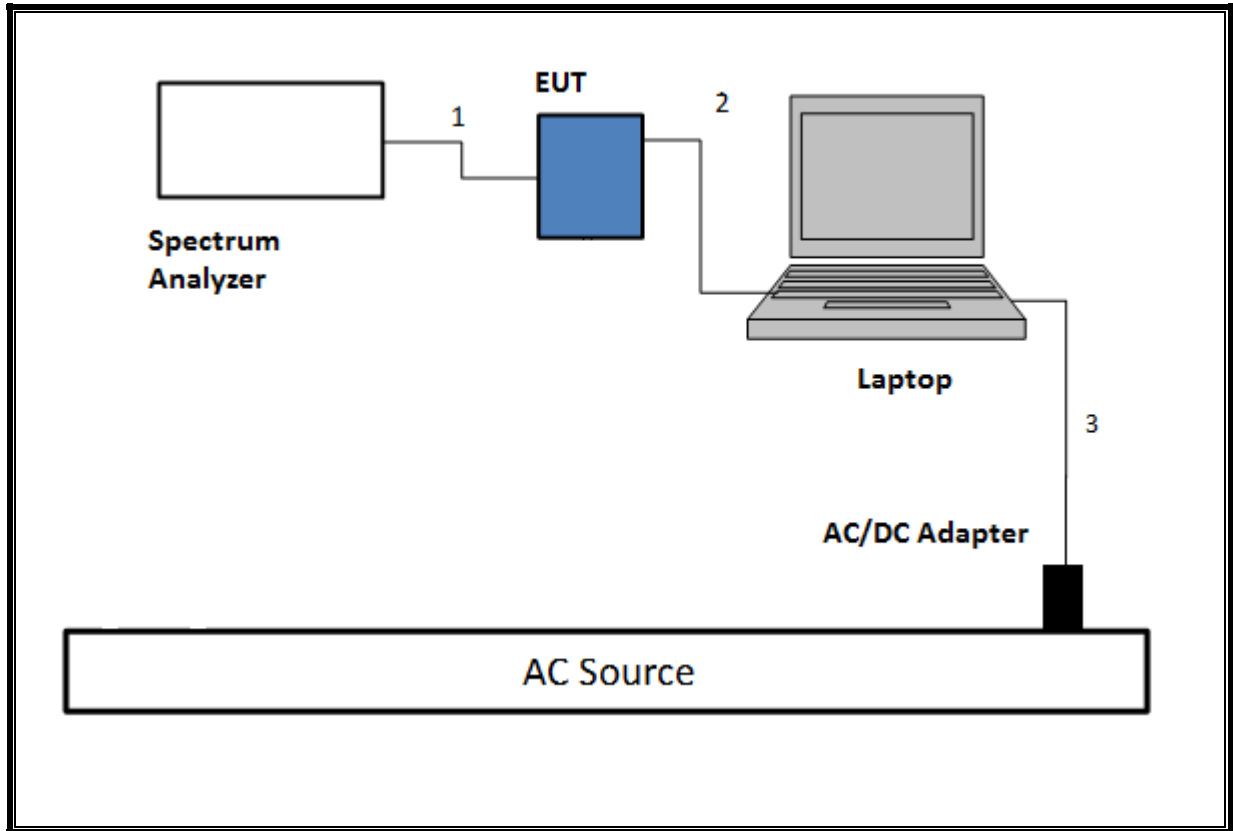

TEST SETUP- RADIATED-ABOVE 1 GHZ

The EUT was powered by battery. Test software exercised the EUT.

SETUP DIAGRAM

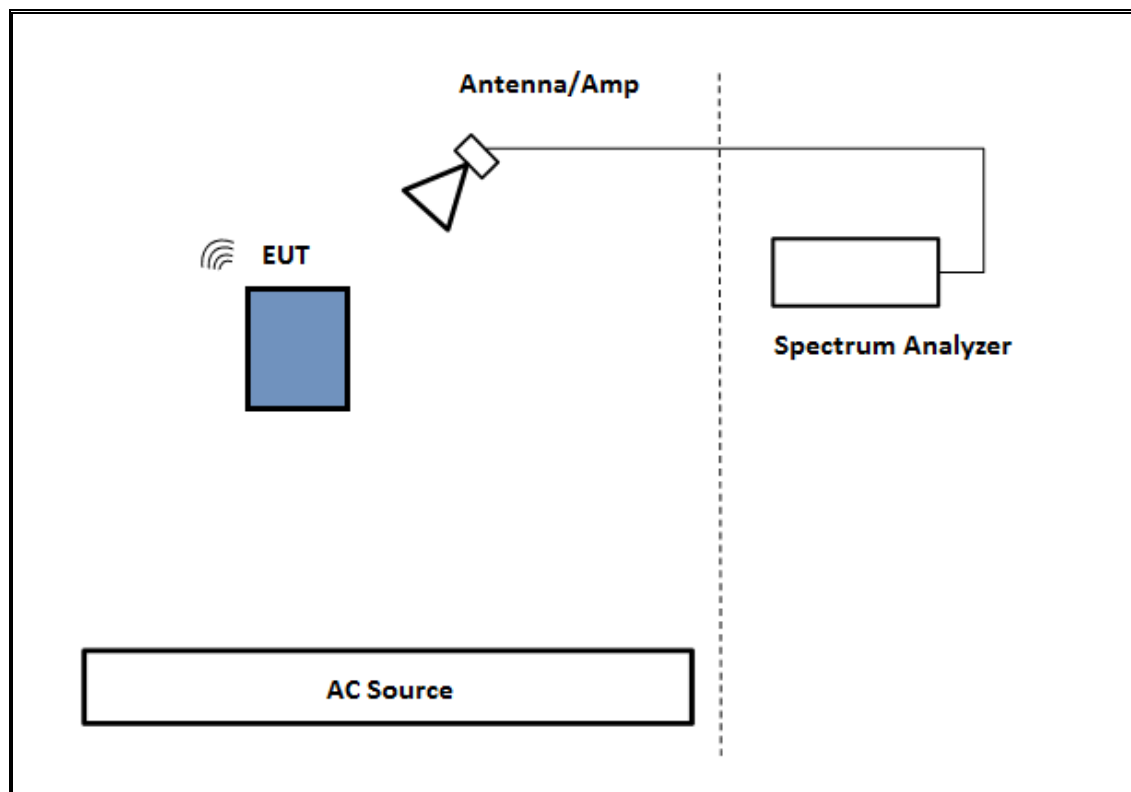

TEST SETUP- BELOW 1GHz

The EUT was powered by AC/DC adapter and connected with earphone. Test software exercised the EUT.

SETUP DIAGRAM

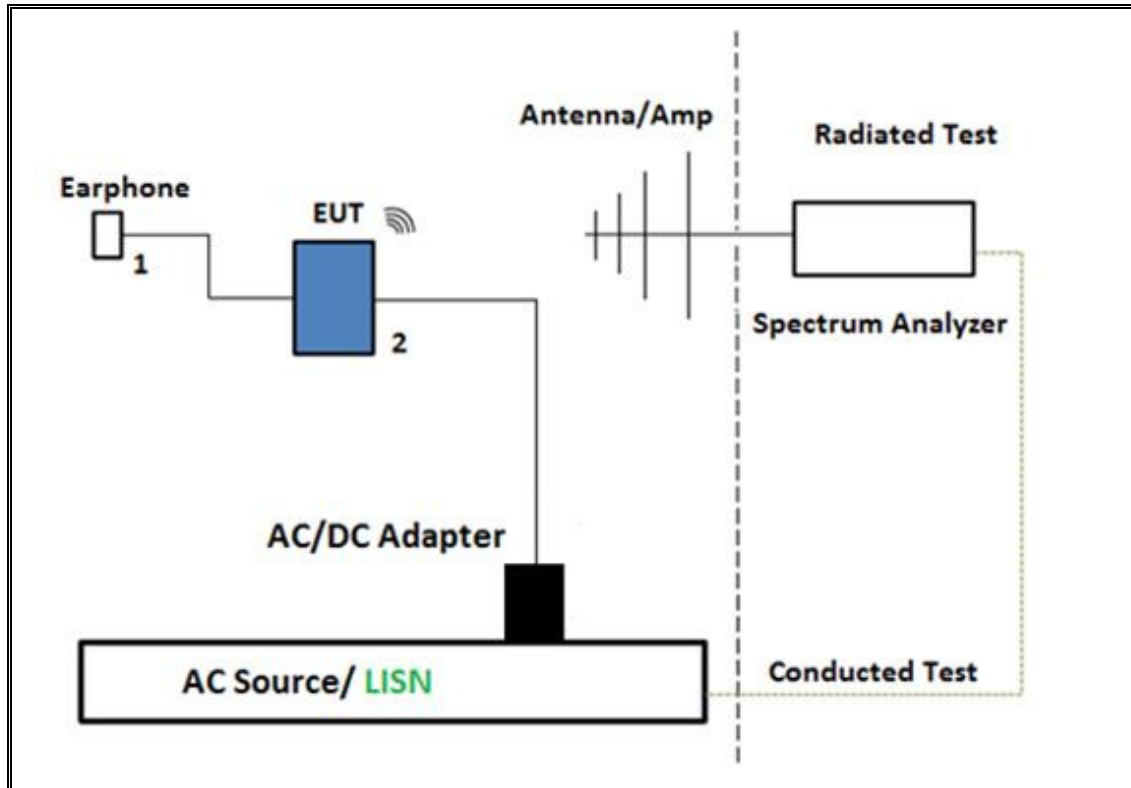

TEST SETUP- AC LINE CONDUCTED: AC/DC ADAPTER CONFIGURATION

The EUT was tested with earphone connected and powered by AC/DC adapter via USB cable. Test software exercised the EUT.

SETUP DIAGRAM

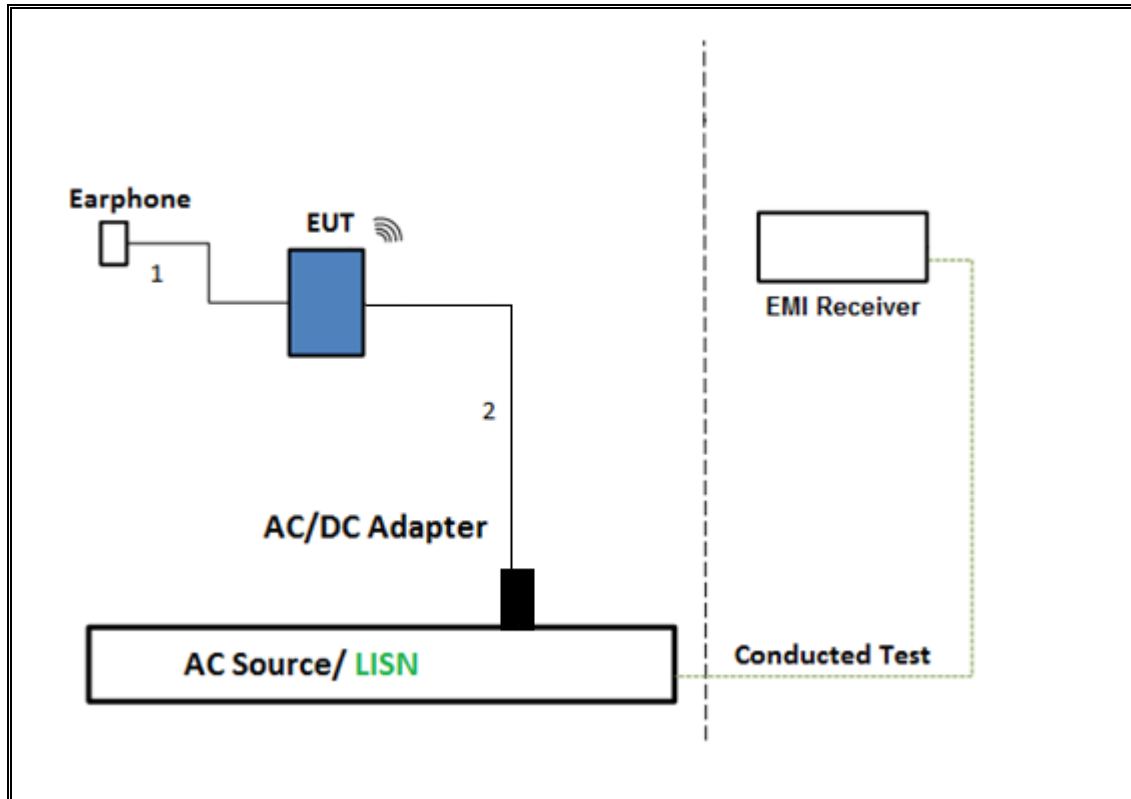

TEST SETUP- AC LINE CONDUCTED: LAPTOP CONFIGURATION

The EUT was tested with earphone connected and powered by host PC via USB cable. Test software exercised the EUT.

SETUP DIAGRAM

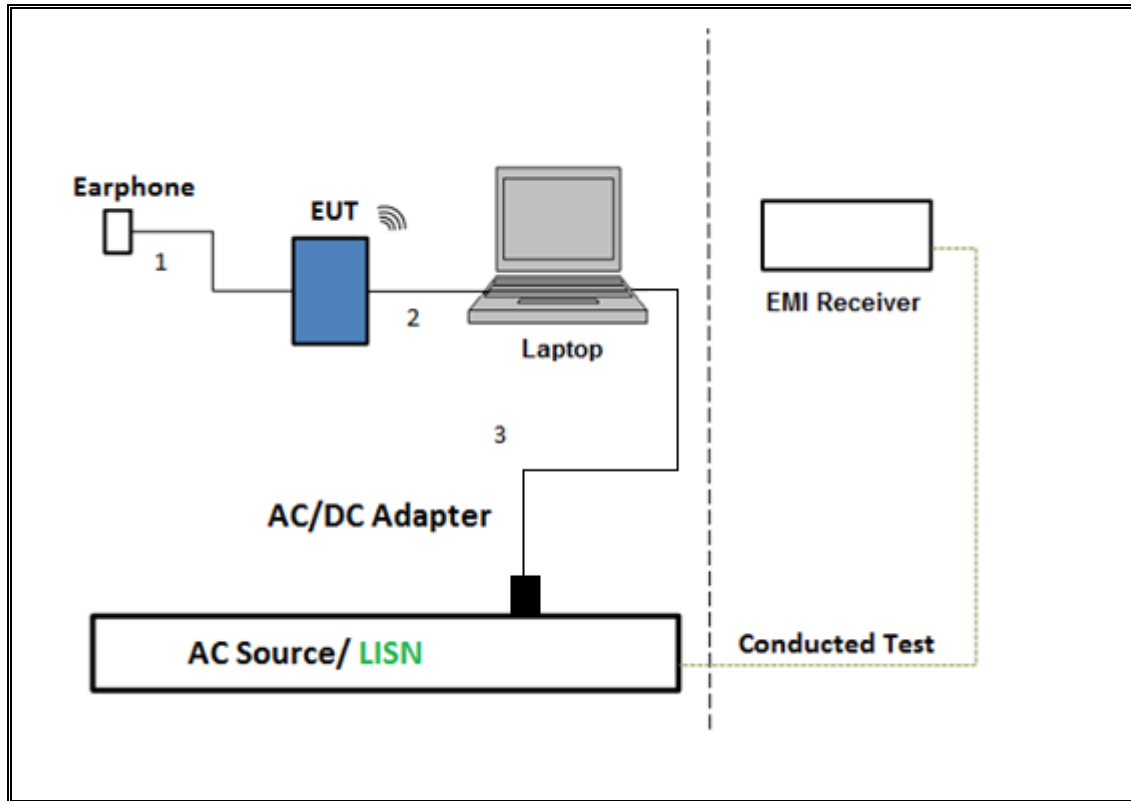

6. TEST AND MEASUREMENT EQUIPMENT

The following test and measurement equipment was utilized for the tests documented in this report:

TEST EQUIPMENT LIST				
Description	Manufacturer	Model	Asset	Cal Due
Power Meter, P-series single channel	Agilent	N1911A	T227	10/11/2017
Power Sensor, P - series, 50MHz to 18GHz, Wideband	Agilent	N1921A	T1228	06/20/2017
*Antenna, Horn 1-18GHz	ETS-Lindgren	3117	T344	02/22/2017
Antenna, Horn 1-18GHz	ETS-Lindgren	3117	T862	04/18/2017
Antenna, BroadBand Hybrid, 30MHz to 2000MHz	Sunol Sciences Corp.	JB3	T407	04/04/2017
RF Amplifier, 1-18GHz	MITEQ	AFS42-00101800-25-S-42	T740	11/29/2017
Amplifier, 10KHz to 1GHz, 32dB	Sonoma Instrument	310	T286	05/04/2017
Spectrum Analyzer, PXA, 3Hz to 44GHz	Agilent (Keysight) Technologies	N9030A	T905	06/21/2017
*Antenna, Horn 1-18GHz	ETS-Lindgren	3117	T346	02/22/2017
Antenna, BroadBand Hybrid, 30MHz to 2000MHz	Sunol Sciences Corp.	JB3	T408	11/10/2017
RF Amplifier, 1-18GHz	MITEQ	AFS42-00101800-25-S-42	T1131	09/23/2017
Amplifier, 10KHz to 1GHz, 32dB	Sonoma Instrument	310	T285	06/20/2017
Spectrum Analyzer, PXA, 3Hz to 44GHz	Agilent (Keysight) Technologies	N9030A	T459	06/13/2017
Spectrum Analyzer, PXA, 3Hz to 44GHz	Agilent (Keysight) Technologies	N9030A	T1210	06/30/2017
Antenna, Horn 18 to 26.5GHz	ARA	MWH-1826/B	T447	06/16/2017
Amplifier, 1 to 26.5GHz, 23.5dB Gain minimum	Keysight	8449B	T402	7/5/2017
Antenna, Horn 26.5GHz to 40GHz	ARA	MWH-2640/B	T446	05/25/2017
Amplifier, 26.5GHz to 40GHz	Miteq	NSP 4000 SP2	T88	04/07/2017
AC Line Conducted				
*EMI Test Receiver 9KHz-7GHz	Rohde & Schwarz	ESCI7	T1436	12/19/2016
LISN for Conducted Emissions CISPR-16	Fischer	50/250-25-2-01	T1310	06/08/2017
UL AUTOMATION SOFTWARE				
Radiated Software	UL	UL EMC	Ver 9.5, April 26, 2016	
Conducted Software	UL	UL EMC	Ver 5.4, October 13, 2016	
AC Line Conducted Software	UL	UL EMC	Ver 9.5, May 26, 2015	

NOTE: *testing is completed before equipment calibration expiration date.

7. ON TIME, DUTY CYCLE AND MEASUREMENT METHODS

7.1. ON TIME AND DUTY CYCLE

LIMITS

None; for reporting purposes only.

PROCEDURE

KDB 789033 Zero-Span Spectrum Analyzer Method.

RESULTS

Mode	ON Time B (msec)	Period (msec)	Duty Cycle x (linear)	Duty Cycle (%)	Duty Cycle Correction Factor (dB)	1/B Minimum VBW (kHz)
802.11n HT20 1TX	1.920	1.940	0.990	98.97%	0.00	0.010
802.11n HT20 CDD	1.920	1.940	0.990	98.97%	0.00	0.010
802.11n HT40 1TX	0.944	0.966	0.977	97.72%	0.10	1.059
802.11n HT40 CDD	0.943	0.965	0.978	97.77%	0.10	1.060
802.11ac VHT80 1TX	0.460	0.481	0.956	95.63%	0.19	2.174
802.11ac VHT80 CDD	0.460	0.482	0.954	95.44%	0.20	2.174

DUTY CYCLE PLOTS

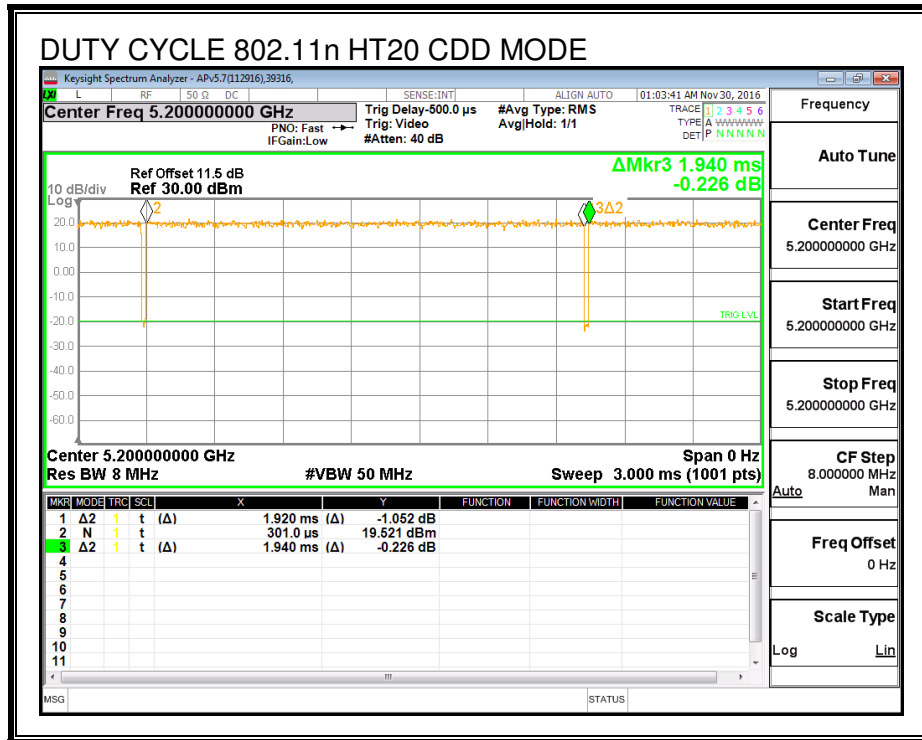
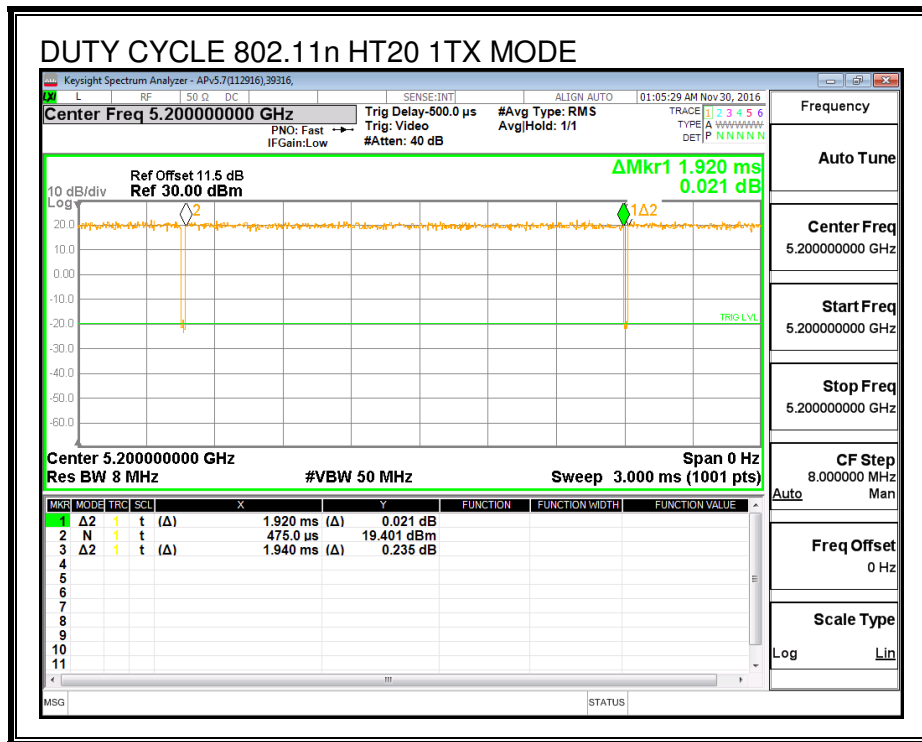

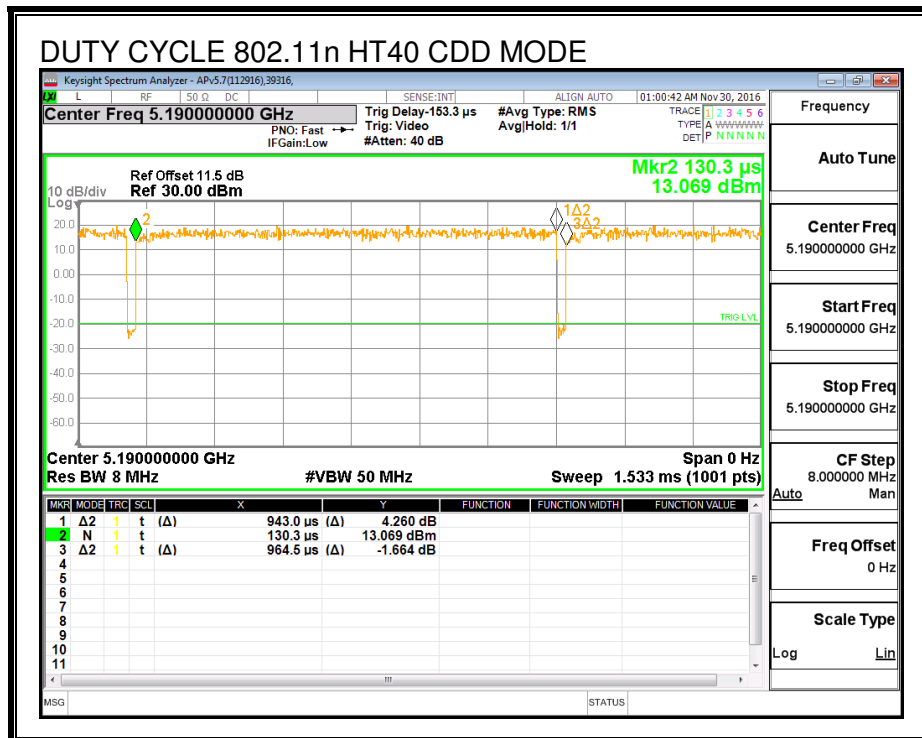
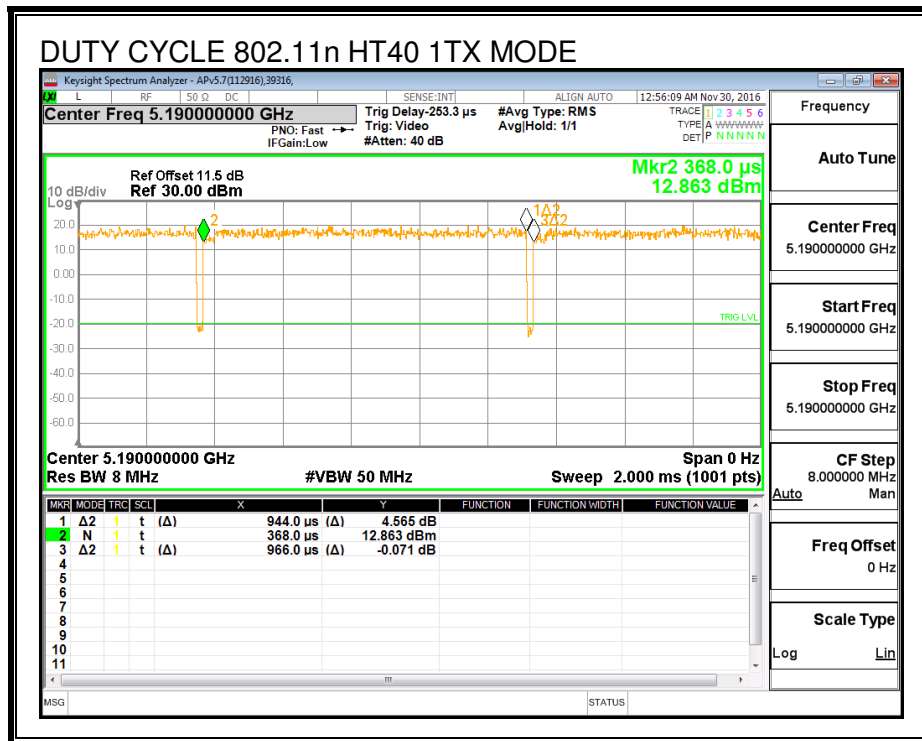

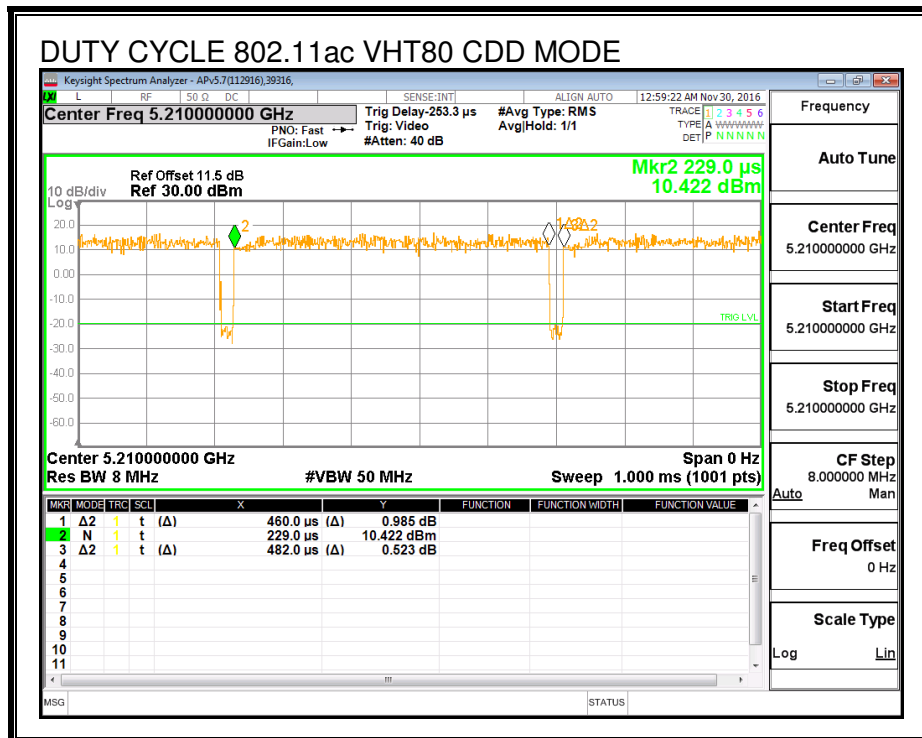
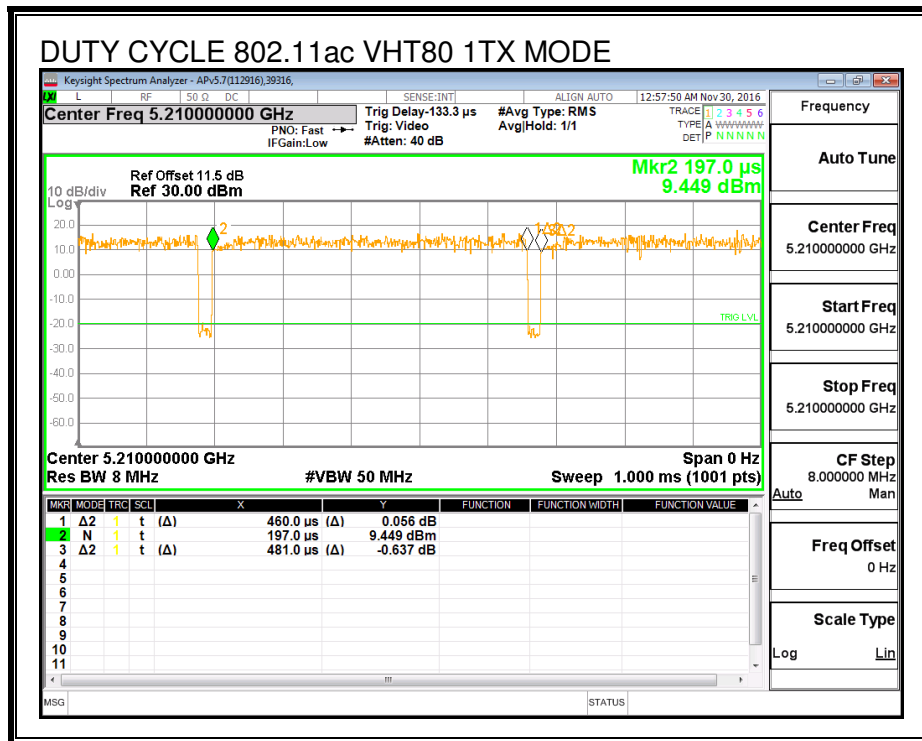

7.2. MEASUREMENT METHODS

6 dB Emission BW: KDB 789033 D02 v01r03, Section C.

26 dB Emission BW: KDB 789033 D02 v01r03, Section C.

99% Occupied BW: KDB 789033 D02 v01r03, Section D.

Conducted Output Power: KDB 789033 D02 v01r03, Section E.3.b (Method PM-G).

Power Spectral Density: KDB 789033 D02 v01r03, Section F (Method SA-2).

Unwanted emissions in restricted bands: KDB 789033 D02 v01r03, Sections G.3, G.4, G.5, and G.6.

Unwanted emissions in non-restricted bands: KDB 789033 D02 v01r03, Sections G.3, G.4, and G.5.

8. ANTENNA PORT TEST RESULTS

8.1. 802.11n HT20 ANTENNA A MODE IN THE 5.2 GHz BAND

8.1.1. 26 dB BANDWIDTH

LIMITS

None; for reporting purposes only.

RESULTS

Channel	Frequency (MHz)	26 dB Bandwidth (MHz)
Low	5180	22.120
Mid	5200	22.000
High	5240	22.080

26 dB BANDWIDTH

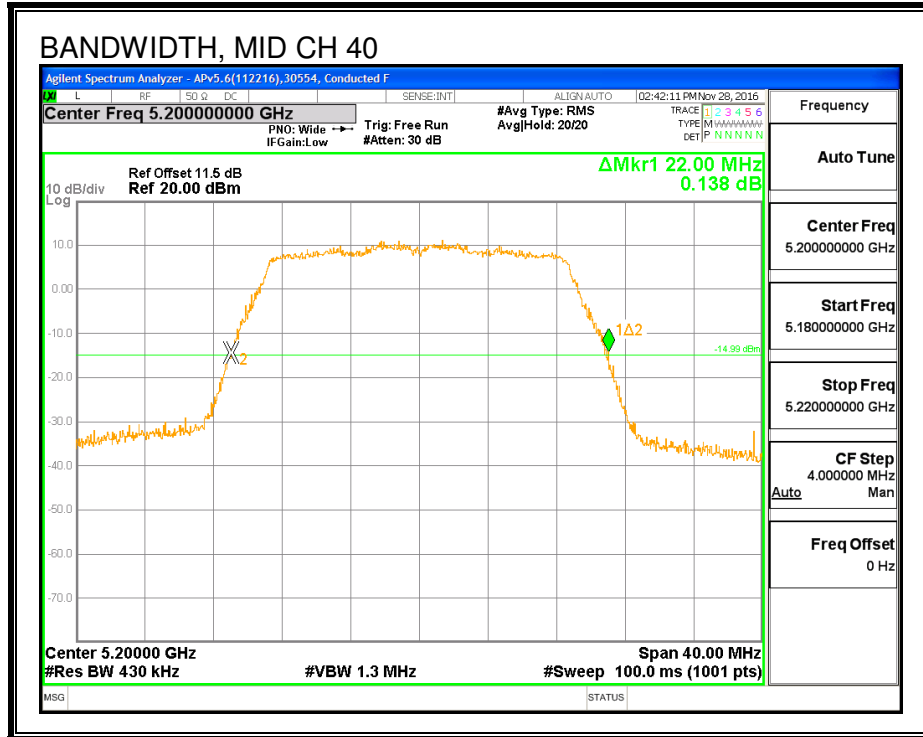
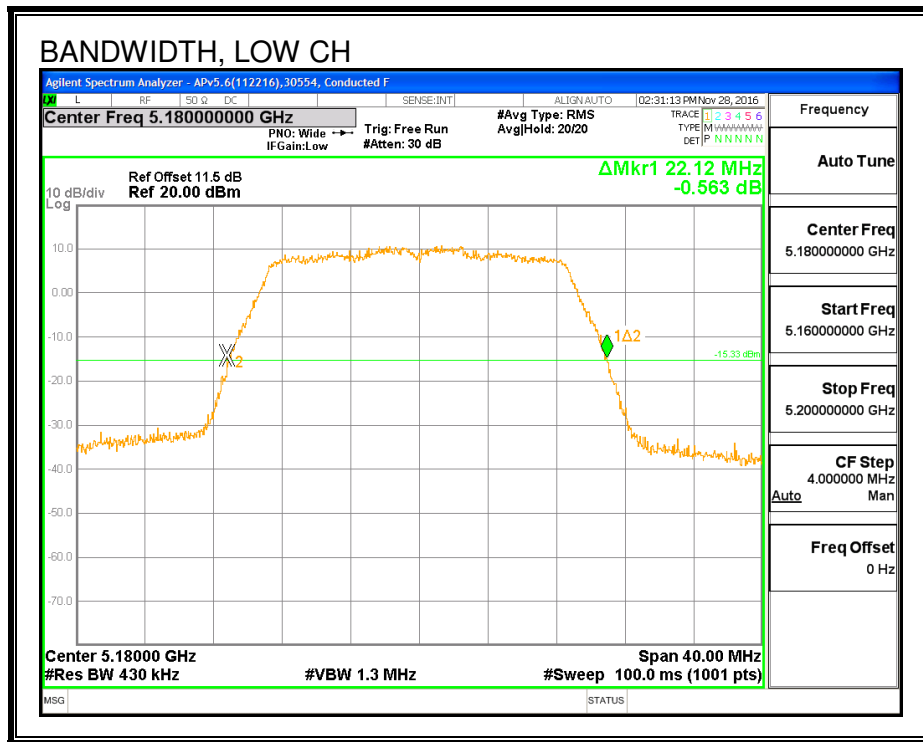

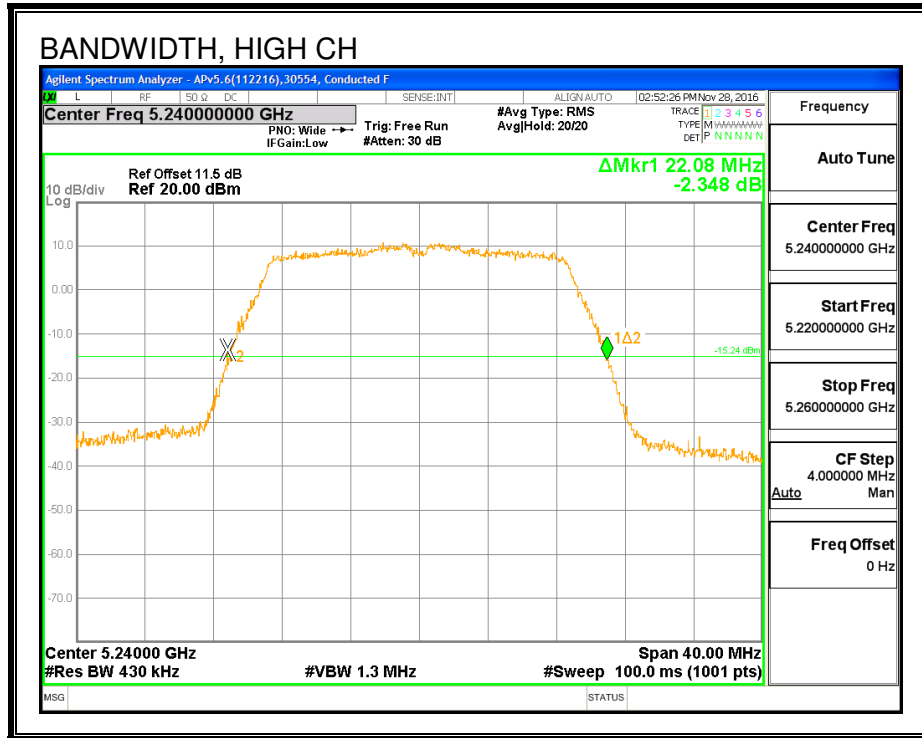

8.1.2. 99% BANDWIDTH

LIMITS

None; for reporting purposes only.

RESULTS

Channel	Frequency (MHz)	99% BW (MHz)
Low	5180	17.803
Mid	5200	17.760
High	5240	17.945

99% BANDWIDTH

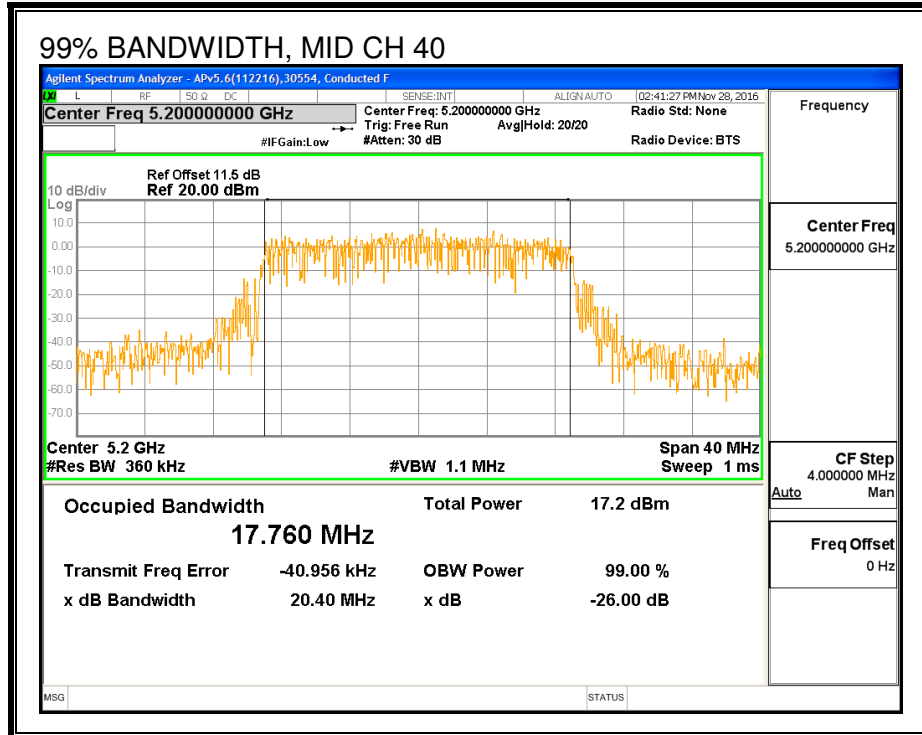
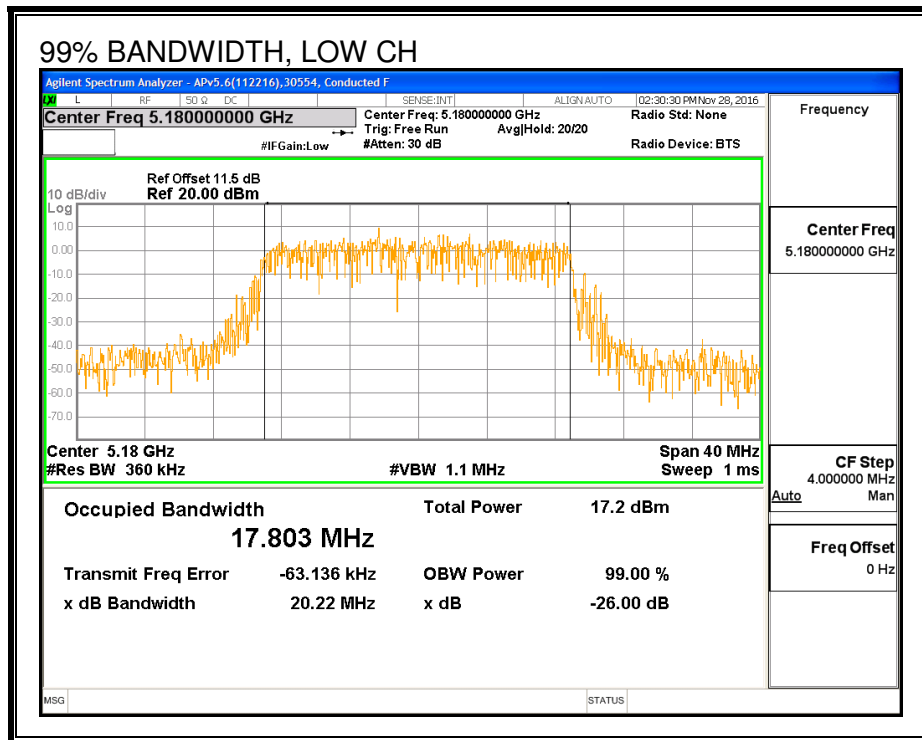

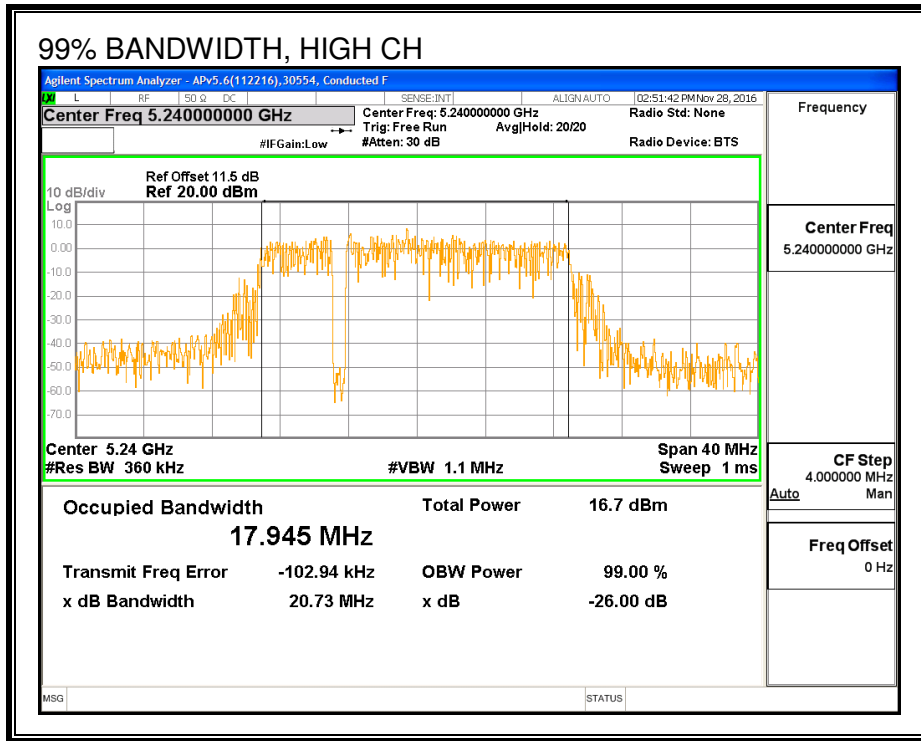

8.1.3. AVERAGE POWER

LIMITS

None; for reporting purposes only.

TEST PROCEDURE

Measurements perform using a wideband gated RF power meter.

RESULTS

ID:	39919	Date:	1/31/17
------------	-------	--------------	---------

Channel	Frequency (MHz)	Power (dBm)
Low	5180	15.94
Mid	5200	16.90
High	5240	16.88

8.1.4. OUTPUT POWER AND PSD

LIMITS

FCC §15.407 (a) (1)

(i) For an outdoor access point operating in the band 5.15-5.25 GHz, the maximum conducted output power over the frequency band of operation shall not exceed 1 W provided the maximum antenna gain does not exceed 6 dBi. In addition, the maximum power spectral density shall not exceed 17 dBm in any 1 megahertz band. If transmitting antennas of directional gain greater than 6 dBi are used, both the maximum conducted output power and the maximum power spectral density shall be reduced by the amount in dB that the directional gain of the antenna exceeds 6 dBi. The maximum e.i.r.p. at any elevation angle above 30 degrees as measured from the horizon must not exceed 125 mW (21 dBm).

(ii) For an indoor access point operating in the band 5.15-5.25 GHz, the maximum conducted output power over the frequency band of operation shall not exceed 1 W provided the maximum antenna gain does not exceed 6 dBi. In addition, the maximum power spectral density shall not exceed 17 dBm in any 1 megahertz band. If transmitting antennas of directional gain greater than 6 dBi are used, both the maximum conducted output power and the maximum power spectral density shall be reduced by the amount in dB that the directional gain of the antenna exceeds 6 dBi.

(iii) For fixed point-to-point access points operating in the band 5.15-5.25 GHz, the maximum conducted output power over the frequency band of operation shall not exceed 1 W. Fixed point-to-point U-NII devices may employ antennas with directional gain up to 23 dBi without any corresponding reduction in the maximum conducted output power or maximum power spectral density. For fixed point-to-point transmitters that employ a directional antenna gain greater than 23 dBi, a 1 dB reduction in maximum conducted output power and maximum power spectral density is required for each 1 dB of antenna gain in excess of 23 dBi. Fixed, point-to-point operations exclude the use of point-to-multipoint systems, omnidirectional applications, and multiple collocated transmitters transmitting the same information. The operator of the U-NII device, or if the equipment is professionally installed, the installer, is responsible for ensuring that systems employing high gain directional antennas are used exclusively for fixed, point-to-point operations.

(iv) For mobile and portable client devices in the 5.15-5.25 GHz band, the maximum conducted output power over the frequency band of operation shall not exceed 250 mW provided the maximum antenna gain does not exceed 6 dBi. In addition, the maximum power spectral density shall not exceed 11 dBm in any 1 megahertz band. If transmitting antennas of directional gain greater than 6 dBi are used, both the maximum conducted output power and the maximum power spectral density shall be reduced by the amount in dB that the directional gain of the antenna exceeds 6 dBi.

TEST PROCEDURE

Measurements perform using a wideband gated RF power meter provided that the gate parameters are adjusted such that the power is measured only when the EUT is transmitting at its maximum power control level. Since the measurement is made only during the ON time of the transmitter, no duty cycle correction factor is required.

DIRECTIONAL ANTENNA GAIN

There is only one transmitter output therefore the directional gain is equal to the antenna gain.

RESULTS

ID:	39919	Date:	1/31/17
------------	-------	--------------	---------

Antenna Gain and Limits

Channel	Frequency (MHz)	Directional Gain for Power (dBi)	Directional Gain for PSD (dBi)	Power Limit (dBm)	PSD Limit (dBm)
Low	5180	3.48	3.48	24.00	11.00
Mid	5200	3.48	3.48	24.00	11.00
High	5240	3.48	3.48	24.00	11.00

Duty Cycle CF (dB)	0.00	Included in Calculations of Corr'd PSD
---------------------------	------	---

Output Power Results

Channel	Frequency (MHz)	Ant A Meas Power (dBm)	Total Corr'd Power (dBm)	Power Limit (dBm)	Power Margin (dB)
Low	5180	15.94	15.94	24.00	-8.06
Mid	5200	16.90	16.90	24.00	-7.10
High	5240	16.88	16.88	24.00	-7.12

PSD Results

Channel	Frequency (MHz)	Ant A Meas PSD (dBm)	Total Corr'd PSD (dBm)	PSD Limit (dBm)	PSD Margin (dB)
Low	5180	6.47	6.47	11.00	-4.53
Mid	5200	6.26	6.26	11.00	-4.75
High	5240	6.14	6.14	11.00	-4.86

PSD

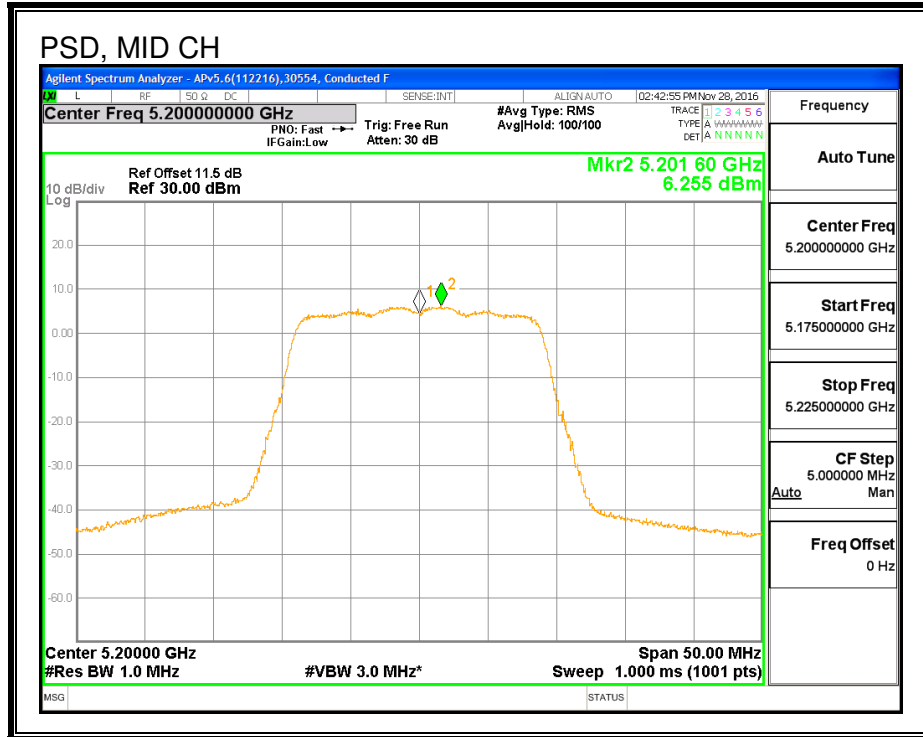
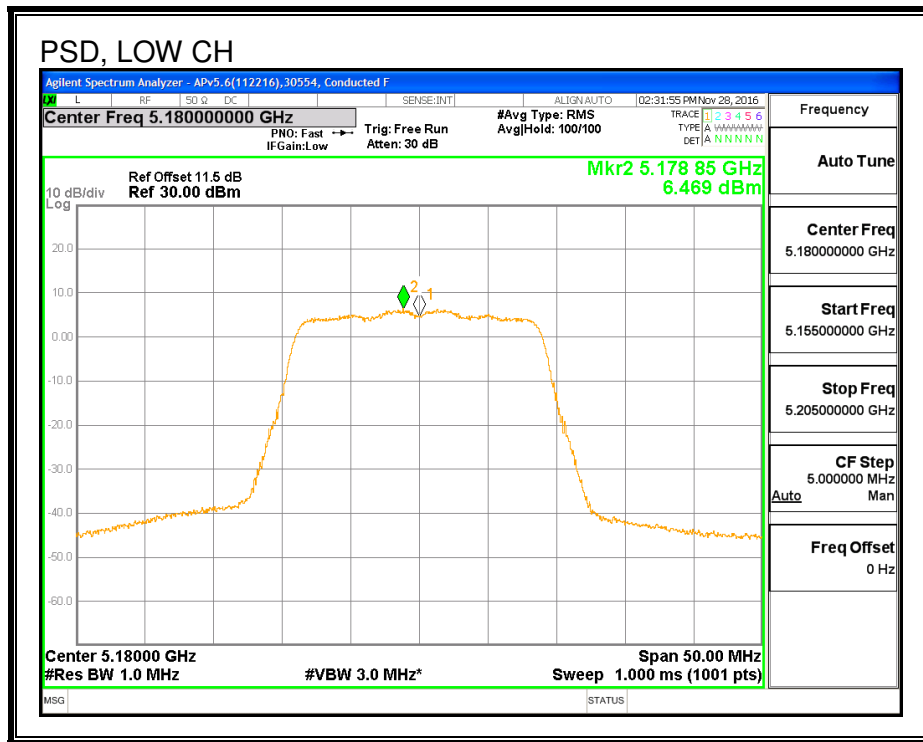

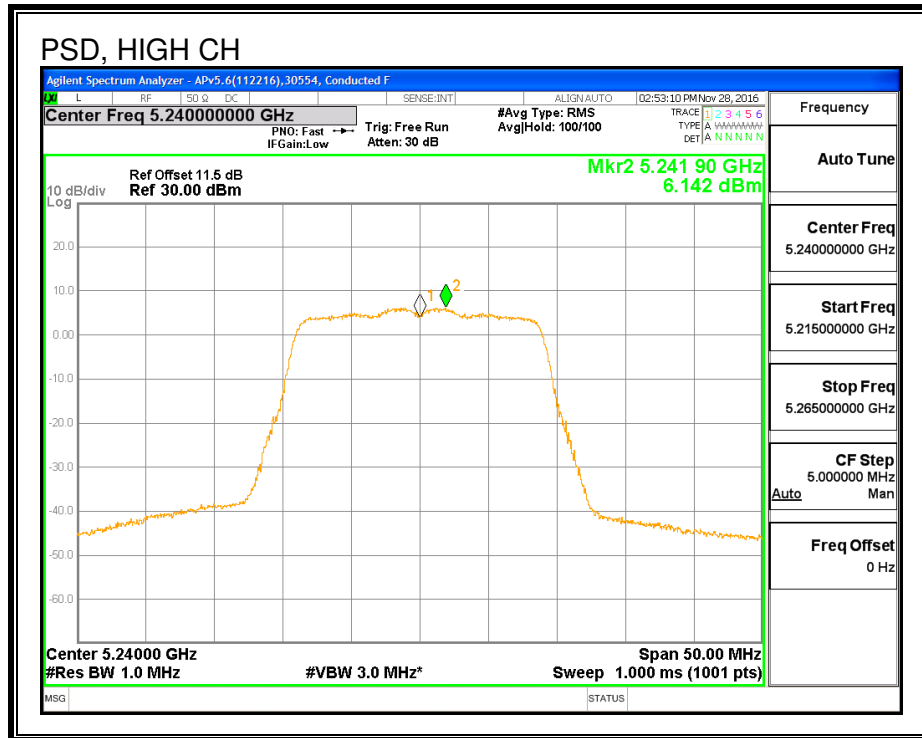

8.2. 802.11n HT20 ANTENNA B MODE IN THE 5.2 GHz BAND

8.2.1. 26 dB BANDWIDTH

LIMITS

None; for reporting purposes only.

RESULTS

Channel	Frequency (MHz)	26 dB Bandwidth (MHz)
Low	5180	22.080
Mid	5200	21.960
High	5240	22.000

26 dB BANDWIDTH

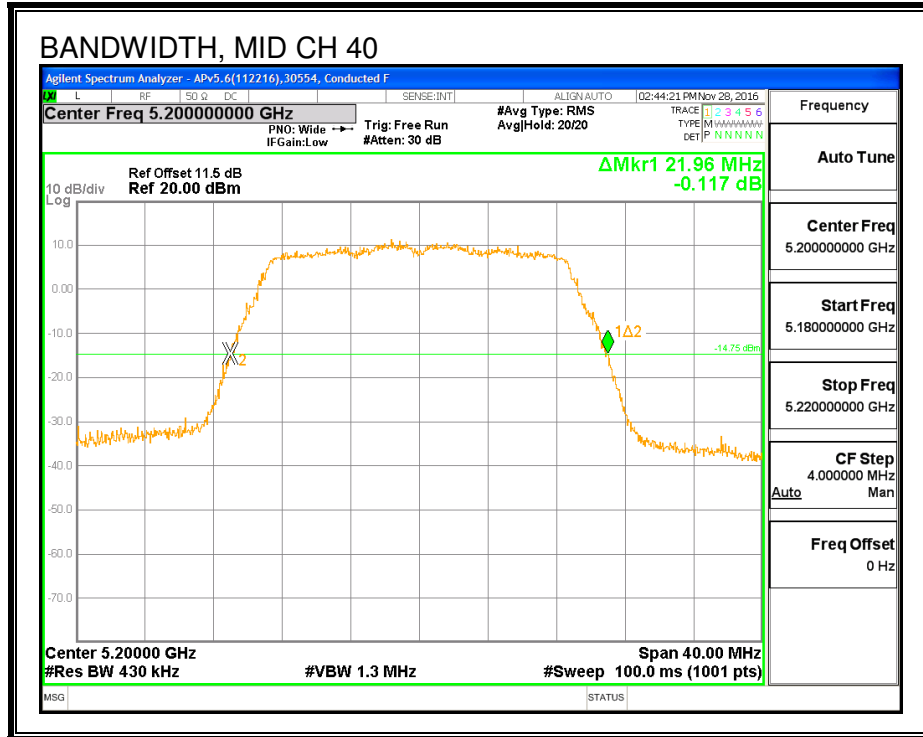
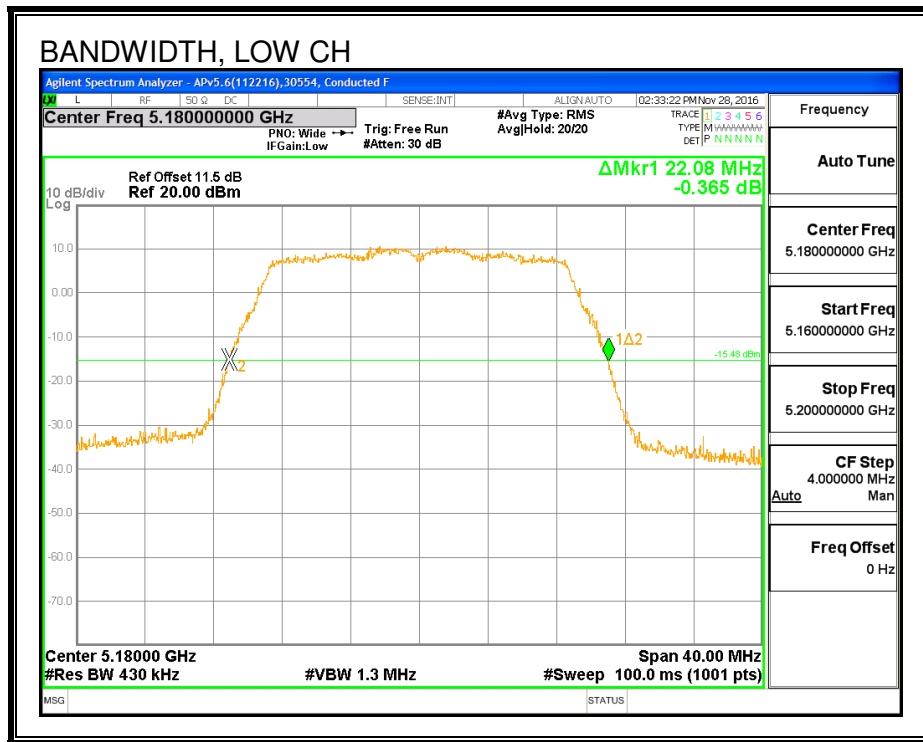

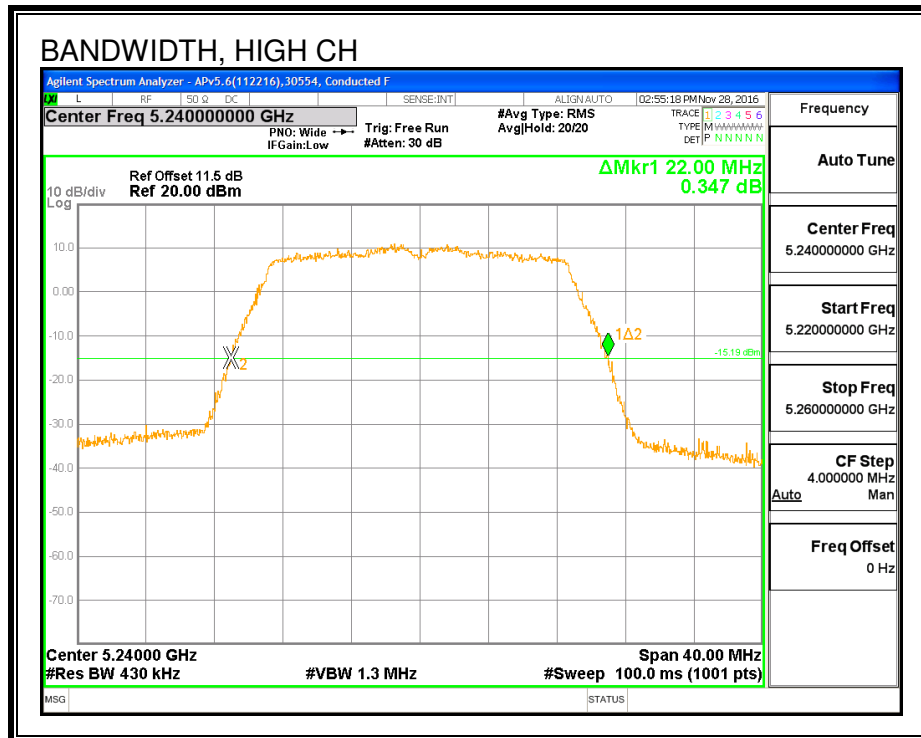

8.2.2. 99% BANDWIDTH

LIMITS

None; for reporting purposes only.

RESULTS

Channel	Frequency (MHz)	99% BW (MHz)
Low	5180	17.750
Mid	5200	17.729
High	5240	17.704

99% BANDWIDTH

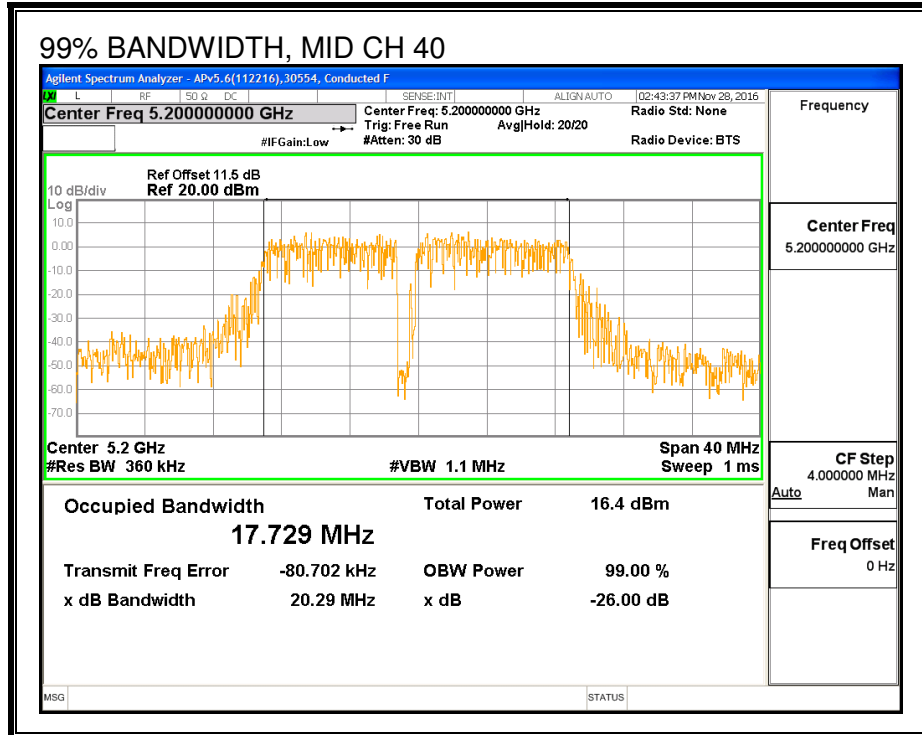
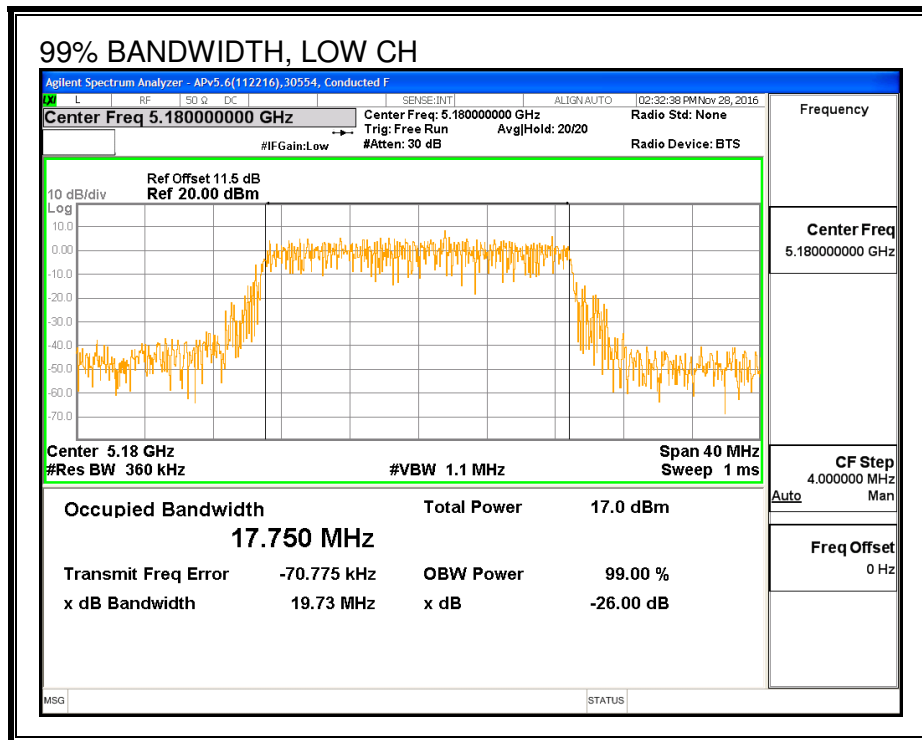

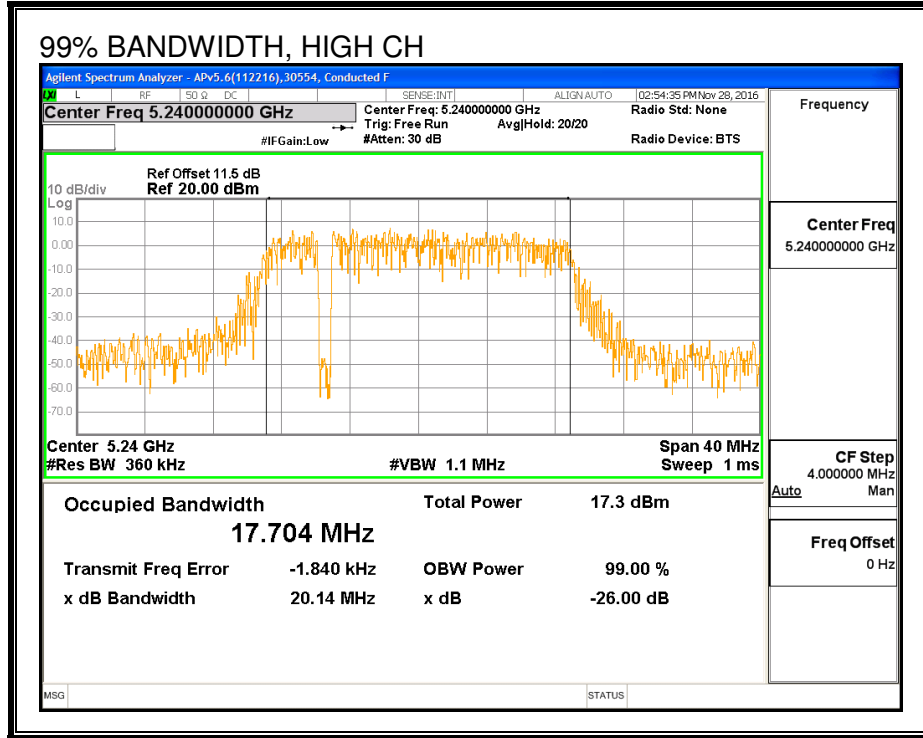

8.2.3. AVERAGE POWER

LIMITS

None; for reporting purposes only.

TEST PROCEDURE

Measurements perform using a wideband gated RF power meter.

RESULTS

ID:	39919	Date:	1/31/17
------------	-------	--------------	---------

Channel	Frequency (MHz)	Power (dBm)
Low	5180	15.89
Mid	5200	15.99
High	5240	15.91

8.2.4. OUTPUT POWER AND PSD

LIMITS

FCC §15.407 (a) (1)

(i) For an outdoor access point operating in the band 5.15-5.25 GHz, the maximum conducted output power over the frequency band of operation shall not exceed 1 W provided the maximum antenna gain does not exceed 6 dBi. In addition, the maximum power spectral density shall not exceed 17 dBm in any 1 megahertz band. If transmitting antennas of directional gain greater than 6 dBi are used, both the maximum conducted output power and the maximum power spectral density shall be reduced by the amount in dB that the directional gain of the antenna exceeds 6 dBi. The maximum e.i.r.p. at any elevation angle above 30 degrees as measured from the horizon must not exceed 125 mW (21 dBm).

(ii) For an indoor access point operating in the band 5.15-5.25 GHz, the maximum conducted output power over the frequency band of operation shall not exceed 1 W provided the maximum antenna gain does not exceed 6 dBi. In addition, the maximum power spectral density shall not exceed 17 dBm in any 1 megahertz band. If transmitting antennas of directional gain greater than 6 dBi are used, both the maximum conducted output power and the maximum power spectral density shall be reduced by the amount in dB that the directional gain of the antenna exceeds 6 dBi.

(iii) For fixed point-to-point access points operating in the band 5.15-5.25 GHz, the maximum conducted output power over the frequency band of operation shall not exceed 1 W. Fixed point-to-point U-NII devices may employ antennas with directional gain up to 23 dBi without any corresponding reduction in the maximum conducted output power or maximum power spectral density. For fixed point-to-point transmitters that employ a directional antenna gain greater than 23 dBi, a 1 dB reduction in maximum conducted output power and maximum power spectral density is required for each 1 dB of antenna gain in excess of 23 dBi. Fixed, point-to-point operations exclude the use of point-to-multipoint systems, omnidirectional applications, and multiple collocated transmitters transmitting the same information. The operator of the U-NII device, or if the equipment is professionally installed, the installer, is responsible for ensuring that systems employing high gain directional antennas are used exclusively for fixed, point-to-point operations.

(iv) For mobile and portable client devices in the 5.15-5.25 GHz band, the maximum conducted output power over the frequency band of operation shall not exceed 250 mW provided the maximum antenna gain does not exceed 6 dBi. In addition, the maximum power spectral density shall not exceed 11 dBm in any 1 megahertz band. If transmitting antennas of directional gain greater than 6 dBi are used, both the maximum conducted output power and the maximum power spectral density shall be reduced by the amount in dB that the directional gain of the antenna exceeds 6 dBi.

TEST PROCEDURE

Measurements perform using a wideband gated RF power meter provided that the gate parameters are adjusted such that the power is measured only when the EUT is transmitting at its maximum power control level. Since the measurement is made only during the ON time of the transmitter, no duty cycle correction factor is required.

DIRECTIONAL ANTENNA GAIN

There is only one transmitter output therefore the directional gain is equal to the antenna gain.

RESULTS

ID:	39919	Date:	1/31/17
------------	-------	--------------	---------

Antenna Gain and Limits

Channel	Frequency (MHz)	Directional Gain for Power (dBi)	Directional Gain for PSD (dBi)	Power Limit (dBm)	PSD Limit (dBm)
Low	5180	3.33	3.33	24.00	11.00
Mid	5200	3.33	3.33	24.00	11.00
High	5240	3.33	3.33	24.00	11.00

Duty Cycle CF (dB)	0.00	Included in Calculations of Corr'd PSD
---------------------------	------	---

Output Power Results

Channel	Frequency (MHz)	Ant B Meas Power (dBm)	Total Corr'd Power (dBm)	Power Limit (dBm)	Power Margin (dB)
Low	5180	15.89	15.89	24.00	-8.11
Mid	5200	15.99	15.99	24.00	-8.01
High	5240	15.91	15.91	24.00	-8.09

PSD Results

Channel	Frequency (MHz)	Ant B Meas PSD (dBm)	Total Corr'd PSD (dBm)	PSD Limit (dBm)	PSD Margin (dB)
Low	5180	6.19	6.19	11.00	-4.81
Mid	5200	6.47	6.47	11.00	-4.53
High	5240	6.22	6.22	11.00	-4.78

PSD

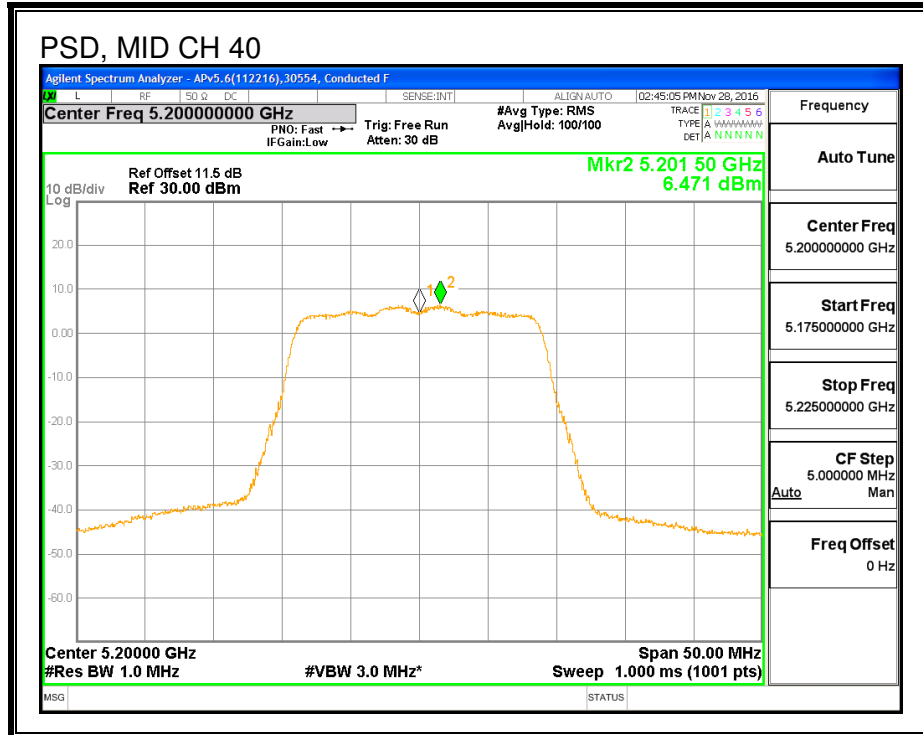
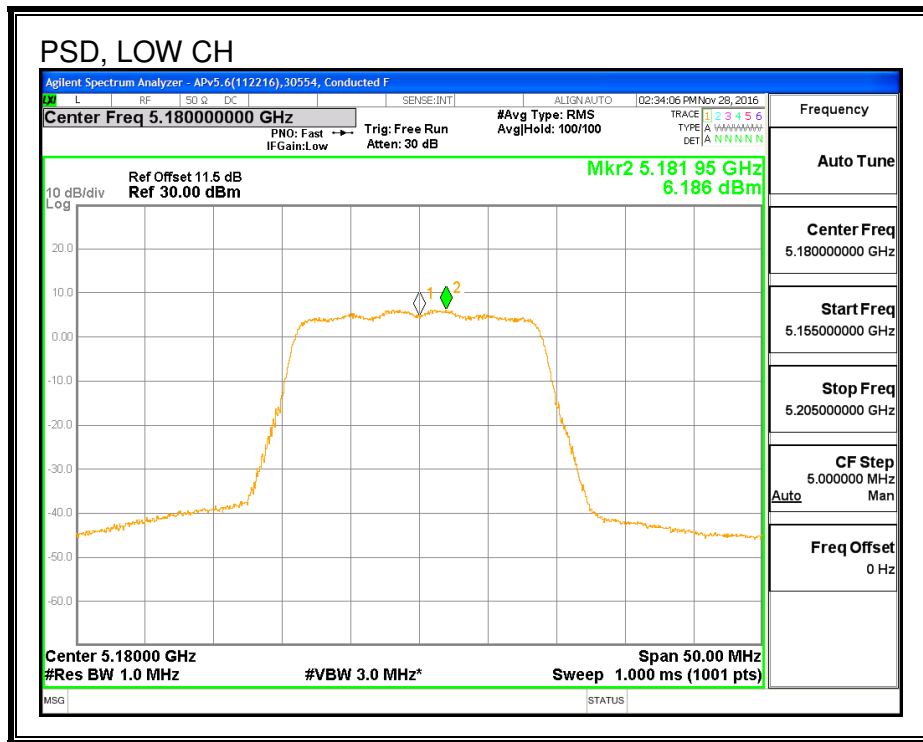

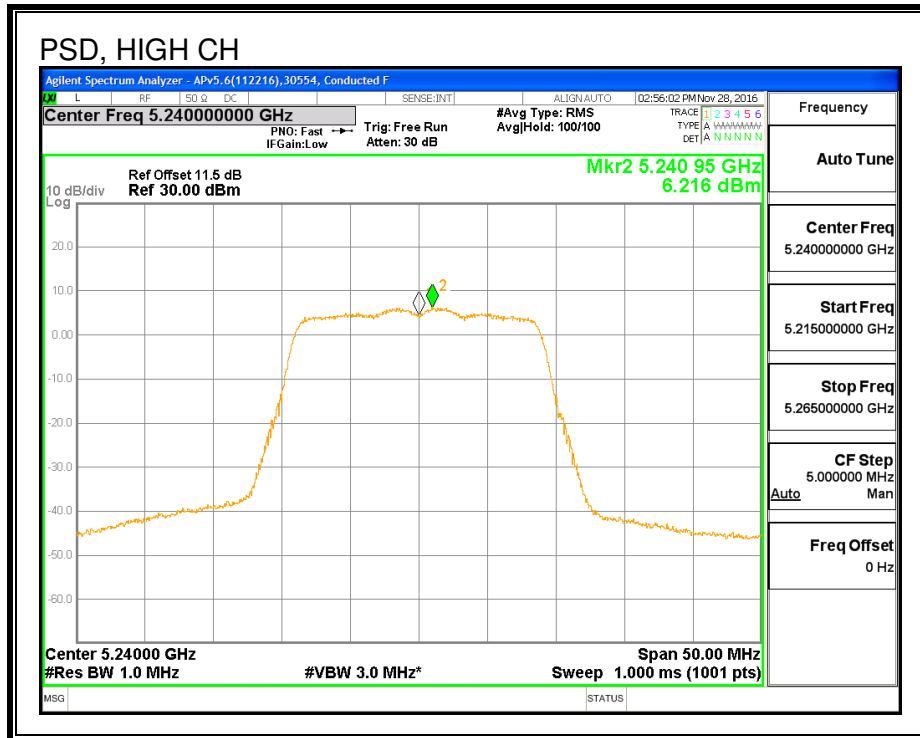

**8.3. 802.11n HT20 2Tx (ANTENNA A + ANTENNA B) CDD MODE IN THE
5.2 GHz BAND**

8.3.1. 26 dB BANDWIDTH

LIMITS

None; for reporting purposes only.

RESULTS

Channel	Frequency (MHz)	26 dB BW Ant A (MHz)	26 dB BW Ant B (MHz)
Low	5180	22.080	21.960
Mid	5200	22.040	22.000
High	5240	22.080	21.880

26 dB BANDWIDTH, ANTENNA A

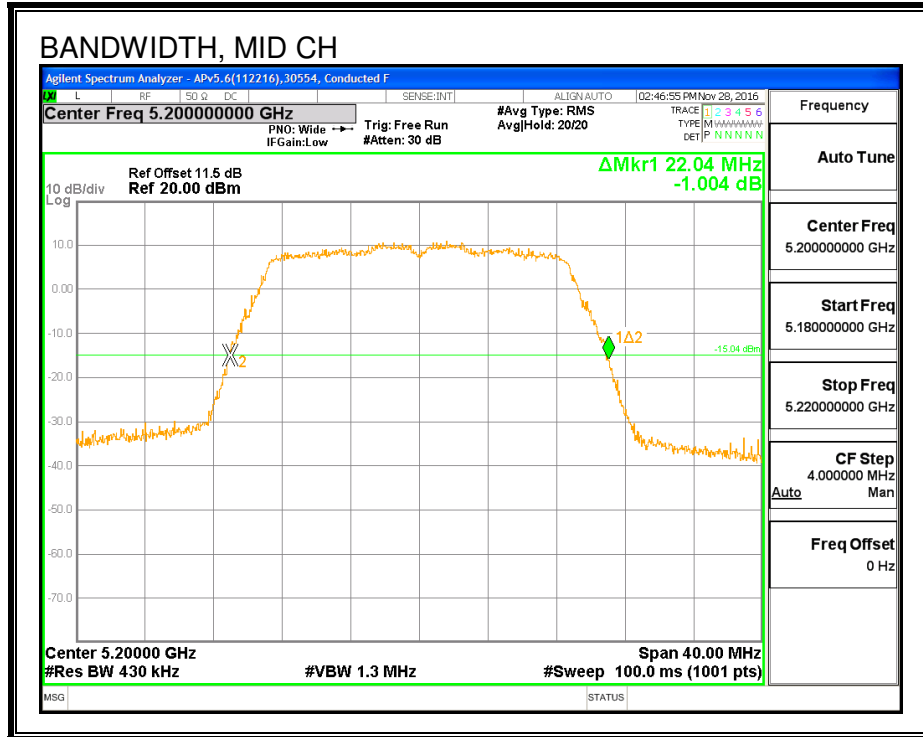
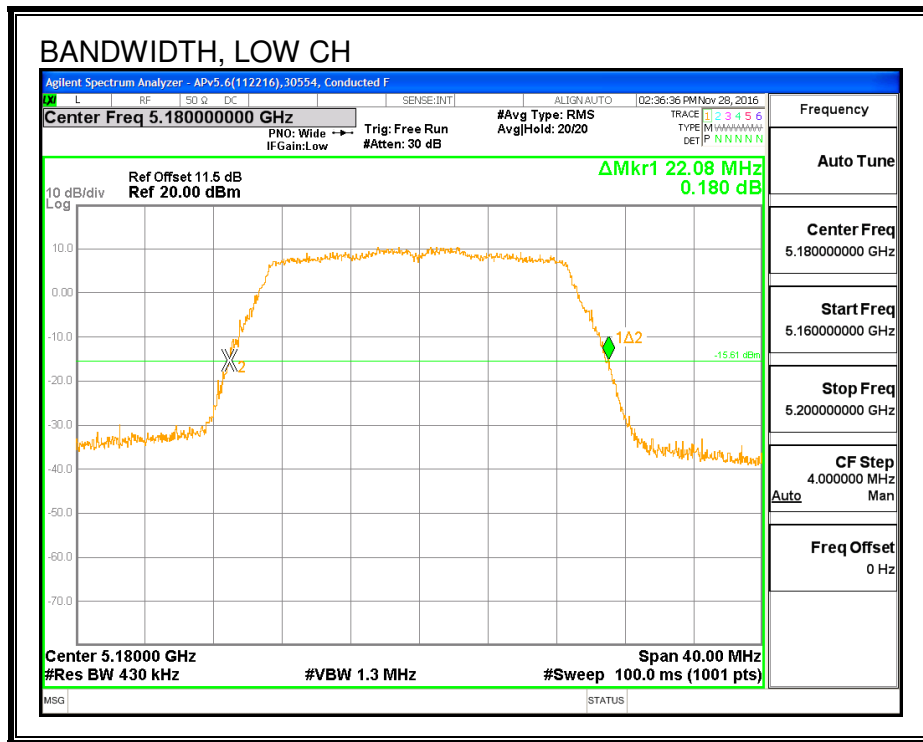

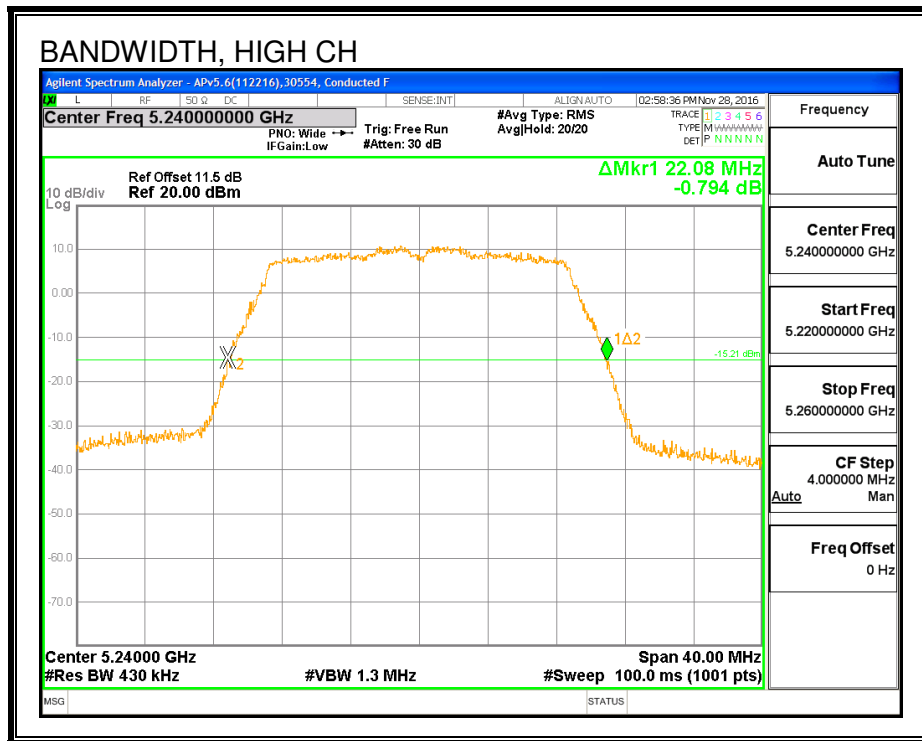

26 dB BANDWIDTH, ANTENNA B

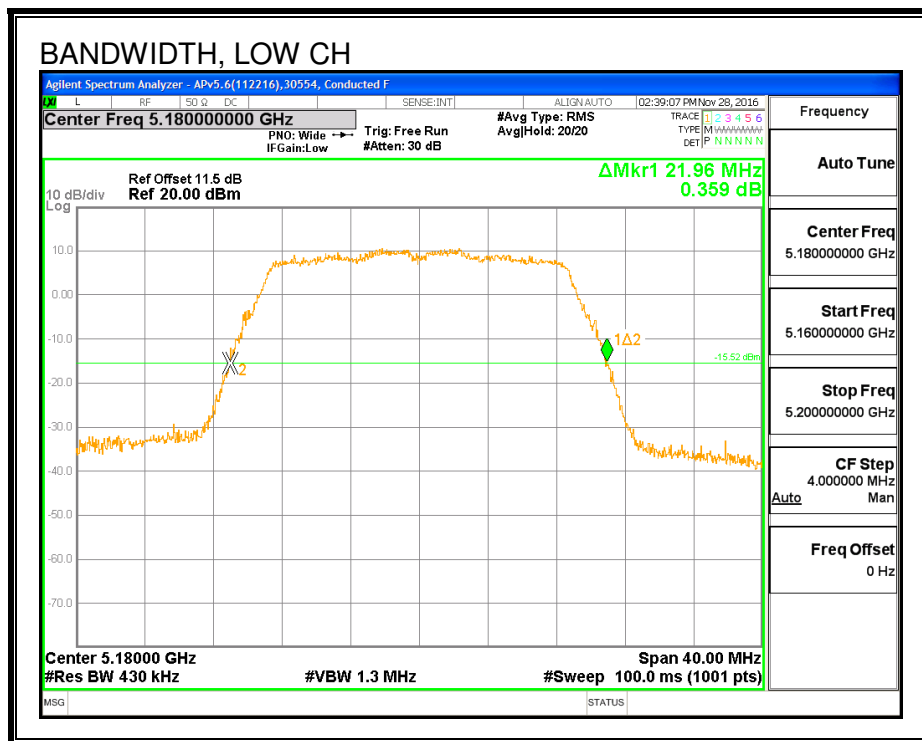

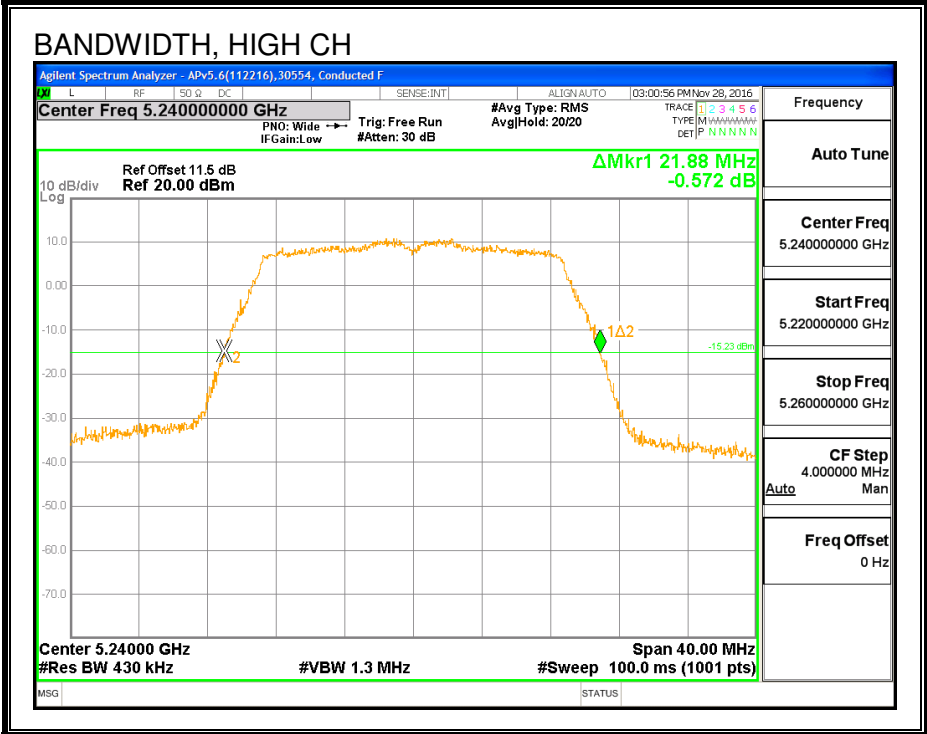
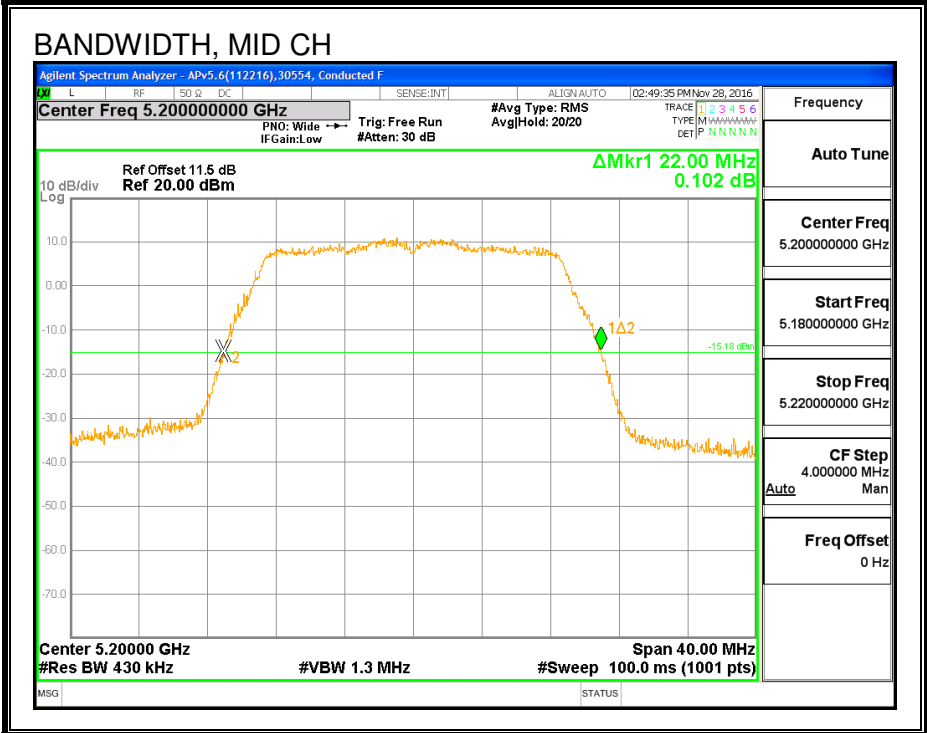

8.3.2. 99% BANDWIDTH

LIMITS

None; for reporting purposes only.

RESULTS

Channel	Frequency (MHz)	99% BW Ant A (MHz)	99% BW Ant B (MHz)
Low	5180	17.720	17.733
Mid	5200	17.694	17.794
High	5240	17.709	17.685

99% BANDWIDTH, ANTENNA A

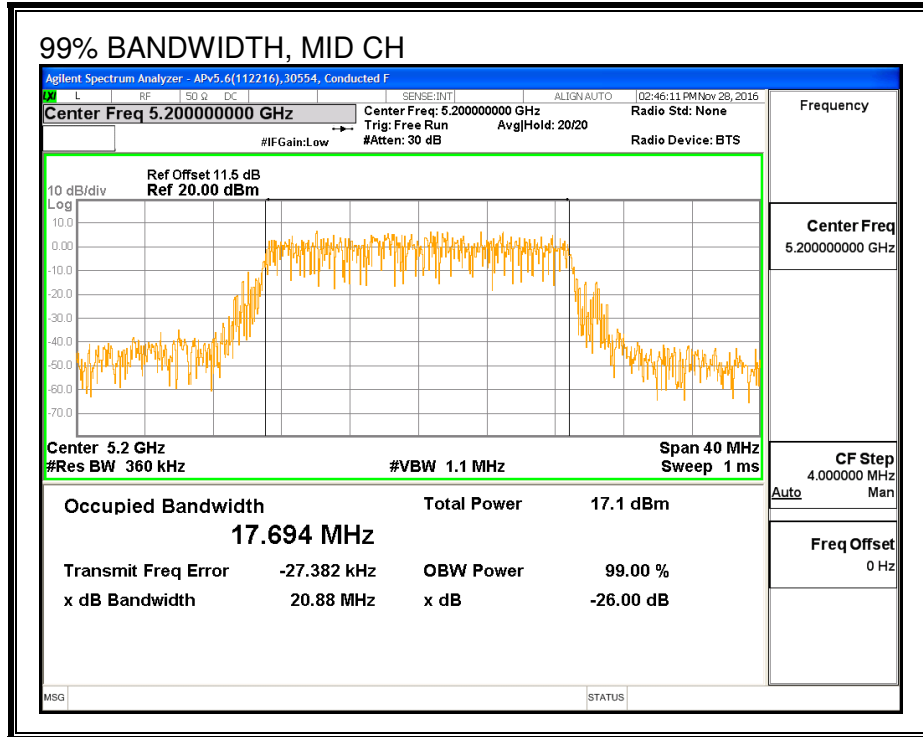
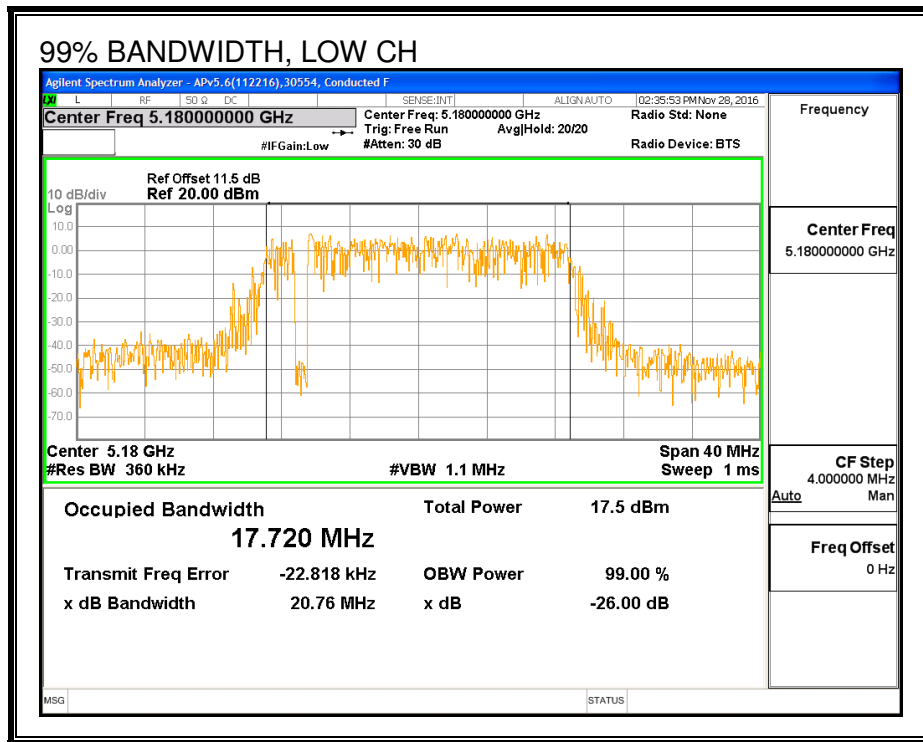

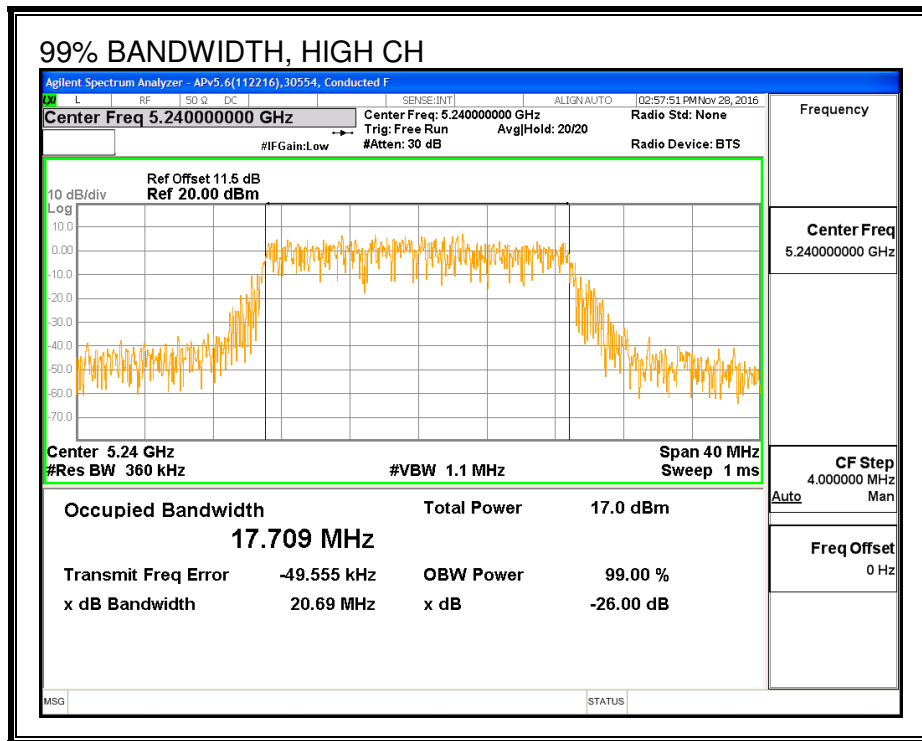

99% BANDWIDTH, ANTENNA B

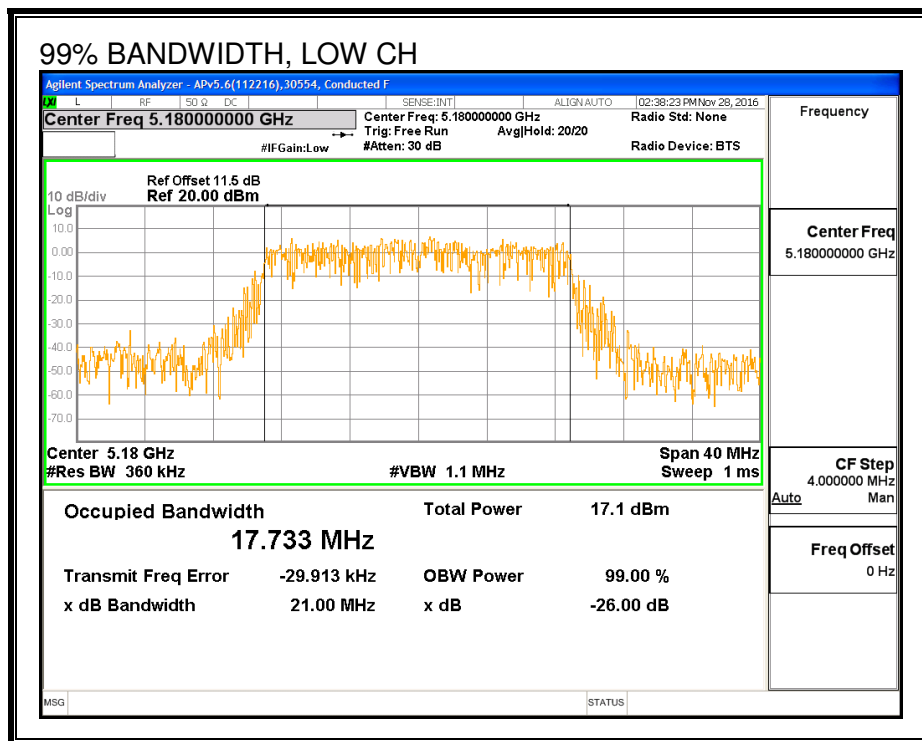

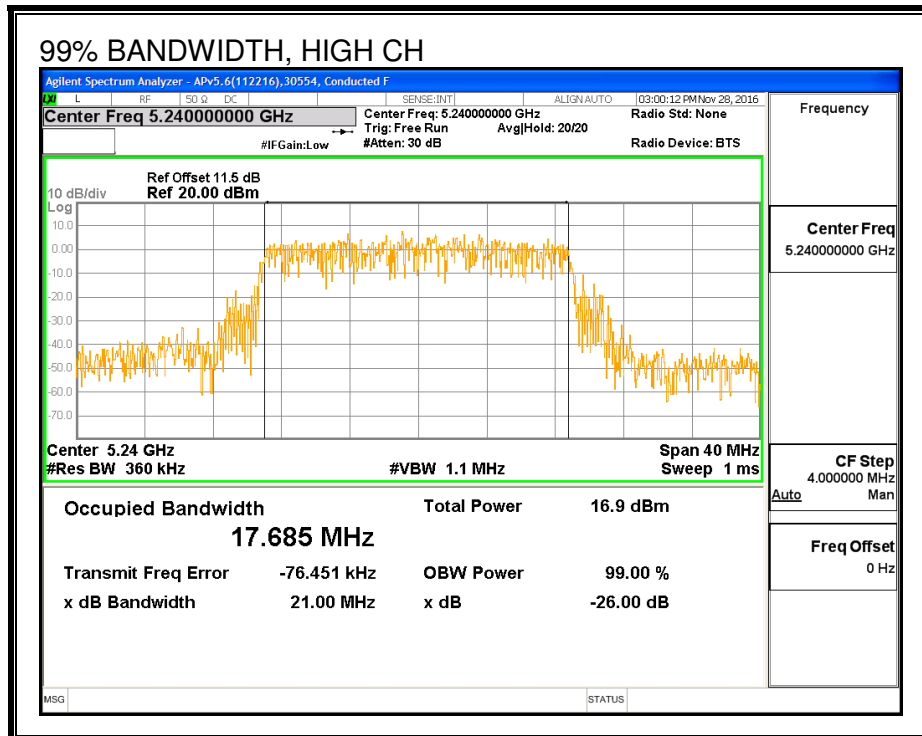
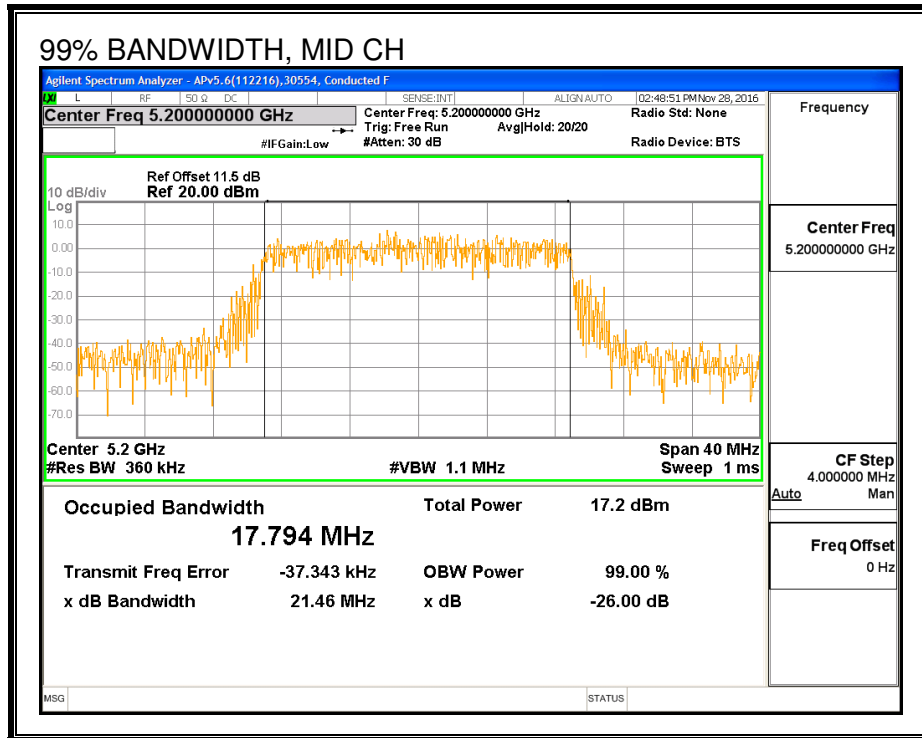

8.3.3. AVERAGE POWER

LIMITS

None; for reporting purposes only.

TEST PROCEDURE

Measurements perform using a wideband gated RF power meter.

RESULTS

ID:	39919	Date:	1/31/17
------------	-------	--------------	---------

Average Power Results

Channel	Frequency (MHz)	Antenna A Power (dBm)	Antenna B Power (dBm)	Total Power (dBm)
Low	5180	14.89	14.97	17.94
Mid	5200	15.40	15.38	18.40
High	5240	15.45	15.41	18.44

8.3.4. OUTPUT POWER AND PSD

LIMITS

FCC §15.407 (a) (1)

(i) For an outdoor access point operating in the band 5.15-5.25 GHz, the maximum conducted output power over the frequency band of operation shall not exceed 1 W provided the maximum antenna gain does not exceed 6 dBi. In addition, the maximum power spectral density shall not exceed 17 dBm in any 1 megahertz band. If transmitting antennas of directional gain greater than 6 dBi are used, both the maximum conducted output power and the maximum power spectral density shall be reduced by the amount in dB that the directional gain of the antenna exceeds 6 dBi. The maximum e.i.r.p. at any elevation angle above 30 degrees as measured from the horizon must not exceed 125 mW (21 dBm).

(ii) For an indoor access point operating in the band 5.15-5.25 GHz, the maximum conducted output power over the frequency band of operation shall not exceed 1 W provided the maximum antenna gain does not exceed 6 dBi. In addition, the maximum power spectral density shall not exceed 17 dBm in any 1 megahertz band. If transmitting antennas of directional gain greater than 6 dBi are used, both the maximum conducted output power and the maximum power spectral density shall be reduced by the amount in dB that the directional gain of the antenna exceeds 6 dBi.

(iii) For fixed point-to-point access points operating in the band 5.15-5.25 GHz, the maximum conducted output power over the frequency band of operation shall not exceed 1 W. Fixed point-to-point U-NII devices may employ antennas with directional gain up to 23 dBi without any corresponding reduction in the maximum conducted output power or maximum power spectral density. For fixed point-to-point transmitters that employ a directional antenna gain greater than 23 dBi, a 1 dB reduction in maximum conducted output power and maximum power spectral density is required for each 1 dB of antenna gain in excess of 23 dBi. Fixed, point-to-point operations exclude the use of point-to-multipoint systems, omnidirectional applications, and multiple collocated transmitters transmitting the same information. The operator of the U-NII device, or if the equipment is professionally installed, the installer, is responsible for ensuring that systems employing high gain directional antennas are used exclusively for fixed, point-to-point operations.

(iv) For mobile and portable client devices in the 5.15-5.25 GHz band, the maximum conducted output power over the frequency band of operation shall not exceed 250 mW provided the maximum antenna gain does not exceed 6 dBi. In addition, the maximum power spectral density shall not exceed 11 dBm in any 1 megahertz band. If transmitting antennas of directional gain greater than 6 dBi are used, both the maximum conducted output power and the maximum power spectral density shall be reduced by the amount in dB that the directional gain of the antenna exceeds 6 dBi.

TEST PROCEDURE

Measurements perform using a wideband gated RF power meter provided that the gate parameters are adjusted such that the power is measured only when the EUT is transmitting at its maximum power control level. Since the measurement is made only during the ON time of the transmitter, no duty cycle correction factor is required.

DIRECTIONAL ANTENNA GAIN

The TX chains are uncorrelated and the antenna gain is unequal among the chains. The directional gain is:

Antenna A	Antenna B	Uncorrelated Chains
Gain (dBi)	Gain (dBi)	Directional Gain (dBi)
3.48	3.33	3.41

The TX chains are correlated and the antenna gain is unequal among the chains. The directional gain is:

Antenna A	Antenna B	Correlated Chains
Gain (dBi)	Gain (dBi)	Directional Gain (dBi)
3.48	3.33	6.42

RESULTS

ID:	39919	Date:	1/31/17
------------	-------	--------------	---------

Antenna Gain and Limits

Channel	Frequency (MHz)	Directional Gain for Power (dBi)	Directional Gain for PSD (dBi)	Power Limit (dBm)	PSD Limit (dBm)
Low	5180	3.41	6.42	24.00	10.58
Mid	5200	3.41	6.42	24.00	10.58
High	5240	3.41	6.42	24.00	10.58

Duty Cycle CF (dB)	0.00	Included in Calculations of Corr'd PSD
---------------------------	------	---

Output Power Results

Channel	Frequency (MHz)	Antenna A Meas Power (dBm)	Antenna B Meas Power (dBm)	Total Corr'd Power (dBm)	Power Limit (dBm)	Power Margin (dB)
Low	5180	14.89	14.97	17.94	24.00	-6.06
Mid	5200	15.40	15.38	18.40	24.00	-5.60
High	5240	15.45	15.41	18.44	24.00	-5.56

PSD Results

Channel	Frequency (MHz)	Antenna A Meas PSD (dBm)	Antenna B Meas PSD (dBm)	Total Corr'd PSD (dBm)	PSD Limit (dBm)	PSD Margin (dB)
Low	5180	6.26	6.41	9.34	10.58	-1.24
Mid	5200	6.34	6.22	9.29	10.58	-1.29
High	5240	6.50	6.07	9.30	10.58	-1.28

PSD, Antenna A

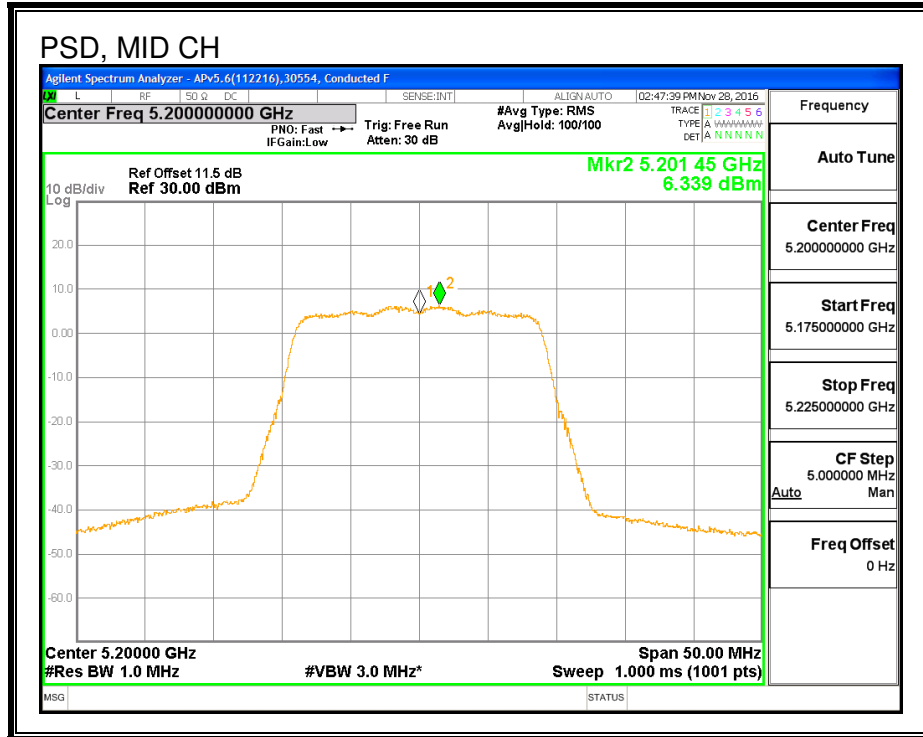
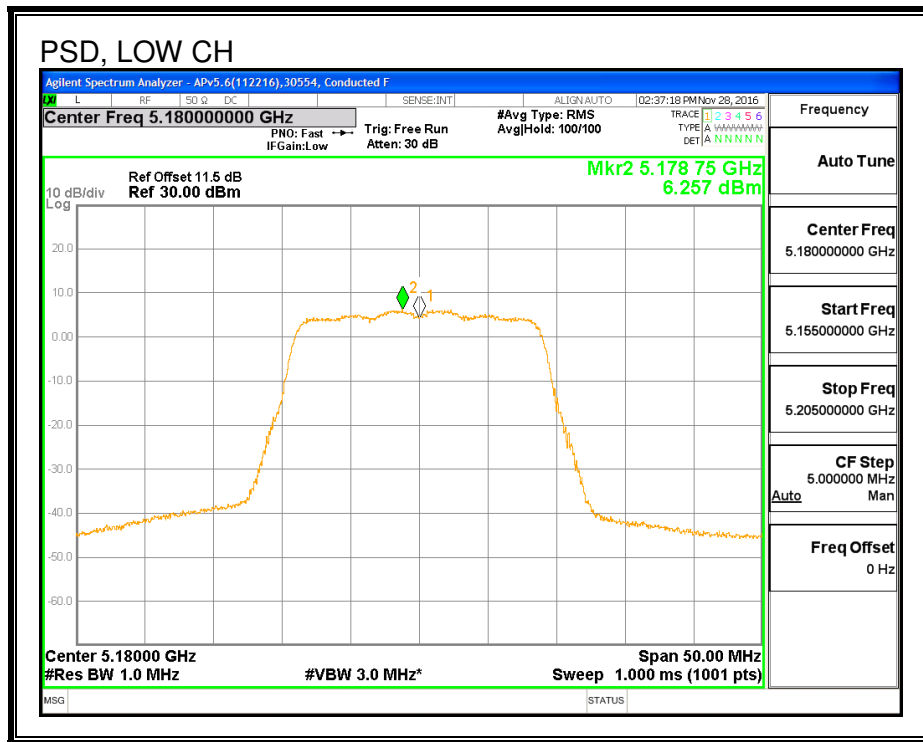

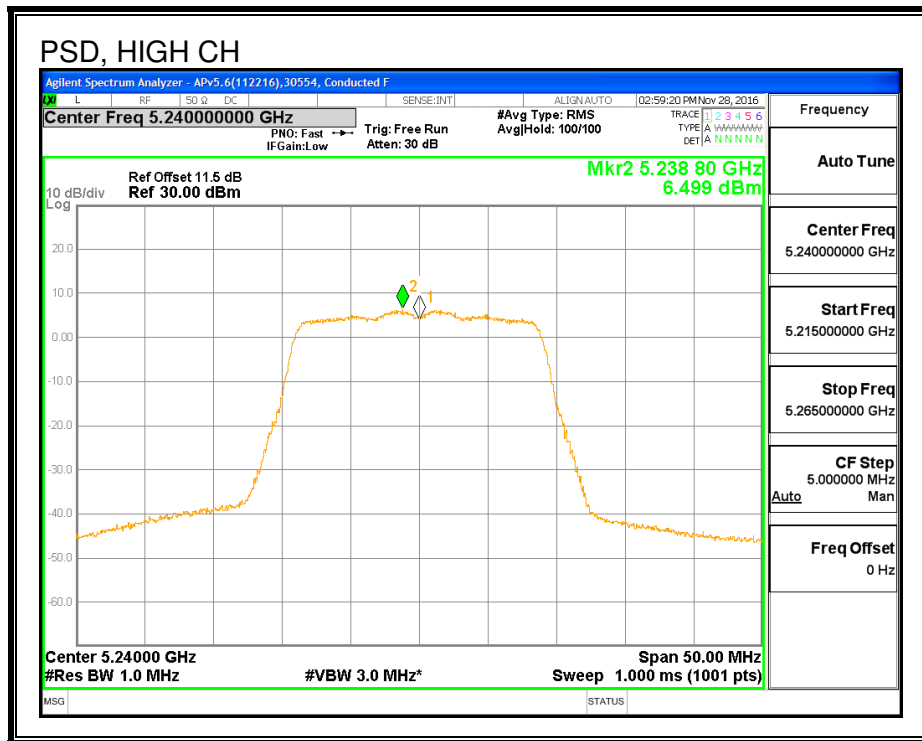

PSD, Antenna B

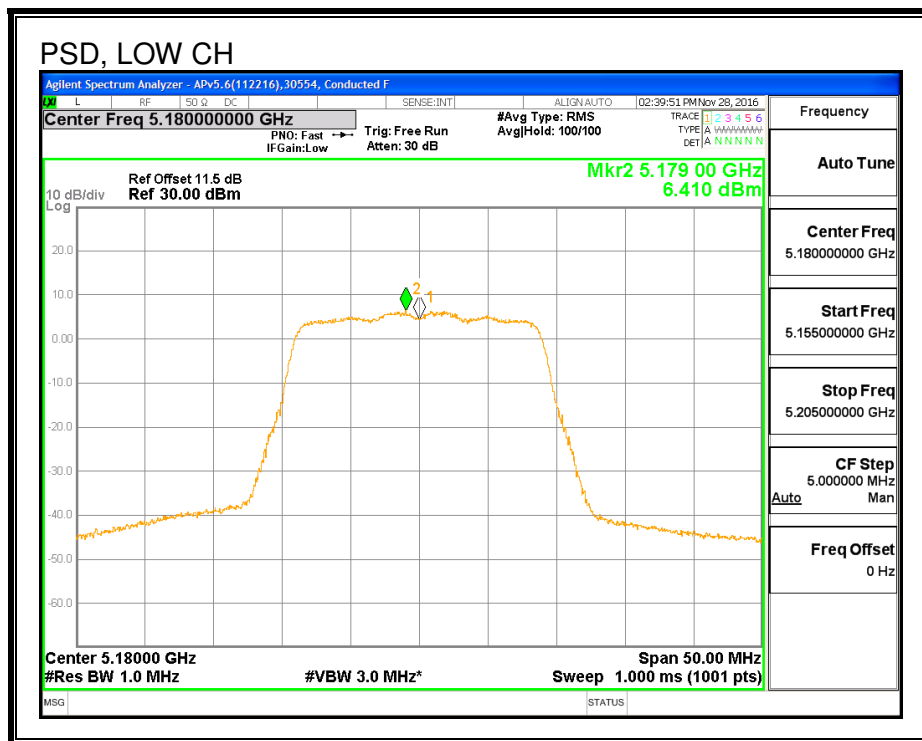

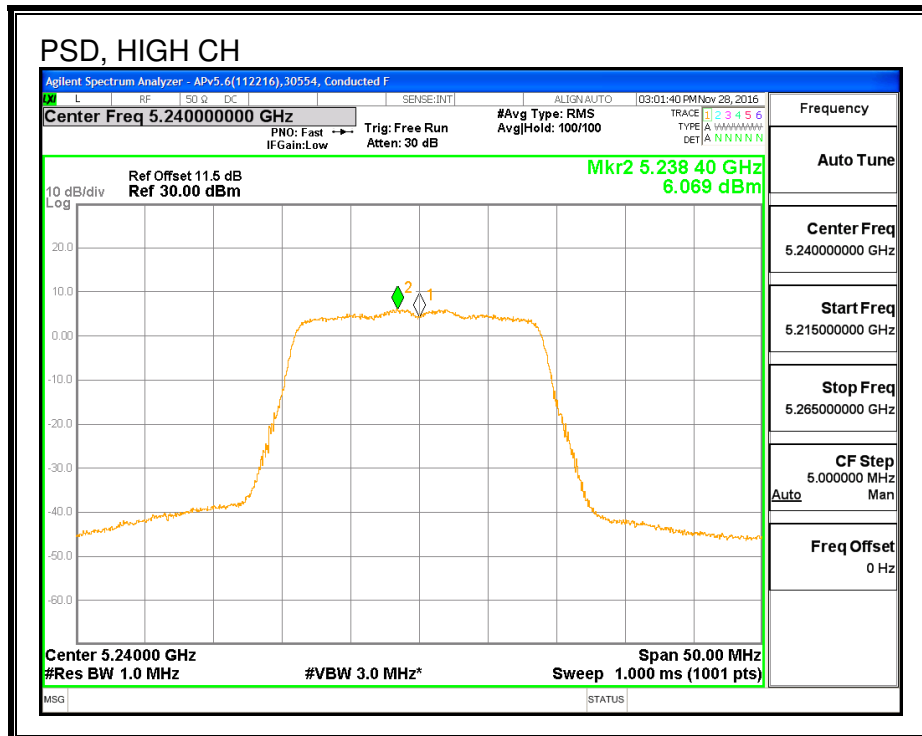
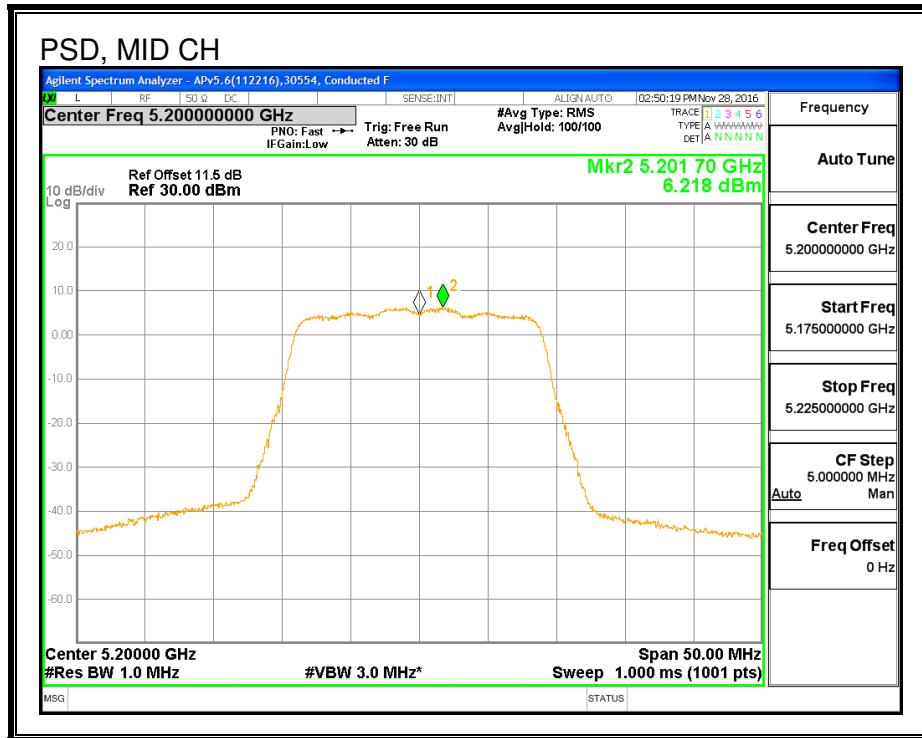

**8.4. 802.11n HT20 2Tx (ANTENNA A + ANTENNA B) STBC MODE IN THE
5.2 GHz BAND**

8.4.1. 26 dB BANDWIDTH

LIMITS

None; for reporting purposes only.

RESULTS

Channel	Frequency (MHz)	26 dB BW Ant A (MHz)	26 dB BW Ant B (MHz)
Low	5180	22.080	21.560
Mid	5200	21.920	21.880
High	5240	21.920	21.600

26 DB BANDWIDTH, Antenna A

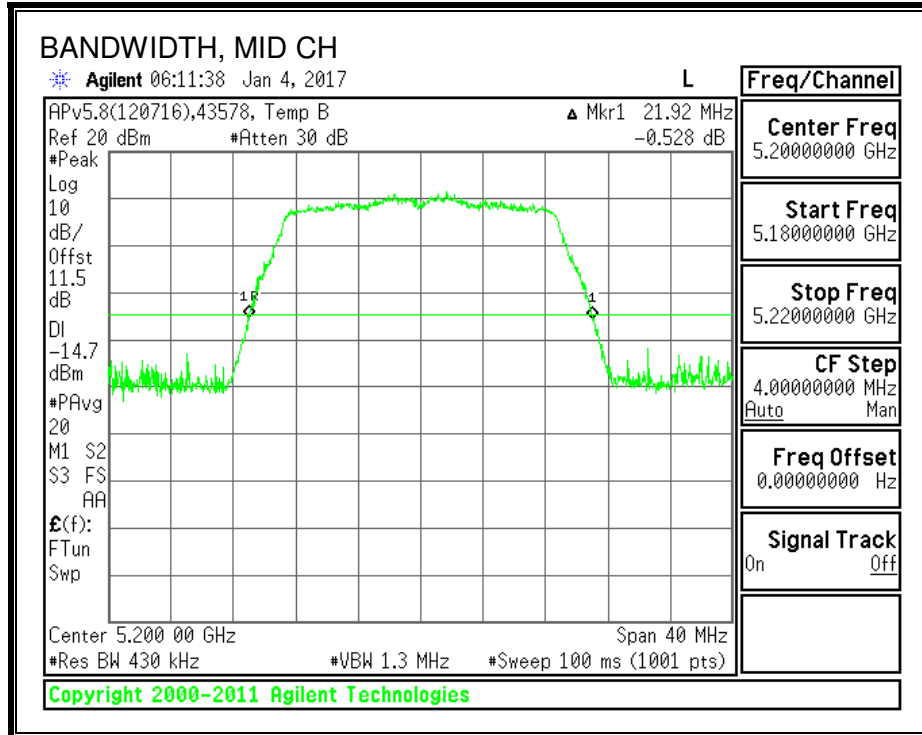
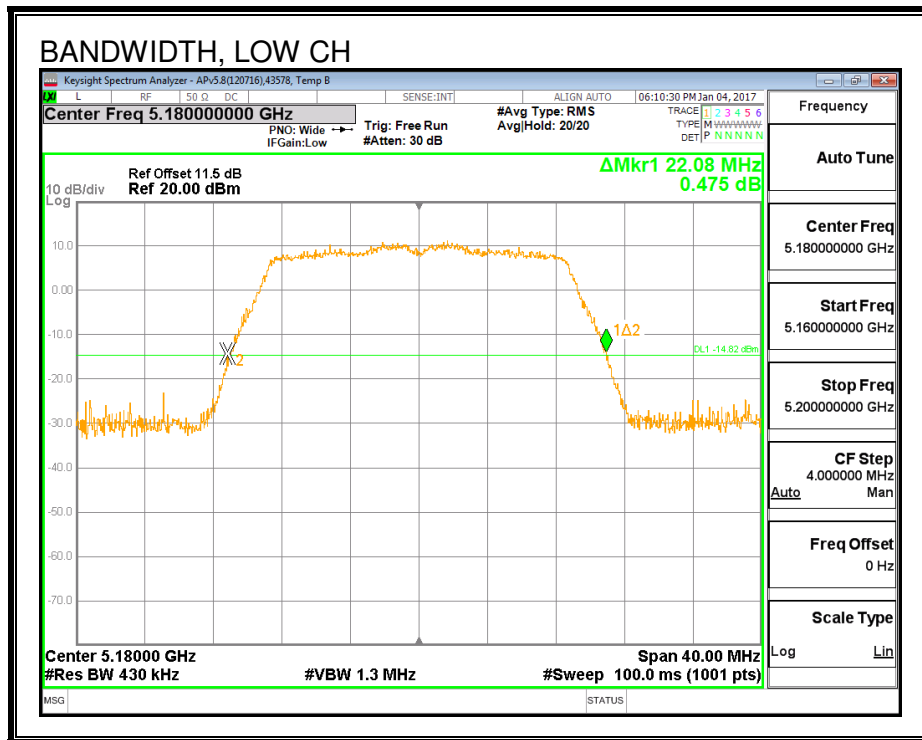

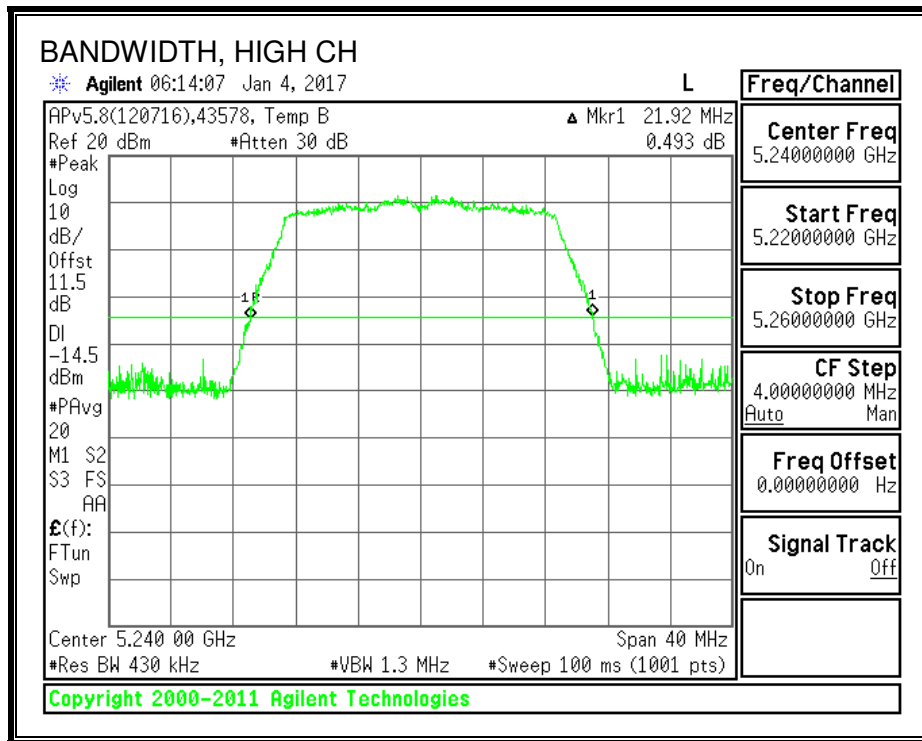

26 DB BANDWIDTH, Antenna B

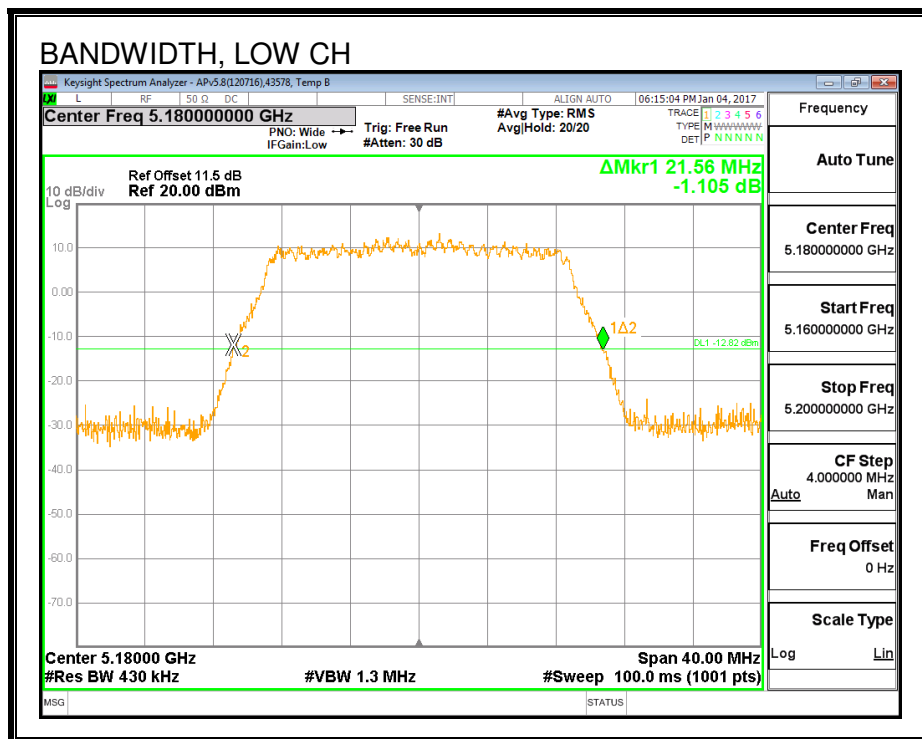

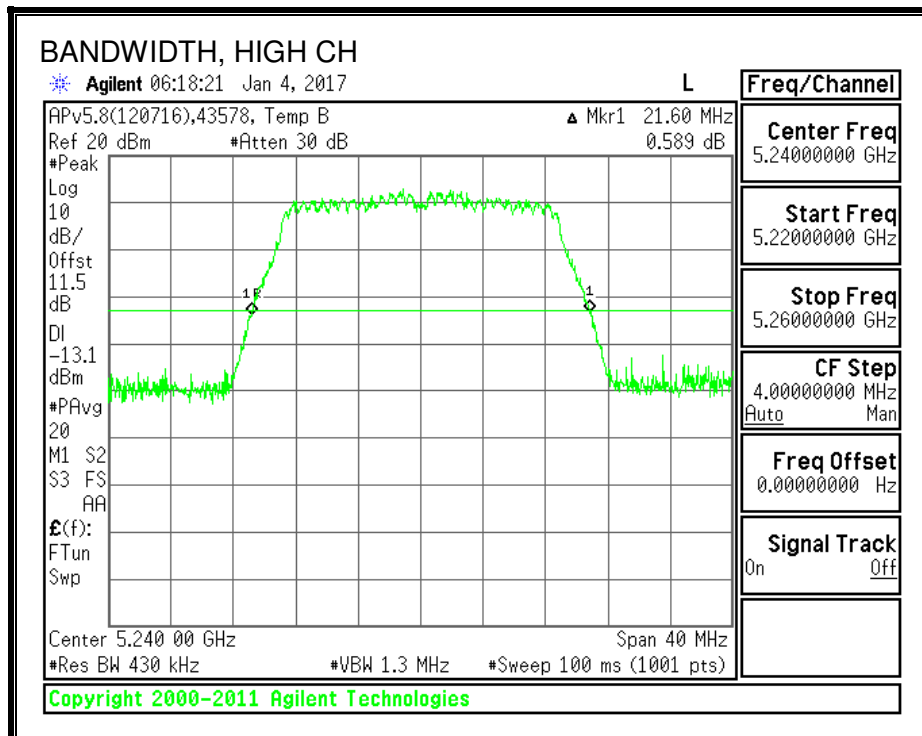
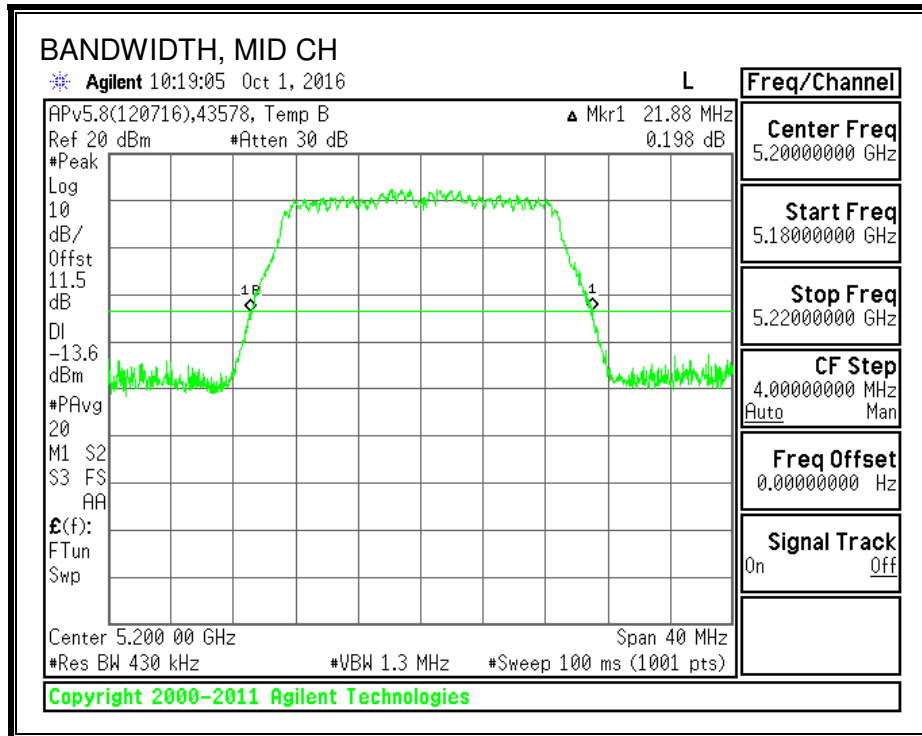

8.4.2. 99% BANDWIDTH

LIMITS

None; for reporting purposes only.

RESULTS

Channel	Frequency (MHz)	99% BW Ant A (MHz)	99% BW Ant B (MHz)
Low	5180	17.737	17.548
Mid	5200	17.692	17.588
High	5240	17.654	17.639

99% BANDWIDTH, Antenna A

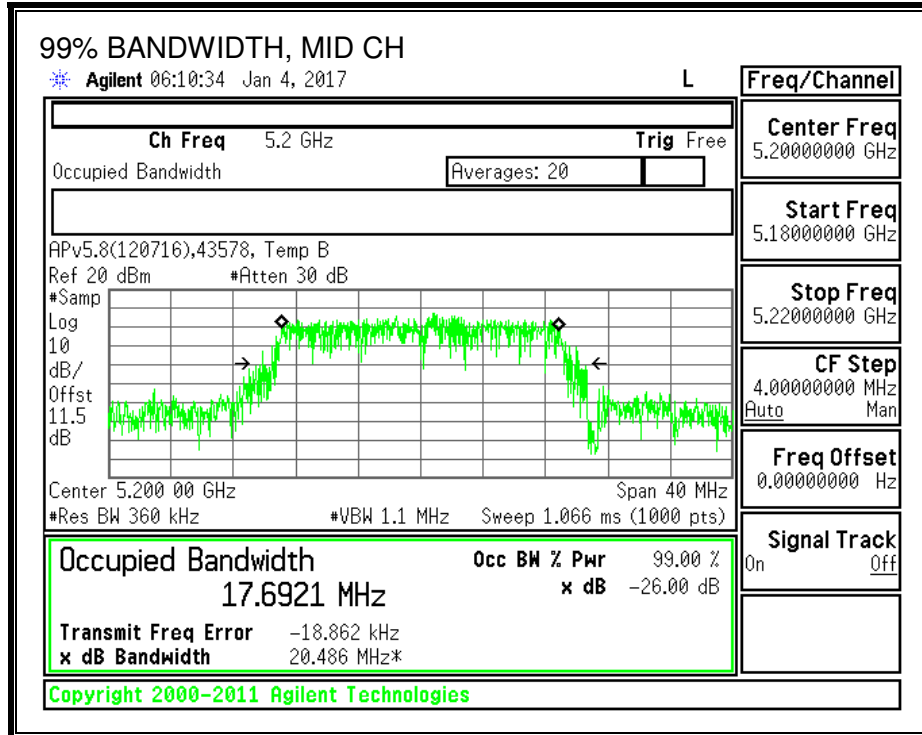
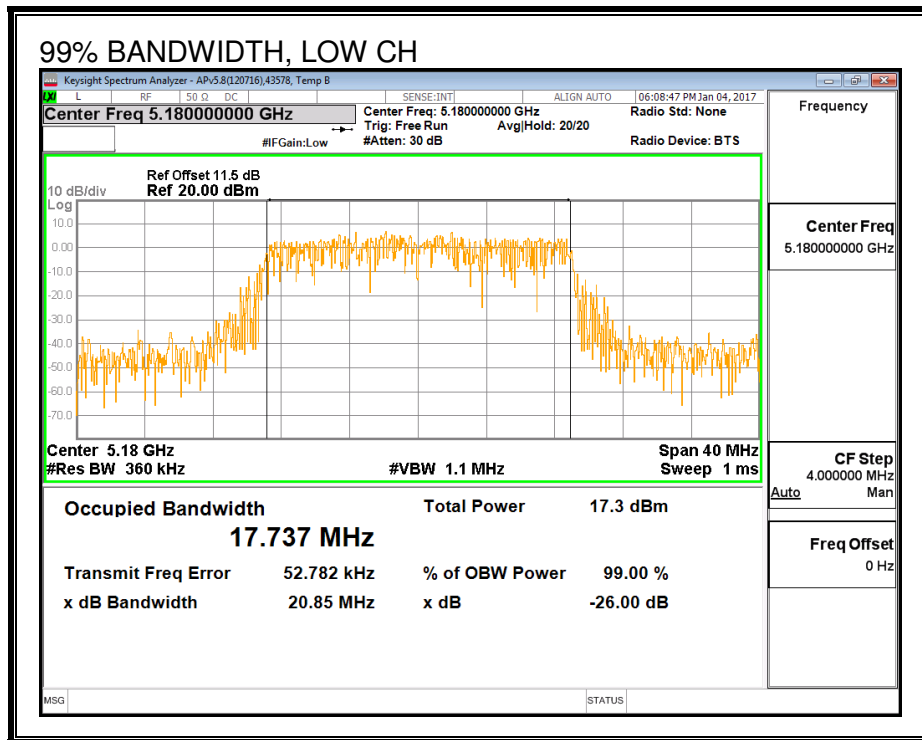

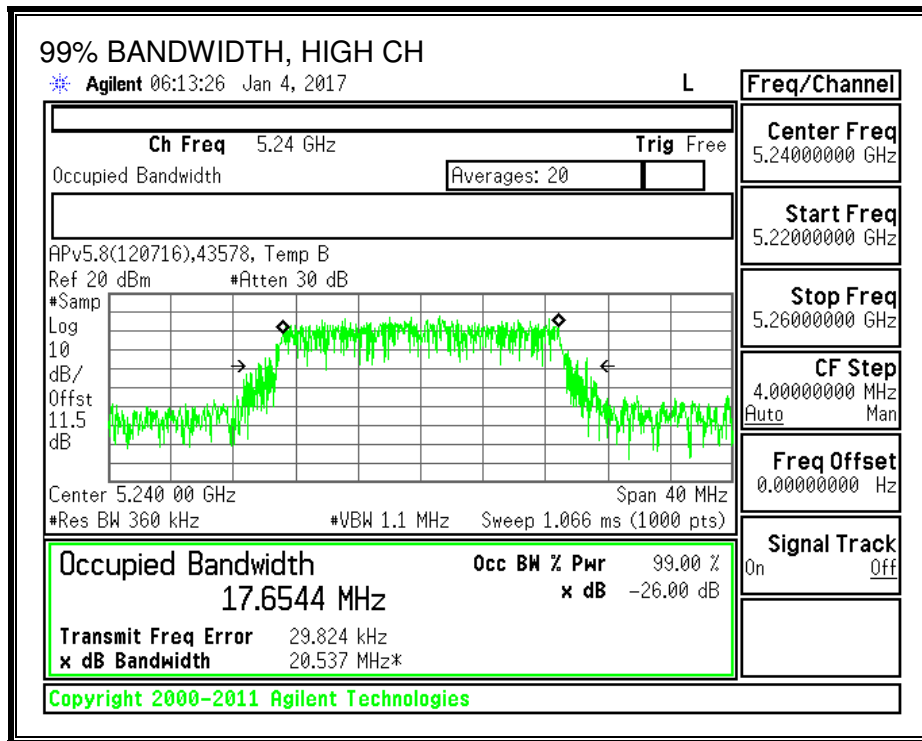

99% BANDWIDTH, Antenna B

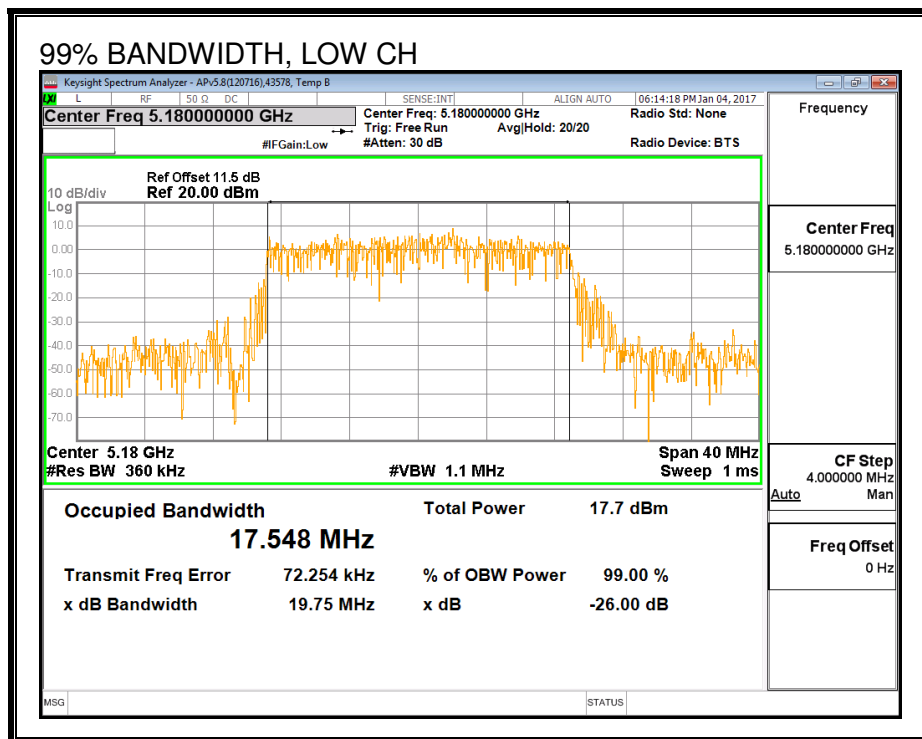

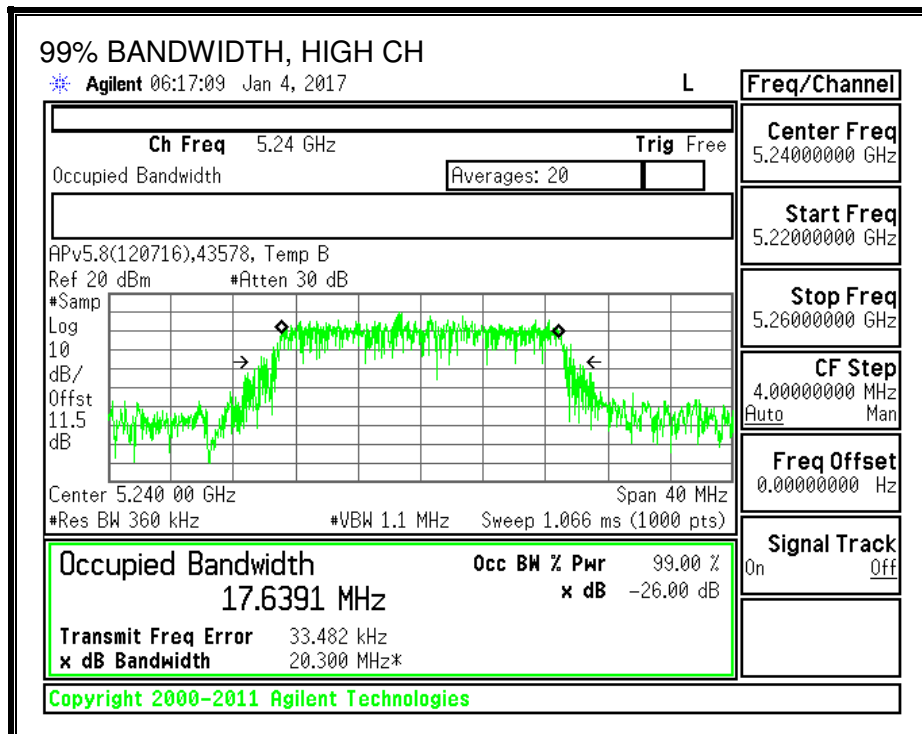
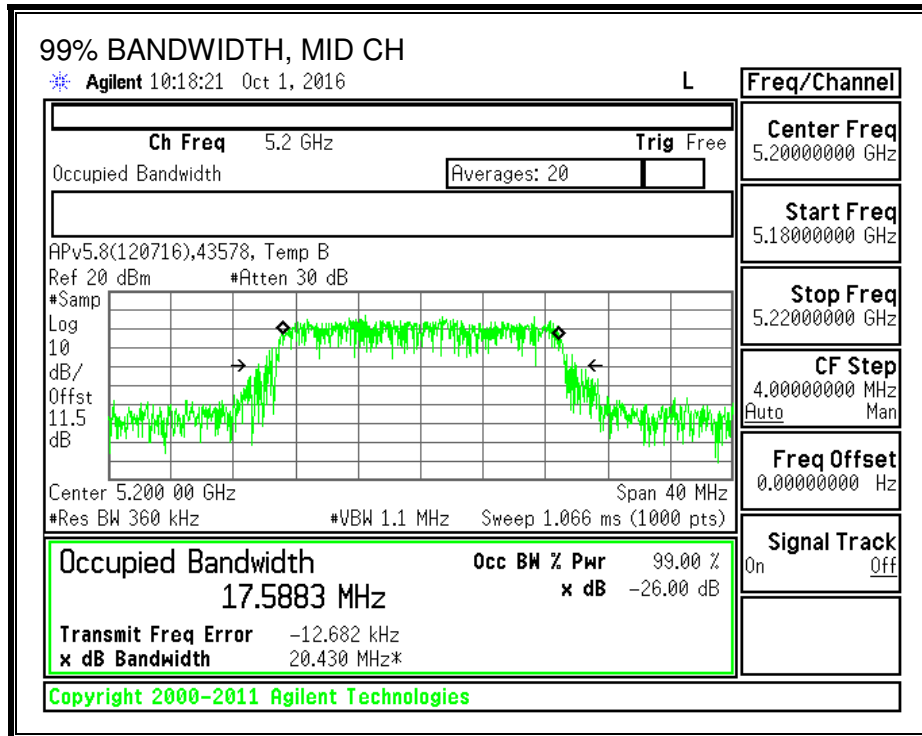

8.4.3. AVERAGE POWER

LIMITS

None; for reporting purposes only.

TEST PROCEDURE

Measurements perform using a wideband gated RF power meter.

RESULTS

ID:	39472	Date:	2/1/17
------------	-------	--------------	--------

Average Power Results

Channel	Frequency (MHz)	Antenna A Power (dBm)	Antenna B Power (dBm)	Total Power (dBm)
Low	5180	14.89	14.97	17.94
Mid	5200	16.94	15.89	19.46
High	5240	16.90	15.92	19.45

8.4.4. OUTPUT POWER AND PSD

LIMITS

FCC §15.407 (a) (1)

(i) For an outdoor access point operating in the band 5.15-5.25 GHz, the maximum conducted output power over the frequency band of operation shall not exceed 1 W provided the maximum antenna gain does not exceed 6 dBi. In addition, the maximum power spectral density shall not exceed 17 dBm in any 1 megahertz band. If transmitting antennas of directional gain greater than 6 dBi are used, both the maximum conducted output power and the maximum power spectral density shall be reduced by the amount in dB that the directional gain of the antenna exceeds 6 dBi. The maximum e.i.r.p. at any elevation angle above 30 degrees as measured from the horizon must not exceed 125 mW (21 dBm).

(ii) For an indoor access point operating in the band 5.15-5.25 GHz, the maximum conducted output power over the frequency band of operation shall not exceed 1 W provided the maximum antenna gain does not exceed 6 dBi. In addition, the maximum power spectral density shall not exceed 17 dBm in any 1 megahertz band. If transmitting antennas of directional gain greater than 6 dBi are used, both the maximum conducted output power and the maximum power spectral density shall be reduced by the amount in dB that the directional gain of the antenna exceeds 6 dBi.

(iii) For fixed point-to-point access points operating in the band 5.15-5.25 GHz, the maximum conducted output power over the frequency band of operation shall not exceed 1 W. Fixed point-to-point U-NII devices may employ antennas with directional gain up to 23 dBi without any corresponding reduction in the maximum conducted output power or maximum power spectral density. For fixed point-to-point transmitters that employ a directional antenna gain greater than 23 dBi, a 1 dB reduction in maximum conducted output power and maximum power spectral density is required for each 1 dB of antenna gain in excess of 23 dBi. Fixed, point-to-point operations exclude the use of point-to-multipoint systems, omnidirectional applications, and multiple collocated transmitters transmitting the same information. The operator of the U-NII device, or if the equipment is professionally installed, the installer, is responsible for ensuring that systems employing high gain directional antennas are used exclusively for fixed, point-to-point operations.

(iv) For mobile and portable client devices in the 5.15-5.25 GHz band, the maximum conducted output power over the frequency band of operation shall not exceed 250 mW provided the maximum antenna gain does not exceed 6 dBi. In addition, the maximum power spectral density shall not exceed 11 dBm in any 1 megahertz band. If transmitting antennas of directional gain greater than 6 dBi are used, both the maximum conducted output power and the maximum power spectral density shall be reduced by the amount in dB that the directional gain of the antenna exceeds 6 dBi.

TEST PROCEDURE

Measurements perform using a wideband gated RF power meter provided that the gate parameters are adjusted such that the power is measured only when the EUT is transmitting at its maximum power control level. Since the measurement is made only during the ON time of the transmitter, no duty cycle correction factor is required.

DIRECTIONAL ANTENNA GAIN

The TX chains are uncorrelated and the antenna gain is unequal among the chains. The directional gain is:

Antenna A	Antenna B	Uncorrelated Chains
Gain	Gain	Directional
(dBi)	(dBi)	Gain
(dBi)	(dBi)	(dBi)
3.48	3.33	3.41

RESULTS

ID:	39472	Date:	2/1/17
------------	-------	--------------	--------

Antenna Gain and Limits

Channel	Frequency (MHz)	Directional Gain for Power (dBi)	Directional Gain for PSD (dBi)	Power Limit (dBm)	PSD Limit (dBm)
Low	5180	3.41	3.41	24.00	11.00
Mid	5200	3.41	3.41	24.00	11.00
High	5240	3.41	3.41	24.00	11.00

Duty Cycle CF (dB)	0.00	Included in Calculations of Corr'd PSD
---------------------------	------	---

Output Power Results

Channel	Frequency (MHz)	Antenna A Meas Power (dBm)	Antenna B Meas Power (dBm)	Total Corr'd Power (dBm)	Power Limit (dBm)	Power Margin (dB)
Low	5180	14.89	14.97	17.94	24.00	-6.06
Mid	5200	16.94	15.89	19.46	24.00	-4.54
High	5240	16.9	15.92	19.45	24.00	-4.55

PSD Results

Channel	Frequency (MHz)	Antenna A Meas PSD (dBm)	Antenna B Meas PSD (dBm)	Total Corr'd PSD (dBm)	PSD Limit (dBm)	PSD Margin (dB)
Low	5180	6.59	6.66	9.63	11.00	-1.37
Mid	5200	6.19	6.80	9.52	11.00	-1.48
High	5240	6.79	6.49	9.65	11.00	-1.35

PSD, Antenna A

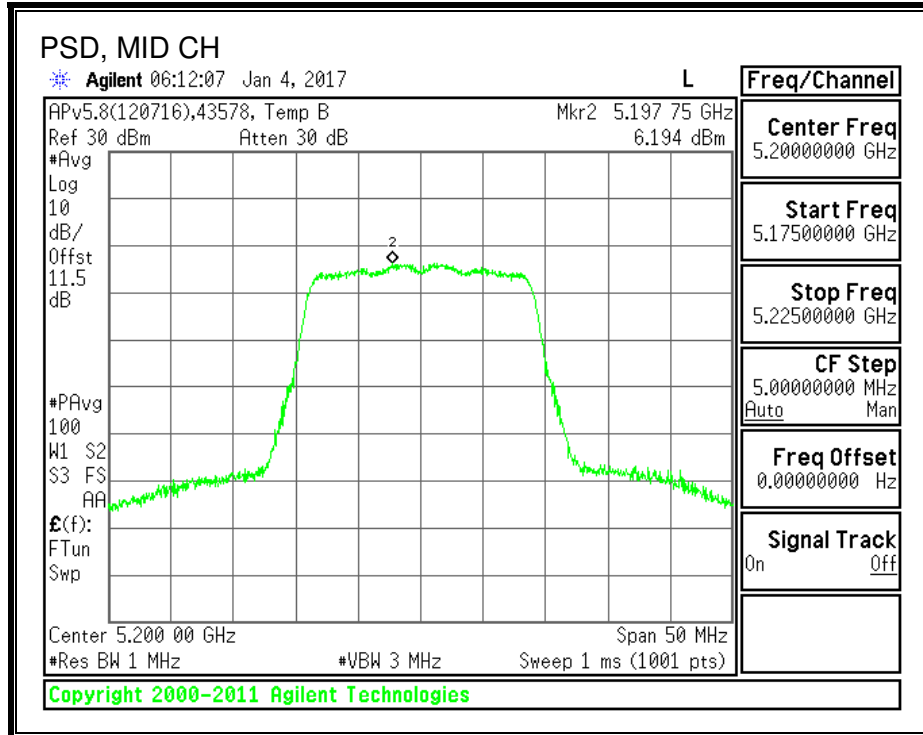
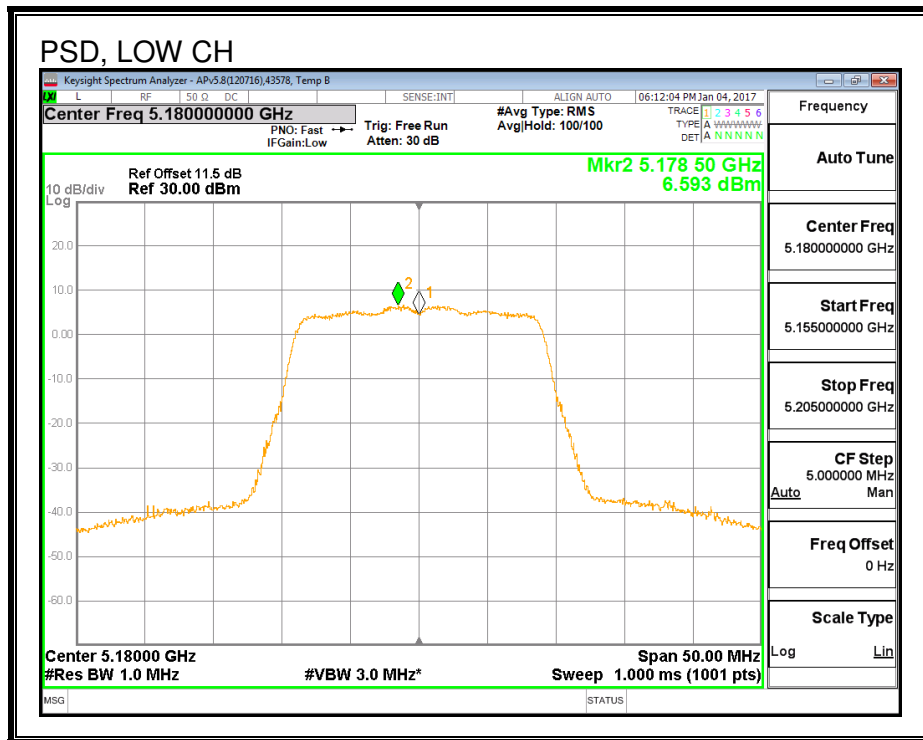

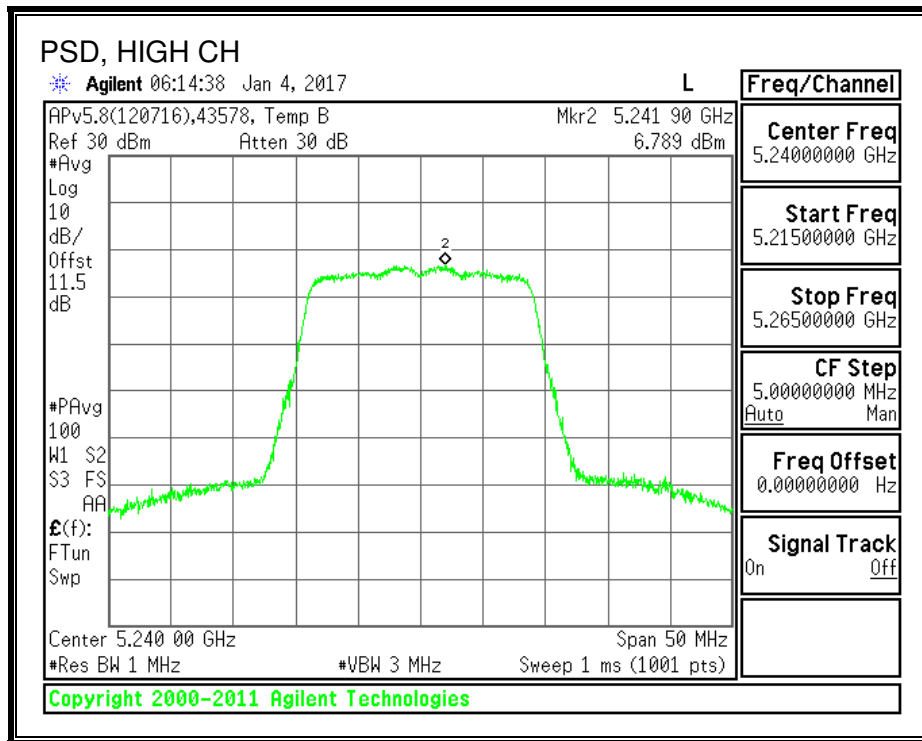

PSD, Antenna B

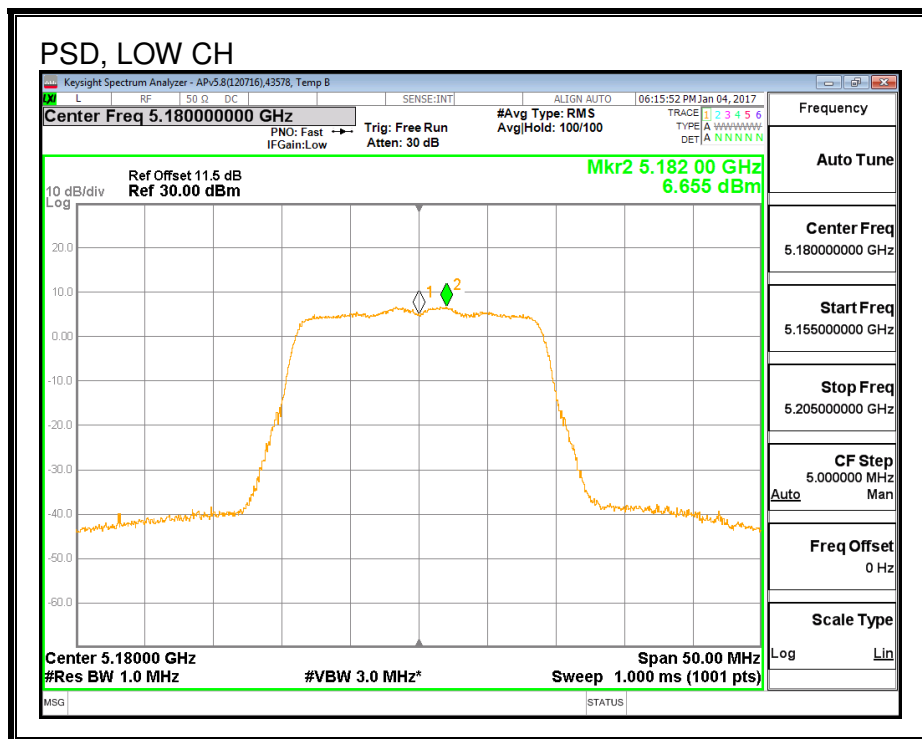

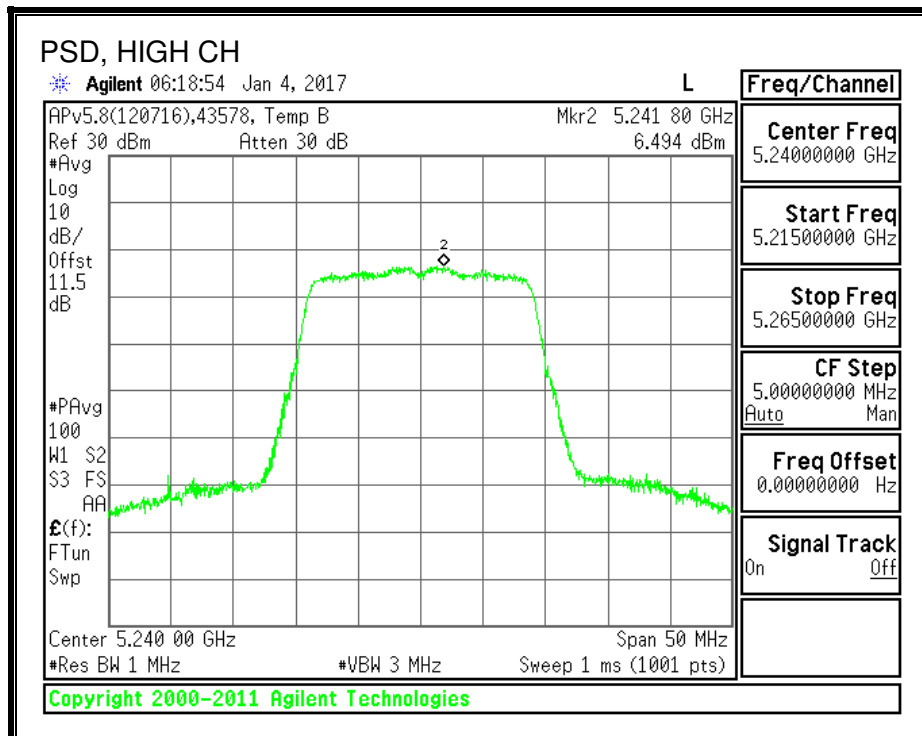
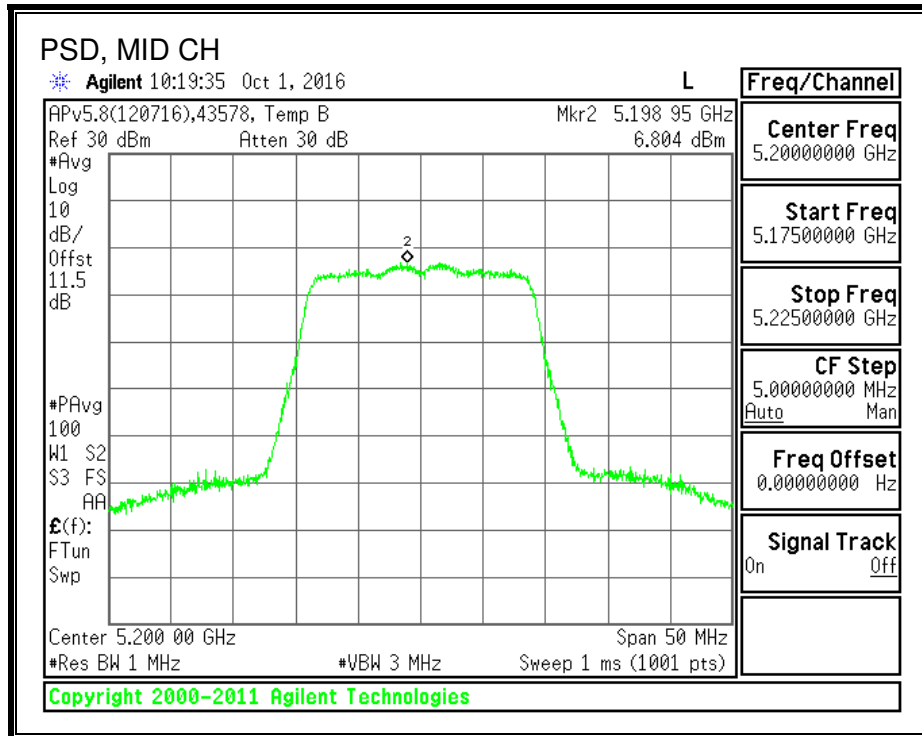

8.5. 802.11n HT40 ANTENNA A MODE IN THE 5.2 GHz BAND

8.5.1. 26 dB BANDWIDTH

LIMITS

None; for reporting purposes only.

RESULTS

Channel	Frequency (MHz)	26 dB Bandwidth (MHz)
Low	5190	40.720
High	5230	40.560

26 dB BANDWIDTH

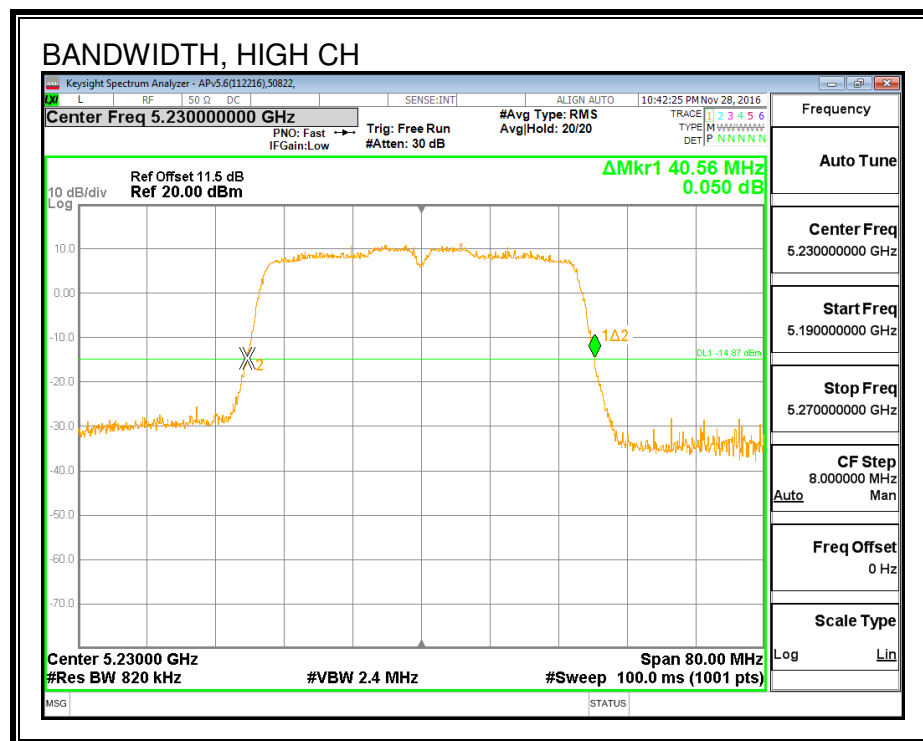
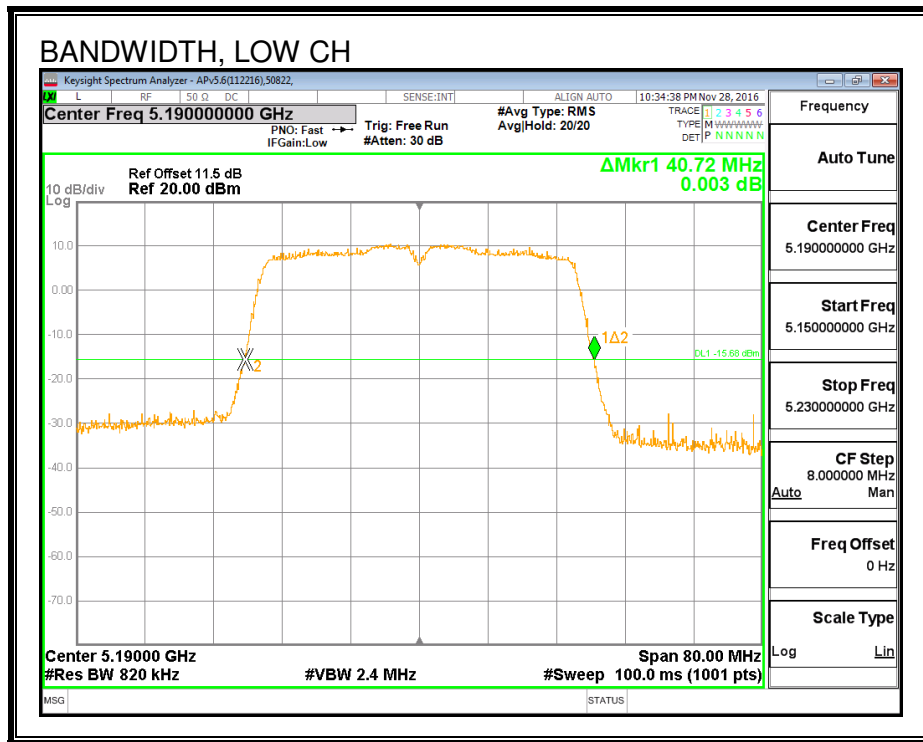

8.5.2. 99% BANDWIDTH

LIMITS

None; for reporting purposes only.

RESULTS

Channel	Frequency (MHz)	99% Bandwidth (MHz)
Low	5190	36.366
High	5230	36.285

99% BANDWIDTH

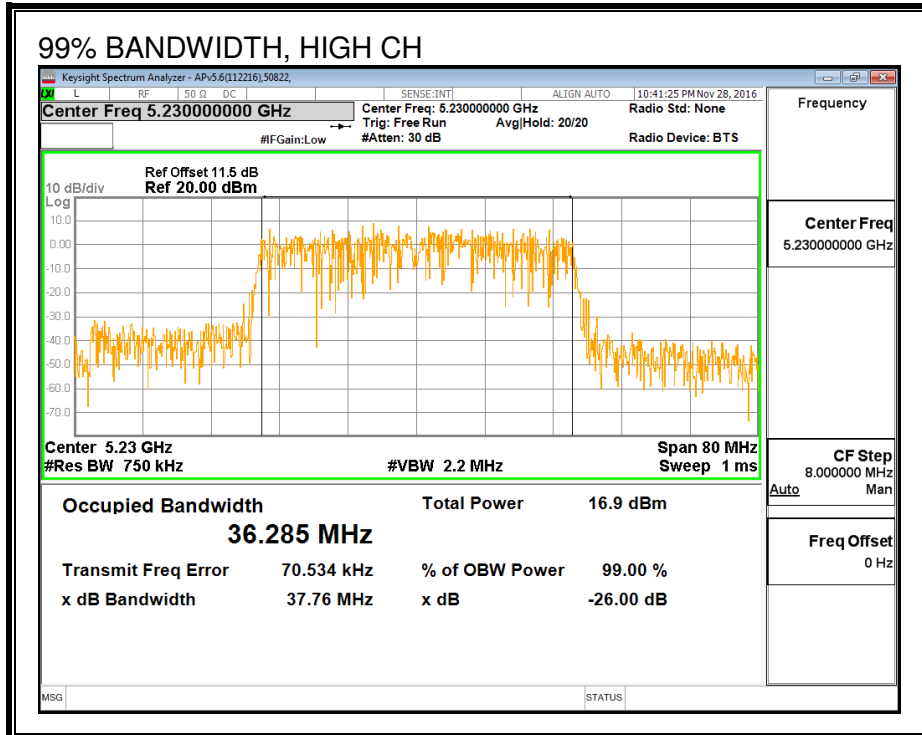
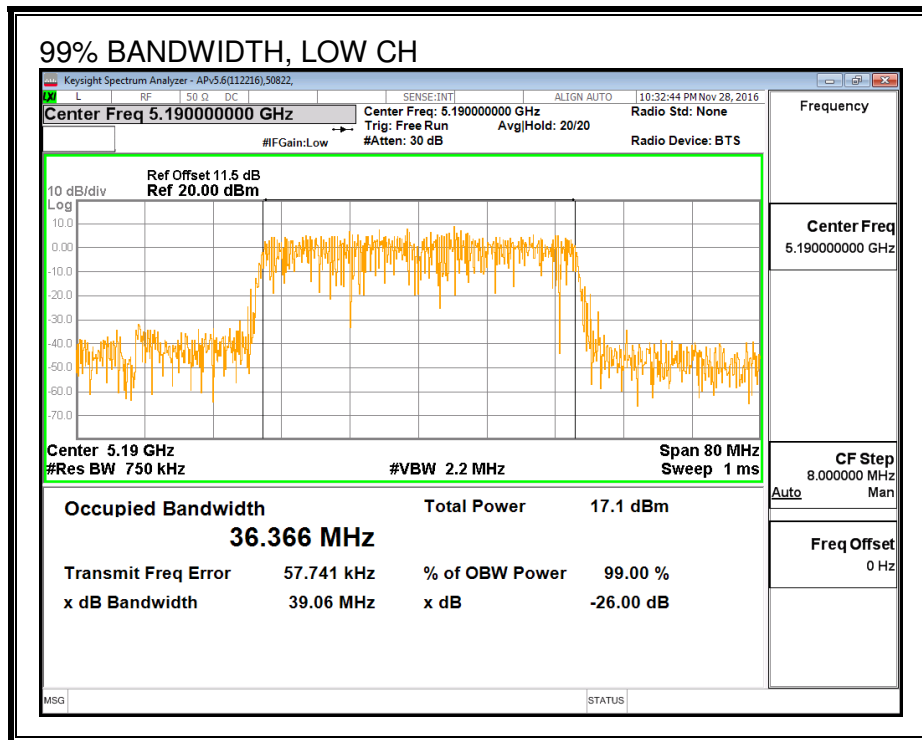

8.5.3. AVERAGE POWER

LIMITS

None; for reporting purposes only.

TEST PROCEDURE

Measurements perform using a wideband gated RF power meter.

RESULTS

ID:	39472	Date:	1/31/17
------------	-------	--------------	---------

Channel	Frequency (MHz)	Power (dBm)
Low	5190	13.99
High	5230	16.94

8.5.4. OUTPUT POWER AND PSD

LIMITS

FCC §15.407 (a) (1)

(i) For an outdoor access point operating in the band 5.15-5.25 GHz, the maximum conducted output power over the frequency band of operation shall not exceed 1 W provided the maximum antenna gain does not exceed 6 dBi. In addition, the maximum power spectral density shall not exceed 17 dBm in any 1 megahertz band. If transmitting antennas of directional gain greater than 6 dBi are used, both the maximum conducted output power and the maximum power spectral density shall be reduced by the amount in dB that the directional gain of the antenna exceeds 6 dBi. The maximum e.i.r.p. at any elevation angle above 30 degrees as measured from the horizon must not exceed 125 mW (21 dBm).

(ii) For an indoor access point operating in the band 5.15-5.25 GHz, the maximum conducted output power over the frequency band of operation shall not exceed 1 W provided the maximum antenna gain does not exceed 6 dBi. In addition, the maximum power spectral density shall not exceed 17 dBm in any 1 megahertz band. If transmitting antennas of directional gain greater than 6 dBi are used, both the maximum conducted output power and the maximum power spectral density shall be reduced by the amount in dB that the directional gain of the antenna exceeds 6 dBi.

(iii) For fixed point-to-point access points operating in the band 5.15-5.25 GHz, the maximum conducted output power over the frequency band of operation shall not exceed 1 W. Fixed point-to-point U-NII devices may employ antennas with directional gain up to 23 dBi without any corresponding reduction in the maximum conducted output power or maximum power spectral density. For fixed point-to-point transmitters that employ a directional antenna gain greater than 23 dBi, a 1 dB reduction in maximum conducted output power and maximum power spectral density is required for each 1 dB of antenna gain in excess of 23 dBi. Fixed, point-to-point operations exclude the use of point-to-multipoint systems, omnidirectional applications, and multiple collocated transmitters transmitting the same information. The operator of the U-NII device, or if the equipment is professionally installed, the installer, is responsible for ensuring that systems employing high gain directional antennas are used exclusively for fixed, point-to-point operations.

(iv) For mobile and portable client devices in the 5.15-5.25 GHz band, the maximum conducted output power over the frequency band of operation shall not exceed 250 mW provided the maximum antenna gain does not exceed 6 dBi. In addition, the maximum power spectral density shall not exceed 11 dBm in any 1 megahertz band. If transmitting antennas of directional gain greater than 6 dBi are used, both the maximum conducted output power and the maximum power spectral density shall be reduced by

TEST PROCEDURE

Measurements perform using a wideband gated RF power meter provided that the gate parameters are adjusted such that the power is measured only when the EUT is transmitting at its maximum power control level. Since the measurement is made only during the ON time of the transmitter, no duty cycle correction factor is required.

DIRECTIONAL ANTENNA GAIN

There is only one transmitter output therefore the directional gain is equal to the antenna gain.

RESULTS

ID:	39472	Date:	1/31/17
------------	-------	--------------	---------

Antenna Gain and Limits

Channel	Frequency (MHz)	Directional Gain for Power (dBi)	Directional Gain for PSD (dBi)	Power Limit (dBm)	PSD Limit (dBm)
Low	5190	3.48	3.48	24.00	11.00
High	5230	3.48	3.48	24.00	11.00

Duty Cycle CF (dB)	0.10	Included in Calculations of Corr'PSD
---------------------------	------	---

Output Power Results

Channel	Frequency (MHz)	Antenna A Meas Power (dBm)	Total Corr'd Power (dBm)	Power Limit (dBm)	Power Margin (dB)
Low	5190	13.99	13.99	24.00	-10.01
High	5230	16.94	16.94	24.00	-7.06

PSD Results

Channel	Frequency (MHz)	Antenna A Meas PSD (dBm)	Total Corr'd PSD (dBm)	PSD Limit (dBm)	PSD Margin (dB)
Low	5190	3.64	3.74	11.00	-7.26
High	5230	3.66	3.76	11.00	-7.24

PSD

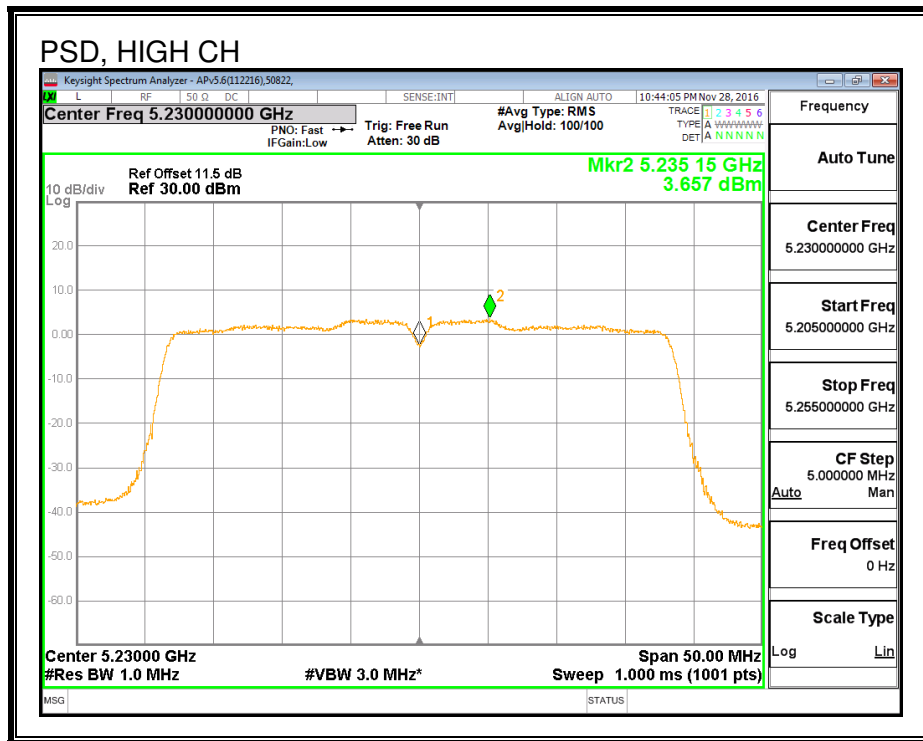
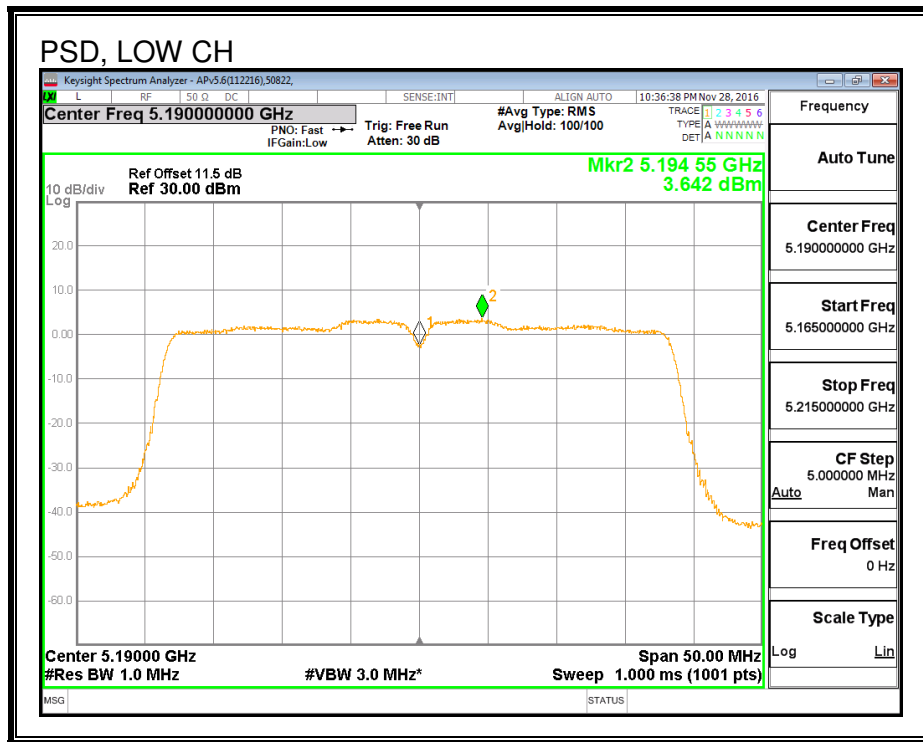

8.6. 802.11n HT40 ANTENNA B MODE IN THE 5.2 GHz BAND

8.6.1. 26 dB BANDWIDTH

LIMITS

None; for reporting purposes only.

RESULTS

Channel	Frequency (MHz)	26 dB Bandwidth (MHz)
Low	5190	40.560
High	5230	40.640

26 dB BANDWIDTH

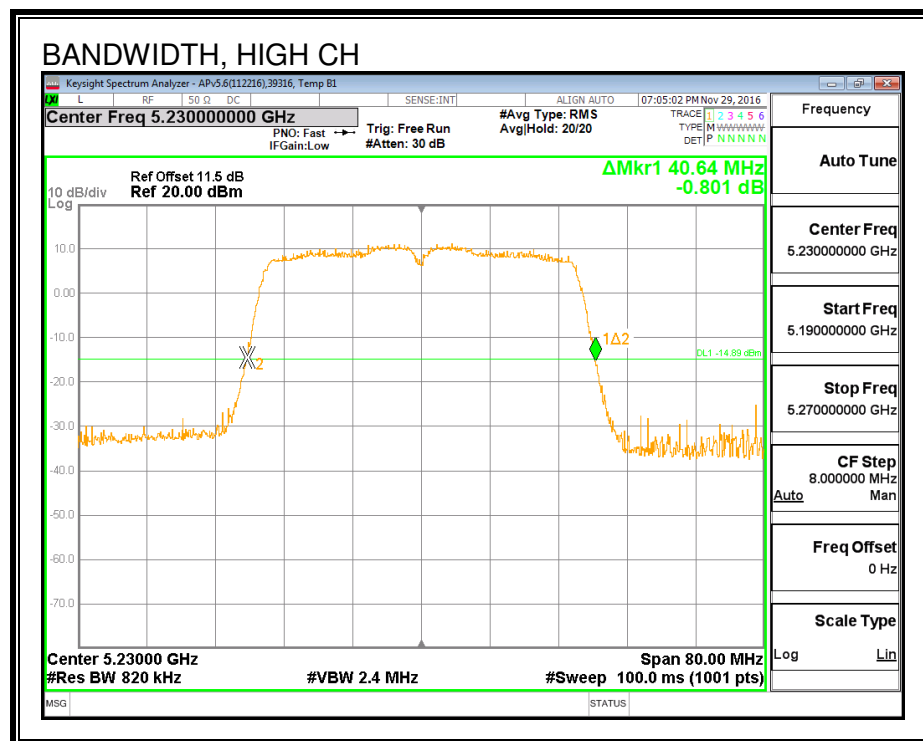
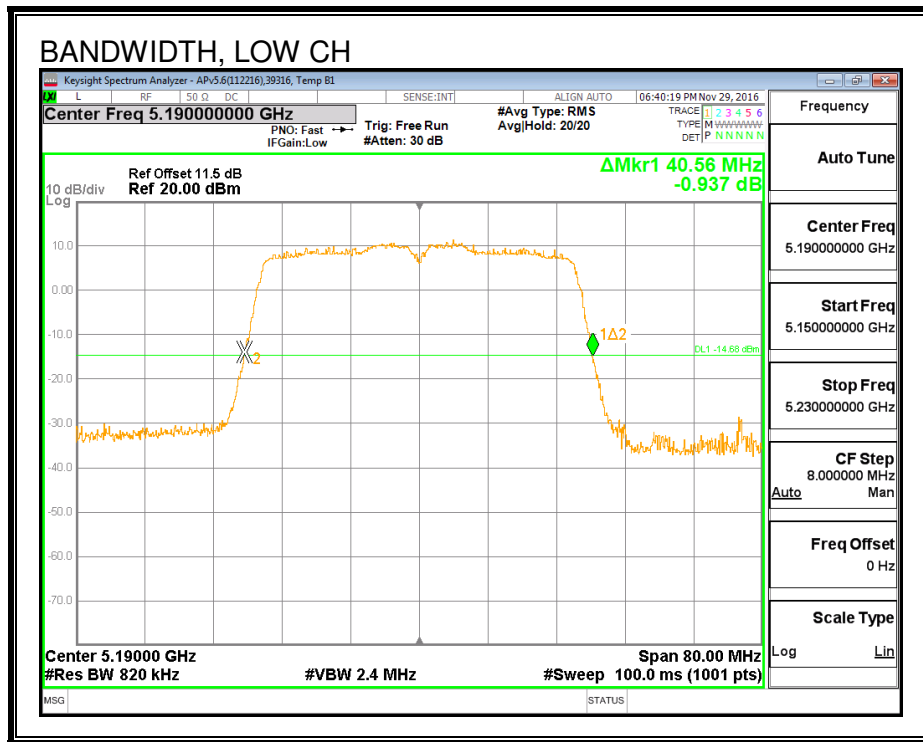

8.6.2. 99% BANDWIDTH

LIMITS

None; for reporting purposes only.

RESULTS

Channel	Frequency (MHz)	99% Bandwidth (MHz)
Low	5190	36.207
High	5230	36.176

99% BANDWIDTH

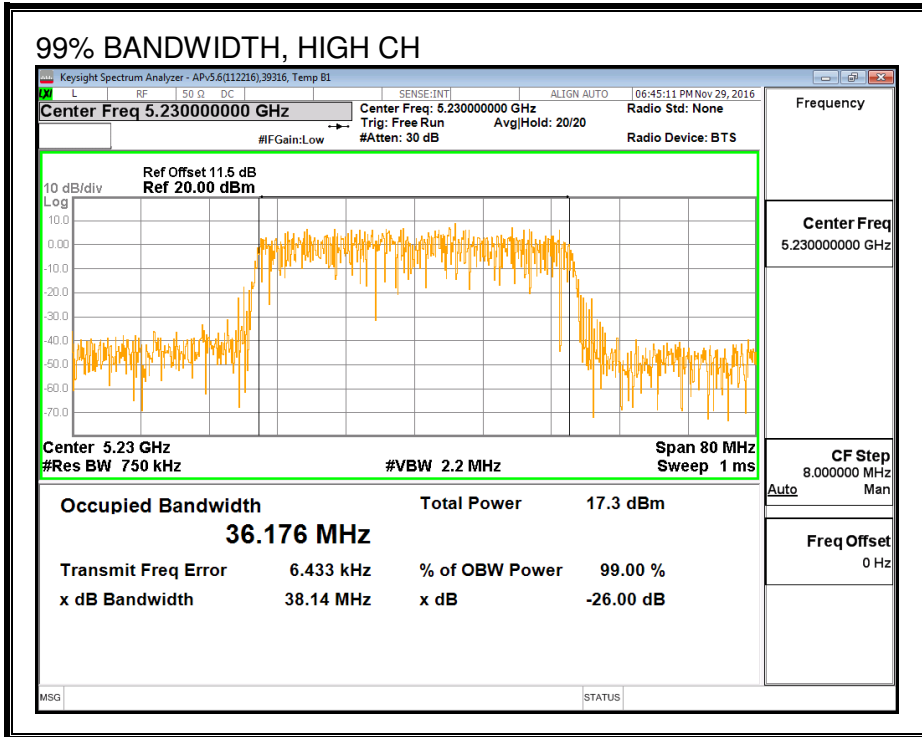
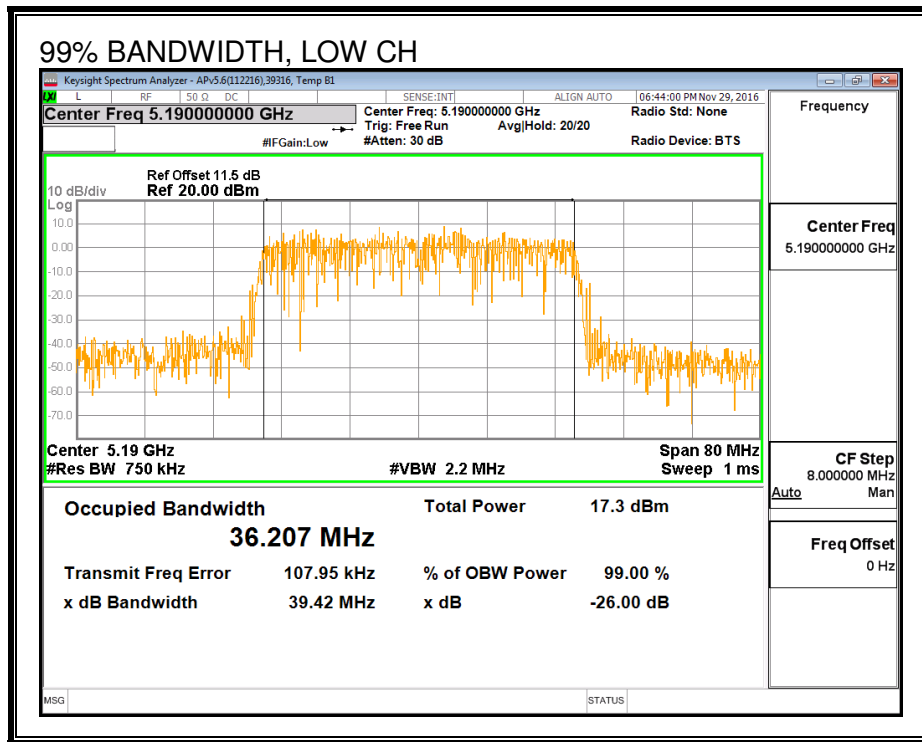

8.6.3. AVERAGE POWER

LIMITS

None; for reporting purposes only.

TEST PROCEDURE

Measurements perform using a wideband gated RF power meter.

RESULTS

ID:	39472	Date:	1/31/17
------------	-------	--------------	---------

Channel	Frequency (MHz)	Power (dBm)
Low	5190	13.94
High	5230	15.98

8.6.4. OUTPUT POWER AND PSD

LIMITS

FCC §15.407 (a) (1)

(i) For an outdoor access point operating in the band 5.15-5.25 GHz, the maximum conducted output power over the frequency band of operation shall not exceed 1 W provided the maximum antenna gain does not exceed 6 dBi. In addition, the maximum power spectral density shall not exceed 17 dBm in any 1 megahertz band. If transmitting antennas of directional gain greater than 6 dBi are used, both the maximum conducted output power and the maximum power spectral density shall be reduced by the amount in dB that the directional gain of the antenna exceeds 6 dBi. The maximum e.i.r.p. at any elevation angle above 30 degrees as measured from the horizon must not exceed 125 mW (21 dBm).

(ii) For an indoor access point operating in the band 5.15-5.25 GHz, the maximum conducted output power over the frequency band of operation shall not exceed 1 W provided the maximum antenna gain does not exceed 6 dBi. In addition, the maximum power spectral density shall not exceed 17 dBm in any 1 megahertz band. If transmitting antennas of directional gain greater than 6 dBi are used, both the maximum conducted output power and the maximum power spectral density shall be reduced by the amount in dB that the directional gain of the antenna exceeds 6 dBi.

(iii) For fixed point-to-point access points operating in the band 5.15-5.25 GHz, the maximum conducted output power over the frequency band of operation shall not exceed 1 W. Fixed point-to-point U-NII devices may employ antennas with directional gain up to 23 dBi without any corresponding reduction in the maximum conducted output power or maximum power spectral density. For fixed point-to-point transmitters that employ a directional antenna gain greater than 23 dBi, a 1 dB reduction in maximum conducted output power and maximum power spectral density is required for each 1 dB of antenna gain in excess of 23 dBi. Fixed, point-to-point operations exclude the use of point-to-multipoint systems, omnidirectional applications, and multiple collocated transmitters transmitting the same information. The operator of the U-NII device, or if the equipment is professionally installed, the installer, is responsible for ensuring that systems employing high gain directional antennas are used exclusively for fixed, point-to-point operations.

(iv) For mobile and portable client devices in the 5.15-5.25 GHz band, the maximum conducted output power over the frequency band of operation shall not exceed 250 mW provided the maximum antenna gain does not exceed 6 dBi. In addition, the maximum power spectral density shall not exceed 11 dBm in any 1 megahertz band. If transmitting antennas of directional gain greater than 6 dBi are used, both the maximum conducted output power and the maximum power spectral density shall be reduced by the amount in dB that the directional gain of the antenna exceeds 6 dBi.

TEST PROCEDURE

Measurements perform using a wideband gated RF power meter provided that the gate parameters are adjusted such that the power is measured only when the EUT is transmitting at its maximum power control level. Since the measurement is made only during the ON time of the transmitter, no duty cycle correction factor is required.

DIRECTIONAL ANTENNA GAIN

There is only one transmitter output therefore the directional gain is equal to the antenna gain.

RESULTS

ID:	39472	Date:	1/31/17
------------	-------	--------------	---------

Antenna Gain and Limits

Channel	Frequency (MHz)	Directional Gain for Power (dBi)	Directional Gain for PSD (dBi)	Power Limit (dBm)	PSD Limit (dBm)
Low	5190	3.33	3.33	24.00	11.00
High	5230	3.33	3.33	24.00	11.00

Duty Cycle CF (dB)	0.10	Included in Calculations of Corr'd PSD
---------------------------	------	---

Output Power Results

Channel	Frequency (MHz)	Antenna B Meas Power (dBm)	Total Corr'd Power (dBm)	Power Limit (dBm)	Power Margin (dB)
Low	5190	13.94	13.94	24.00	-10.06
High	5230	15.98	15.98	24.00	-8.02

PSD Results

Channel	Frequency (MHz)	Antenna B Meas PSD (dBm)	Total Corr'd PSD (dBm)	PSD Limit (dBm)	PSD Margin (dB)
Low	5190	3.42	3.52	11.00	-7.48
High	5230	3.32	3.42	11.00	-7.59

PSD

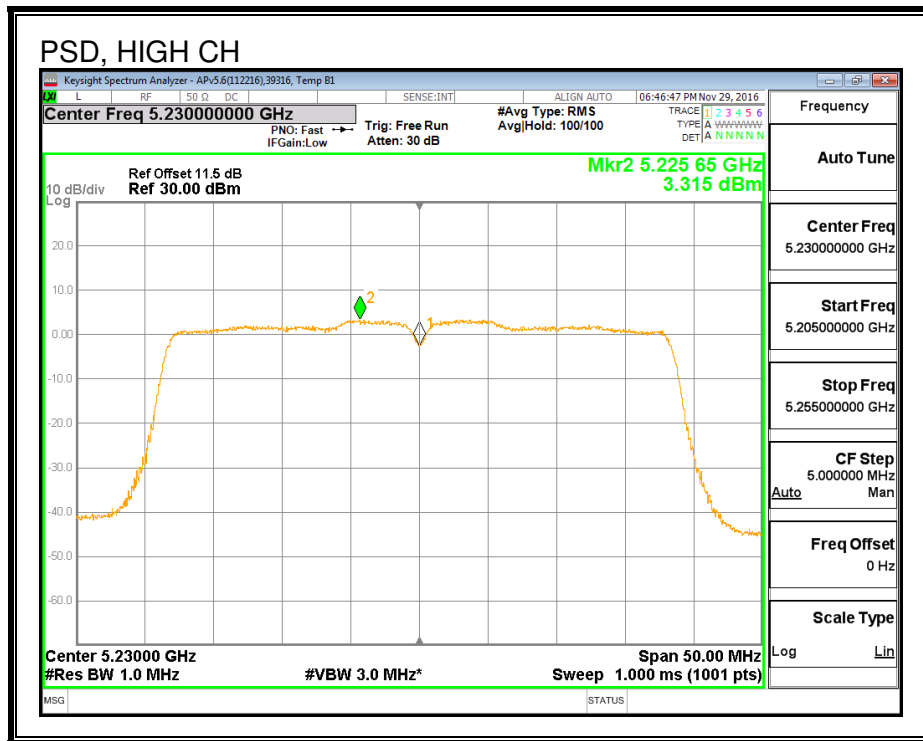
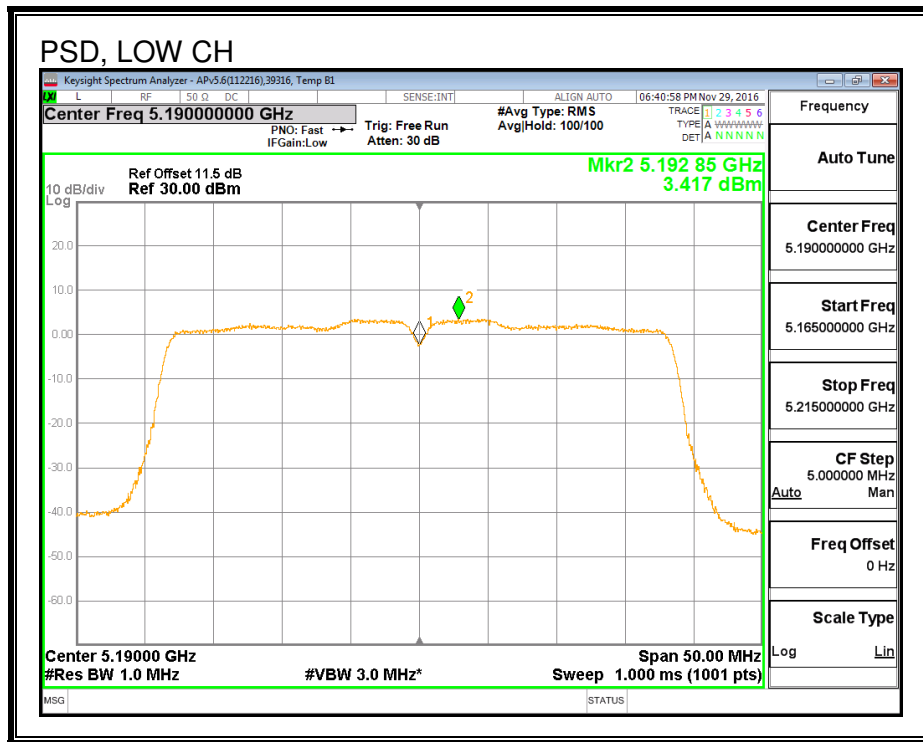

**8.7. 802.11n HT40 2Tx (ANTENNA A + ANTENNA B) CDD MODE IN THE
5.2 GHz BAND**

8.7.1. 26 dB BANDWIDTH

LIMITS

None; for reporting purposes only.

RESULTS

Channel	Frequency (MHz)	26 dB BW Ant A (MHz)	26 dB BW Ant B (MHz)
Low	5190	40.480	40.080
High	5230	40.640	40.400

26 DB BANDWIDTH, Antenna A

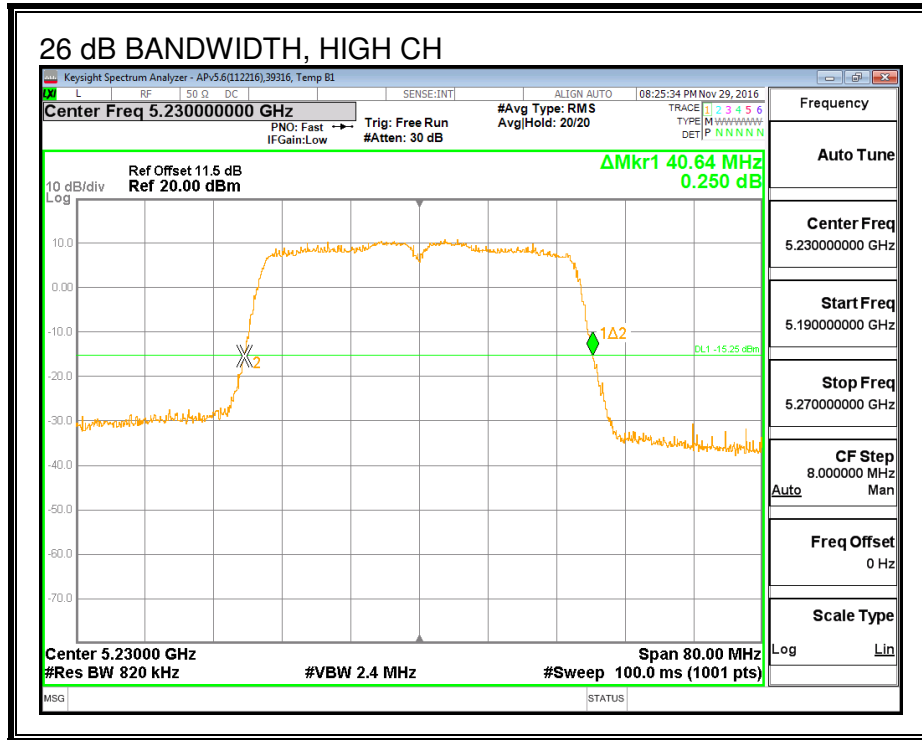
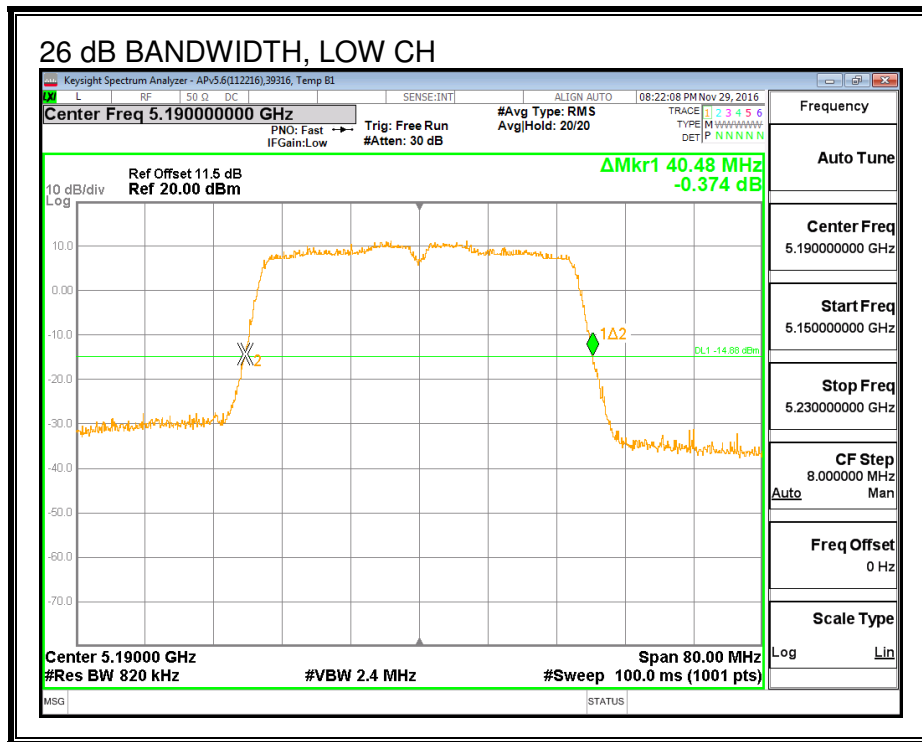

26 DB BANDWIDTH, Antenna B

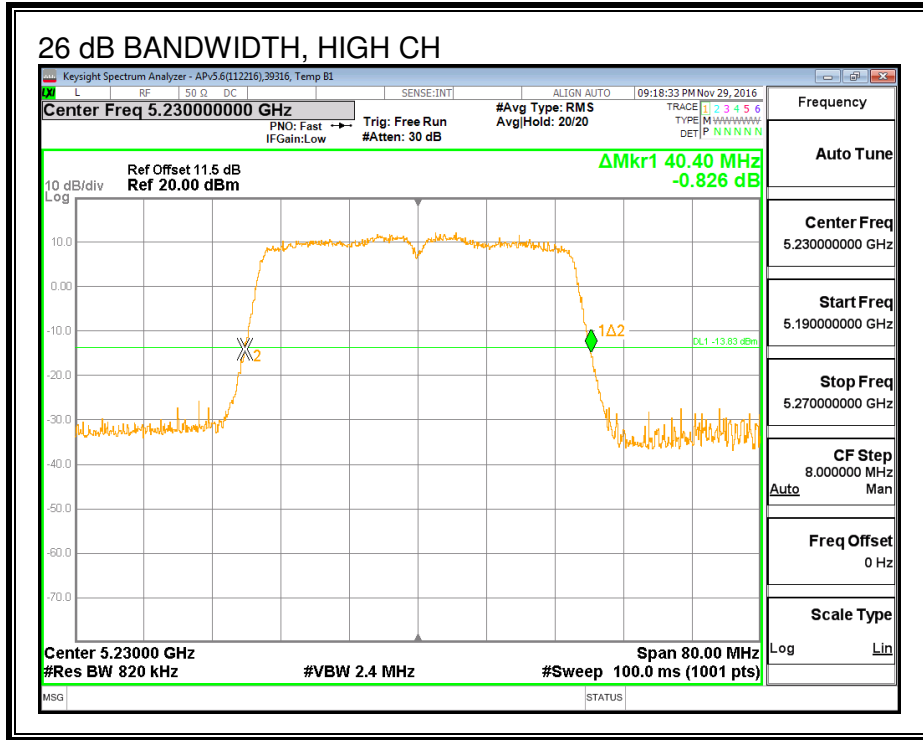
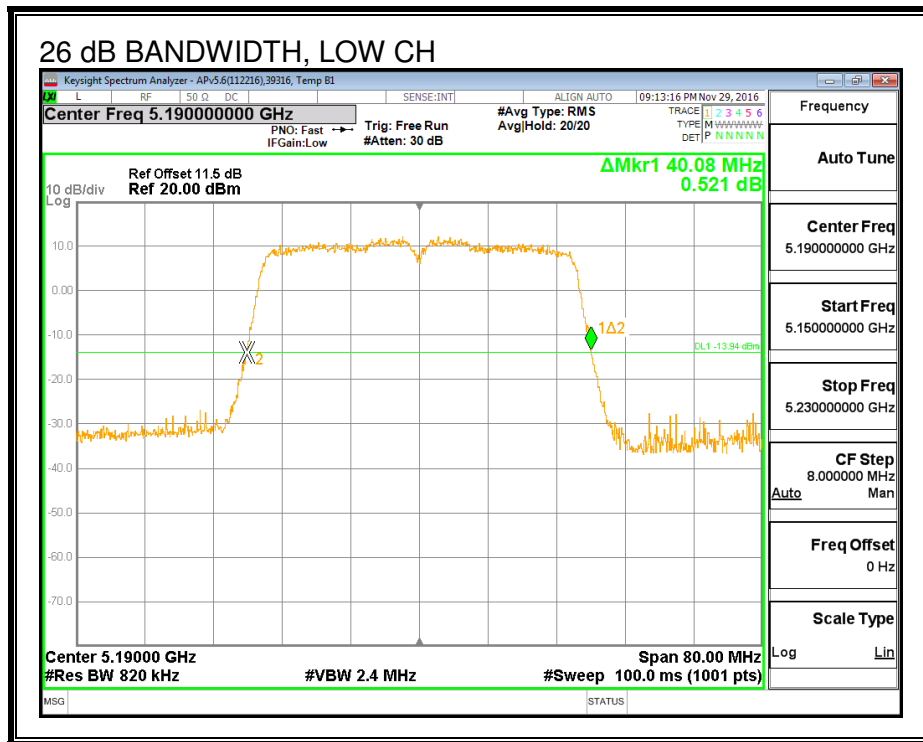

8.7.2. 99% BANDWIDTH

LIMITS

None; for reporting purposes only.

RESULTS

Channel	Frequency (MHz)	99% BW Ant A (MHz)	99% BW Ant B (MHz)
Low	5190	36.162	36.336
High	5230	36.261	36.331

99% BANDWIDTH, Antenna A

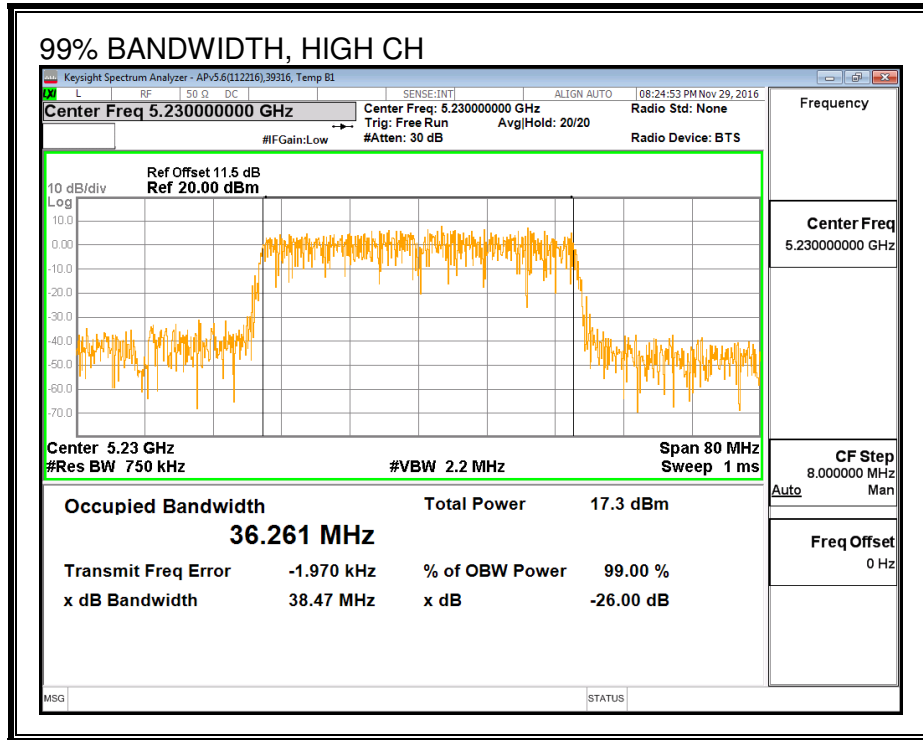
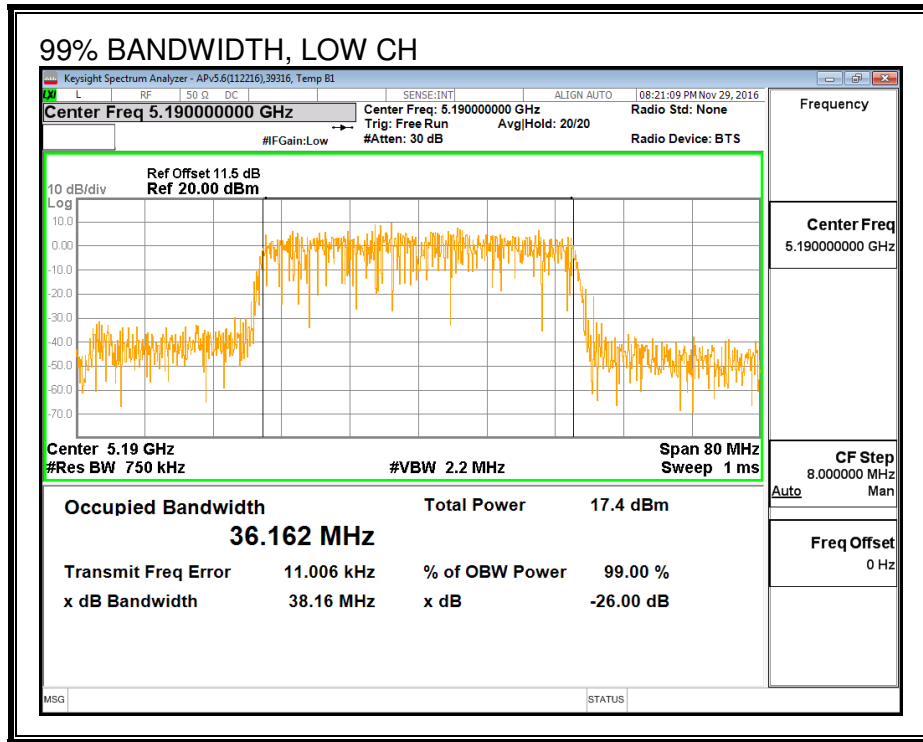

99% BANDWIDTH, Antenna B

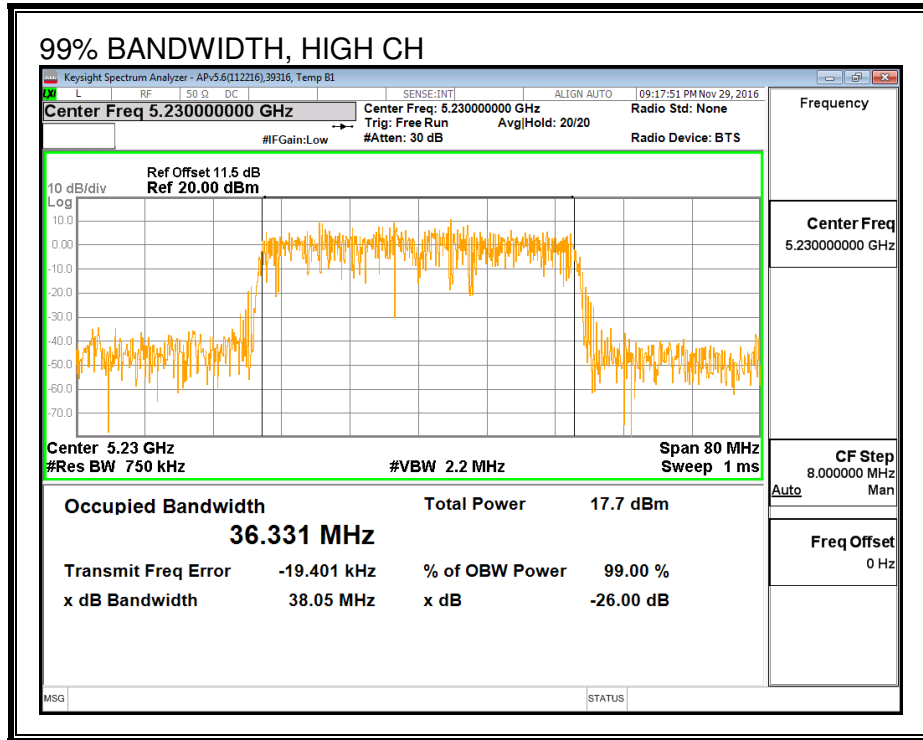
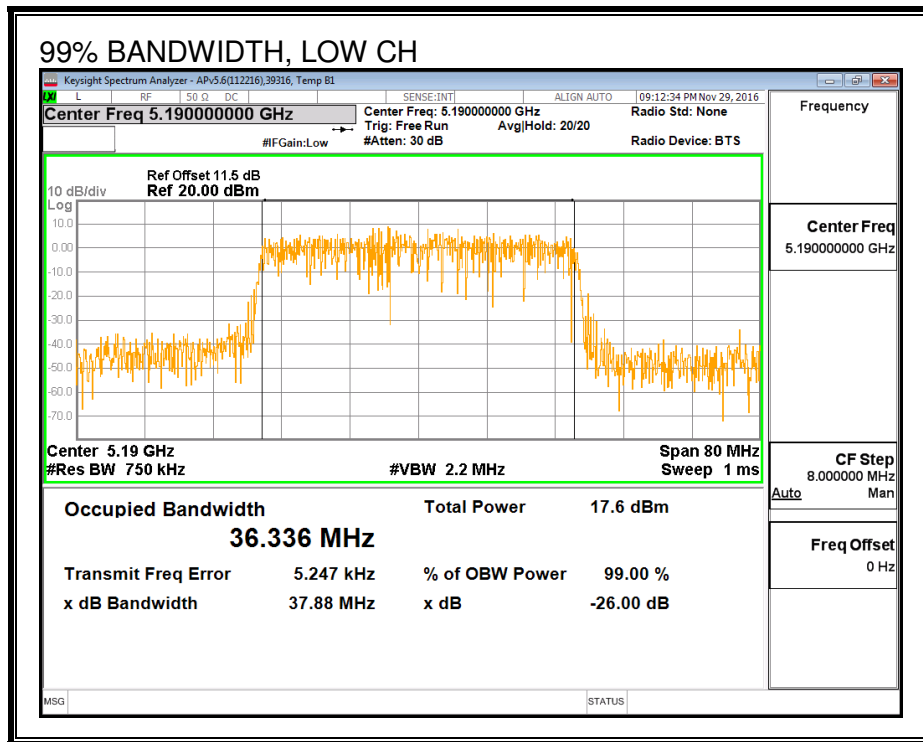

8.7.3. AVERAGE POWER

LIMITS

None; for reporting purposes only.

TEST PROCEDURE

Measurements perform using a wideband gated RF power meter.

RESULTS

ID:	39472	Date:	1/31/17
------------	-------	--------------	---------

Average Power Results

Channel	Frequency (MHz)	Antenna A Power (dBm)	Antenna B Power (dBm)	Total Power (dBm)
Low	5190	12.82	13.00	15.92
High	5230	16.95	15.99	19.51

8.7.4. OUTPUT POWER AND PSD

LIMITS

FCC §15.407 (a) (1)

(i) For an outdoor access point operating in the band 5.15-5.25 GHz, the maximum conducted output power over the frequency band of operation shall not exceed 1 W provided the maximum antenna gain does not exceed 6 dBi. In addition, the maximum power spectral density shall not exceed 17 dBm in any 1 megahertz band. If transmitting antennas of directional gain greater than 6 dBi are used, both the maximum conducted output power and the maximum power spectral density shall be reduced by the amount in dB that the directional gain of the antenna exceeds 6 dBi. The maximum e.i.r.p. at any elevation angle above 30 degrees as measured from the horizon must not exceed 125 mW (21 dBm).

(ii) For an indoor access point operating in the band 5.15-5.25 GHz, the maximum conducted output power over the frequency band of operation shall not exceed 1 W provided the maximum antenna gain does not exceed 6 dBi. In addition, the maximum power spectral density shall not exceed 17 dBm in any 1 megahertz band. If transmitting antennas of directional gain greater than 6 dBi are used, both the maximum conducted output power and the maximum power spectral density shall be reduced by the amount in dB that the directional gain of the antenna exceeds 6 dBi.

(iii) For fixed point-to-point access points operating in the band 5.15-5.25 GHz, the maximum conducted output power over the frequency band of operation shall not exceed 1 W. Fixed point-to-point U-NII devices may employ antennas with directional gain up to 23 dBi without any corresponding reduction in the maximum conducted output power or maximum power spectral density. For fixed point-to-point transmitters that employ a directional antenna gain greater than 23 dBi, a 1 dB reduction in maximum conducted output power and maximum power spectral density is required for each 1 dB of antenna gain in excess of 23 dBi. Fixed, point-to-point operations exclude the use of point-to-multipoint systems, omnidirectional applications, and multiple collocated transmitters transmitting the same information. The operator of the U-NII device, or if the equipment is professionally installed, the installer, is responsible for ensuring that systems employing high gain directional antennas are used exclusively for fixed, point-to-point operations.

(iv) For mobile and portable client devices in the 5.15-5.25 GHz band, the maximum conducted output power over the frequency band of operation shall not exceed 250 mW provided the maximum antenna gain does not exceed 6 dBi. In addition, the maximum power spectral density shall not exceed 11 dBm in any 1 megahertz band. If transmitting antennas of directional gain greater than 6 dBi are used, both the maximum conducted output power and the maximum power spectral density shall be reduced by the amount in dB that the directional gain of the antenna exceeds 6 dBi.

TEST PROCEDURE

Measurements perform using a wideband gated RF power meter provided that the gate parameters are adjusted such that the power is measured only when the EUT is transmitting at its maximum power control level. Since the measurement is made only during the ON time of the transmitter, no duty cycle correction factor is required.

DIRECTIONAL ANTENNA GAIN

The TX chains are uncorrelated and the antenna gain is unequal among the chains. The directional gain is:

Antenna A	Antenna B	Uncorrelated Chains
Gain (dBi)	Gain (dBi)	Directional Gain (dBi)
3.48	3.33	3.41

The TX chains are correlated and the antenna gain is unequal among the chains. The directional gain is:

Antenna A	Antenna B	Correlated Chains
Gain (dBi)	Gain (dBi)	Directional Gain (dBi)
3.48	3.33	6.42

RESULTS

ID:	39472	Date:	1/31/17
------------	-------	--------------	---------

Antenna Gain and Limits

Channel	Frequency (MHz)	Directional Gain for Power (dBi)	Directional Gain for PSD (dBi)	Power Limit (dBm)	PSD Limit (dBm)
Low	5190	3.41	6.42	24.00	10.58
High	5230	3.41	6.42	24.00	10.58

Duty Cycle CF (dB)	0.10	Included in Calculations of Corr'd PSD
---------------------------	------	---

Output Power Results

Channel	Frequency (MHz)	Antenna A Meas Power (dBm)	Antenna B Meas Power (dBm)	Total Corr'd Power (dBm)	Power Limit (dBm)	Power Margin (dB)
Low	5190	12.82	13.00	15.92	24.00	-8.08
High	5230	16.95	15.99	19.51	24.00	-4.49

PSD Results

Channel	Frequency (MHz)	Antenna A Meas PSD (dBm)	Antenna B Meas PSD (dBm)	Total Corr'd PSD (dBm)	PSD Limit (dBm)	PSD Margin (dB)
Low	5190	3.77	3.77	6.88	10.58	-3.70
High	5230	3.71	3.99	6.96	10.58	-3.62

PSD, Antenna A

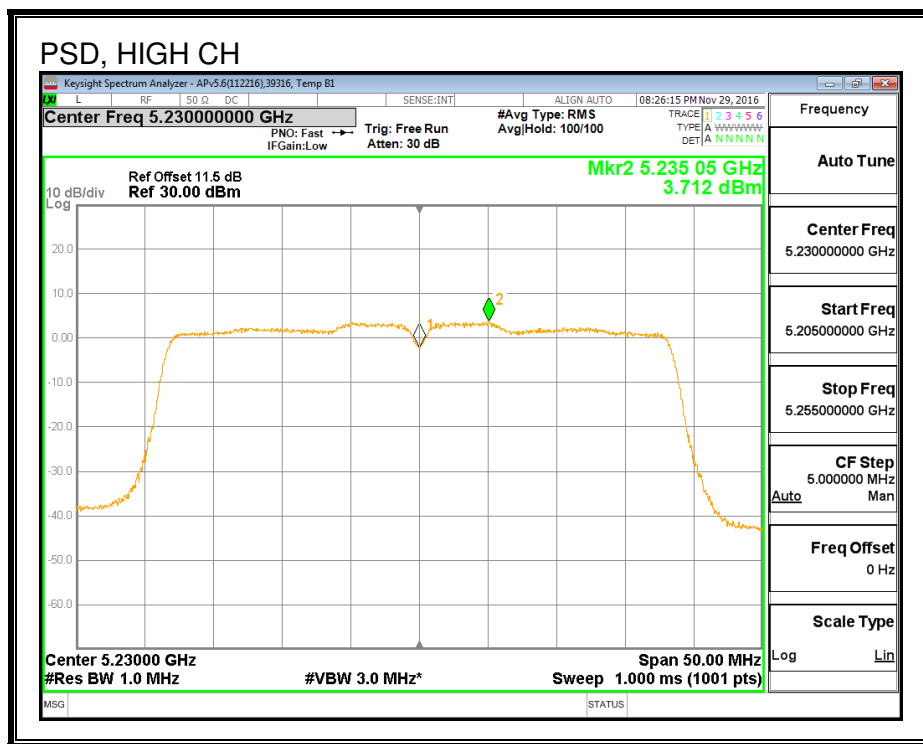
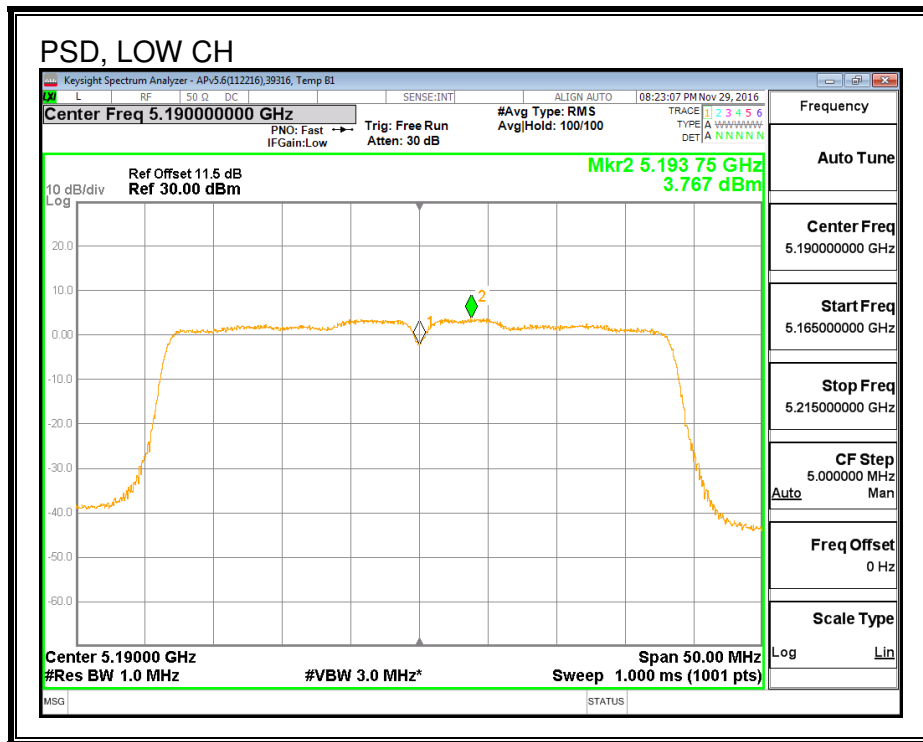

PSD, Antenna B

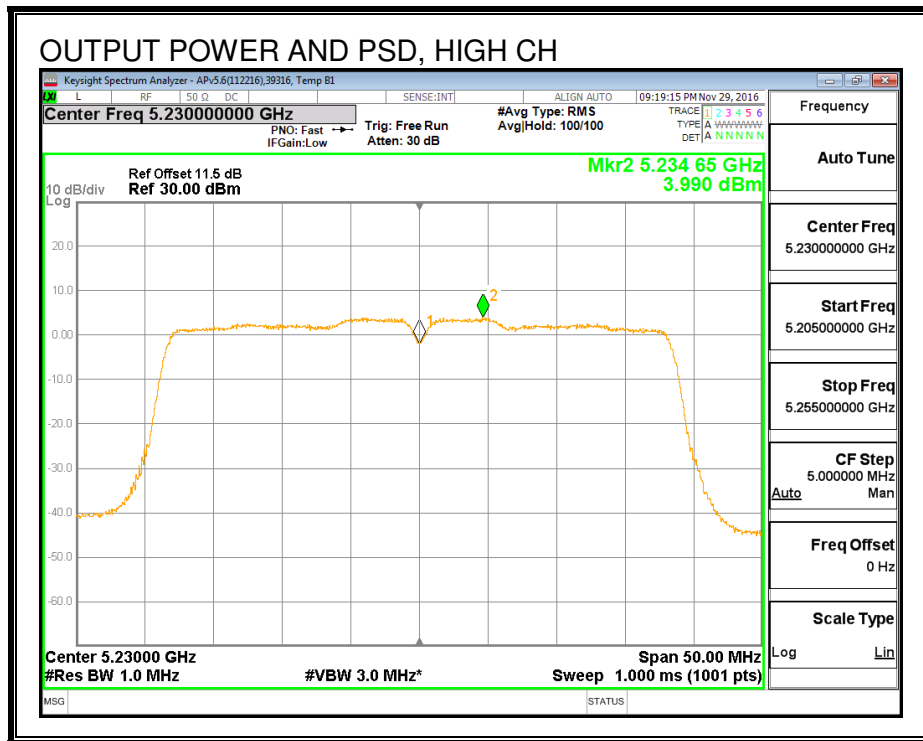
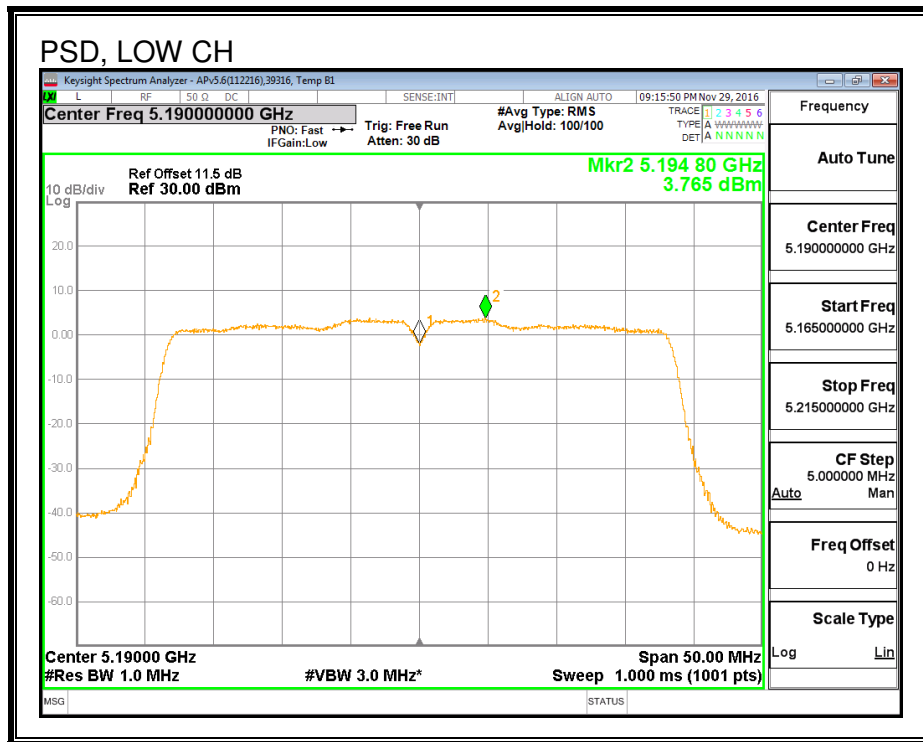

**8.8. 802.11n HT40 2Tx (ANTENNA A + ANTENNA B) STBC MODE IN THE
5.2 GHz BAND**

Noted: Covered by 802.11n HT40 2Tx (ANTENNA A + ANTENNA B) CDD MODE IN THE 5.2 GHz BAND

8.9. 802.11ac VHT80 ANTENNA A MODE IN THE 5.2 GHz BAND

8.9.1. 26 dB BANDWIDTH

LIMITS

None; for reporting purposes only.

RESULTS

Channel	Frequency (MHz)	26 dB Bandwidth (MHz)
Mid	5210	83.360

26 dB BANDWIDTH

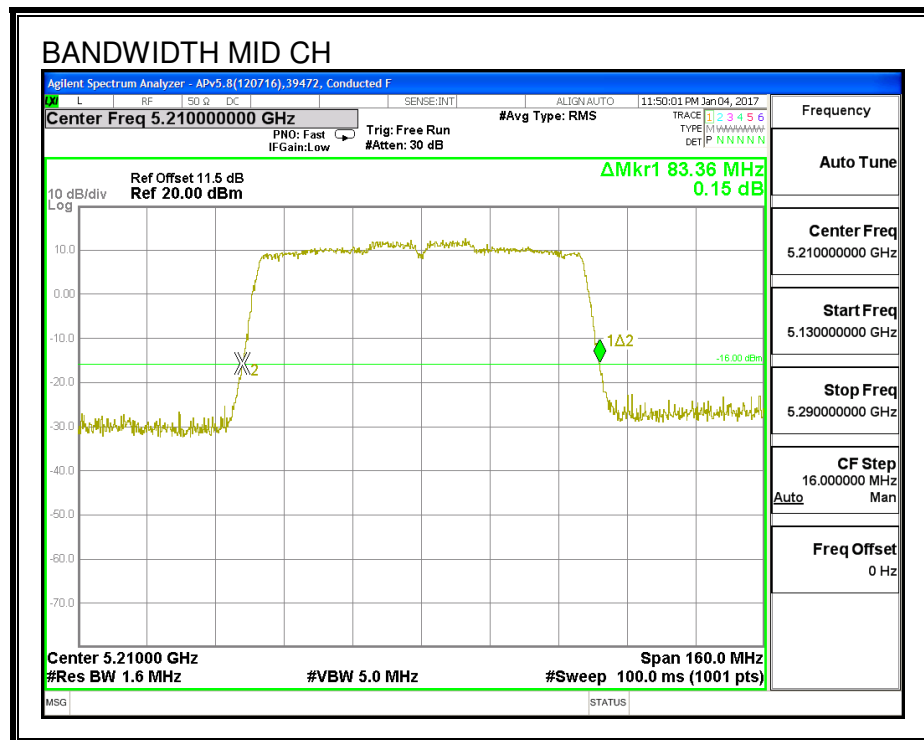

8.9.2. 99% BANDWIDTH

LIMITS

None; for reporting purposes only.

RESULTS

Channel	Frequency (MHz)	99% Bandwidth (MHz)
Mid	5210	75.902

99% BANDWIDTH

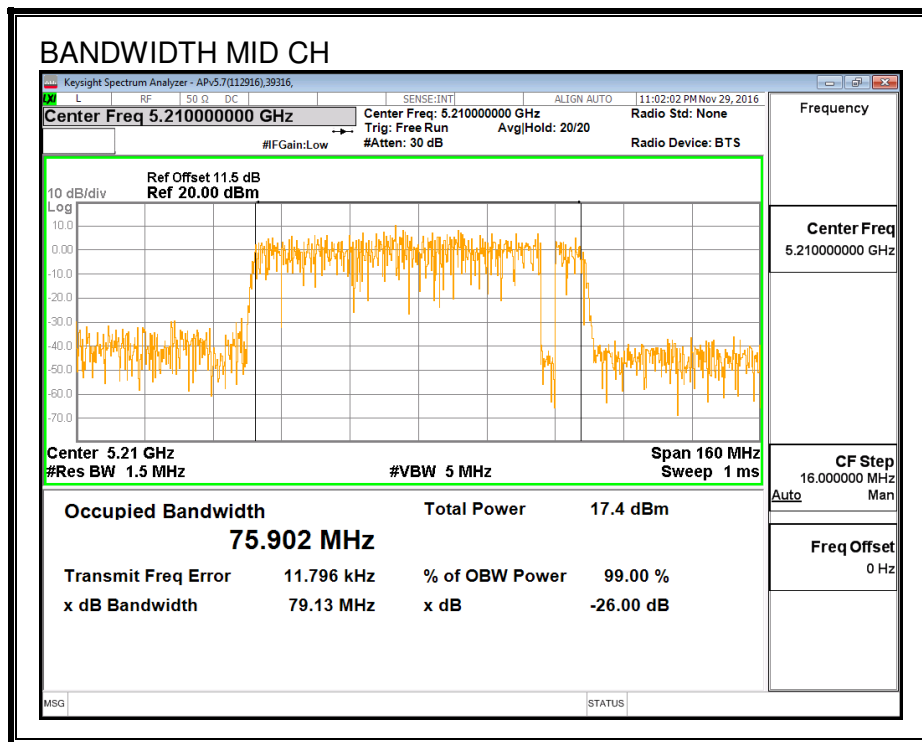

8.9.3. AVERAGE POWER

LIMITS

None; for reporting purposes only.

TEST PROCEDURE

Measurements perform using a wideband gated RF power meter.

RESULTS

ID:	39472	Date:	1/31/17
------------	-------	--------------	---------

Channel	Frequency (MHz)	Power (dBm)
Mid	5210	13.36

8.9.4. OUTPUT POWER AND PSD

LIMITS

FCC §15.407 (a) (1)

(i) For an outdoor access point operating in the band 5.15-5.25 GHz, the maximum conducted output power over the frequency band of operation shall not exceed 1 W provided the maximum antenna gain does not exceed 6 dBi. In addition, the maximum power spectral density shall not exceed 17 dBm in any 1 megahertz band. If transmitting antennas of directional gain greater than 6 dBi are used, both the maximum conducted output power and the maximum power spectral density shall be reduced by the amount in dB that the directional gain of the antenna exceeds 6 dBi. The maximum e.i.r.p. at any elevation angle above 30 degrees as measured from the horizon must not exceed 125 mW (21 dBm).

(ii) For an indoor access point operating in the band 5.15-5.25 GHz, the maximum conducted output power over the frequency band of operation shall not exceed 1 W provided the maximum antenna gain does not exceed 6 dBi. In addition, the maximum power spectral density shall not exceed 17 dBm in any 1 megahertz band. If transmitting antennas of directional gain greater than 6 dBi are used, both the maximum conducted output power and the maximum power spectral density shall be reduced by the amount in dB that the directional gain of the antenna exceeds 6 dBi.

(iii) For fixed point-to-point access points operating in the band 5.15-5.25 GHz, the maximum conducted output power over the frequency band of operation shall not exceed 1 W. Fixed point-to-point U-NII devices may employ antennas with directional gain up to 23 dBi without any corresponding reduction in the maximum conducted output power or maximum power spectral density. For fixed point-to-point transmitters that employ a directional antenna gain greater than 23 dBi, a 1 dB reduction in maximum conducted output power and maximum power spectral density is required for each 1 dB of antenna gain in excess of 23 dBi. Fixed, point-to-point operations exclude the use of point-to-multipoint systems, omnidirectional applications, and multiple collocated transmitters transmitting the same information. The operator of the U-NII device, or if the equipment is professionally installed, the installer, is responsible for ensuring that systems employing high gain directional antennas are used exclusively for fixed, point-to-point operations.

(iv) For mobile and portable client devices in the 5.15-5.25 GHz band, the maximum conducted output power over the frequency band of operation shall not exceed 250 mW provided the maximum antenna gain does not exceed 6 dBi. In addition, the maximum power spectral density shall not exceed 11 dBm in any 1 megahertz band. If transmitting antennas of directional gain greater than 6 dBi are used, both the maximum conducted output power and the maximum power spectral density shall be reduced by the amount in dB that the directional gain of the antenna exceeds 6 dBi.

TEST PROCEDURE

Measurements perform using a wideband gated RF power meter provided that the gate parameters are adjusted such that the power is measured only when the EUT is transmitting at its maximum power control level. Since the measurement is made only during the ON time of the transmitter, no duty cycle correction factor is required.

DIRECTIONAL ANTENNA GAIN

There is only one transmitter output therefore the directional gain is equal to the antenna gain.

RESULTS

ID:	39472	Date:	1/31/17
------------	-------	--------------	---------

Antenna Gain and Limits

Channel	Frequency (MHz)	Directional Gain for Power (dBi)	Directional Gain for PSD (dBi)	Power Limit (dBm)	PSD Limit (dBm)
Mid	5210	3.48	3.48	24.00	11.00

Duty Cycle CF (dB)	0.19	Included in Calculations of Corr'd PSD
---------------------------	------	---

Output Power Results

Channel	Frequency (MHz)	Antenna A Meas Power (dBm)	Total Corr'd Power (dBm)	Power Limit (dBm)	Power Margin (dB)
Mid	5210	13.36	13.36	24.00	-10.64

PSD Results

Channel	Frequency (MHz)	Antenna A Meas PSD (dBm)	Total Corr'd PSD (dBm)	PSD Limit (dBm)	PSD Margin (dB)
Mid	5210	0.66	0.85	11.00	-10.15

PSD

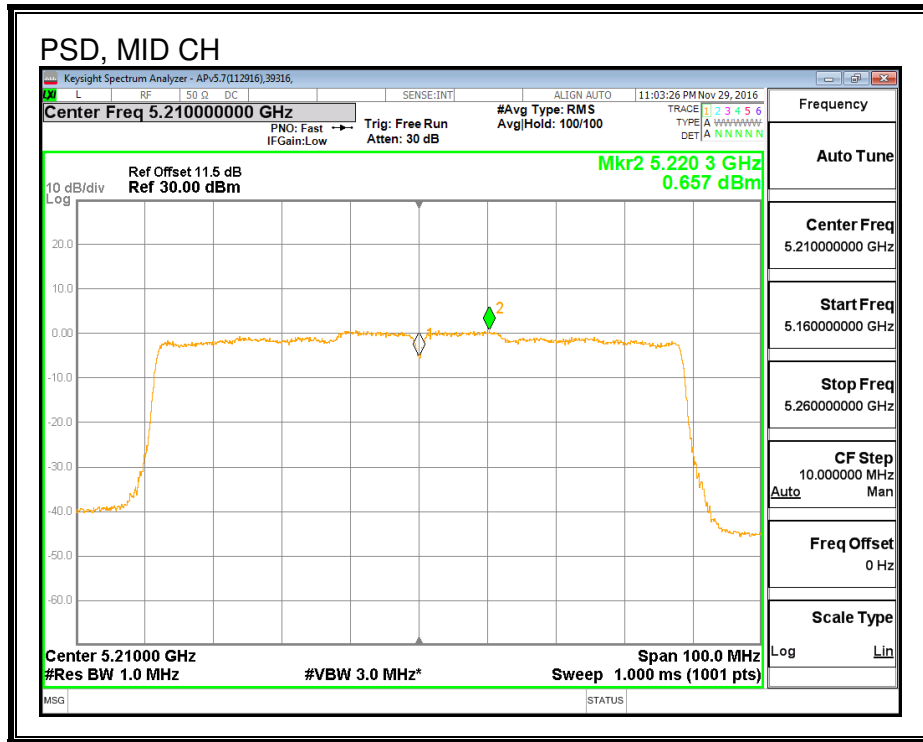

8.10. 802.11ac VHT80 ANTENNA B MODE IN THE 5.2 GHz BAND

8.10.1. 26 dB BANDWIDTH

LIMITS

None; for reporting purposes only.

RESULTS

Channel	Frequency (MHz)	26 dB Bandwidth (MHz)
Mid	5210	82.720

26 dB BANDWIDTH

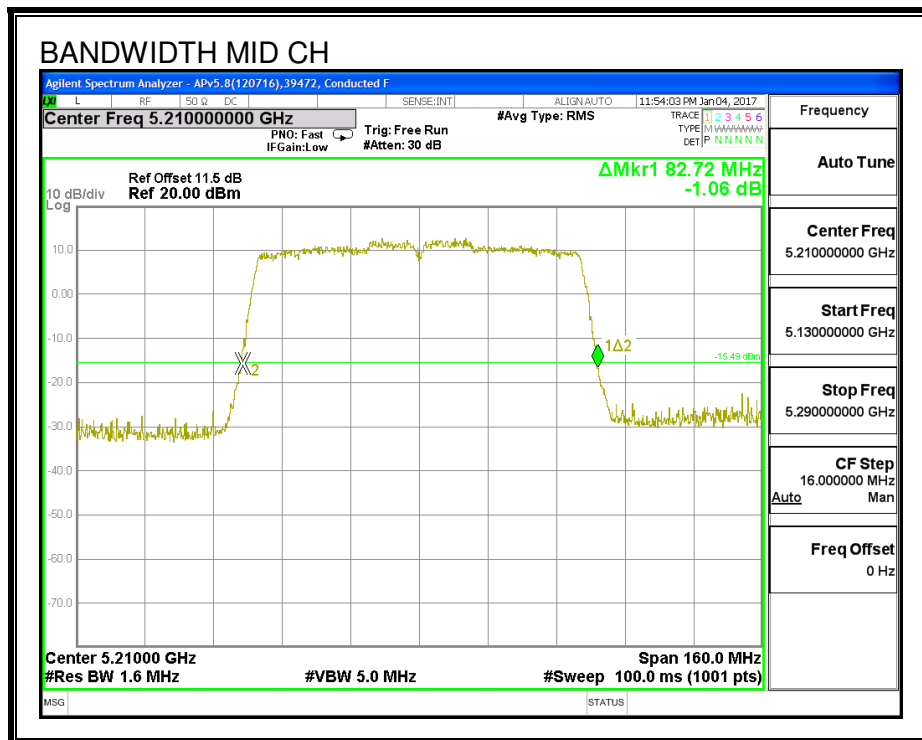

8.10.2. 99% BANDWIDTH

LIMITS

None; for reporting purposes only.

RESULTS

Channel	Frequency (MHz)	99% Bandwidth (MHz)
Mid	5210	75.628

99% BANDWIDTH

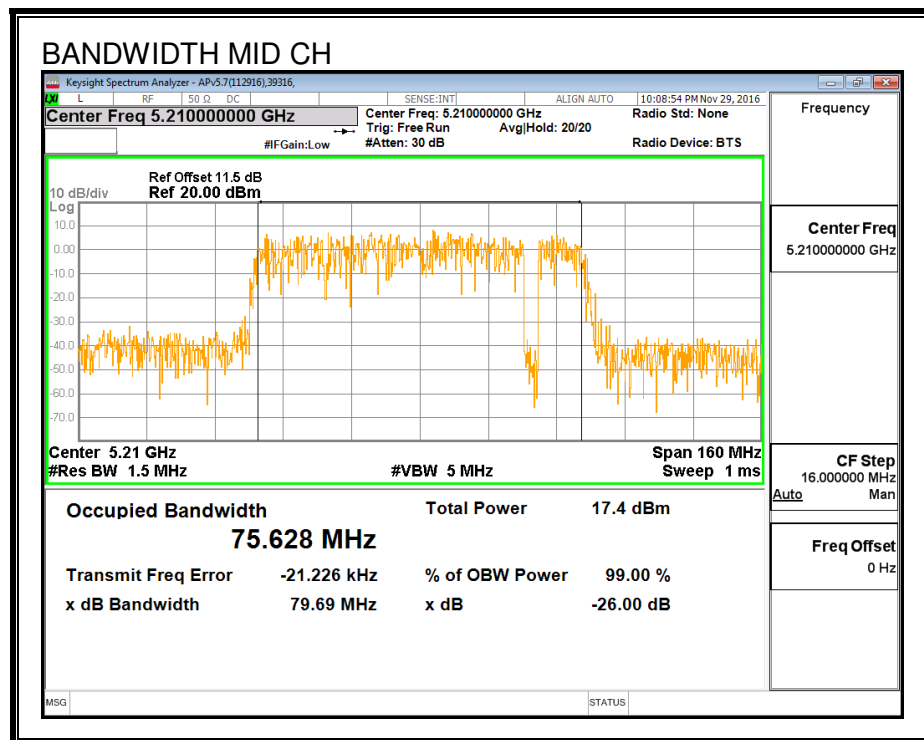

8.10.3. AVERAGE POWER

LIMITS

None; for reporting purposes only.

TEST PROCEDURE

Measurements perform using a wideband gated RF power meter.

RESULTS

ID:	39472	Date:	1/31/17
------------	-------	--------------	---------

Channel	Frequency (MHz)	Power (dBm)
Mid	5210	13.48

8.10.4. OUTPUT POWER AND PSD

LIMITS

FCC §15.407 (a) (1)

(i) For an outdoor access point operating in the band 5.15-5.25 GHz, the maximum conducted output power over the frequency band of operation shall not exceed 1 W provided the maximum antenna gain does not exceed 6 dBi. In addition, the maximum power spectral density shall not exceed 17 dBm in any 1 megahertz band. If transmitting antennas of directional gain greater than 6 dBi are used, both the maximum conducted output power and the maximum power spectral density shall be reduced by the amount in dB that the directional gain of the antenna exceeds 6 dBi. The maximum e.i.r.p. at any elevation angle above 30 degrees as measured from the horizon must not exceed 125 mW (21 dBm).

(ii) For an indoor access point operating in the band 5.15-5.25 GHz, the maximum conducted output power over the frequency band of operation shall not exceed 1 W provided the maximum antenna gain does not exceed 6 dBi. In addition, the maximum power spectral density shall not exceed 17 dBm in any 1 megahertz band. If transmitting antennas of directional gain greater than 6 dBi are used, both the maximum conducted output power and the maximum power spectral density shall be reduced by the amount in dB that the directional gain of the antenna exceeds 6 dBi.

(iii) For fixed point-to-point access points operating in the band 5.15-5.25 GHz, the maximum conducted output power over the frequency band of operation shall not exceed 1 W. Fixed point-to-point U-NII devices may employ antennas with directional gain up to 23 dBi without any corresponding reduction in the maximum conducted output power or maximum power spectral density. For fixed point-to-point transmitters that employ a directional antenna gain greater than 23 dBi, a 1 dB reduction in maximum conducted output power and maximum power spectral density is required for each 1 dB of antenna gain in excess of 23 dBi. Fixed, point-to-point operations exclude the use of point-to-multipoint systems, omnidirectional applications, and multiple collocated transmitters transmitting the same information. The operator of the U-NII device, or if the equipment is professionally installed, the installer, is responsible for ensuring that systems employing high gain directional antennas are used exclusively for fixed, point-to-point operations.

(iv) For mobile and portable client devices in the 5.15-5.25 GHz band, the maximum conducted output power over the frequency band of operation shall not exceed 250 mW provided the maximum antenna gain does not exceed 6 dBi. In addition, the maximum power spectral density shall not exceed 11 dBm in any 1 megahertz band. If transmitting antennas of directional gain greater than 6 dBi are used, both the maximum conducted output power and the maximum power spectral density shall be reduced by the amount in dB that the directional gain of the antenna exceeds 6 dBi.

TEST PROCEDURE

Measurements perform using a wideband gated RF power meter provided that the gate parameters are adjusted such that the power is measured only when the EUT is transmitting at its maximum power control level. Since the measurement is made only during the ON time of the transmitter, no duty cycle correction factor is required.

DIRECTIONAL ANTENNA GAIN

There is only one transmitter output therefore the directional gain is equal to the antenna gain.

RESULTS

ID:	39472	Date:	1/31/17
------------	-------	--------------	---------

Antenna Gain and Limits

Channel	Frequency (MHz)	Directional Gain for Power (dBi)	Directional Gain for PSD (dBi)	Power Limit (dBm)	PSD Limit (dBm)
Mid	5210	3.33	3.33	24.00	11.00

Duty Cycle CF (dB)	0.19	Included in Calculations of Corr'd PSD
---------------------------	------	---

Output Power Results

Channel	Frequency (MHz)	Antenna B Meas Power (dBm)	Total Corr'd Power (dBm)	Power Limit (dBm)	Power Margin (dB)
Mid	5210	13.48	13.48	24.00	-10.52

PSD Results

Channel	Frequency (MHz)	Antenna B Meas PSD (dBm)	Total Corr'd PSD (dBm)	PSD Limit (dBm)	PSD Margin (dB)
Mid	5210	1.03	1.22	11.00	-9.78

PSD

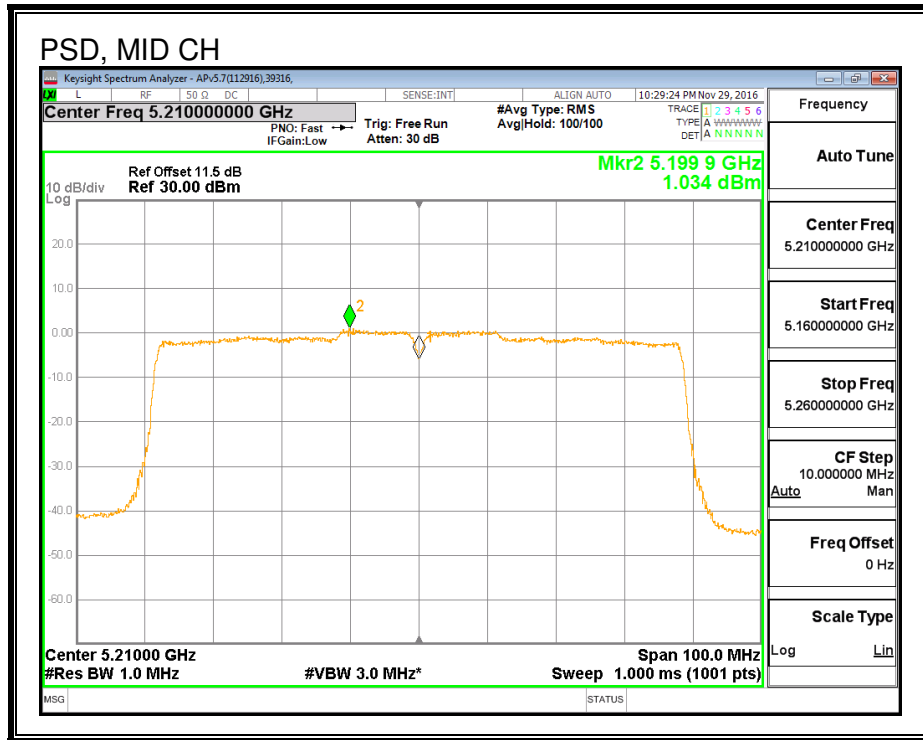

8.11. 802.11ac VHT80 2Tx (ANTENNA A + ANTENNA B) CDD MODE IN THE 5.2 GHz BAND

8.11.1. 26 dB BANDWIDTH

LIMITS

None; for reporting purposes only.

RESULTS

Channel	Frequency (MHz)	26 dB BW Ant A (MHz)	26 dB BW Ant B (MHz)
Mid	5210	82.720	82.720

26 dB BANDWIDTH, Antenna A

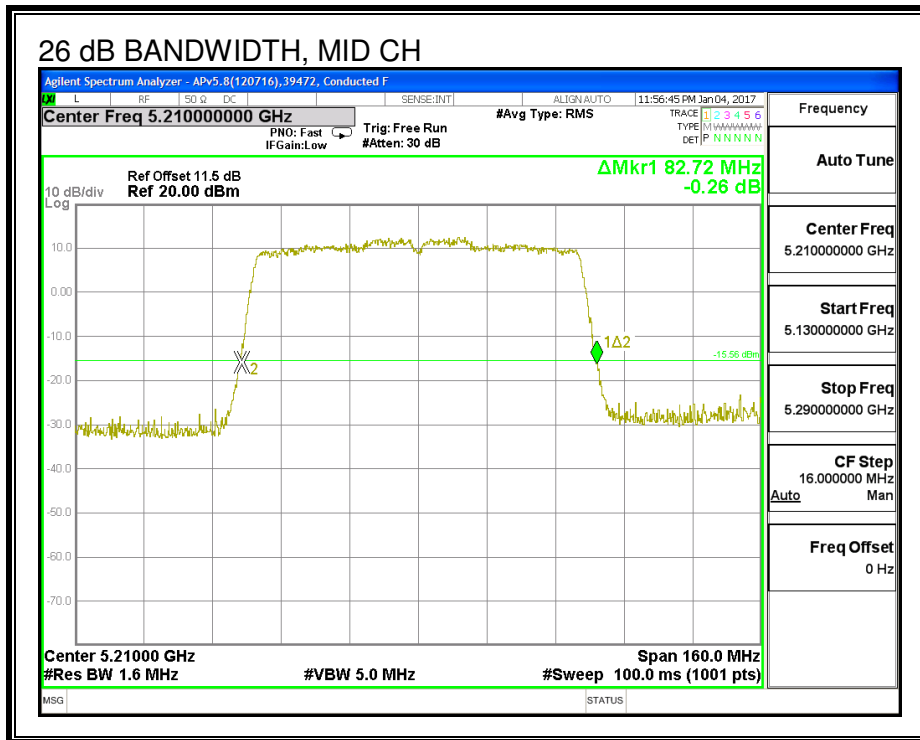

26 DB BANDWIDTH, Antenna B

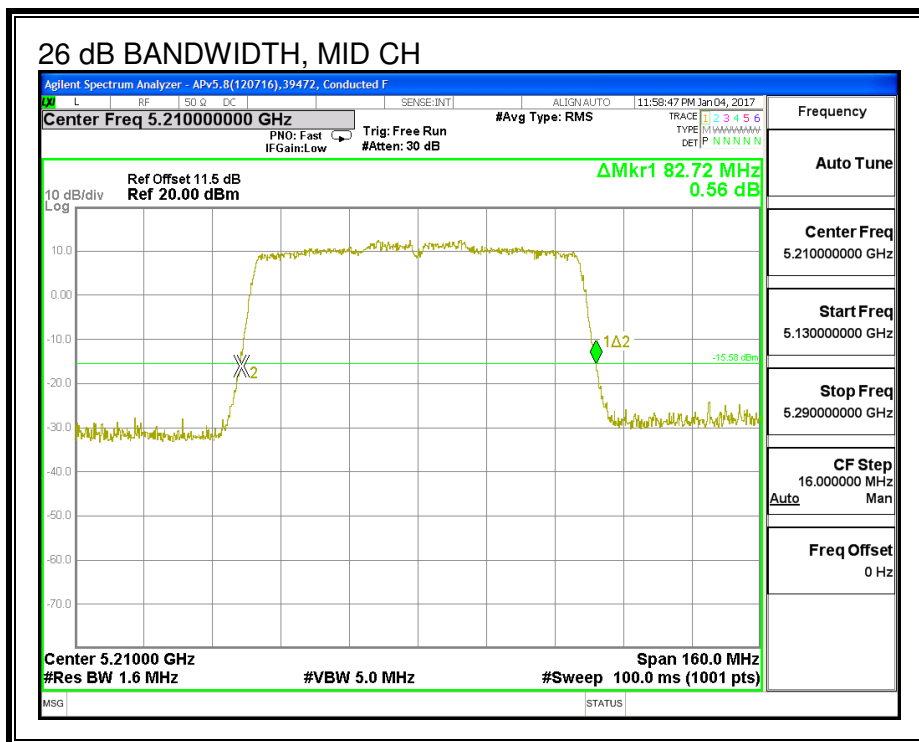

8.11.2. 99% BANDWIDTH

LIMITS

None; for reporting purposes only.

RESULTS

Channel	Frequency (MHz)	99% BW Ant A (MHz)	99% BW Ant B (MHz)
Mid	5210	75.347	75.919

99% BANDWIDTH, Antenna A

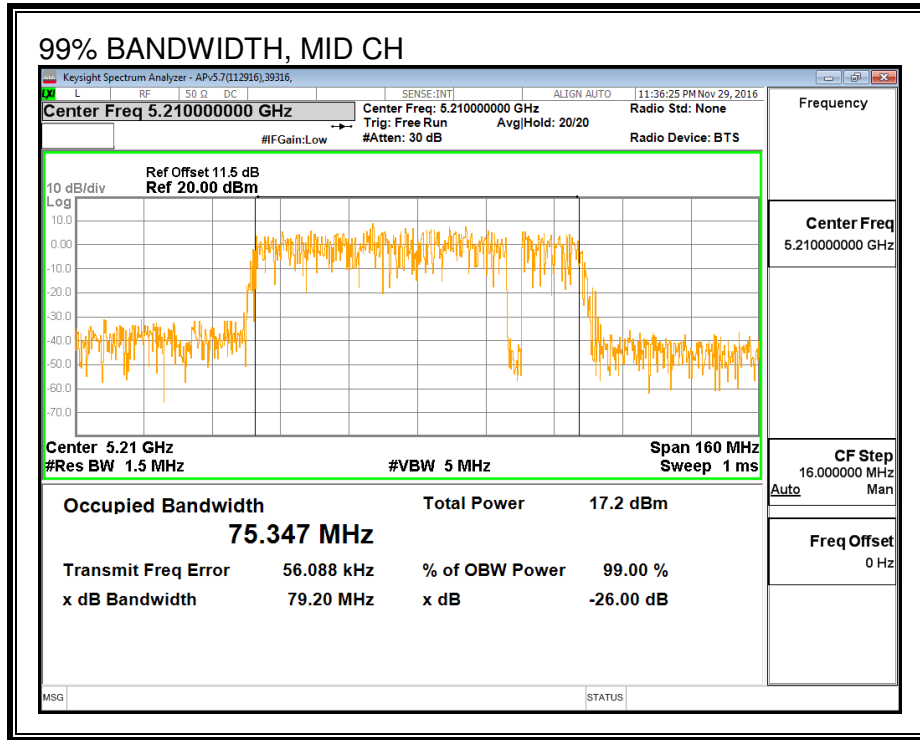

99% BANDWIDTH, Antenna B

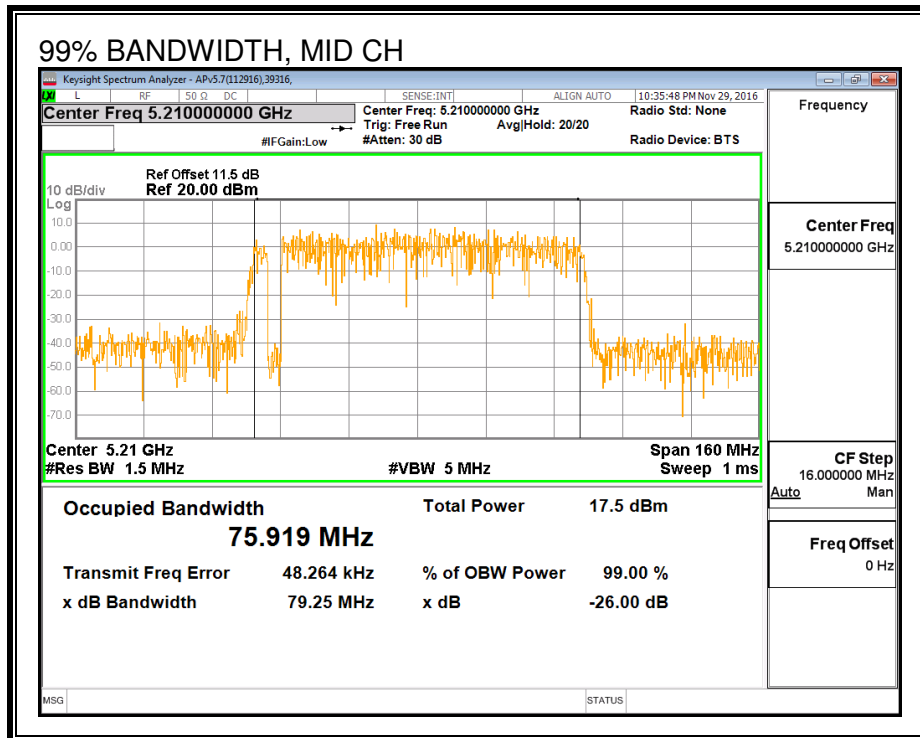

8.11.3. AVERAGE POWER

LIMITS

None; for reporting purposes only.

TEST PROCEDURE

Measurements perform using a wideband gated RF power meter.

RESULTS

ID:	39472	Date:	1/31/17
------------	-------	--------------	---------

Average Power Results

Channel	Frequency (MHz)	Ant A Power (dBm)	Ant B Power (dBm)	Total Power (dBm)
Mid	5210	11.81	11.94	14.89

8.11.4. OUTPUT POWER AND PSD

LIMITS

FCC §15.407 (a) (1)

(i) For an outdoor access point operating in the band 5.15-5.25 GHz, the maximum conducted output power over the frequency band of operation shall not exceed 1 W provided the maximum antenna gain does not exceed 6 dBi. In addition, the maximum power spectral density shall not exceed 17 dBm in any 1 megahertz band. If transmitting antennas of directional gain greater than 6 dBi are used, both the maximum conducted output power and the maximum power spectral density shall be reduced by the amount in dB that the directional gain of the antenna exceeds 6 dBi. The maximum e.i.r.p. at any elevation angle above 30 degrees as measured from the horizon must not exceed 125 mW (21 dBm).

(ii) For an indoor access point operating in the band 5.15-5.25 GHz, the maximum conducted output power over the frequency band of operation shall not exceed 1 W provided the maximum antenna gain does not exceed 6 dBi. In addition, the maximum power spectral density shall not exceed 17 dBm in any 1 megahertz band. If transmitting antennas of directional gain greater than 6 dBi are used, both the maximum conducted output power and the maximum power spectral density shall be reduced by the amount in dB that the directional gain of the antenna exceeds 6 dBi.

(iii) For fixed point-to-point access points operating in the band 5.15-5.25 GHz, the maximum conducted output power over the frequency band of operation shall not exceed 1 W. Fixed point-to-point U-NII devices may employ antennas with directional gain up to 23 dBi without any corresponding reduction in the maximum conducted output power or maximum power spectral density. For fixed point-to-point transmitters that employ a directional antenna gain greater than 23 dBi, a 1 dB reduction in maximum conducted output power and maximum power spectral density is required for each 1 dB of antenna gain in excess of 23 dBi. Fixed, point-to-point operations exclude the use of point-to-multipoint systems, omnidirectional applications, and multiple collocated transmitters transmitting the same information. The operator of the U-NII device, or if the equipment is professionally installed, the installer, is responsible for ensuring that systems employing high gain directional antennas are used exclusively for fixed, point-to-point operations.

(iv) For mobile and portable client devices in the 5.15-5.25 GHz band, the maximum conducted output power over the frequency band of operation shall not exceed 250 mW provided the maximum antenna gain does not exceed 6 dBi. In addition, the maximum power spectral density shall not exceed 11 dBm in any 1 megahertz band. If transmitting antennas of directional gain greater than 6 dBi are used, both the maximum conducted output power and the maximum power spectral density shall be reduced by the amount in dB that the directional gain of the antenna exceeds 6 dBi.

TEST PROCEDURE

Measurements perform using a wideband gated RF power meter provided that the gate parameters are adjusted such that the power is measured only when the EUT is transmitting at its maximum power control level. Since the measurement is made only during the ON time of the transmitter, no duty cycle correction factor is required.

DIRECTIONAL ANTENNA GAIN

The TX chains are uncorrelated and the antenna gain is unequal among the chains. The directional gain is:

Antenna A	Antenna B	Uncorrelated Chains
Gain (dBi)	Gain (dBi)	Directional Gain (dBi)
3.48	3.33	3.41

The TX chains are correlated and the antenna gain is unequal among the chains. The directional gain is:

Antenna A	Antenna B	Correlated Chains
Gain (dBi)	Gain (dBi)	Directional Gain (dBi)
3.48	3.33	6.42

RESULTS

ID:	39472	Date:	1/31/17
------------	-------	--------------	---------

Antenna Gain and Limits

Channel	Frequency (MHz)	Directional Gain for Power (dBi)	Directional Gain for PSD (dBi)	Power Limit (dBm)	PSD Limit (dBm)
Mid	5210	3.41	6.42	24.00	10.58

Duty Cycle CF (dB)	0.20	Included in Calculations of Corr'd PSD
---------------------------	------	---

Output Power Results

Channel	Frequency (MHz)	Antenna A Meas Power (dBm)	Antenna B Meas Power (dBm)	Total Corr'd Power (dBm)	Power Limit (dBm)	Power Margin (dB)
Mid	5210	11.81	11.94	14.89	24.00	-9.11

PSD Results

Channel	Frequency (MHz)	Antenna A Meas PSD (dBm)	Antenna B Meas PSD (dBm)	Total Corr'd PSD (dBm)	PSD Limit (dBm)	PSD Margin (dB)
Mid	5210	0.83	0.96	4.10	10.58	-6.48

PSD, Antenna A

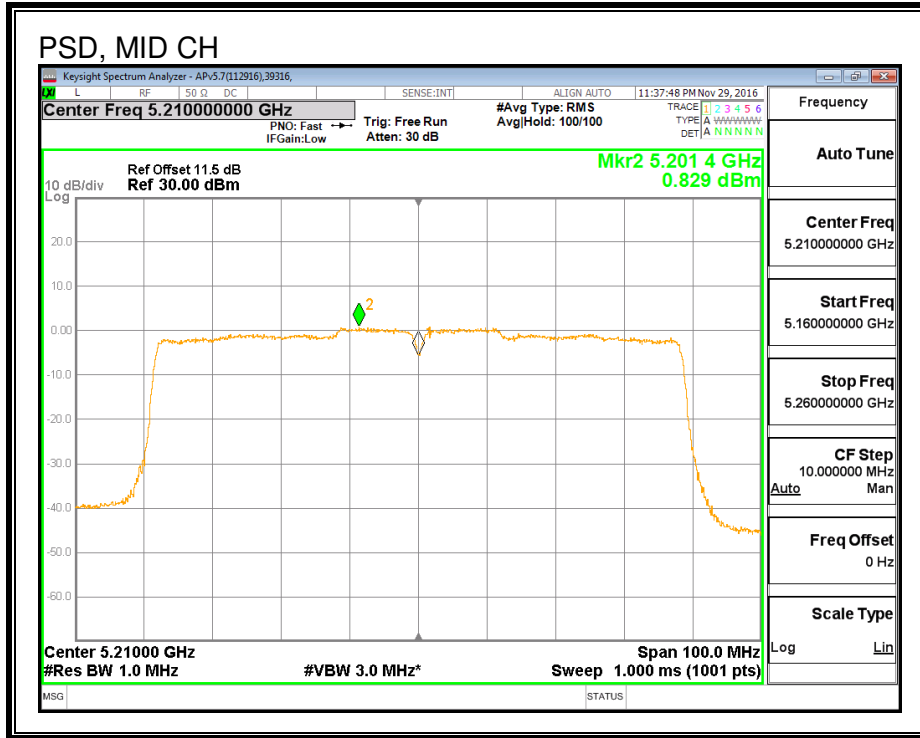

PSD, Antenna B

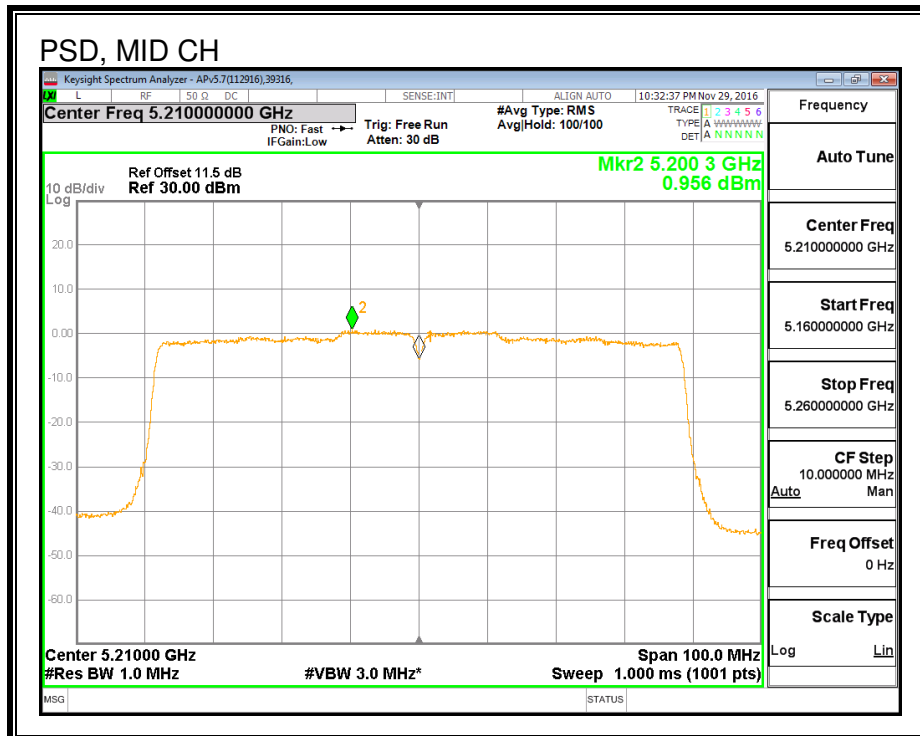

**8.12. 802.11ac VHT80 2Tx (ANTENNA A + ANTENNA B) STBC MODE IN
THE 5.2 GHz BAND**

Noted: Covered by 802.11n HT40 2Tx (ANTENNA A + ANTENNA B) CDD MODE IN THE 5.2 GHz BAND

8.13. 802.11n HT20 ANTENNA A MODE IN THE 5.3 GHz BAND

8.13.1. 26 dB BANDWIDTH

LIMITS

None; for reporting purposes only.

RESULTS

Channel	Frequency (MHz)	26 dB Bandwidth (MHz)
Low	5260	22.040
Mid	5300	21.760
High	5320	22.000

26 dB BANDWIDTH

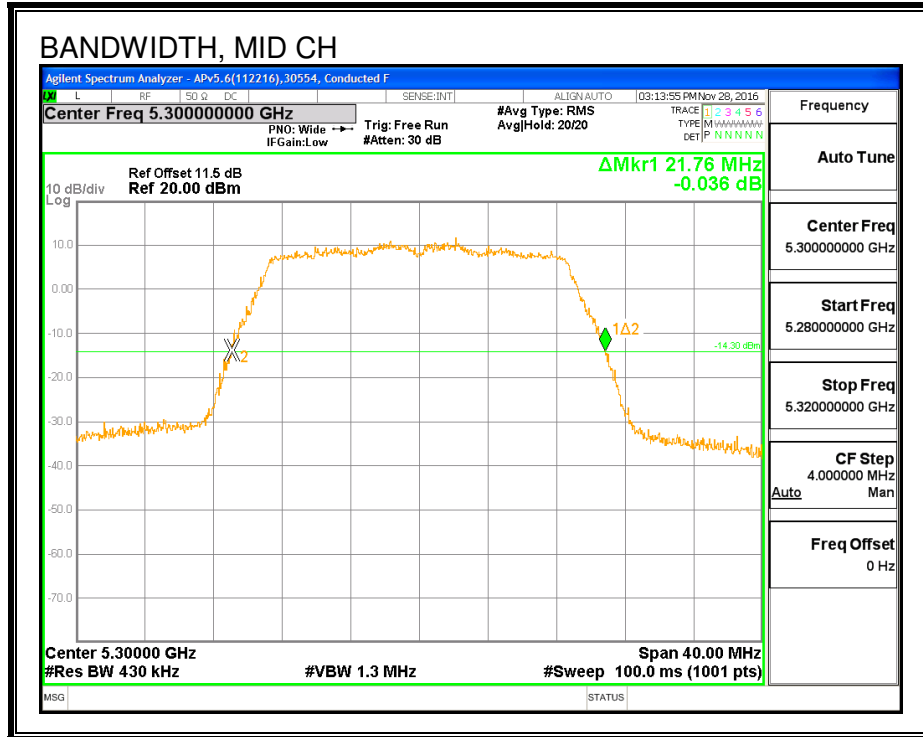
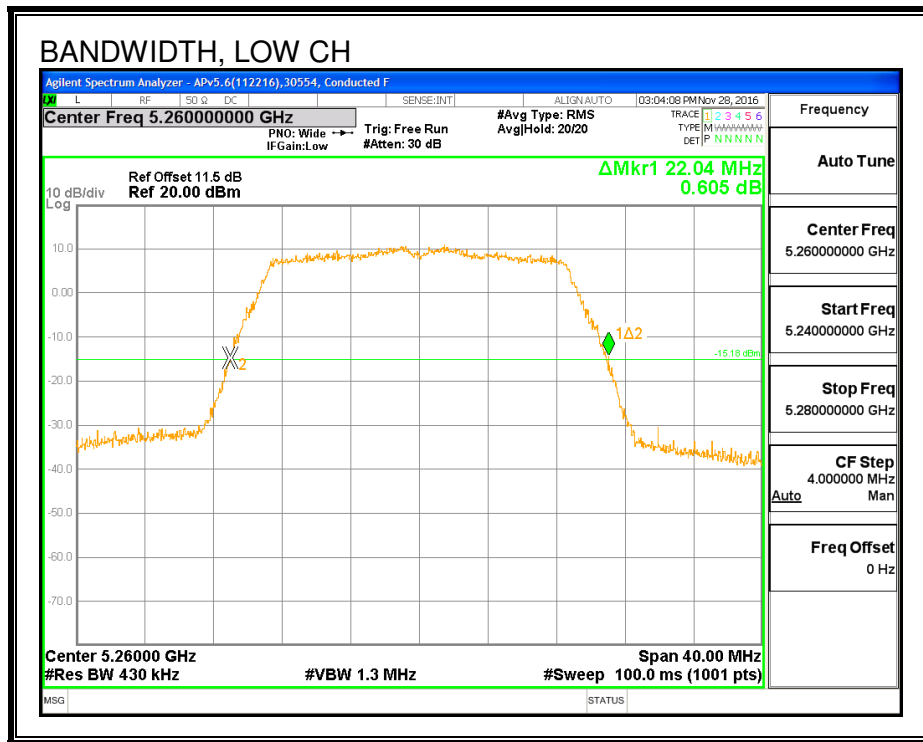

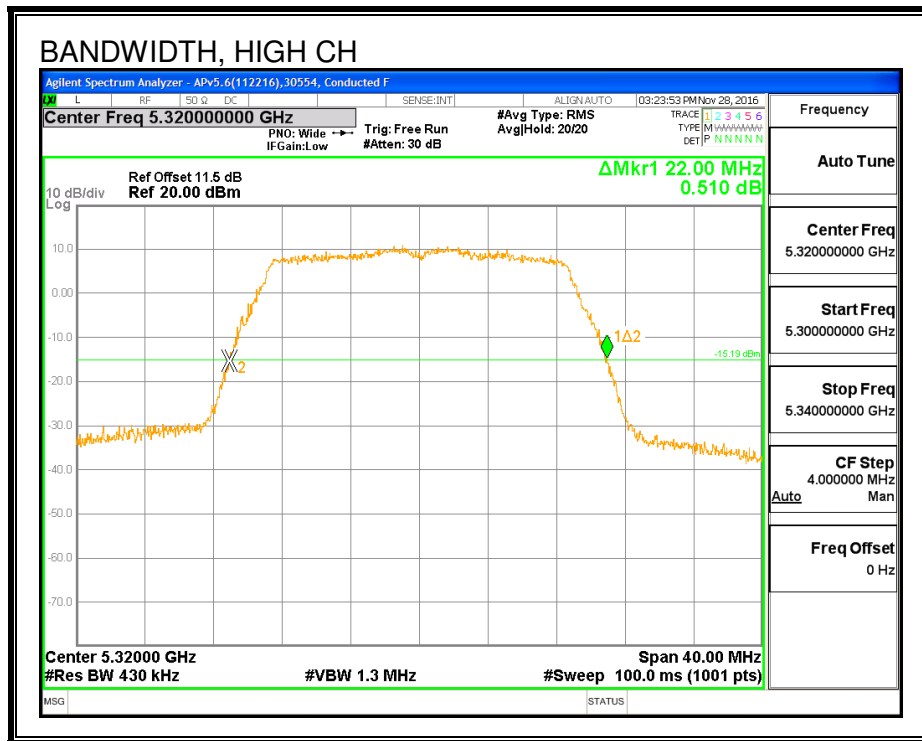

8.13.2. 99% BANDWIDTH

LIMITS

None; for reporting purposes only.

RESULTS

Channel	Frequency (MHz)	99% Bandwidth (MHz)
Low	5260	17.737
Mid	5300	17.834
High	5320	17.738

99% BANDWIDTH

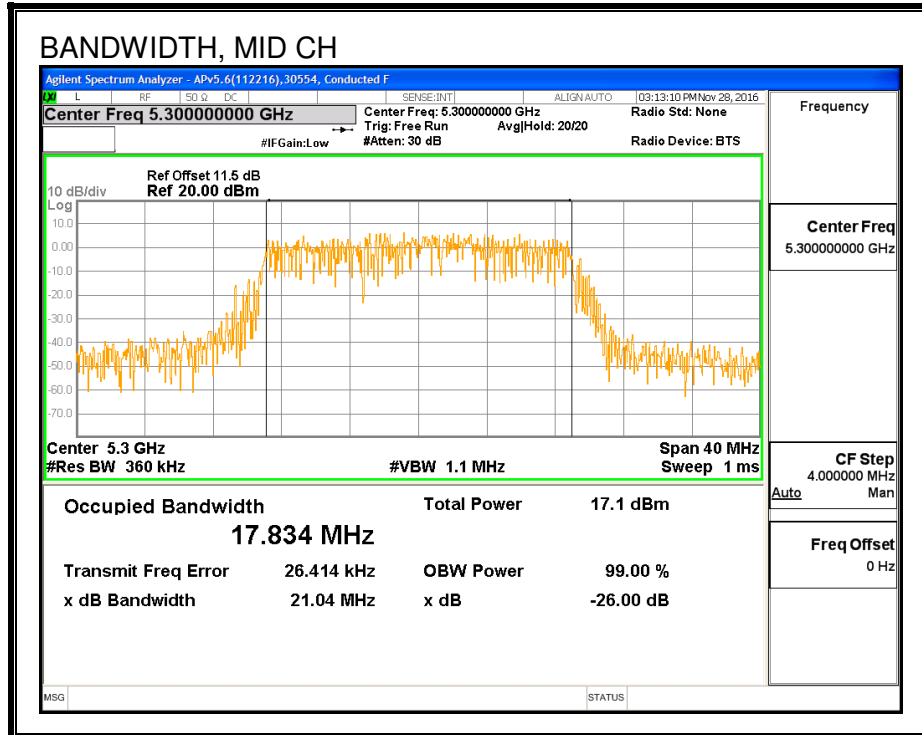
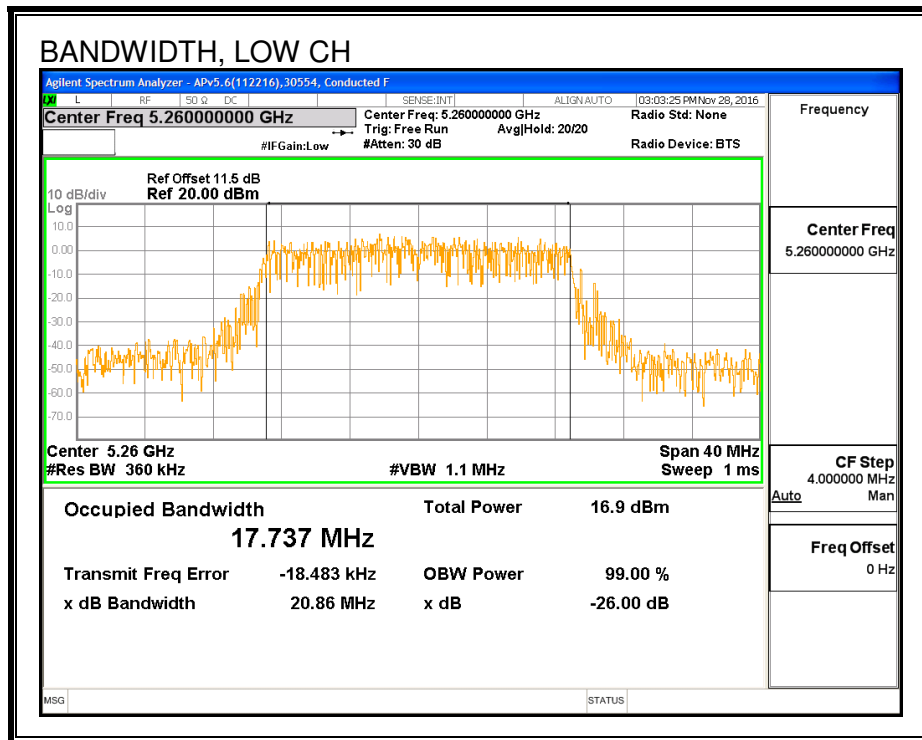

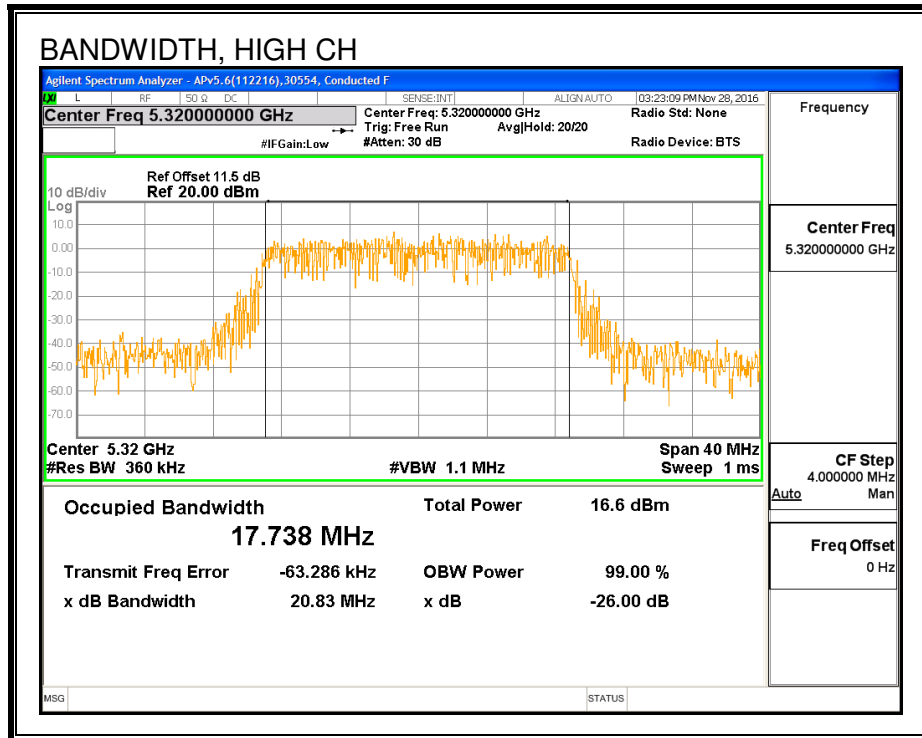

8.13.3. AVERAGE POWER

LIMITS

None; for reporting purposes only.

TEST PROCEDURE

Measurements perform using a wideband gated RF power meter.

RESULTS

ID:	39472	Date:	2/1/17
------------	-------	--------------	--------

Channel	Frequency (MHz)	Power (dBm)
Low	5260	15.98
Mid	5300	15.87
High	5320	15.90

8.13.4. OUTPUT POWER AND PSD

LIMITS

FCC §15.407 (a) (2)

For the band 5.25–5.35 GHz, the maximum conducted output power over the frequency band of operation shall not exceed the lesser of 250 mW or $11 \text{ dBm} + 10 \log B$, where B is the 26-dB emission bandwidth in MHz. In addition, the maximum power spectral density shall not exceed 11 dBm in any 1-MHz band. If transmitting antennas of directional gain greater than 6 dBi are used, both the maximum conducted output power and the peak power spectral density shall be reduced by the amount in dB that the directional gain of the antenna exceeds 6 dBi.

TEST PROCEDURE

Measurements perform using a wideband gated RF power meter provided that the gate parameters are adjusted such that the power is measured only when the EUT is transmitting at its maximum power control level. Since the measurement is made only during the ON time of the transmitter, no duty cycle correction factor is required.

DIRECTIONAL ANTENNA GAIN

There is only one transmitter output therefore the directional gain is equal to the antenna gain.

RESULTS

ID:	39472	Date:	2/1/17
------------	-------	--------------	--------

Bandwidth, Antenna Gain, and Limits

Channel	Frequency (MHz)	Min 26 dB BW (MHz)	Min 99% BW (MHz)	Directional Gain (dBi)	Power Limit (dBm)	PSD Limit (dBm)
Low	5260	22.04	17.74	4.11	23.49	11.00
Mid	5300	21.76	17.83	4.11	23.51	11.00
High	5320	22.00	17.74	4.11	23.49	11.00

Duty Cycle CF (dB)	0.00	Included in Calculations of Corr'd PSD
---------------------------	------	---

Output Power Results

Channel	Frequency (MHz)	Ant A Meas Power (dBm)	Total Corr'd Power (dBm)	Power Limit (dBm)	Power Margin (dB)
Low	5260	15.98	15.98	23.49	-7.51
Mid	5300	15.87	15.87	23.51	-7.64
High	5320	15.9	15.90	23.49	-7.59

PSD Results

Channel	Frequency (MHz)	Ant A Meas PSD (dBm)	Total Corr'd PSD (dBm)	PSD Limit (dBm)	PSD Margin (dB)
Low	5260	6.06	6.06	11.00	-4.94
Mid	5300	5.84	5.84	11.00	-5.16
High	5320	5.72	5.72	11.00	-5.28

PSD

