



# **CERTIFICATION TEST REPORT**

**Report Number. :** 16U23815-E1V2

**Applicant :** APPLE, INC  
1 INFINITE LOOP  
CUPERTINO, CA 95014, U.S.A.

**Model :** A1670

**FCC ID :** BCGA1670

**IC :** 579C-A1670

**EUT Description :** TABLET DEVICE

**Test Standard(s) :** FCC 47 CFR PART 15 SUBPART C  
INDUSTRY CANADA RSS - 247 ISSUE 1

**Date Of Issue:**  
February 27, 2017

**Prepared by:**  
UL Verification Services Inc.  
47173 Benicia Street  
Fremont, CA 94538, U.S.A.  
TEL: (510) 771-1000  
FAX: (510) 661-0888

**NVLAP<sup>®</sup>**  
TESTING  
NVLAP LAB CODE 200065-0

Revision History

<u>Rev.</u>	<u>Issue Date</u>	<u>Revisions</u>	<u>Revised By</u>
V1	02/15/2017	Initial Issue	Mengistu Mekuria
V2	02/27/2017	Address TCB's Question	Chin Pang

## TABLE OF CONTENTS

<b>1. ATTESTATION OF TEST RESULTS .....</b>	<b>5</b>
<b>2. TEST METHODOLOGY .....</b>	<b>6</b>
<b>3. FACILITIES AND ACCREDITATION .....</b>	<b>6</b>
<b>4. CALIBRATION AND UNCERTAINTY .....</b>	<b>7</b>
4.1. MEASURING INSTRUMENT CALIBRATION .....	7
4.2. SAMPLE CALCULATION .....	7
4.3. MEASUREMENT UNCERTAINTY.....	7
<b>5. EQUIPMENT UNDER TEST .....</b>	<b>8</b>
5.1. DESCRIPTION OF EUT .....	8
5.2. MAXIMUM OUTPUT POWER.....	8
5.3. DESCRIPTION OF AVAILABLE ANTENNAS .....	8
5.4. SOFTWARE AND FIRMWARE.....	8
5.5. WORST-CASE CONFIGURATION AND MODE.....	9
5.6. DESCRIPTION OF TEST SETUP.....	10
<b>6. TEST AND MEASUREMENT EQUIPMENT .....</b>	<b>16</b>
<b>7. ANTENNA PORT TEST RESULTS .....</b>	<b>17</b>
7.1. MEASUREMENT METHODS .....	17
7.2. ON TIME, DUTY CYCLE .....	18
7.3. HIGH POWER MODE.....	20
7.3.1. 6 dB BANDWIDTH.....	20
7.3.2. 99% BANDWIDTH.....	23
7.3.3. AVERAGE POWER .....	26
7.3.4. OUTPUT POWER .....	27
7.3.5. POWER SPECTRAL DENSITY .....	28
7.3.6. CONDUCTED BANDEDGE AND SPURIOUS EMISSIONS.....	31
7.4. LOW POWER MODE .....	35
7.4.1. 6 dB BANDWIDTH.....	35
7.4.2. 99% BANDWIDTH.....	38
7.4.3. AVERAGE POWER .....	41
7.4.4. OUTPUT POWER .....	42
7.4.5. POWER SPECTRAL DENSITY .....	45
7.4.6. CONDUCTED BANDEDGE AND SPURIOUS EMISSIONS.....	48
<b>8. RADIATED TEST RESULTS.....</b>	<b>52</b>
8.1. LIMITS AND PROCEDURE.....	52

---

8.2.	<i>HIGH POWER MODE</i> .....	53
8.2.1.	RESTRICTED BANDEDGE (LOW CHANNEL).....	53
8.2.2.	AUTHORIZED BANDEDGE (HIGH CHANNEL).....	55
8.2.3.	HARMONICS AND SPURIOUS EMISSIONS .....	57
8.3.	<i>LOW POWER MODE</i> .....	63
8.3.1.	RESTRICTED BANDEDGE (LOW CHANNEL).....	63
8.3.2.	AUTHORIZED BANDEDGE (HIGH CHANNEL).....	65
8.3.3.	HARMONICS AND SPURIOUS EMISSIONS .....	67
8.4.	<i>WORST-CASE CO-LOCATION</i> .....	73
8.5.	<i>WORST-CASE BELOW 1 GHz</i> .....	75
8.6.	<i>WORST-CASE ABOVE 18 GHz</i> .....	77
<b>9.</b>	<b>AC POWER LINE CONDUCTED EMISSIONS</b> .....	<b>79</b>
9.1.	<i>EUT POWERED BY AC/DC ADAPTER VIA USB CABLE</i> .....	80
9.2.	<i>EUT POWERED BY HOST PC VIA USB CABLE</i> .....	82
<b>10.</b>	<b>SETUP PHOTOS</b> .....	<b>84</b>

# 1. ATTESTATION OF TEST RESULTS

**COMPANY NAME:** APPLE  
1 INFINITE LOOP  
CUPERTINO, CA 95014, U.S.A.

**EUT DESCRIPTION:** TABLET DEVICE

**MODEL:** A1670

**SERIAL NUMBER:** CONDUCTED (DLXST005HPK5), RADIATED (DLXST008HPK5)

**DATE TESTED:** NOVEMBER 23, 2016 – JANUARY 20, 2017

APPLICABLE STANDARDS	
STANDARD	TEST RESULTS
CFR 47 Part 15 Subpart C	Pass
INDUSTRY CANADA RSS-247 Issue 1	Pass
INDUSTRY CANADA RSS-GEN Issue 4	Pass

UL Verification Services Inc. tested the above equipment in accordance with the requirements set forth in the above standards. All indications of Pass/Fail in this report are opinions expressed by UL Verification Services Inc. based on interpretations and/or observations of test results. Measurement Uncertainties were not taken into account and are published for informational purposes only. The test results show that the equipment tested is capable of demonstrating compliance with the requirements as documented in this report.

**Note:** The results documented in this report apply only to the tested sample, under the conditions and modes of operation as described herein. This document may not be altered or revised in any way unless done so by UL Verification Services Inc. and all revisions are duly noted in the revisions section. Any alteration of this document not carried out by UL Verification Services Inc. will constitute fraud and shall nullify the document. This report must not be used by the client to claim product certification, approval, or endorsement by NVLAP, NIST, any agency of the Federal Government, or any agency of any government.

Approved & Released For  
UL Verification Services Inc. By:

Prepared By:

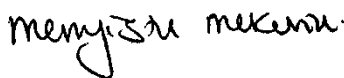

MENGISTU MEKURIA  
SENIOR ENGINEER  
UL VERIFICATION SERVICES INC.

CHRIS XIONG  
TEST ENGINEER  
UL VERIFICATION SERVICES INC.

## 2. TEST METHODOLOGY

The tests documented in this report were performed in accordance with FCC CFR 47 Part 2, FCC CFR 47 Part 15, KDB 558074 D01 v03r05, ANSI C63.10-2013, RSS-GEN Issue 4, and RSS-247 Issue 1.

## 3. FACILITIES AND ACCREDITATION

The test sites and measurement facilities used to collect data are located at 47173 and 47266 Benicia Street, Fremont, California, USA. Line conducted emissions are measured only at the 47173 address. The following table identifies which facilities were utilized for radiated emission measurements documented in this report. Specific facilities are also identified in the test results sections.

47173 Benicia Street	47266 Benicia Street
<input type="checkbox"/> Chamber A (IC:2324B-1)	<input type="checkbox"/> Chamber D (IC:2324B-4)
<input type="checkbox"/> Chamber B (IC:2324B-2)	<input type="checkbox"/> Chamber E (IC:2324B-5)
<input type="checkbox"/> Chamber C (IC:2324B-3)	<input checked="" type="checkbox"/> Chamber F (IC:2324B-6)
	<input type="checkbox"/> Chamber G (IC:2324B-7)
	<input checked="" type="checkbox"/> Chamber H (IC:2324B-8)

The above test sites and facilities are covered under FCC Test Firm Registration # 208313.

UL Verification Services Inc. is accredited by NVLAP, Laboratory Code 200065-0. The full scope of accreditation can be viewed at <http://ts.nist.gov/standards/scopes/2000650.htm>.

## 4. CALIBRATION AND UNCERTAINTY

### 4.1. MEASURING INSTRUMENT CALIBRATION

The measuring equipment utilized to perform the tests documented in this report has been calibrated in accordance with the manufacturer's recommendations, and is traceable to recognized national standards.

### 4.2. SAMPLE CALCULATION

Where relevant, the following sample calculation is provided:

$$\begin{aligned} \text{Field Strength (dBuV/m)} &= \text{Measured Voltage (dBuV)} + \text{Antenna Factor (dB/m)} + \\ &\text{Cable Loss (dB)} - \text{Preamp Gain (dB)} \\ 36.5 \text{ dBuV} + 18.7 \text{ dB/m} + 0.6 \text{ dB} - 26.9 \text{ dB} &= 28.9 \text{ dBuV/m} \end{aligned}$$

### 4.3. MEASUREMENT UNCERTAINTY

Where relevant, the following measurement uncertainty levels have been estimated for tests performed on the apparatus:

Parameter	Uncertainty
Worst Case Conducted Disturbance, 9KHz to 0.15 MHz	3.84 dB
Worst Case Conducted Disturbance, 0.15 to 30 MHz	3.65 dB
Worst Case Radiated Disturbance, 9KHz to 30 MHz	3.15 dB
Worst Case Radiated Disturbance, 30 to 1000 MHz	5.36 dB
Worst Case Radiated Disturbance, 1000 to 18000 MHz	4.32 dB
Worst Case Radiated Disturbance, 18000 to 26000 MHz	4.45 dB
Worst Case Radiated Disturbance, 26000 to 40000 MHz	5.24 dB

Uncertainty figures are valid to a confidence level of 95%.

## 5. EQUIPMENT UNDER TEST

### 5.1. DESCRIPTION OF EUT

The EUT is a tablet with multimedia functions (music, application support, and video), IEEE 802.11a/b/g/n/ac radio, and Bluetooth radio. The rechargeable battery is not user accessible.

### 5.2. MAXIMUM OUTPUT POWER

The transmitter has a maximum peak conducted output power as follows:

Frequency Range (MHz)	Mode	Output Power (dBm)	Output Power (mW)
2402 - 2480	BLE	17.51	56.36

### 5.3. DESCRIPTION OF AVAILABLE ANTENNAS

Frequency Band (GHz)	Antenna Gain (dBi)
2.4	-0.48

### 5.4. SOFTWARE AND FIRMWARE

The firmware installed in the EUT during testing was 14E232

## 5.5. WORST-CASE CONFIGURATION AND MODE

For below 1G, 18-26GHz radiated emission, and power line conducted emissions were performed with the EUT set to transmit at the channel with highest output power as worst-case scenario.

The fundamental of the EUT was investigated in three orthogonal orientations X/Y/Z, it was determined that Y (Landscape) orientation was worst-case orientation. Therefore, all final radiated testing was performed with the EUT in Y orientation.

Worst-case data rates as provided by the client were:  
Based on the baseline scan, the worst-case data rates were:

BLE: 1 Mbps.

There are two vendors of the WiFi/Bluetooth radio modules: variant 1 and variant 2. The WiFi/Bluetooth radio modules have the same mechanical outline (e.g., the same package dimension and pin-out layout), use the same on-board antenna matching circuit, have an identical antenna structure, and are built and tested to conform to the same specifications and to operate within the same tolerances.

Baseline testing was performed on the two variants to determine the worst case on all conducted power and radiated emissions.

## 5.6. DESCRIPTION OF TEST SETUP

### SUPPORT EQUIPMENT

Support Equipment List				
Description	Manufacturer	Model	Serial Number	FCC ID
Laptop	Apple	A1286	7313700NAGW	N/A
Laptop AC/DC adapter	Apple	A1343	C062172045DDJ94A6	N/A
Earphone	Apple	NA	NA	N/A
EUT AC/DC adapter	Apple	A1357	W010A051	N/A

### I/O CABLES (CONDUCTED TEST)

I/O Cable List						
Cable No	Port	# of identical ports	Connector Type	Cable Type	Cable Length (m)	Remarks
1	Antenna	1	SMA	Un-Shielded	0.2	To spectrum Analyzer
2	USB	1	USB	Shielded	1	N/A
3	AC	1	AC	Un-shielded	2	N/A

### I/O CABLES (RADIATED ABOVE 1 GHZ)

I/O Cable List						
Cable No	Port	# of identical ports	Connector Type	Cable Type	Cable Length (m)	Remarks
None Used						

### I/O CABLES (RADIATED BELOW 1 GHZ AND AC LINE CONDUCTED: AC/DC ADAPTER CONFIGURATION)

I/O Cable List						
Cable No	Port	# of identical	Connector Type	Cable Type	Cable Length (m)	Remarks
1	Earphone Jack	1	3.5mm Audio	Shielded	0.9	N/A
2	USB	1	USB	shielded	1	N/A

### I/O CABLES (AC LINE CONDUCTED: LAPTOP CONFIGUARTION)

I/O Cable List						
Cable No	Port	# of identical	Connector Type	Cable Type	Cable Length (m)	Remarks
1	Earphone Jack	1	3.5mm Audio	Shielded	0.9	N/A
2	USB	1	USB	Shielded	1	N/A
3	AC	1	AC	Un-shielded	2	N/A

**TEST SETUP - CONDUCTED TESTS**

The EUT was connected to a host Laptop via USB cable adapter and spectrum analyzer to antenna port. Test software exercised the EUT.

**SETUP DIAGRAM**

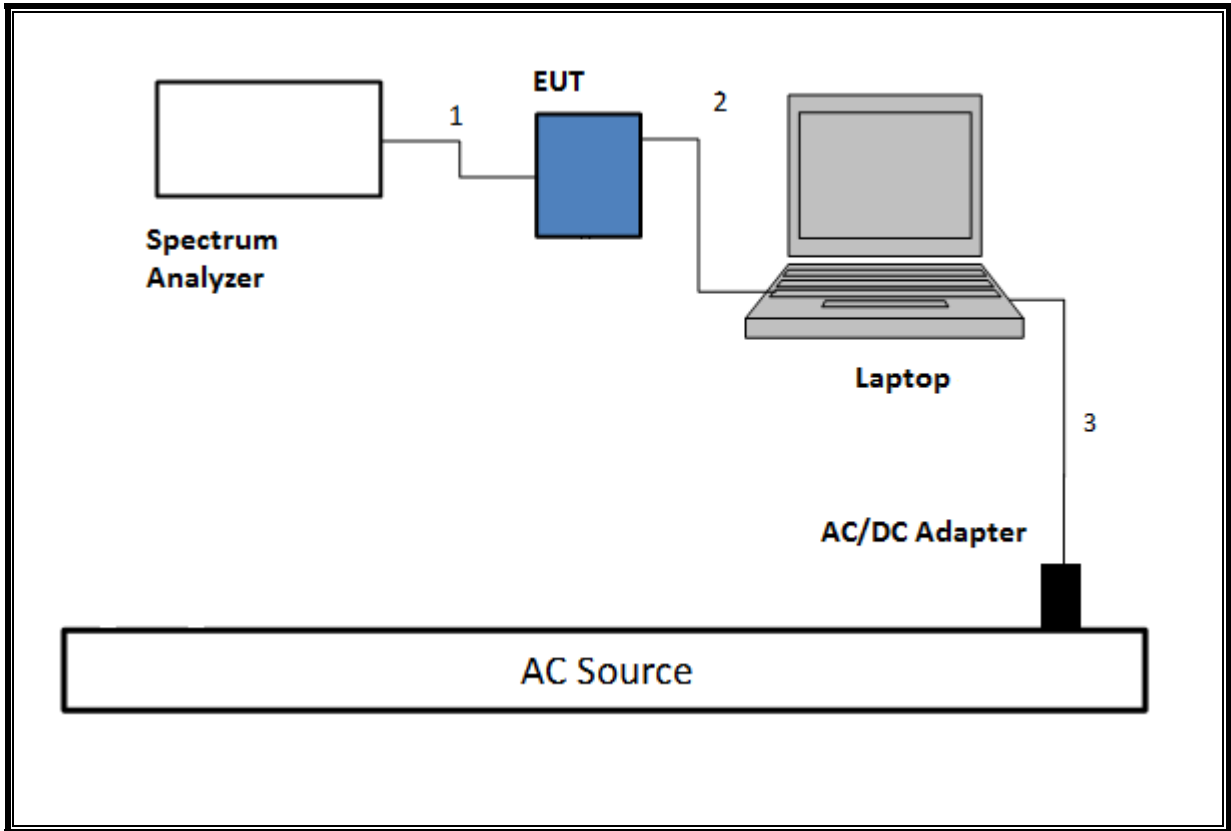

**TEST SETUP- RADIATED-ABOVE 1 GHZ**

The EUT was powered by battery. Test software exercised the EUT.

**SETUP DIAGRAM**

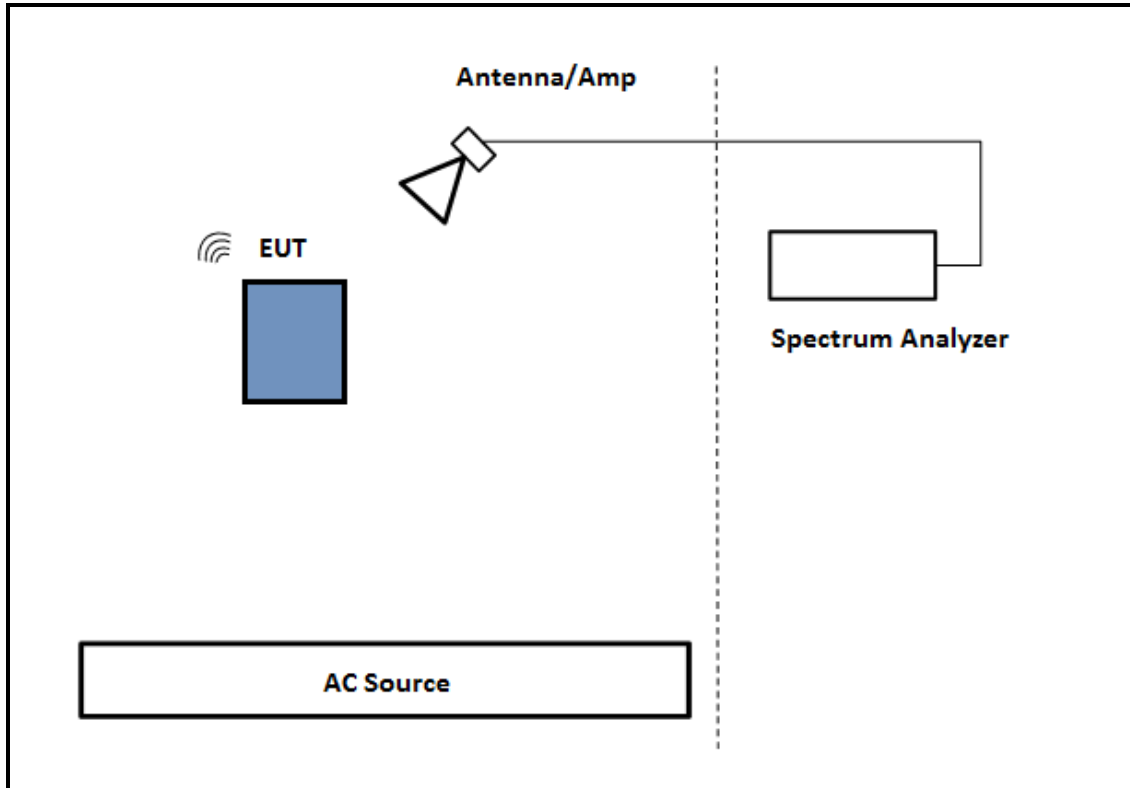

**TEST SETUP- BELOW 1GHz**

The EUT was powered by AC/DC adapter and connected with earphone. Test software exercised the EUT.

**SETUP DIAGRAM**

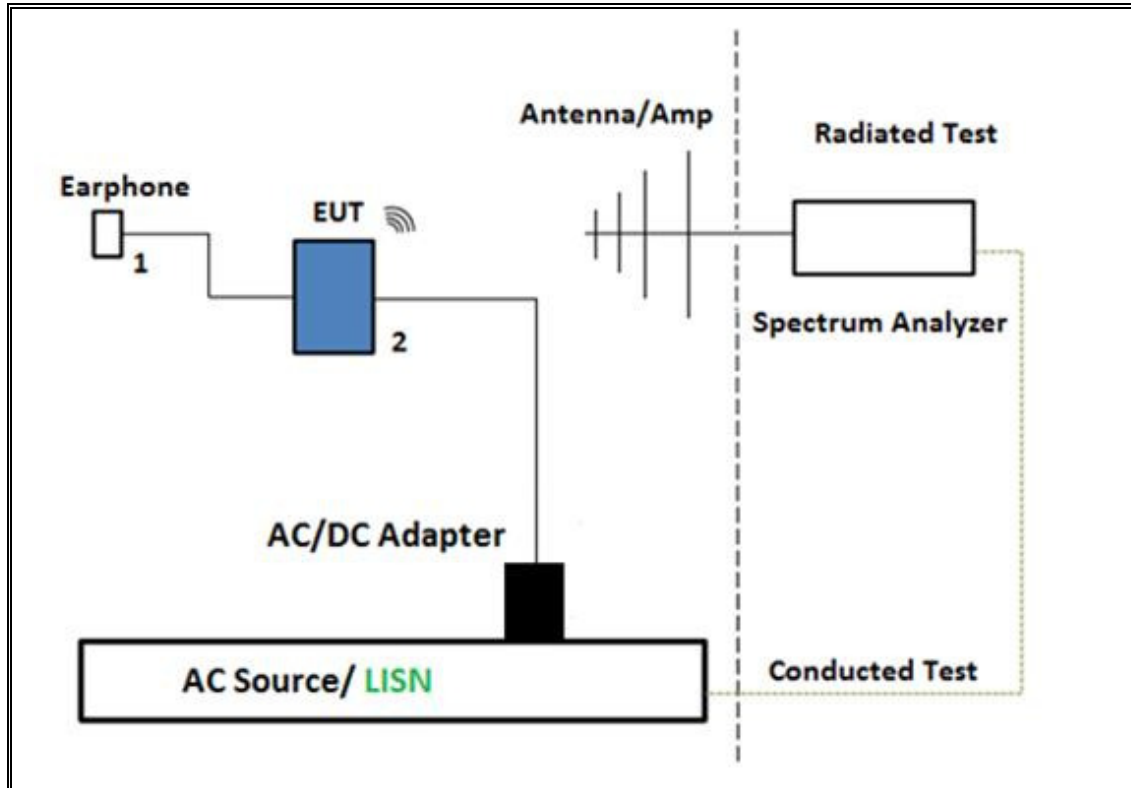

**TEST SETUP- AC LINE CONDUCTED: AC/DC ADAPTER CONFIGURATION**

The EUT was tested with earphone connected and powered by AC/DC adapter via USB cable. Test software exercised the EUT.

**SETUP DIAGRAM**

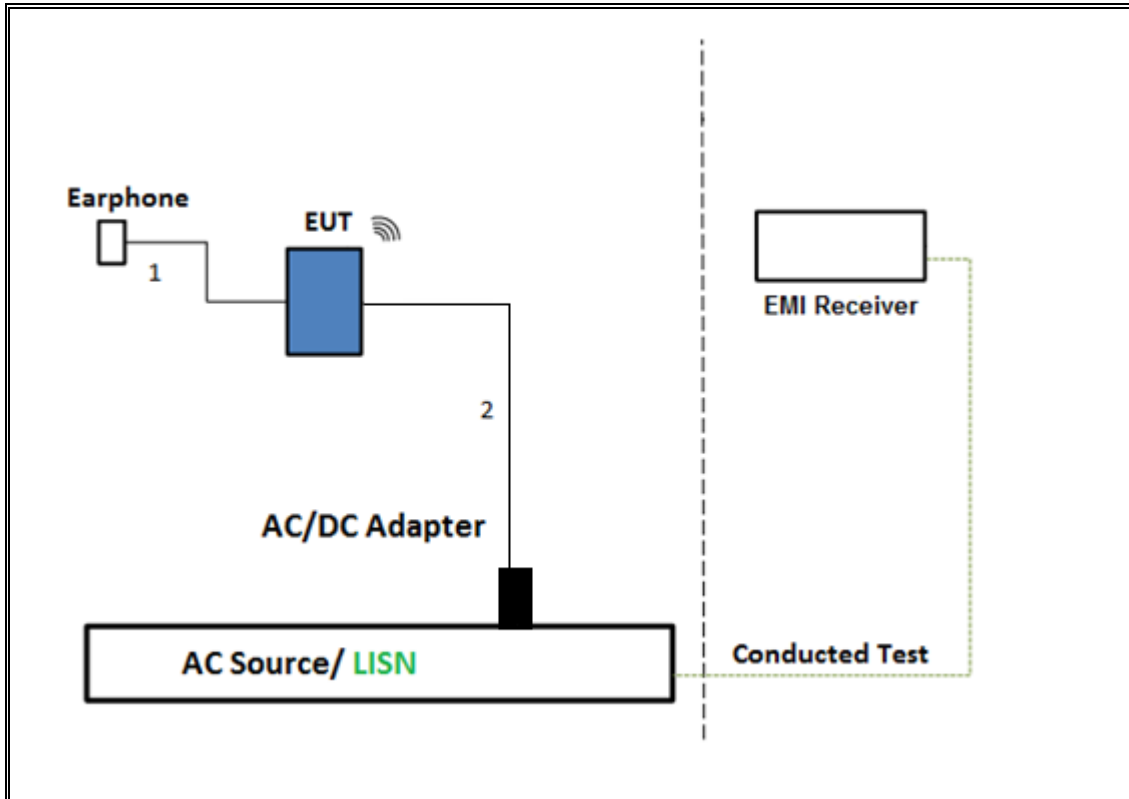

**TEST SETUP- AC LINE CONDUCTED: LAPTOP CONFIGURATION**

The EUT was tested with earphone connected and powered by host PC via USB cable. Test software exercised the EUT.

**SETUP DIAGRAM**

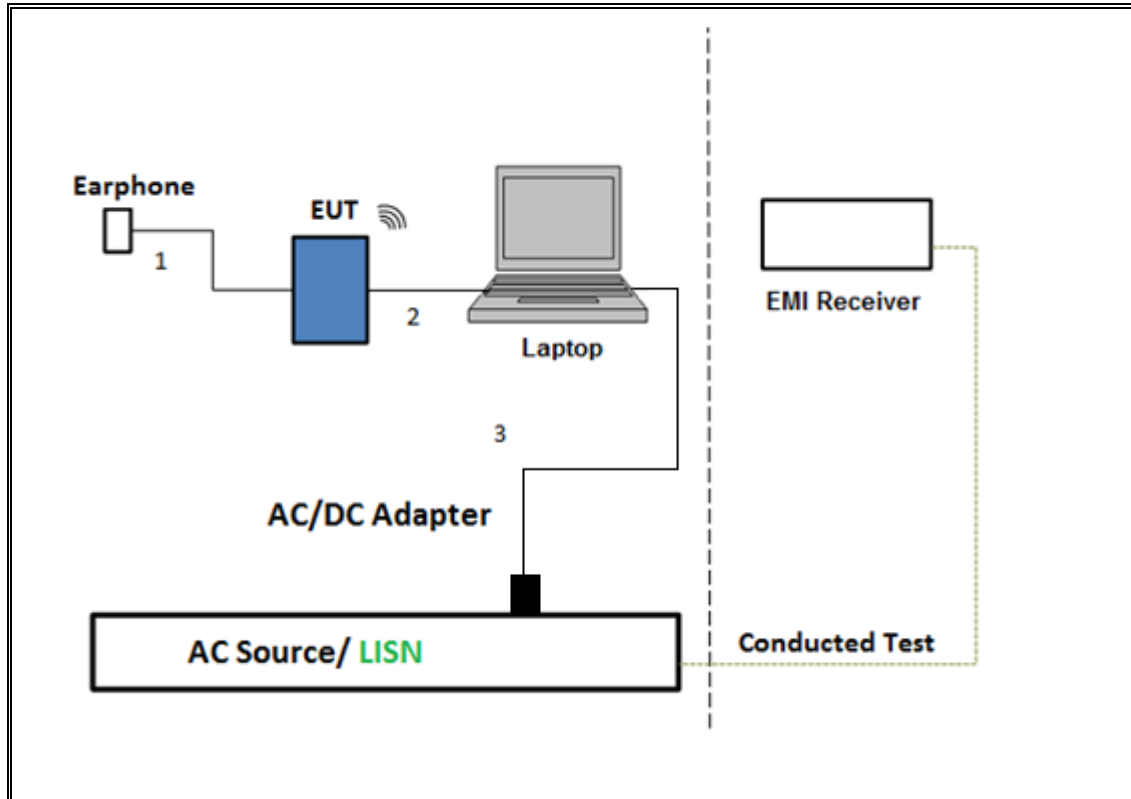

## 6. TEST AND MEASUREMENT EQUIPMENT

The following test and measurement equipment was utilized for the tests documented in this report:

<b>TEST EQUIPMENT LIST</b>				
<b>Description</b>	<b>Manufacturer</b>	<b>Model</b>	<b>Asset</b>	<b>Cal Due</b>
Antenna, Horn 1-18GHz	ETS Lindgren	3117	T120	4/5/2017
Antenna, Broadband Hybrid, 30MHz to 2000MHz	Sunol Sciences	JB3	T122	1/29/2017
Amplifier, 1 to 18GHz	Miteq	AFS42-00101800-25-S-42	T742	11/29/2017
Amplifier, 10KHz to 1GHz, 32dB	Sonoma	310N	T173	6/17/2017
Spectrum Analyzer, PXA 3Hz to 44GHz	Keysight	N9030A	T341	10/25/2017
Filter, HPF 3.0GHz	MICROTRONICS	HPM17543	T487	01/26/2017
Antenna, Horn 1-18GHz	ETS Lindgren	3117	T863	4/26/2017
Antenna, Broadband Hybrid, 30MHz to 2000MHz	Sunol Sciences	JB3	T900	5/3/2017
Amplifier, 1 to 18GHz, 35dB	Amplical	AMP1G18-35	T1569	9/15/2017
Amplifier, 10KHz to 1GHz, 32dB	Sonoma	310N	T835	6/18/2017
Spectrum Analyzer, PXA 3Hz to 44GHz	Keysight	N9030A	T906	02/03/2017
Power Meter, P-series single channel	Agilent (Keysight) Technologies	N1912A	T1245	05/03/2017
Power Sensor, P - series, 50MHz to 18GHz, Wideband	Agilent (Keysight) Technologies	N1921A	T1226	05/18/2017
Antenna Horn, 18 to 26GHz	ARA	MWH-1826	T447	6/16/2017
Spectrum Analyzer, 40GHz	Agilent	8564E	T106	9/7/2017
Amplifier, 1 to 26.5GHz 23.5dB gain Minimum	Keysight	8449B	T402	7/5/2017
<b>AC Line Conducted</b>				
EMI Test Receiver 9KHz-7GHz	Rohde & Schwarz	ESCI7	T1124	10/07/2017
LISN for Conducted Emissions CISPR-16	Fischer	50/250-25-2-01	T1310	06/08/2017
Power Cable, Line Conducted Emissions	UL	PG1	T861	9/1/2017
<b>UL AUTOMATION SOFTWARE</b>				
Radiated Software	UL	UL EMC	Ver 9.5, April 26, 2016	
Conducted Software	UL	UL EMC	Ver 5.4, October 13, 2016	
AC Line Conducted Software	UL	UL EMC	Ver 9.5, May 26, 2015	

NOTE: \*testing is completed before equipment calibration expiration date.

## 7. ANTENNA PORT TEST RESULTS

### 7.1. MEASUREMENT METHODS

6 dB BW: KDB 558074 D01 v03r05, Section 8.1.

Output Power: KDB 558074 D01 v03r05, Section 9.1.2.

Power Spectral Density: KDB 558074 D01 v03r05, Section 10.2.

Out-of-band emissions in non-restricted bands: KDB 558074 D01 v03r05, Section 11.0.

Out-of-band emissions in restricted bands: KDB 558074 D01 v03r05, Section 12.1.

Band-edge: KDB 558074 D01 v03r05, Section 12.1.

## 7.2. ON TIME, DUTY CYCLE

### LIMITS

None; for reporting purposes only.

### PROCEDURE

KDB 558074 Zero-Span Spectrum Analyzer Method.

### ON TIME AND DUTY CYCLE RESULTS

Mode	ON Time B (msec)	Period (msec)	Duty Cycle x (linear)	Duty Cycle (%)	Duty Cycle Correction Factor (dB)	1/B Minimum VBW (kHz)
BLE HIGH POWER	1.000	1.000	1.000	100.00%	0.00	0.010
BLE LOW POWER	1.000	1.000	1.000	100.00%	0.00	0.010

**DUTY CYCLE PLOTS**

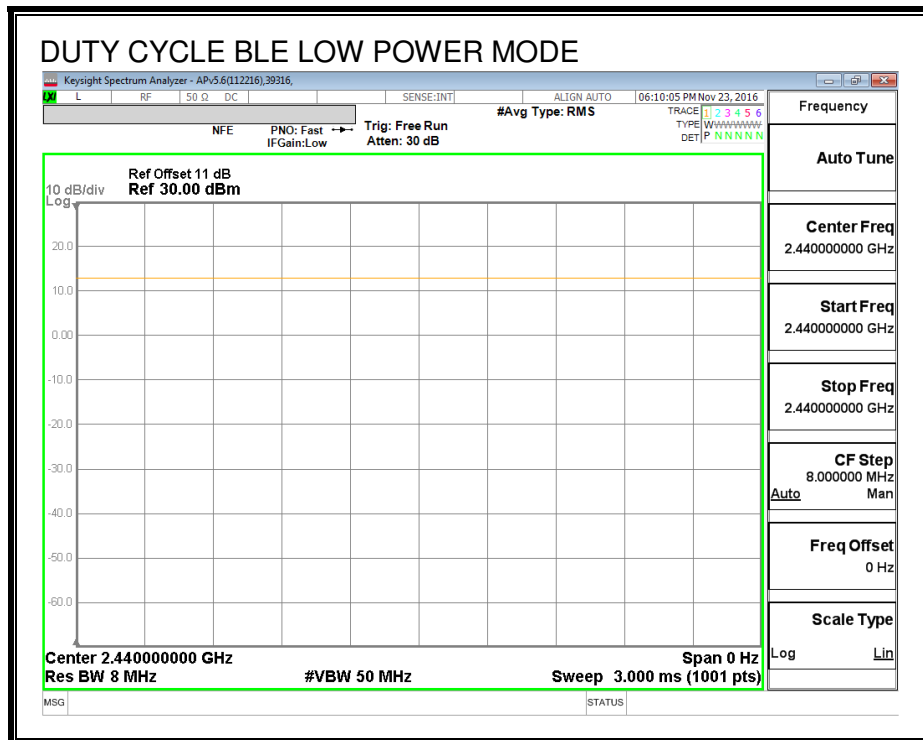
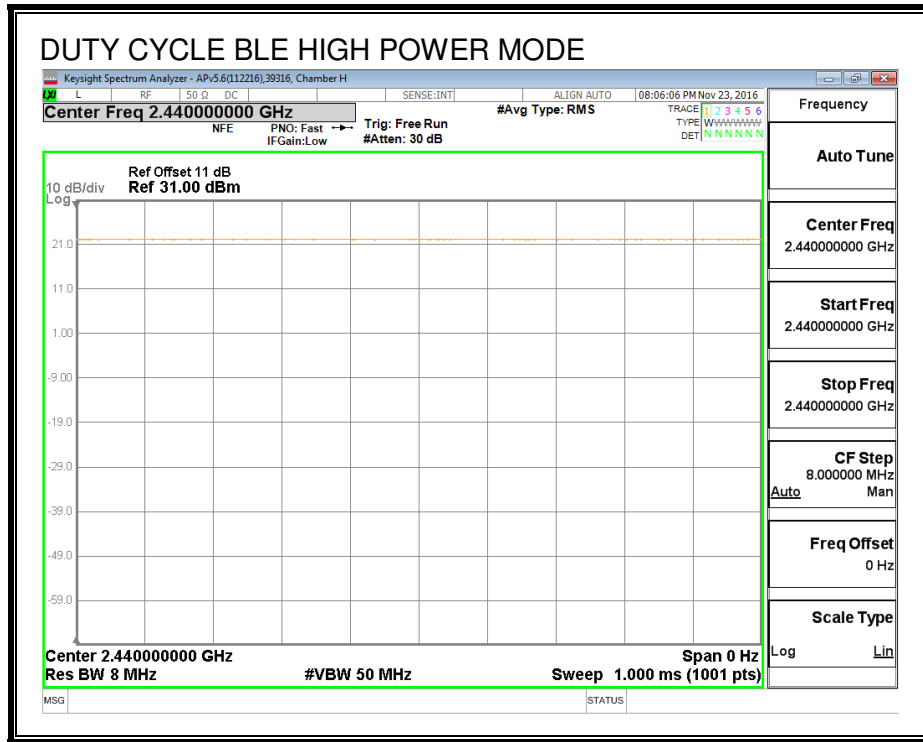

### 7.3. HIGH POWER MODE

#### 7.3.1. 6 dB BANDWIDTH

##### LIMITS

FCC §15.247 (a) (2)

IC RSS-247 (5.2) (1)

The minimum 6 dB bandwidth shall be at least 500 kHz.

##### RESULTS

Channel	Frequency	6 dB Bandwidth (MHz)	Minimum Limit (MHz)
Low	2402	0.742	0.5
Middle	2440	0.728	0.5
High	2480	0.738	0.5

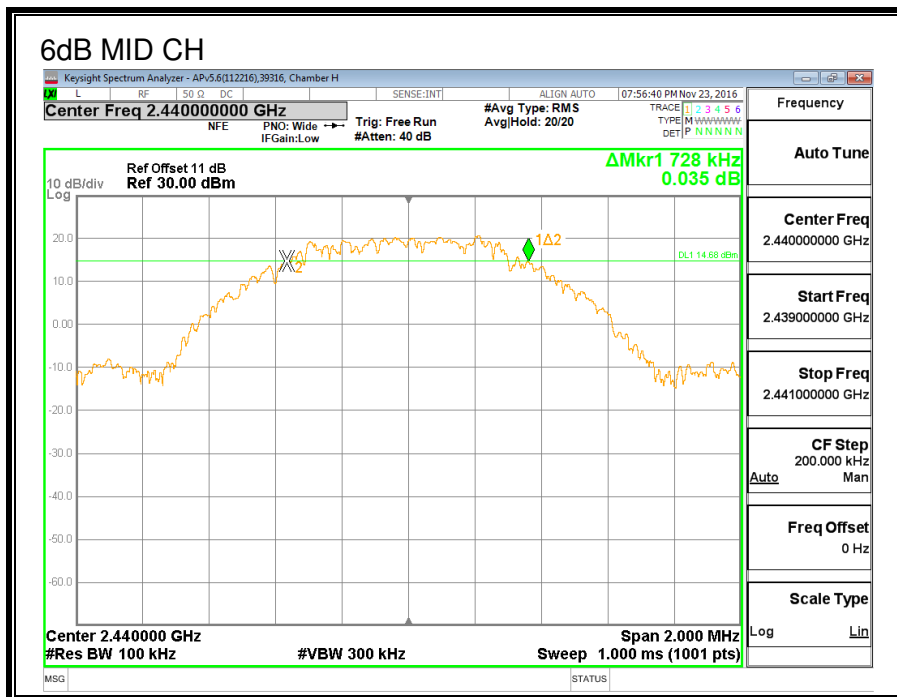
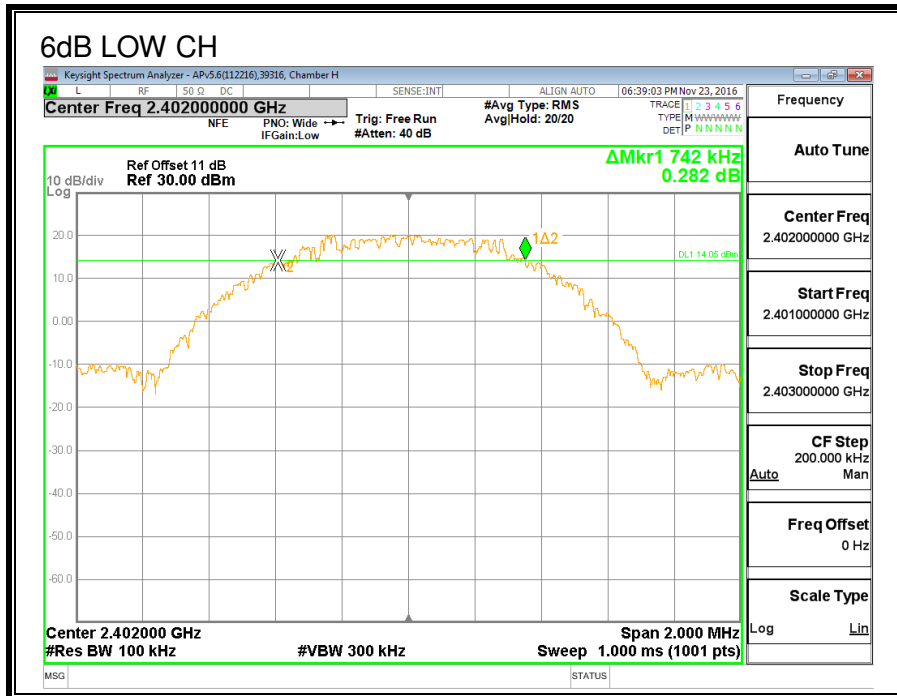

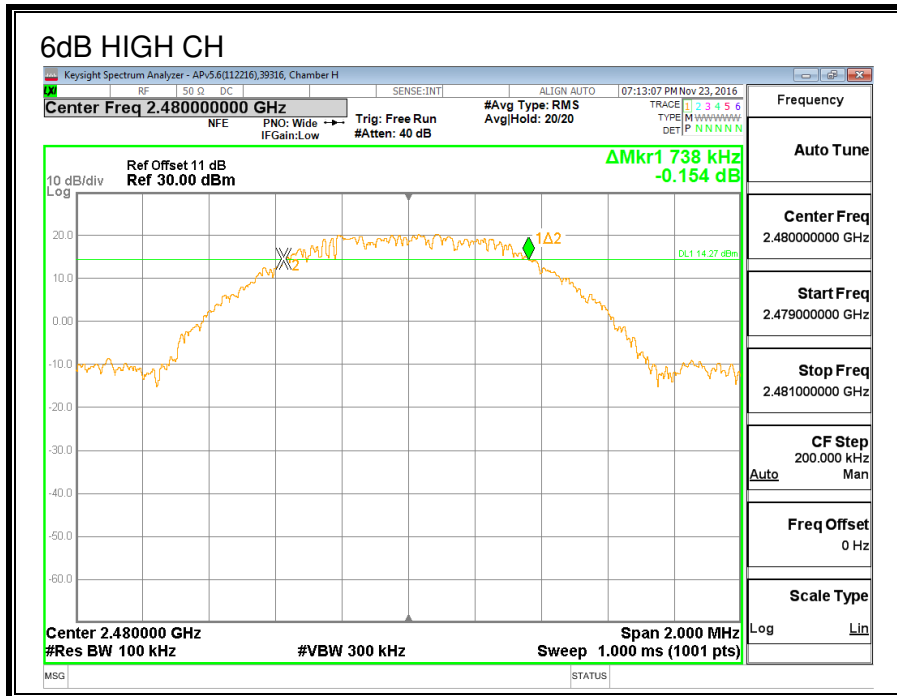

### 7.3.2. 99% BANDWIDTH

#### LIMITS

None; for reporting purposes only.

#### Test Procedure

The transmitter output is connected to the spectrum analyzer. The RBW is set to 1% to 3% of the 99 % bandwidth and to 1% of the span. The VBW is set to 3 times the RBW. The sweep time is coupled. The spectrum analyzer internal 99% bandwidth function is utilized.

#### RESULTS

Channel	Frequency (MHz)	99% Bandwidth (MHz)
Low	2402	1.059
Middle	2440	1.062
High	2480	1.062

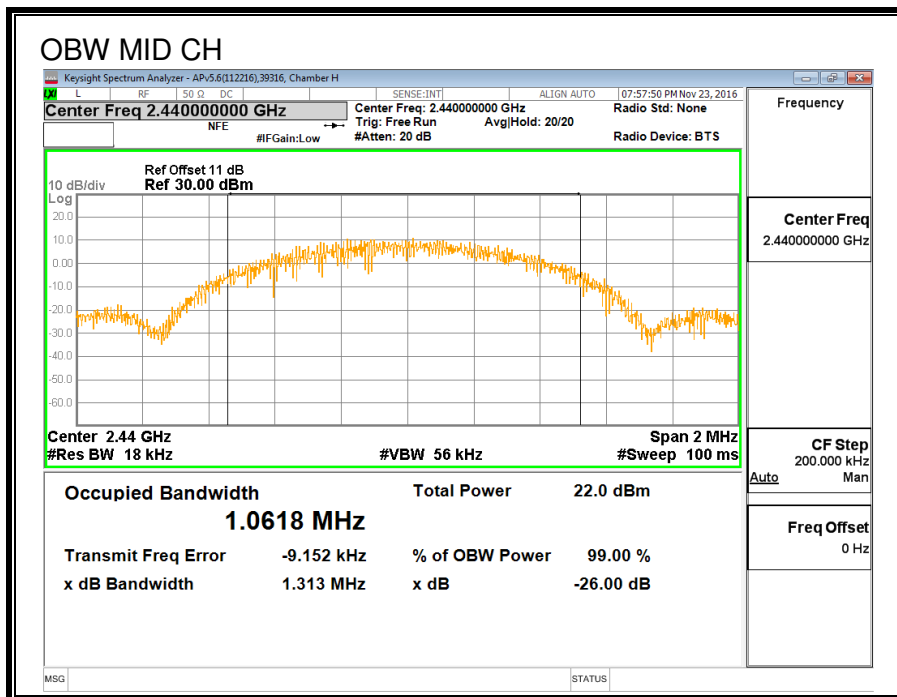
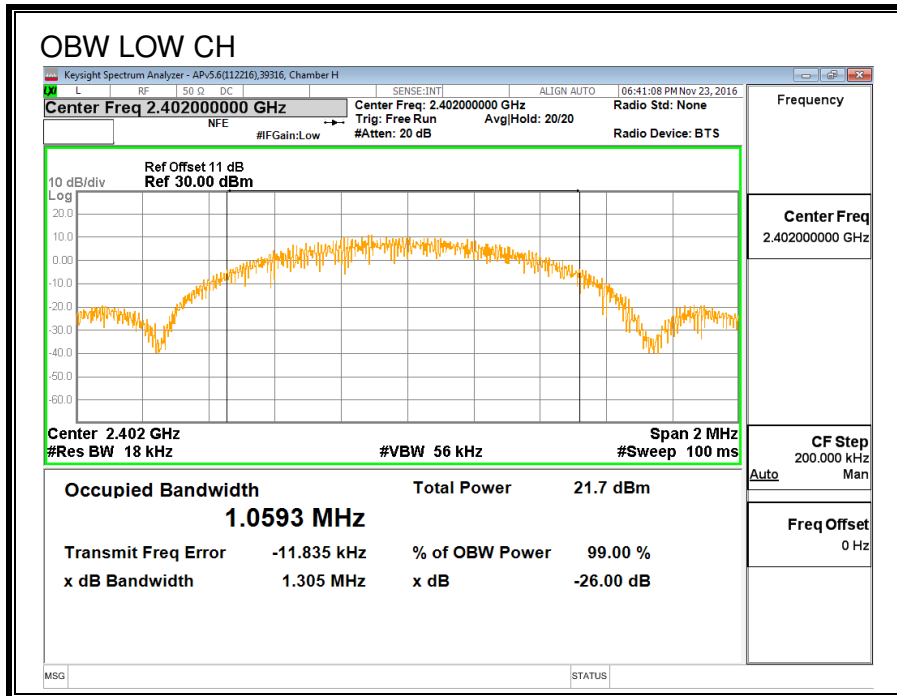

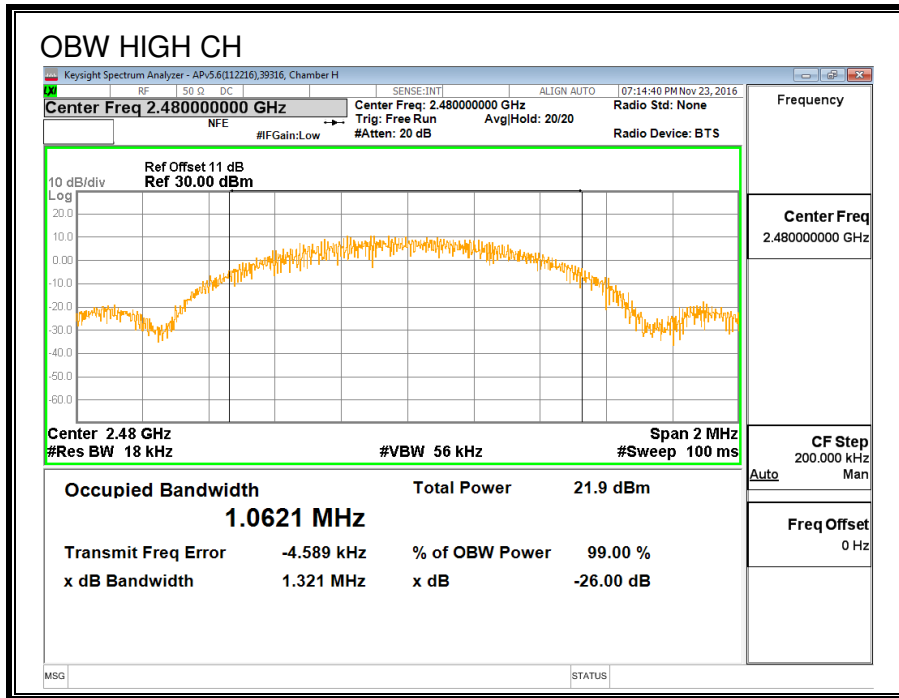

### 7.3.3. AVERAGE POWER

<b>ID:</b>	39316	<b>Date:</b>	11/23/16
------------	-------	--------------	----------

#### LIMITS

None; for reporting purposes only.

#### TEST PROCEDURE

The transmitter output is connected to a broadband Peak/average RF power meter

The cable assembly insertion loss of 11 dB (including 10 dB pad and 1 dB cable) was entered as an offset in the power meter to allow for direct reading of power.

#### RESULTS

Channel	Frequency (MHz)	AV Power (MHz)
Low	2402	16.78
Middle	2440	16.85
High	2480	16.98

### 7.3.4. OUTPUT POWER

#### LIMITS

FCC §15.247 (b)

IC RSS-247 (5.4) (4)

The maximum antenna gain is less than or equal to 6 dBi, therefore the limit is 30 dBm.

#### TEST PROCEDURE

The transmitter output is connected to a broadband peak/average RF power meter.

The cable assembly insertion loss of 11 dB (including 10 dB pad and 1 dB cable) was entered as an offset in the power meter to allow for direct reading of power.

#### RESULTS

Channel	Frequency (MHz)	Peak Power Reading (dBm)	Limit (dBm)	Margin (dB)
Low	2402	17.18	30	-12.82
Middle	2440	17.51	30	-12.50
High	2480	17.36	30	-12.64

### 7.3.5. POWER SPECTRAL DENSITY

#### LIMITS

FCC §15.247 (e)

IC RSS-247 (5.2) (2)

The power spectral density conducted from the transmitter to the antenna shall not be greater than 8 dBm in any 3 kHz band during any time interval of continuous transmission.

#### RESULTS

Channel	Frequency (MHz)	PSD (dBm)	Limit (dBm)	Margin (dB)
Low	2402	4.18	8	-3.82
Middle	2440	4.58	8	-3.42
High	2480	4.53	8	-3.47

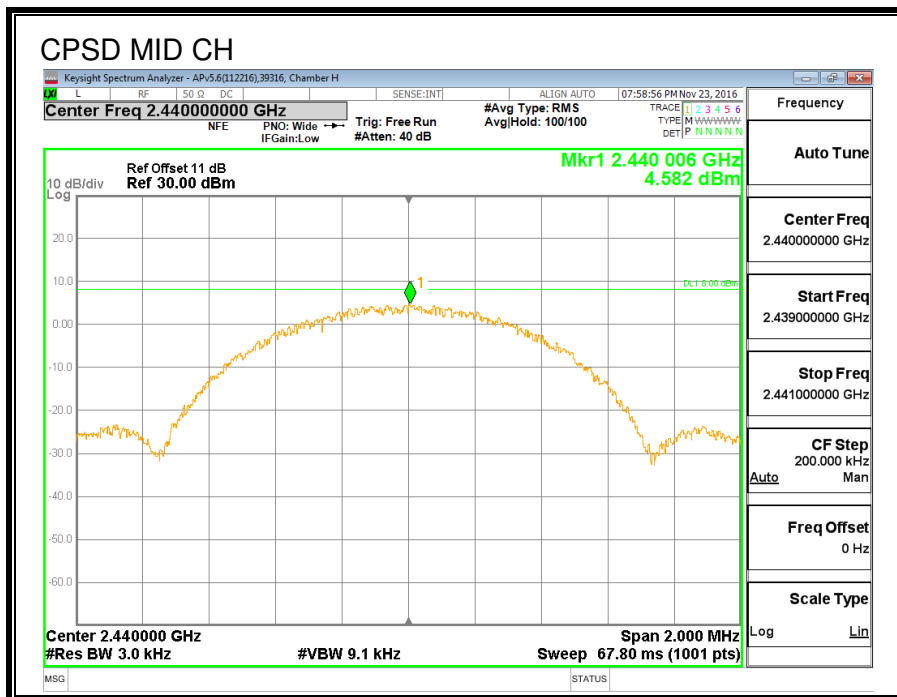
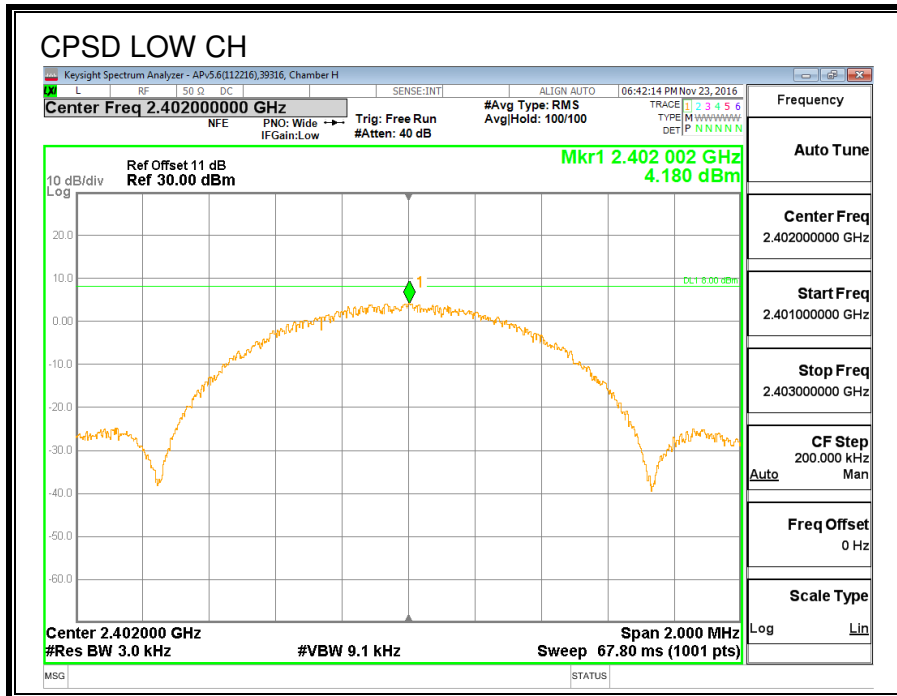

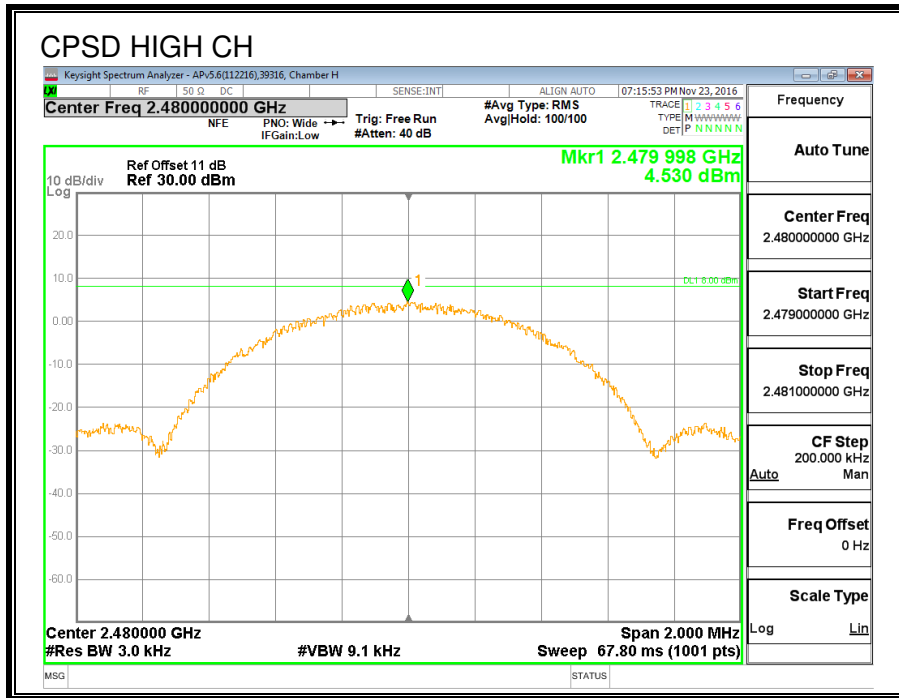

### 7.3.6. CONDUCTED BANDEDGE AND SPURIOUS EMISSIONS

#### LIMITS

FCC §15.247 (d)

IC RSS-247 (5.5)

Output power was measured based on the use of a peak measurement, therefore the required attenuation is 20 dB.

#### RESULTS

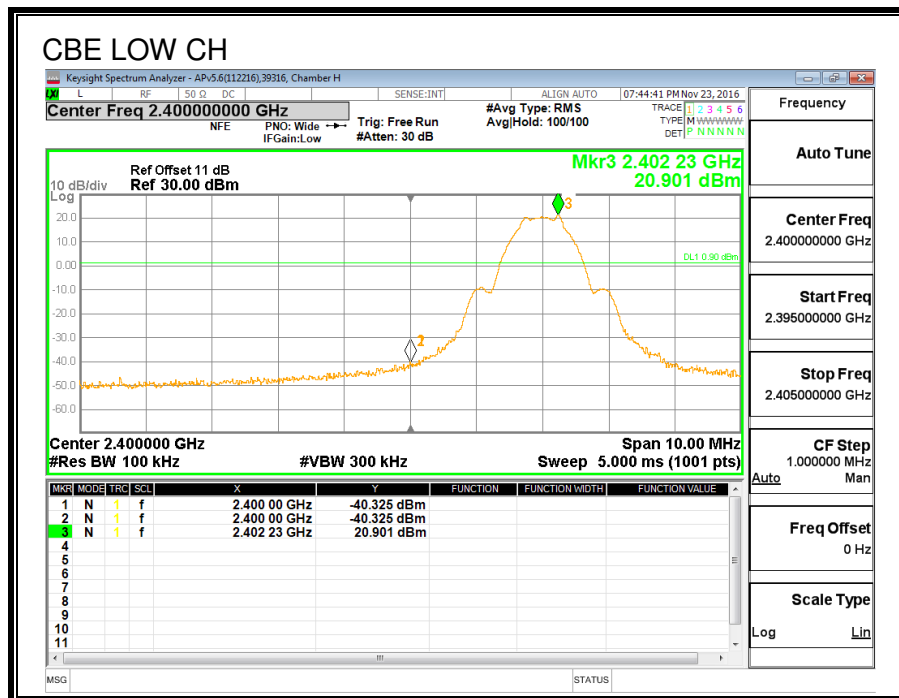

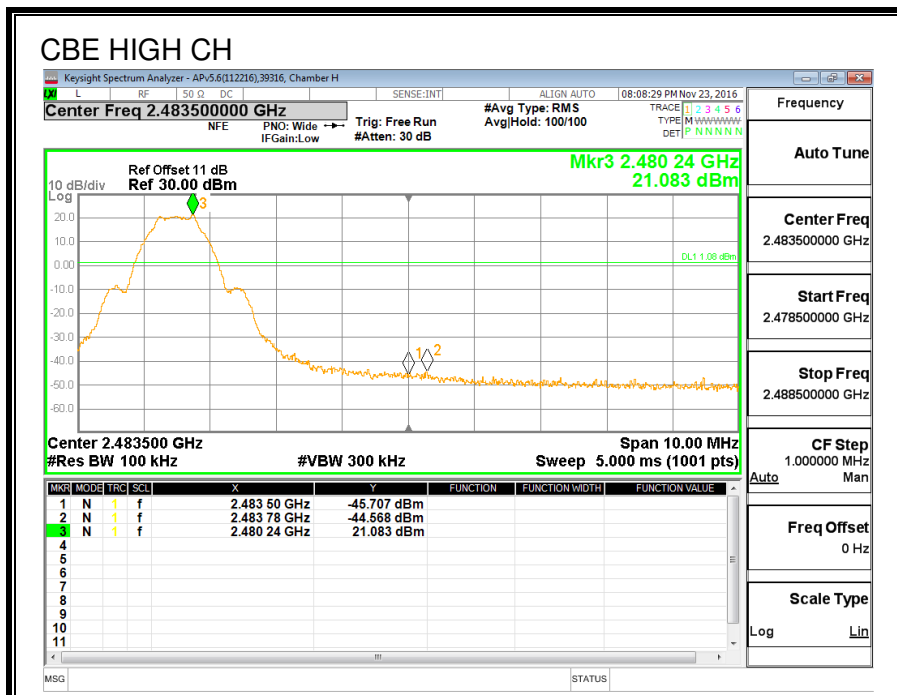
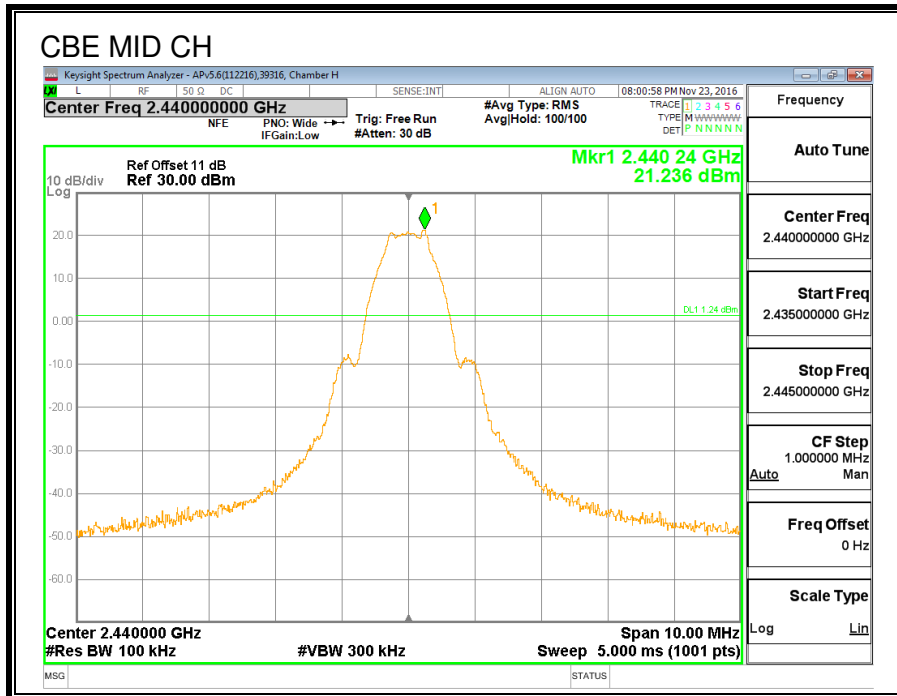

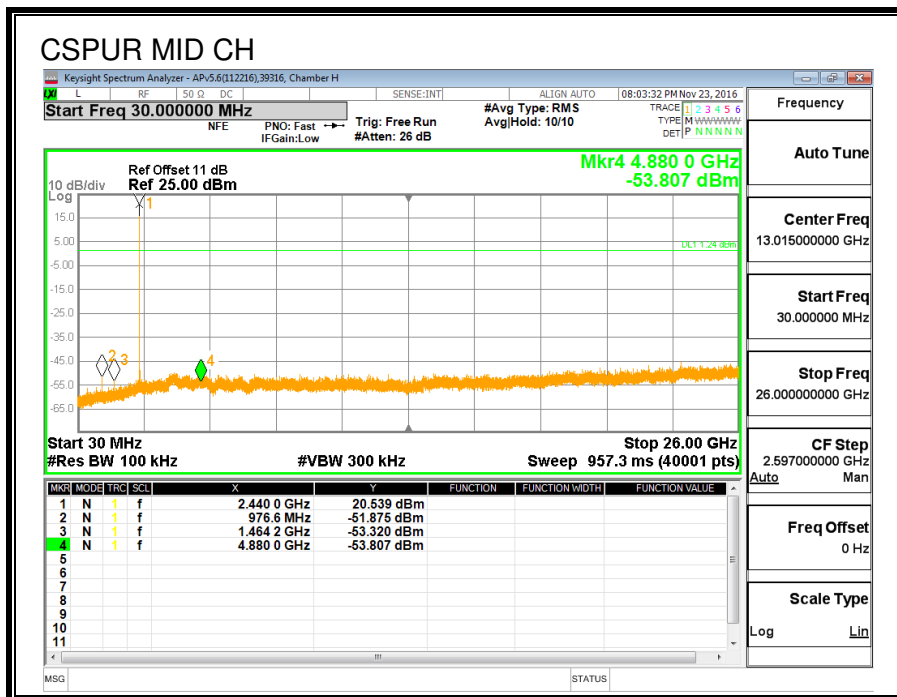
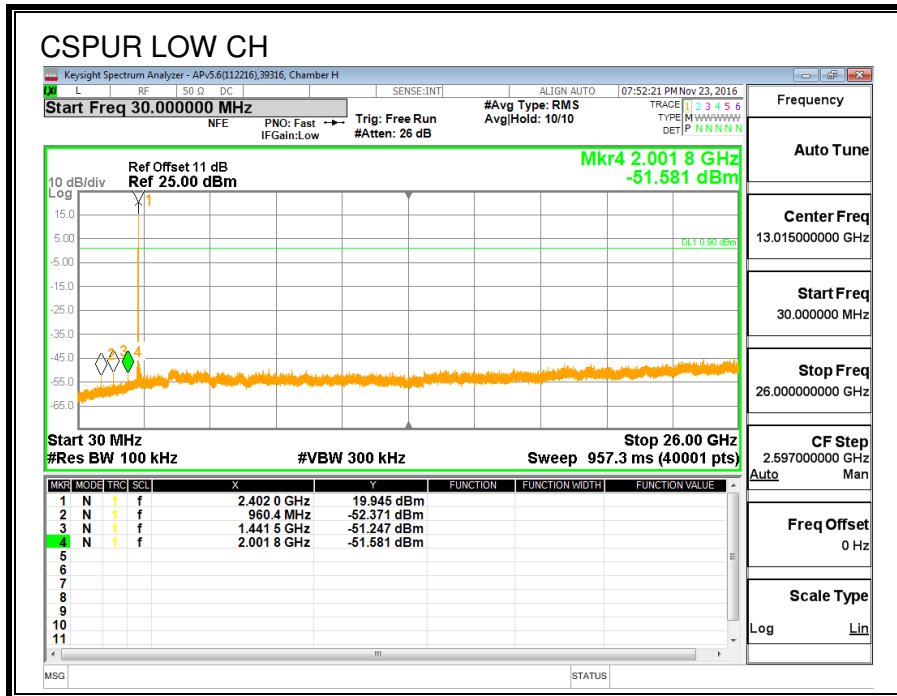

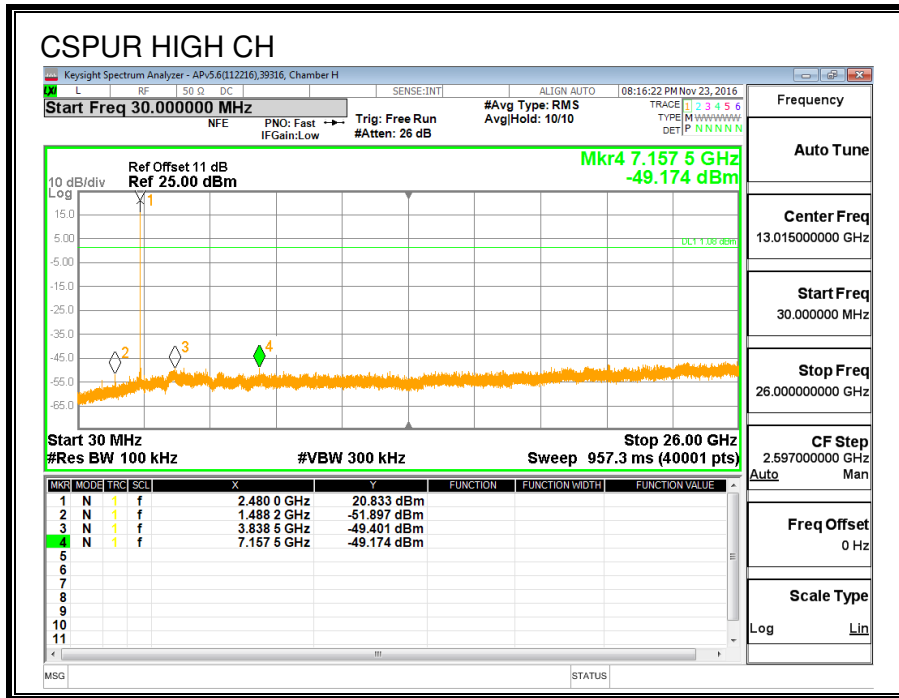

## 7.4. LOW POWER MODE

### 7.4.1. 6 dB BANDWIDTH

#### LIMITS

FCC §15.247 (a) (2)

IC RSS-247 (5.2) (1)

The minimum 6 dB bandwidth shall be at least 500 kHz.

#### RESULTS

Channel	Frequency	6 dB Bandwidth (MHz)	Minimum Limit (MHz)
Low	2402	0.734	0.5
Middle	2440	0.734	0.5
High	2480	0.756	0.5

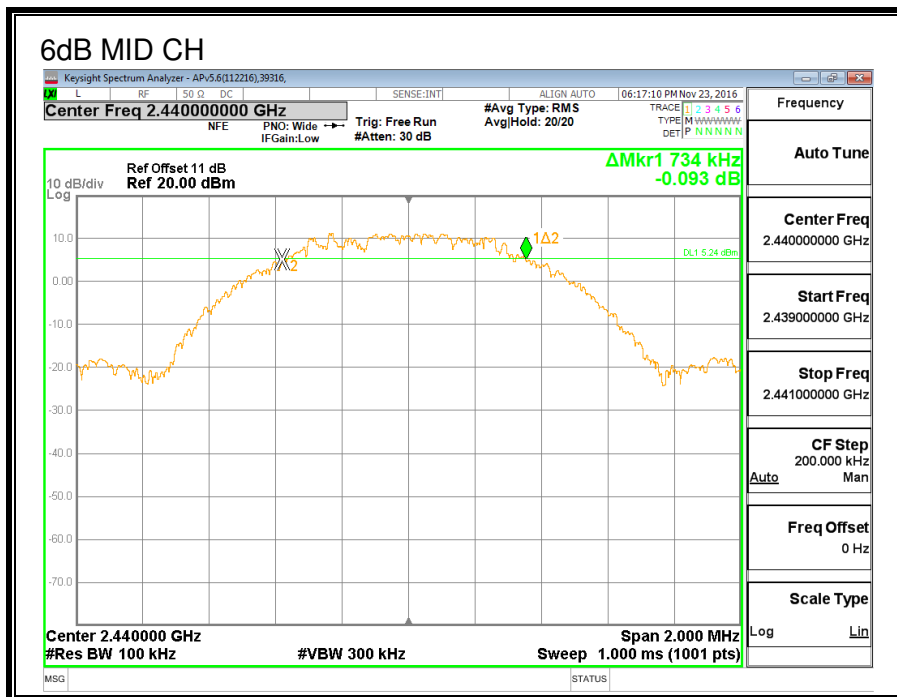
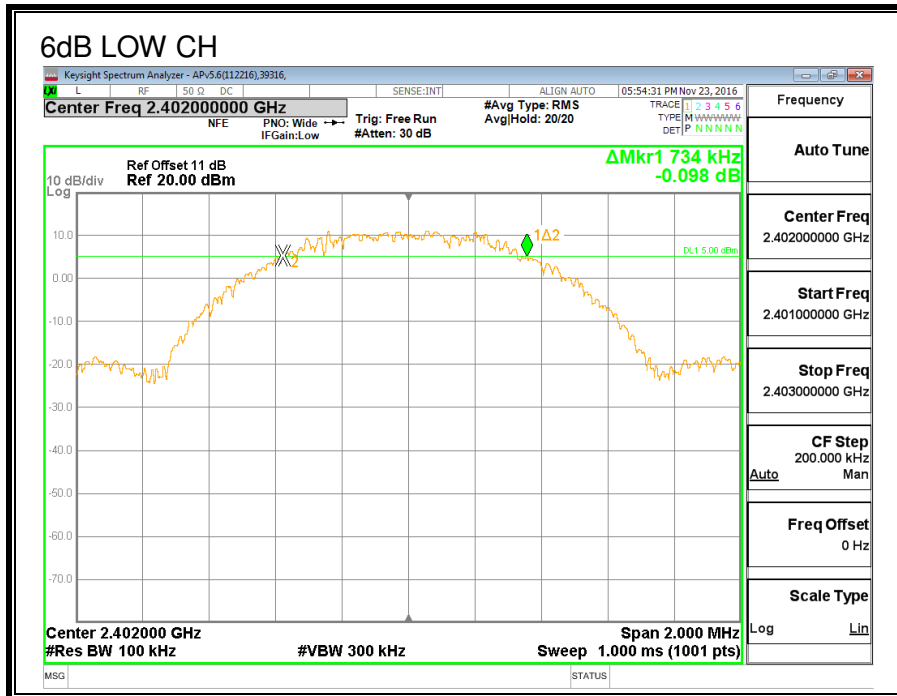

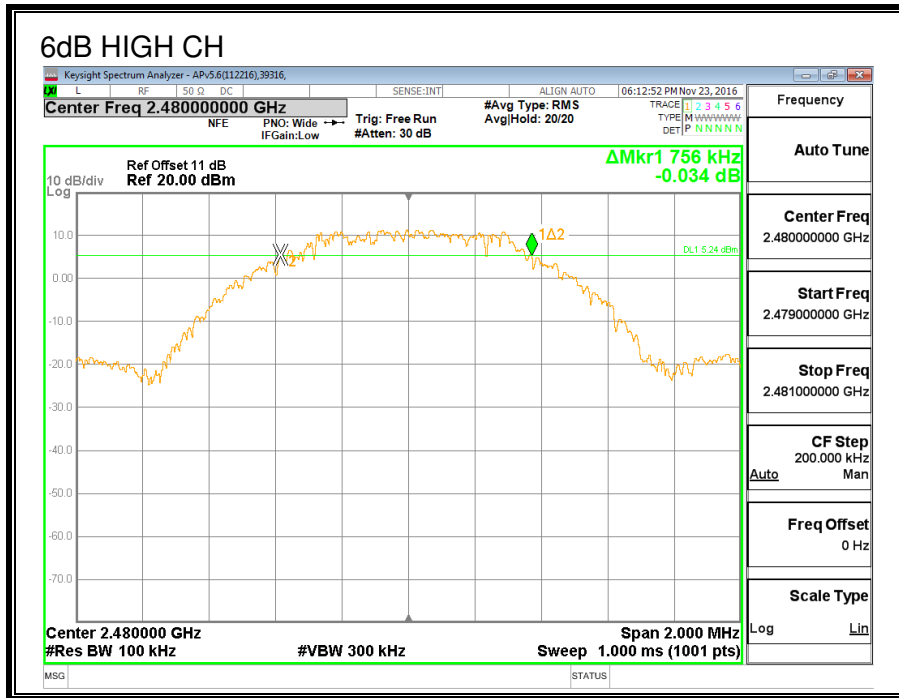

### 7.4.2. 99% BANDWIDTH

#### LIMITS

None; for reporting purposes only.

#### Test Procedure

The transmitter output is connected to the spectrum analyzer. The RBW is set to 1% to 3% of the 99 % bandwidth and to 1% of the span. The VBW is set to 3 times the RBW. The sweep time is coupled. The spectrum analyzer internal 99% bandwidth function is utilized.

#### RESULTS

Channel	Frequency (MHz)	99% Bandwidth (MHz)
Low	2402	1.0602
Middle	2440	1.0605
High	2480	1.0595

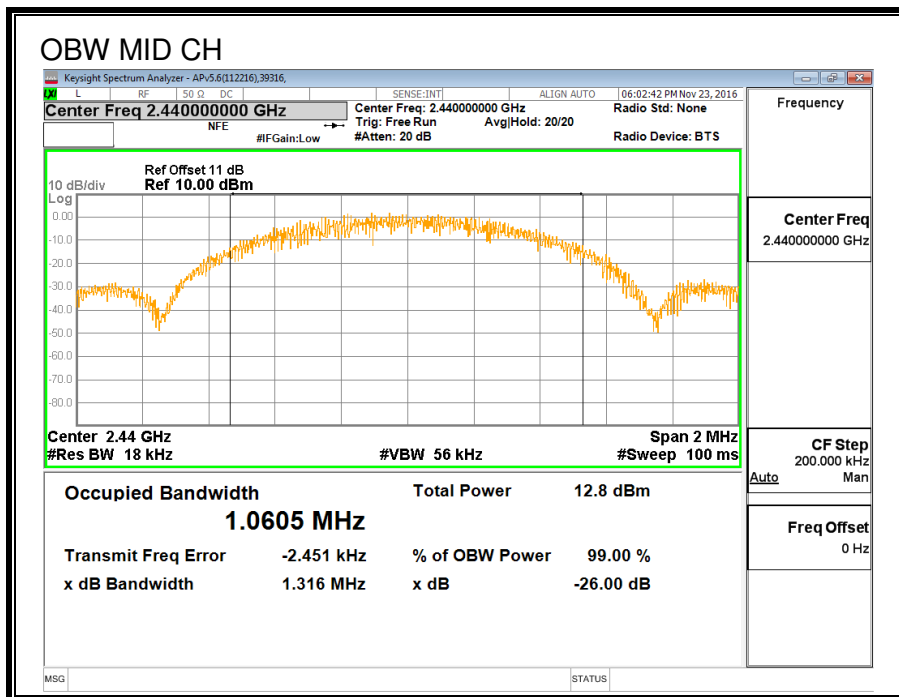
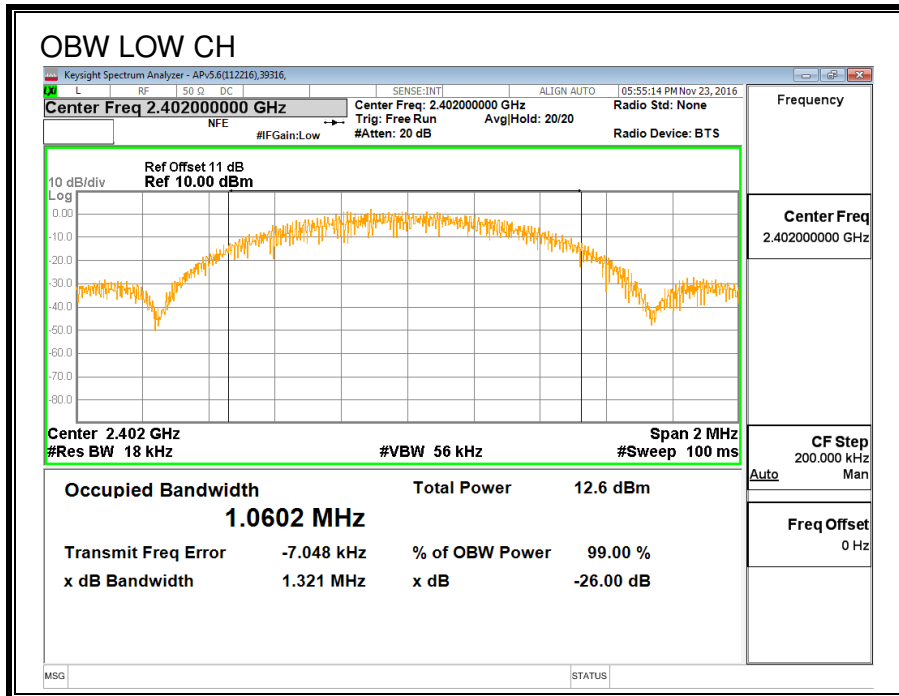

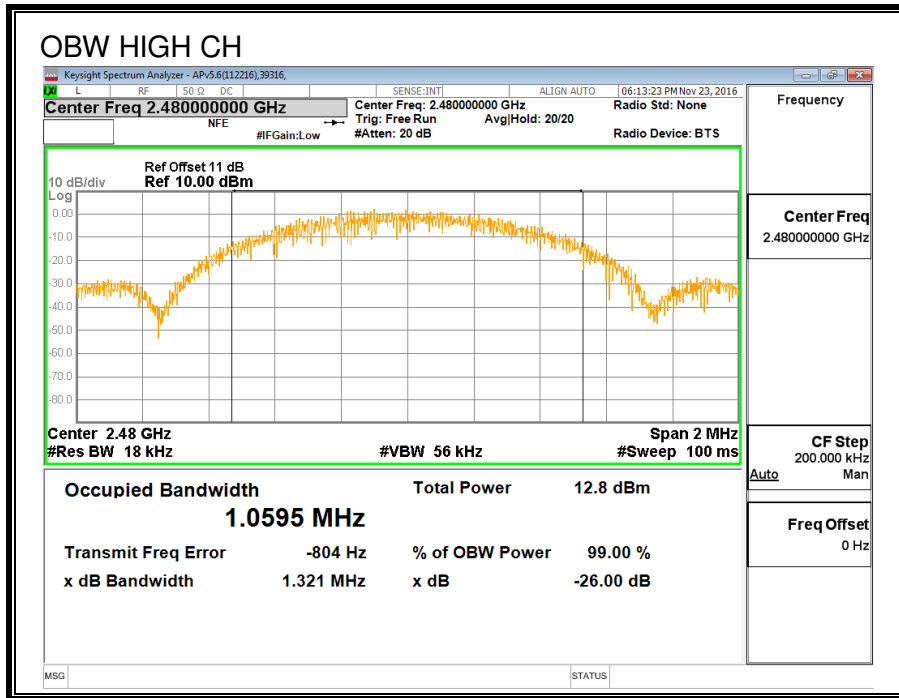

### 7.4.3. AVERAGE POWER

<b>ID:</b>	39316	<b>Date:</b>	11/23/16
------------	-------	--------------	----------

#### LIMITS

None; for reporting purposes only.

The cable assembly insertion loss of 11 dB (including 10 dB pad and 1 dB cable) was entered as an offset in the power meter to allow for direct reading of power.

#### RESULTS

Channel	Frequency (MHz)	AV Power (MHz)
Low	2402	9.39
Middle	2440	9.50
High	2480	9.44

### 7.4.4. OUTPUT POWER

#### LIMITS

FCC §15.247 (b)

IC RSS-247 (5.4) (4)

The maximum antenna gain is less than or equal to 6 dBi, therefore the limit is 30 dBm.

#### RESULTS

Channel	Frequency (MHz)	Peak Power Reading (dBm)	Limit (dBm)	Margin (dB)
Low	2402	9.63	30	-20.37
Middle	2440	9.73	30	-20.27
High	2480	9.68	30	-20.32

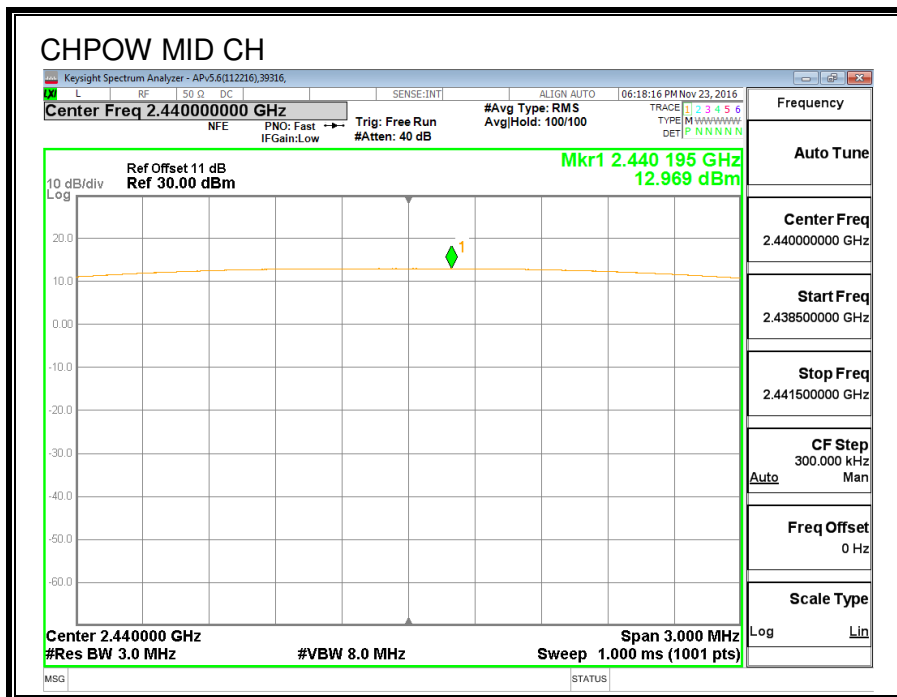
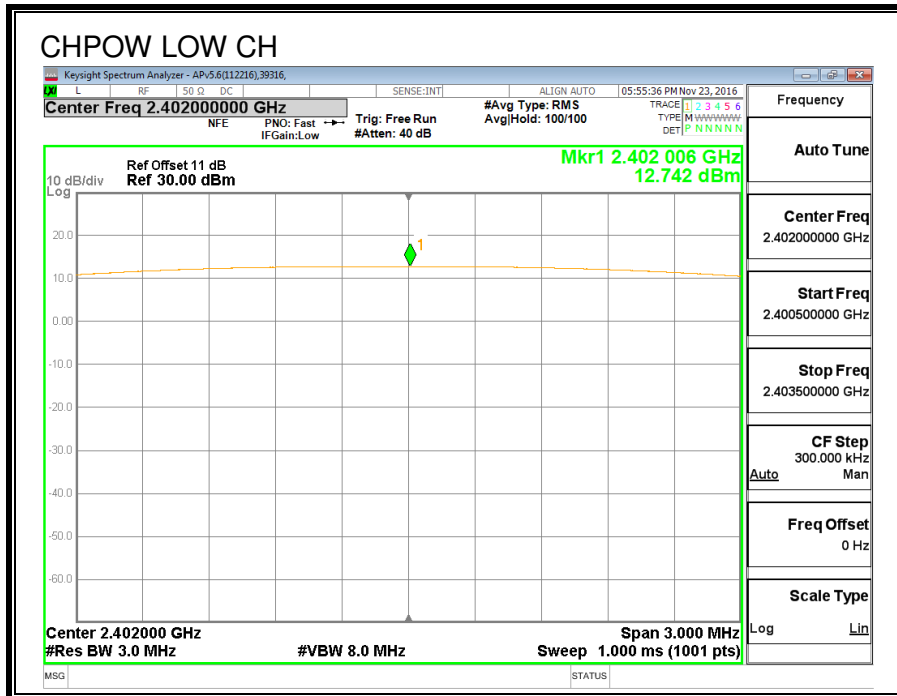

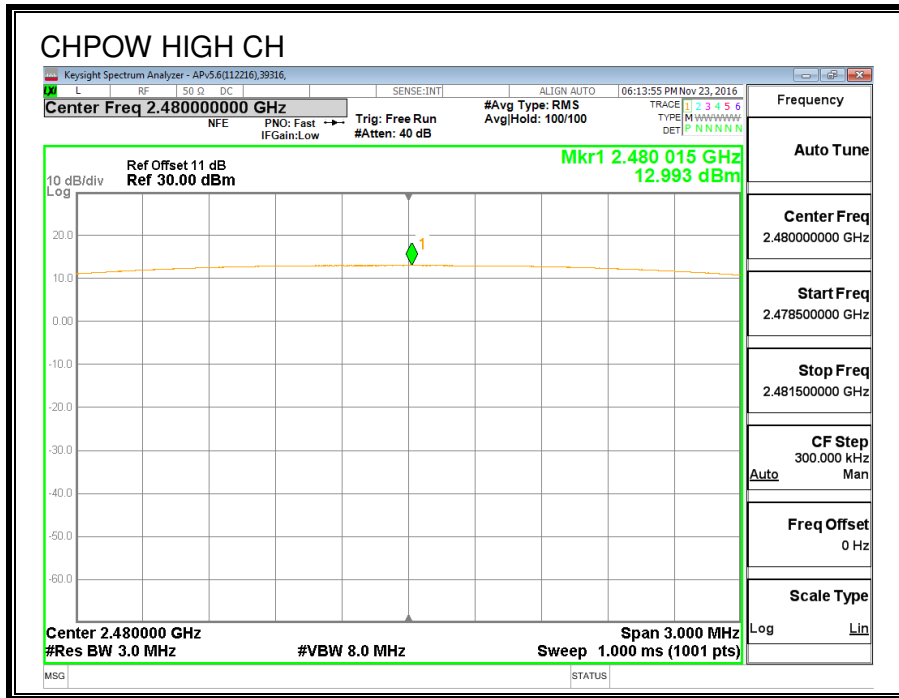

### 7.4.5. POWER SPECTRAL DENSITY

#### LIMITS

FCC §15.247 (e)

IC RSS-247 (5.2) (2)

The power spectral density conducted from the transmitter to the antenna shall not be greater than 8 dBm in any 3 kHz band during any time interval of continuous transmission.

#### RESULTS

Channel	Frequency (MHz)	PSD (dBm)	Limit (dBm)	Margin (dB)
Low	2402	-4.61	8	-12.61
Middle	2440	-4.60	8	-12.60
High	2480	-4.35	8	-12.35

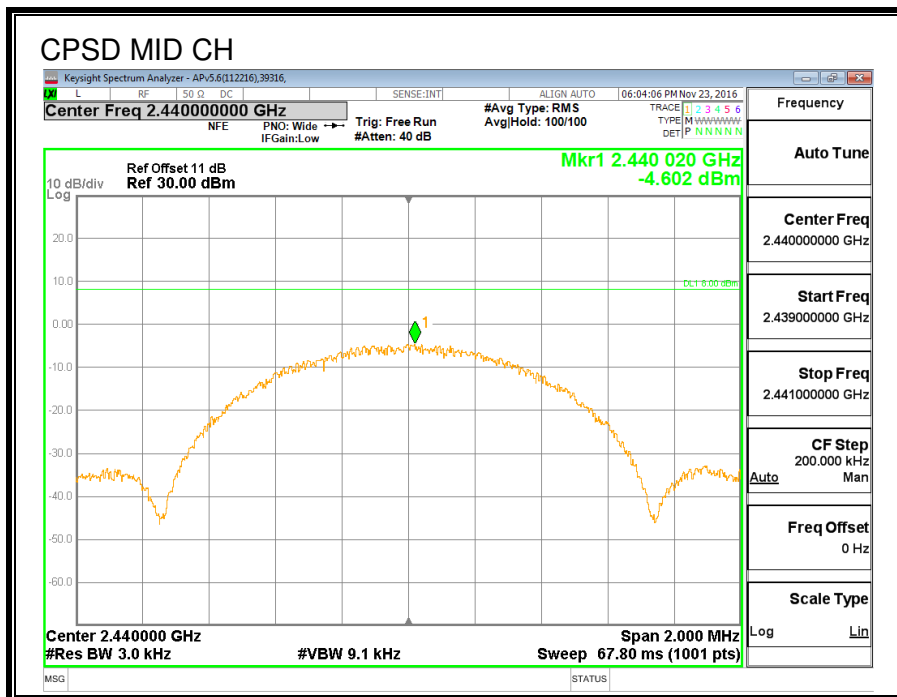
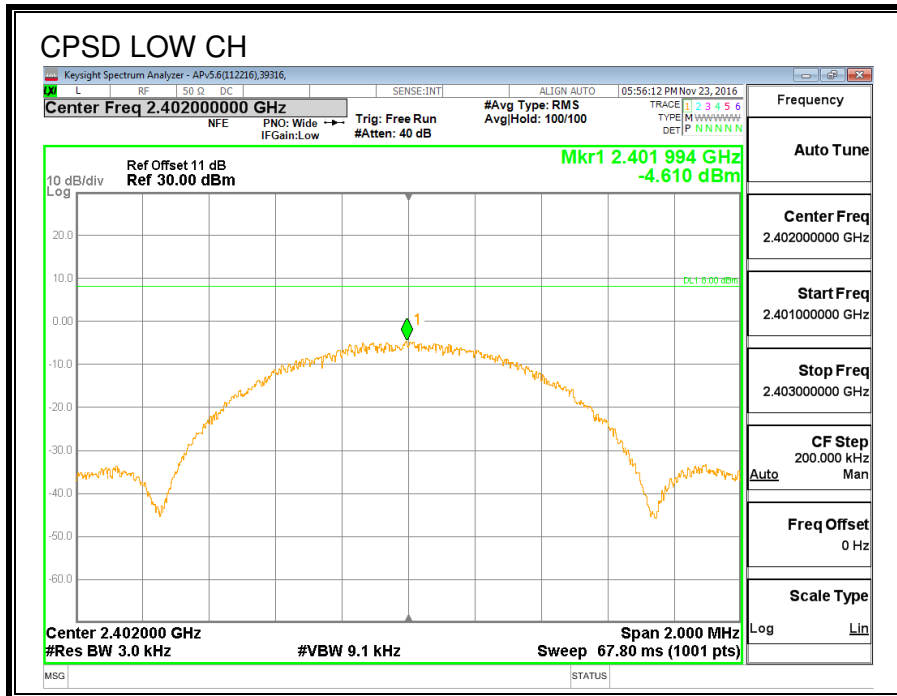

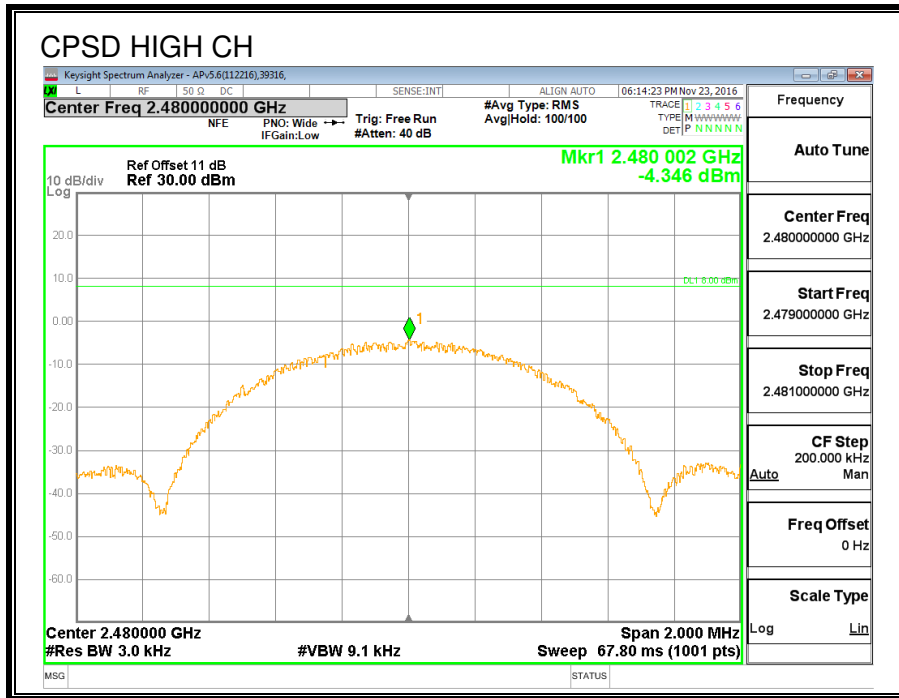

### 7.4.6. CONDUCTED BANDEDGE AND SPURIOUS EMISSIONS

#### LIMITS

FCC §15.247 (d)

IC RSS-247 (5.5)

Output power was measured based on the use of a peak measurement, therefore the required attenuation is 20 dB.

#### RESULTS

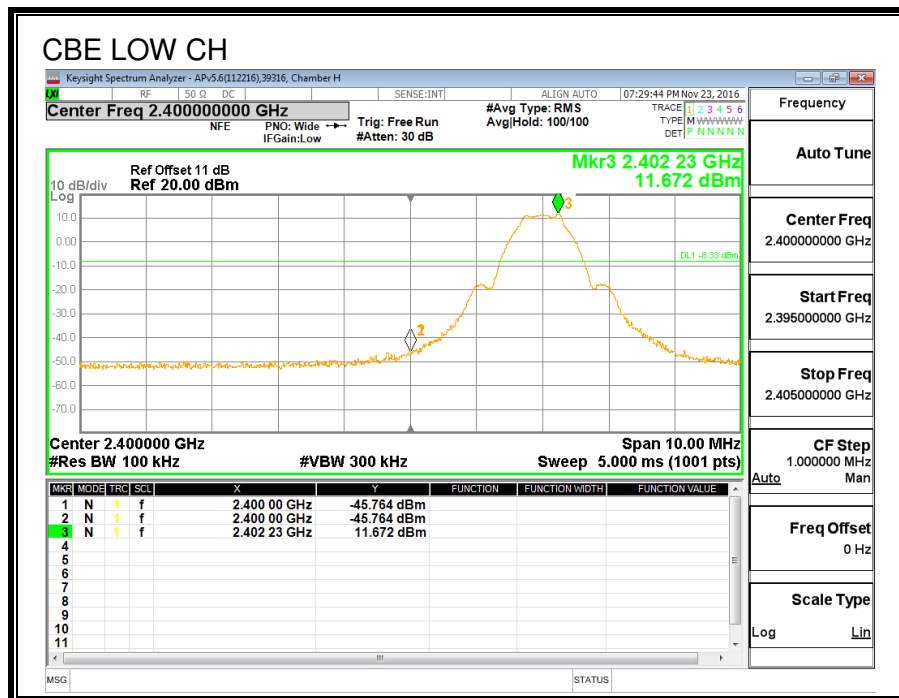

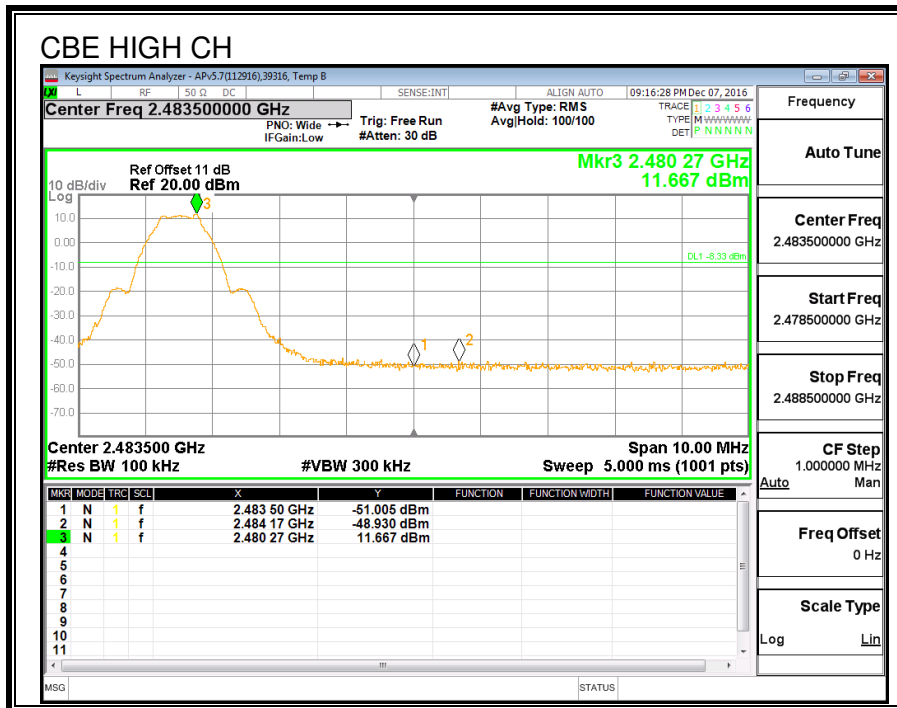
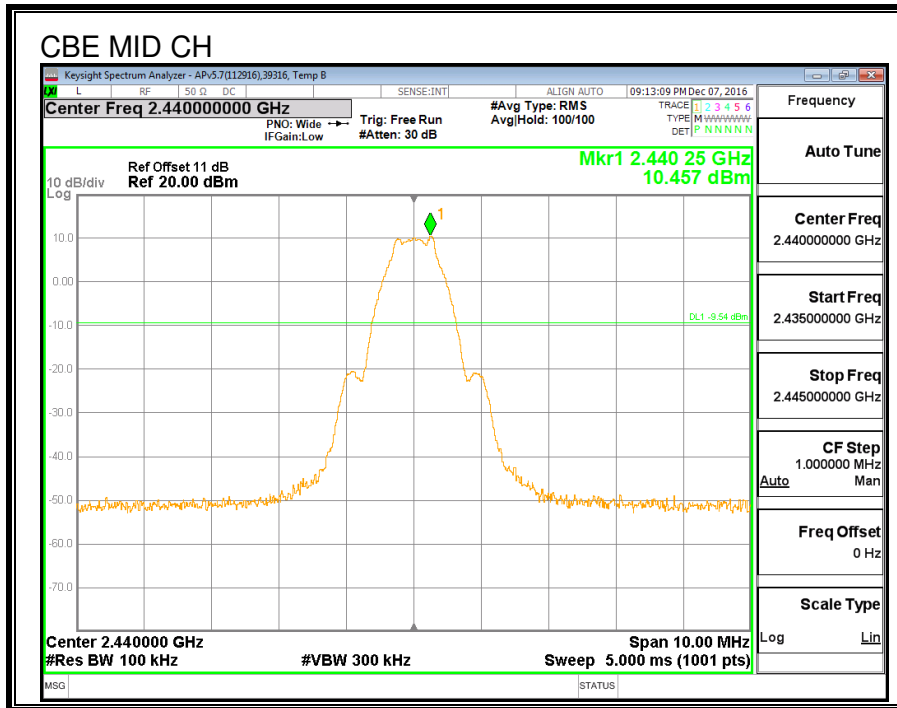

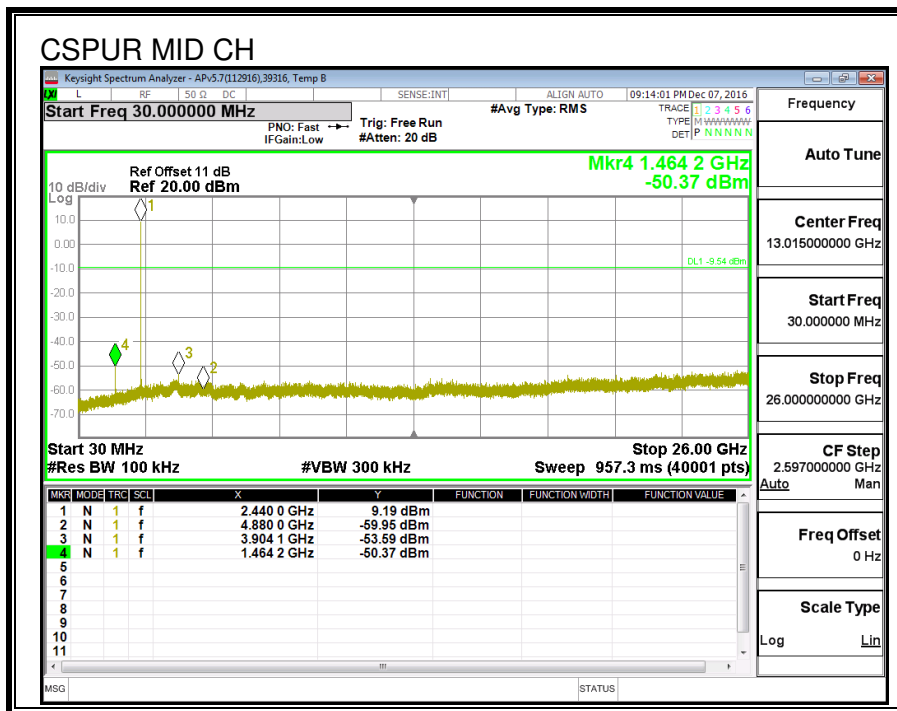
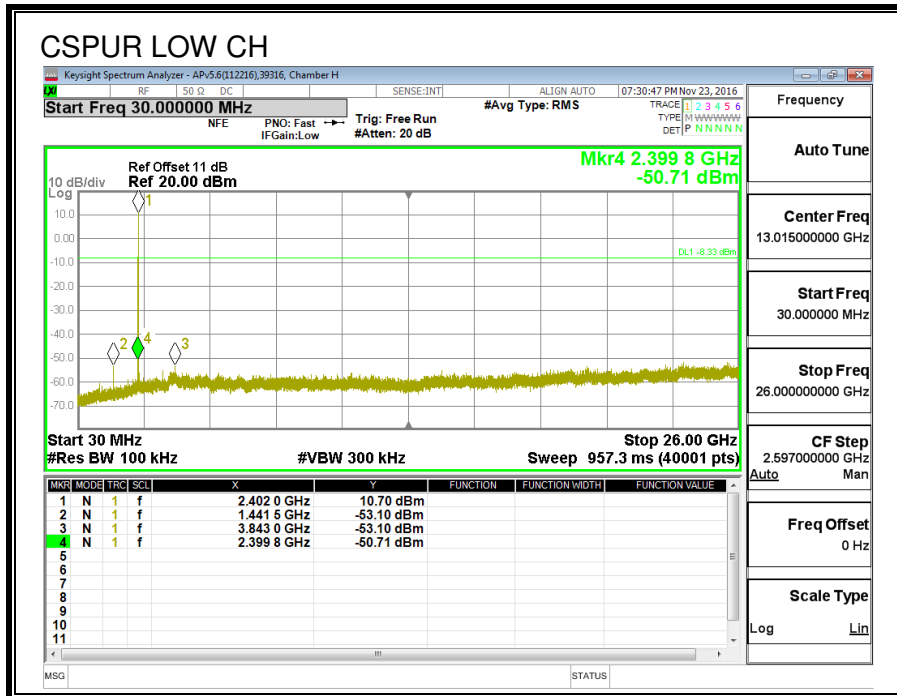

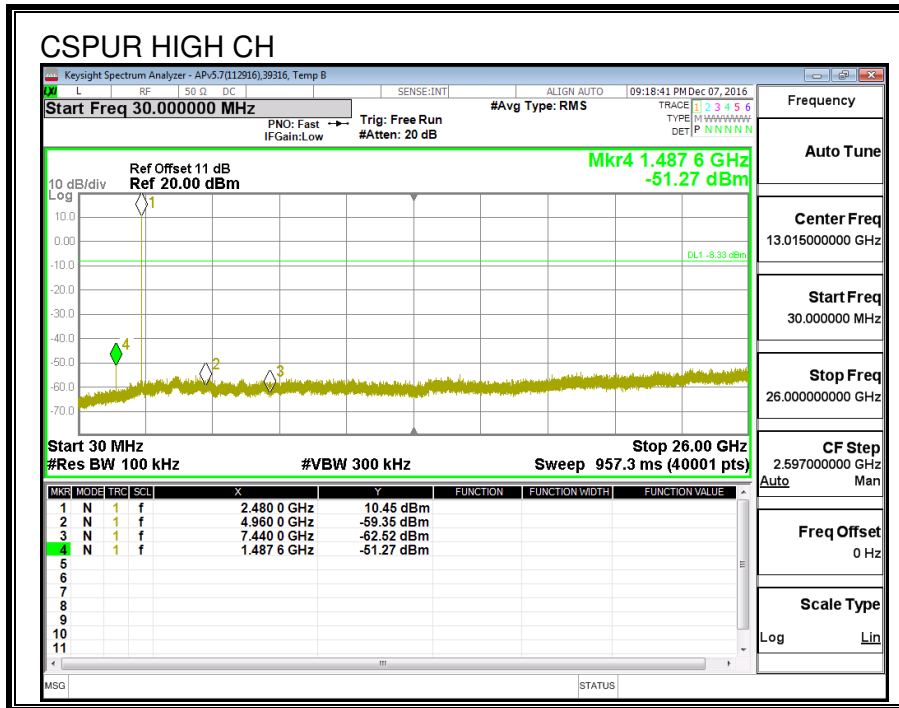

## 8. RADIATED TEST RESULTS

### 8.1. LIMITS AND PROCEDURE

#### LIMITS

FCC §15.205 and §15.209

IC RSS-GEN, Section 8.9 and 8.10.

Frequency Range (MHz)	Field Strength Limit (uV/m) at 3 m	Field Strength Limit (dBuV/m) at 3 m
30 - 88	100	40
88 - 216	150	43.5
216 - 960	200	46
Above 960	500	54

#### TEST PROCEDURE

The EUT is placed on a non-conducting table 80 cm above the ground plane for measurement below 1GHz; 1.5 m above the ground plane for measurement above 1GHz. The antenna to EUT distance is 3 meters. The EUT is configured in accordance with ANSI C63.10. The EUT is set to transmit in a continuous mode.

For measurements below 1 GHz the resolution bandwidth is set to 100 kHz for peak detection measurements or 120 kHz for quasi-peak detection measurements. Peak detection is used unless otherwise noted as quasi-peak.

For pre-scans above 1 GHz the resolution bandwidth is set to 1 MHz; the video bandwidth is set to 30 KHz for peak measurements.

For final measurements above 1 GHz the resolution bandwidth is set to 1 MHz; the video bandwidth is set to 3 MHz for peak measurements and as applicable for average measurements.

The frequency range of interest is monitored at a fixed antenna height and EUT azimuth. The EUT is rotated through 360 degrees to maximize emissions received. The antenna is scanned from 1 to 4 meters above the ground plane to further maximize the emission. Measurements are made with the antenna polarized in both the vertical and the horizontal positions.

## 8.2. HIGH POWER MODE

### 8.2.1. RESTRICTED BANDEDGE (LOW CHANNEL)

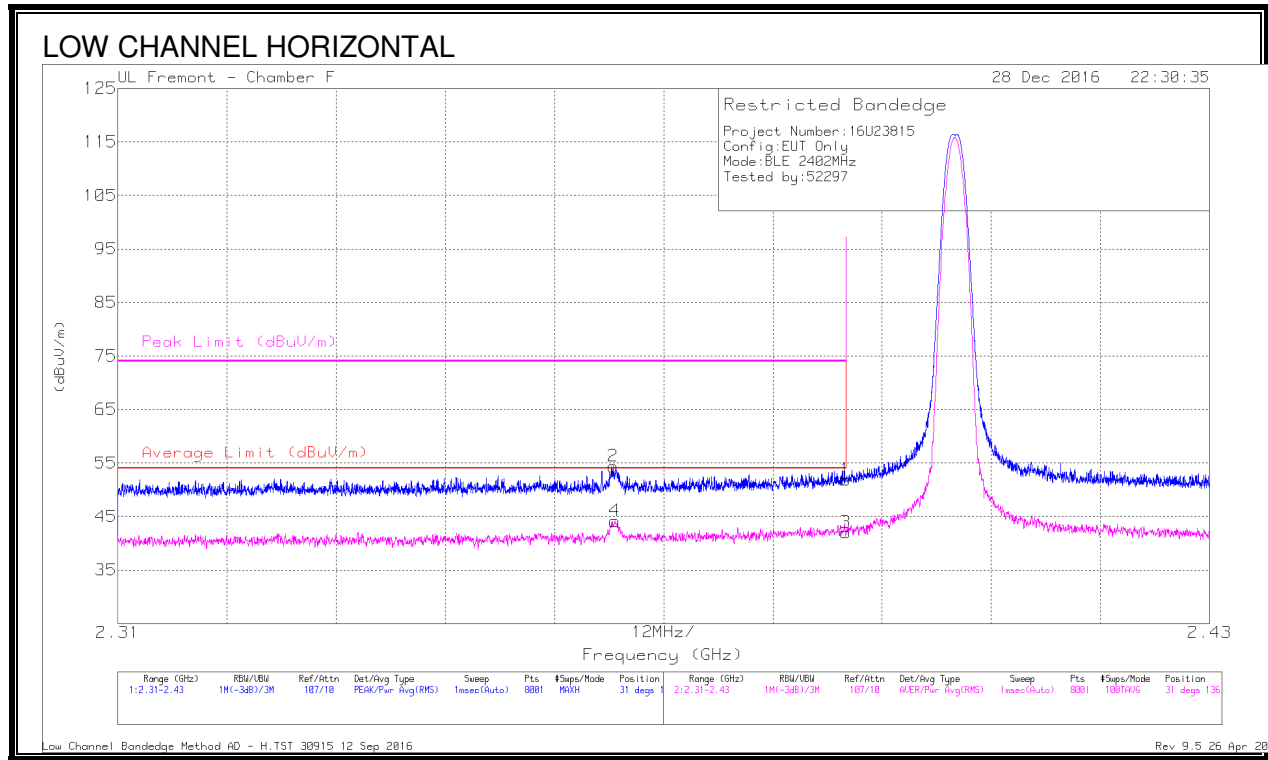

Marker	Frequency (GHz)	Meter Reading (dBuV)	Det	AF T344 (dB/m)	Amp/Cbl/Filtr/Pad (dB)	Corrected Reading (dBuV/m)	Average Limit (dBuV/m)	Margin (dB)	Peak Limit (dBuV/m)	PK Margin (dB)	Azimuth (Degs)	Height (cm)	Polarity
1	* 2.39	40.68	Pk	32.1	-20.9	51.88	-	-	74	-22.12	31	136	H
2	* 2.364	43.28	Pk	32	-20.9	54.38	-	-	74	-19.62	31	136	H
3	* 2.39	30.8	RMS	32.1	-20.9	42	54	-12	-	-	31	136	H
4	* 2.365	33.05	RMS	32	-20.9	44.15	54	-9.85	-	-	31	136	H

\* - indicates frequency in CFR47 Pt 15 / IC RSS-Restricted Band

Pk - Peak detector

RMS - RMS detection

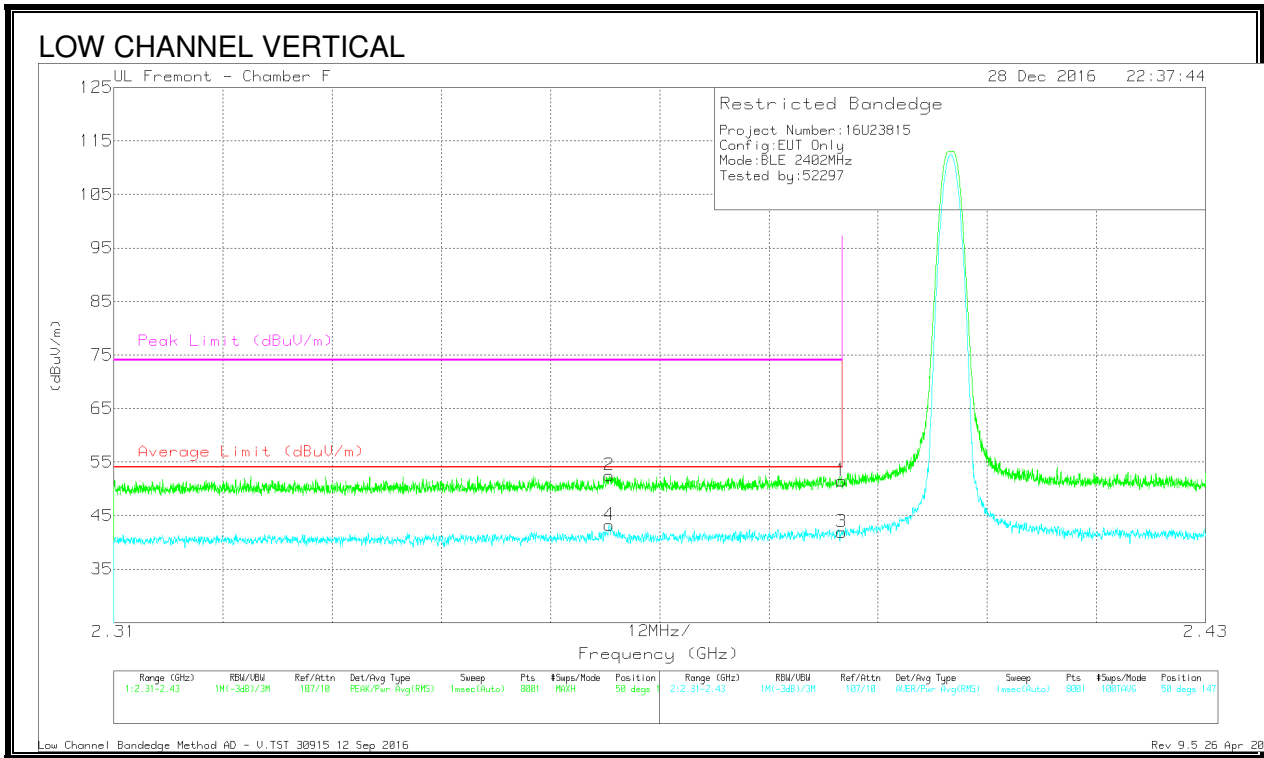

Marker	Frequency (GHz)	Meter Reading (dBuV)	Det	AF T344 (dB/m)	Amp/Cbl/Filtr/Pad (dB)	Corrected Reading (dBuV/m)	Average Limit (dBuV/m)	Margin (dB)	Peak Limit (dBuV/m)	PK Margin (dB)	Azimuth (Degs)	Height (cm)	Polarity
1	* 2.39	40.34	Pk	32.1	-20.9	51.54	-	-	74	-22.46	50	147	V
2	* 2.364	41.43	Pk	32	-20.9	52.53	-	-	74	-21.47	50	147	V
3	* 2.39	30.73	RMS	32.1	-20.9	41.93	54	-12.07	-	-	50	147	V
4	* 2.364	32.13	RMS	32	-20.9	43.23	54	-10.77	-	-	50	147	V

\* - indicates frequency in CFR47 Pt 15 / IC RSS-Restricted Band  
 Pk - Peak detector  
 RMS - RMS detection

### 8.2.2. AUTHORIZED BANDEDGE (HIGH CHANNEL)

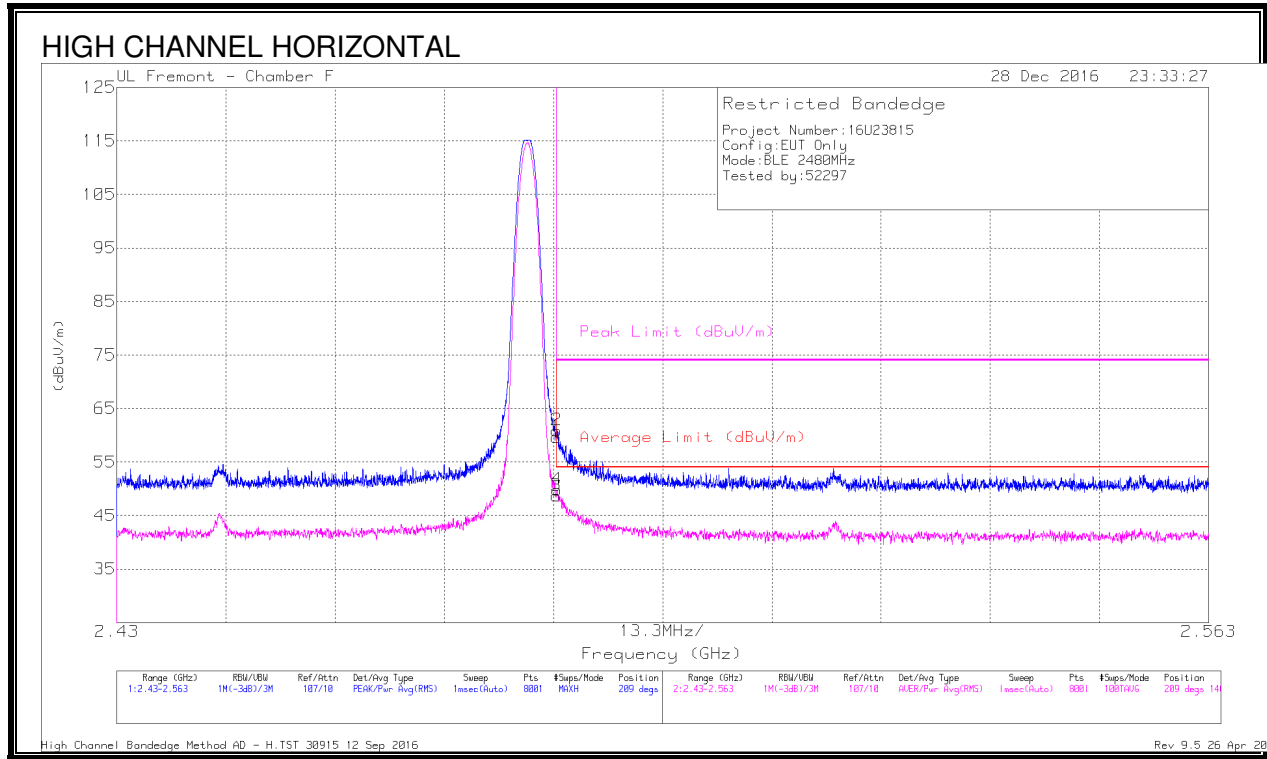

Marker	Frequency (GHz)	Meter Reading (dBuV)	Det	AF T344 (dB/m)	Amp/Cbl/Filtr/Pad (dB)	Corrected Reading (dBuV/m)	Average Limit (dBuV/m)	Margin (dB)	Peak Limit (dBuV/m)	PK Margin (dB)	Azimuth (Degs)	Height (cm)	Polarity
1	* 2.484	48.37	Pk	32.3	-21	59.67	-	-	74	-14.33	209	140	H
2	* 2.484	49.62	Pk	32.3	-21	60.92	-	-	74	-13.08	209	140	H
3	* 2.484	37.39	RMS	32.3	-21	48.69	54	-5.31	-	-	209	140	H
4	* 2.484	38.52	RMS	32.3	-21	49.82	54	-4.18	-	-	209	140	H

\* - indicates frequency in CFR47 Pt 15 / IC RSS-Restricted Band

Pk - Peak detector

RMS - RMS detection

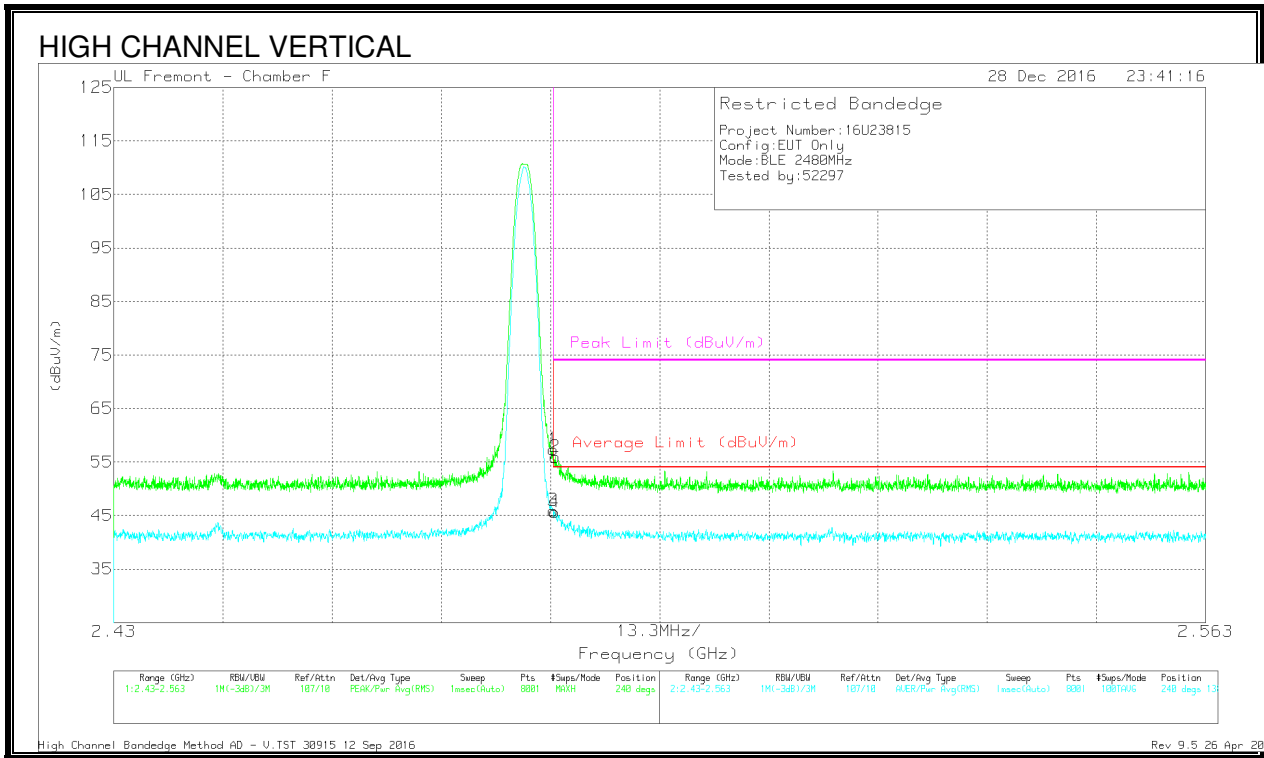

Marker	Frequency (GHz)	Meter Reading (dBuV)	Det	AF T344 (dB/m)	Amp/Cbl/Filtr/Pad (dB)	Corrected Reading (dBuV/m)	Average Limit (dBuV/m)	Margin (dB)	Peak Limit (dBuV/m)	PK Margin (dB)	Azimuth (Degs)	Height (cm)	Polarity
1	* 2.484	46.04	Pk	32.3	-21	57.34	-	-	74	-16.66	240	138	V
2	* 2.484	44.66	Pk	32.3	-21	55.96	-	-	74	-18.04	240	138	V
3	* 2.484	34.61	RMS	32.3	-21	45.91	54	-8.09	-	-	240	138	V
4	* 2.484	34.38	RMS	32.3	-21	45.68	54	-8.32	-	-	240	138	V

\* - indicates frequency in CFR47 Pt 15 / IC RSS-Restricted Band

Pk - Peak detector

RMS - RMS detection

### 8.2.3. HARMONICS AND SPURIOUS EMISSIONS

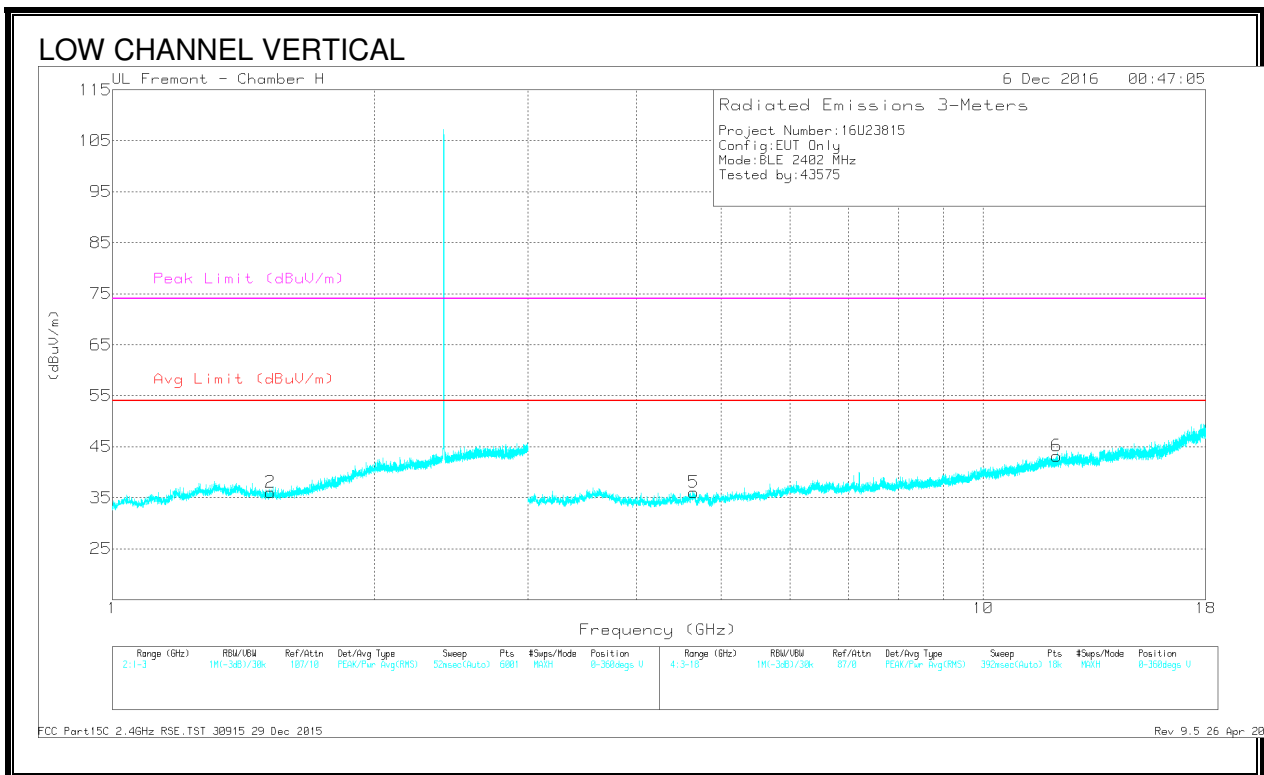
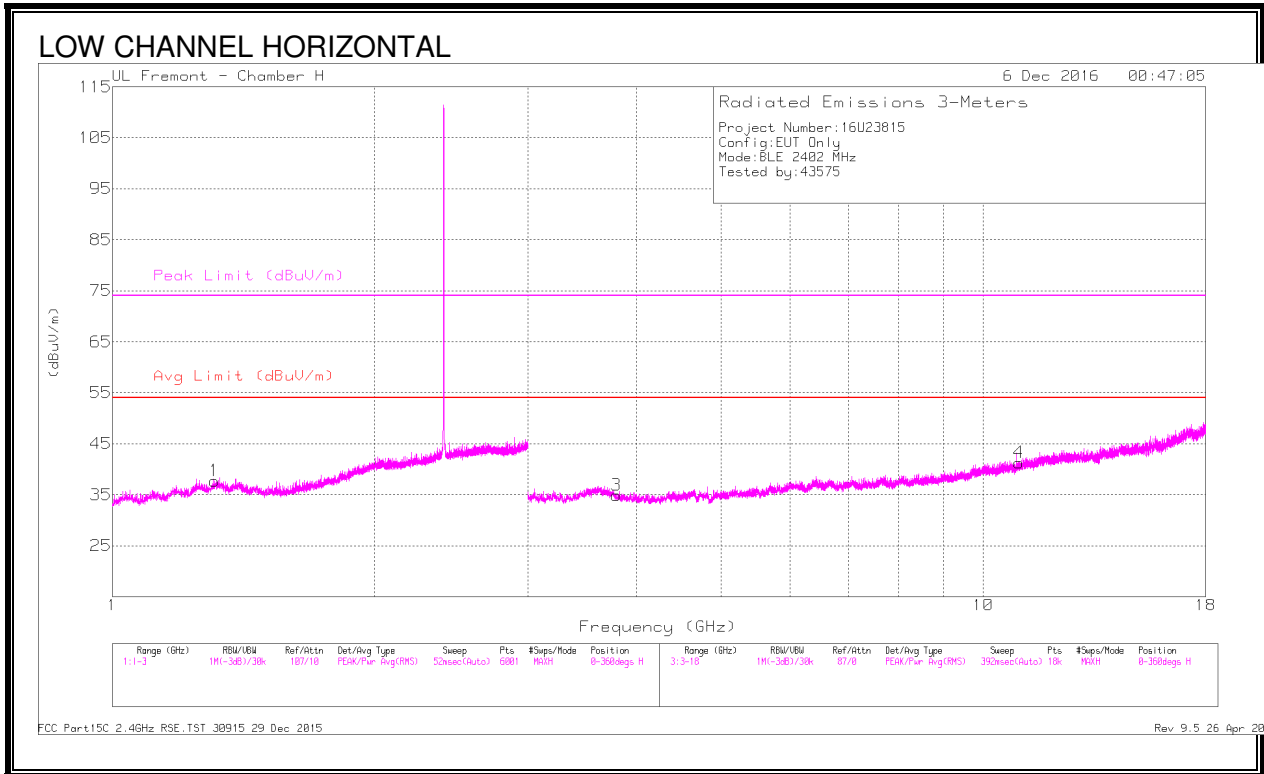

Marker	Frequency (GHz)	Meter Reading (dBuV)	Det	AF T120 (dB/m)	Amp/Cbl/Filtr/Pad (dB)	Corrected Reading (dBuV/m)	Avg Limit (dBuV/m)	Margin (dB)	Peak Limit (dBuV/m)	PK Margin (dB)	Azimuth (Degs)	Height (cm)	Polarity
1	* 1.312	37.53	PK2	29.7	-22.1	45.13	-	-	74	-28.87	91	229	H
	* 1.313	23.51	MAv1	29.7	-22.1	31.11	54	-22.89	-	-	91	229	H
2	* 1.519	37.54	PK2	28	-21.3	44.24	-	-	74	-29.76	126	174	V
	* 1.519	22.76	MAv1	28	-21.3	29.46	54	-24.54	-	-	126	174	V
3	* 3.788	43.28	PK2	34.2	-35.6	41.88	-	-	74	-32.12	51	131	H
	* 3.789	32.63	MAv1	34.1	-35.7	31.03	54	-22.97	-	-	51	131	H
4	* 10.985	37.75	PK2	38.3	-27.3	48.75	-	-	74	-25.25	179	376	H
	* 10.985	26.29	MAv1	38.3	-27.3	37.29	54	-16.71	-	-	179	376	H
5	* 4.652	43.3	PK2	34	-34.3	43	-	-	74	-31	183	362	V
	* 4.653	32.34	MAv1	34	-34.3	32.04	54	-21.96	-	-	183	362	V
6	* 12.138	36.78	PK2	39.3	-26.2	49.88	-	-	74	-24.12	219	280	V
	* 12.136	25.25	MAv1	39.3	-26.2	38.35	54	-15.65	-	-	219	280	V

\* - indicates frequency in CFR47 Pt 15 / IC RSS-Restricted Band

PK2 - KDB558074 Method: Maximum Peak

MAv1 - KDB558074 Option 1 Maximum RMS Average

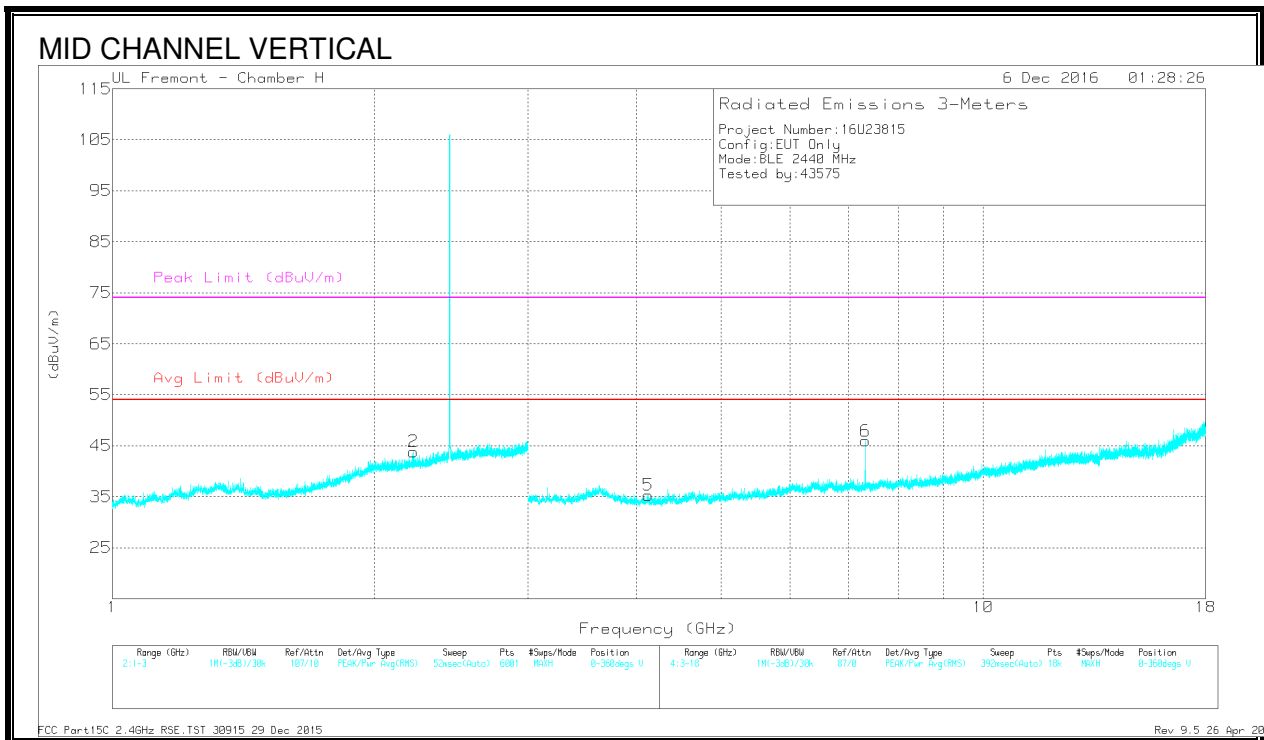
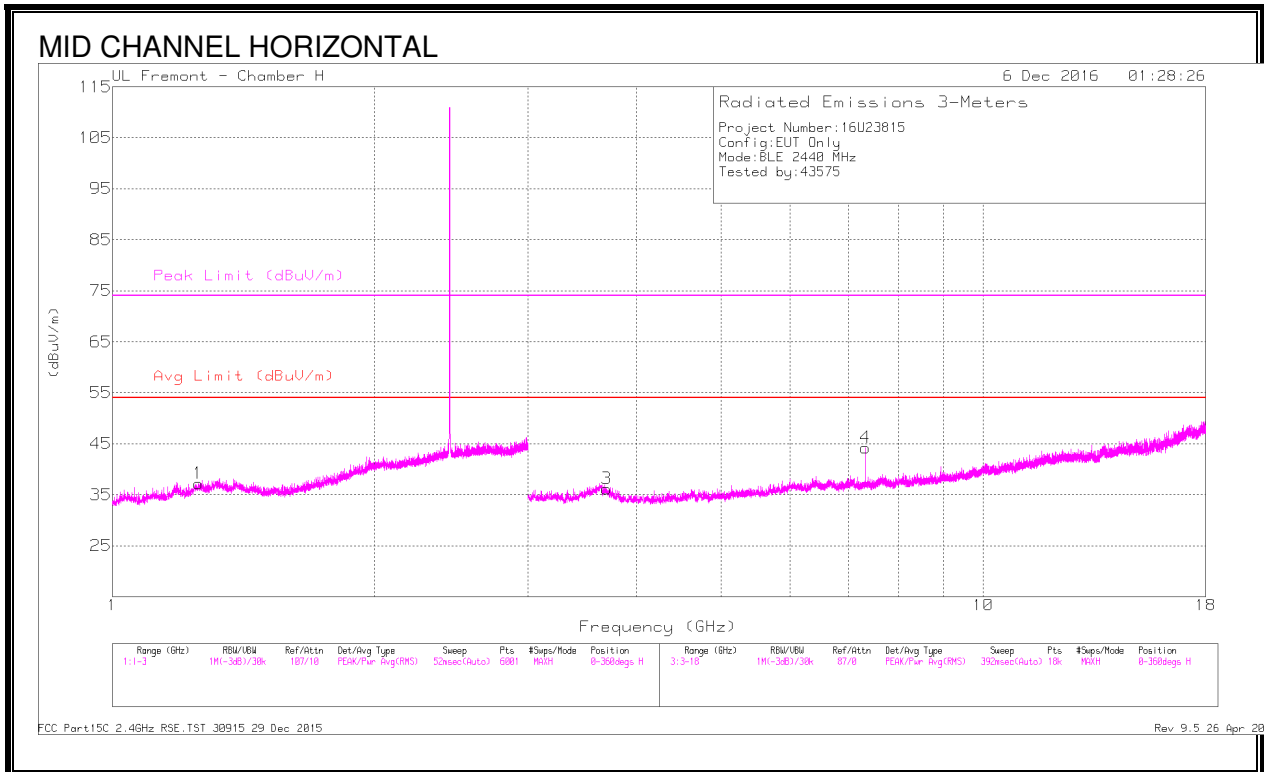

Marker	Frequency (GHz)	Meter Reading (dBuV)	Det	AF T120 (dB/m)	Amp/Cbl/Filtr/Pad (dB)	Corrected Reading (dBuV/m)	Avg Limit (dBuV/m)	Margin (dB)	Peak Limit (dBuV/m)	PK Margin (dB)	Azimuth (Degs)	Height (cm)	Polarity
1	* 1.257	38.29	PK2	29.3	-22.3	45.29	-	-	74	-28.71	289	389	H
	* 1.257	24.35	MAv1	29.3	-22.3	31.35	54	-22.65	-	-	289	389	H
2	* 2.22	38.44	PK2	31.7	-20.1	50.04	-	-	74	-23.96	12	134	V
	* 2.218	22.26	MAv1	31.7	-20.1	33.86	54	-20.14	-	-	12	134	V
3	* 3.693	44.33	PK2	34.9	-35.9	43.33	-	-	74	-30.67	153	188	H
	* 3.693	33.29	MAv1	34.9	-35.9	32.29	54	-21.71	-	-	153	188	H
4	* 7.32	47	PK2	35.7	-31.2	51.5	-	-	74	-22.5	19	189	H
	* 7.321	40.82	MAv1	35.7	-31.2	45.32	54	-8.68	-	-	19	189	H
5	* 4.121	42.85	PK2	33.5	-34.6	41.75	-	-	74	-32.25	223	235	V
	* 4.124	31.87	MAv1	33.5	-34.5	30.87	54	-23.13	-	-	223	235	V
6	* 7.319	48.16	PK2	35.7	-31.2	52.66	-	-	74	-21.34	280	257	V
	* 7.319	42.76	MAv1	35.7	-31.2	47.26	54	-6.74	-	-	280	257	V

\* - indicates frequency in CFR47 Pt 15 / IC RSS-Restricted Band

PK2 - KDB558074 Method: Maximum Peak

MAv1 - KDB558074 Option 1 Maximum RMS Average

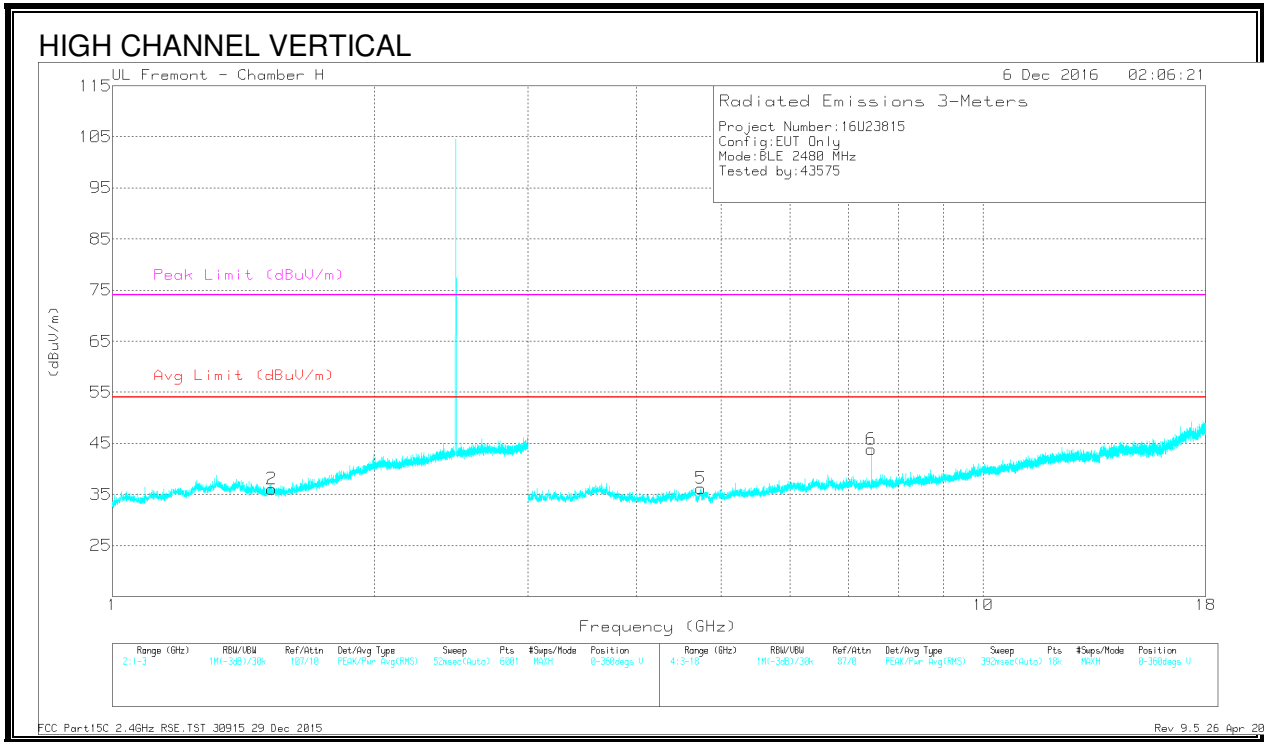
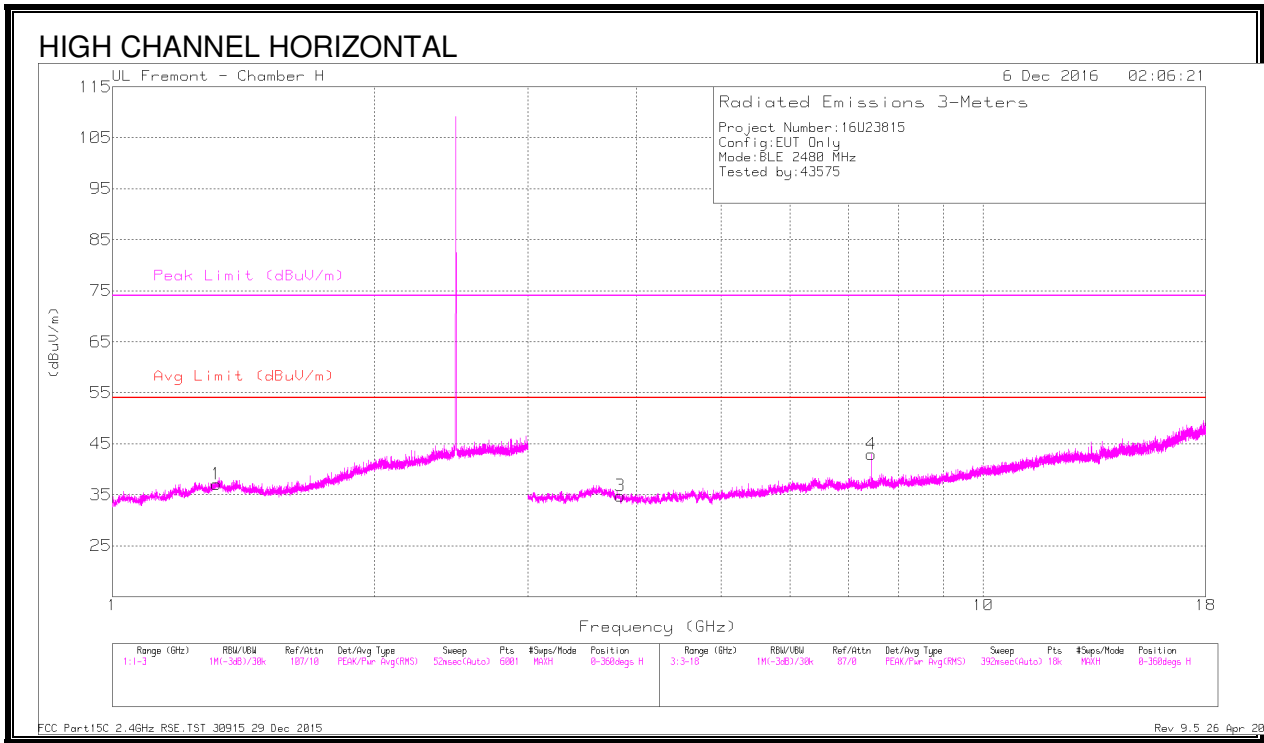

Marker	Frequency (GHz)	Meter Reading (dBuV)	Det	AF T120 (dB/m)	Amp/Cbl/Filtr/Pad (dB)	Corrected Reading (dBuV/m)	Avg Limit (dBuV/m)	Margin (dB)	Peak Limit (dBuV/m)	PK Margin (dB)	Azimuth (Degs)	Height (cm)	Polarity
1	* 1.315	37.81	PK2	29.7	-22.1	45.41	-	-	74	-28.59	358	324	H
	* 1.318	23.63	MAv1	29.7	-22.1	31.23	54	-22.77	-	-	358	324	H
2	* 1.526	37.22	PK2	28	-21.3	43.92	-	-	74	-30.08	352	218	V
	* 1.527	22.68	MAv1	28	-21.4	29.28	54	-24.72	-	-	352	218	V
3	* 3.83	43.49	PK2	33.9	-35.3	42.09	-	-	74	-31.91	5	352	H
	* 3.833	32.46	MAv1	33.9	-35.3	31.06	54	-22.94	-	-	5	352	H
4	* 7.44	45.65	PK2	35.7	-31.3	50.05	-	-	74	-23.95	53	315	H
	* 7.441	38.8	MAv1	35.7	-31.3	43.2	54	-10.8	-	-	53	315	H
5	* 4.739	43.33	PK2	34	-34.7	42.63	-	-	74	-31.37	169	117	V
	* 4.739	32.15	MAv1	34	-34.7	31.45	54	-22.55	-	-	169	117	V
6	* 7.44	45.61	PK2	35.7	-31.3	50.01	-	-	74	-23.99	97	206	V
	* 7.439	39.04	MAv1	35.7	-31.3	43.44	54	-10.56	-	-	97	206	V

\* - indicates frequency in CFR47 Pt 15 / IC RSS-Restricted Band

PK2 - KDB558074 Method: Maximum Peak

MAv1 - KDB558074 Option 1 Maximum RMS Average

### 8.3. LOW POWER MODE

#### 8.3.1. RESTRICTED BANDEDGE (LOW CHANNEL)

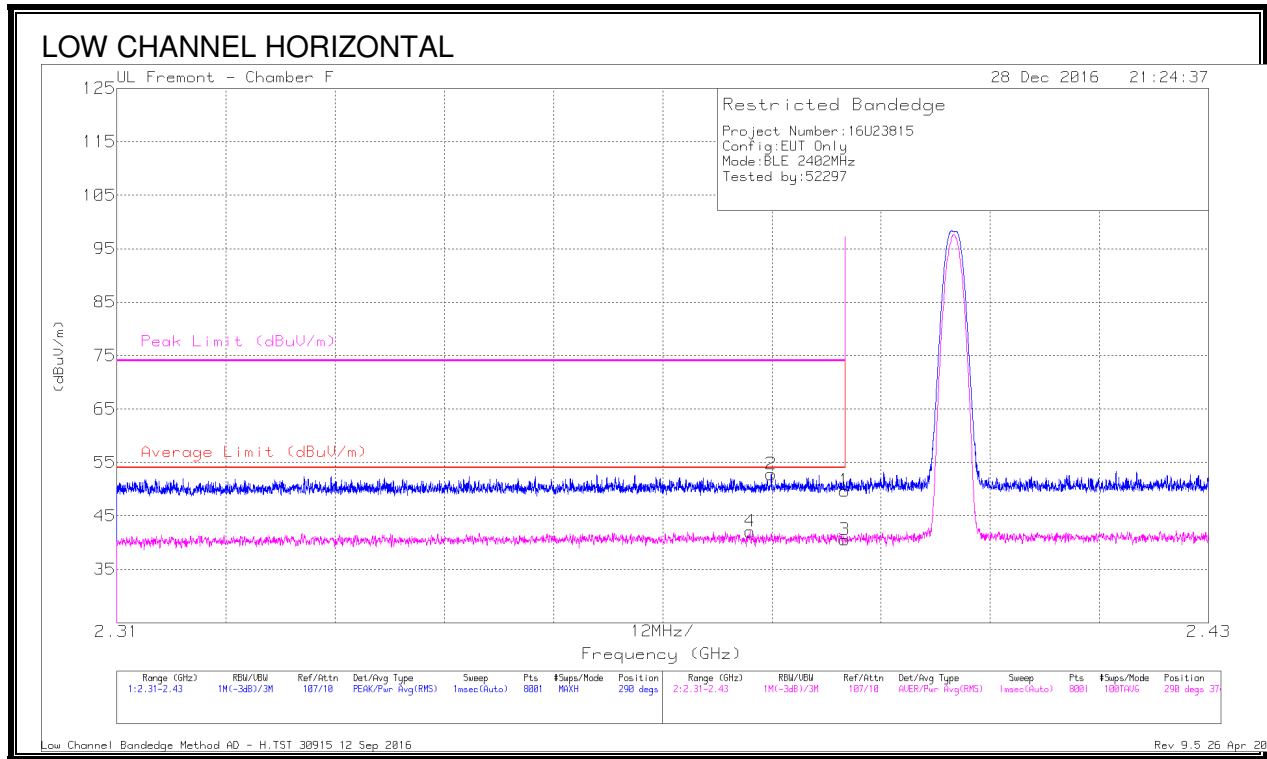

Marker	Frequency (GHz)	Meter Reading (dBuV)	Det	AF T344 (dB/m)	Amp/Cbl/Filtr/Pad (dB)	Corrected Reading (dBuV/m)	Average Limit (dBuV/m)	Margin (dB)	Peak Limit (dBuV/m)	PK Margin (dB)	Azimuth (Degs)	Height (cm)	Polarity
1	* 2.39	38.53	Pk	32.1	-20.9	49.73	-	-	74	-24.27	290	374	H
2	* 2.382	41.6	Pk	32.1	-20.9	52.8	-	-	74	-21.2	290	374	H
3	* 2.39	29.34	RMS	32.1	-20.9	40.54	54	-13.46	-	-	290	374	H
4	* 2.38	30.89	RMS	32.1	-20.9	42.09	54	-11.91	-	-	290	374	H

\* - indicates frequency in CFR47 Pt 15 / IC RSS-Restricted Band

Pk - Peak detector

RMS - RMS detection

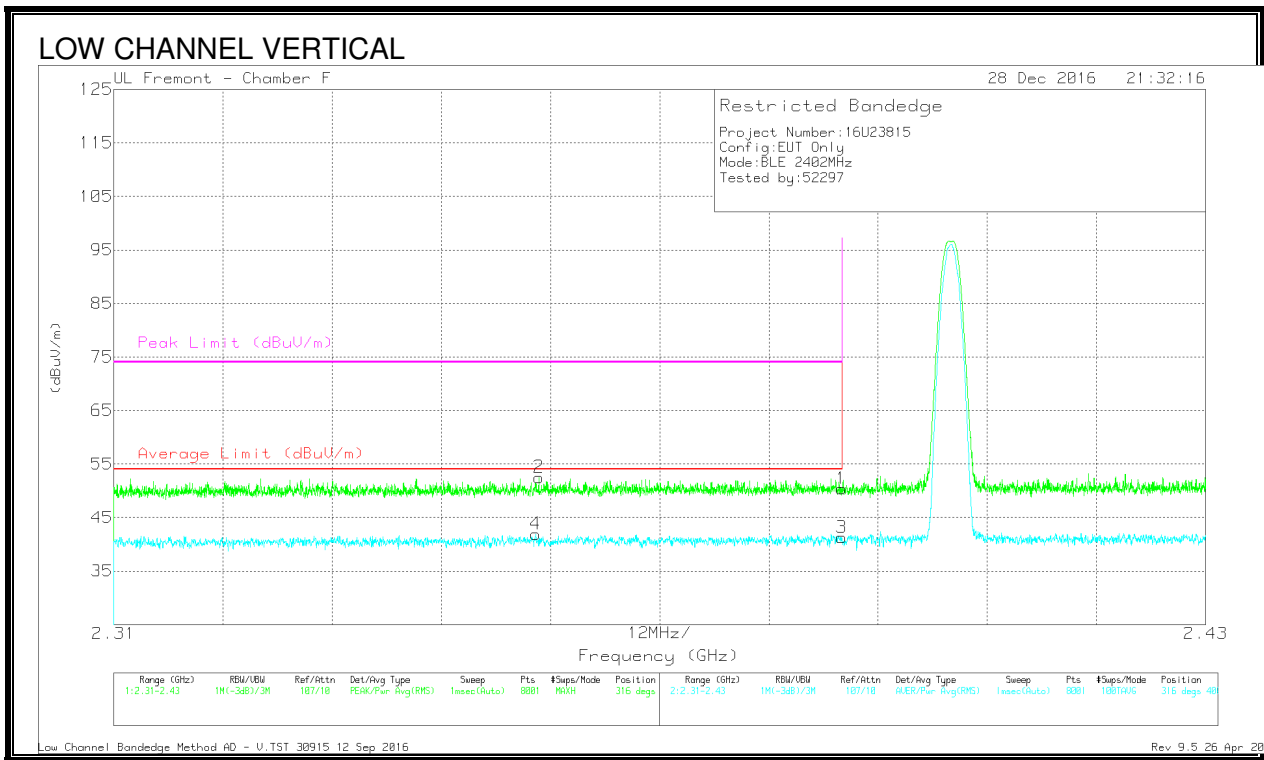

Marker	Frequency (GHz)	Meter Reading (dBuV)	Det	AF T344 (dB/m)	Amp/Cbl/Filtr/ Pad (dB)	Corrected Reading (dBuV/m)	Average Limit (dBuV/m)	Margin (dB)	Peak Limit (dBuV/m)	PK Margin (dB)	Azimuth (Degs)	Height (cm)	Polarity
1	* 2.39	39.19	Pk	32.1	-20.9	50.39	-	-	74	-23.61	316	400	V
2	* 2.357	41.39	Pk	32	-20.9	52.49	-	-	74	-21.51	316	400	V
3	* 2.39	30.07	RMS	32.1	-20.9	41.27	54	-12.73	-	-	316	400	V
4	* 2.356	30.81	RMS	32	-20.9	41.91	54	-12.09	-	-	316	400	V

\* - indicates frequency in CFR47 Pt 15 / IC RSS-Restricted Band  
 Pk - Peak detector  
 RMS - RMS detection

### 8.3.2. AUTHORIZED BANDEGE (HIGH CHANNEL)

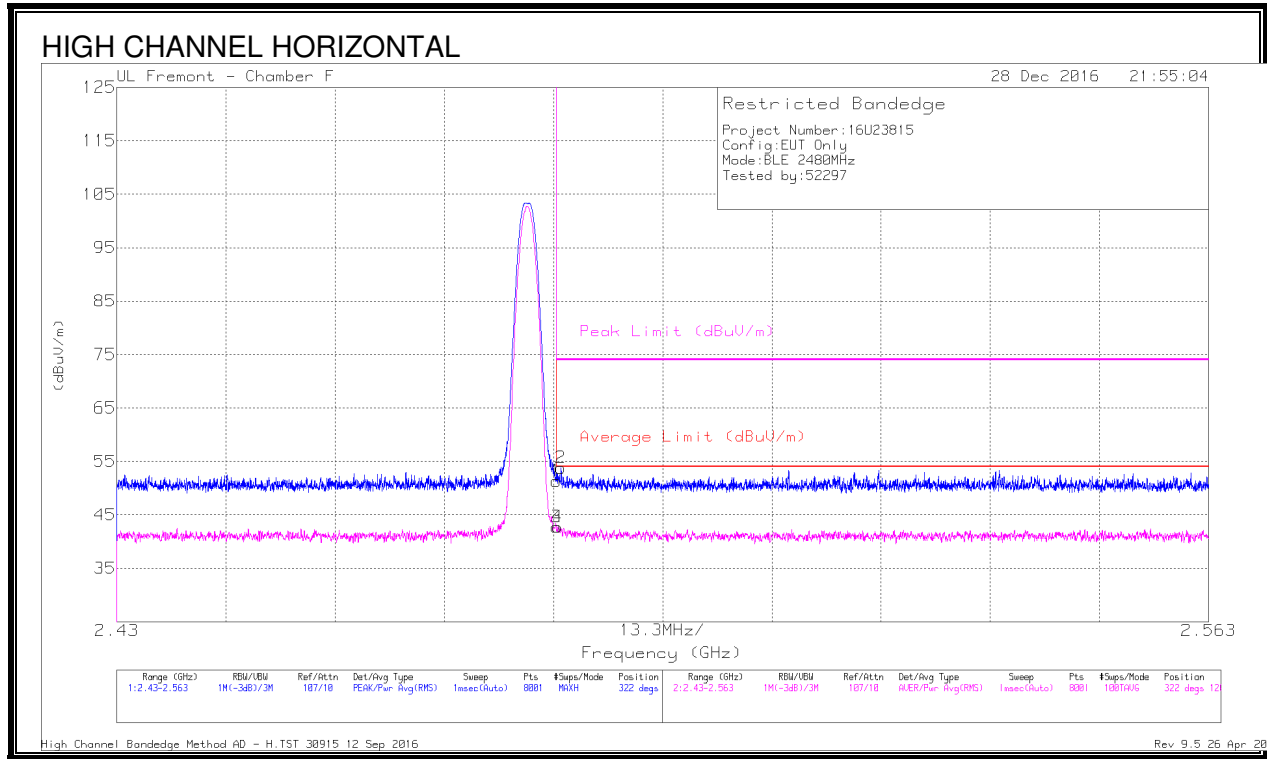

Marker	Frequency (GHz)	Meter Reading (dBuV)	Det	AF T344 (dB/m)	Amp/Cbl/Filtr/ Pad (dB)	Corrected Reading (dBuV/m)	Average Limit (dBuV/m)	Margin (dB)	Peak Limit (dBuV/m)	PK Margin (dB)	Azimuth (Degs)	Height (cm)	Polarity
1	* 2.484	40.02	Pk	32.3	-21	51.32	-	-	74	-22.68	322	120	H
2	* 2.484	42.47	Pk	32.3	-21	53.77	-	-	74	-20.23	322	120	H
3	* 2.484	31.41	RMS	32.3	-21	42.71	54	-11.29	-	-	322	120	H
4	* 2.484	31.43	RMS	32.3	-21	42.73	54	-11.27	-	-	322	120	H

\* - indicates frequency in CFR47 Pt 15 / IC RSS-Restricted Band  
 Pk - Peak detector  
 RMS - RMS detection

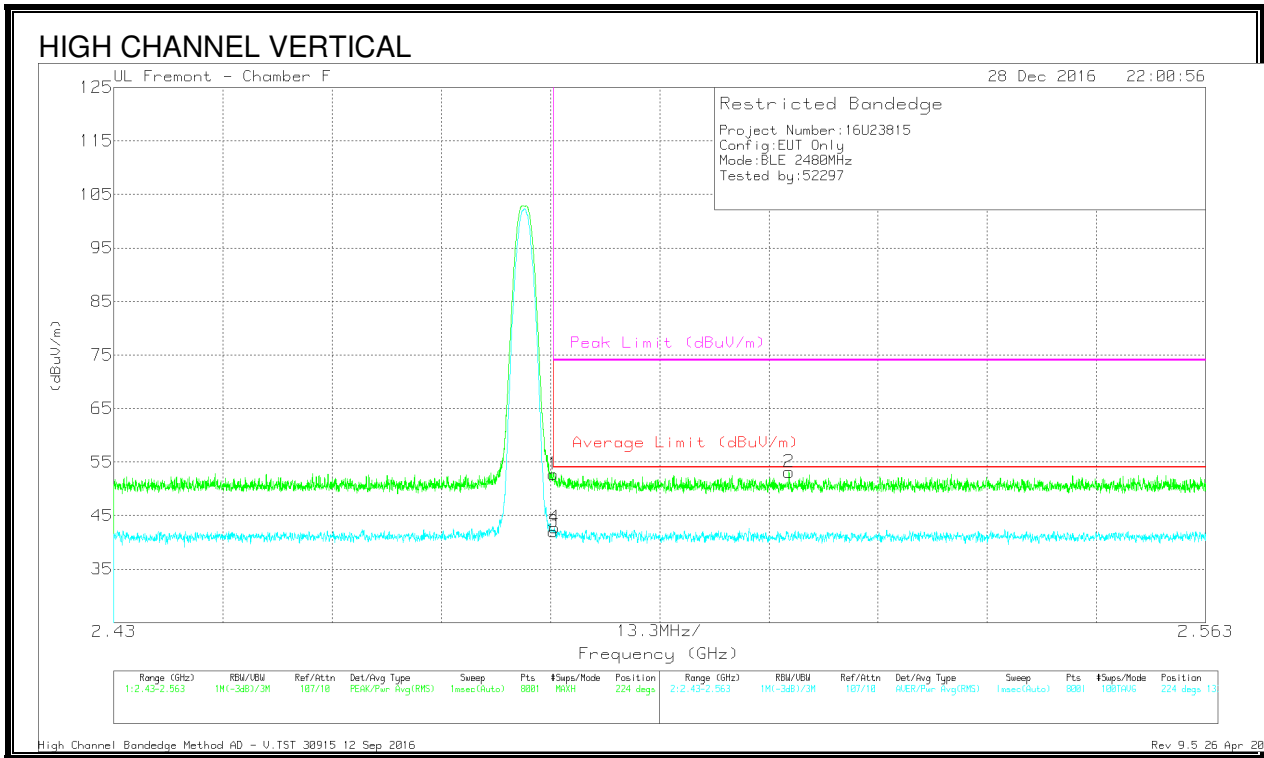

Marker	Frequency (GHz)	Meter Reading (dBuV)	Det	AF T344 (dB/m)	Amp/Cbl/Filtr/Pad (dB)	Corrected Reading (dBuV/m)	Average Limit (dBuV/m)	Margin (dB)	Peak Limit (dBuV/m)	PK Margin (dB)	Azimuth (Degs)	Height (cm)	Polarity
1	* 2.484	41.42	Pk	32.3	-21	52.72	-	-	74	-21.28	224	133	V
2	2.512	41.85	Pk	32.3	-21	53.15	-	-	74	-20.85	224	133	V
3	* 2.484	30.69	RMS	32.3	-21	41.99	54	-12.01	-	-	224	133	V
4	* 2.484	31.46	RMS	32.3	-21	42.76	54	-11.24	-	-	224	133	V

\* - indicates frequency in CFR47 Pt 15 / IC RSS-Restricted Band

Pk - Peak detector

RMS - RMS detection

### 8.3.3. HARMONICS AND SPURIOUS EMISSIONS

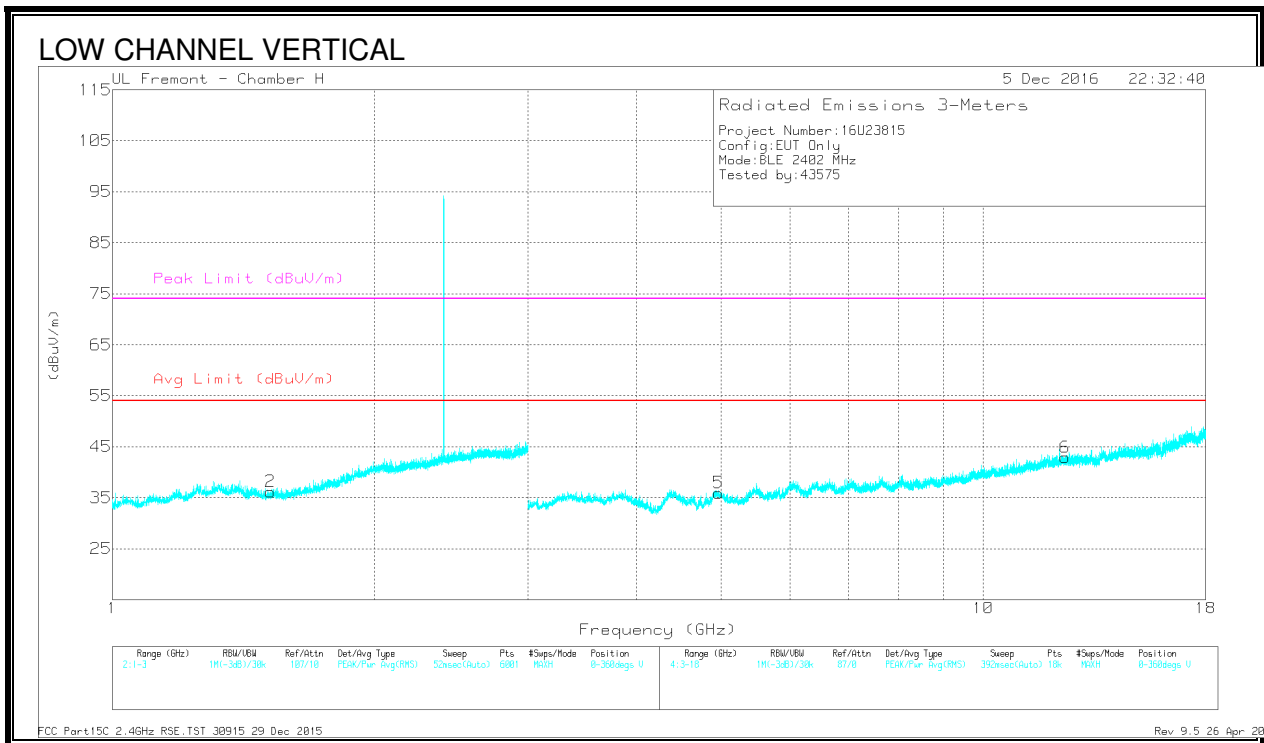
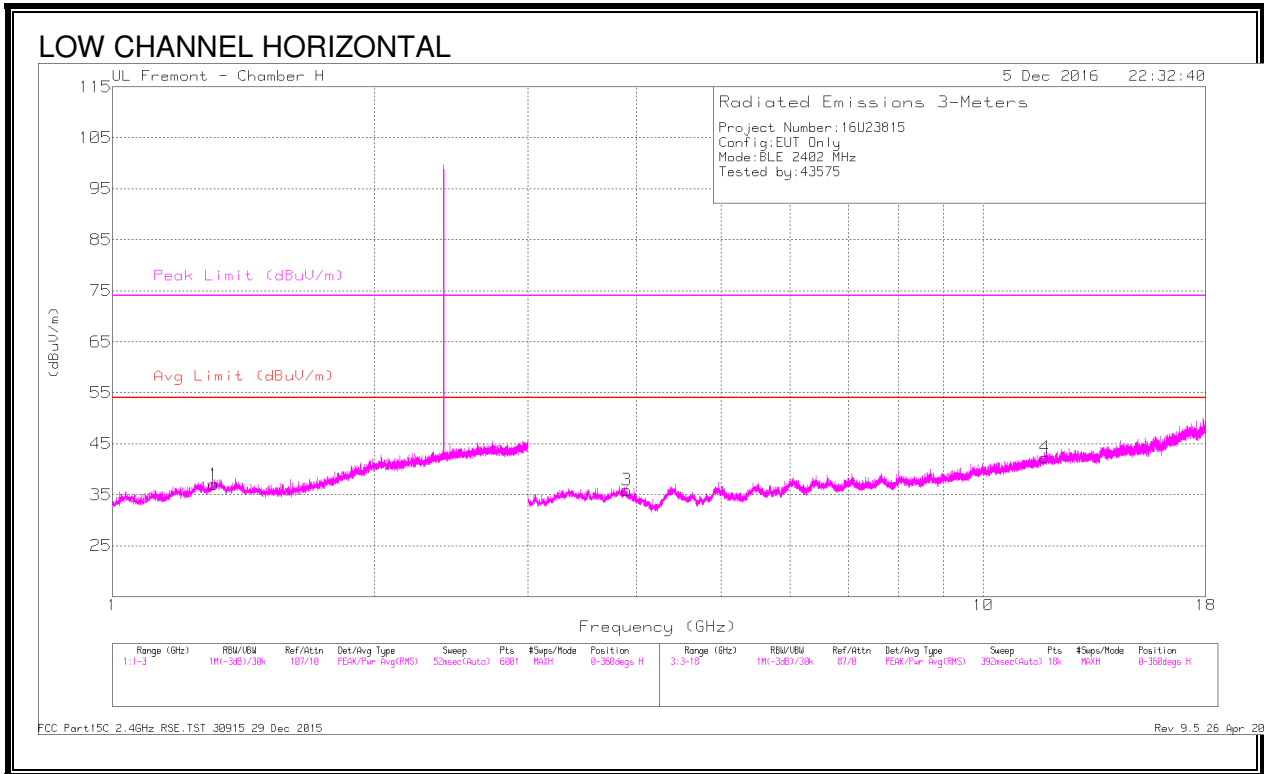

Marker	Frequency (GHz)	Meter Reading (dBuV)	Det	AF T120 (dB/m)	Amp/Cbl/Filtr/Pad (dB)	Corrected Reading (dBuV/m)	Avg Limit (dBuV/m)	Margin (dB)	Peak Limit (dBuV/m)	PK Margin (dB)	Azimuth (Degs)	Height (cm)	Polarity
1	* 1.309	37.14	PK2	29.7	-22.1	44.74	-	-	74	-29.26	324	118	H
	* 1.31	23.38	MAv1	29.7	-22.1	30.98	54	-23.02	-	-	324	118	H
2	* 1.519	37.5	PK2	28	-21.3	44.2	-	-	74	-29.8	124	230	V
	* 1.517	22.72	MAv1	28	-21.3	29.42	54	-24.58	-	-	124	230	V
3	* 3.896	43.54	PK2	33.6	-35.1	42.04	-	-	74	-31.96	74	333	H
	* 3.895	32.62	MAv1	33.6	-35.1	31.12	54	-22.88	-	-	74	333	H
4	* 11.773	37.07	PK2	39.1	-26.3	49.87	-	-	74	-24.13	8	381	H
	* 11.775	25.58	MAv1	39.1	-26.4	38.28	54	-15.72	-	-	8	381	H
5	* 4.961	43.5	PK2	34	-34.2	43.3	-	-	74	-30.7	106	388	V
	* 4.961	32.39	MAv1	34	-34.2	32.19	54	-21.81	-	-	106	388	V
6	* 12.41	37.01	PK2	39.3	-26.3	50.01	-	-	74	-23.99	136	320	V
	* 12.41	25.68	MAv1	39.3	-26.3	38.68	54	-15.32	-	-	136	320	V

\* - indicates frequency in CFR47 Pt 15 / IC RSS-Restricted Band

PK2 - KDB558074 Method: Maximum Peak

MAv1 - KDB558074 Option 1 Maximum RMS Average

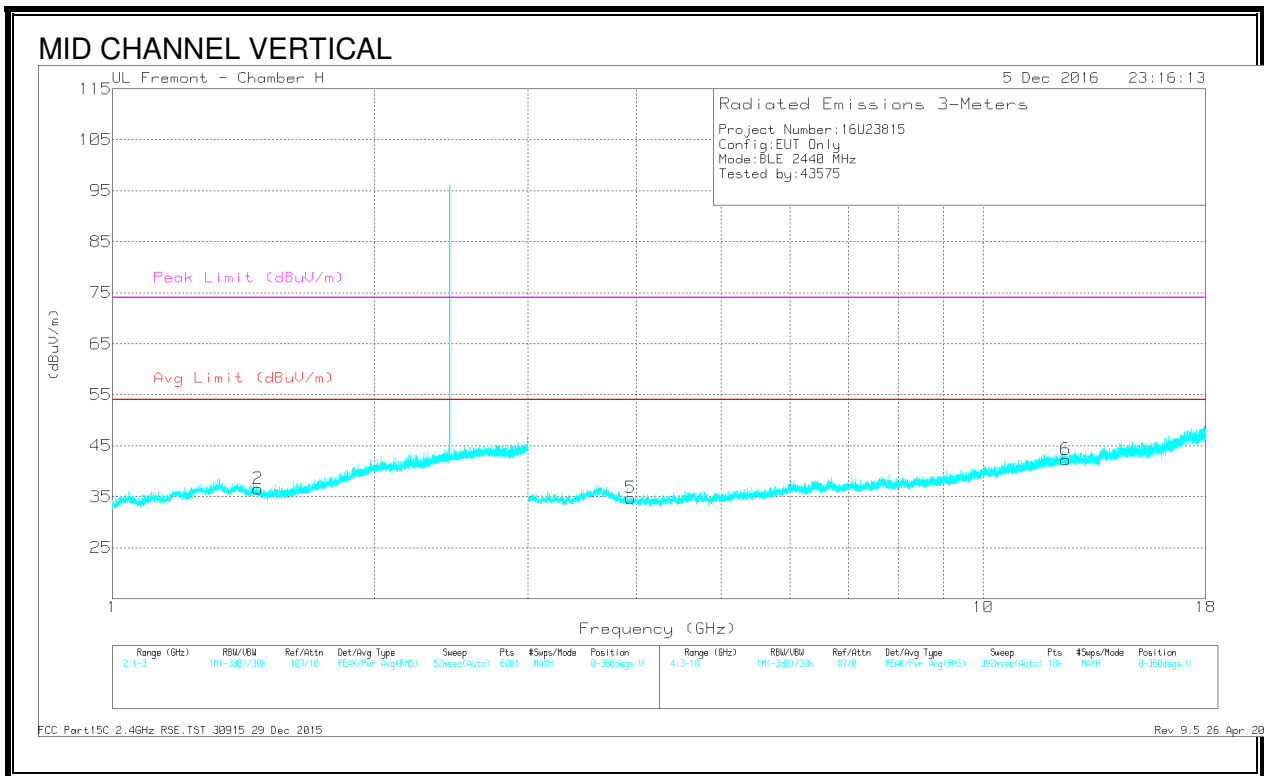
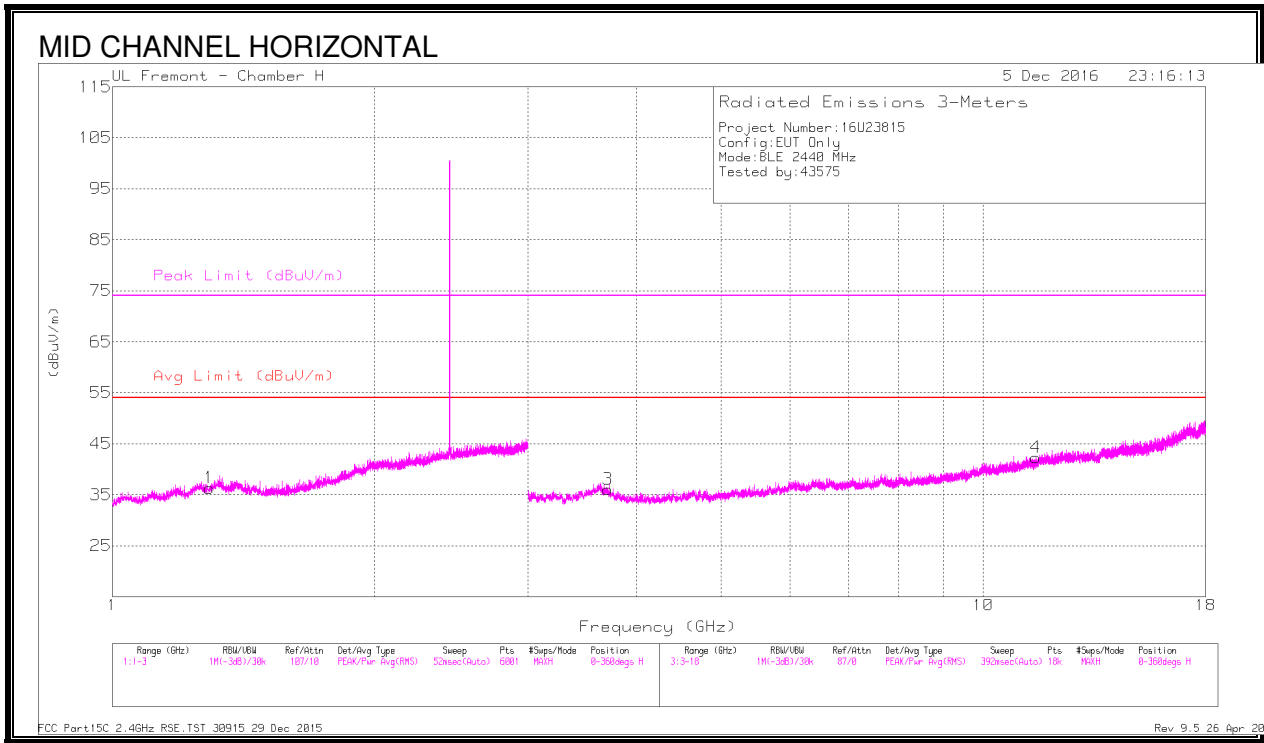

Marker	Frequency (GHz)	Meter Reading (dBuV)	Det	AF T120 (dB/m)	Amp/Cbl/Filtr/Pad (dB)	Corrected Reading (dBuV/m)	Avg Limit (dBuV/m)	Margin (dB)	Peak Limit (dBuV/m)	PK Margin (dB)	Azimuth (Degs)	Height (cm)	Polarity
1	* 1.294	37.64	PK2	29.7	-22.1	45.24	-	-	74	-28.76	128	267	H
	* 1.294	22.4	MAv1	29.7	-22.1	30	54	-24	-	-	128	267	H
2	* 1.471	37.8	PK2	28.4	-21.7	44.5	-	-	74	-29.5	216	289	V
	* 1.469	23.14	MAv1	28.4	-21.7	29.84	54	-24.16	-	-	216	289	V
3	* 3.711	43.68	PK2	34.8	-35.9	42.58	-	-	74	-31.42	120	263	H
	* 3.711	32.95	MAv1	34.8	-35.9	31.85	54	-22.15	-	-	120	263	H
4	* 11.49	36.74	PK2	38.7	-26.7	48.74	-	-	74	-25.26	193	275	H
	* 11.492	25.6	MAv1	38.7	-26.7	37.6	54	-16.4	-	-	193	275	H
5	* 3.939	44.18	PK2	33.5	-35.4	42.28	-	-	74	-31.72	0	148	V
	* 3.94	32.78	MAv1	33.5	-35.4	30.88	54	-23.12	-	-	0	148	V
6	* 12.436	36.4	PK2	39.3	-26.5	49.2	-	-	74	-24.8	11	316	V
	* 12.436	25.46	MAv1	39.3	-26.5	38.26	54	-15.74	-	-	11	316	V

\* - indicates frequency in CFR47 Pt 15 / IC RSS-Restricted Band

PK2 - KDB558074 Method: Maximum Peak

MAv1 - KDB558074 Option 1 Maximum RMS Average

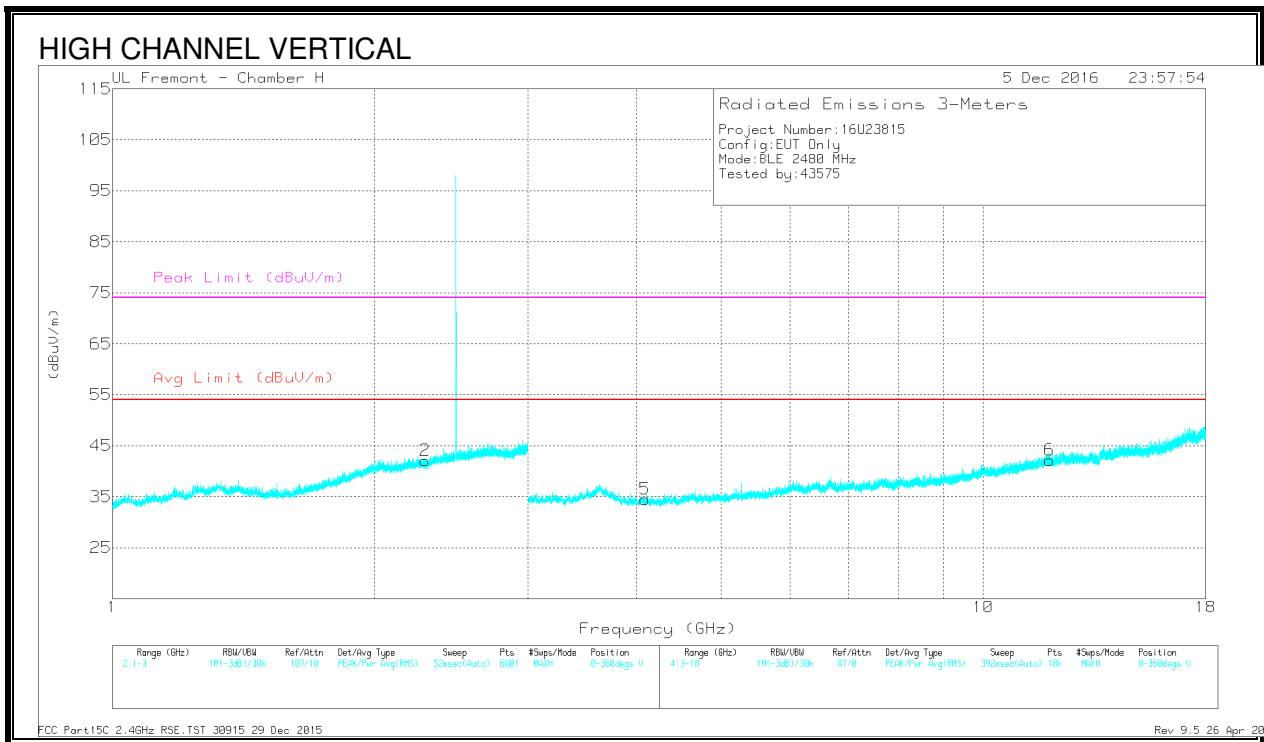
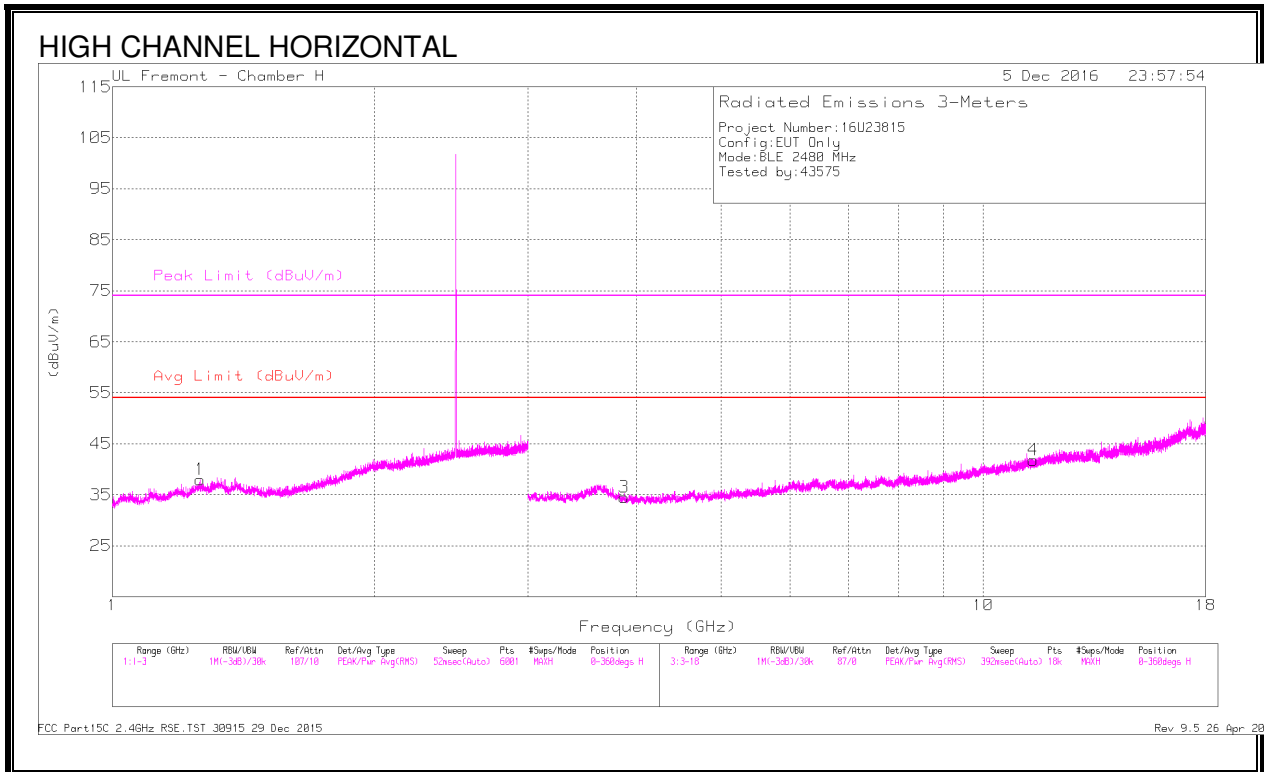

Marker	Frequency (GHz)	Meter Reading (dBuV)	Det	AF T120 (dB/m)	Amp/Cbl/Filtr/Pad (dB)	Corrected Reading (dBuV/m)	Avg Limit (dBuV/m)	Margin (dB)	Peak Limit (dBuV/m)	PK Margin (dB)	Azimuth (Degs)	Height (cm)	Polarity
1	* 1.263	38.25	PK2	29.4	-22.2	45.45	-	-	74	-28.55	84	366	H
	* 1.26	23.84	MAv1	29.3	-22.3	30.84	54	-23.16	-	-	84	366	H
2	* 2.29	38.24	PK2	31.5	-20	49.74	-	-	74	-24.26	360	332	V
	* 2.289	22.6	MAv1	31.5	-20	34.1	54	-19.9	-	-	360	332	V
3	* 3.872	43.41	PK2	33.7	-35.2	41.91	-	-	74	-32.09	98	112	H
	* 3.873	32.84	MAv1	33.7	-35.2	31.34	54	-22.66	-	-	98	112	H
4	* 11.407	36.73	PK2	38.6	-26.9	48.43	-	-	74	-25.57	146	376	H
	* 11.408	25.36	MAv1	38.6	-26.9	37.06	54	-16.94	-	-	146	376	H
5	* 4.089	44.31	PK2	33.5	-34.7	43.11	-	-	74	-30.89	188	100	V
	* 4.087	31.82	MAv1	33.5	-34.7	30.62	54	-23.38	-	-	188	100	V
6	* 11.916	36.6	PK2	39.1	-26.2	49.5	-	-	74	-24.5	122	239	V
	* 11.916	25.3	MAv1	39.1	-26.2	38.2	54	-15.8	-	-	122	239	V

\* - indicates frequency in CFR47 Pt 15 / IC RSS-Restricted Band

PK2 - KDB558074 Method: Maximum Peak

MAv1 - KDB558074 Option 1 Maximum RMS Average

### 8.4. WORST-CASE CO-LOCATION

#### BLUETOOTH LOW ENERGY AND 802.11 HT20 2Tx CDD MODE IN THE 5.6GHZ BAND

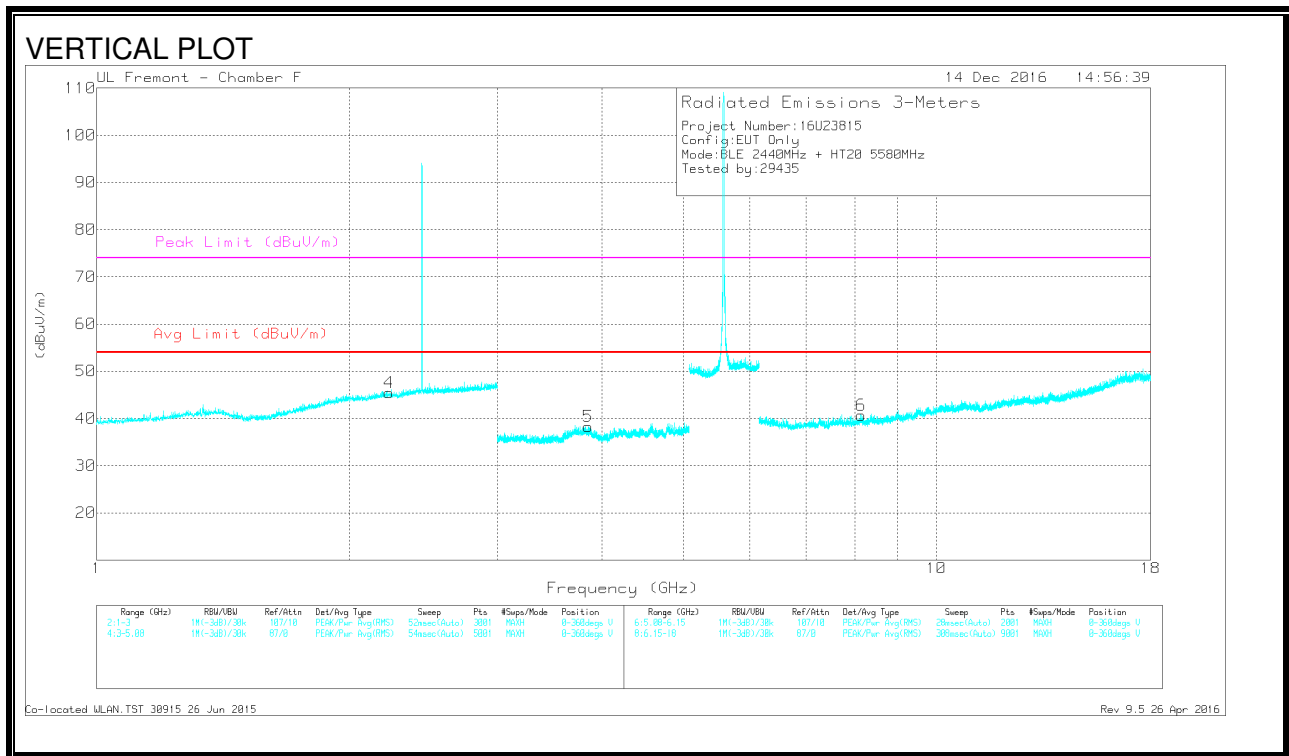
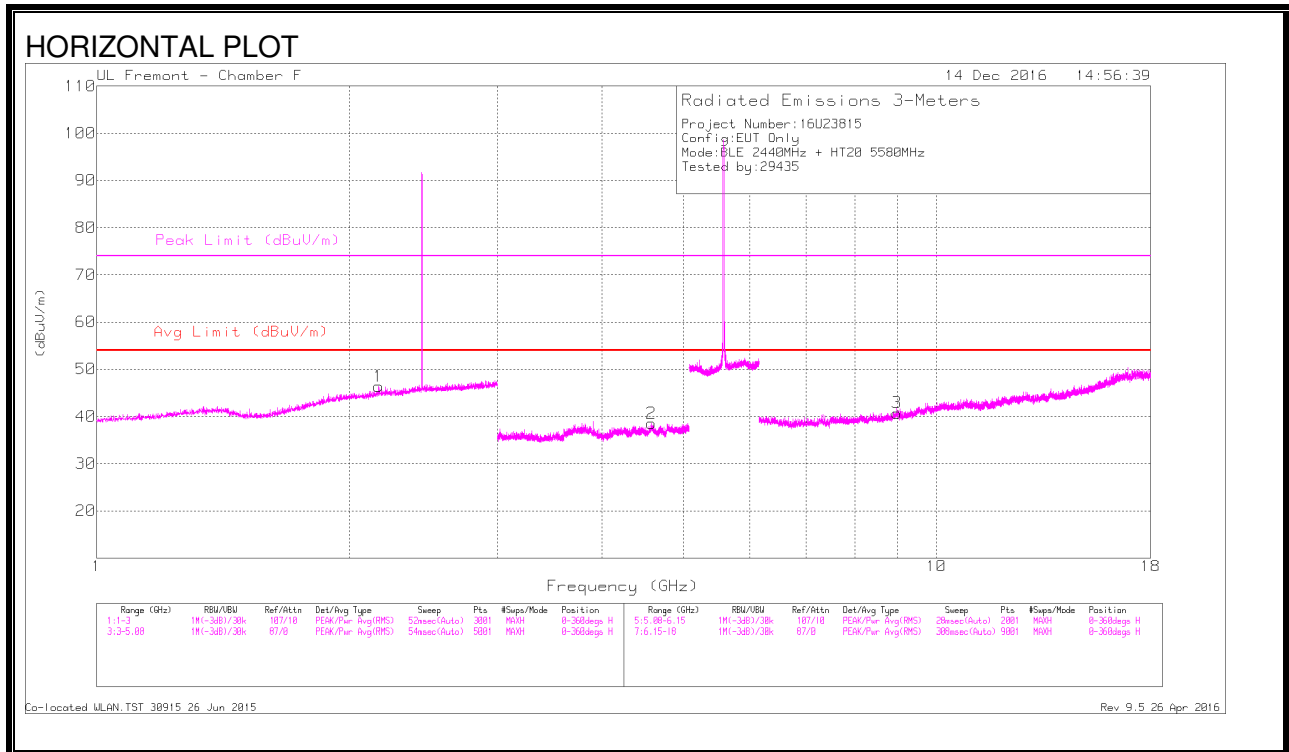

**DATA**

Marker	Frequen cy (GHz)	Meter Readi ng (dBuV )	Det	AF T344 (dB/m)	Amp/Cbl/Fit r/Pad (dB)	Correct ed Readin g (dBuV/ m)	Avg Limit (dBuV/m)	Margin (dB)	Peak Limit (dBuV/m)	Margi n (dB)	Azimu th (Degs)	Heig ht (cm)	Polari ty
1	2.169	41.57	PK-U	31.8	-21.1	52.27			74	-21.73	22	143	H
	2.167	30.37	ADR	31.7	-21.1	40.97	53.97	-13.00	-	-	22	143	H
4	* 2.229	42.62	PK-U	31.8	-21	53.42			74	-20.58	178	170	V
	* 2.227	30.31	ADR	31.8	-20.9	41.21	53.97	-12.76	-	-	178	170	V
2	* 4.579	38.02	PK-U	34.1	-27.8	44.32			74	-29.68	114	213	H
	* 4.58	27.28	ADR	34.1	-27.8	33.58	53.97	-20.39	-	-	114	213	H
5	* 3.852	39.39	PK-U	33.4	-28.2	44.59			74	-29.41	99	316	V
	* 3.852	27.75	ADR	33.4	-28.2	32.95	53.97	-21.02	-	-	99	316	V
3	8.985	35.04	PK-U	35.9	-22.9	48.04			74	-25.96	9	271	H
	8.983	23.63	ADR	35.9	-22.9	36.63	53.97-	-17.34	-	-	9	271	H
6	* 8.141	34.98	PK-U	35.7	-24.3	46.38			74	-27.62	335	299	V
	* 8.14	24.74	ADR	35.7	-24.3	36.14	53.97	-17.83	-	-	335	299	V

\* - indicates frequency in CFR47 Pt 15 / IC RSS-Restricted Band  
 PK-U - U-NII: Maximum Peak  
 ADR - U-NII AD primary method, RMS average

### 8.5. WORST-CASE BELOW 1 GHz

#### SPURIOUS EMISSIONS 30 TO 1000 MHz (WORST-CASE CONFIGURATION)

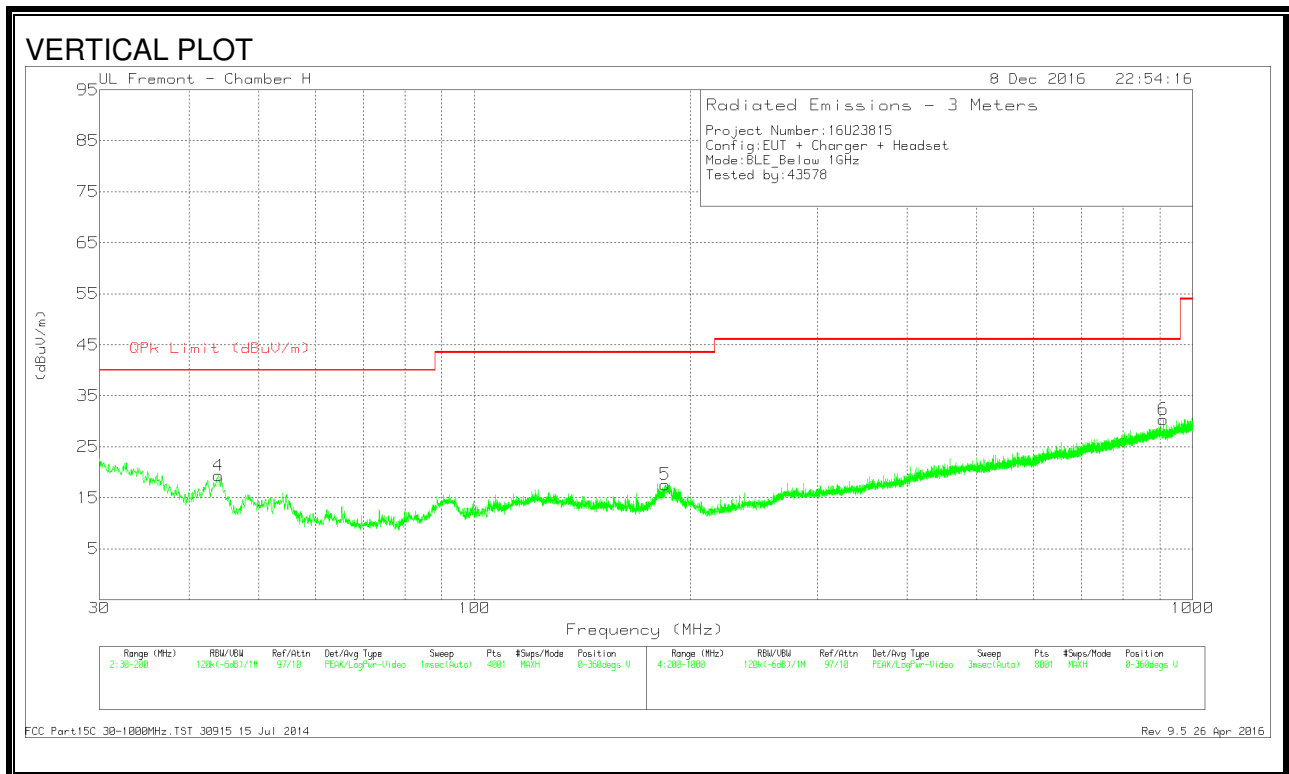
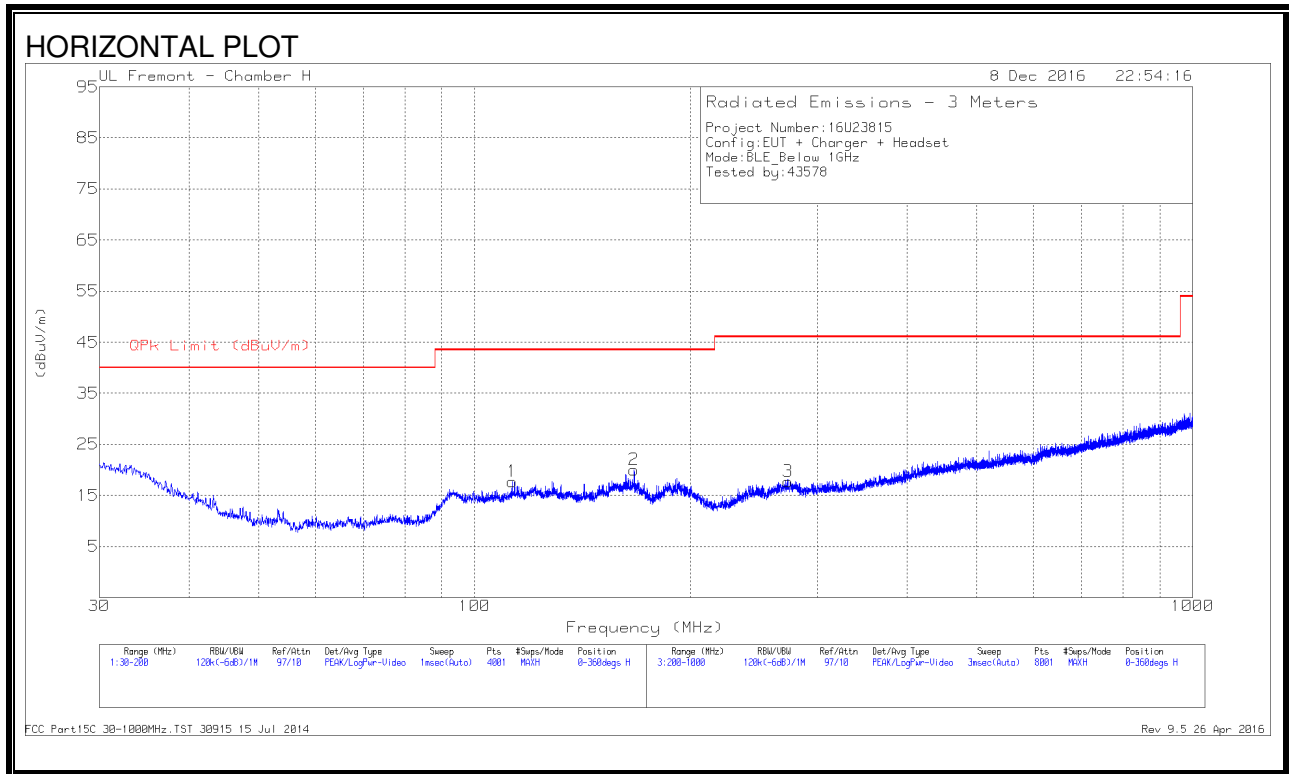

**DATA**

Marker	Frequency (MHz)	Meter Reading (dBuV)	Det	AF T407 (dB/m)	Amp/Cbl (dB)	Corrected Reading (dBuV/m)	QPk Limit (dBuV/m)	Margin (dB)	Azimuth (Degs)	Height (cm)	Polarity
1	* 112.875	31.15	Pk	17	-30.4	17.75	43.52	-25.77	0-360	299	H
2	* 166.85	34.21	Pk	15.7	-29.9	20.01	43.52	-23.51	0-360	199	H
3	* 273.3	29.67	Pk	17.3	-29.3	17.67	46.02	-28.35	0-360	199	H
5	184.2325	32.4	Pk	15	-29.8	17.6	43.52	-25.92	0-360	100	V
4	43.9825	35.5	Pk	14.9	-31.1	19.3	40	-20.7	0-360	100	V
6	909.5	30.44	Pk	26.3	-26.4	30.34	46.02	-15.68	0-360	399	V

\* - indicates frequency in CFR47 Pt 15 / IC RSS-Restricted Band  
 Pk - Peak detector

### 8.6. WORST-CASE ABOVE 18 GHz

#### SPURIOUS EMISSIONS 18 TO 26 GHz (WORST-CASE CONFIGURATION)

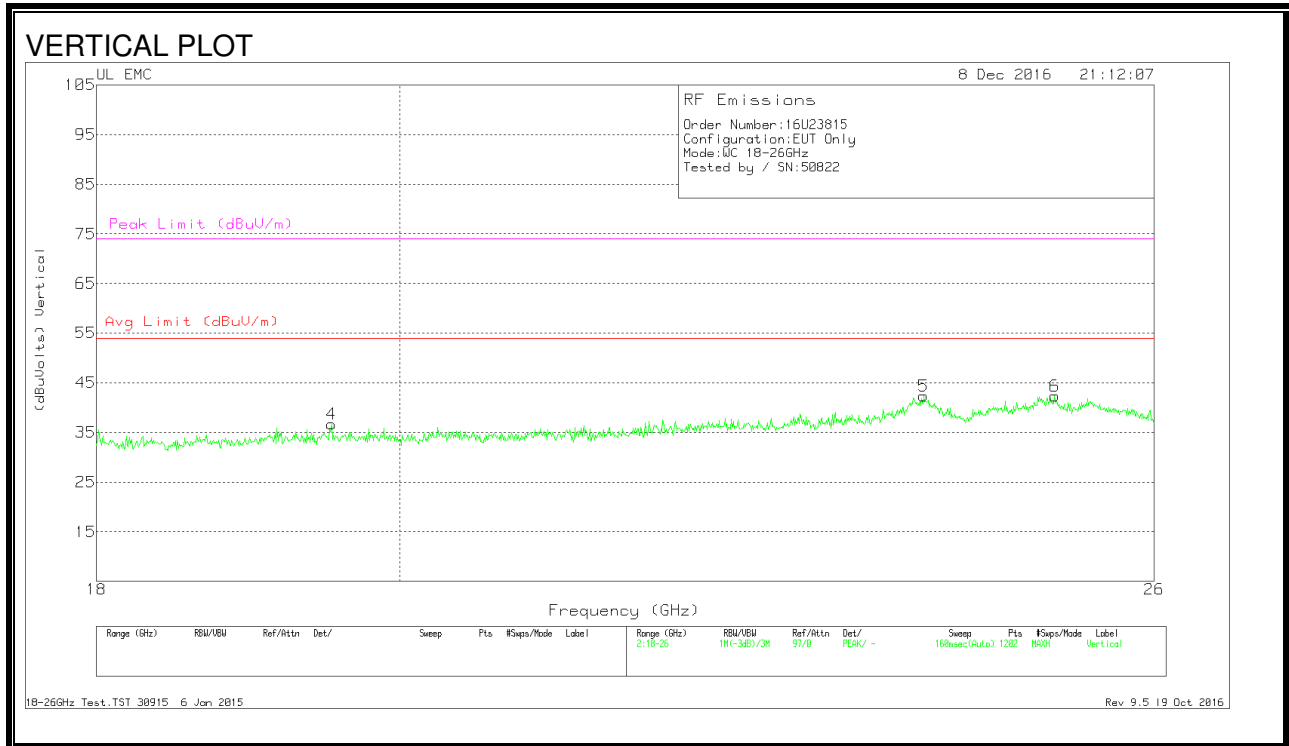
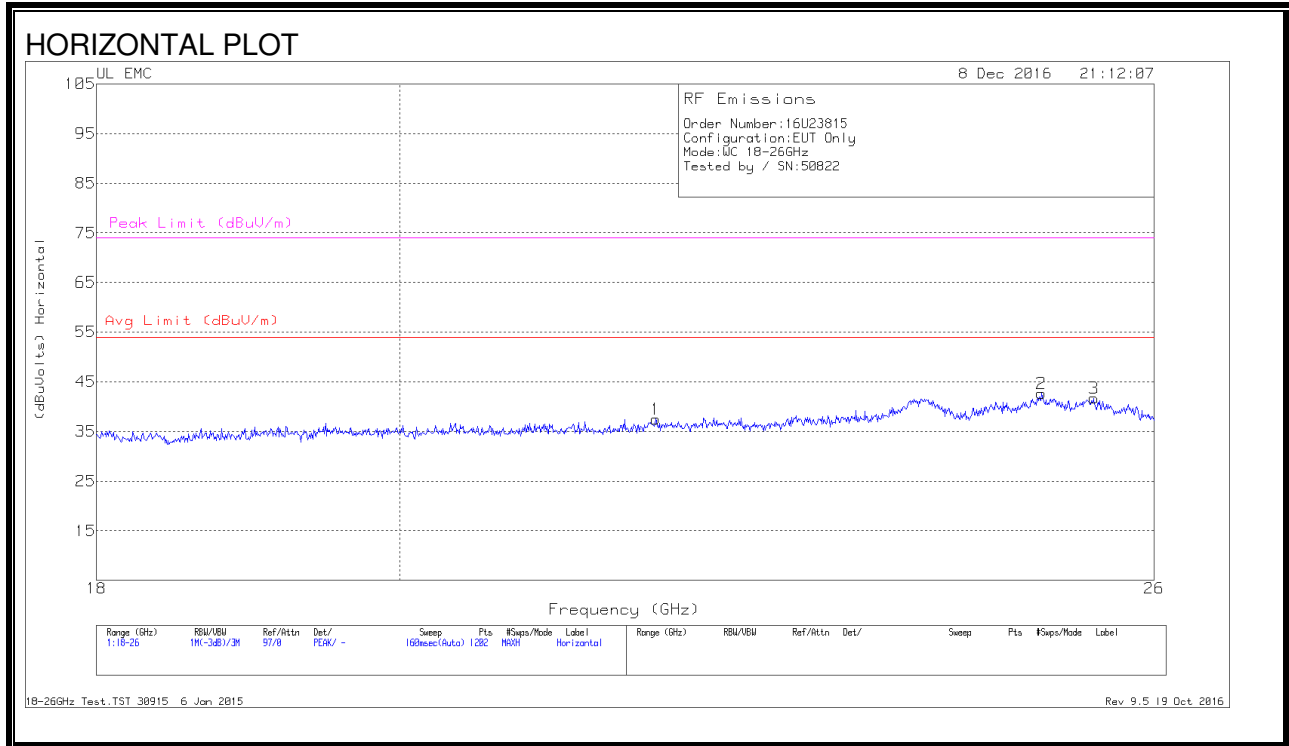

**Data**

Marker	Frequency (GHz)	Meter Reading (dBuV)	Det	AF T449 (dB/m)	Amp/Cbl (dB)	Dist Corr (dB)	Corrected Reading (dBuVolts)	Avg Limit (dBuV/m)	Margin (dB)	Peak Limit (dBuV/m)	PK Margin (dB)
1	21.863	38.3	Pk	33.3	-24.6	-9.5	37.5	54	-16.5	74	-36.5
2	25.001	42.57	Pk	34.2	-24.6	-9.5	42.66	54	-11.33	74	-31.33
3	25.46	41.27	Pk	34.4	-24.5	-9.5	41.66	54	-12.33	74	-32.33
4	19.532	38.67	Pk	32.7	-25.2	-9.5	36.66	54	-17.33	74	-37.33
5	23.995	42.23	Pk	34	-24.4	-9.5	42.33	54	-11.66	74	-31.66
6	25.114	42.03	Pk	34.3	-24.5	-9.5	42.33	54	-11.66	74	-31.66

Pk - Peak detector

## 9. AC POWER LINE CONDUCTED EMISSIONS

### LIMITS

FCC §15.207 (a)

RSS-Gen 8.8

Frequency of Emission (MHz)	Conducted Limit (dB $\mu$ V)	
	Quasi-peak	Average
0.15-0.5	66 to 56 *	56 to 46 *
0.5-5	56	46
5-30	60	50

\*Decreases with the logarithm of the frequency.

### TEST PROCEDURE

The EUT is placed on a non-conducting table 40 cm from the vertical ground plane and 80 cm above the horizontal ground plane. The EUT is configured in accordance with ANSI C63.10.

The receiver is set to a resolution bandwidth of 9 kHz. Peak detection is used unless otherwise noted as quasi-peak or average.

Line conducted data is recorded for both NEUTRAL and HOT lines.

### RESULTS

## 9.1. EUT POWERED BY AC/DC ADAPTER VIA USB CABLE

### LINE 1 RESULTS

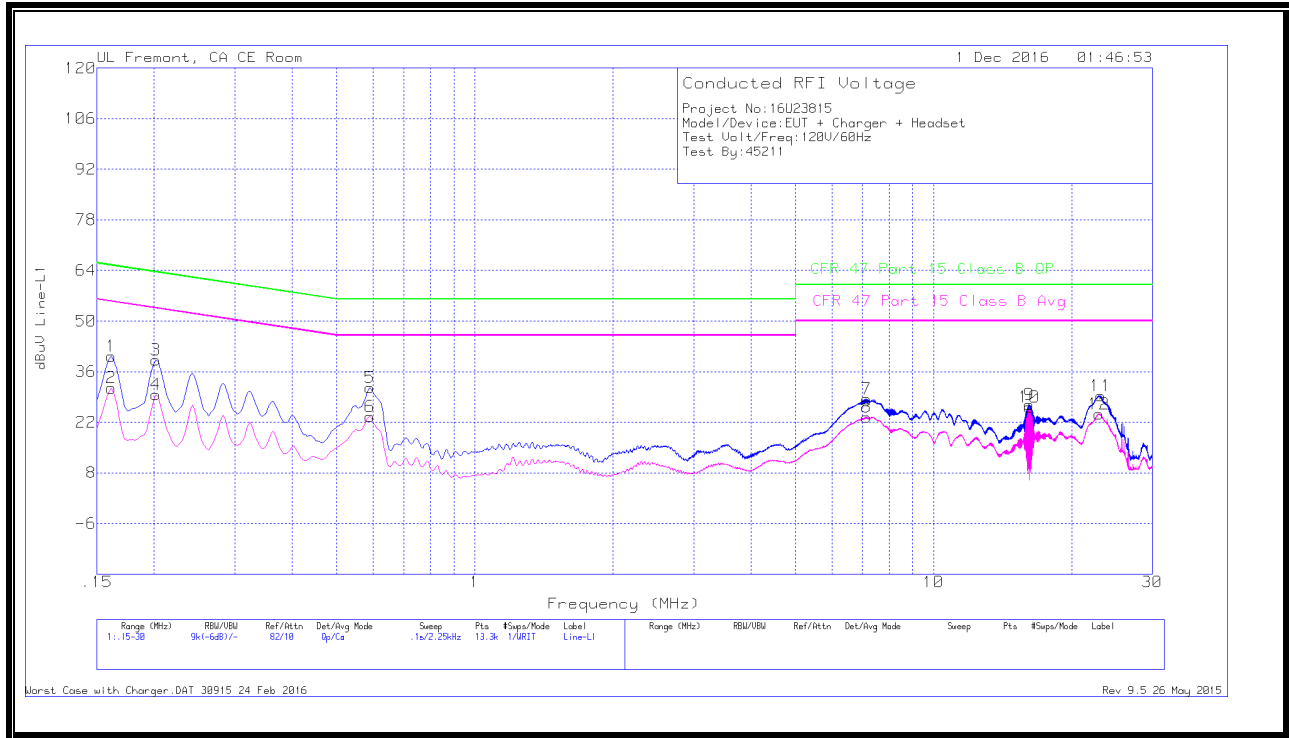

### WORST EMISSIONS

Range 1: Line-L1 .15 - 30MHz											
Marker	Frequency (MHz)	Meter Reading (dBuV)	Det	LISN L1	LC Cables 1&3	Limiter (dB)	Corrected Reading dBuV	CFR 47 Part 15 Class B QP	QP Margin (dB)	CFR 47 Part 15 Class B Avg	Av(CISPR) Margin (dB)
1	.16125	30.2	Qp	0	0	10.1	40.3	65.4	-25.1	-	-
2	.16125	21.39	Ca	0	0	10.1	31.49	-	-	55.4	-23.91
3	.20175	29.14	Qp	0	0	10.1	39.24	63.54	-24.3	-	-
4	.20175	19.49	Ca	0	0	10.1	29.59	-	-	53.54	-23.95
5	.591	21.45	Qp	0	0	10.1	31.55	56	-24.45	-	-
6	.58987	13.48	Ca	0	0	10.1	23.58	-	-	46	-22.42
7	7.1385	18.09	Qp	0	.1	10.2	28.39	60	-31.61	-	-
8	7.13625	13.09	Ca	0	.1	10.2	23.39	-	-	50	-26.61
9	16.1655	16.42	Qp	0	.2	10.3	26.92	60	-33.08	-	-
10	16.1655	15.72	Ca	0	.2	10.3	26.22	-	-	50	-23.78
11	23.12925	18.69	Qp	.1	.2	10.4	29.39	60	-30.61	-	-
12	22.9425	13.65	Ca	.1	.2	10.4	24.35	-	-	50	-25.65

Qp - Quasi-Peak detector

Ca - CISPR average detection

**LINE 2 RESULTS**

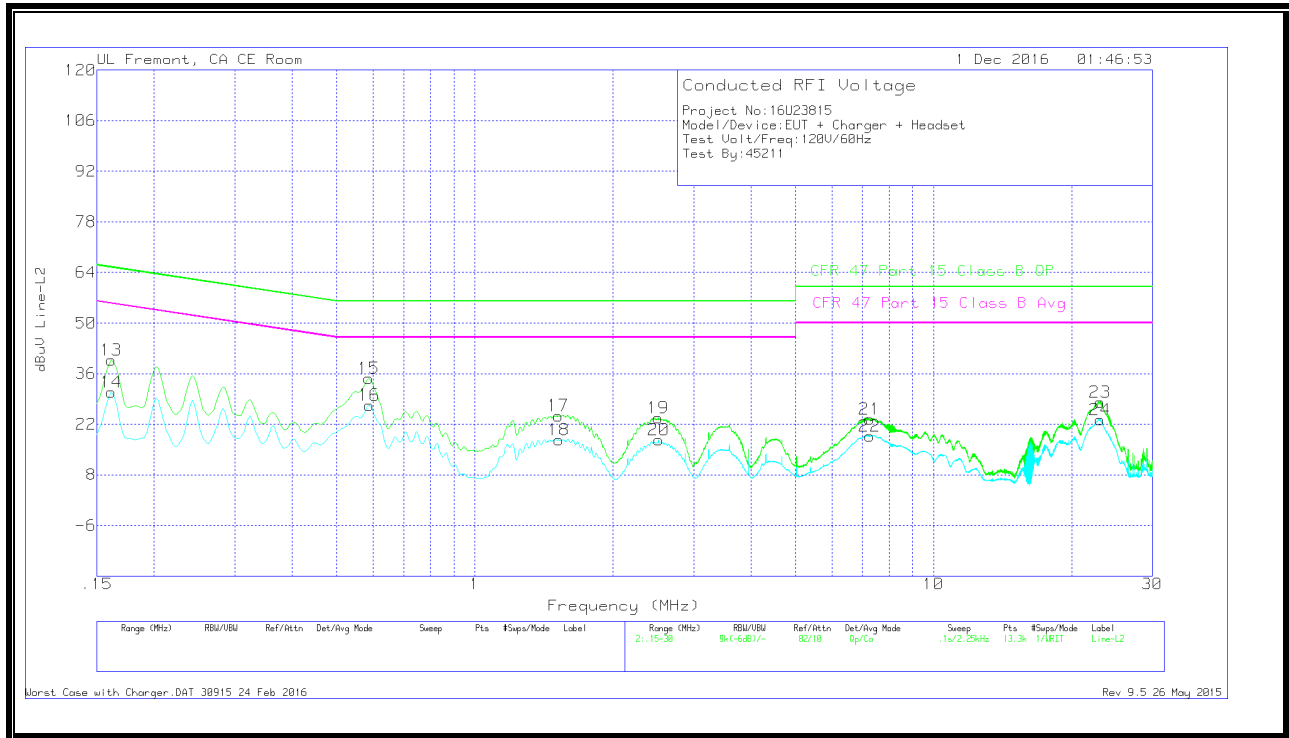

**WORST EMISSIONS**

Range 2: Line-L2 .15 - 30MHz											
Marker	Frequency (MHz)	Meter Reading (dBuV)	Det	LISN L2	LC Cables 2&3	Limiter (dB)	Corrected Reading dBuV	CFR 47 Part 15 Class B QP	QP Margin (dB)	CFR 47 Part 15 Class B Avg	Av(CISPR) Margin (dB)
13	.16125	29.7	Qp	0	0	10.1	39.8	65.4	-25.6	-	-
14	.16125	20.81	Ca	0	0	10.1	30.91	-	-	55.4	-24.49
15	.5865	24.55	Qp	0	0	10.1	34.65	56	-21.35	-	-
16	.58875	17.21	Ca	0	0	10.1	27.31	-	-	46	-18.69
17	1.5225	14.16	Qp	0	.1	10.1	24.36	56	-31.64	-	-
18	1.52475	7.4	Ca	0	.1	10.1	17.6	-	-	46	-28.4
19	2.5125	13.62	Qp	0	.1	10.1	23.82	56	-32.18	-	-
20	2.51475	7.51	Ca	0	.1	10.1	17.71	-	-	46	-28.29
21	7.26225	13.1	Qp	0	.1	10.2	23.4	60	-36.6	-	-
22	7.2645	8.41	Ca	0	.1	10.2	18.71	-	-	50	-31.29
23	23.073	17.44	Qp	.1	.2	10.4	28.14	60	-31.86	-	-
24	23.09325	12.48	Ca	.1	.2	10.4	23.18	-	-	50	-26.82

Qp - Quasi-Peak detector

Ca - CISPR average detection

## 9.2. EUT POWERED BY HOST PC VIA USB CABLE

### LINE 1 RESULTS

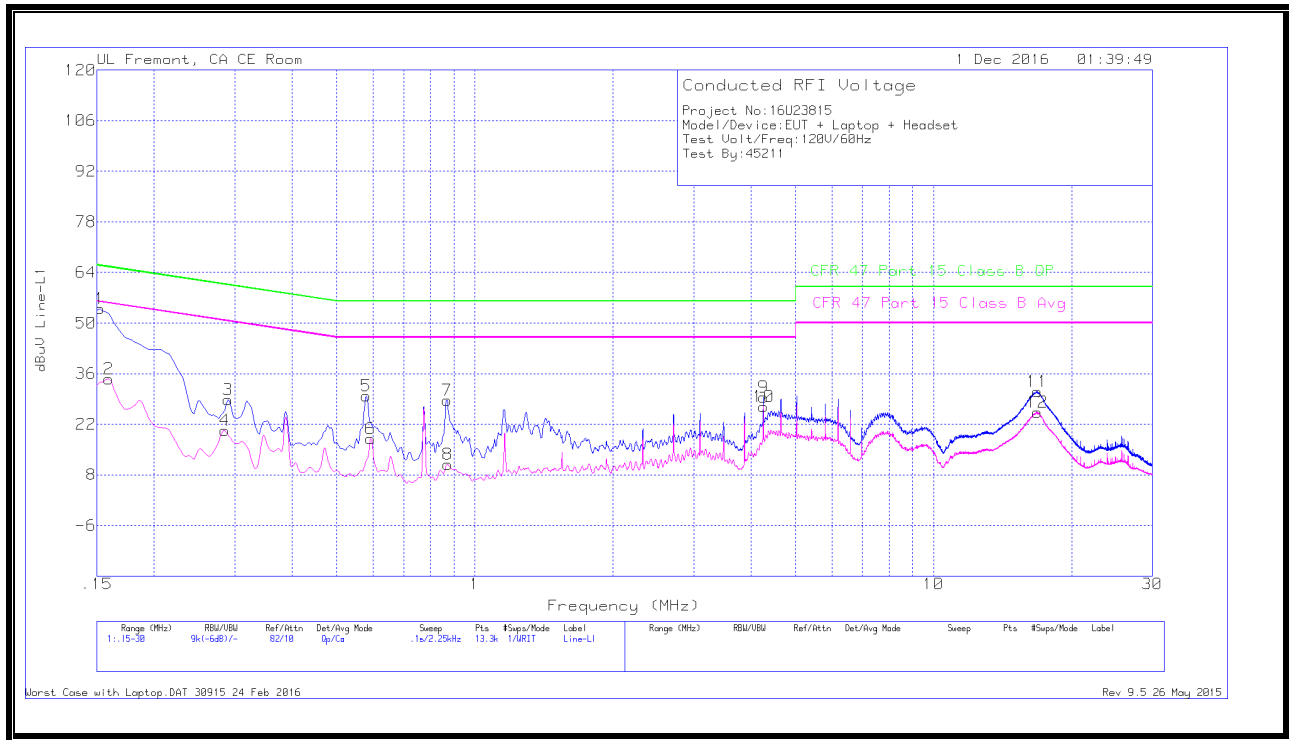

### WORST EMISSIONS

Range 1: Line-L1 .15 - 30MHz											
Marker	Frequency (MHz)	Meter Reading (dBuV)	Det	LISN L1	LC Cables 1&3	Limiter (dB)	Corrected Reading dBuV	CFR 47 Part 15 Class B QP	QP Margin (dB)	CFR 47 Part 15 Class B Avg	Av(CISPR) Margin (dB)
1	.15225	43.82	Qp	.1	0	10.1	54.02	65.88	-11.86	-	-
2	.159	24.38	Ca	0	0	10.1	34.48	-	-	55.52	-21.04
3	.2895	18.71	Qp	0	0	10.1	28.81	60.54	-31.73	-	-
4	.285	10.2	Ca	0	0	10.1	20.3	-	-	50.67	-30.37
5	.57975	19.81	Qp	0	0	10.1	29.91	56	-26.09	-	-
6	.59325	7.92	Ca	0	0	10.1	18.02	-	-	46	-27.98
7	.87	18.57	Qp	0	0	10.1	28.67	56	-27.33	-	-
8	.87225	.83	Ca	0	0	10.1	10.93	-	-	46	-35.07
9	4.26075	19.21	Qp	0	.1	10.1	29.41	56	-26.59	-	-
10	4.26075	16.61	Ca	0	.1	10.1	26.81	-	-	46	-19.19
11	16.83488	20.52	Qp	0	.2	10.3	31.02	60	-28.98	-	-
12	16.8315	14.75	Ca	0	.2	10.3	25.25	-	-	50	-24.75

Qp - Quasi-Peak detector

Ca - CISPR average detection

**LINE 2 RESULTS**

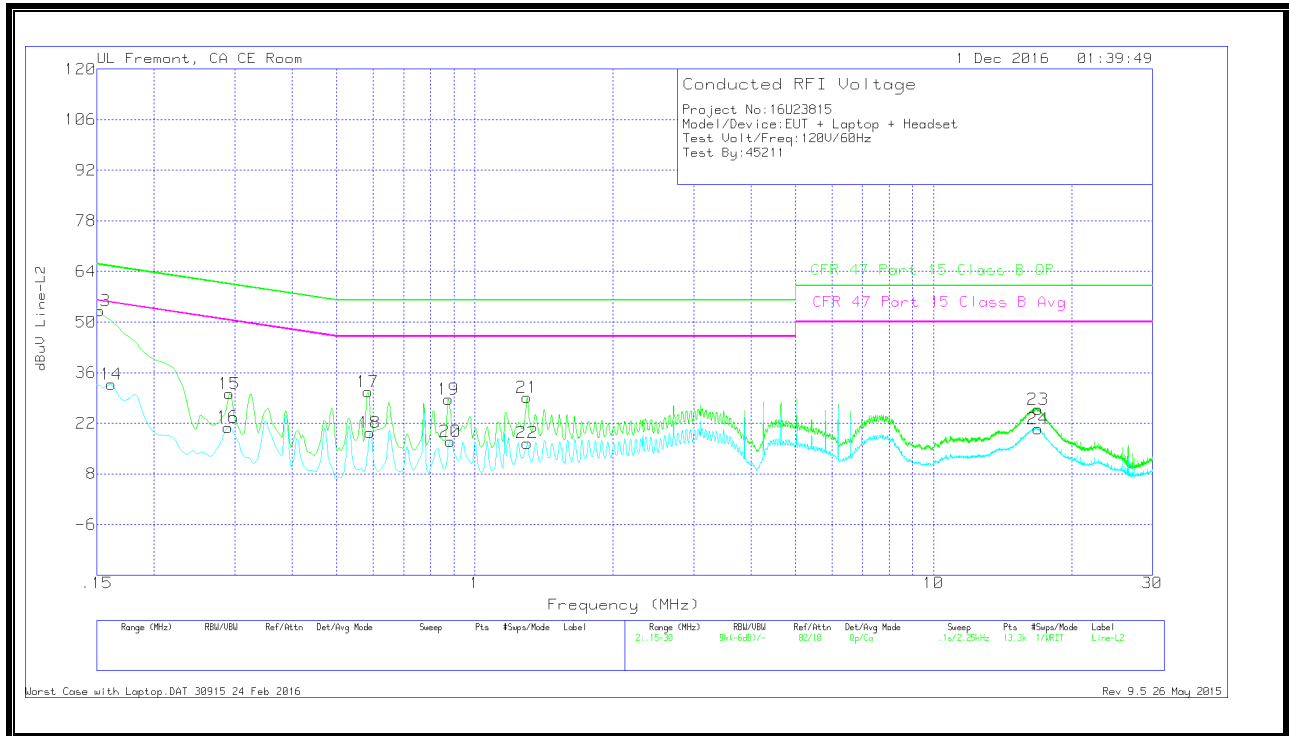

**WORST EMISSIONS**

Range 2: Line-L2 .15 - 30MHz											
Marker	Frequency (MHz)	Meter Reading (dBuV)	Det	LISN L2	LC Cables 2&3	Limiter (dB)	Corrected Reading dBuV	CFR 47 Part 15 Class B QP	QP Margin (dB)	CFR 47 Part 15 Class B Avg	Av(CISPR) Margin (dB)
13	.15225	43.01	Qp	0	0	10.1	53.11	65.88	-12.77	-	-
14	.16125	22.62	Ca	0	0	10.1	32.72	-	-	55.4	-22.68
15	.29175	20.14	Qp	0	0	10.1	30.24	60.47	-30.23	-	-
16	.2895	10.78	Ca	0	0	10.1	20.88	-	-	50.54	-29.66
17	.58425	20.57	Qp	0	0	10.1	30.67	56	-25.33	-	-
18	.591	9.25	Ca	0	0	10.1	19.35	-	-	46	-26.65
19	.87675	18.58	Qp	0	0	10.1	28.68	56	-27.32	-	-
20	.8835	6.89	Ca	0	0	10.1	16.99	-	-	46	-29.01
21	1.29975	19.01	Qp	0	.1	10.1	29.21	56	-26.79	-	-
22	1.30088	6.34	Ca	0	.1	10.1	16.54	-	-	46	-29.46
23	16.90575	15.38	Qp	0	.2	10.3	25.88	60	-34.12	-	-
24	16.90125	10.01	Ca	0	.2	10.3	20.51	-	-	50	-29.49

Qp - Quasi-Peak detector

Ca - CISPR average detection