



FCC 47 CFR PART 15 SUBPART E

CERTIFICATION TEST REPORT

FOR

TABLET DEVICE

MODEL NUMBER: A1584

FCC ID: BCGA1584

REPORT NUMBER: 14U19185-E4V4

ISSUE DATE: SEPTEMBER 14, 2015

Prepared for
APPLE, INC.
1 INFINITE LOOP
CUPERTINO, CA 95014, U.S.A.

Prepared by
UL VERIFICATION SERVICES INC.
47173 BENICIA STREET
FREMONT, CA 94538, U.S.A.
TEL: (510) 771-1000
FAX: (510) 661-0888



NVLAP LAB CODE 200065-0

Revision History

<u>Rev.</u>	<u>Issue Date</u>	<u>Revisions</u>	<u>Revised By</u>
V1	09/03/2015	Initial Issue	M. Mekuria
V2	09/08/2015	Addressed TCB Questions	E. Yu
V3	09/11/2015	Updated Antenna Gain	C. Pang
V4	09/14/2015	Address TCB's Questions	E. Yu

TABLE OF CONTENTS

1. ATTESTATION OF TEST RESULTS	12
2. TEST METHODOLOGY	13
3. FACILITIES AND ACCREDITATION	13
4. CALIBRATION AND UNCERTAINTY	14
4.1. <i>MEASURING INSTRUMENT CALIBRATION</i>	<i>14</i>
4.2. <i>SAMPLE CALCULATION</i>	<i>14</i>
4.3. <i>MEASUREMENT UNCERTAINTY</i>	<i>14</i>
5. EQUIPMENT UNDER TEST.....	15
5.1. <i>DESCRIPTION OF EUT</i>	<i>15</i>
5.2. <i>MAXIMUM OUTPUT POWER</i>	<i>15</i>
5.3. <i>DESCRIPTION OF AVAILABLE ANTENNAS.....</i>	<i>18</i>
5.4. <i>SOFTWARE AND FIRMWARE</i>	<i>18</i>
5.5. <i>WORST-CASE CONFIGURATION AND MODE.....</i>	<i>19</i>
5.6. <i>DESCRIPTION OF TEST SETUP</i>	<i>20</i>
6. TEST AND MEASUREMENT EQUIPMENT	25
7. ON TIME, DUTY CYCLE AND MEASUREMENT METHODS	26
7.1. <i>ON TIME AND DUTY CYCLE.....</i>	<i>26</i>
7.2. <i>MEASUREMENT METHODS.....</i>	<i>30</i>
8. ANTENNA PORT TEST RESULTS.....	31
8.1. <i>802.11a MODE IN THE 5.2 GHz BAND</i>	<i>31</i>
8.2. <i>802.11n HT20 CHAIN 0 MODE IN THE 5.2 GHz BAND</i>	<i>32</i>
8.2.1. <i>26 dB BANDWIDTH</i>	<i>32</i>
8.2.2. <i>99% BANDWIDTH.....</i>	<i>35</i>
8.2.3. <i>AVERAGE POWER.....</i>	<i>38</i>
8.2.4. <i>OUTPUT POWER AND PSD</i>	<i>39</i>
8.3. <i>802.11n HT20 CHAIN 1 MODE IN THE 5.2 GHz BAND</i>	<i>43</i>
8.3.1. <i>26 dB BANDWIDTH</i>	<i>43</i>
8.3.2. <i>99% BANDWIDTH.....</i>	<i>46</i>
8.3.3. <i>AVERAGE POWER.....</i>	<i>49</i>
8.3.4. <i>OUTPUT POWER AND PSD</i>	<i>50</i>
8.4. <i>802.11a CDD 2TX MODE IN THE 5.2 GHz BAND</i>	<i>54</i>
8.5. <i>802.11n HT20 2Tx CDD MODE IN THE 5.2 GHz BAND</i>	<i>55</i>
8.5.1. <i>26 dB BANDWIDTH</i>	<i>55</i>
8.5.2. <i>99% BANDWIDTH.....</i>	<i>59</i>
8.5.3. <i>AVERAGE POWER.....</i>	<i>63</i>
8.5.4. <i>OUTPUT POWER AND PSD</i>	<i>64</i>

8.6. 802.11n HT20 2Tx STBC MODE IN THE 5.2 GHz BAND..... 70
8.6.1. 26 dB BANDWIDTH 70
8.6.2. 99% BANDWIDTH..... 74
8.6.3. AVERAGE POWER..... 78
8.6.4. OUTPUT POWER AND PSD 79
8.7. 802.11n HT20 2Tx SDM MODE IN THE 5.2 GHz BAND 85
8.8. 802.11n HT40 CHAIN 0 MODE IN THE 5.2 GHz BAND 86
8.8.1. 26 dB BANDWIDTH 86
8.8.2. 99% BANDWIDTH..... 88
8.8.3. AVERAGE POWER..... 90
8.8.4. OUTPUT POWER AND PSD 91
8.9. 802.11n HT40 CHAIN 1 MODE IN THE 5.2 GHz BAND 94
8.9.1. 26 dB BANDWIDTH 94
8.9.2. 99% BANDWIDTH..... 96
8.9.3. AVERAGE POWER..... 98
8.9.4. OUTPUT POWER AND PSD 99
8.10. 802.11n HT40 2TX CDD MODE IN THE 5.2 GHz BAND 102
8.10.1. 26 dB BANDWIDTH..... 102
8.10.2. 99% BANDWIDTH..... 105
8.10.3. AVERAGE POWER 108
8.10.4. OUTPUT POWER AND PSD 109
8.11. 802.11n HT40 2Tx STBC MODE IN THE 5.2 GHz BAND 114
8.11.1. 26 dB BANDWIDTH..... 114
8.11.2. 99% BANDWIDTH..... 117
8.11.3. AVERAGE POWER..... 120
8.11.4. OUTPUT POWER AND PSD 121
8.12. 802.11n HT40 2Tx SDM MODE IN THE 5.2 GHz BAND..... 126
8.13. 802.11ac VHT80 CHAIN 0 MODE IN THE 5.2 GHz BAND 127
8.13.1. 26 dB BANDWIDTH..... 127
8.13.2. 99% BANDWIDTH..... 128
8.13.3. AVERAGE POWER 129
8.13.4. OUTPUT POWER AND PSD 130
8.14. 802.11ac VHT80 CHAIN 1 MODE IN THE 5.2 GHz BAND 133
8.14.1. 26 dB BANDWIDTH..... 133
8.14.2. 99% BANDWIDTH..... 134
8.14.3. AVERAGE POWER 135
8.14.4. OUTPUT POWER AND PSD 136
8.15. 802.11ac VHT80 2Tx CDD MODE IN THE 5.2 GHz BAND..... 139
8.15.1. 26 dB BANDWIDTH..... 139
8.15.2. 99% BANDWIDTH..... 141
8.15.3. AVERAGE POWER 143
8.15.4. OUTPUT POWER AND PSD 144
8.16. 802.11ac VHT80 2Tx STBC/SDM MODE IN THE 5.2 GHz BAND 148
8.17. 802.11a SISO MODE IN THE 5.3 GHz BAND..... 149
8.18. 802.11n HT20 CHAIN 0 MODE IN THE 5.3 GHz BAND 150
8.18.1. 26 dB BANDWIDTH..... 150
8.18.2. 99% BANDWIDTH..... 153

8.18.3.	AVERAGE POWER	156
8.18.4.	OUTPUT POWER AND PSD	157
8.19.	<i>802.11n HT20 CHAIN 1 MODE IN THE 5.3 GHz BAND</i>	161
8.19.1.	26 dB BANDWIDTH	161
8.19.2.	99% BANDWIDTH	164
8.19.3.	AVERAGE POWER	167
8.19.4.	OUTPUT POWER AND PSD	168
8.20.	<i>802.11a CDD 2TX MODE IN THE 5.3 GHz BAND</i>	172
8.21.	<i>802.11n HT20 2Tx CDD MODE IN THE 5.3 GHz BAND</i>	173
8.21.1.	26 dB BANDWIDTH	173
8.21.2.	99% BANDWIDTH	177
8.21.3.	AVERAGE POWER	181
8.21.4.	OUTPUT POWER AND PSD	182
8.22.	<i>802.11n HT20 2Tx STBC MODE IN THE 5.3 GHz BAND</i>	187
8.22.1.	26 dB BANDWIDTH	187
8.22.2.	99% BANDWIDTH	191
8.22.3.	AVERAGE POWER	195
8.22.4.	OUTPUT POWER AND PSD	196
8.23.	<i>802.11n HT20 2Tx SDM MODE IN THE 5.3 GHz BAND</i>	201
8.24.	<i>802.11n HT40 CHAIN 0 MODE IN THE 5.3 GHz BAND</i>	202
8.24.1.	26 dB BANDWIDTH	202
8.24.2.	99% BANDWIDTH	204
8.24.3.	AVERAGE POWER	206
8.24.4.	OUTPUT POWER AND PSD	207
8.25.	<i>802.11n HT40 CHAIN 1 MODE IN THE 5.3 GHz BAND</i>	210
8.25.1.	26 dB BANDWIDTH	210
8.25.2.	99% BANDWIDTH	212
8.25.3.	AVERAGE POWER	214
8.25.4.	OUTPUT POWER AND PSD	215
8.26.	<i>802.11n HT40 2Tx CDD MODE IN THE 5.3 GHz BAND</i>	218
8.26.1.	26 dB BANDWIDTH	218
8.26.2.	99% BANDWIDTH	221
8.26.3.	AVERAGE POWER	224
8.26.4.	OUTPUT POWER AND PSD	225
8.27.	<i>802.11n HT40 2Tx STBC MODE IN THE 5.3 GHz BAND</i>	229
8.27.1.	26 dB BANDWIDTH	229
8.27.2.	99% BANDWIDTH	232
8.27.3.	AVERAGE POWER	235
8.27.4.	OUTPUT POWER AND PSD	236
8.28.	<i>802.11n HT40 2Tx SDM MODE IN THE 5.3 GHz BAND</i>	240
8.29.	<i>802.11ac VHT80 CHAIN 0 MODE IN THE 5.3 GHz BAND</i>	241
8.29.1.	26 dB BANDWIDTH	241
8.29.2.	99% BANDWIDTH	242
8.29.3.	AVERAGE POWER	243
8.29.4.	OUTPUT POWER AND PSD	244
8.30.	<i>802.11ac VHT80 CHAIN 1 MODE IN THE 5.3 GHz BAND</i>	247
8.30.1.	26 dB BANDWIDTH	247

8.30.2.	99% BANDWIDTH.....	248
8.30.3.	AVERAGE POWER.....	249
8.30.4.	OUTPUT POWER AND PSD.....	250
8.31.	<i>802.11ac VHT80 2Tx CDD MODE IN THE 5.3 GHz BAND.....</i>	<i>253</i>
8.31.1.	26 dB BANDWIDTH.....	253
8.31.2.	99% BANDWIDTH.....	255
8.31.3.	AVERAGE POWER.....	257
8.31.4.	OUTPUT POWER AND PSD.....	258
8.32.	<i>802.11n VHT80 2Tx STBC/SDM MODE IN THE 5.3 GHz BAND.....</i>	<i>261</i>
8.33.	<i>802.11a SISO MODE IN THE 5.6 GHz BAND.....</i>	<i>262</i>
8.34.	<i>802.11n HT20 CHAIN 0 MODE IN THE 5.6 GHz BAND.....</i>	<i>263</i>
8.34.1.	26 dB BANDWIDTH.....	263
8.34.2.	99% BANDWIDTH.....	266
8.34.3.	AVERAGE POWER.....	269
8.34.4.	OUTPUT POWER AND PSD.....	270
8.34.5.	STRADDLE CHANNEL 144 RESULTS.....	274
8.34.6.	6 dB BANDWIDTH.....	278
8.35.	<i>802.11n HT20 CHAIN 1 MODE IN THE 5.6 GHz BAND.....</i>	<i>279</i>
8.35.1.	26 dB BANDWIDTH.....	279
8.35.2.	99% BANDWIDTH.....	282
8.35.3.	AVERAGE POWER.....	285
8.35.4.	OUTPUT POWER AND PSD.....	286
8.35.5.	STRADDLE CHANNEL 144 RESULTS.....	290
8.35.6.	6 dB BANDWIDTH.....	294
8.36.	<i>802.11a CDD 2TX MODE IN THE 5.6 GHz BAND.....</i>	<i>295</i>
8.37.	<i>802.11n HT20 2Tx CDD MODE IN THE 5.6 GHz BAND.....</i>	<i>296</i>
8.37.1.	26 dB BANDWIDTH.....	296
8.37.2.	99% BANDWIDTH.....	301
8.37.3.	AVERAGE POWER.....	306
8.37.4.	OUTPUT POWER AND PSD.....	307
8.37.5.	STRADDLE CHANNEL 144 RESULTS.....	312
8.37.6.	6 dB BANDWIDTH.....	317
8.38.	<i>802.11n HT20 2Tx STBC/SDM MODE IN THE 5.6 GHz BAND.....</i>	<i>319</i>
8.39.	<i>802.11n HT40 CHAIN 0 MODE IN THE 5.6 GHz BAND.....</i>	<i>320</i>
8.39.1.	26 dB BANDWIDTH.....	320
8.39.2.	99% BANDWIDTH.....	323
8.39.3.	AVERAGE POWER.....	326
8.39.4.	OUTPUT POWER AND PSD.....	327
8.39.5.	STRADDLE CH 142 RESULTS.....	331
8.39.6.	6 dB BANDWIDTH.....	335
8.40.	<i>802.11n HT40 CHAIN 1 MODE IN THE 5.6 GHz BAND.....</i>	<i>336</i>
8.40.1.	26 dB BANDWIDTH.....	336
8.40.2.	99% BANDWIDTH.....	339
8.40.3.	AVERAGE POWER.....	342
8.40.4.	OUTPUT POWER AND PSD.....	343
8.40.5.	STRADDLE CH 142 RESULTS.....	347
8.40.6.	6 dB BANDWIDTH.....	351
8.41.	<i>802.11n HT40 2Tx CDD MODE IN THE 5.6 GHz BAND.....</i>	<i>352</i>

8.41.1.	26 dB BANDWIDTH.....	352
8.41.2.	99% BANDWIDTH.....	357
8.41.3.	AVERAGE POWER.....	362
8.41.4.	OUTPUT POWER AND PSD.....	363
8.41.5.	STRADDLE CHANNEL 142 RESULTS.....	368
8.41.6.	6 dB BANDWIDTH.....	373
8.42.	<i>802.11n HT40 2Tx STBC/SDM MODE IN THE 5.6 GHz BAND.....</i>	<i>375</i>
8.43.	<i>802.11ac VHT80 CHAIN 0 MODE IN THE 5.6 GHz BAND.....</i>	<i>376</i>
8.43.1.	26 dB BANDWIDTH.....	376
8.43.2.	99% BANDWIDTH.....	379
8.43.3.	AVERAGE POWER.....	382
8.43.4.	OUTPUT POWER AND PSD.....	383
8.43.5.	STRADDLE CHANNEL 138 RESULTS.....	386
8.43.6.	6 dB BANDWIDTH.....	390
8.44.	<i>802.11ac VHT80 CHAIN 1 MODE IN THE 5.6 GHz BAND.....</i>	<i>391</i>
8.44.1.	26 dB BANDWIDTH.....	391
8.44.2.	99% BANDWIDTH.....	394
8.44.3.	OUTPUT POWER AND PSD.....	398
8.44.4.	STRADDLE CHANNEL 138 RESULTS.....	401
8.44.5.	6 dB BANDWIDTH.....	405
8.45.	<i>802.11ac VHT80 2Tx CDD MODE IN THE 5.6 GHz BAND.....</i>	<i>406</i>
8.45.1.	26 dB BANDWIDTH.....	406
8.45.2.	99% BANDWIDTH.....	410
8.45.3.	AVERAGE POWER.....	414
8.45.4.	OUTPUT POWER AND PSD.....	415
8.45.5.	STRADDLE CHANNEL 138 RESULTS.....	419
8.45.6.	6 dB BANDWIDTH.....	424
8.46.	<i>802.11n VHT80 2Tx STBC/SDM MODE IN THE 5.6 GHz BAND.....</i>	<i>426</i>
8.47.	<i>802.11a SISO MODE IN THE 5.8 GHz BAND.....</i>	<i>427</i>
8.48.	<i>802.11n HT20 CHAIN 0 MODE IN THE 5.8 GHz BAND.....</i>	<i>428</i>
8.48.1.	6 dB BANDWIDTH.....	428
8.48.2.	26 dB BANDWIDTH.....	431
8.48.3.	99% BANDWIDTH.....	434
8.48.4.	AVERAGE POWER.....	437
8.48.5.	OUTPUT POWER.....	438
8.48.6.	PSD.....	440
8.49.	<i>802.11n HT20 CHAIN 1 MODE IN THE 5.8 GHz BAND.....</i>	<i>443</i>
8.49.1.	6 dB BANDWIDTH.....	443
8.49.2.	26 dB BANDWIDTH.....	446
8.49.3.	99% BANDWIDTH.....	449
8.49.4.	AVERAGE POWER.....	452
8.49.5.	OUTPUT POWER.....	453
8.49.6.	PSD.....	455
8.50.	<i>802.11a CDD 2TX MODE IN THE 5.8 GHz BAND.....</i>	<i>458</i>
8.51.	<i>802.11n HT20 2Tx CDD MODE IN THE 5.8 GHz BAND.....</i>	<i>459</i>
8.51.1.	6 dB BANDWIDTH.....	459
8.51.2.	26 dB BANDWIDTH.....	463
8.51.3.	99% BANDWIDTH.....	467

8.51.4.	AVERAGE POWER.....	471
8.51.5.	OUTPUT POWER.....	472
8.51.6.	PSD	474
8.52.	802.11n HT20 2Tx STBC/SDM MODE IN THE 5.8 GHz BAND	479
8.53.	802.11n HT40 CHAIN 0 MODE IN THE 5.8 GHz BAND	480
8.53.1.	6 dB BANDWIDTH.....	480
8.53.2.	26 dB BANDWIDTH.....	482
8.53.3.	99% BANDWIDTH.....	484
8.53.4.	AVERAGE POWER.....	486
8.53.5.	OUTPUT POWER.....	487
8.53.6.	PSD	489
8.54.	802.11n HT40 CHAIN 1 MODE IN THE 5.8 GHz BAND	492
8.54.1.	6 dB BANDWIDTH.....	492
8.54.2.	26 dB BANDWIDTH.....	494
8.54.3.	99% BANDWIDTH.....	496
8.54.4.	AVERAGE POWER.....	498
8.54.5.	OUTPUT POWER.....	499
8.54.6.	PSD	501
8.55.	802.11n HT40 2Tx CDD MODE IN THE 5.8 GHz BAND.....	504
8.55.1.	6 dB BANDWIDTH.....	504
8.55.2.	26 dB BANDWIDTH.....	507
8.55.3.	99% BANDWIDTH.....	510
8.55.4.	AVERAGE POWER.....	513
8.55.5.	OUTPUT POWER.....	514
8.55.6.	PSD	516
8.56.	802.11n HT40 2Tx STBC/SDM MODE IN THE 5.8 GHz BAND	520
8.57.	802.11ac VHT80 CHAIN 0 MODE IN THE 5.8 GHz BAND	521
8.57.1.	6 dB BANDWIDTH.....	521
8.57.2.	26 dB BANDWIDTH.....	522
8.57.3.	99% BANDWIDTH.....	523
8.57.4.	AVERAGE POWER.....	524
8.57.5.	OUTPUT POWER.....	525
8.57.6.	PSD	527
8.58.	802.11ac VHT80 CHAIN 1 MODE IN THE 5.8 GHz BAND	529
8.58.1.	6 dB BANDWIDTH.....	529
8.58.2.	26 dB BANDWIDTH.....	530
8.58.3.	99% BANDWIDTH.....	531
8.58.4.	AVERAGE POWER.....	532
8.58.5.	OUTPUT POWER.....	533
8.58.6.	PSD	534
8.59.	802.11ac VHT80 2Tx CDD MODE IN THE 5.8 GHz BAND.....	536
8.59.1.	6 dB BANDWIDTH.....	536
8.59.2.	26 dB BANDWIDTH.....	538
8.59.3.	99% BANDWIDTH.....	540
8.59.4.	AVERAGE POWER.....	542
8.59.5.	OUTPUT POWER.....	543
8.59.6.	PSD	544
8.60.	802.11n VHT80 2Tx STBC/SDM MODE IN THE 5.8 GHz BAND.....	546

9. RADIATED TEST RESULTS 547

- 9.1. *LIMITS AND PROCEDURE..... 547*
- 9.2. *802.11n HT20 1Tx MODE IN THE 5.2 GHz BAND 548*
- 9.3. *802.11n HT20 2Tx CDD MODE IN THE 5.2 GHz BAND 564*
- 9.4. *802.11n HT40 1Tx MODE IN THE 5.2 GHz BAND 572*
- 9.5. *802.11n HT40 2Tx CDD MODE IN THE 5.2 GHz BAND 584*
- 9.6. *802.11ac VHT80 1Tx MODE IN THE 5.2 GHz BAND..... 590*
- 9.7. *802.11ac VHT80 2Tx CDD MODE IN THE 5.2 GHz BAND 598*
- 9.8. *802.11n HT20 1Tx MODE IN THE 5.3 GHz BAND 602*
- 9.9. *802.11n HT20 2Tx CDD MODE IN THE 5.3 GHz BAND 618*
- 9.10. *802.11n HT40 1Tx MODE IN THE 5.3 GHz BAND 626*
- 9.11. *802.11n HT40 2Tx CDD MODE IN THE 5.3 GHz BAND..... 638*
- 9.12. *802.11ac VHT80 1Tx MODE IN THE 5.3 GHz BAND 644*
- 9.13. *802.11ac VHT80 2Tx CDD MODE IN THE 5.3 GHz BAND..... 652*
- 9.14. *802.11n HT20 1Tx MODE IN THE 5.6 GHz BAND 656*
- 9.15. *802.11n HT20 2Tx CDD MODE IN THE 5.6 GHz BAND..... 680*
- 9.16. *802.11n HT40 1Tx MODE IN THE 5.6 GHz BAND 692*
- 9.17. *802.11n HT40 2Tx CDD MODE IN THE 5.6 GHz BAND..... 716*
- 9.18. *802.11ac VHT80 1Tx MODE IN THE 5.6 GHz BAND 728*
- 9.19. *802.11ac VHT80 2Tx CDD MODE IN THE 5.6 GHz BAND..... 744*
- 9.20. *802.11n HT20 1Tx MODE IN THE 5.8 GHz BAND 752*
- 9.21. *802.11n HT20 2Tx CDD MODE IN THE 5.8 GHz BAND..... 772*
- 9.22. *802.11n HT40 1Tx MODE IN THE 5.8 GHz BAND 782*
- 9.23. *802.11n HT40 2Tx CDD MODE IN THE 5.8 GHz BAND..... 798*
- 9.24. *802.11ac VHT80 1Tx MODE IN THE 5.8 GHz BAND 806*
- 9.25. *802.11ac VHT80 2Tx CDD MODE IN THE 5.8 GHz BAND..... 818*
- 9.26. *WORST CASE CO-LOCATION 824*
- 9.27. *WORST-CASE BELOW 1 GHz..... 828*
- 9.28. *WORST-CASE ABOVE 18 GHz 830*

10. AC POWER LINE CONDUCTED EMISSIONS 834

- 10.1. *EUT POWERED BY AC ADAPTER..... 835*
- 10.2. *EUT POWERED BY HOST PC VIA USB CABLE 837*

11. DYNAMIC FREQUENCY SELECTION..... 839

- 11.1. *OVERVIEW 839*
 - 11.1.1. *LIMITS..... 839*
 - 11.1.1. *TEST AND MEASUREMENT SYSTEM 843*

11.1.2.	SETUP OF EUT (CLIENT MODE)	846
11.1.3.	SETUP OF EUT (CLIENT-TO-CLIENT COMMUNICATIONS MODE).....	847
11.1.4.	DESCRIPTION OF EUT	848
11.2.	<i>CLIENT MODE RESULTS FOR 20 MHz BANDWIDTH</i>	850
11.2.1.	TEST CHANNEL.....	850
11.2.2.	RADAR WAVEFORM AND TRAFFIC.....	850
11.2.3.	OVERLAPPING CHANNEL TESTS.....	853
11.2.4.	MOVE AND CLOSING TIME	853
11.3.	<i>CLIENT MODE RESULTS FOR 40 MHz BANDWIDTH</i>	857
11.3.1.	TEST CHANNEL.....	857
11.3.2.	RADAR WAVEFORM AND TRAFFIC.....	857
11.3.3.	OVERLAPPING CHANNEL TESTS.....	860
11.3.4.	MOVE AND CLOSING TIME	860
11.3.5.	10-MINUTE CLIENT Tx MONITORING PERIOD.....	864
11.4.	<i>CLIENT MODE RESULTS FOR 80 MHz BANDWIDTH</i>	865
11.4.1.	TEST CHANNEL.....	865
11.4.2.	RADAR WAVEFORM AND TRAFFIC.....	865
11.4.3.	OVERLAPPING CHANNEL TESTS.....	868
11.4.4.	MOVE AND CLOSING TIME	868
11.4.5.	10-MINUTE CLIENT Tx MONITORING PERIOD.....	872
11.5.	<i>-CLIENT-TO-CLIENT COMMUNICATIONS MODE RESULTS FOR 20 MHz BANDWIDTH</i> 873	
11.5.1.	TEST CHANNEL.....	873
11.5.2.	RADAR WAVEFORM AND TRAFFIC.....	873
11.5.3.	OVERLAPPING CHANNEL TESTS.....	876
11.5.4.	MOVE AND CLOSING TIME	876
11.6.	<i>CLIENT-TO-CLIENT COMMUNICATIONS MODE RESULTS FOR 40 MHz BANDWIDTH</i> 880	
11.6.1.	TEST CHANNEL.....	880
11.6.2.	RADAR WAVEFORM AND TRAFFIC.....	880
11.6.3.	OVERLAPPING CHANNEL TESTS.....	883
11.6.4.	MOVE AND CLOSING TIME	883
11.6.5.	10-MINUTE CLIENT Tx MONITORING PERIOD.....	887
11.7.	<i>CLIENT-TO-CLIENT COMMUNICATIONS MODE RESULTS FOR 80 MHz BANDWIDTH</i> 888	
11.7.1.	TEST CHANNEL.....	888
11.7.2.	RADAR WAVEFORM AND TRAFFIC.....	888
11.7.3.	OVERLAPPING CHANNEL TESTS.....	891
11.7.4.	MOVE AND CLOSING TIME	891
11.7.5.	10-MINUTE CLIENT Tx MONITORING PERIOD.....	895
12.	SETUP PHOTOS.....	896
12.1.	<i>ANTENNA PORT CONDUCTED RF MEASUREMENT SETUP</i>	896
12.2.	<i>RADIATED RF MEASUREMENT SETUP (BELOW 1 GHz).....</i>	897
12.3.	<i>RADIATED RF MEASUREMENT SETUP FOR PORTABLE CONFIGURATION.....</i>	898
12.4.	<i>POWERLINE CONDUCTED EMISSIONS MEASUREMENT SETUP</i>	901
12.5.	<i>DYNAMIC FREQUENCY SELECTION MEASUREMENT SETUP.....</i>	902
12.5.1.	STANDARD CLIENT MODE.....	902

12.5.2. CLIENT TO CLIENT MODE 904

1. ATTESTATION OF TEST RESULTS

COMPANY NAME: APPLE, INC.
1 INFINITE LOOP
CUPERTINO, CA 95014, U.S.A.

EUT DESCRIPTION: TABLET DEVICE

MODEL: A1584

SERIAL NUMBER: DLXQ100DGPCT (Conducted); DLXQ100FGPCT (Radiated)

DATE TESTED: July 20, 2015 to September 02, 2015

APPLICABLE STANDARDS	
STANDARD	TEST RESULTS
CFR 47 Part 15 Subpart E	Pass

UL Verification Services Inc. tested the above equipment in accordance with the requirements set forth in the above standards. All indications of Pass/Fail in this report are opinions expressed by UL Verification Services Inc. based on interpretations and/or observations of test results. Measurement Uncertainties were not taken into account and are published for informational purposes only. The test results show that the equipment tested is capable of demonstrating compliance with the requirements as documented in this report.

Note: The results documented in this report apply only to the tested sample, under the conditions and modes of operation as described herein. This document may not be altered or revised in any way unless done so by UL Verification Services Inc. and all revisions are duly noted in the revisions section. Any alteration of this document not carried out by UL Verification Services Inc. will constitute fraud and shall nullify the document. This report must not be used by the client to claim product certification, approval, or endorsement by NVLAP, NIST, any agency of the Federal Government, or any agency of any government.

Approved & Released For
UL Verification Services Inc. By:

Tested By:

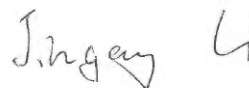
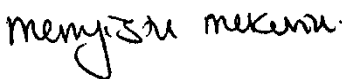

MENGISTU MEKURIA
SENIOR ENGINEER
UL VERIFICATION SERVICES INC.

JINGANG LI
EMC LAB TECHNICIAN
UL VERIFICATION SERVICES INC.

2. TEST METHODOLOGY

FCC: The tests documented in this report were performed in accordance with FCC CFR 47 Part 2, FCC CFR 47 Part 15, FCC 14-30, FCC KDB 662911 D01 v02r01, FCC KDB 905462 D02 v01r01/D03 v01r01/D06 v01, FCC KDB 789033 D02, FCC KDB 644545 D03 v01 and ANSI C63.10-2013.

3. FACILITIES AND ACCREDITATION

The test sites and measurement facilities used to collect data are located at 47173 and 47266 Benicia Street, Fremont, California, USA. Line conducted emissions are measured only at the 47173 address. The following table identifies which facilities were utilized for radiated emission measurements documented in this report. Specific facilities are also identified in the test results sections.

47173 Benicia Street	47266 Benicia Street
<input type="checkbox"/> Chamber A	<input checked="" type="checkbox"/> Chamber D
<input type="checkbox"/> Chamber B	<input checked="" type="checkbox"/> Chamber E
<input type="checkbox"/> Chamber C	<input checked="" type="checkbox"/> Chamber F
	<input type="checkbox"/> Chamber G
	<input checked="" type="checkbox"/> Chamber H

The above test sites and facilities are covered under FCC Test Firm Registration # 208313. Chambers A through H are covered under Industry Canada company address code 2324B with site numbers 2324B -1 through 2324B-8, respectively.

UL Verification Services Inc. is accredited by NVLAP, Laboratory Code 200065-0. The full scope of accreditation can be viewed at <http://ts.nist.gov/standards/scopes/2000650.htm>.

4. CALIBRATION AND UNCERTAINTY

4.1. MEASURING INSTRUMENT CALIBRATION

The measuring equipment utilized to perform the tests documented in this report has been calibrated in accordance with the manufacturer's recommendations, and is traceable to recognized national standards.

4.2. SAMPLE CALCULATION

Where relevant, the following sample calculation is provided:

$$\begin{aligned} \text{Field Strength (dBuV/m)} &= \text{Measured Voltage (dBuV)} + \text{Antenna Factor (dB/m)} + \text{Cable} \\ &\text{Loss (dB)} - \text{Preamp Gain (dB)} \\ 36.5 \text{ dBuV} + 18.7 \text{ dB/m} + 0.6 \text{ dB} - 26.9 \text{ dB} &= 28.9 \text{ dBuV/m} \end{aligned}$$

4.3. MEASUREMENT UNCERTAINTY

Where relevant, the following measurement uncertainty levels have been estimated for tests performed on the apparatus:

PARAMETER	UNCERTAINTY
Conducted Disturbance, 0.15 to 30 MHz	± 3.52 dB
Radiated Disturbance, 30 to 1000 MHz	± 4.94 dB
Radiated Disturbance, 1 to 6 GHz	± 3.86 dB
Radiated Disturbance, 6 to 18 GHz	± 4.23 dB
Radiated Disturbance, 18 to 26 GHz	± 5.30 dB
Radiated Disturbance, 26 to 40 GHz	± 5.23 dB

Uncertainty figures are valid to a confidence level of 95%.

5. EQUIPMENT UNDER TEST

5.1. DESCRIPTION OF EUT

The EUT is a tablet with multimedia functions (music, application support, and video), IEEE 802.11a/b/g/n/ac radio, and Bluetooth radio. The rechargeable battery is not user accessible.

5.2. MAXIMUM OUTPUT POWER

The transmitter has a maximum conducted output power as follows:

5.2GHz Band (FCC)

Frequency Range (MHz)	Mode	Output Power (dBm)	Output Power (mW)
5180 - 5240	802.11a	Covered by 802.11n HT20 SISO	
	802.11n HT20 SISO	17.00	50.12
	802.11a 2TX CDD	Covered by 802.11n HT20 CDD 2TX	
	802.11n HT20 2TX CDD	19.47	88.51
	802.11n HT20 2TX STBC	20.00	100.00
	802.11n HT20 2TX SDM	Covered by 802.11n HT20 STBC 2TX	
5190 - 5230	802.11n HT40 SISO	16.89	48.87
	802.11n HT40 2TX CDD	19.49	88.92
	802.11n HT40 2TX STBC	19.99	99.77
	802.11n HT40 2TX SDM	Covered by 802.11n HT40 STBC 2TX	
5210	802.11ac VHT80 SISO	13.00	19.95
	802.11ac VHT80 2TX CDD	15.43	34.91
	802.11ac VHT80 2TX STBC/SDM	Covered by 802.11ac VHT80 CDD 2TX	

5.3GHz Band

Frequency Range (MHz)	Mode	Output Power (dBm)	Output Power (mW)
5260 - 5320	802.11a	Covered by 802.11n HT20 SISO	
	802.11n HT20 SISO	16.90	48.98
	802.11a 2TX CDD	Covered by 802.11n HT20 CDD 2TX	
	802.11n HT20 2TX CDD	18.94	78.34
	802.11n HT20 2TX STBC	19.67	92.68
	802.11n HT20 2TX SDM	Covered by 802.11n HT20 STBC 2TX	
5270 - 5310	802.11n HT40 SISO	16.84	48.31
	802.11n HT40 2TX CDD	19.00	79.43
	802.11n HT40 2TX STBC	19.75	94.41
	802.11n HT20 2TX SDM	Covered by 802.11n HT20 STBC 2TX	
5290	802.11ac VHT80 SISO	14.50	28.18
	802.11ac VHT80 2TX CDD	15.92	39.08
	802.11ac VHT80 2TX STBC/SDM	Covered by 802.11ac VHT80 CDD 2TX	

5.6GHz Band

Frequency Range (MHz)	Mode	Output Power (dBm)	Output Power (mW)
5500 - 5700	802.11a	Covered by 802.11n HT20 SISO	
5720	802.11a	Covered by 802.11n HT20 SISO	
5500 - 5700	802.11n HT20 SISO	16.00	39.81
5720	802.11n HT20 SISO	14.66	29.24
5500 - 5700	802.11a 2TX CDD	Covered by 802.11n HT20 CDD 2TX	
5720	802.11a 2TX CDD	Covered by 802.11n HT20 CDD 2TX	
5500 - 5700	802.11n HT20 2TX CDD	18.67	73.62
5720	802.11n HT20 2TX CDD	17.33	54.08
5500 - 5700	802.11n HT20 2TX STBC/SDM	Covered by 802.11n HT20 CDD 2TX	
5720	802.11n HT20 2TX STBC/SDM	Covered by 802.11n HT20 CDD 2TX	
5510 - 5670	802.11n HT40 SISO	16.00	39.81
5710	802.11n HT40 SISO	14.52	28.31
5510 - 5670	802.11n HT40 2TX CDD	18.66	73.45
5710	802.11n HT40 2TX CDD	17.14	51.76
5510 - 5670	802.11n HT40 2TX STBC/SDM	Covered by 802.11n HT40 CDD 2TX	
5710	802.11n HT40 2TX STBC/SDM	Covered by 802.11n HT40 CDD 2TX	
5530-5610	802.11ac VHT80 SISO	15.92	39.08
5690	802.11ac VHT80 SISO	15.92	39.08
5530-5610	802.11ac VHT80 2TX CDD	18.65	73.28
5690	802.11ac VHT80 2TX CDD	18.88	77.27
5530-5610	802.11ac VHT80 2TX STBC/SDM	Covered by 802.11ac VHT80 CDD 2TX	
5690	802.11ac VHT80 2TX STBC/SDM	Covered by 802.11ac VHT80 CDD 2TX	

5.8GHz Band

Frequency Range (MHz)	Mode	Output Power (dBm)	Output Power (mW)
5745 - 5825	802.11a	Covered by 802.11n HT20 SISO	
5745 - 5825	802.11n HT20 SISO	16.50	44.67
5745 - 5825	802.11a 2TX CDD	Covered by 802.11n HT20 CDD 2TX	
5745 - 5825	802.11n HT20 2TX CDD	18.74	74.82
5745 - 5825	802.11n HT20 2TX STBC/SDM	Covered by 802.11n HT20 CDD 2TX	
5755 - 5795	802.11n HT40 SISO	15.93	39.17
5755 - 5795	802.11n HT40 2TX CDD	18.48	70.47
5755 - 5795	802.11n HT40 2TX STBC/SDM	Covered by 802.11n HT40 CDD 2TX	
5775	802.11ac VHT80 SISO	14.45	27.86
5775	802.11ac VHT80 2TX CDD	16.93	49.32
5775	802.11ac VHT80 2TX STBC/SDM	Covered by 802.11ac VHT80 CDD 2TX	

5.3. DESCRIPTION OF AVAILABLE ANTENNAS

Frequency Band (GHz)	Antenna Gain	
	Antenna 1	Antenna 2
5.2	1.90	2.30
5.3	2.30	2.90
5.5	2.70	3.10
5.8	2.40	3.10

5.4. SOFTWARE AND FIRMWARE

The software installed in the EUT during testing was 13B72.

5.5. WORST-CASE CONFIGURATION AND MODE

Radiated emission and power line conducted emission were performed with the EUT set to transmit at the channel with highest output power as worst-case scenario.

For SISO modes, there are two transmission antennas. The antenna used in any given time can be either Chain 0 or Chain 1. Both antenna ports have the same power; output power and PSD measurement for SISO modes are both reported. For MIMO modes, both Chain 0 and Chain 1 used at the same time.

The fundamental of the EUT was investigated in three orthogonal orientations X (Flatbed), Y (Landscape), Z (Portrait), it was determined that (see table below) was worst-case orientations. Therefore, all final radiated testing was performed with the EUT in (see table below) orientation.

Frequency Band (GHz)	Mode	Antenna Port	Worst-case Orientation
5.2-5.8	1TX SISO	Chain 0	Y-Landscape
		Chain 1	Y-Landscape
	2TX MIMO	Chain 0 + Chain 1	Y-Landscape

Worst-case data rates as provided by the client were:

- 802.11a mode: 6 Mbps
- 802.11n HT20 mode: MCS0
- 802.11n HT40 mode: MCS0
- 802.11ac VHT20 mode: MCS0
- 802.11ac VHT40 mode: MCS0
- 802.11ac VHT80 mode: MCS0

802.11ac VHT20 and VHT40 mode are different from 802.11nHT20 and HT40 only in control messages and have the same power settings.

There are two vendors of the radio modules: variant 1 and variant 2. The Wi-Fi/Bluetooth radio modules have the same mechanical outline (e.g., the same package dimension and pin-out layout), use the same on-board antenna matching circuit, have an identical antenna structure, and are built and tested to conform to the same specifications and to operate within the same tolerances.

Baseline testing was performed on the two variants to determine the worst case on all conducted power and radiated emissions.

For simultaneous transmission of multiple channels from the same antenna in BT/BLE and WLAN 5 GHz bands. Baseline testing was performed on various configurations to determine the worst case on radiated emissions.

The following configurations were investigated on AC line conducted test.

Configuration	Descriptions
1	EUT powered by AC/DC adapter via USB cable
2	EUT powered by host PC via USB cable

5.6. DESCRIPTION OF TEST SETUP

SUPPORT EQUIPMENT

Support Equipment List				
Description	Manufacturer	Model	Serial Number	FCC ID
Laptop	Dell	Latitude 3540	6LNG802	N/A
Laptop AC/DC adapter	Dell	FA90PE1-00	CN-0CM889-73245-95L-4954-A00	N/A
Earphone	Apple	NA	NA	N/A
EUT AC/DC adapter	Apple	A1385	D293062F3WVDHLHCF	N/A

I/O CABLES (CONDUCTED TEST)

I/O Cable List						
Cable No	Port	# of identical ports	Connector Type	Cable Type	Cable Length (m)	Remarks
1	Antenna	2	SMA	Un-Shielded	0.2	To spectrum Analyzer
2	USB	1	USB	Shielded	1	N/A
3	AC	1	AC	Un-shielded	3	N/A

I/O CABLES (RADIATED ABOVE 1 GHZ)

I/O Cable List						
Cable No	Port	# of identical ports	Connector Type	Cable Type	Cable Length (m)	Remarks
None used						

I/O CABLES (AC POWER CONDUCTED TEST AND BELOW 1 GHZ)

I/O Cable List						
Cable No	Port	# of identical ports	Connector Type	Cable Type	Cable Length (m)	Remarks
1	Headphones Jack	1	3.5mm Audio	Shielded	0.9	N/A
2	AC	1	AC	Un-shielded	3	N/A

I/O CABLES (AC LINE CONDUCTED: LAPTOP CONFIGUARTION)

I/O Cable List						
Cable No	Port	# of identical	Connector Type	Cable Type	Cable Length (m)	Remarks
1	Headphones Jack	1	3.5mm Audio	Shielded	0.9	N/A
2	USB	1	USB	Shielded	1	N/A
3	AC	1	AC	Un-shielded	3	N/A

TEST SETUP

The EUT was tested connected to a host Laptop via USB cable and to spectrum analyzer via antenna port. Test software exercised the EUT.

SETUP DIAGRAM

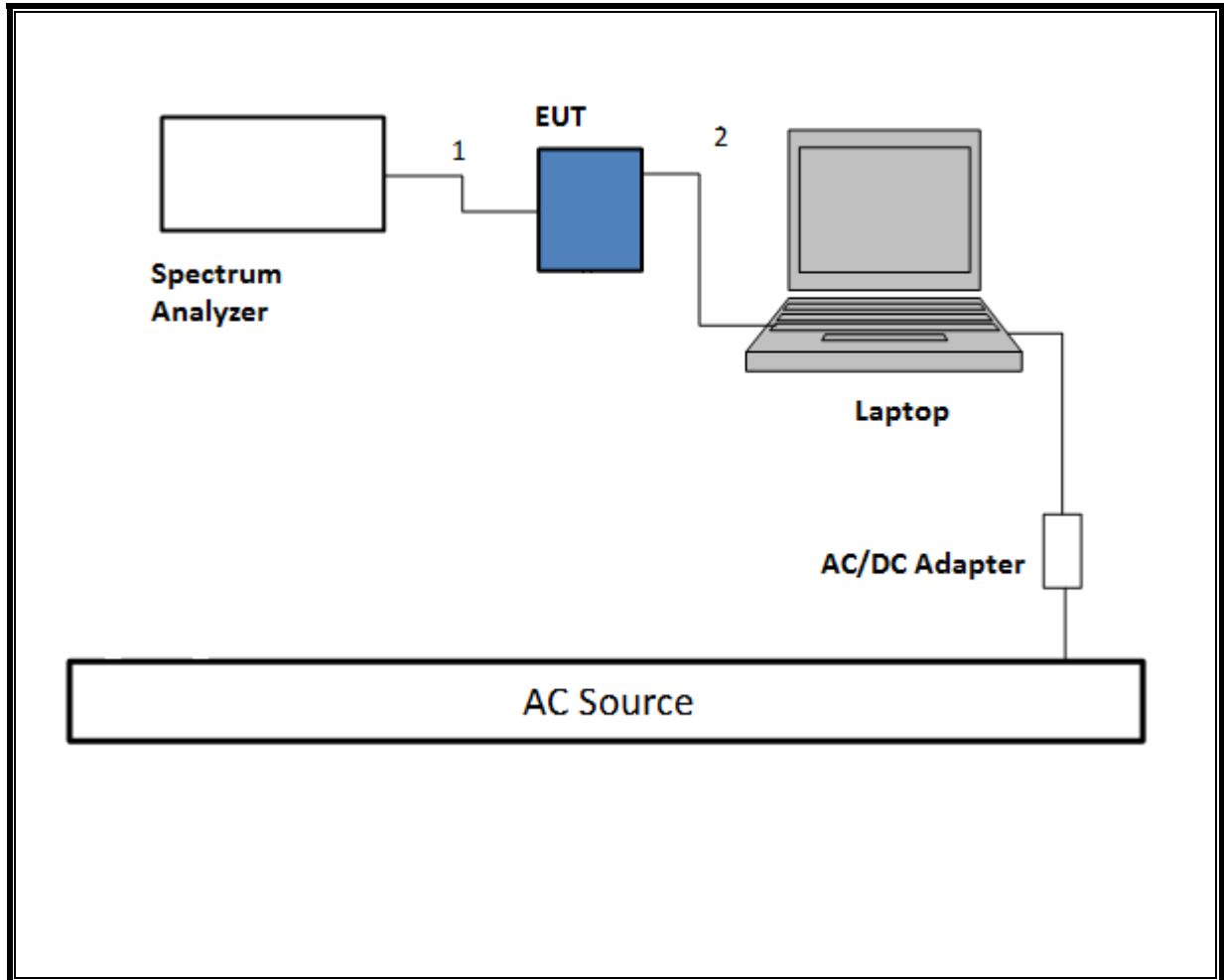

TEST SETUP- RADIATED-ABOVE 1 GHZ

The EUT was tested battery powered. Test software exercised the EUT.

SETUP DIAGRAM

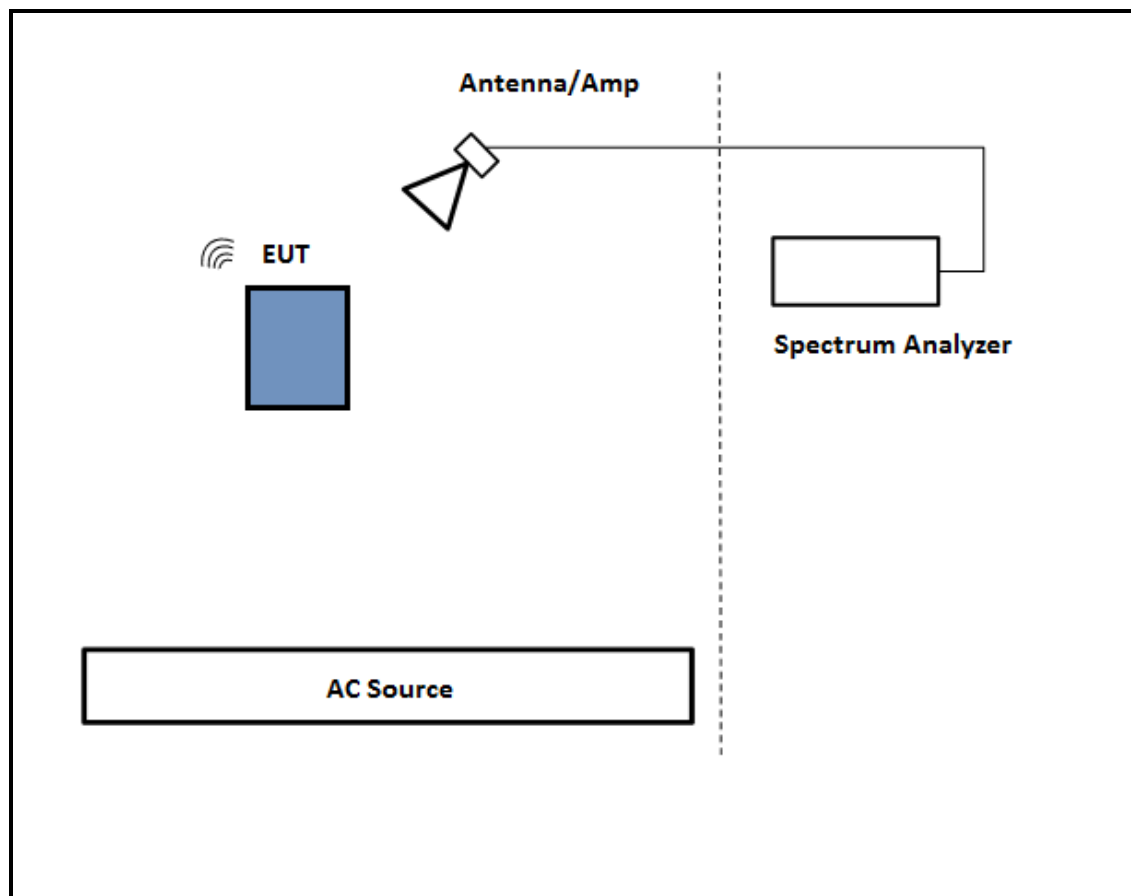

TEST SETUP- BELOW 1GHZ

The EUT was tested with earphone connected and powered by AC adapter. Test software exercised the EUT.

SETUP DIAGRAM

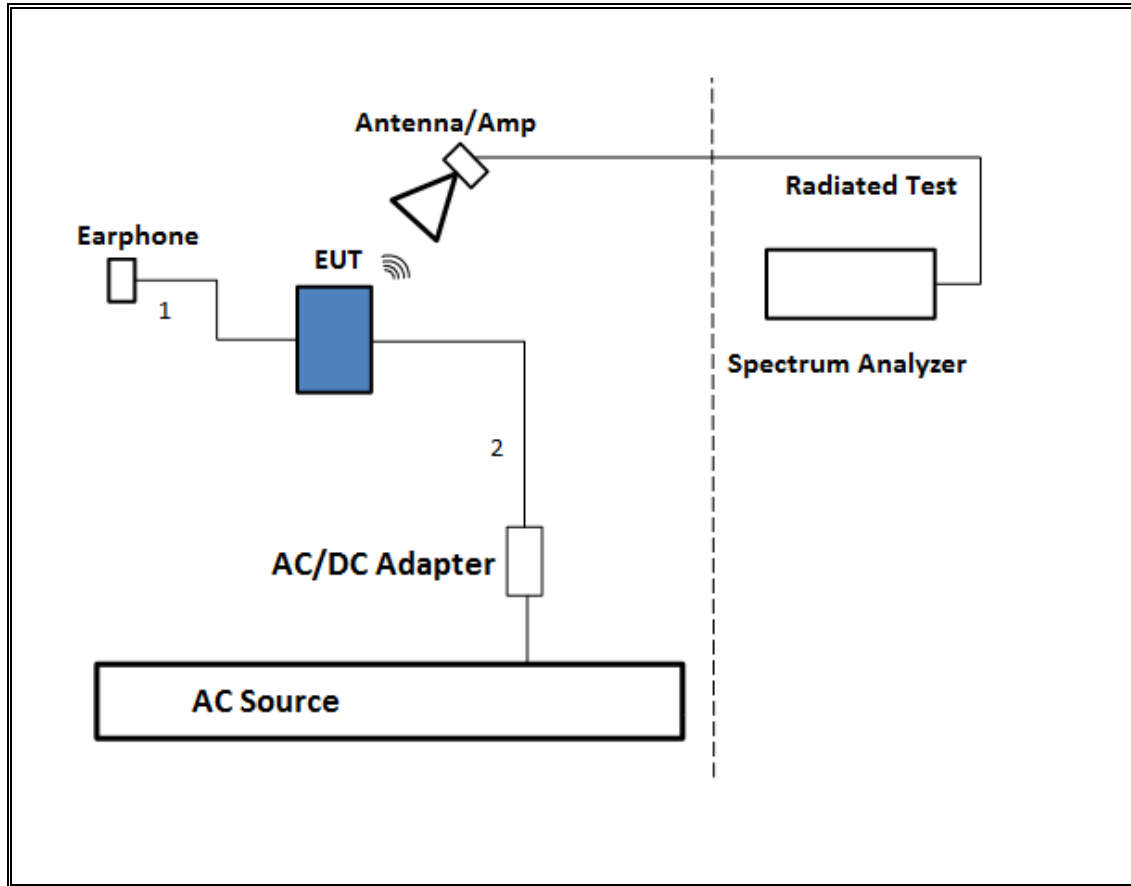

TEST SETUP- AC LINE CONDUCTED: AC/DC ADAPTER

The EUT was tested with earphone connected and powered by AC/DC adapter via USB cable. Test software exercised the EUT.

SETUP DIAGRAM

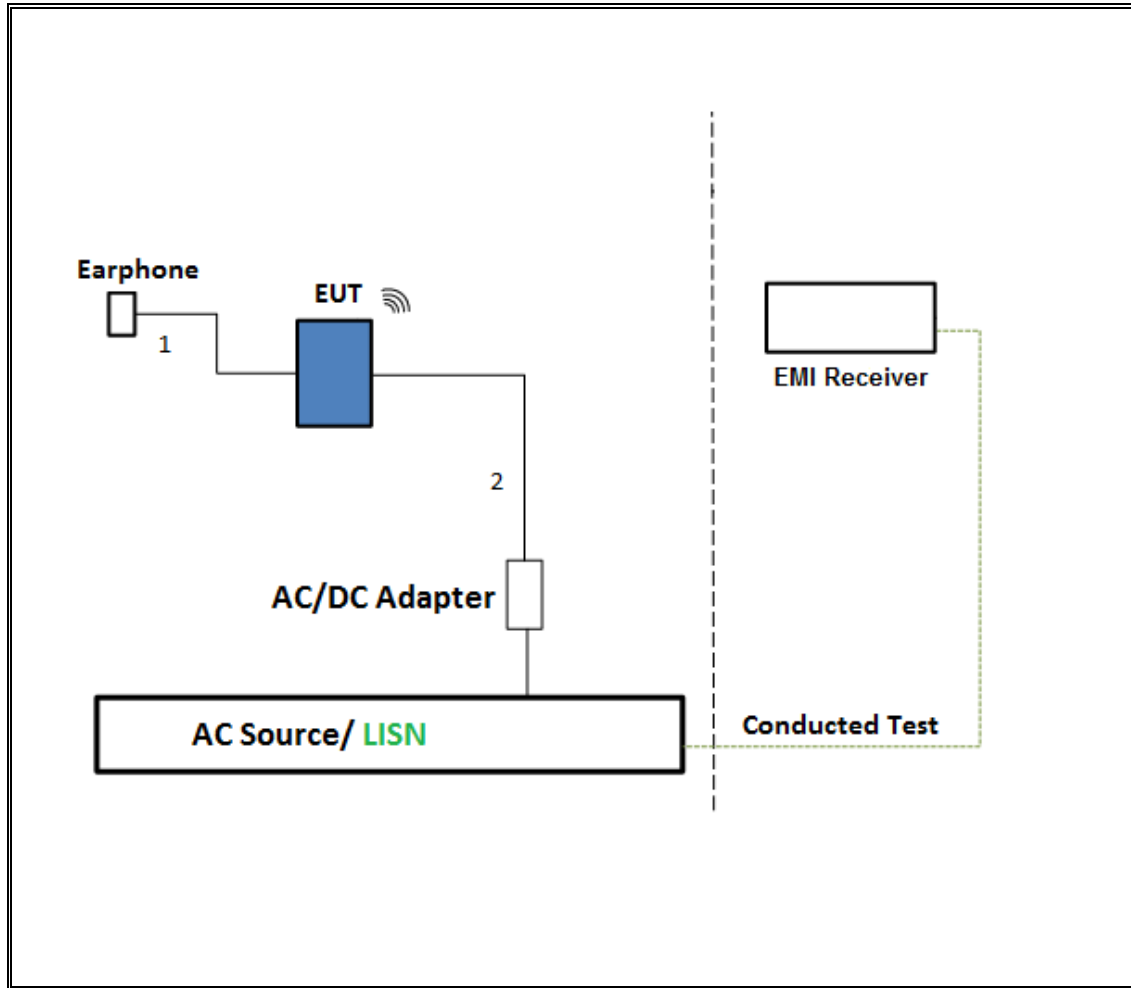

6. TEST AND MEASUREMENT EQUIPMENT

The following test and measurement equipment was utilized for the tests documented in this report:

Test Equipment List				
Description	Manufacturer	Model	Asset	Cal Due
Antenna, Horn 1-18GHz	ETS Lindgren	3117	00143448	2/10/2016
Antenna, Broadband Hybrid, 30MHz to 2000MHz	Sunol Sciences	JB3	A022813-1	1/14/2016
Amplifier, 1 - 18GHz	Miteq	AFS42-00101800-25-S-42	1782158	1/26/2016
Amplifier, 10KHz to 1GHz, 32dB	Sonoma	310N	323561	5/28/2016
Spectrum Analyzer, PXA, 3Hz to 50GHz	Agilent	N9030A	MY52350427	9/13/2015
Amplifier, 10KHz to 1GHz, 32dB	Sonoma	310N	325117	6/5/2016
Spectrum Analyzer, PXA, 3Hz to 44GHz	Agilent	N9030A	MY53310959	5/7/2016
Power Meter, P-series single channel	Agilent	N1911A	GB45100212	10/9/2015
Power Sensor, P - series, 50MHz to 18GHz, Wideband	Agilent	N1921A	MY53260010	7/12/2016
Power Meter, Peak	Boonton	4541		7/17/2016
Power Sensor, Peak	Boonton	57006		7/17/2016
Antenna, Horn 18 to 26.5GHz	ARA	MWH-1826	1049	12/17/2015
Horn Antenna, 40GHz	ARA	MWH-2640/B	1029	7/15/2016
Spectrum Analyzer, 40 GHz	Agilent	8564E	3943A01643	8/6/2016
Amplifier, 1 to 26.5GHz, 23.5dB Gain minimum	Agilent	8449B	3008A01114	10/4/2015
Amplifier, 26 to 40GHz	Miteq	NSP4000-SP2	1029	9/3/2015
AC Line Conducted				
EMI Test Receiver 9Khz-7GHz	Rohde & Schwarz	ESCI7	100935	9/16/2015
LISN for Conducted Emissions CISPR-16	FCC	50/250-25-2	114	1/16/2016
Power Cable, Line Conducted Emissions ANSI 63.4	U L	PG1	N/A	7/28/2015
UL SOFTWARE				
* Radiated Software	UL	UL EMC	Ver 9.5, July 22, 2014	
* Conducted Software	UL	UL EMC	Ver 2.2, March 31, 2015	
* AC Line Conducted Software	UL	UL EMC	Ver 9.5, April 3, 2015	

Note: * indicates automation software version used in the compliance certification testing

7. ON TIME, DUTY CYCLE AND MEASUREMENT METHODS

7.1. ON TIME AND DUTY CYCLE

LIMITS

None; for reporting purposes only.

PROCEDURE

KDB 789033 Zero-Span Spectrum Analyzer Method.

RESULTS

Mode	ON Time B (msec)	Period (msec)	Duty Cycle x (linear)	Duty Cycle (%)	Duty Cycle Correction Factor (dB)	1/B Minimum VBW (kHz)
802.11n HT20 1TX	1.920	1.941	0.989	98.92%	0.00	0.010
802.11n HT20 CDD	1.920	1.941	0.989	98.92%	0.00	0.010
802.11n HT40 1TX	1.124	1.142	0.984	98.42%	0.00	0.010
802.11n HT40 CDD	1.124	1.142	0.984	98.42%	0.00	0.010
802.11ac VHT80 1TX	0.542	0.566	0.958	95.76%	0.19	1.845
802.11ac VHT80 CDD	0.460	0.484	0.950	95.04%	0.22	2.174

DUTY CYCLE PLOTS

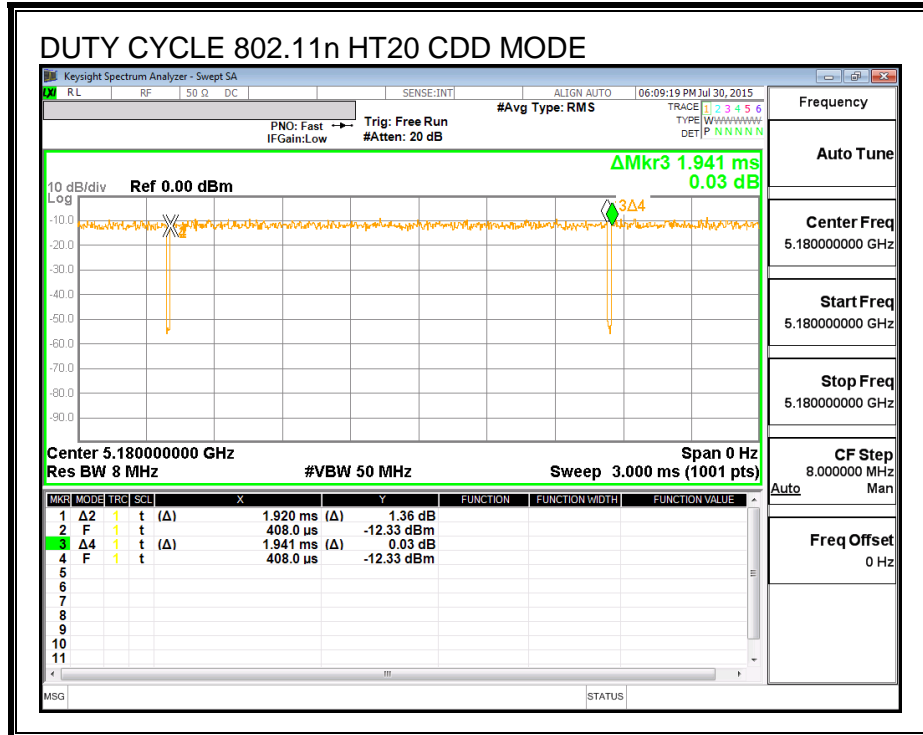
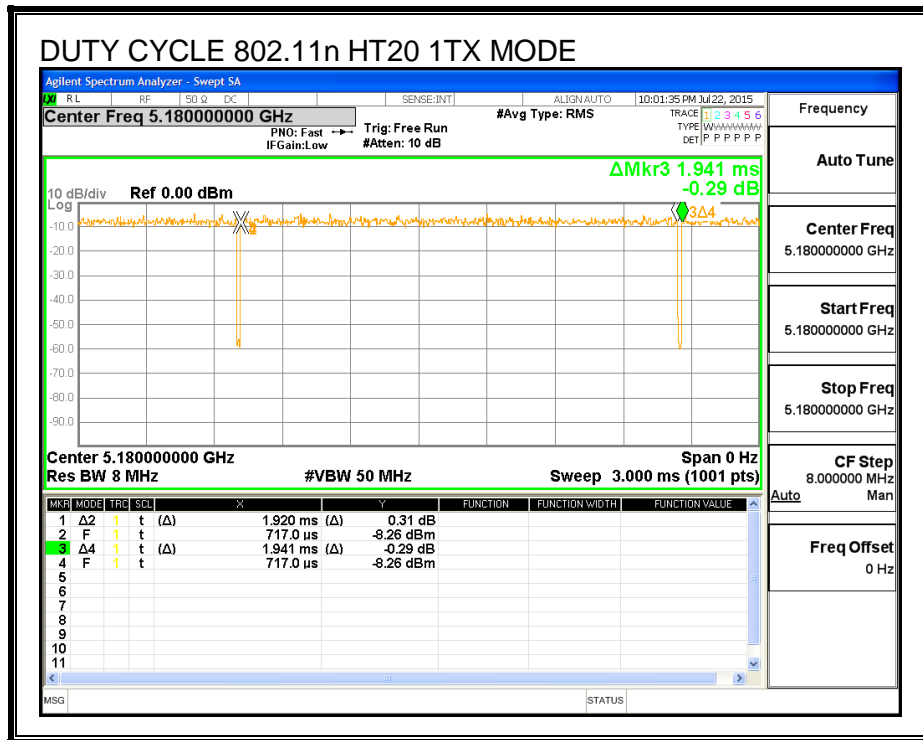

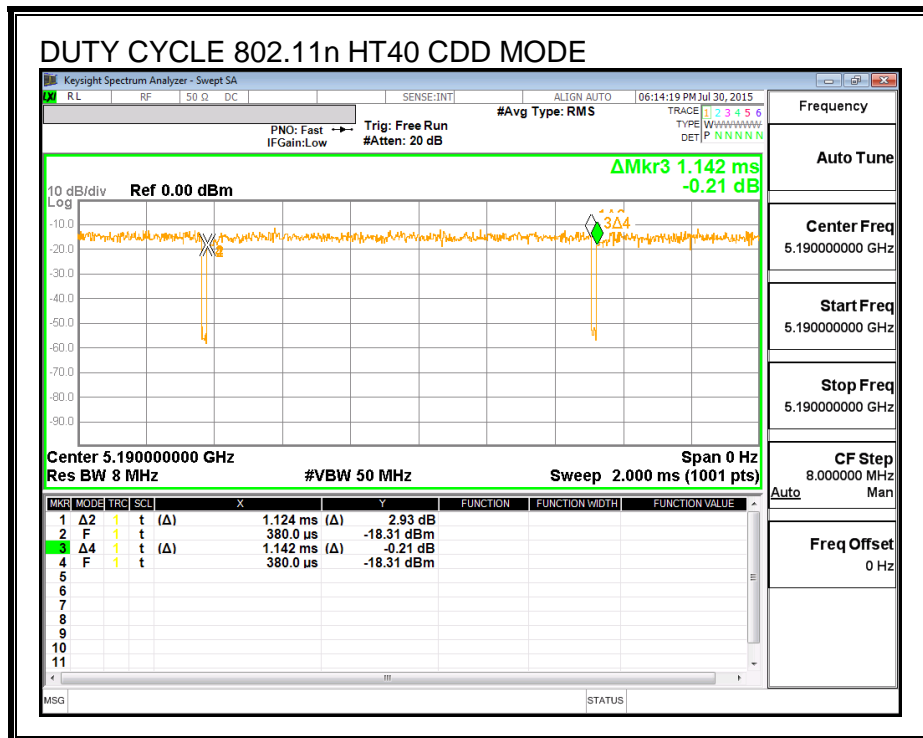
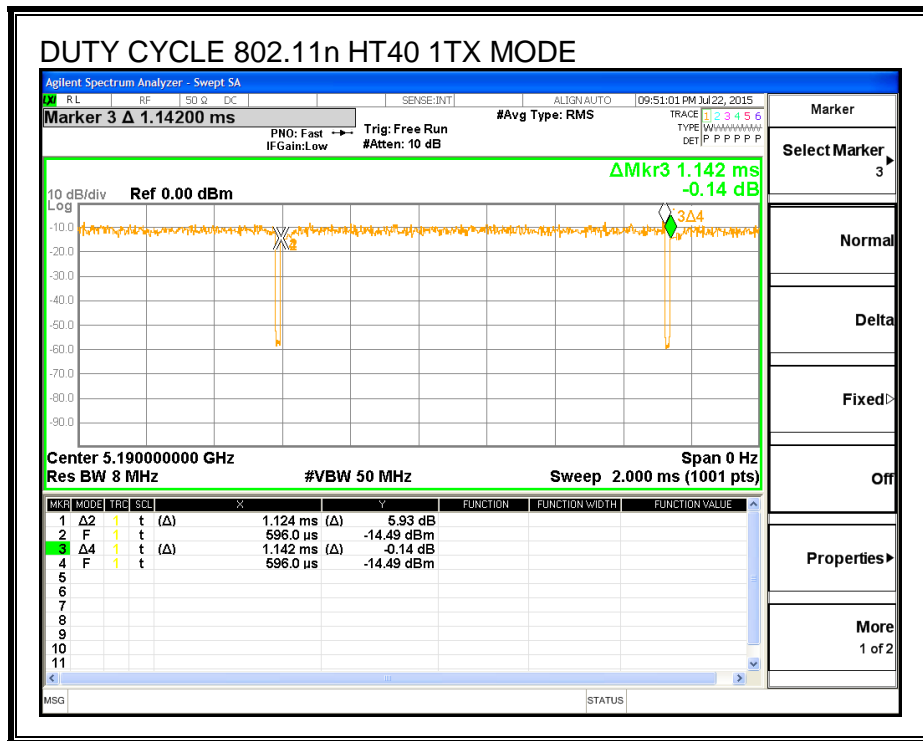

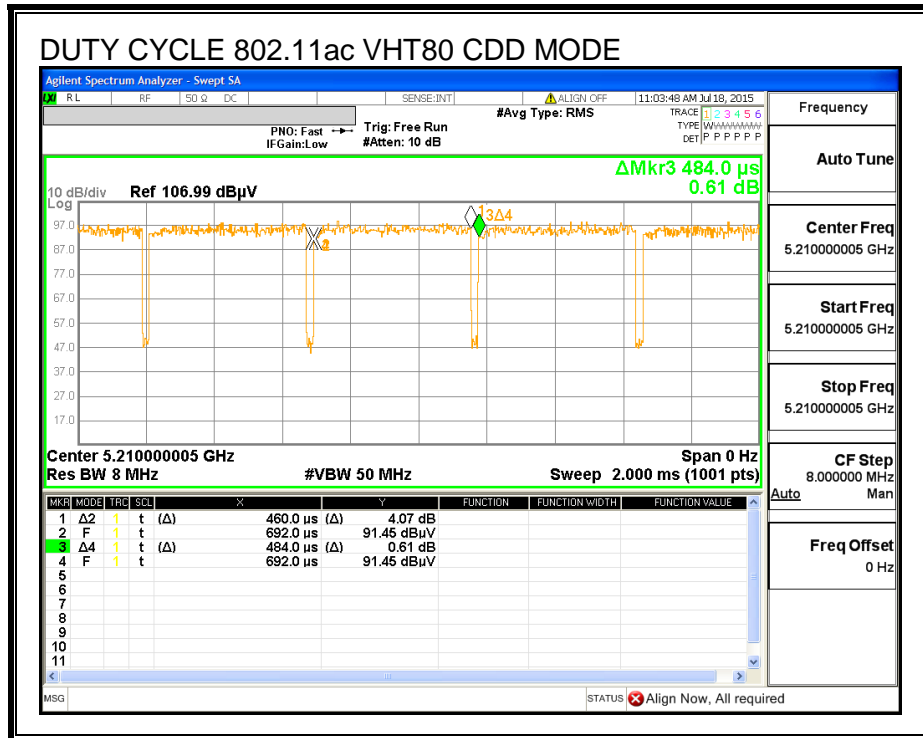
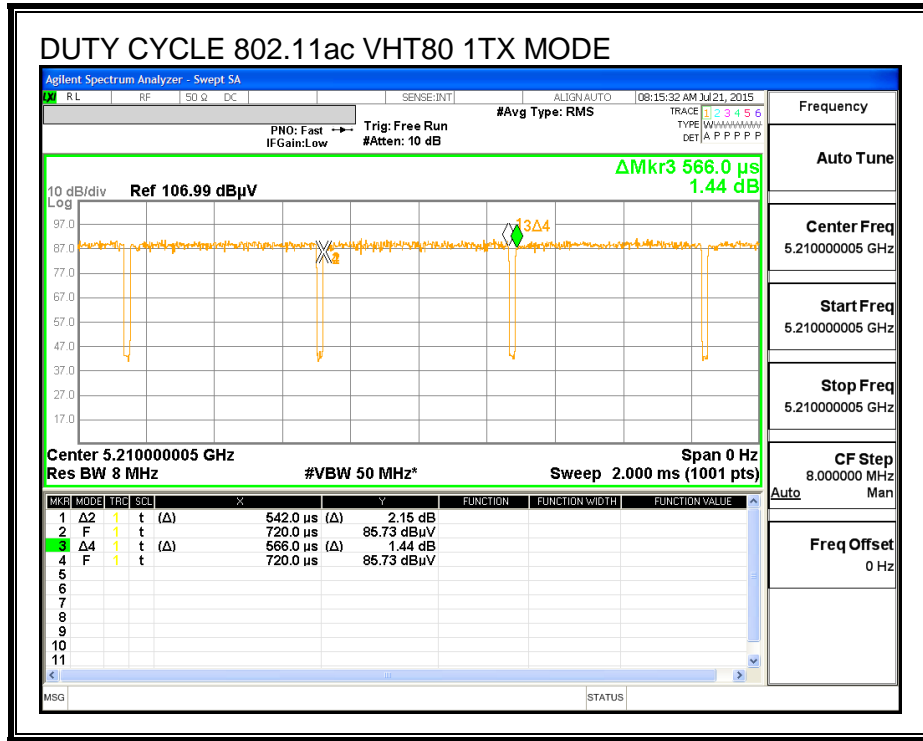

7.2. MEASUREMENT METHODS

26 dB Emission BW: KDB 789033 D02 v01, Section C.

99% Occupied BW: KDB 789033 D02 v01, Section D.

Conducted Output Power: KDB 789033 D02 v01, Section E.3.a (Method PM).

Power Spectral Density: KDB 789033 D02 v01, Section F.

Unwanted emissions in restricted bands: KDB 789033 D02 v01, Sections G.3, G.4, G.5, and G.6.

Unwanted emissions in non-restricted bands: KDB 789033 D02 v01, Sections G.3, G.4, and G.5.

8. ANTENNA PORT TEST RESULTS

8.1. 802.11a MODE IN THE 5.2 GHz BAND

Note: Covered by 802.11n HT20 SISO MODE

8.2. 802.11n HT20 CHAIN 0 MODE IN THE 5.2 GHz BAND

8.2.1. 26 dB BANDWIDTH

LIMITS

None; for reporting purposes only.

RESULTS

Channel	Frequency (MHz)	26 dB Bandwidth (MHz)
Low	5180	22.14
Mid	5200	22.11
High	5240	22.20

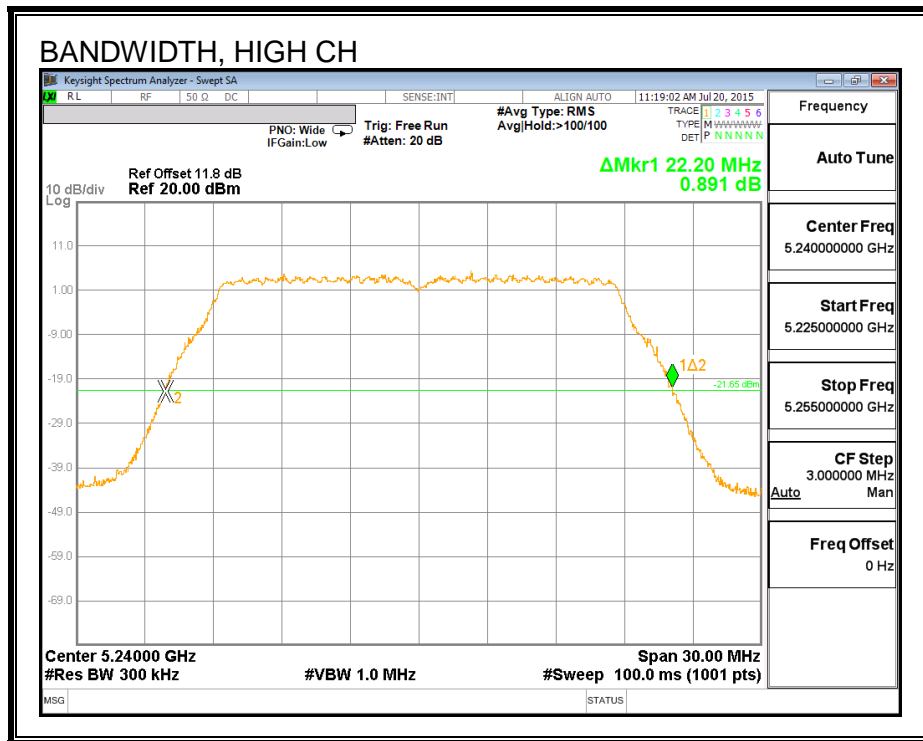

8.2.2. 99% BANDWIDTH

LIMITS

None; for reporting purposes only.

RESULTS

Channel	Frequency (MHz)	99% BW (MHz)
Low	5180	17.919
Mid	5200	17.998
High	5240	17.832

99% BANDWIDTH

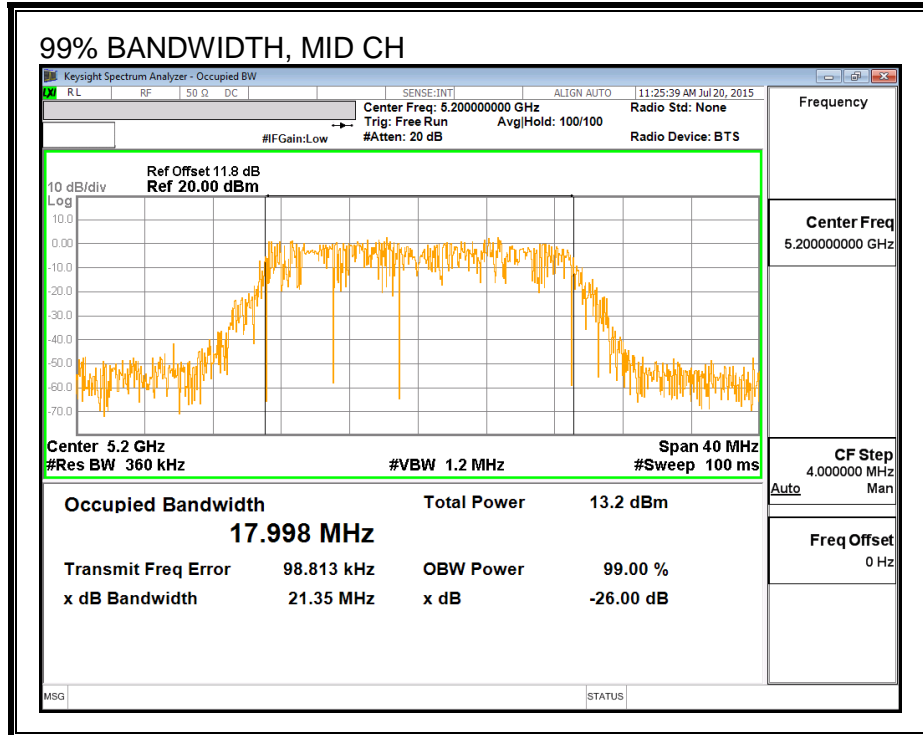
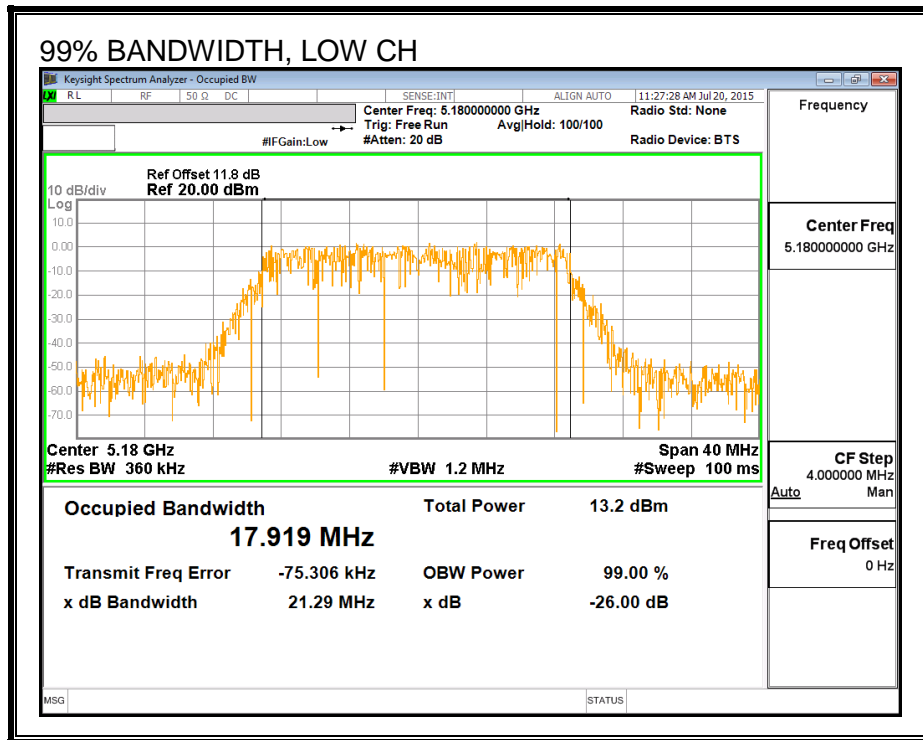

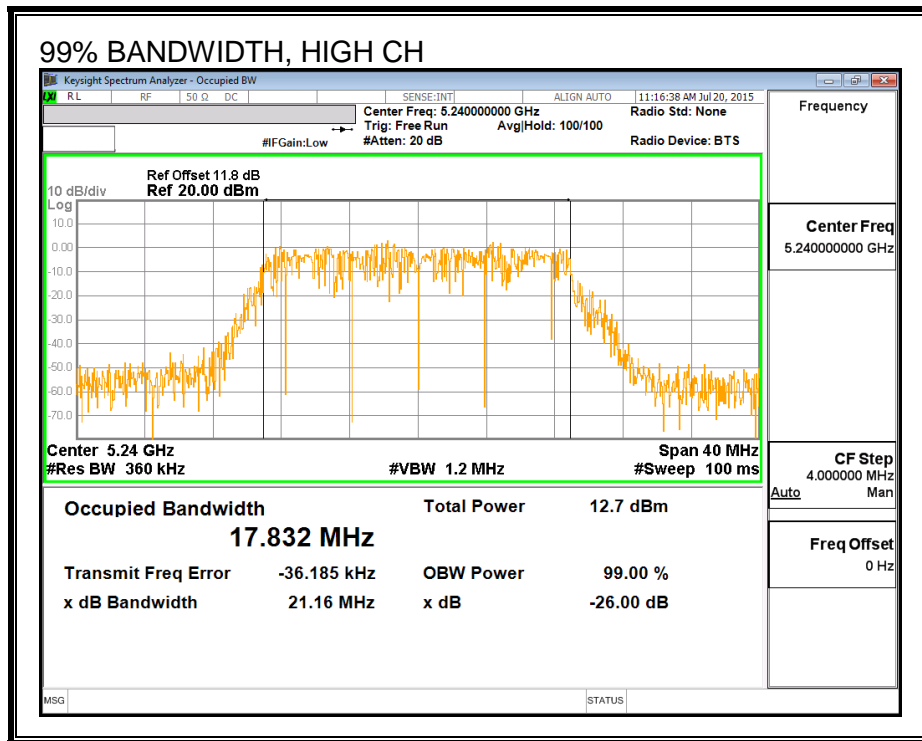

8.2.3. AVERAGE POWER

LIMITS

None; for reporting purposes only.

RESULTS

Channel	Frequency (MHz)	Power (dBm)
Low	5180	16.32
Mid	5200	17.00
High	5240	16.96

8.2.4. OUTPUT POWER AND PSD

LIMITS

FCC §15.407 (a) (1)

(i) For an outdoor access point operating in the band 5.15-5.25 GHz, the maximum conducted output power over the frequency band of operation shall not exceed 1 W provided the maximum antenna gain does not exceed 6 dBi. In addition, the maximum power spectral density shall not exceed 17 dBm in any 1 megahertz band. If transmitting antennas of directional gain greater than 6 dBi are used, both the maximum conducted output power and the maximum power spectral density shall be reduced by the amount in dB that the directional gain of the antenna exceeds 6 dBi. The maximum e.i.r.p. at any elevation angle above 30 degrees as measured from the horizon must not exceed 125 mW (21 dBm).

(ii) For an indoor access point operating in the band 5.15-5.25 GHz, the maximum conducted output power over the frequency band of operation shall not exceed 1 W provided the maximum antenna gain does not exceed 6 dBi. In addition, the maximum power spectral density shall not exceed 17 dBm in any 1 megahertz band. If transmitting antennas of directional gain greater than 6 dBi are used, both the maximum conducted output power and the maximum power spectral density shall be reduced by the amount in dB that the directional gain of the antenna exceeds 6 dBi.

(iii) For fixed point-to-point access points operating in the band 5.15-5.25 GHz, the maximum conducted output power over the frequency band of operation shall not exceed 1 W. Fixed point-to-point U-NII devices may employ antennas with directional gain up to 23 dBi without any corresponding reduction in the maximum conducted output power or maximum power spectral density. For fixed point-to-point transmitters that employ a directional antenna gain greater than 23 dBi, a 1 dB reduction in maximum conducted output power and maximum power spectral density is required for each 1 dB of antenna gain in excess of 23 dBi. Fixed, point-to-point operations exclude the use of point-to-multipoint systems, omnidirectional applications, and multiple collocated transmitters transmitting the same information. The operator of the U-NII device, or if the equipment is professionally installed, the installer, is responsible for ensuring that systems employing high gain directional antennas are used exclusively for fixed, point-to-point operations.

(iv) For mobile and portable client devices in the 5.15-5.25 GHz band, the maximum conducted output power over the frequency band of operation shall not exceed 250 mW provided the maximum antenna gain does not exceed 6 dBi. In addition, the maximum power spectral density shall not exceed 11 dBm in any 1 megahertz band. If transmitting antennas of directional gain greater than 6 dBi are used, both the maximum conducted output power and the maximum power spectral density shall be reduced by the amount in dB that the directional gain of the antenna exceeds 6 dBi.

DIRECTIONAL ANTENNA GAIN

There is only one transmitter output therefore the directional gain is equal to the antenna gain.

RESULTS

RESULTS

Antenna Gain and Limits

Channel	Frequency (MHz)	Directional Gain for Power (dBi)	Directional Gain for PSD (dBi)	Power Limit (dBm)	PSD Limit (dBm)
Low	5180	1.90	1.90	24.00	11.00
Mid	5200	1.90	1.90	24.00	11.00
High	5240	1.90	1.90	24.00	11.00

Duty Cycle CF (dB)	0.00	Included in Calculations of Corr'd Power & PSD
---------------------------	------	---

Output Power Results

Channel	Frequency (MHz)	Meas Power (dBm)	Total Corr'd Power (dBm)	Power Limit (dBm)	Power Margin (dB)
Low	5180	16.32	16.32	24.00	-7.68
Mid	5200	17.00	17.00	24.00	-7.00
High	5240	16.96	16.96	24.00	-7.04

PSD Results

Channel	Frequency (MHz)	Meas PSD (dBm)	Total Corr'd PSD (dBm)	PSD Limit (dBm)	PSD Margin (dB)
Low	5180	4.83	4.83	11.00	-6.18
Mid	5200	5.59	5.59	11.00	-5.41
High	5240	5.50	5.50	11.00	-5.50

PSD

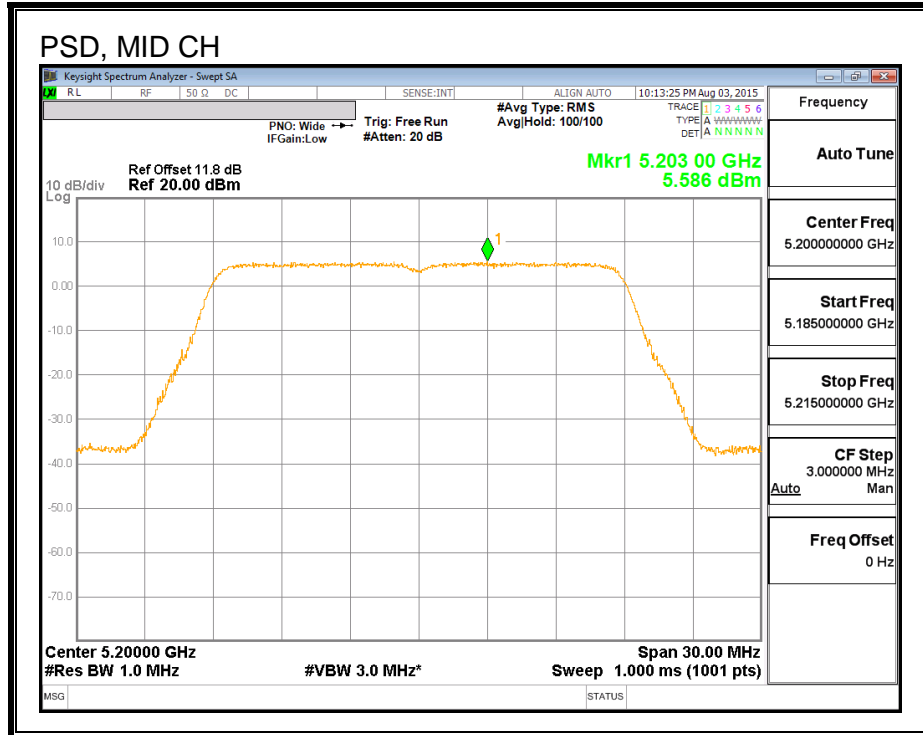
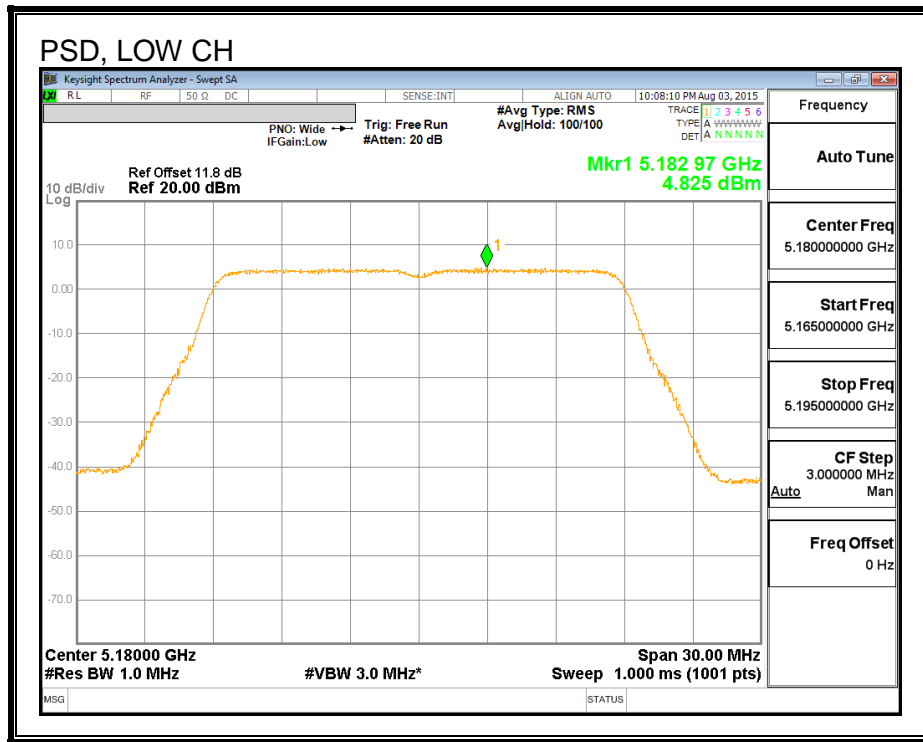

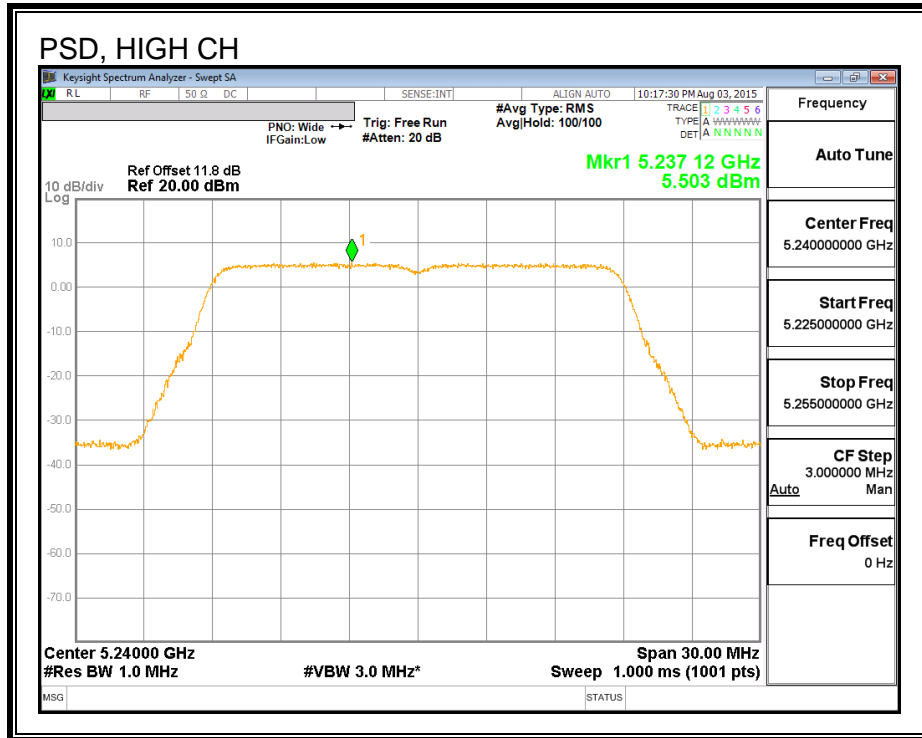

8.3. 802.11n HT20 CHAIN 1 MODE IN THE 5.2 GHz BAND

8.3.1. 26 dB BANDWIDTH

LIMITS

None; for reporting purposes only.

RESULTS

Channel	Frequency (MHz)	26 dB Bandwidth (MHz)
Low	5180	22.11
Mid	5200	22.17
High	5240	22.14

26 dB BANDWIDTH

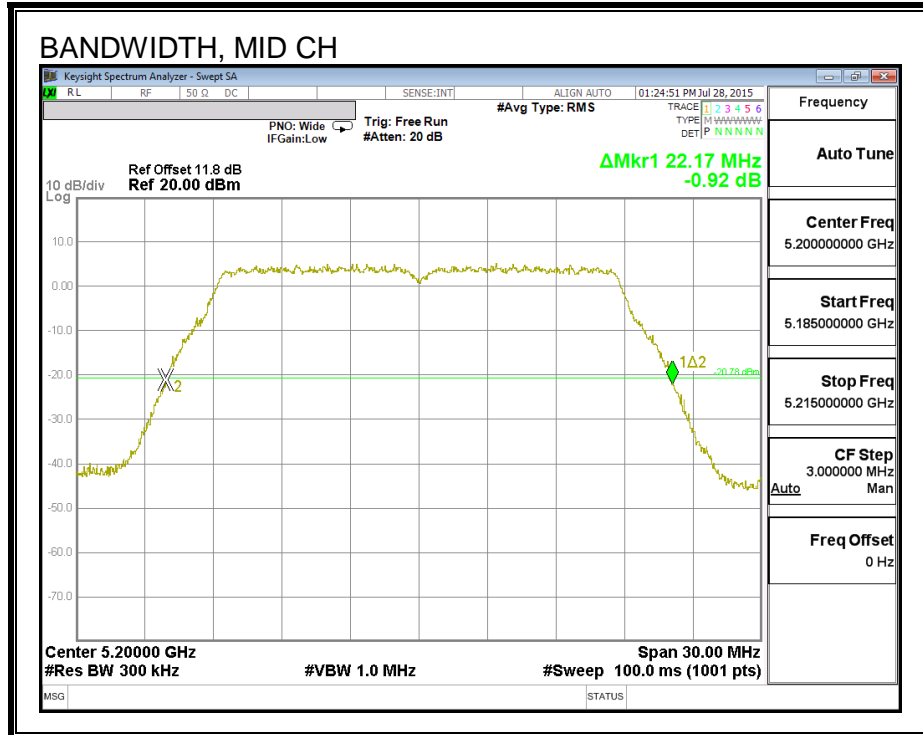
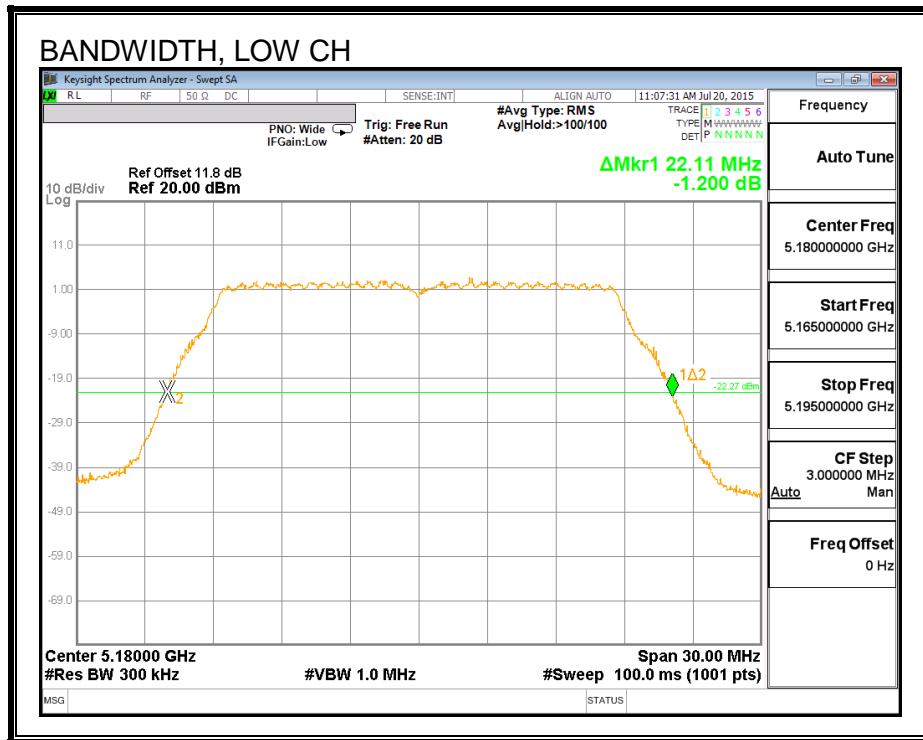

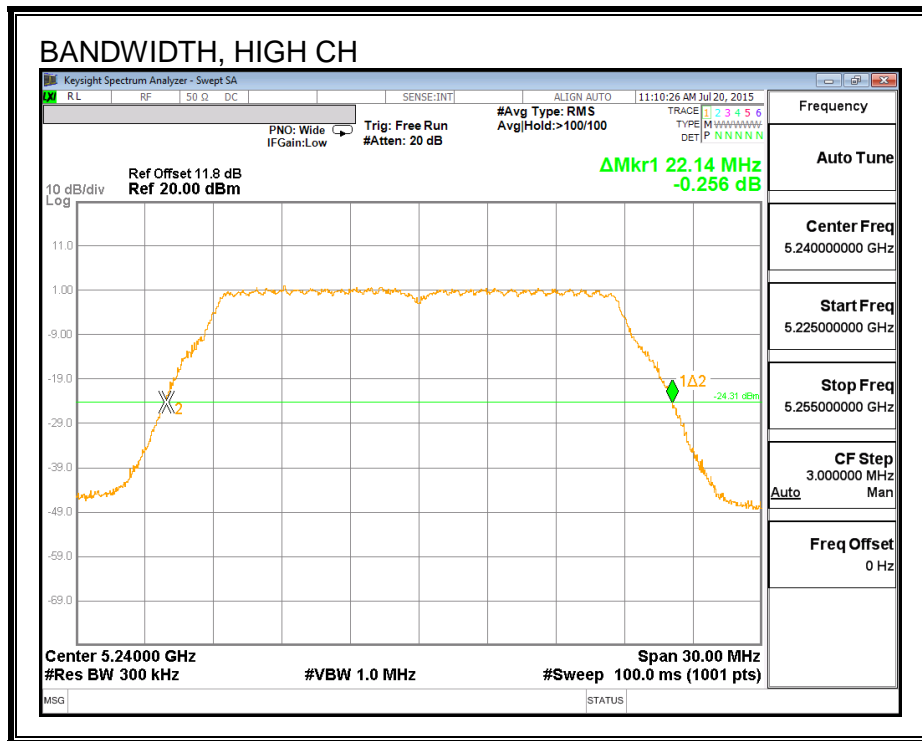

8.3.2. 99% BANDWIDTH

LIMITS

None; for reporting purposes only.

RESULTS

Channel	Frequency (MHz)	99% BW (MHz)
Low	5180	17.855
Mid	5200	17.808
High	5240	17.744

99% BANDWIDTH

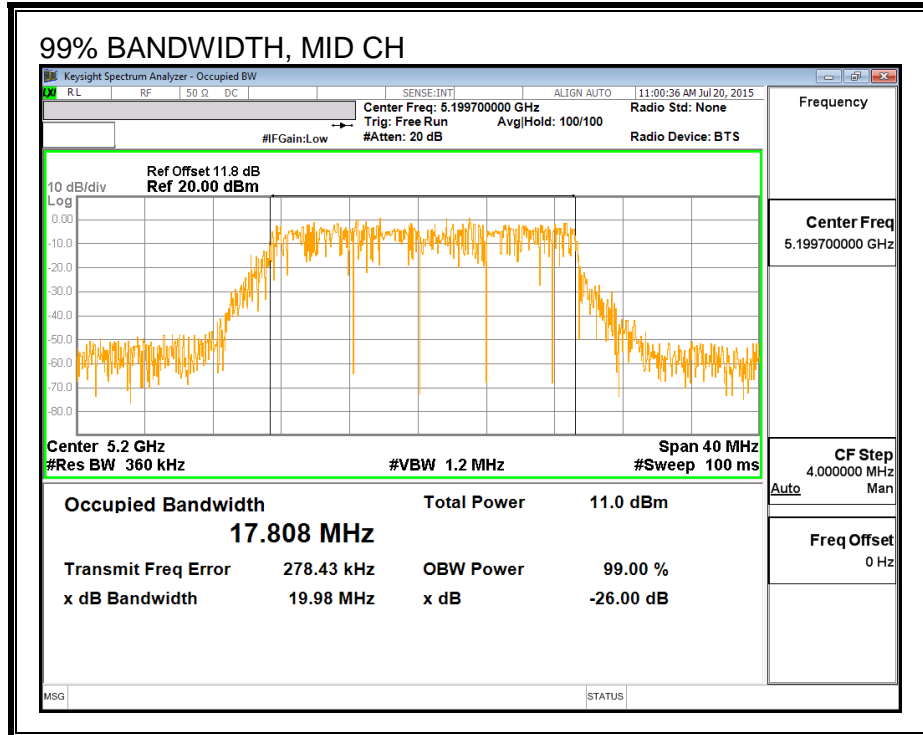
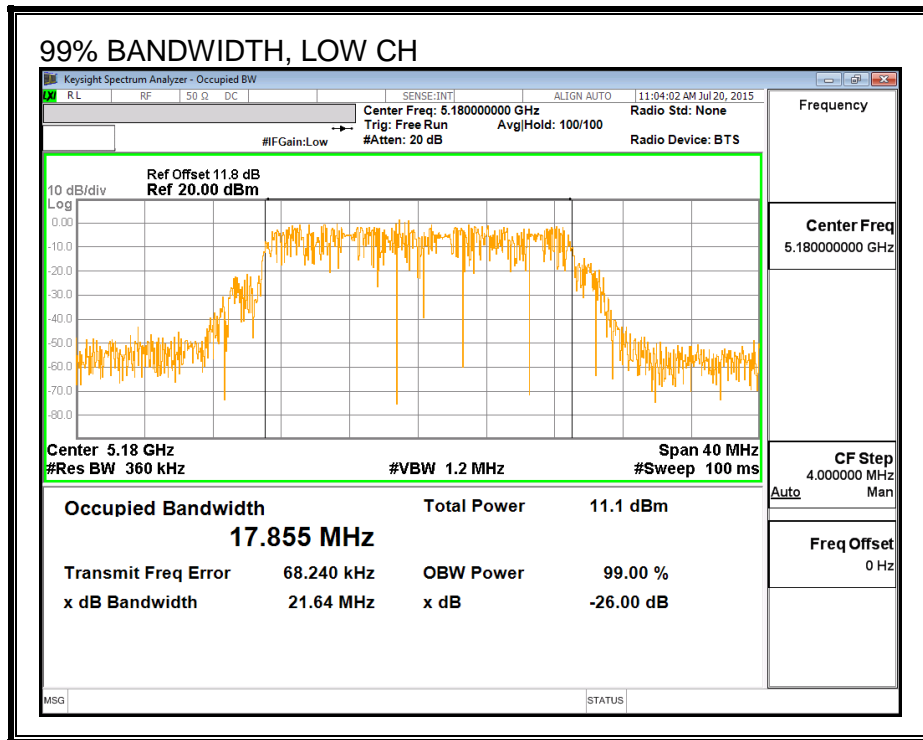

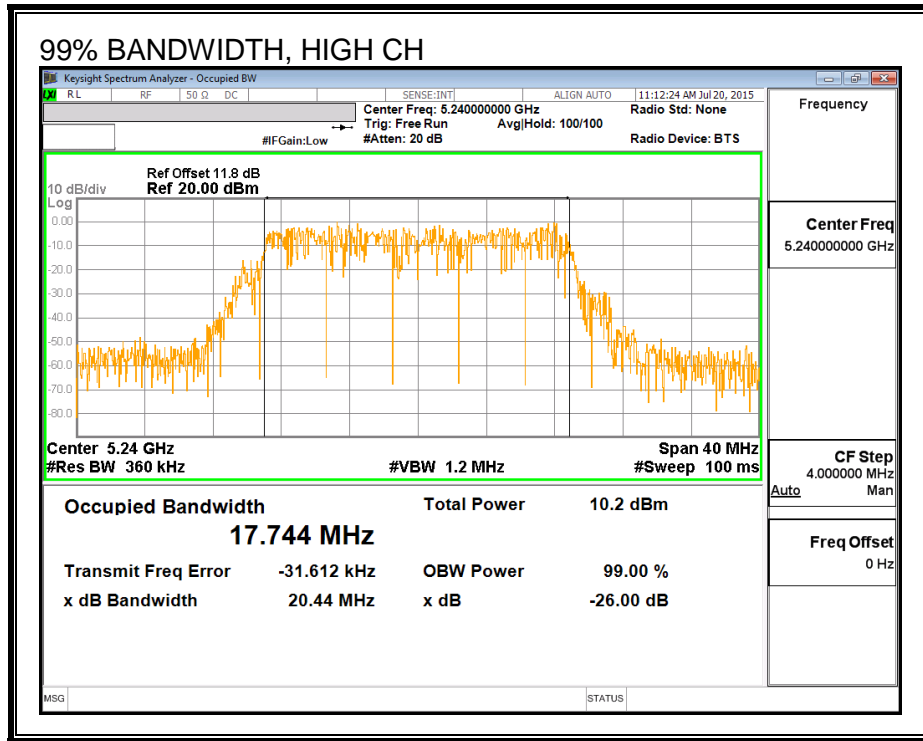

8.3.3. AVERAGE POWER

LIMITS

None; for reporting purposes only.

RESULTS

Channel	Frequency (MHz)	Power (dBm)
Low	5180	16.38
Mid	5200	16.80
High	5240	17.00

8.3.4. OUTPUT POWER AND PSD

LIMITS

FCC §15.407 (a) (1)

(i) For an outdoor access point operating in the band 5.15-5.25 GHz, the maximum conducted output power over the frequency band of operation shall not exceed 1 W provided the maximum antenna gain does not exceed 6 dBi. In addition, the maximum power spectral density shall not exceed 17 dBm in any 1 megahertz band. If transmitting antennas of directional gain greater than 6 dBi are used, both the maximum conducted output power and the maximum power spectral density shall be reduced by the amount in dB that the directional gain of the antenna exceeds 6 dBi. The maximum e.i.r.p. at any elevation angle above 30 degrees as measured from the horizon must not exceed 125 mW (21 dBm).

(ii) For an indoor access point operating in the band 5.15-5.25 GHz, the maximum conducted output power over the frequency band of operation shall not exceed 1 W provided the maximum antenna gain does not exceed 6 dBi. In addition, the maximum power spectral density shall not exceed 17 dBm in any 1 megahertz band. If transmitting antennas of directional gain greater than 6 dBi are used, both the maximum conducted output power and the maximum power spectral density shall be reduced by the amount in dB that the directional gain of the antenna exceeds 6 dBi.

(iii) For fixed point-to-point access points operating in the band 5.15-5.25 GHz, the maximum conducted output power over the frequency band of operation shall not exceed 1 W. Fixed point-to-point U-NII devices may employ antennas with directional gain up to 23 dBi without any corresponding reduction in the maximum conducted output power or maximum power spectral density. For fixed point-to-point transmitters that employ a directional antenna gain greater than 23 dBi, a 1 dB reduction in maximum conducted output power and maximum power spectral density is required for each 1 dB of antenna gain in excess of 23 dBi. Fixed, point-to-point operations exclude the use of point-to-multipoint systems, omnidirectional applications, and multiple collocated transmitters transmitting the same information. The operator of the U-NII device, or if the equipment is professionally installed, the installer, is responsible for ensuring that systems employing high gain directional antennas are used exclusively for fixed, point-to-point operations.

(iv) For mobile and portable client devices in the 5.15-5.25 GHz band, the maximum conducted output power over the frequency band of operation shall not exceed 250 mW provided the maximum antenna gain does not exceed 6 dBi. In addition, the maximum power spectral density shall not exceed 11 dBm in any 1 megahertz band. If transmitting antennas of directional gain greater than 6 dBi are used, both the maximum conducted output power and the maximum power spectral density shall be reduced by the amount in dB that the directional gain of the antenna exceeds 6 dBi.

DIRECTIONAL ANTENNA GAIN

There is only one transmitter output therefore the directional gain is equal to the antenna gain.

RESULTS

RESULTS

Antenna Gain and Limits

Channel	Frequency (MHz)	Directional Gain for Power (dBi)	Directional Gain for PSD (dBi)	Power Limit (dBm)	PSD Limit (dBm)
Low	5180	2.30	2.30	24.00	11.00
Mid	5200	2.30	2.30	24.00	11.00
High	5240	2.30	2.30	24.00	11.00

Duty Cycle CF (dB)	0.00	Included in Calculations of Corr'd Power & PSD
---------------------------	------	---

Output Power Results

Channel	Frequency (MHz)	Meas Power (dBm)	Total Corr'd Power (dBm)	Power Limit (dBm)	Power Margin (dB)
Low	5180	16.38	16.38	24.00	-7.62
Mid	5200	16.80	16.80	24.00	-7.20
High	5240	17.00	17.00	24.00	-7.00

PSD Results

Channel	Frequency (MHz)	Meas PSD (dBm)	Total Corr'd PSD (dBm)	PSD Limit (dBm)	PSD Margin (dB)
Low	5180	4.95	4.95	11.00	-6.06
Mid	5200	5.37	5.37	11.00	-5.63
High	5240	5.63	5.63	11.00	-5.37

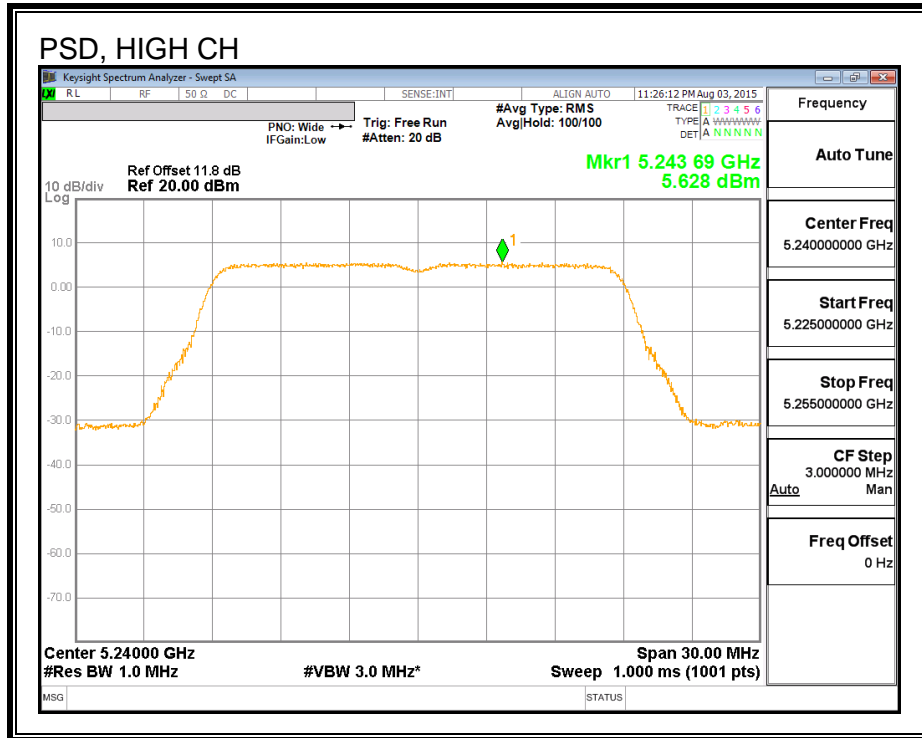

8.4. 802.11a CDD 2TX MODE IN THE 5.2 GHz BAND

Note: Covered by 802.11n HT20 CDD 2TX MODE.

8.5. 802.11n HT20 2Tx CDD MODE IN THE 5.2 GHz BAND

8.5.1. 26 dB BANDWIDTH

LIMITS

None; for reporting purposes only.

RESULTS

Channel	Frequency (MHz)	26 dB BW Chain 0 (MHz)	26 dB BW Chain 1 (MHz)
Low	5180	22.20	22.17
Mid	5200	22.11	22.08
High	5240	22.14	22.11

26 DB BANDWIDTH, CHAIN 0

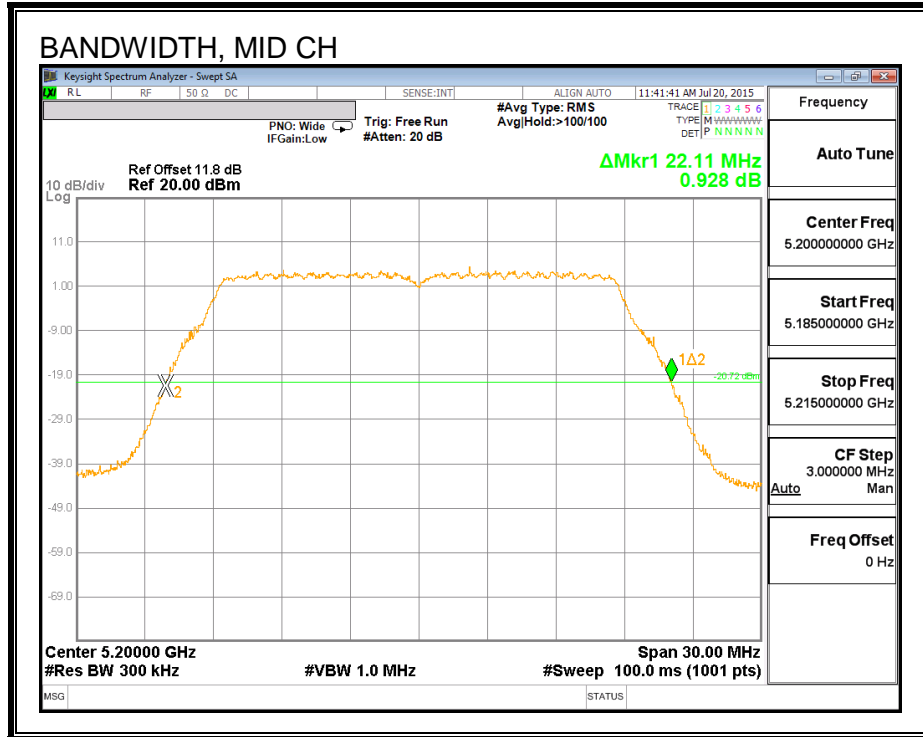
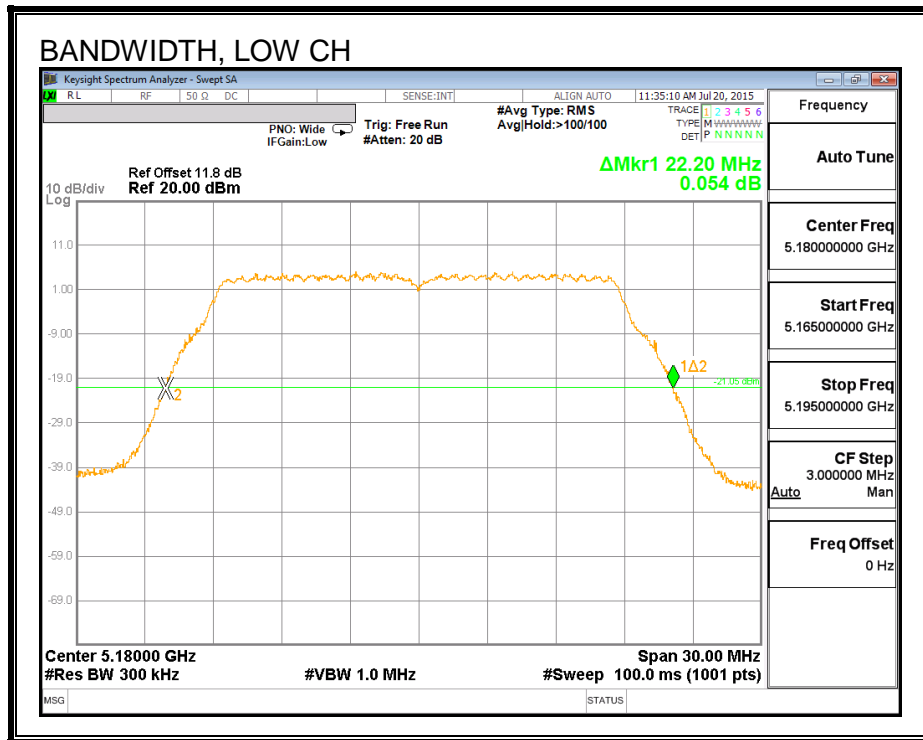

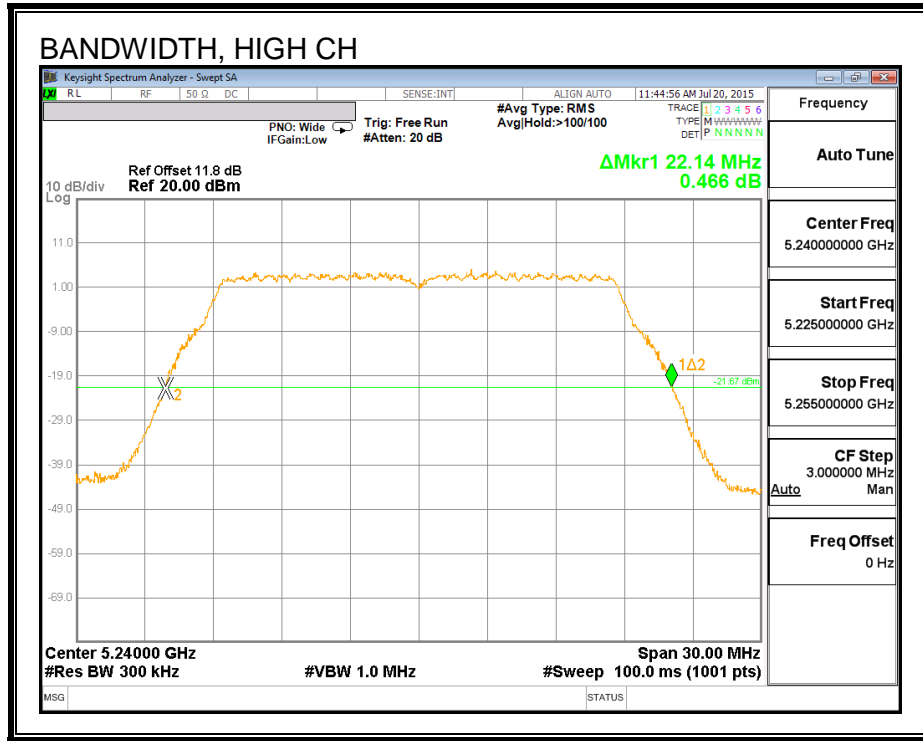

26 DB BANDWIDTH, CHAIN 1

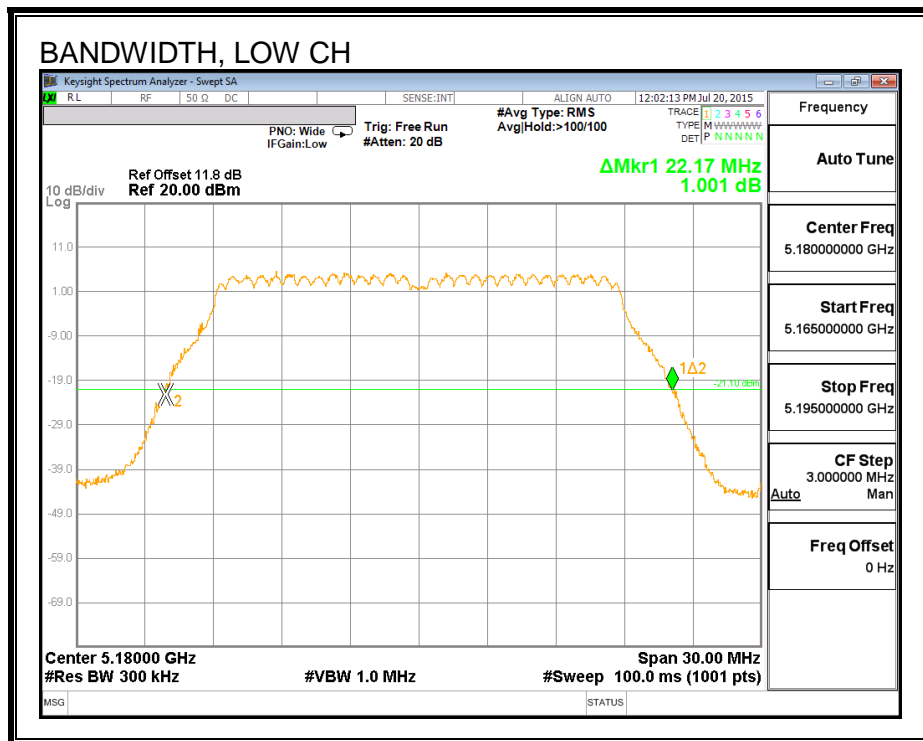

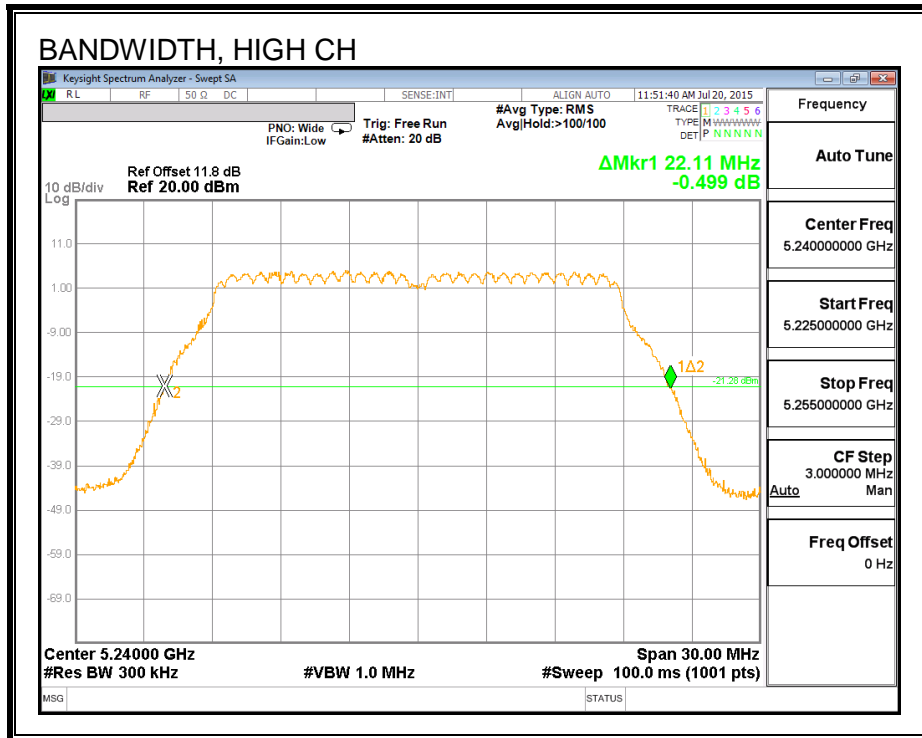
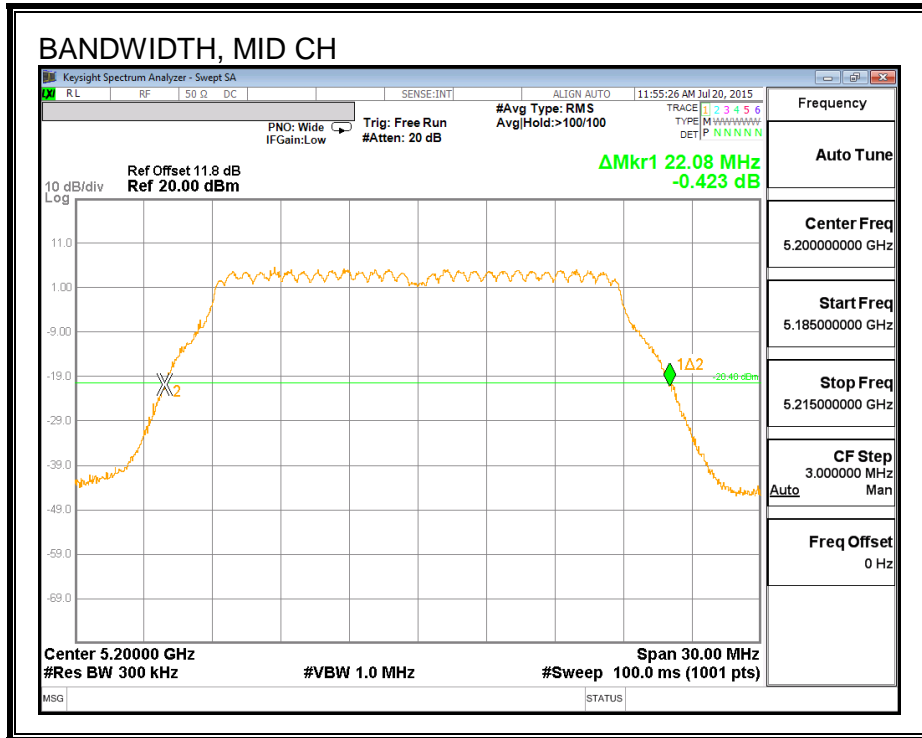

8.5.2. 99% BANDWIDTH

LIMITS

None; for reporting purposes only.

RESULTS

Channel	Frequency (MHz)	99% BW Chain 0 (MHz)	99% BW Chain 1 (MHz)
Low	5180	17.891	17.730
Mid	5200	17.939	17.767
High	5240	17.752	17.859

99% BANDWIDTH, CHAIN 0

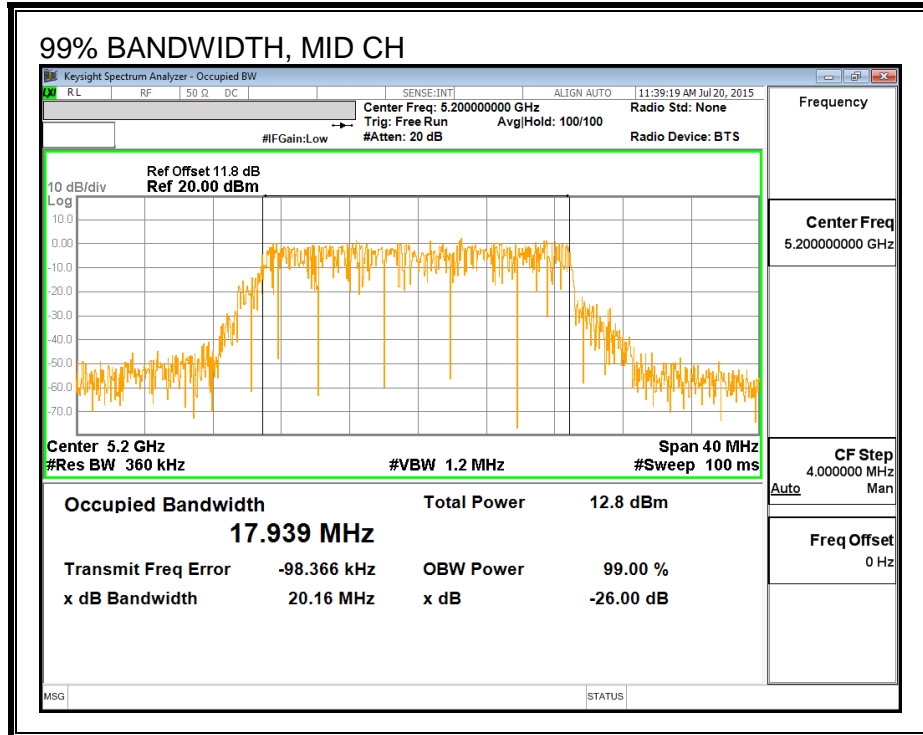
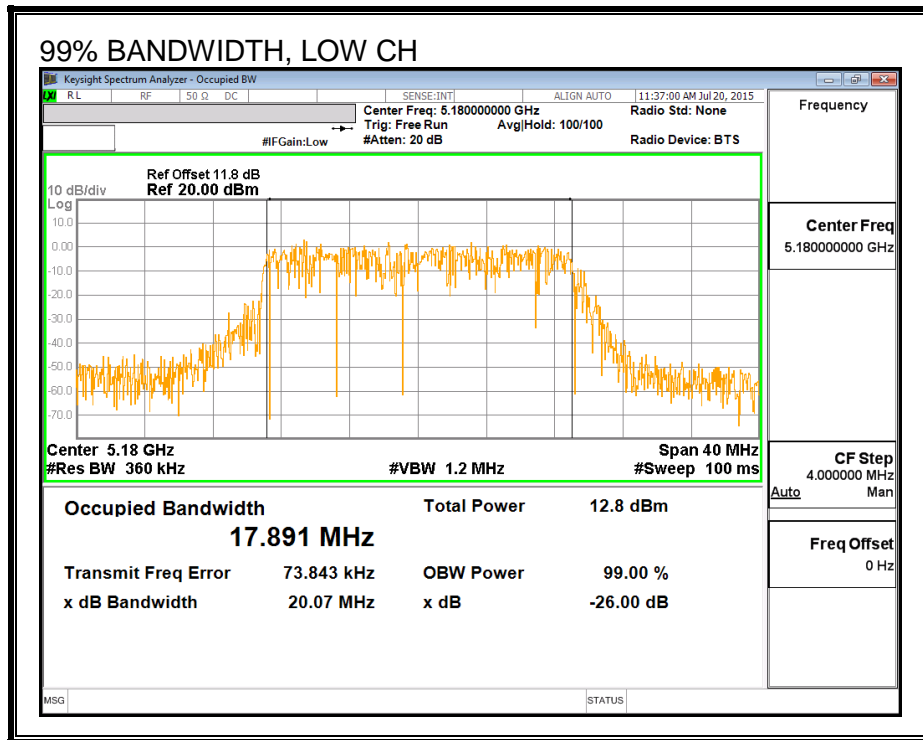

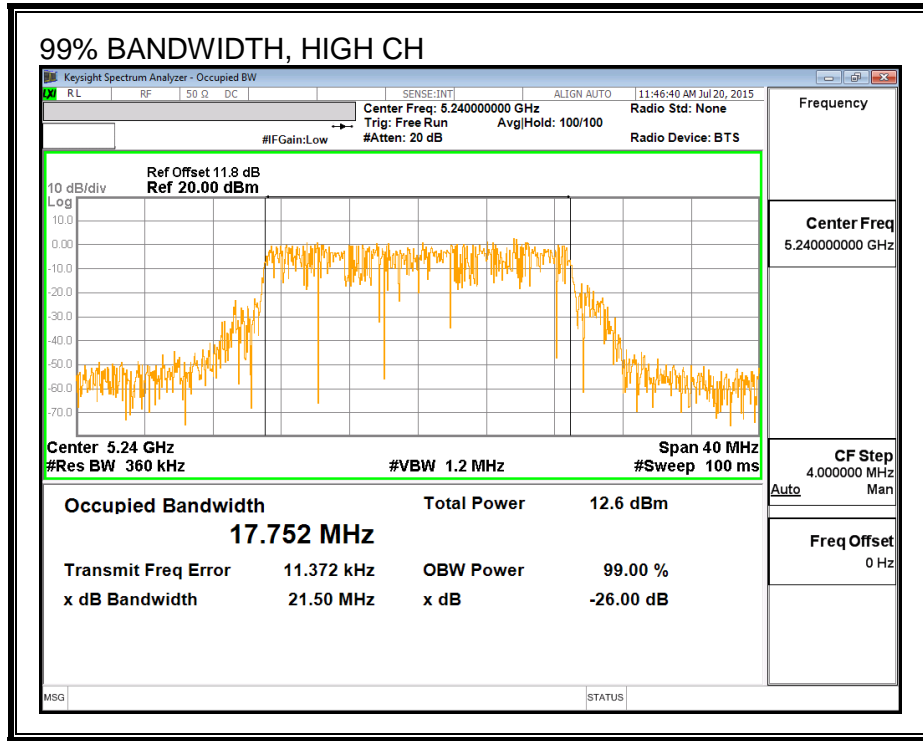

99% BANDWIDTH, CHAIN 1

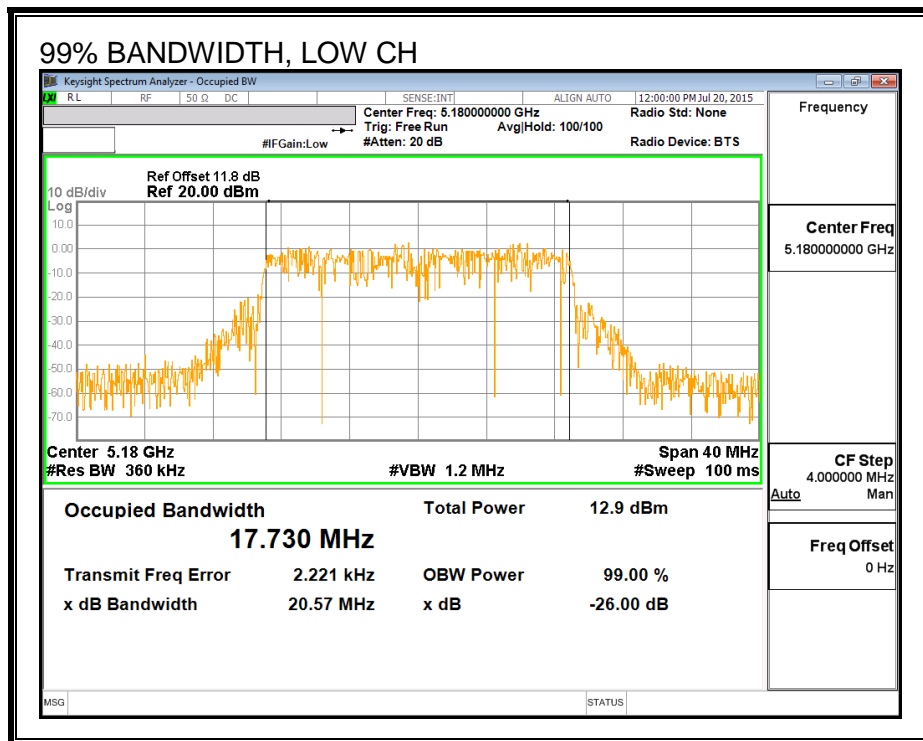

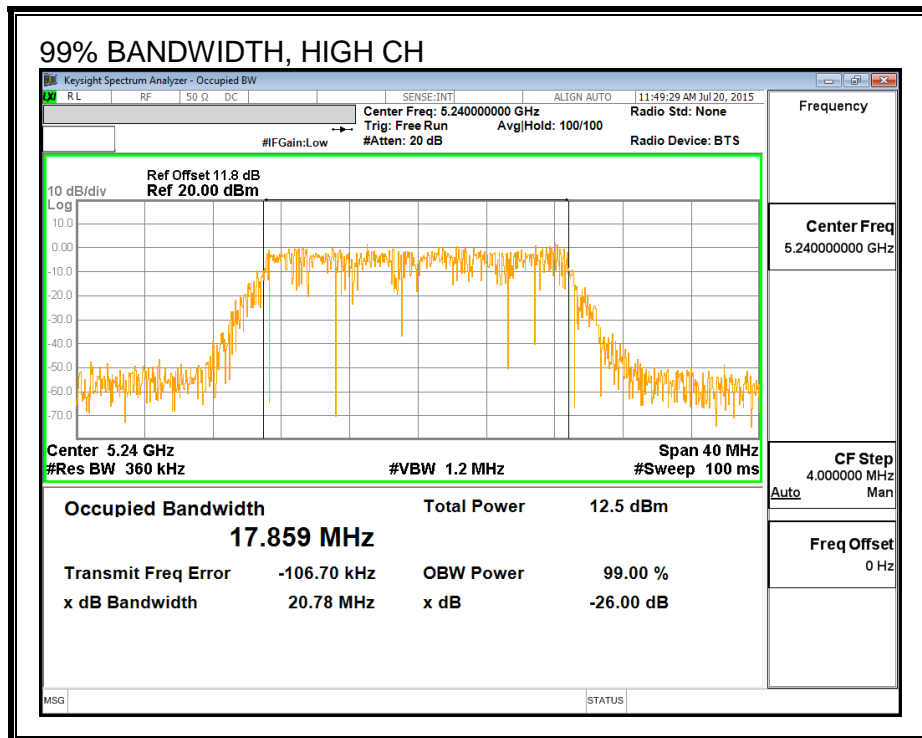
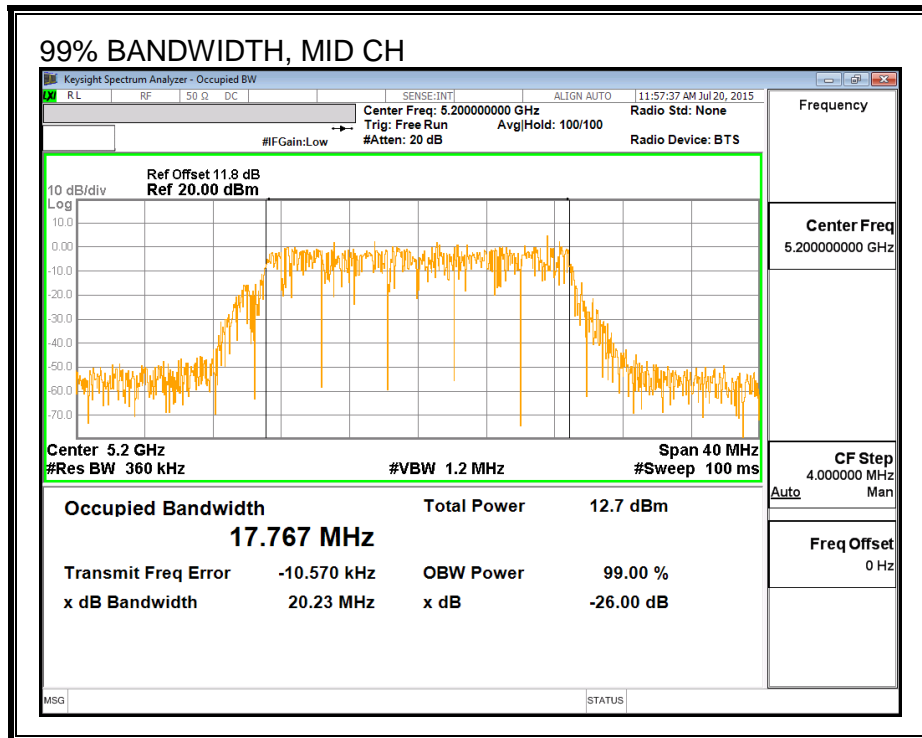

8.5.3. AVERAGE POWER

LIMITS

None; for reporting purposes only.

RESULTS

Average Power Results

Channel	Frequency (MHz)	Chain 0 Power (dBm)	Chain 1 Power (dBm)	Total Power (dBm)
Low	5180	14.95	14.90	17.94
Mid	5200	16.45	16.40	19.44
High	5240	16.44	16.47	19.47

8.5.4. OUTPUT POWER AND PSD

LIMITS

FCC §15.407 (a) (1)

(i) For an outdoor access point operating in the band 5.15-5.25 GHz, the maximum conducted output power over the frequency band of operation shall not exceed 1 W provided the maximum antenna gain does not exceed 6 dBi. In addition, the maximum power spectral density shall not exceed 17 dBm in any 1 megahertz band. If transmitting antennas of directional gain greater than 6 dBi are used, both the maximum conducted output power and the maximum power spectral density shall be reduced by the amount in dB that the directional gain of the antenna exceeds 6 dBi. The maximum e.i.r.p. at any elevation angle above 30 degrees as measured from the horizon must not exceed 125 mW (21 dBm).

(ii) For an indoor access point operating in the band 5.15-5.25 GHz, the maximum conducted output power over the frequency band of operation shall not exceed 1 W provided the maximum antenna gain does not exceed 6 dBi. In addition, the maximum power spectral density shall not exceed 17 dBm in any 1 megahertz band. If transmitting antennas of directional gain greater than 6 dBi are used, both the maximum conducted output power and the maximum power spectral density shall be reduced by the amount in dB that the directional gain of the antenna exceeds 6 dBi.

(iii) For fixed point-to-point access points operating in the band 5.15-5.25 GHz, the maximum conducted output power over the frequency band of operation shall not exceed 1 W. Fixed point-to-point U-NII devices may employ antennas with directional gain up to 23 dBi without any corresponding reduction in the maximum conducted output power or maximum power spectral density. For fixed point-to-point transmitters that employ a directional antenna gain greater than 23 dBi, a 1 dB reduction in maximum conducted output power and maximum power spectral density is required for each 1 dB of antenna gain in excess of 23 dBi. Fixed, point-to-point operations exclude the use of point-to-multipoint systems, omnidirectional applications, and multiple collocated transmitters transmitting the same information. The operator of the U-NII device, or if the equipment is professionally installed, the installer, is responsible for ensuring that systems employing high gain directional antennas are used exclusively for fixed, point-to-point operations.

(iv) For mobile and portable client devices in the 5.15-5.25 GHz band, the maximum conducted output power over the frequency band of operation shall not exceed 250 mW provided the maximum antenna gain does not exceed 6 dBi. In addition, the maximum power spectral density shall not exceed 11 dBm in any 1 megahertz band. If transmitting antennas of directional gain greater than 6 dBi are used, both the maximum conducted output power and the maximum power spectral density shall be reduced by the amount in dB that the directional gain of the antenna exceeds 6 dBi.

DIRECTIONAL ANTENNA GAIN

The TX chains are uncorrelated and the antenna gain is unequal among the chains. The directional gain is:

Chain 0 Antenna Gain (dBi)	Chain 1 Antenna Gain (dBi)	Uncorrelated Chains Directional Gain (dBi)
1.90	2.30	2.10

The TX chains are correlated and the antenna gain is unequal among the chains. The directional gain is:

Chain 0 Antenna Gain (dBi)	Chain 1 Antenna Gain (dBi)	Correlated Chains Directional Gain (dBi)
1.90	2.30	5.11

RESULTS

Antenna Gain and Limits

Channel	Frequency (MHz)	Directional Gain for Power (dBi)	Directional Gain for PSD (dBi)	Power Limit (dBm)	PSD Limit (dBm)
Low	5180	2.10	5.11	24.00	11.00
Mid	5200	2.10	5.11	24.00	11.00
High	5240	2.10	5.11	24.00	11.00

Duty Cycle CF (dB)	0.00	Included in Calculations of Corr'd Power & PSD
---------------------------	------	---

Output Power Results

Channel	Frequency (MHz)	Chain 0 Meas Power (dBm)	Chain 1 Meas Power (dBm)	Total Corr'd Power (dBm)	Power Limit (dBm)	Power Margin (dB)
Low	5180	14.95	14.90	17.94	24.00	-6.06
Mid	5200	16.45	16.40	19.44	24.00	-4.56
High	5240	16.44	16.47	19.47	24.00	-4.53

PSD Results

Channel	Frequency (MHz)	Chain 0 Meas PSD (dBm)	Chain 1 Meas PSD (dBm)	Total Corr'd PSD (dBm)	PSD Limit (dBm)	PSD Margin (dB)
Low	5180	3.29	3.29	6.30	11.00	-4.70
Mid	5200	5.13	4.98	8.07	11.00	-2.93
High	5240	4.85	5.03	7.95	11.00	-3.05

PSD, Chain 0

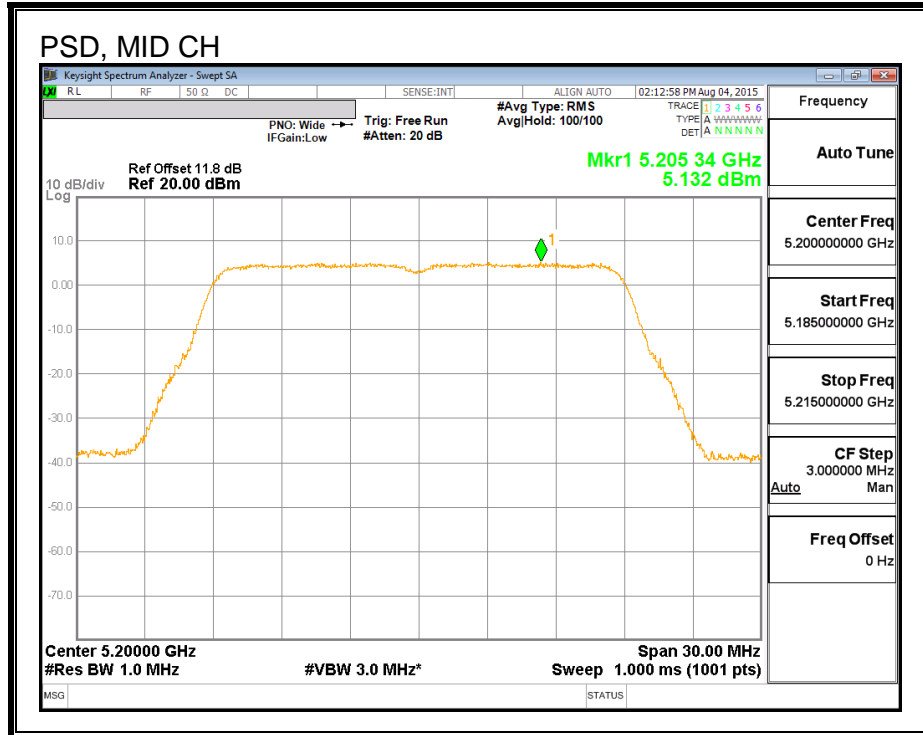
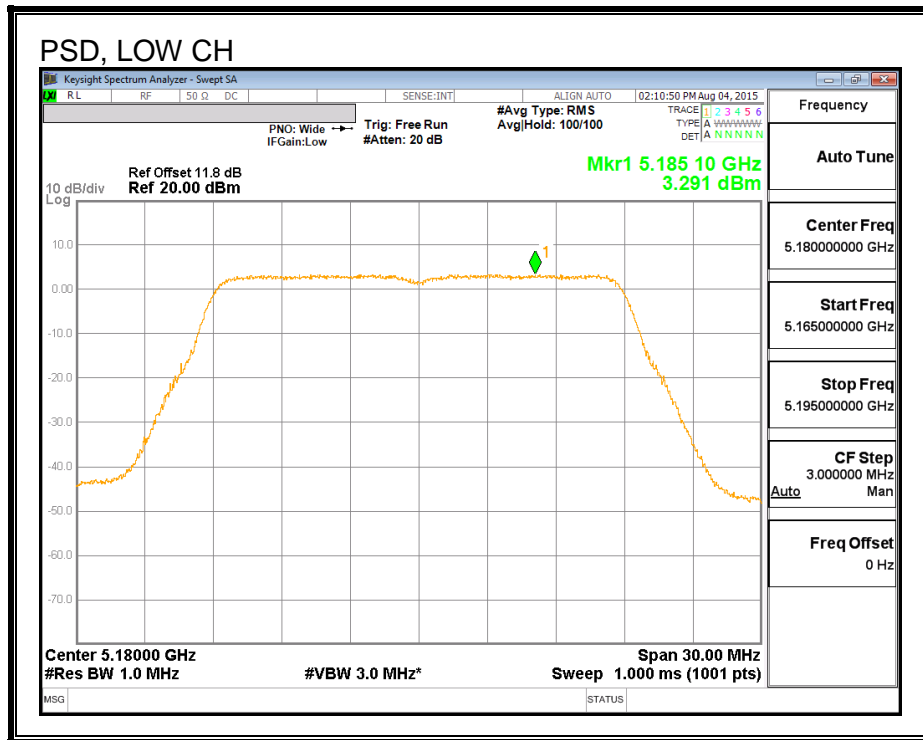

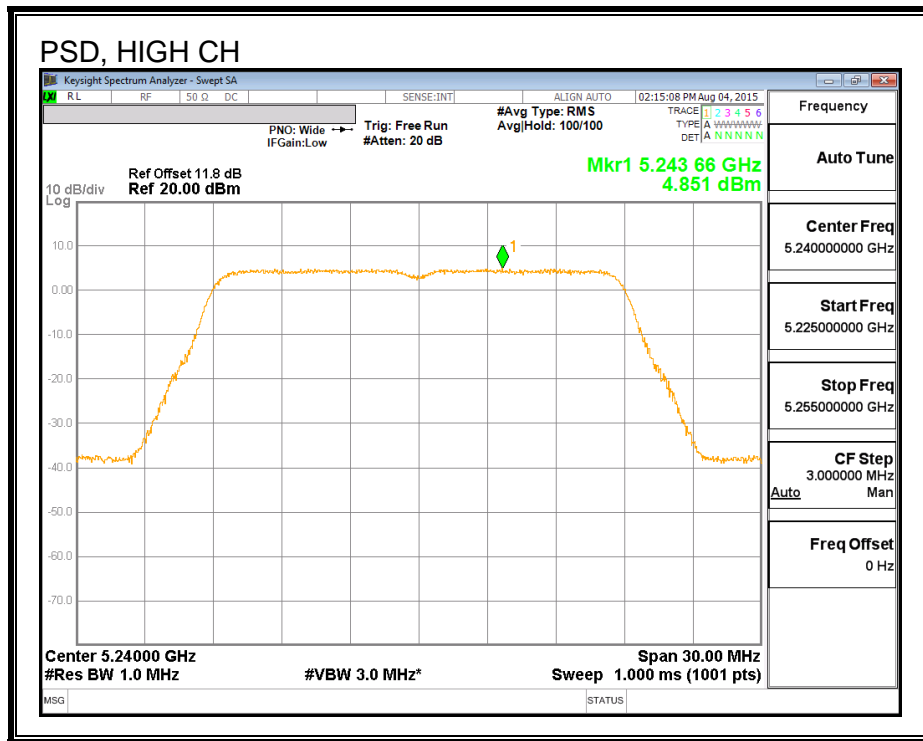

PSD, Chain 1

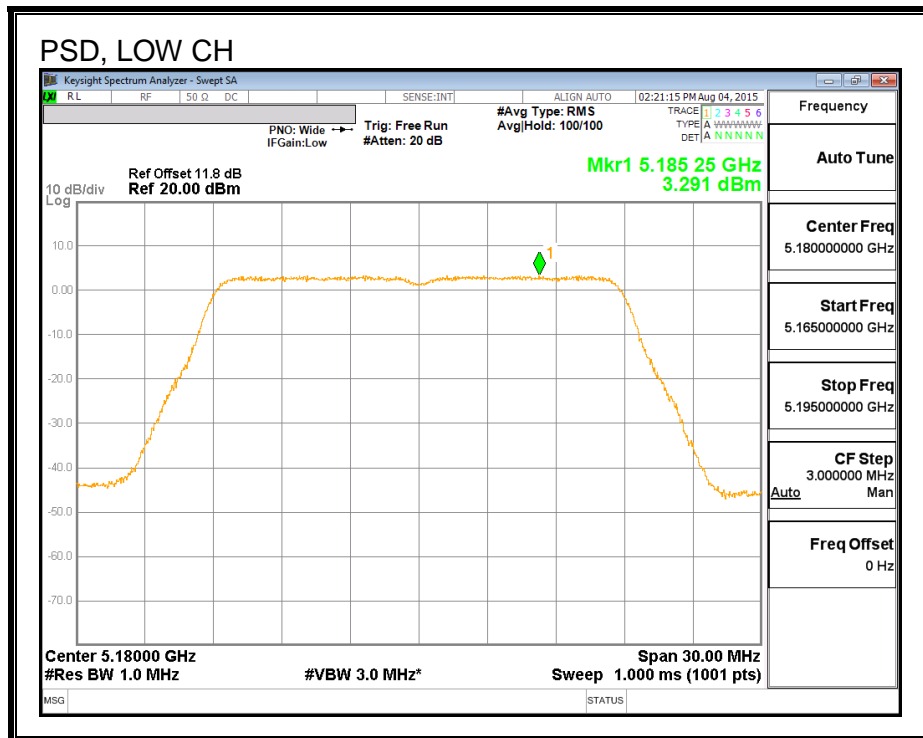

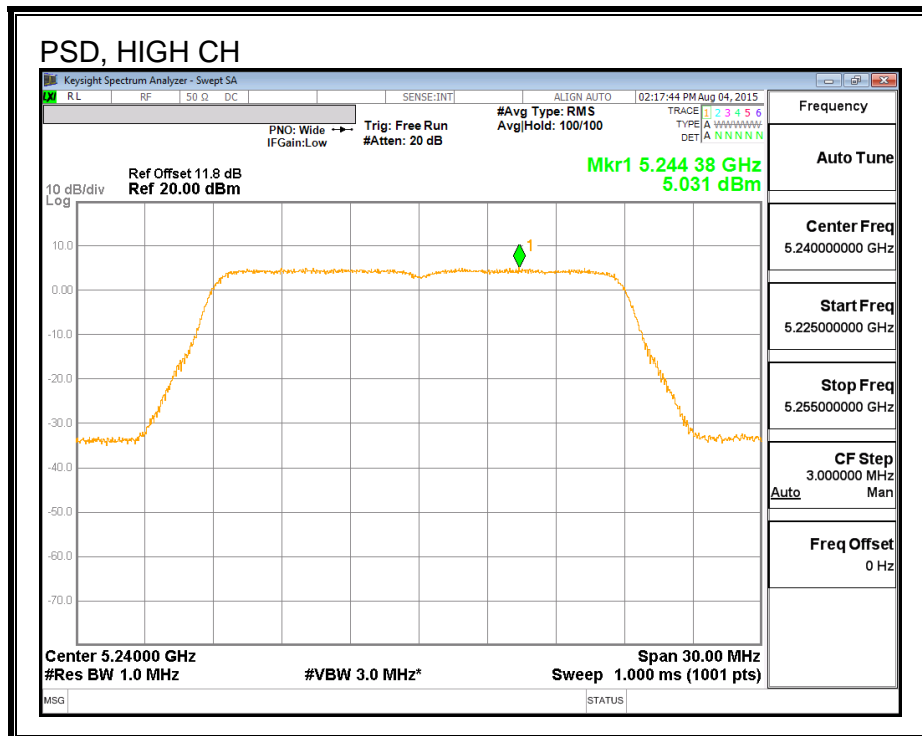
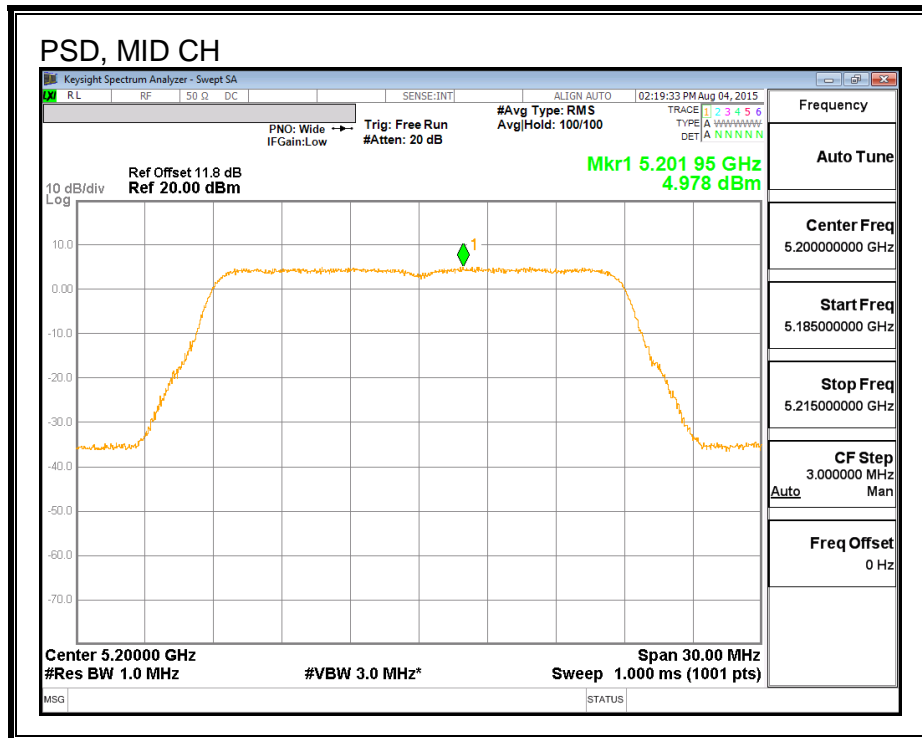

8.6. 802.11n HT20 2Tx STBC MODE IN THE 5.2 GHz BAND

8.6.1. 26 dB BANDWIDTH

LIMITS

None; for reporting purposes only.

RESULTS

Channel	Frequency (MHz)	26 dB BW Chain 0 (MHz)	26 dB BW Chain 1 (MHz)
Low	5180	21.54	21.69
Mid	5200	21.63	21.51
High	5240	21.54	21.54

26 dB BANDWIDTH, Chain 0

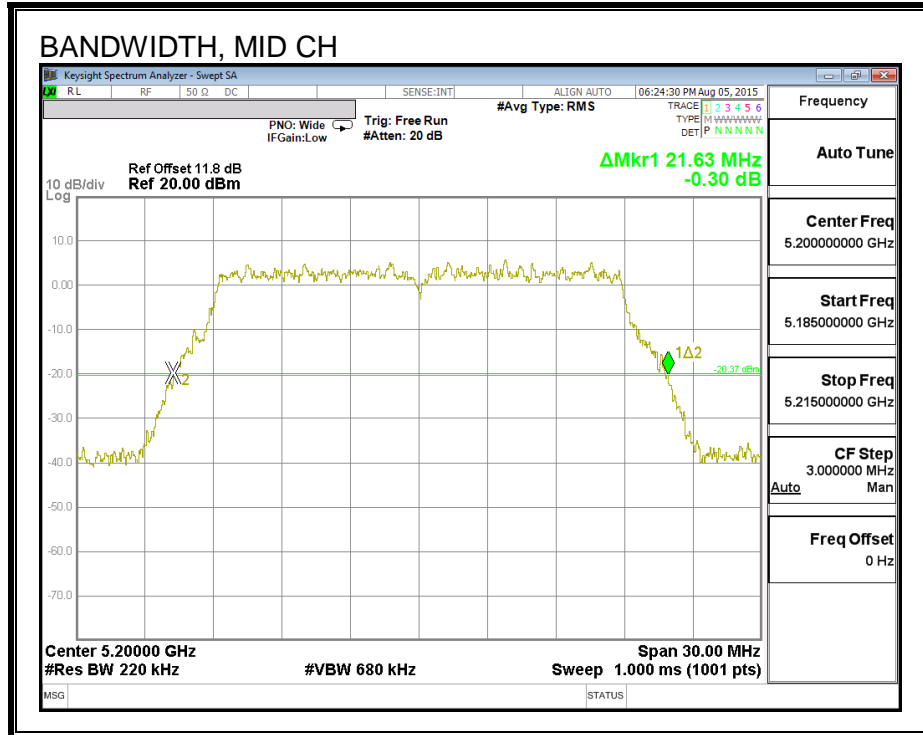
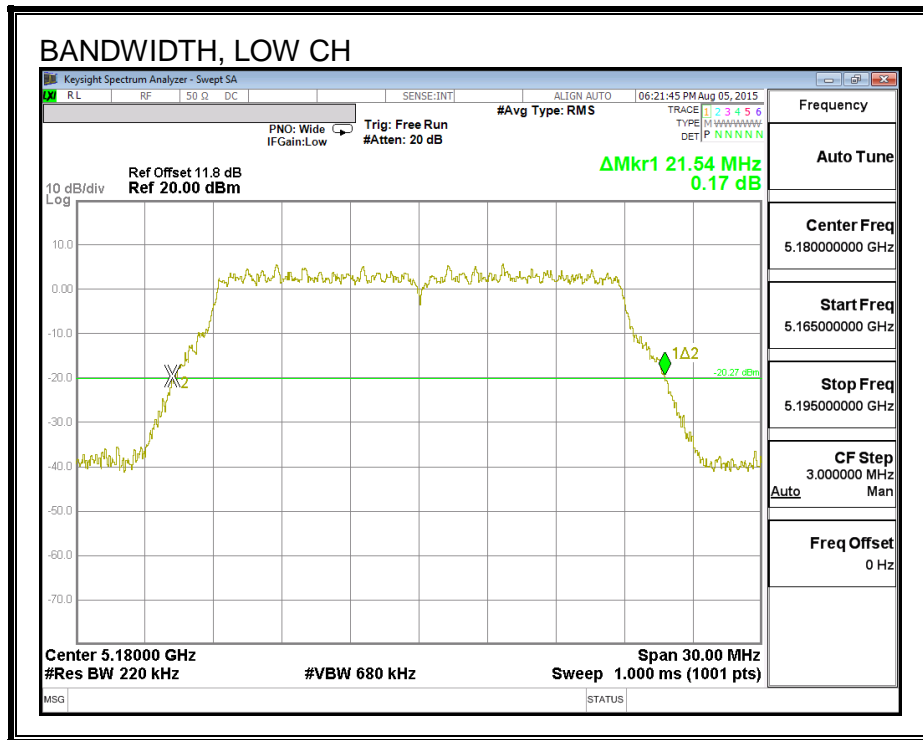

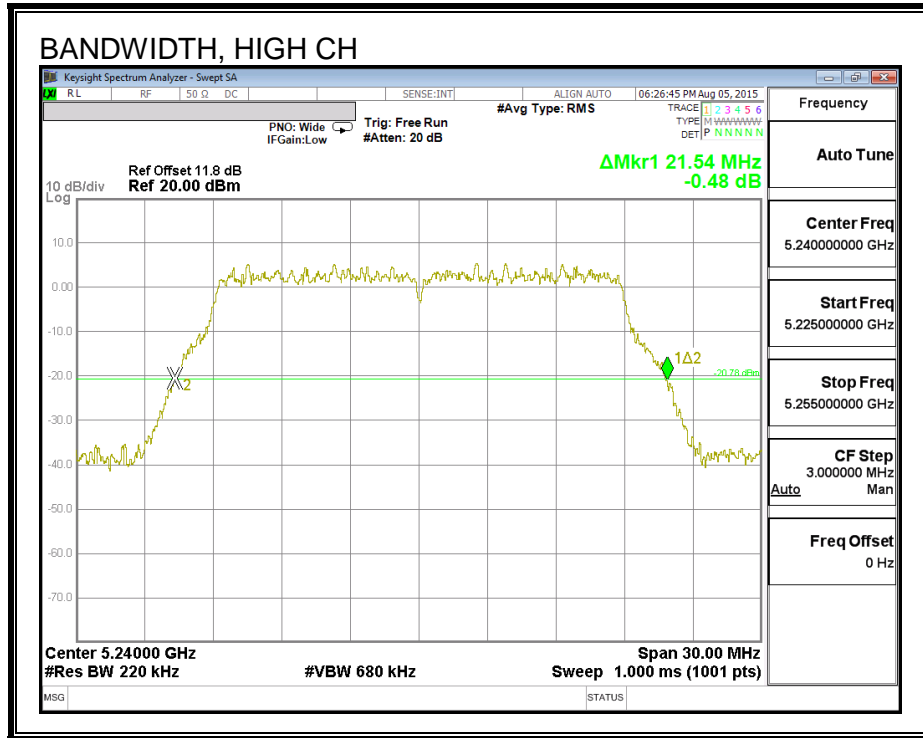

26 dB BANDWIDTH, Chain 1

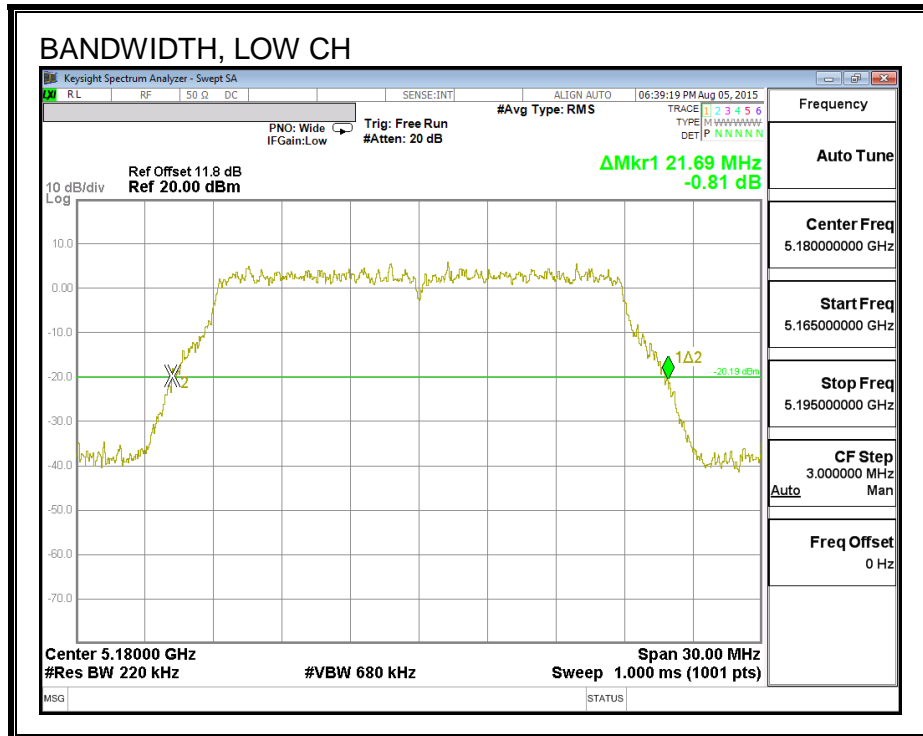

8.6.2. 99% BANDWIDTH

LIMITS

None; for reporting purposes only.

RESULTS

Channel	Frequency (MHz)	99% BW Chain 0 (MHz)	99% BW Chain 1 (MHz)
Low	5180	17.736	17.750
Mid	5200	17.752	17.478
High	5240	17.775	17.721

99% BANDWIDTH, Chain 0

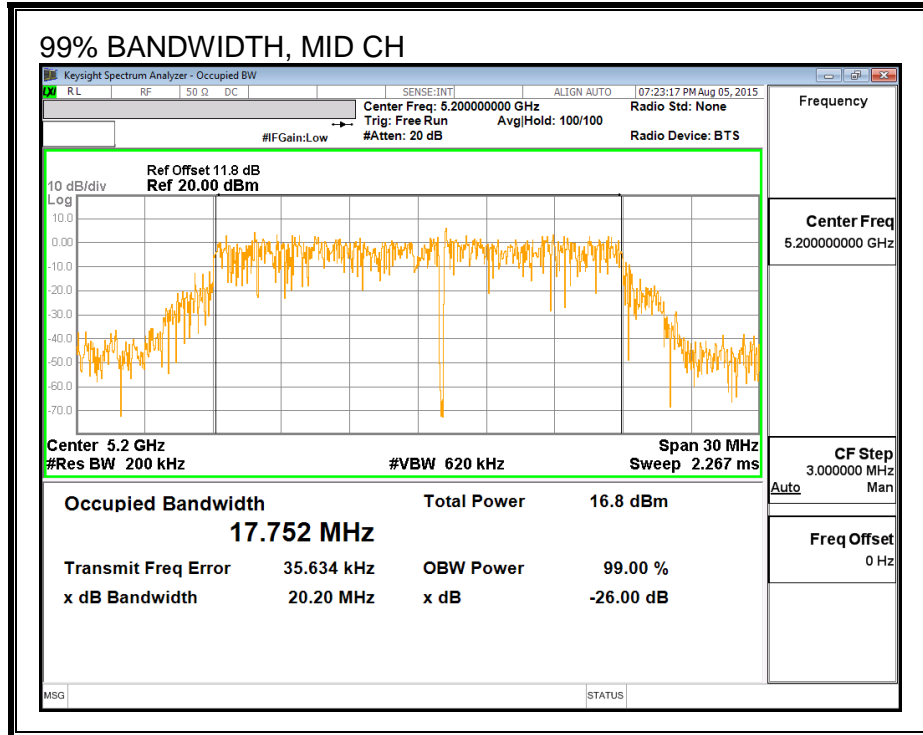
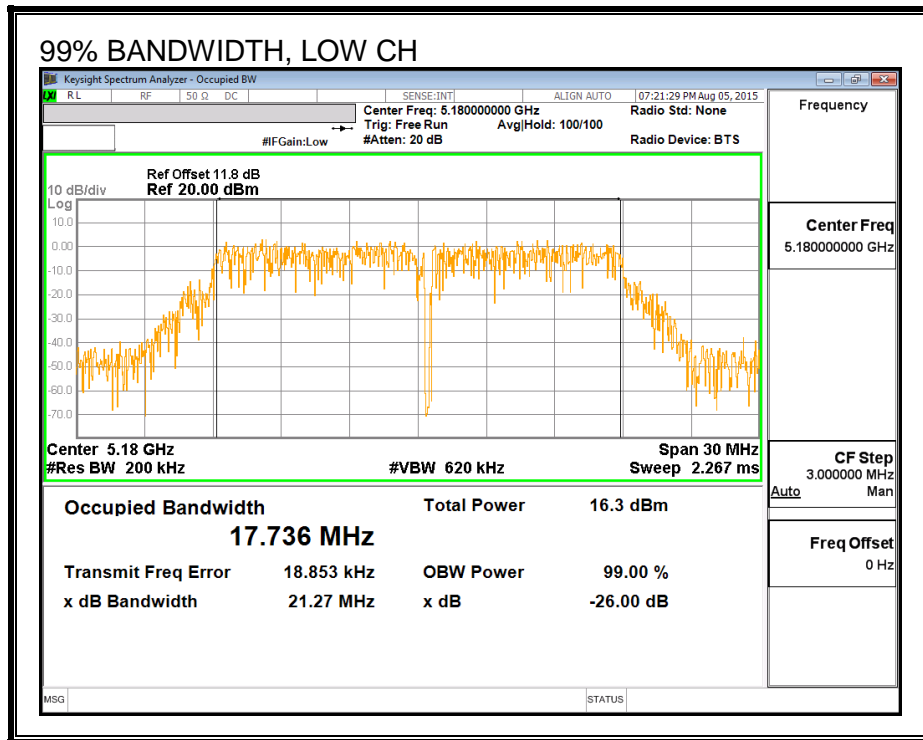

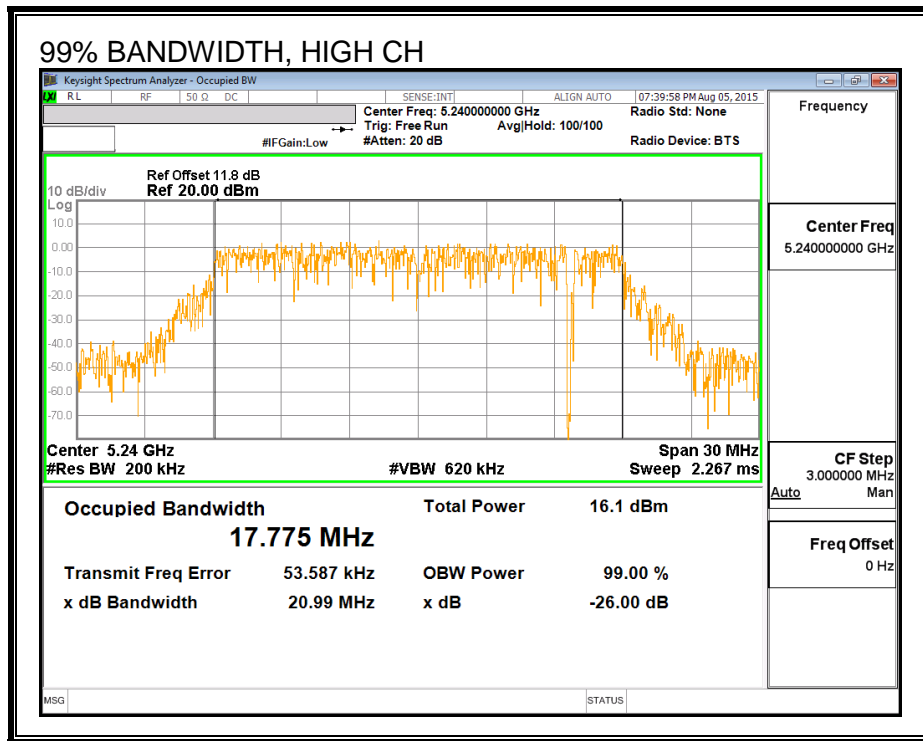

99% BANDWIDTH, Chain 1

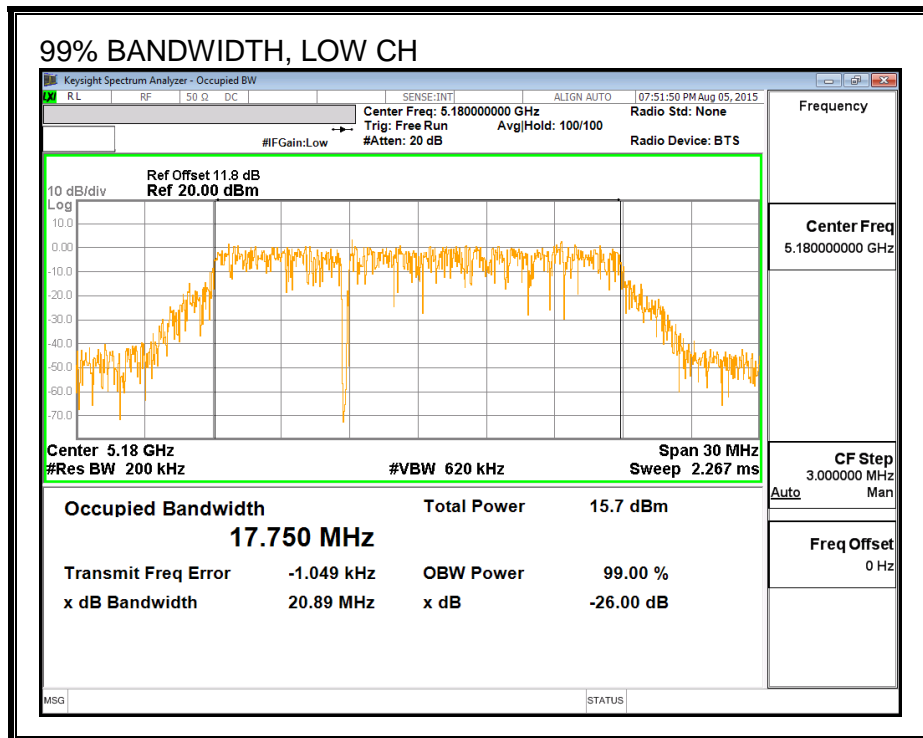

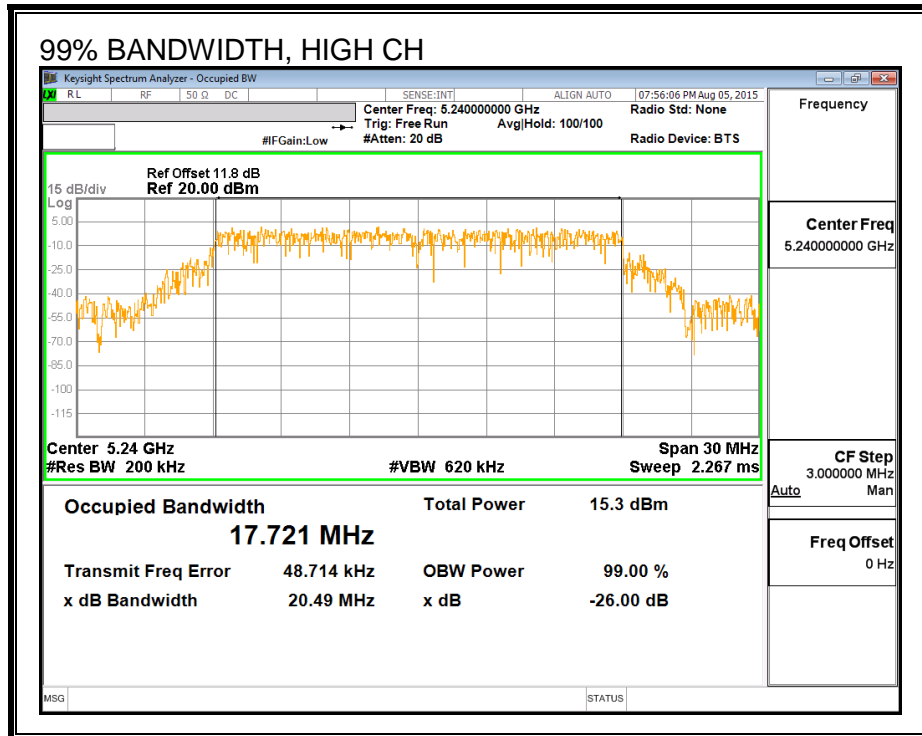
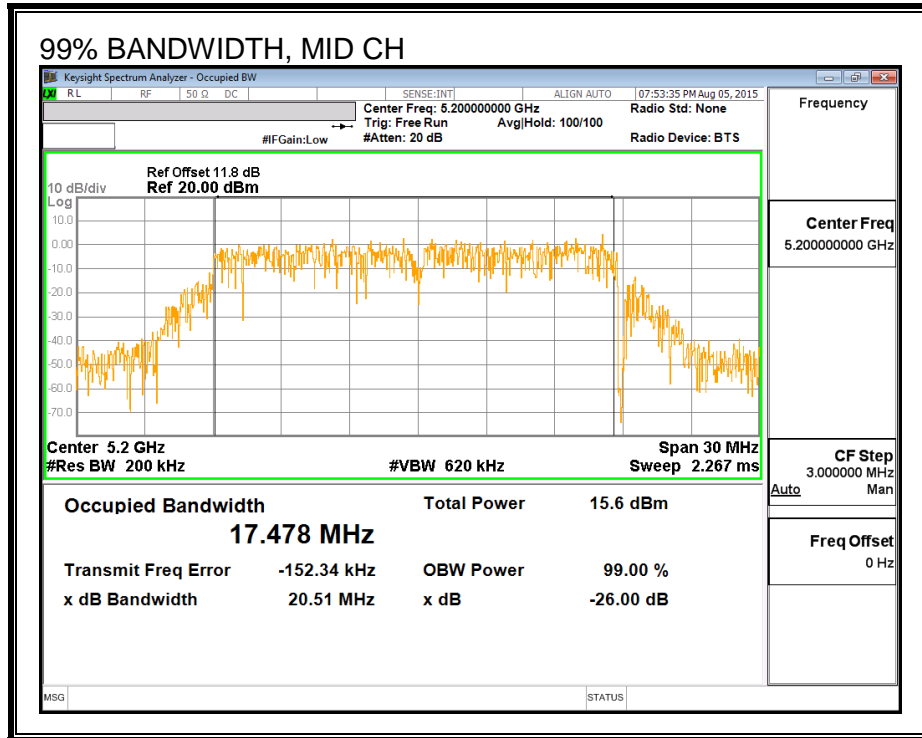

8.6.3. AVERAGE POWER

LIMITS

None; for reporting purposes only.

RESULTS

Average Power Results

Channel	Frequency (MHz)	Chain 0 Power (dBm)	Chain 1 Power (dBm)	Total Power (dBm)
Low	5180	14.89	14.95	17.93
Mid	5200	16.99	16.99	20.00
High	5240	16.97	16.91	19.95

8.6.4. OUTPUT POWER AND PSD

LIMITS

FCC §15.407 (a) (1)

(i) For an outdoor access point operating in the band 5.15-5.25 GHz, the maximum conducted output power over the frequency band of operation shall not exceed 1 W provided the maximum antenna gain does not exceed 6 dBi. In addition, the maximum power spectral density shall not exceed 17 dBm in any 1 megahertz band. If transmitting antennas of directional gain greater than 6 dBi are used, both the maximum conducted output power and the maximum power spectral density shall be reduced by the amount in dB that the directional gain of the antenna exceeds 6 dBi. The maximum e.i.r.p. at any elevation angle above 30 degrees as measured from the horizon must not exceed 125 mW (21 dBm).

(ii) For an indoor access point operating in the band 5.15-5.25 GHz, the maximum conducted output power over the frequency band of operation shall not exceed 1 W provided the maximum antenna gain does not exceed 6 dBi. In addition, the maximum power spectral density shall not exceed 17 dBm in any 1 megahertz band. If transmitting antennas of directional gain greater than 6 dBi are used, both the maximum conducted output power and the maximum power spectral density shall be reduced by the amount in dB that the directional gain of the antenna exceeds 6 dBi.

(iii) For fixed point-to-point access points operating in the band 5.15-5.25 GHz, the maximum conducted output power over the frequency band of operation shall not exceed 1 W. Fixed point-to-point U-NII devices may employ antennas with directional gain up to 23 dBi without any corresponding reduction in the maximum conducted output power or maximum power spectral density. For fixed point-to-point transmitters that employ a directional antenna gain greater than 23 dBi, a 1 dB reduction in maximum conducted output power and maximum power spectral density is required for each 1 dB of antenna gain in excess of 23 dBi. Fixed, point-to-point operations exclude the use of point-to-multipoint systems, omnidirectional applications, and multiple collocated transmitters transmitting the same information. The operator of the U-NII device, or if the equipment is professionally installed, the installer, is responsible for ensuring that systems employing high gain directional antennas are used exclusively for fixed, point-to-point operations.

(iv) For mobile and portable client devices in the 5.15-5.25 GHz band, the maximum conducted output power over the frequency band of operation shall not exceed 250 mW provided the maximum antenna gain does not exceed 6 dBi. In addition, the maximum power spectral density shall not exceed 11 dBm in any 1 megahertz band. If transmitting antennas of directional gain greater than 6 dBi are used, both the maximum conducted output power and the maximum power spectral density shall be reduced by the amount in dB that the directional gain of the antenna exceeds 6 dBi.

DIRECTIONAL ANTENNA GAIN

The TX chains are uncorrelated and the antenna gain is unequal among the chains. The directional gain is:

Antenna Gain (dBi)	Antenna Gain (dBi)	Directional Gain (dBi)
1.90	2.30	2.10

RESULTS

Antenna Gain and Limits

Channel	Frequency (MHz)	Directional Gain for Power (dBi)	Directional Gain for PSD (dBi)	Power Limit (dBm)	PSD Limit (dBm)
Low	5180	2.10	2.10	24.00	11.00
Mid	5200	2.10	2.10	24.00	11.00
High	5240	2.10	2.10	24.00	11.00

Duty Cycle CF (dB)	0.00	Included in Calculations of Corr'd Power & PSD
---------------------------	------	---

Output Power Results

Channel	Frequency (MHz)	Chain 0 Meas Power (dBm)	Chain 1 Meas Power (dBm)	Total Corr'd Power (dBm)	Power Limit (dBm)	Power Margin (dB)
Low	5180	14.89	14.95	17.93	24.00	-6.07
Mid	5200	16.99	16.99	20.00	24.00	-4.00
High	5240	16.97	16.91	19.95	24.00	-4.05

PSD Results

Channel	Frequency (MHz)	Chain 0 Meas PSD (dBm)	Chain 1 Meas PSD (dBm)	Total Corr'd PSD (dBm)	PSD Limit (dBm)	PSD Margin (dB)
Low	5180	3.32	3.48	6.41	11.00	-4.59
Mid	5200	5.48	5.73	8.62	11.00	-2.38
High	5240	5.38	5.47	8.44	11.00	-2.56

PSD, Chain 0

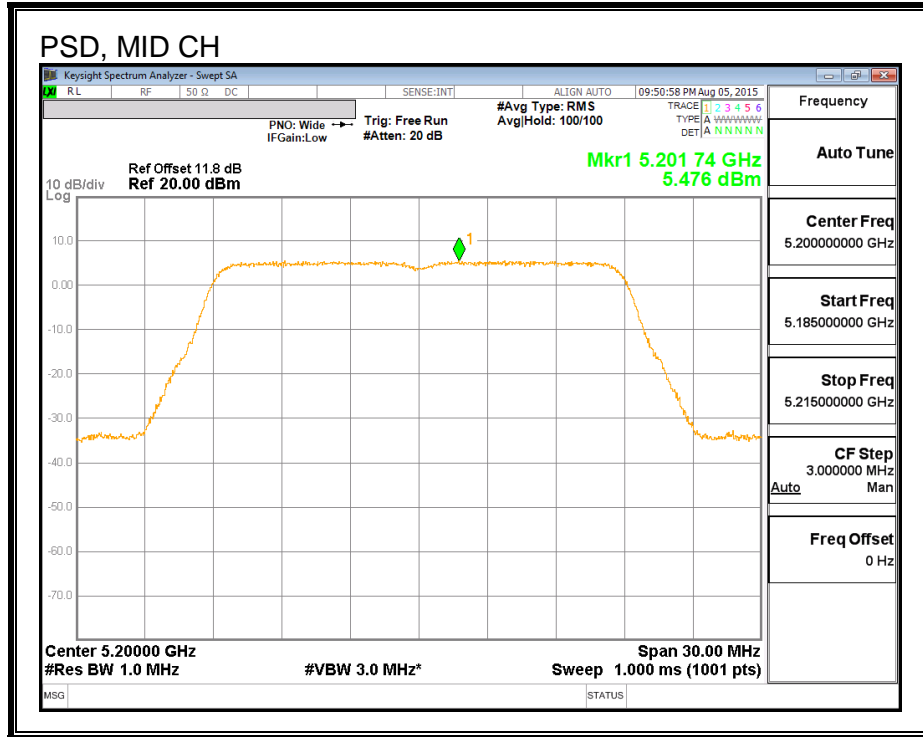
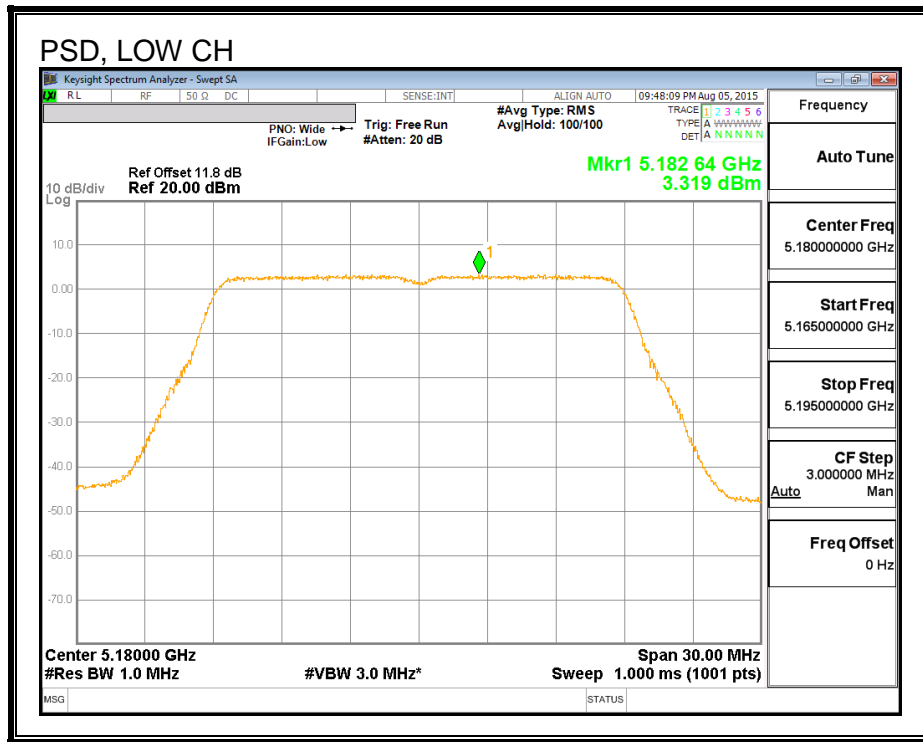

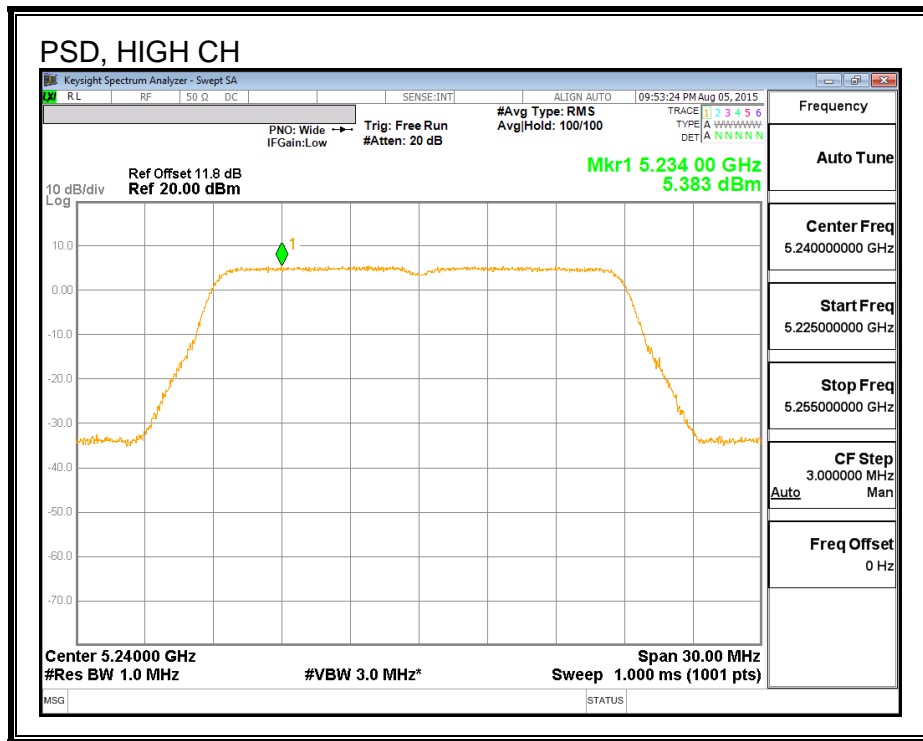

PSD, Chain 1

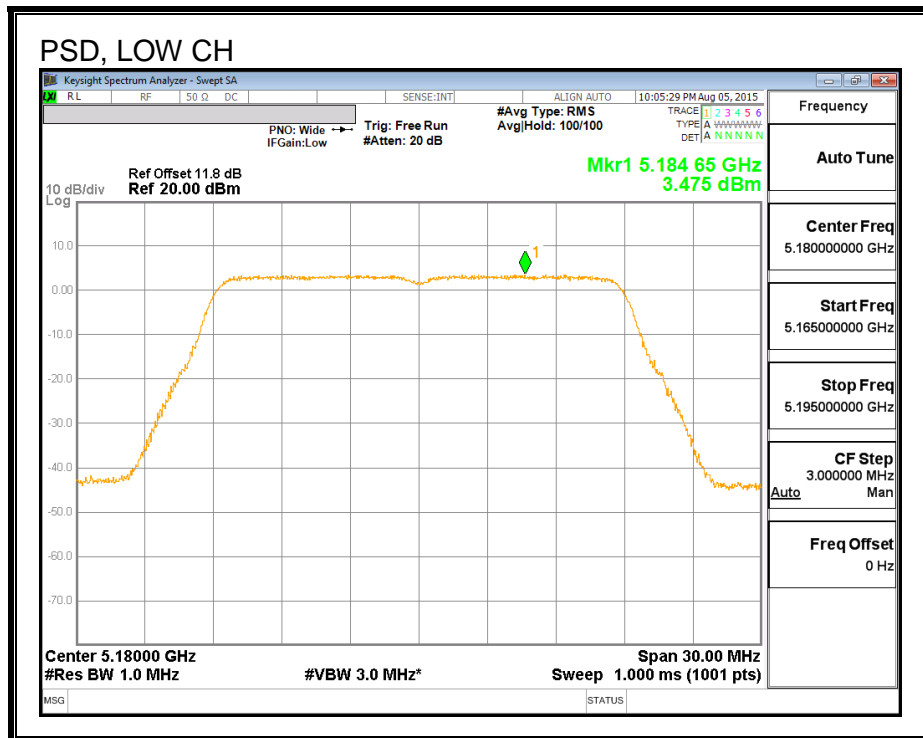

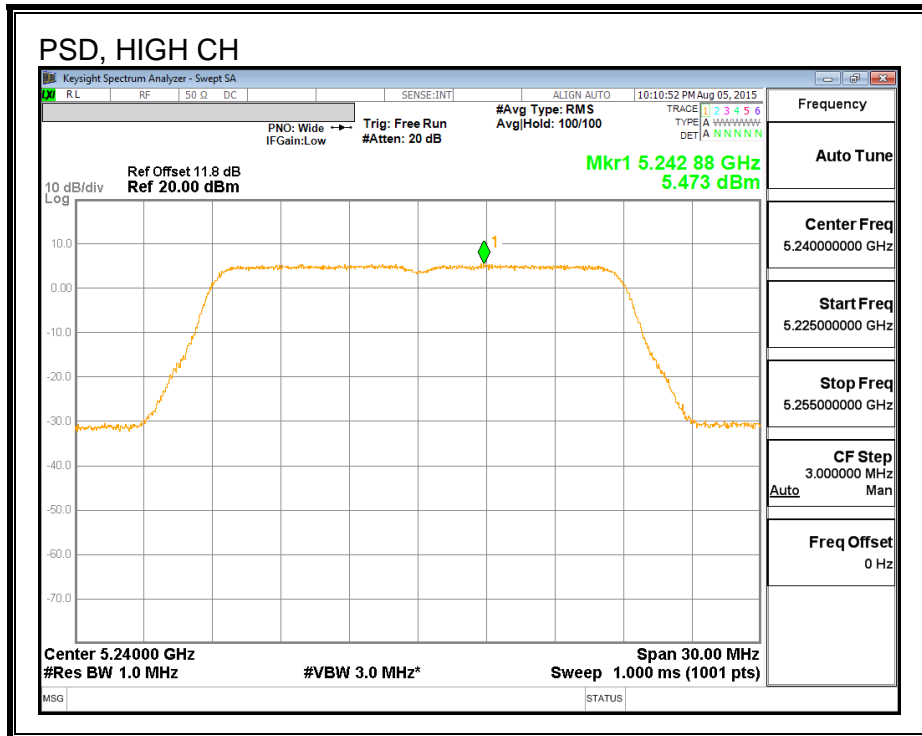
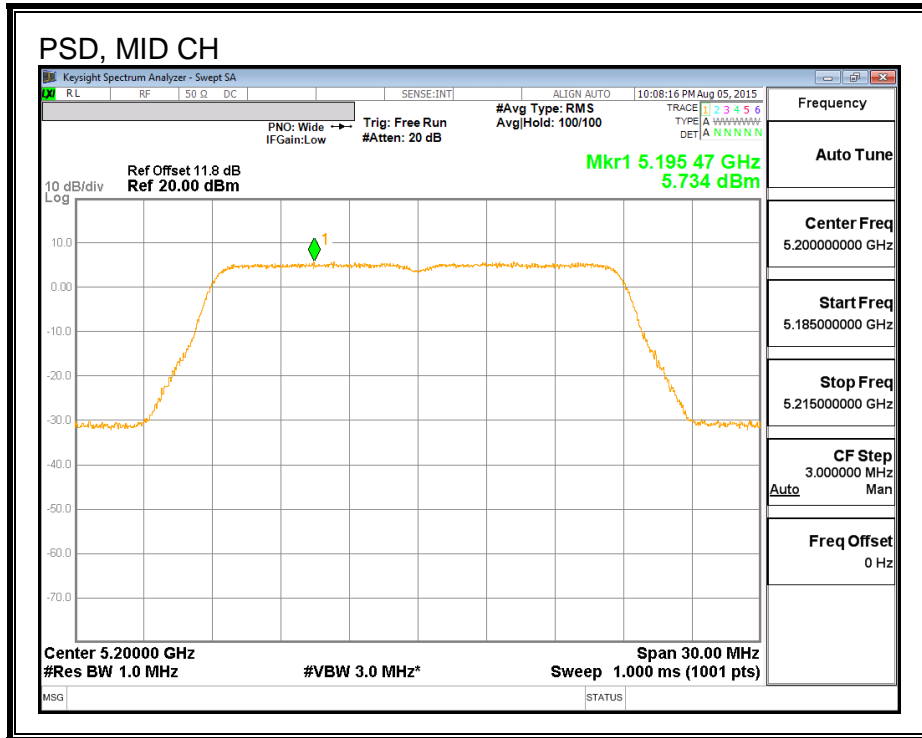

8.7. 802.11n HT20 2Tx SDM MODE IN THE 5.2 GHz BAND

Note: Covered by 802.11n HT20 2Tx STBC MODE.

8.8. 802.11n HT40 CHAIN 0 MODE IN THE 5.2 GHz BAND

8.8.1. 26 dB BANDWIDTH

LIMITS

None; for reporting purposes only.

RESULTS

Channel	Frequency (MHz)	26 dB Bandwidth (MHz)
Low	5190	40.44
High	5230	40.26

26 dB BANDWIDTH

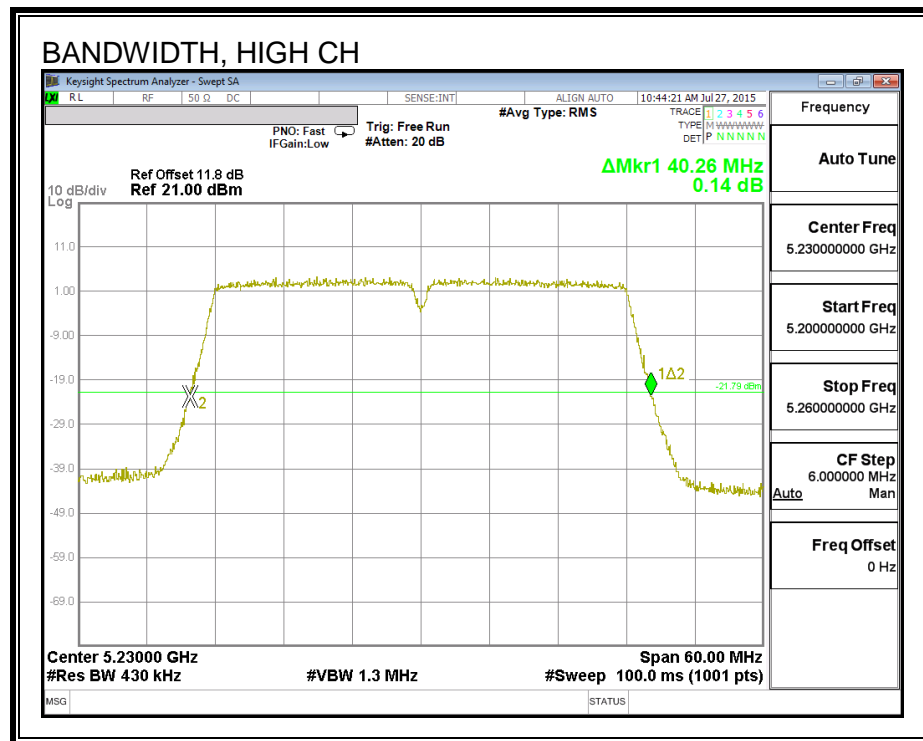
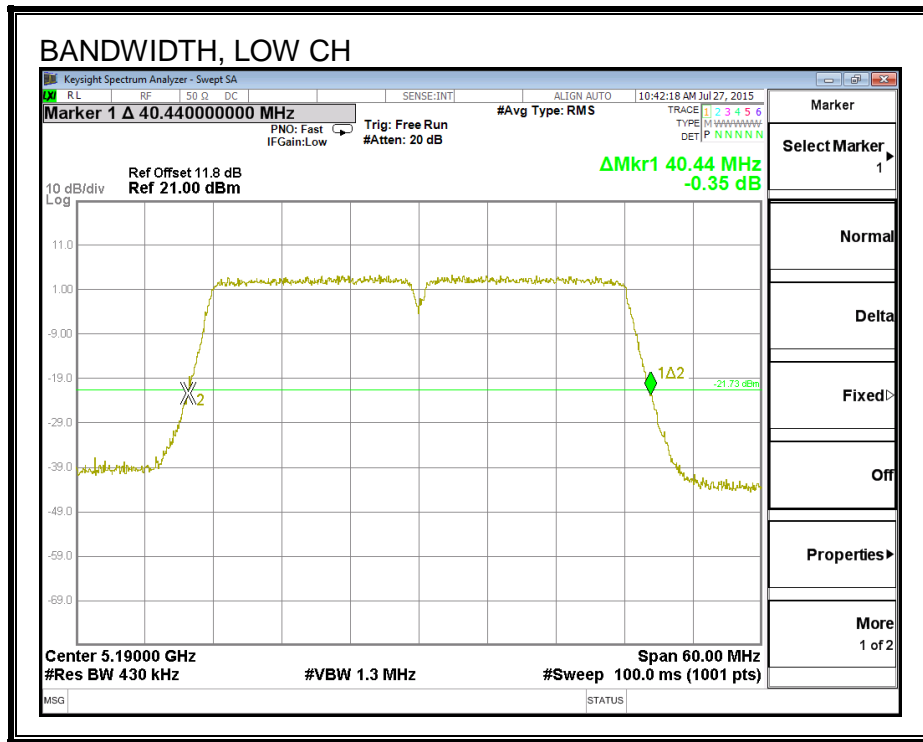

8.8.2. 99% BANDWIDTH

LIMITS

None; for reporting purposes only.

RESULTS

Channel	Frequency (MHz)	99% Bandwidth (MHz)
Low	5190	36.322
High	5230	36.440

99% BANDWIDTH

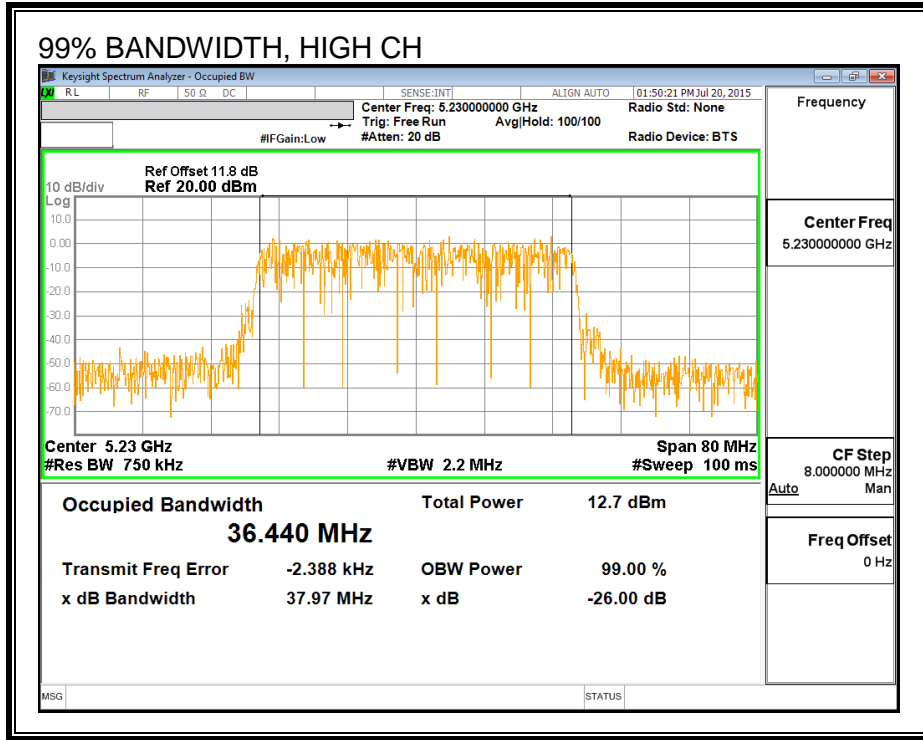
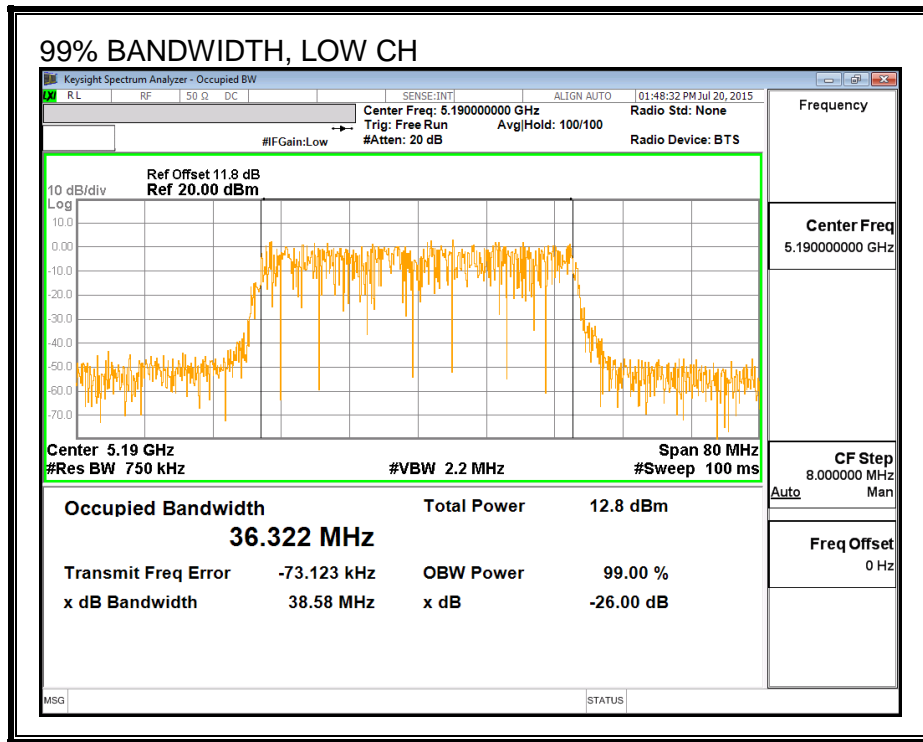

8.8.3. AVERAGE POWER

LIMITS

None; for reporting purposes only.

RESULTS

Channel	Frequency (MHz)	Power (dBm)
Low	5190	14.50
High	5230	16.89

8.8.4. OUTPUT POWER AND PSD

LIMITS

FCC §15.407 (a) (1)

(i) For an outdoor access point operating in the band 5.15-5.25 GHz, the maximum conducted output power over the frequency band of operation shall not exceed 1 W provided the maximum antenna gain does not exceed 6 dBi. In addition, the maximum power spectral density shall not exceed 17 dBm in any 1 megahertz band. If transmitting antennas of directional gain greater than 6 dBi are used, both the maximum conducted output power and the maximum power spectral density shall be reduced by the amount in dB that the directional gain of the antenna exceeds 6 dBi. The maximum e.i.r.p. at any elevation angle above 30 degrees as measured from the horizon must not exceed 125 mW (21 dBm).

(ii) For an indoor access point operating in the band 5.15-5.25 GHz, the maximum conducted output power over the frequency band of operation shall not exceed 1 W provided the maximum antenna gain does not exceed 6 dBi. In addition, the maximum power spectral density shall not exceed 17 dBm in any 1 megahertz band. If transmitting antennas of directional gain greater than 6 dBi are used, both the maximum conducted output power and the maximum power spectral density shall be reduced by the amount in dB that the directional gain of the antenna exceeds 6 dBi.

(iii) For fixed point-to-point access points operating in the band 5.15-5.25 GHz, the maximum conducted output power over the frequency band of operation shall not exceed 1 W. Fixed point-to-point U-NII devices may employ antennas with directional gain up to 23 dBi without any corresponding reduction in the maximum conducted output power or maximum power spectral density. For fixed point-to-point transmitters that employ a directional antenna gain greater than 23 dBi, a 1 dB reduction in maximum conducted output power and maximum power spectral density is required for each 1 dB of antenna gain in excess of 23 dBi. Fixed, point-to-point operations exclude the use of point-to-multipoint systems, omnidirectional applications, and multiple collocated transmitters transmitting the same information. The operator of the U-NII device, or if the equipment is professionally installed, the installer, is responsible for ensuring that systems employing high gain directional antennas are used exclusively for fixed, point-to-point operations.

(iv) For mobile and portable client devices in the 5.15-5.25 GHz band, the maximum conducted output power over the frequency band of operation shall not exceed 250 mW provided the maximum antenna gain does not exceed 6 dBi. In addition, the maximum power spectral density shall not exceed 11 dBm in any 1 megahertz band. If transmitting antennas of directional gain greater than 6 dBi are used, both the maximum conducted output power and the maximum power spectral density shall be reduced by the amount in dB that the directional gain of the antenna exceeds 6 dBi.

DIRECTIONAL ANTENNA GAIN

There is only one transmitter output therefore the directional gain is equal to the antenna gain.

RESULTS

Antenna Gain and Limits

Channel	Frequency (MHz)	Directional Gain for Power (dBi)	Directional Gain for PSD (dBi)	Power Limit (dBm)	PSD Limit (dBm)
Low	5190	1.90	1.90	24.00	11.00
High	5230	1.90	1.90	24.00	11.00

Duty Cycle CF (dB)	0.00	Included in Calculations of Corr'd Power & PSD
---------------------------	------	---

Output Power Results

Channel	Frequency (MHz)	Meas Power (dBm)	Total Corr'd Power (dBm)	Power Limit (dBm)	Power Margin (dB)
Low	5190	14.50	14.50	24.00	-9.50
High	5230	16.89	16.89	24.00	-7.11

PSD Results

Channel	Frequency (MHz)	Meas PSD (dBm)	Total Corr'd PSD (dBm)	PSD Limit (dBm)	PSD Margin (dB)
Low	5190	0.04	0.04	11.00	-10.96
High	5230	2.52	2.52	11.00	-8.48

PSD

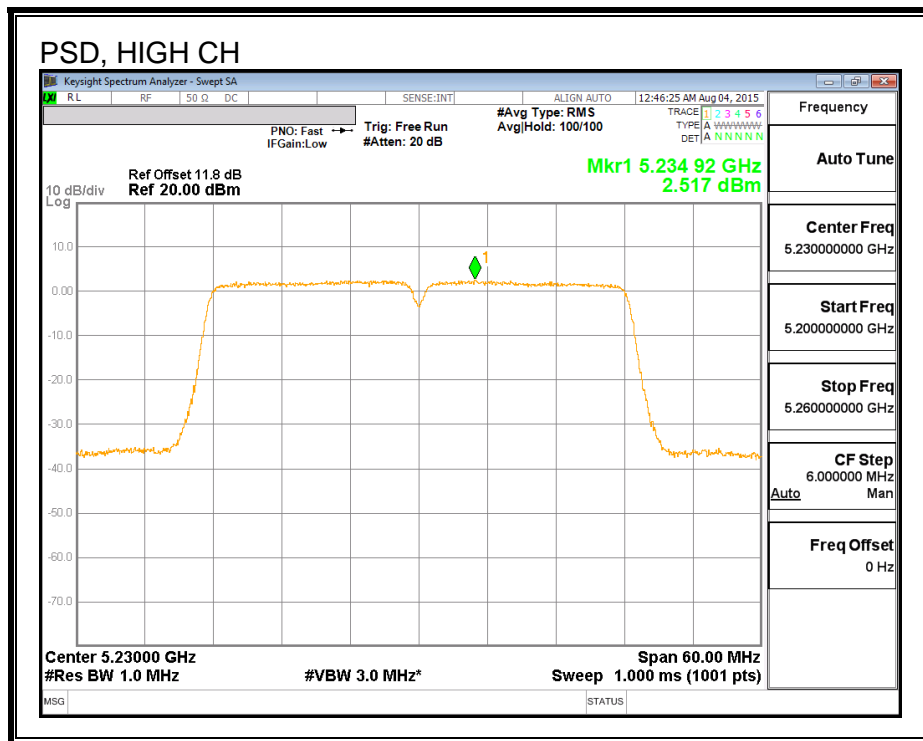
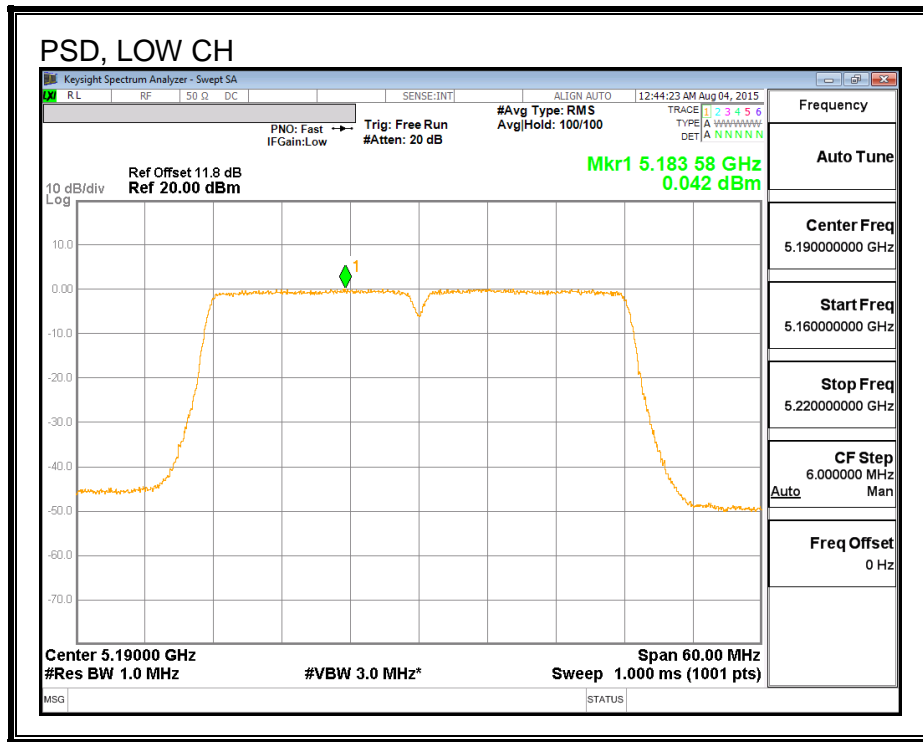

8.9. 802.11n HT40 CHAIN 1 MODE IN THE 5.2 GHz BAND

8.9.1. 26 dB BANDWIDTH

LIMITS

None; for reporting purposes only.

RESULTS

Channel	Frequency (MHz)	26 dB Bandwidth (MHz)
Low	5190	40.32
High	5230	40.38

26 dB BANDWIDTH

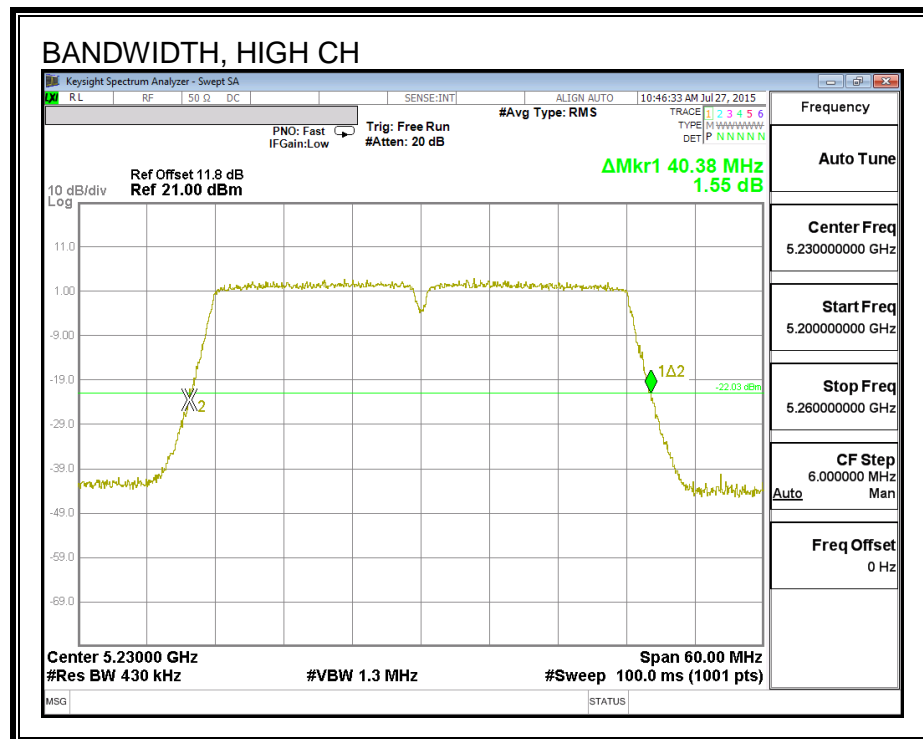
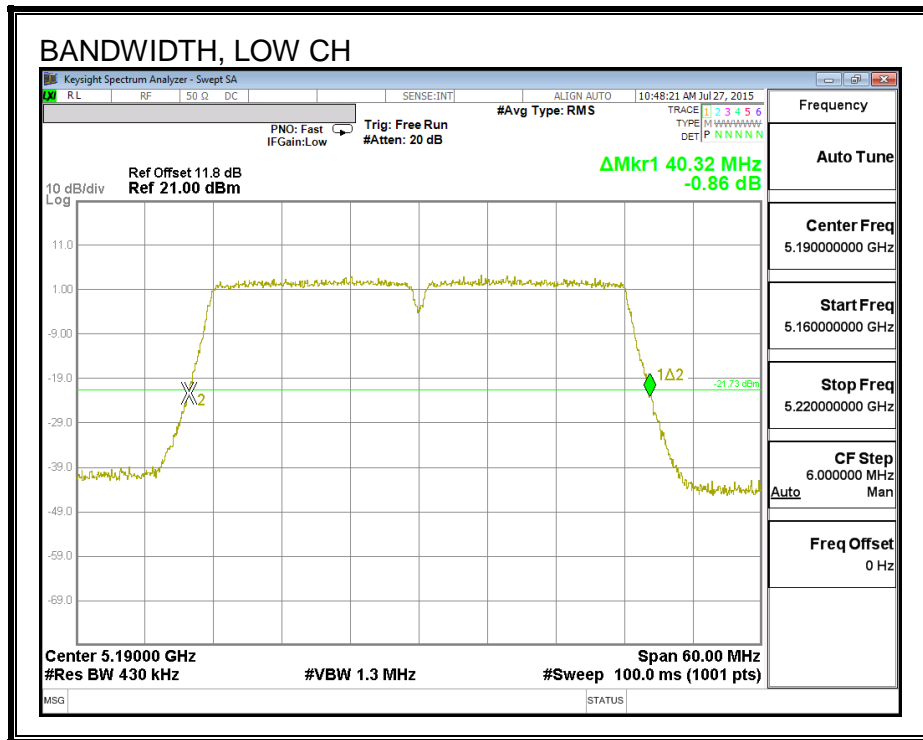

8.9.2. 99% BANDWIDTH

LIMITS

None; for reporting purposes only.

RESULTS

Channel	Frequency (MHz)	99% Bandwidth (MHz)
Low	5190	36.361
High	5230	36.550

99% BANDWIDTH

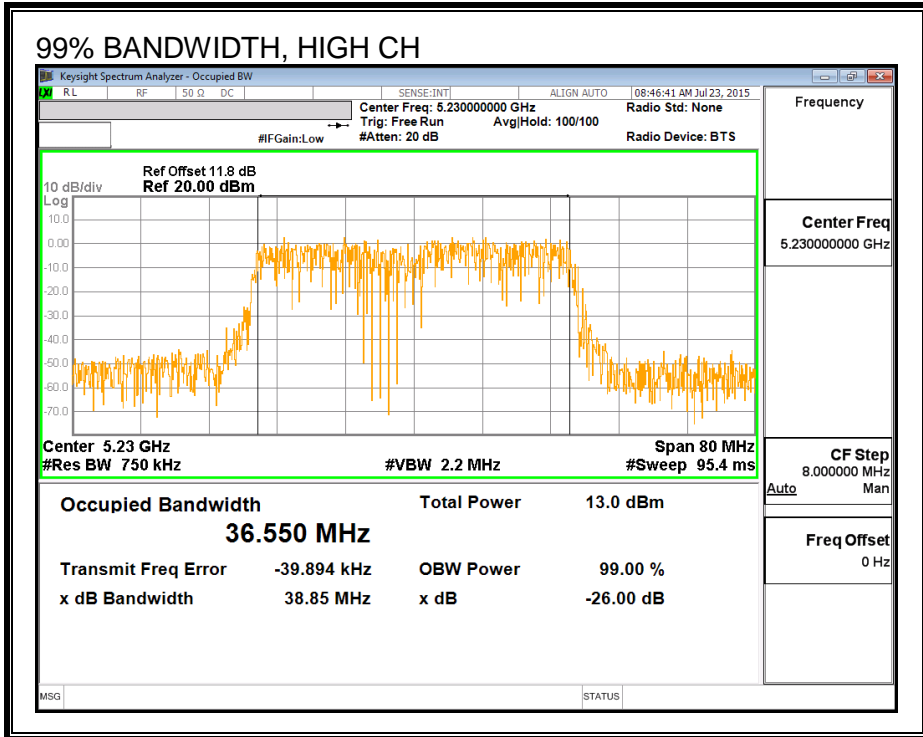
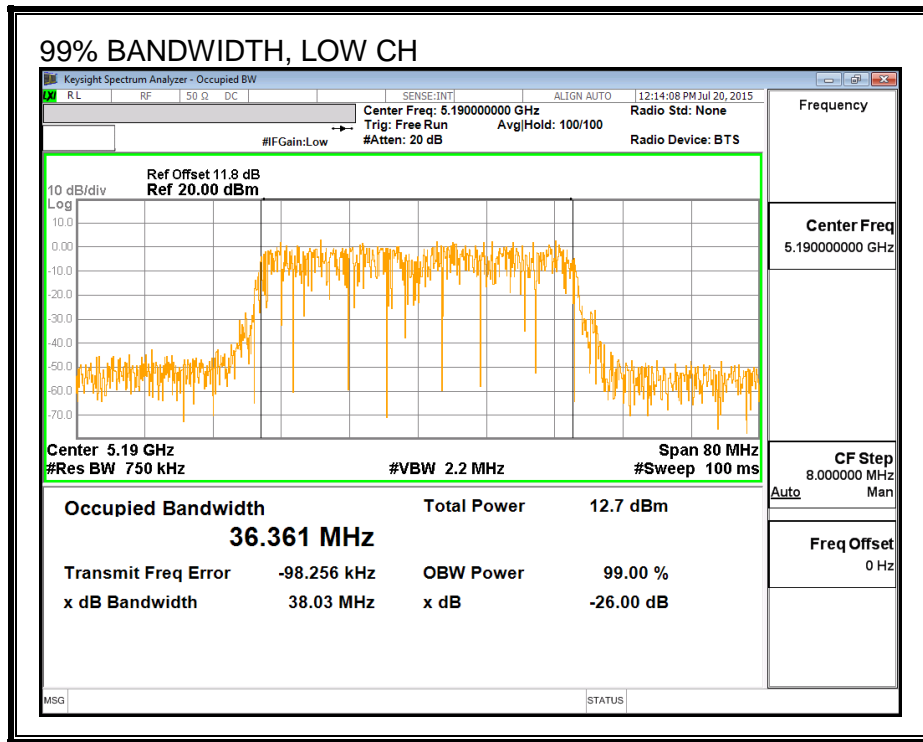

8.9.3. AVERAGE POWER

LIMITS

None; for reporting purposes only.

RESULTS

Channel	Frequency (MHz)	Power (dBm)
Low	5190	14.45
High	5230	16.81

8.9.4. OUTPUT POWER AND PSD

LIMITS

FCC §15.407 (a) (1)

(i) For an outdoor access point operating in the band 5.15-5.25 GHz, the maximum conducted output power over the frequency band of operation shall not exceed 1 W provided the maximum antenna gain does not exceed 6 dBi. In addition, the maximum power spectral density shall not exceed 17 dBm in any 1 megahertz band. If transmitting antennas of directional gain greater than 6 dBi are used, both the maximum conducted output power and the maximum power spectral density shall be reduced by the amount in dB that the directional gain of the antenna exceeds 6 dBi. The maximum e.i.r.p. at any elevation angle above 30 degrees as measured from the horizon must not exceed 125 mW (21 dBm).

(ii) For an indoor access point operating in the band 5.15-5.25 GHz, the maximum conducted output power over the frequency band of operation shall not exceed 1 W provided the maximum antenna gain does not exceed 6 dBi. In addition, the maximum power spectral density shall not exceed 17 dBm in any 1 megahertz band. If transmitting antennas of directional gain greater than 6 dBi are used, both the maximum conducted output power and the maximum power spectral density shall be reduced by the amount in dB that the directional gain of the antenna exceeds 6 dBi.

(iii) For fixed point-to-point access points operating in the band 5.15-5.25 GHz, the maximum conducted output power over the frequency band of operation shall not exceed 1 W. Fixed point-to-point U-NII devices may employ antennas with directional gain up to 23 dBi without any corresponding reduction in the maximum conducted output power or maximum power spectral density. For fixed point-to-point transmitters that employ a directional antenna gain greater than 23 dBi, a 1 dB reduction in maximum conducted output power and maximum power spectral density is required for each 1 dB of antenna gain in excess of 23 dBi. Fixed, point-to-point operations exclude the use of point-to-multipoint systems, omnidirectional applications, and multiple collocated transmitters transmitting the same information. The operator of the U-NII device, or if the equipment is professionally installed, the installer, is responsible for ensuring that systems employing high gain directional antennas are used exclusively for fixed, point-to-point operations.

(iv) For mobile and portable client devices in the 5.15-5.25 GHz band, the maximum conducted output power over the frequency band of operation shall not exceed 250 mW provided the maximum antenna gain does not exceed 6 dBi. In addition, the maximum power spectral density shall not exceed 11 dBm in any 1 megahertz band. If transmitting antennas of directional gain greater than 6 dBi are used, both the maximum conducted output power and the maximum power spectral density shall be reduced by the amount in dB that the directional gain of the antenna exceeds 6 dBi.

DIRECTIONAL ANTENNA GAIN

There is only one transmitter output therefore the directional gain is equal to the antenna gain.

RESULTS

Antenna Gain and Limits

Channel	Frequency (MHz)	Directional Gain for Power (dBi)	Directional Gain for PSD (dBi)	Power Limit (dBm)	PSD Limit (dBm)
Low	5190	2.30	2.30	24.00	11.00
High	5230	2.30	2.30	24.00	11.00

Duty Cycle CF (dB)	0.00	Included in Calculations of Corr'd Power & PSD
---------------------------	------	---

Output Power Results

Channel	Frequency (MHz)	Meas Power (dBm)	Total Corr'd Power (dBm)	Power Limit (dBm)	Power Margin (dB)
Low	5190	14.45	14.45	24.00	-9.55
High	5230	16.81	16.81	24.00	-7.19

PSD Results

Channel	Frequency (MHz)	Meas PSD (dBm)	Total Corr'd PSD (dBm)	PSD Limit (dBm)	PSD Margin (dB)
Low	5190	-0.11	-0.11	11.00	-11.11
High	5230	2.34	2.34	11.00	-8.66

PSD

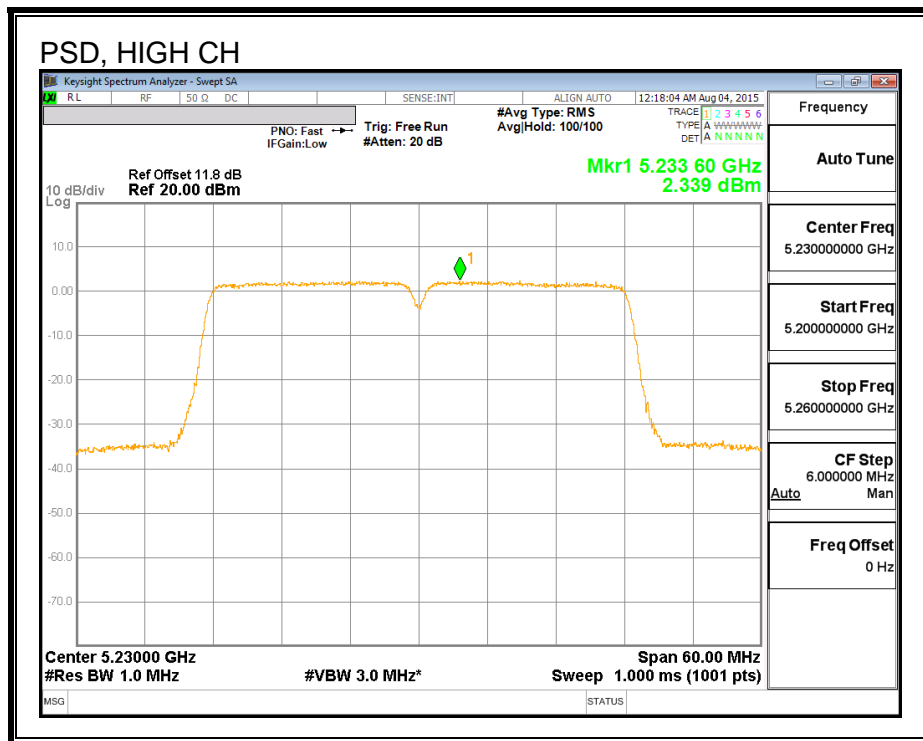
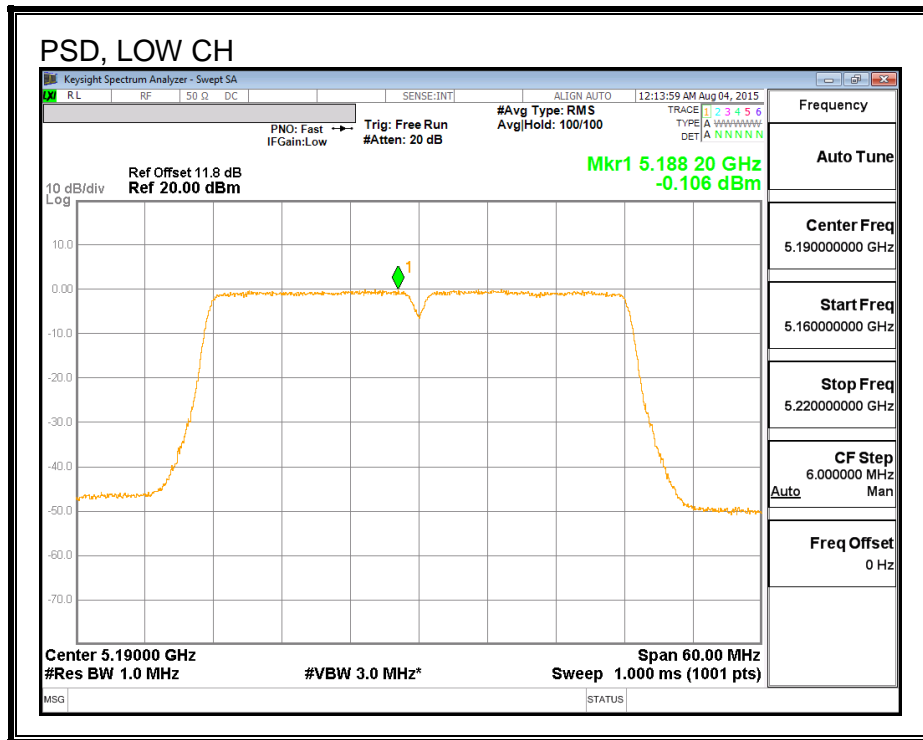

8.10. 802.11n HT40 2TX CDD MODE IN THE 5.2 GHz BAND

8.10.1. 26 dB BANDWIDTH

LIMITS

None; for reporting purposes only.

RESULTS

Channel	Frequency (MHz)	26 dB BW Chain 0 (MHz)	26 dB BW Chain 1 (MHz)
Low	5190	40.44	40.08
High	5230	40.38	40.02

26 DB BANDWIDTH, CHAIN 0

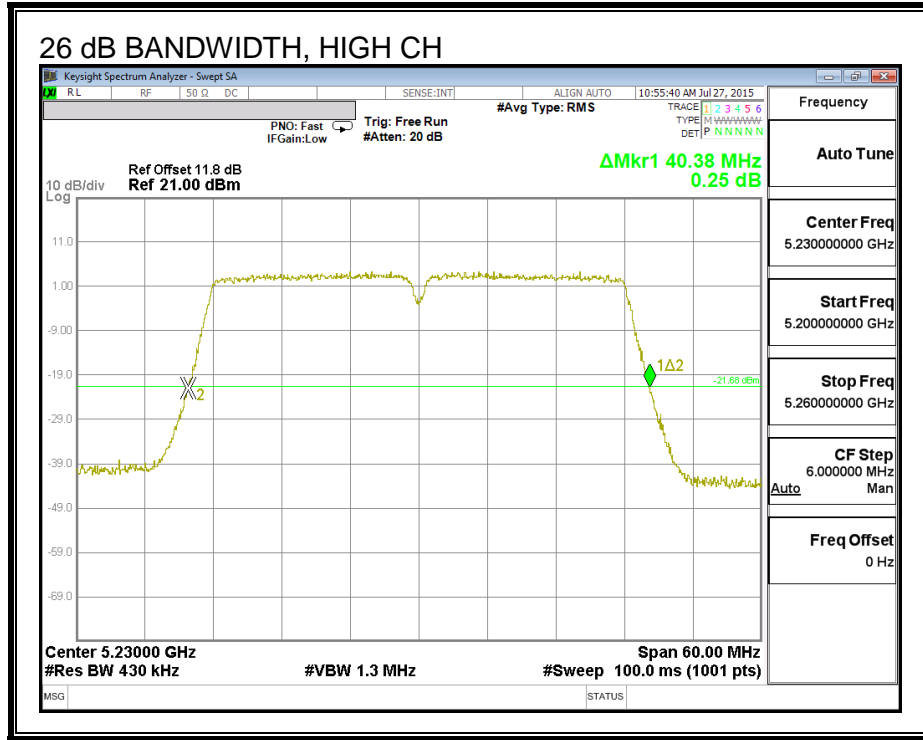
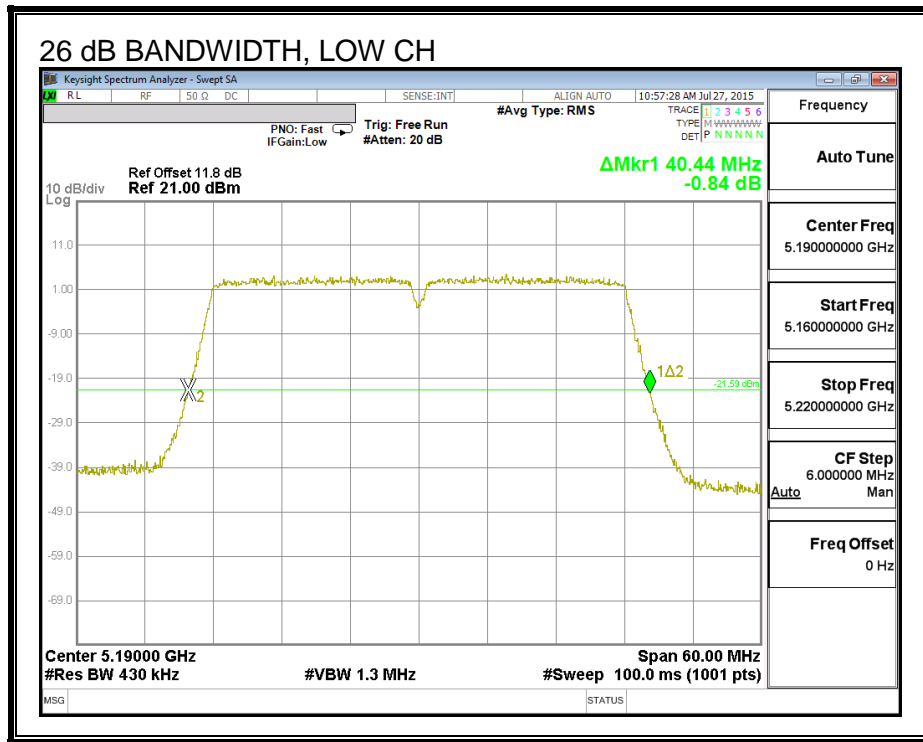

8.10.2. 99% BANDWIDTH

LIMITS

None; for reporting purposes only.

RESULTS

Channel	Frequency (MHz)	99% BW Chain 0 (MHz)	99% BW Chain 1 (MHz)
Low	5190	36.206	36.416
High	5230	36.471	36.322

99% BANDWIDTH, CHAIN 0

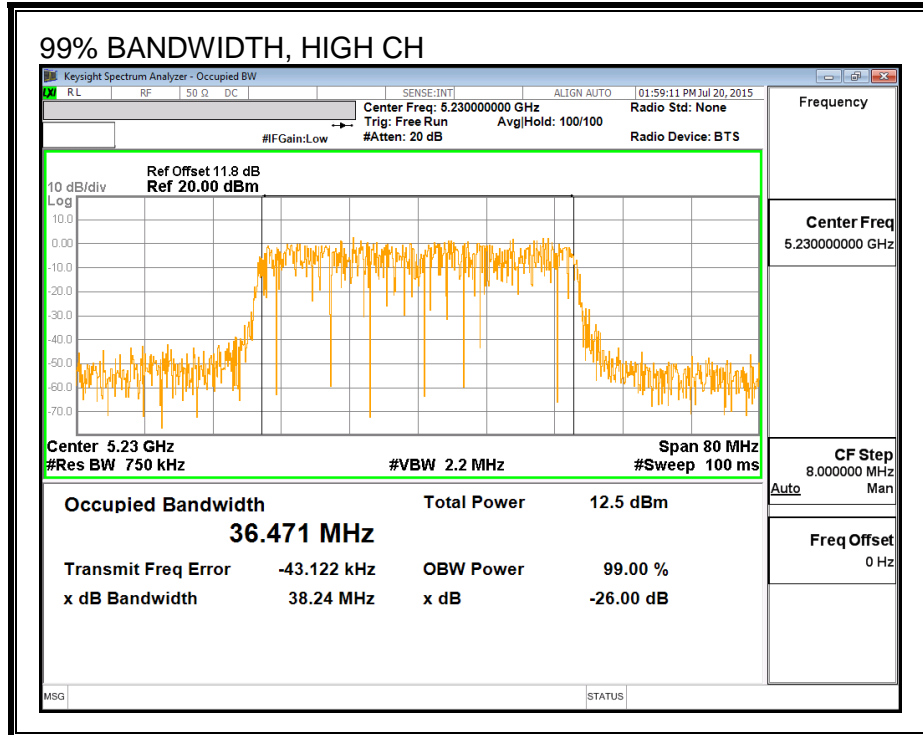
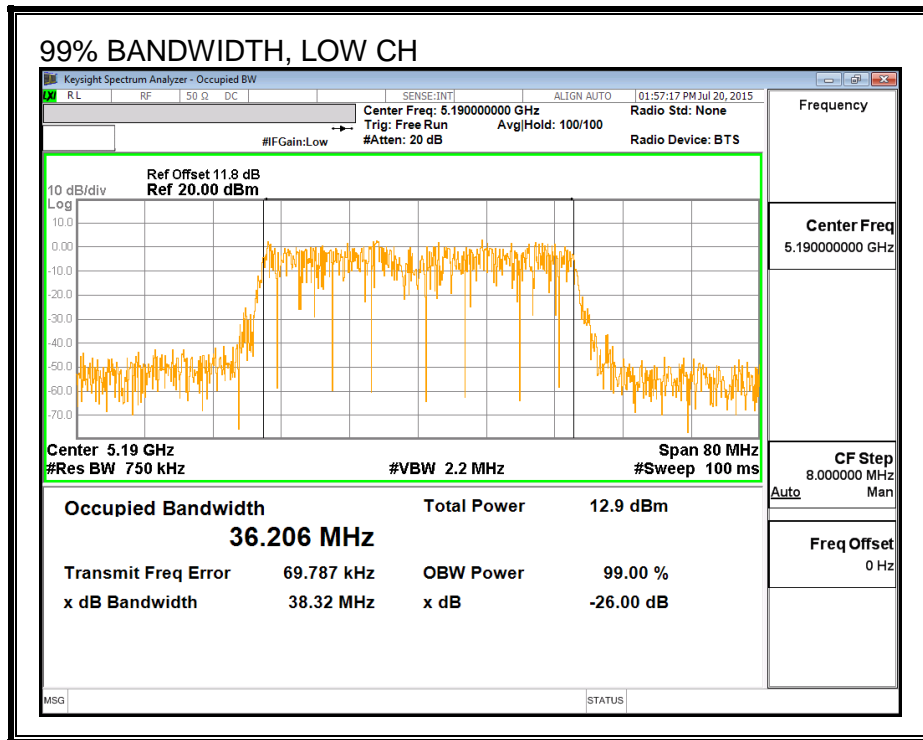

99% BANDWIDTH, CHAIN 1

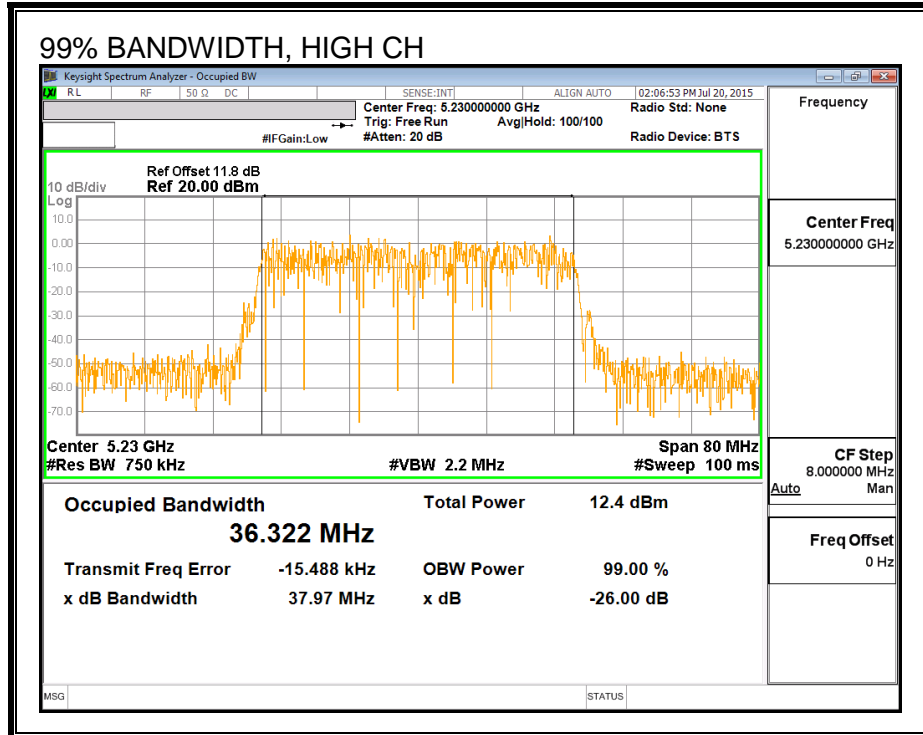
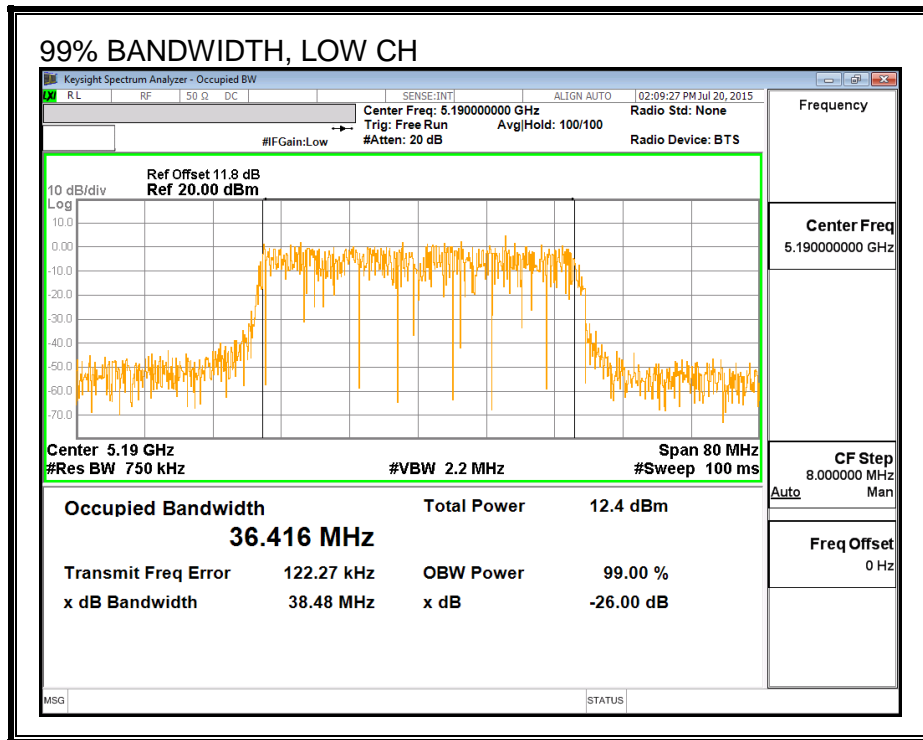

8.10.3. AVERAGE POWER

LIMITS

None; for reporting purposes only.

RESULTS

Average Power Results

Channel	Frequency (MHz)	Chain 0 Power (dBm)	Chain 1 Power (dBm)	Total Power (dBm)
Low	5190	12.99	12.98	16.00
High	5230	16.49	16.47	19.49

8.10.4. OUTPUT POWER AND PSD

LIMITS

FCC §15.407 (a) (1)

(i) For an outdoor access point operating in the band 5.15-5.25 GHz, the maximum conducted output power over the frequency band of operation shall not exceed 1 W provided the maximum antenna gain does not exceed 6 dBi. In addition, the maximum power spectral density shall not exceed 17 dBm in any 1 megahertz band. If transmitting antennas of directional gain greater than 6 dBi are used, both the maximum conducted output power and the maximum power spectral density shall be reduced by the amount in dB that the directional gain of the antenna exceeds 6 dBi. The maximum e.i.r.p. at any elevation angle above 30 degrees as measured from the horizon must not exceed 125 mW (21 dBm).

(ii) For an indoor access point operating in the band 5.15-5.25 GHz, the maximum conducted output power over the frequency band of operation shall not exceed 1 W provided the maximum antenna gain does not exceed 6 dBi. In addition, the maximum power spectral density shall not exceed 17 dBm in any 1 megahertz band. If transmitting antennas of directional gain greater than 6 dBi are used, both the maximum conducted output power and the maximum power spectral density shall be reduced by the amount in dB that the directional gain of the antenna exceeds 6 dBi.

(iii) For fixed point-to-point access points operating in the band 5.15-5.25 GHz, the maximum conducted output power over the frequency band of operation shall not exceed 1 W. Fixed point-to-point U-NII devices may employ antennas with directional gain up to 23 dBi without any corresponding reduction in the maximum conducted output power or maximum power spectral density. For fixed point-to-point transmitters that employ a directional antenna gain greater than 23 dBi, a 1 dB reduction in maximum conducted output power and maximum power spectral density is required for each 1 dB of antenna gain in excess of 23 dBi. Fixed, point-to-point operations exclude the use of point-to-multipoint systems, omnidirectional applications, and multiple collocated transmitters transmitting the same information. The operator of the U-NII device, or if the equipment is professionally installed, the installer, is responsible for ensuring that systems employing high gain directional antennas are used exclusively for fixed, point-to-point operations.

(iv) For mobile and portable client devices in the 5.15-5.25 GHz band, the maximum conducted output power over the frequency band of operation shall not exceed 250 mW provided the maximum antenna gain does not exceed 6 dBi. In addition, the maximum power spectral density shall not exceed 11 dBm in any 1 megahertz band. If transmitting antennas of directional gain greater than 6 dBi are used, both the maximum conducted output power and the maximum power spectral density shall be reduced by the amount in dB that the directional gain of the antenna exceeds 6 dBi.

DIRECTIONAL ANTENNA GAIN

The TX chains are uncorrelated and the antenna gain is unequal among the chains. The directional gain is:

Antenna Gain (dBi)	Antenna Gain (dBi)	Directional Gain (dBi)
1.90	2.30	2.10

The TX chains are correlated and the antenna gain is unequal among the chains. The directional gain is:

Chain 0 Antenna Gain (dBi)	Chain 1 Antenna Gain (dBi)	Correlated Chains Directional Gain (dBi)
1.90	2.30	5.11

RESULTS

Antenna Gain and Limits

Channel	Frequency (MHz)	Directional Gain for Power (dBi)	Directional Gain for PSD (dBi)	Power Limit (dBm)	PSD Limit (dBm)
Low	5190	2.10	5.11	24.00	11.00
High	5230	2.10	5.11	24.00	11.00

Duty Cycle CF (dB)	0.00	Included in Calculations of Corr'd Power & PSD
---------------------------	------	---

Output Power Results

Channel	Frequency (MHz)	Chain 0 Meas Power (dBm)	Chain 1 Meas Power (dBm)	Total Corr'd Power (dBm)	Power Limit (dBm)	Power Margin (dB)
Low	5190	12.99	12.98	16.00	24.00	-8.00
High	5230	16.49	16.47	19.49	24.00	-4.51

PSD Results

Channel	Frequency (MHz)	Chain 0 Meas PSD (dBm)	Chain 1 Meas PSD (dBm)	Total Corr'd PSD (dBm)	PSD Limit (dBm)	PSD Margin (dB)
Low	5190	-1.47	-1.52	1.51	11.00	-9.49
High	5230	1.93	1.89	4.92	11.00	-6.08

PSD, Chain 0

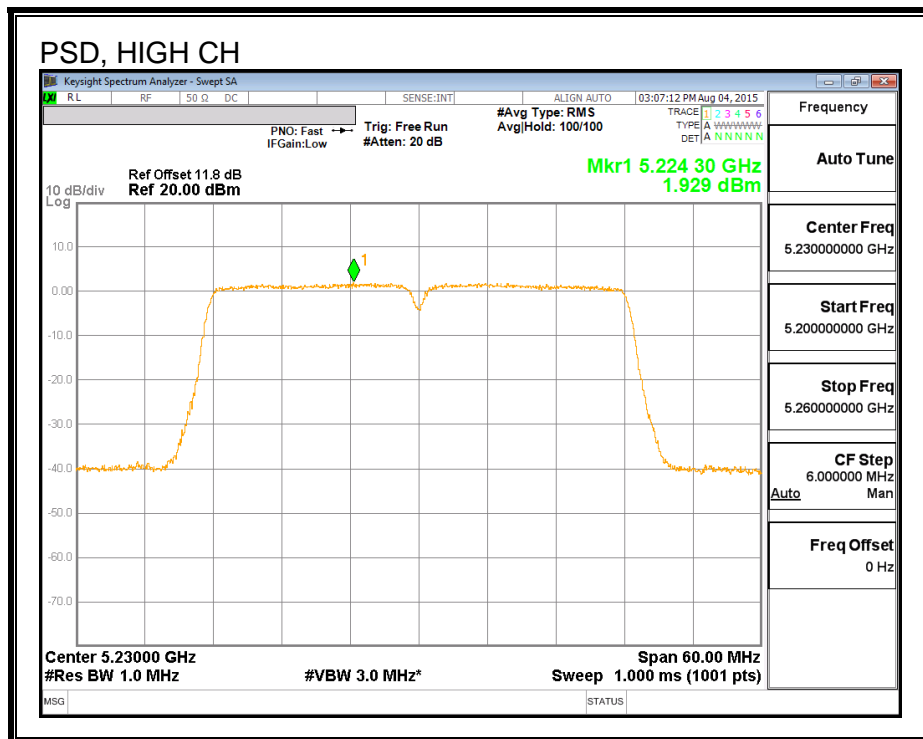
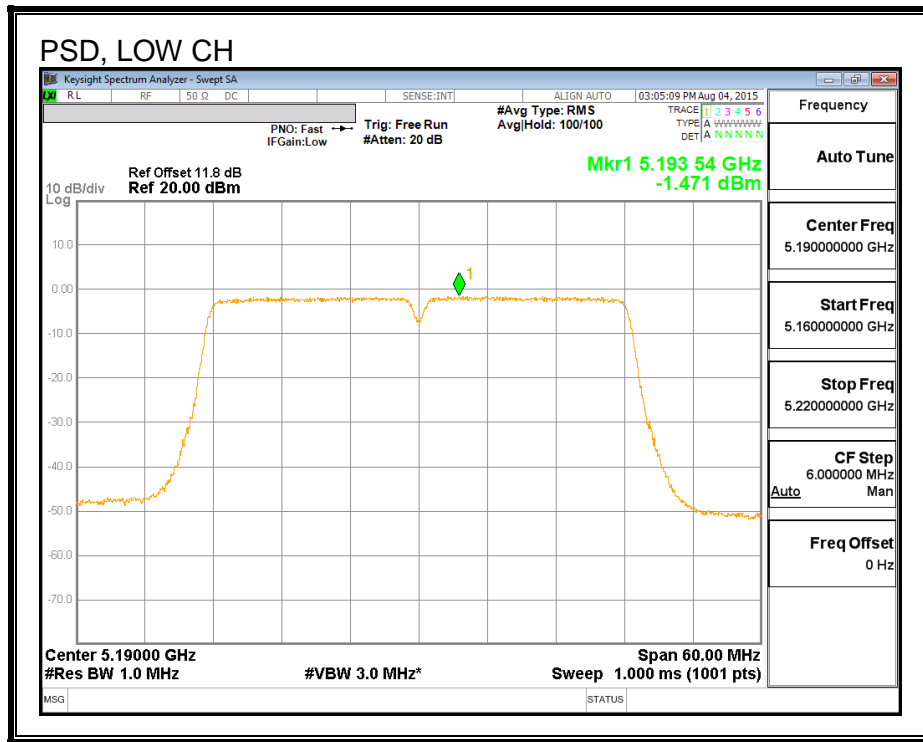

PSD, Chain 1

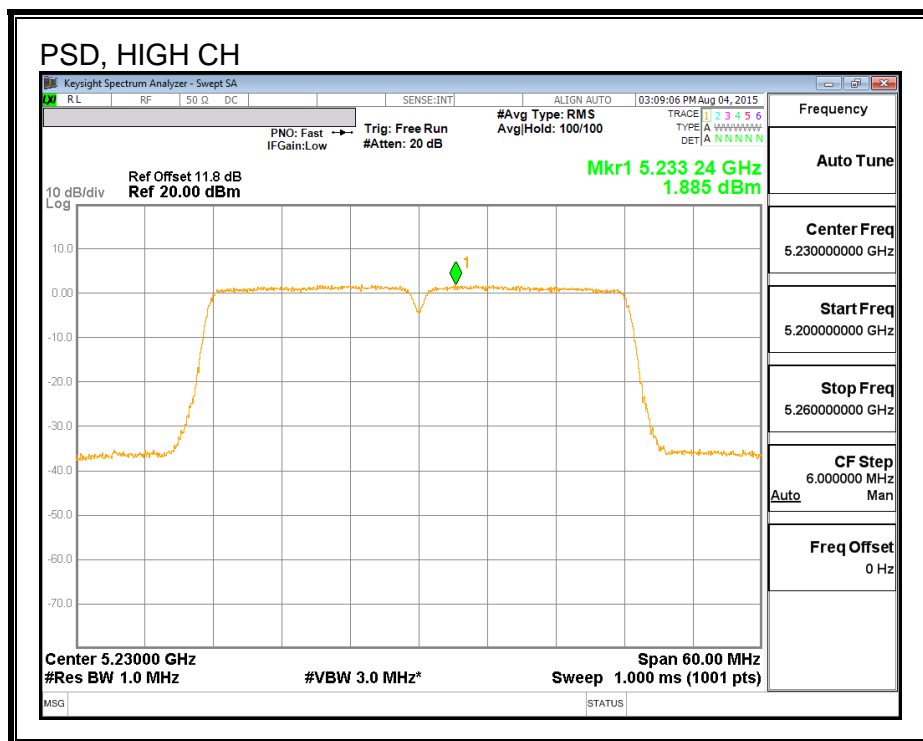
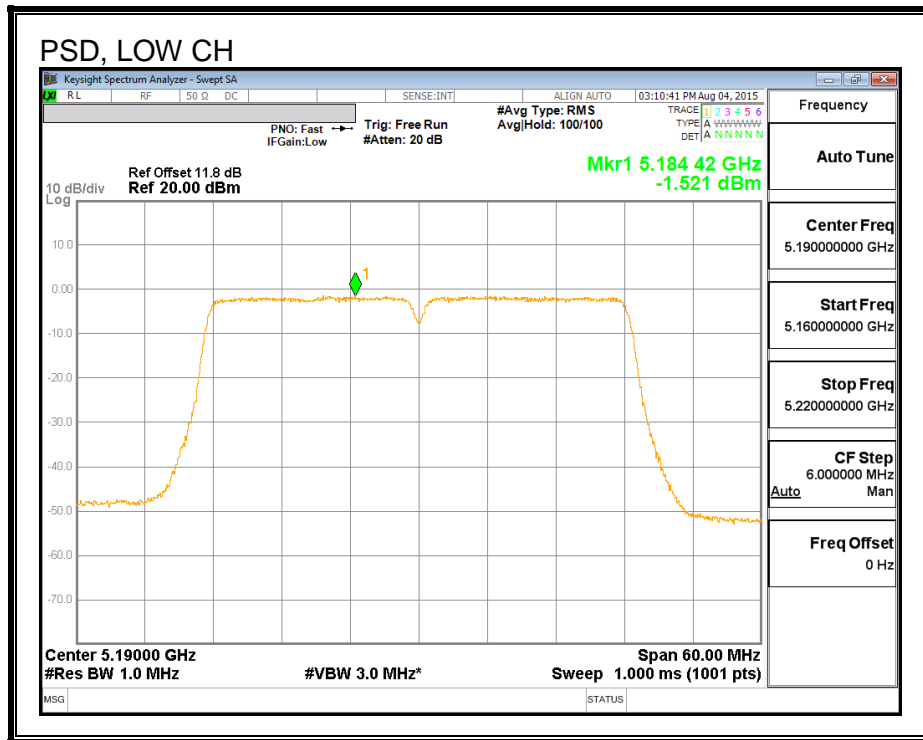

8.11. 802.11n HT40 2Tx STBC MODE IN THE 5.2 GHz BAND

8.11.1. 26 dB BANDWIDTH

LIMITS

None; for reporting purposes only.

RESULTS

Channel	Frequency (MHz)	26 dB BW Chain 0 (MHz)	26 dB BW Chain 1 (MHz)
Low	5190	40.02	39.60
High	5230	39.78	39.54

8.11.2. 99% BANDWIDTH

LIMITS

None; for reporting purposes only.

RESULTS

Channel	Frequency (MHz)	99% BW Chain 0 (MHz)	99% BW Chain 1 (MHz)
Low	5190	36.302	36.210
High	5230	36.100	36.169

99% BANDWIDTH, Chain 0

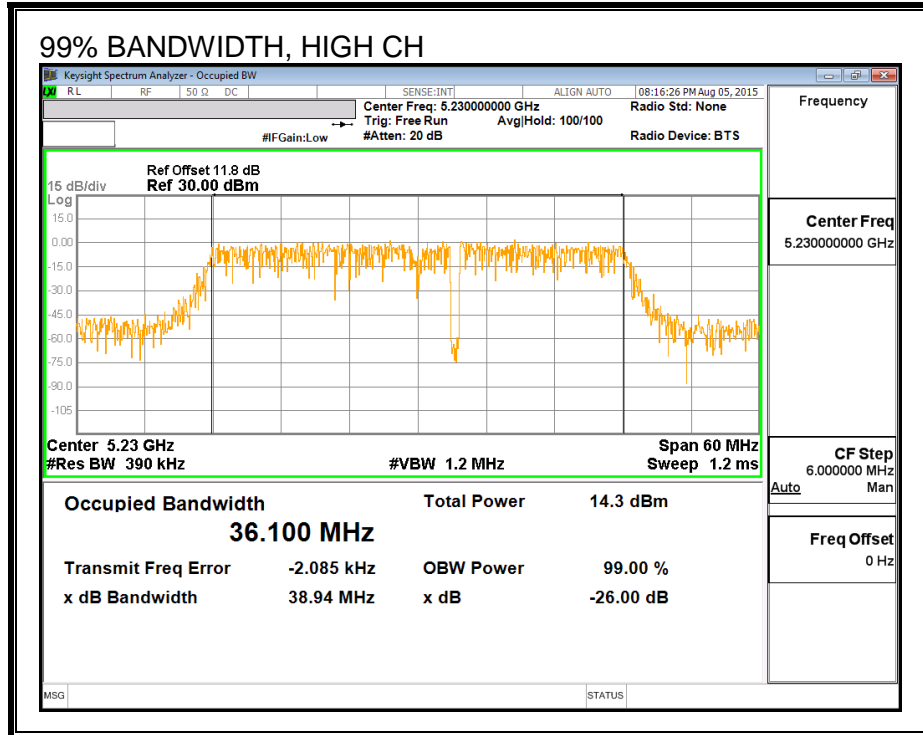
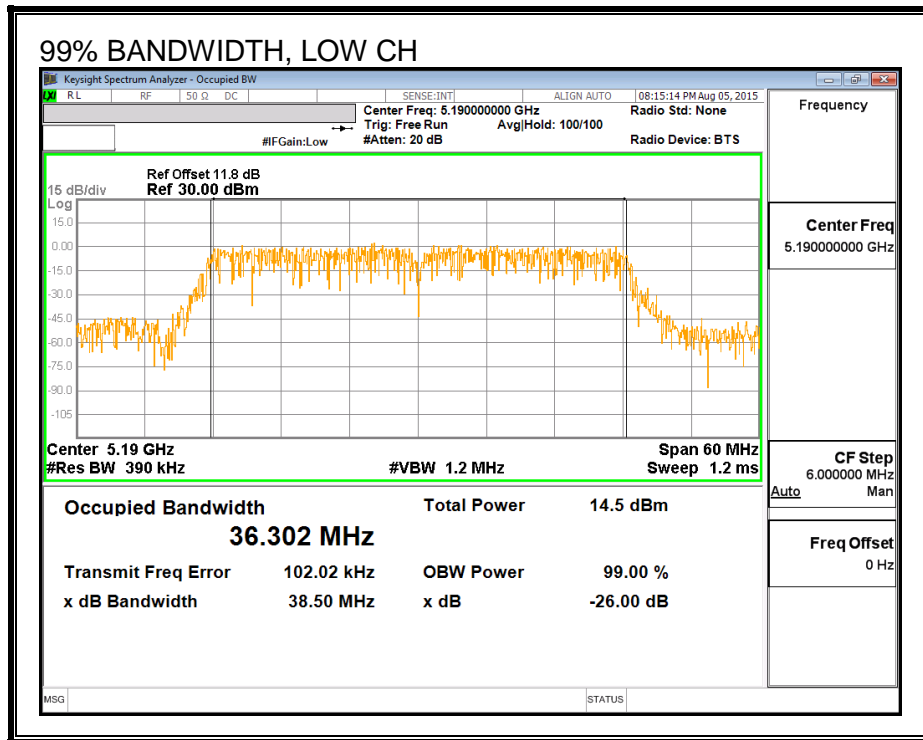

99% BANDWIDTH, Chain 1

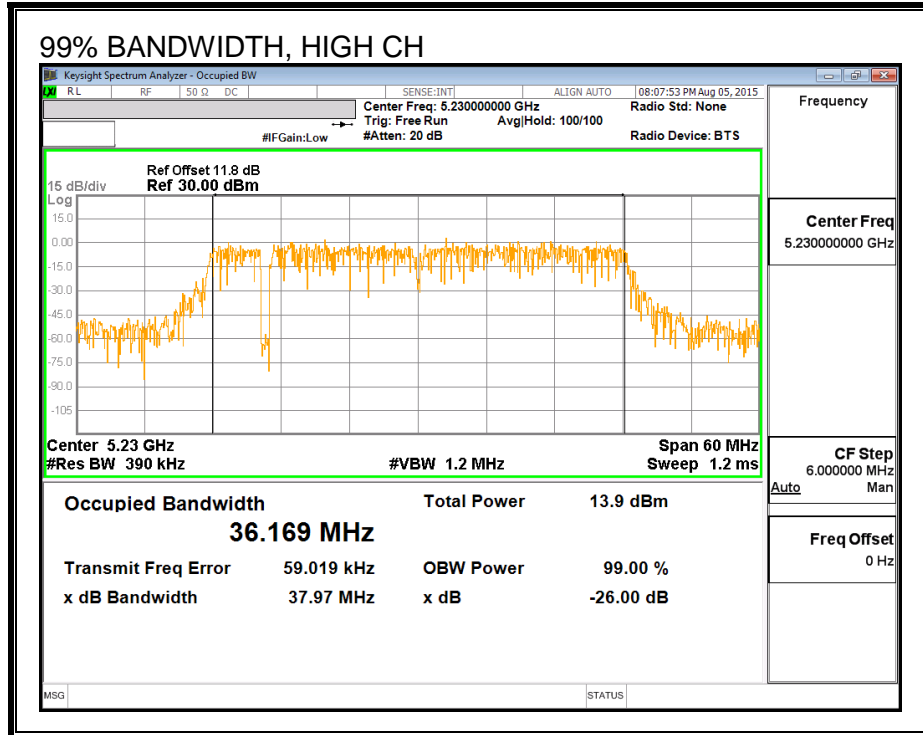
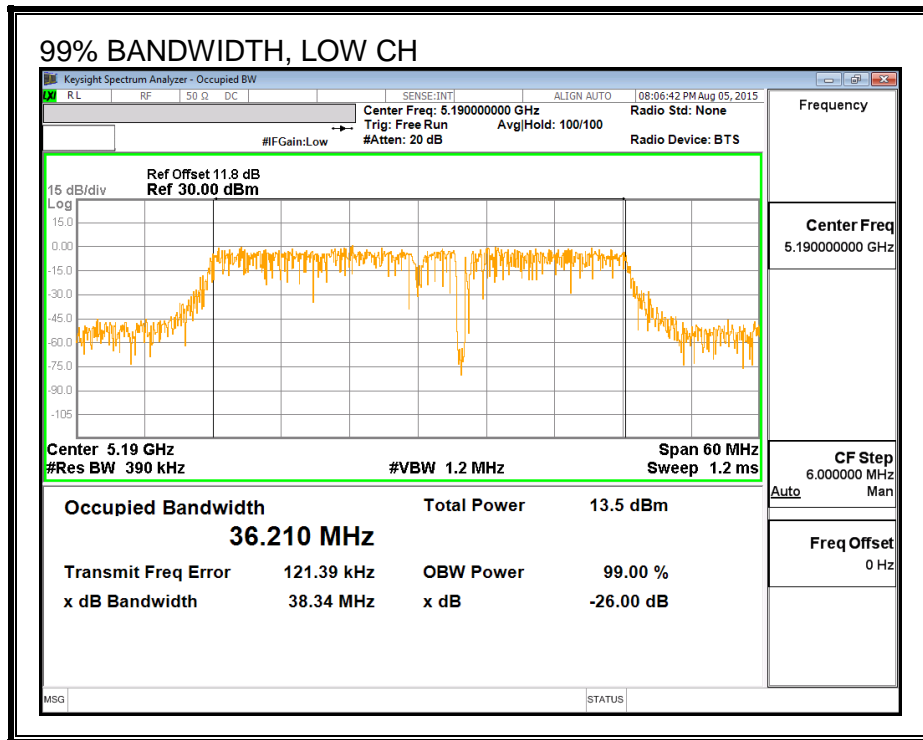

8.11.3. AVERAGE POWER

LIMITS

None; for reporting purposes only.

RESULTS

Average Power Results

Channel	Frequency (MHz)	Chain 0 Power (dBm)	Chain 1 Power (dBm)	Total Power (dBm)
Low	5190	12.98	12.95	15.98
High	5230	16.96	17.00	19.99

8.11.4. OUTPUT POWER AND PSD

LIMITS

FCC §15.407 (a) (1)

(i) For an outdoor access point operating in the band 5.15-5.25 GHz, the maximum conducted output power over the frequency band of operation shall not exceed 1 W provided the maximum antenna gain does not exceed 6 dBi. In addition, the maximum power spectral density shall not exceed 17 dBm in any 1 megahertz band. If transmitting antennas of directional gain greater than 6 dBi are used, both the maximum conducted output power and the maximum power spectral density shall be reduced by the amount in dB that the directional gain of the antenna exceeds 6 dBi. The maximum e.i.r.p. at any elevation angle above 30 degrees as measured from the horizon must not exceed 125 mW (21 dBm).

(ii) For an indoor access point operating in the band 5.15-5.25 GHz, the maximum conducted output power over the frequency band of operation shall not exceed 1 W provided the maximum antenna gain does not exceed 6 dBi. In addition, the maximum power spectral density shall not exceed 17 dBm in any 1 megahertz band. If transmitting antennas of directional gain greater than 6 dBi are used, both the maximum conducted output power and the maximum power spectral density shall be reduced by the amount in dB that the directional gain of the antenna exceeds 6 dBi.

(iii) For fixed point-to-point access points operating in the band 5.15-5.25 GHz, the maximum conducted output power over the frequency band of operation shall not exceed 1 W. Fixed point-to-point U-NII devices may employ antennas with directional gain up to 23 dBi without any corresponding reduction in the maximum conducted output power or maximum power spectral density. For fixed point-to-point transmitters that employ a directional antenna gain greater than 23 dBi, a 1 dB reduction in maximum conducted output power and maximum power spectral density is required for each 1 dB of antenna gain in excess of 23 dBi. Fixed, point-to-point operations exclude the use of point-to-multipoint systems, omnidirectional applications, and multiple collocated transmitters transmitting the same information. The operator of the U-NII device, or if the equipment is professionally installed, the installer, is responsible for ensuring that systems employing high gain directional antennas are used exclusively for fixed, point-to-point operations.

(iv) For mobile and portable client devices in the 5.15-5.25 GHz band, the maximum conducted output power over the frequency band of operation shall not exceed 250 mW provided the maximum antenna gain does not exceed 6 dBi. In addition, the maximum power spectral density shall not exceed 11 dBm in any 1 megahertz band. If transmitting antennas of directional gain greater than 6 dBi are used, both the maximum conducted output power and the maximum power spectral density shall be reduced by the amount in dB that the directional gain of the antenna exceeds 6 dBi.

DIRECTIONAL ANTENNA GAIN

The TX chains are uncorrelated and the antenna gain is unequal among the chains. The directional gain is:

Antenna Gain (dBi)	Antenna Gain (dBi)	Directional Gain (dBi)
1.90	2.30	2.10

RESULTS

Antenna Gain and Limits

Channel	Frequency (MHz)	Directional Gain for Power (dBi)	Directional Gain for PSD (dBi)	Power Limit (dBm)	PSD Limit (dBm)
Low	5190	2.10	2.10	24.00	11.00
High	5230	2.10	2.10	24.00	11.00

Duty Cycle CF (dB)	0.00	Included in Calculations of Corr'd Power & PSD
---------------------------	------	---

Output Power Results

Channel	Frequency (MHz)	Chain 0 Meas Power (dBm)	Chain 1 Meas Power (dBm)	Total Corr'd Power (dBm)	Power Limit (dBm)	Power Margin (dB)
Low	5190	12.98	12.95	15.98	24.00	-8.02
High	5230	16.96	17.00	19.99	24.00	-4.01

PSD Results

Channel	Frequency (MHz)	Chain 0 Meas PSD (dBm)	Chain 1 Meas PSD (dBm)	Total Corr'd PSD (dBm)	PSD Limit (dBm)	PSD Margin (dB)
Low	5190	-1.53	-1.51	1.49	11.00	-9.51
High	5230	2.41	2.83	5.63	11.00	-5.37

PSD, Chain 0

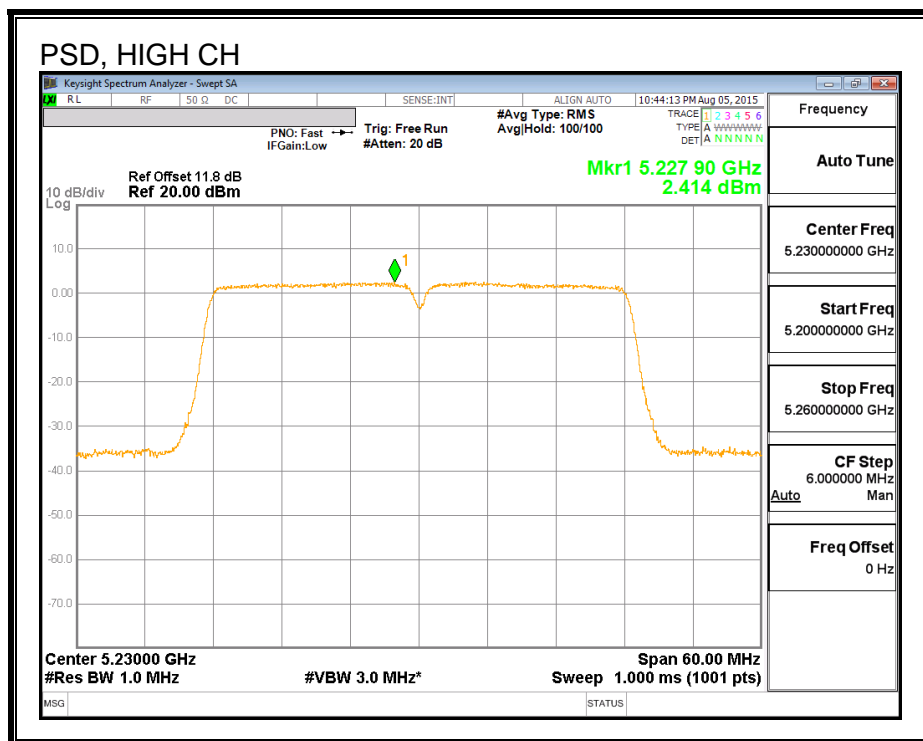
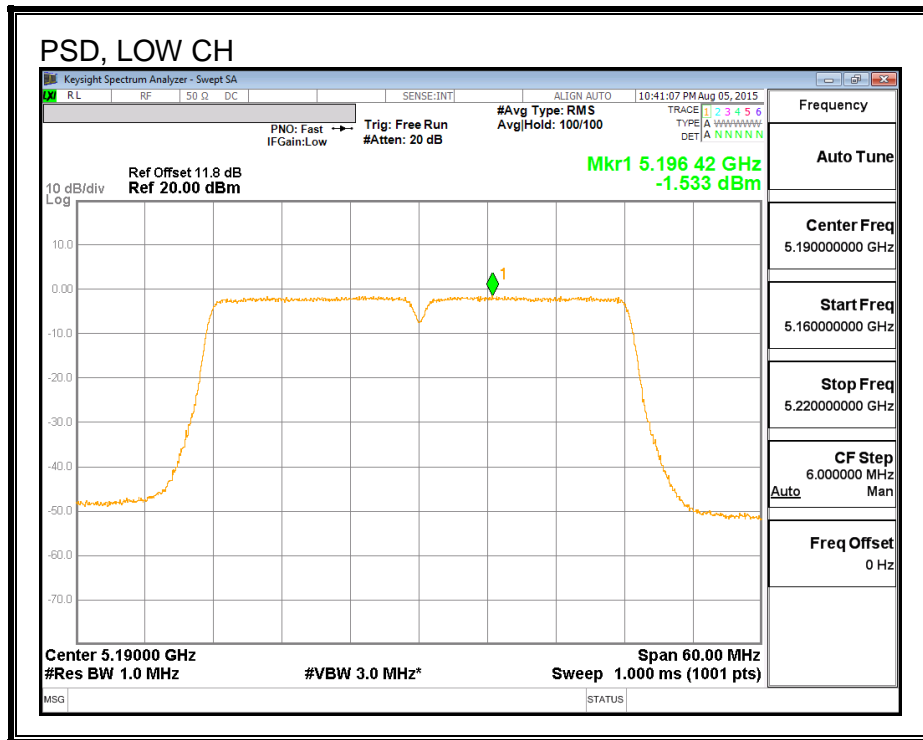

PSD, Chain 1

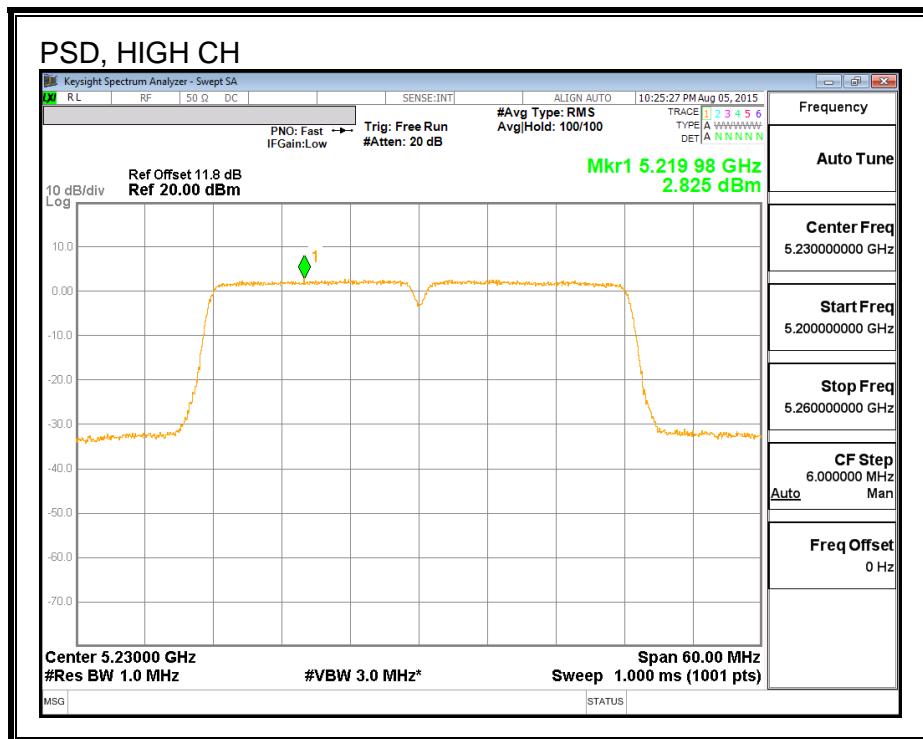
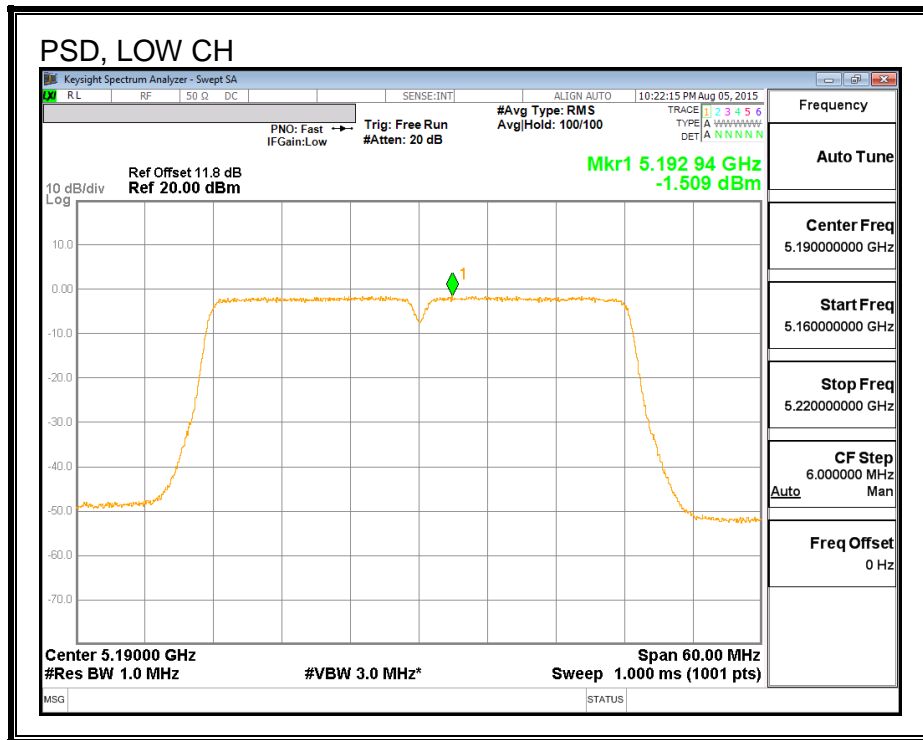

8.12. 802.11n HT40 2Tx SDM MODE IN THE 5.2 GHz BAND

Note: Covered by 802.11n HT40 2Tx STBC MODE

8.13. 802.11ac VHT80 CHAIN 0 MODE IN THE 5.2 GHz BAND

8.13.1. 26 dB BANDWIDTH

LIMITS

None; for reporting purposes only.

RESULTS

Channel	Frequency (MHz)	26 dB Bandwidth (MHz)
Mid	5210	82.28

26 dB BANDWIDTH

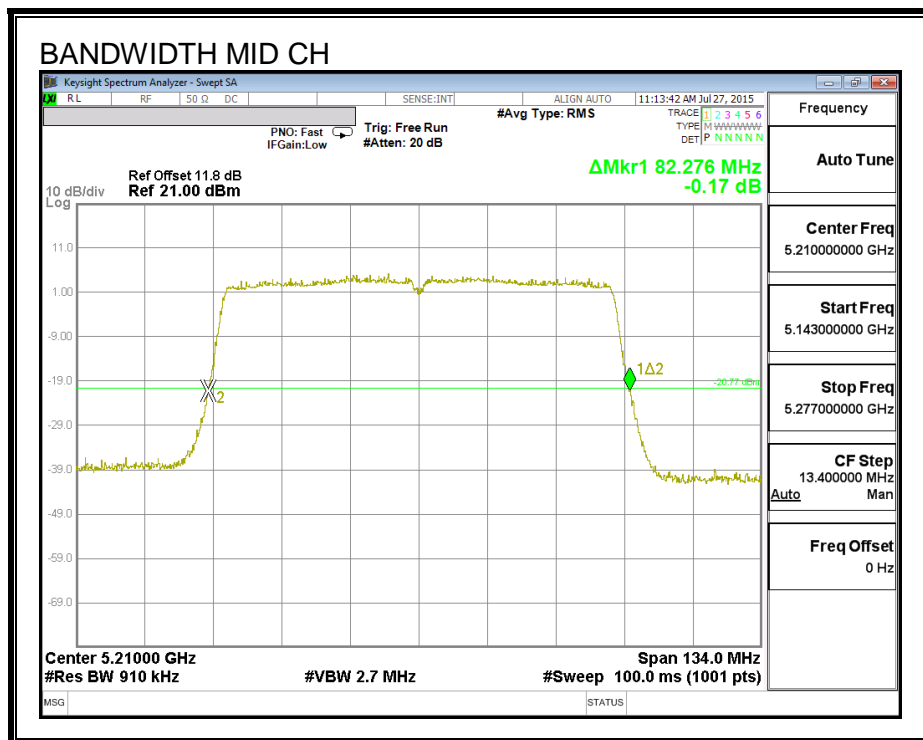

8.13.2. 99% BANDWIDTH

LIMITS

None; for reporting purposes only.

RESULTS

Channel	Frequency (MHz)	99% Bandwidth (MHz)
Mid	5210	75.657

99% BANDWIDTH

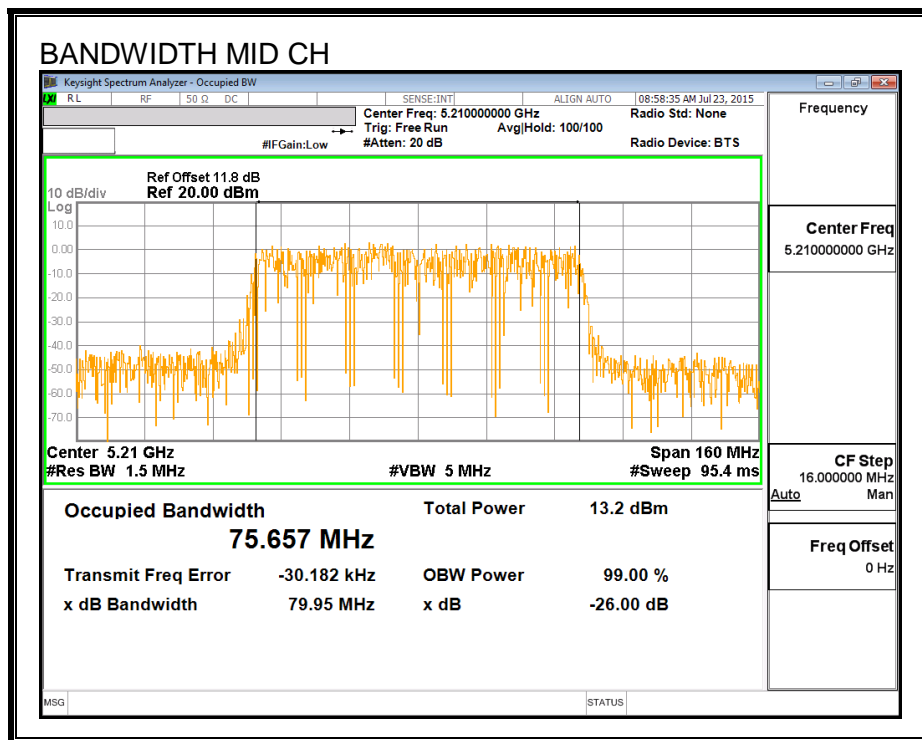

8.13.3. AVERAGE POWER

LIMITS

None; for reporting purposes only.

RESULTS

Channel	Frequency (MHz)	Power (dBm)
Mid	5210	12.83

8.13.4. OUTPUT POWER AND PSD

LIMITS

FCC §15.407 (a) (1)

(i) For an outdoor access point operating in the band 5.15-5.25 GHz, the maximum conducted output power over the frequency band of operation shall not exceed 1 W provided the maximum antenna gain does not exceed 6 dBi. In addition, the maximum power spectral density shall not exceed 17 dBm in any 1 megahertz band. If transmitting antennas of directional gain greater than 6 dBi are used, both the maximum conducted output power and the maximum power spectral density shall be reduced by the amount in dB that the directional gain of the antenna exceeds 6 dBi. The maximum e.i.r.p. at any elevation angle above 30 degrees as measured from the horizon must not exceed 125 mW (21 dBm).

(ii) For an indoor access point operating in the band 5.15-5.25 GHz, the maximum conducted output power over the frequency band of operation shall not exceed 1 W provided the maximum antenna gain does not exceed 6 dBi. In addition, the maximum power spectral density shall not exceed 17 dBm in any 1 megahertz band. If transmitting antennas of directional gain greater than 6 dBi are used, both the maximum conducted output power and the maximum power spectral density shall be reduced by the amount in dB that the directional gain of the antenna exceeds 6 dBi.

(iii) For fixed point-to-point access points operating in the band 5.15-5.25 GHz, the maximum conducted output power over the frequency band of operation shall not exceed 1 W. Fixed point-to-point U-NII devices may employ antennas with directional gain up to 23 dBi without any corresponding reduction in the maximum conducted output power or maximum power spectral density. For fixed point-to-point transmitters that employ a directional antenna gain greater than 23 dBi, a 1 dB reduction in maximum conducted output power and maximum power spectral density is required for each 1 dB of antenna gain in excess of 23 dBi. Fixed, point-to-point operations exclude the use of point-to-multipoint systems, omnidirectional applications, and multiple collocated transmitters transmitting the same information. The operator of the U-NII device, or if the equipment is professionally installed, the installer, is responsible for ensuring that systems employing high gain directional antennas are used exclusively for fixed, point-to-point operations.

(iv) For mobile and portable client devices in the 5.15-5.25 GHz band, the maximum conducted output power over the frequency band of operation shall not exceed 250 mW provided the maximum antenna gain does not exceed 6 dBi. In addition, the maximum power spectral density shall not exceed 11 dBm in any 1 megahertz band. If transmitting antennas of directional gain greater than 6 dBi are used, both the maximum conducted output power and the maximum power spectral density shall be reduced by the amount in dB that the directional gain of the antenna exceeds 6 dBi.

DIRECTIONAL ANTENNA GAIN

There is only one transmitter output therefore the directional gain is equal to the antenna gain.

RESULTS

Antenna Gain and Limits

Channel	Frequency (MHz)	Directional Gain for Power (dBi)	Directional Gain for PSD (dBi)	Power Limit (dBm)	PSD Limit (dBm)
Mid	5210	1.90	1.90	24.00	11.00

Duty Cycle CF (dB)	0.19	Included in Calculations of Corr'd Power & PSD
---------------------------	------	---

Output Power Results

Channel	Frequency (MHz)	Meas Power (dBm)	Total Corr'd Power (dBm)	Power Limit (dBm)	Power Margin (dB)
Mid	5210	12.64	12.83	24.00	-11.17

PSD Results

Channel	Frequency (MHz)	Meas PSD (dBm)	Total Corr'd PSD (dBm)	PSD Limit (dBm)	PSD Margin (dB)
Mid	5210	-4.61	-4.42	11.00	-15.42

8.14. 802.11ac VHT80 CHAIN 1 MODE IN THE 5.2 GHZ BAND

8.14.1. 26 dB BANDWIDTH

LIMITS

None; for reporting purposes only.

RESULTS

Channel	Frequency (MHz)	26 dB Bandwidth (MHz)
Mid	5210	82.142

26 dB BANDWIDTH

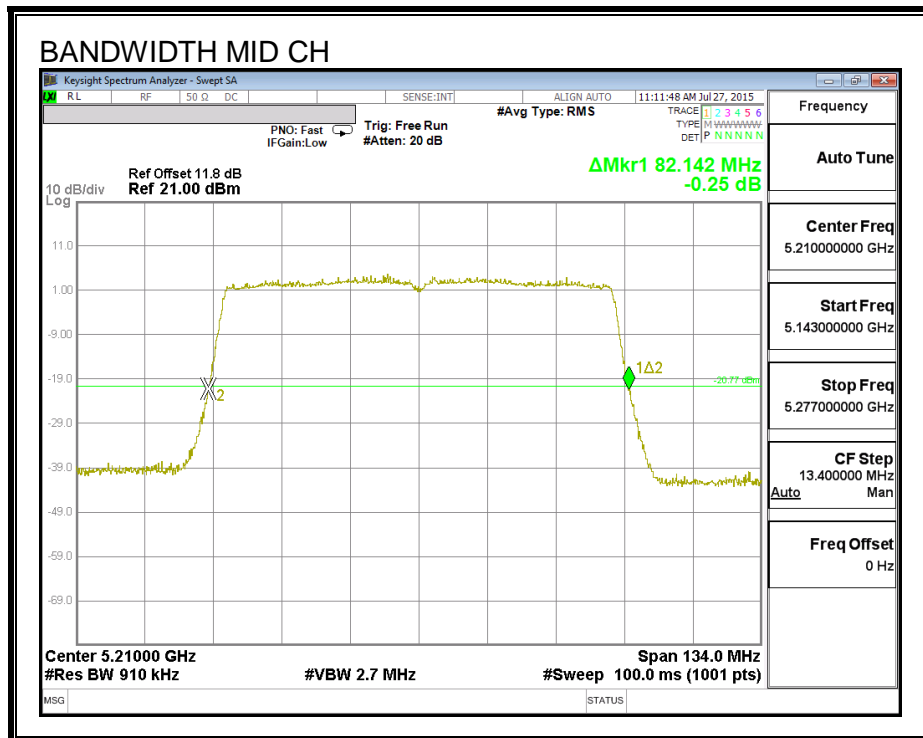

8.14.2. 99% BANDWIDTH

LIMITS

None; for reporting purposes only.

RESULTS

Channel	Frequency (MHz)	99% Bandwidth (MHz)
Mid	5210	75.673

99% BANDWIDTH

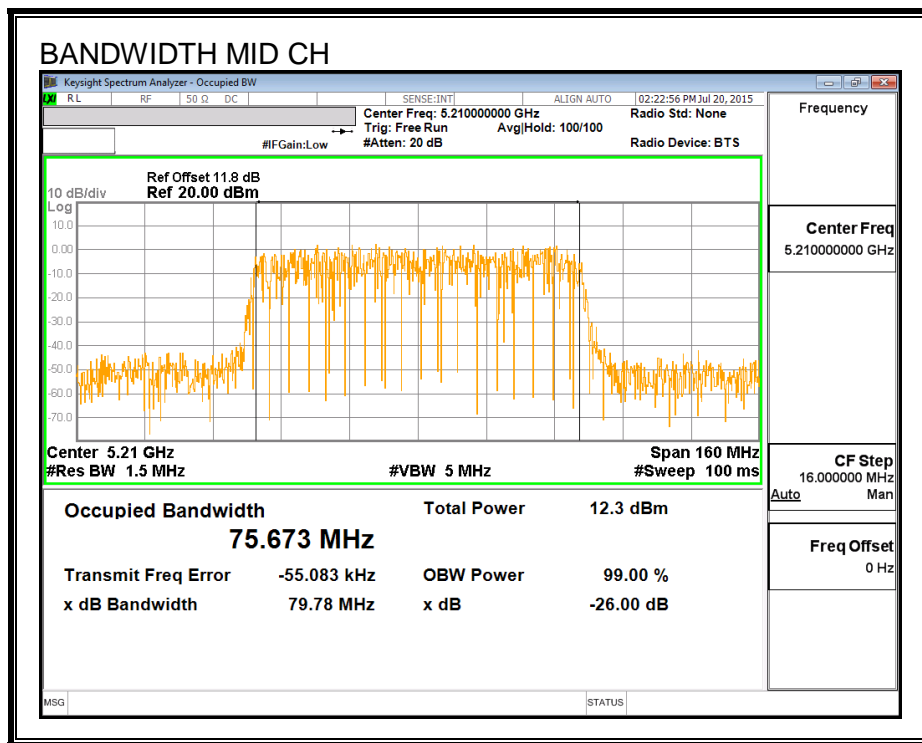

8.14.3. AVERAGE POWER

LIMITS

None; for reporting purposes only.

RESULTS

Channel	Frequency (MHz)	Power (dBm)
Mid	5210	13.00

8.14.4. OUTPUT POWER AND PSD

LIMITS

FCC §15.407 (a) (1)

(i) For an outdoor access point operating in the band 5.15-5.25 GHz, the maximum conducted output power over the frequency band of operation shall not exceed 1 W provided the maximum antenna gain does not exceed 6 dBi. In addition, the maximum power spectral density shall not exceed 17 dBm in any 1 megahertz band. If transmitting antennas of directional gain greater than 6 dBi are used, both the maximum conducted output power and the maximum power spectral density shall be reduced by the amount in dB that the directional gain of the antenna exceeds 6 dBi. The maximum e.i.r.p. at any elevation angle above 30 degrees as measured from the horizon must not exceed 125 mW (21 dBm).

(ii) For an indoor access point operating in the band 5.15-5.25 GHz, the maximum conducted output power over the frequency band of operation shall not exceed 1 W provided the maximum antenna gain does not exceed 6 dBi. In addition, the maximum power spectral density shall not exceed 17 dBm in any 1 megahertz band. If transmitting antennas of directional gain greater than 6 dBi are used, both the maximum conducted output power and the maximum power spectral density shall be reduced by the amount in dB that the directional gain of the antenna exceeds 6 dBi.

(iii) For fixed point-to-point access points operating in the band 5.15-5.25 GHz, the maximum conducted output power over the frequency band of operation shall not exceed 1 W. Fixed point-to-point U-NII devices may employ antennas with directional gain up to 23 dBi without any corresponding reduction in the maximum conducted output power or maximum power spectral density. For fixed point-to-point transmitters that employ a directional antenna gain greater than 23 dBi, a 1 dB reduction in maximum conducted output power and maximum power spectral density is required for each 1 dB of antenna gain in excess of 23 dBi. Fixed, point-to-point operations exclude the use of point-to-multipoint systems, omnidirectional applications, and multiple collocated transmitters transmitting the same information. The operator of the U-NII device, or if the equipment is professionally installed, the installer, is responsible for ensuring that systems employing high gain directional antennas are used exclusively for fixed, point-to-point operations.

(iv) For mobile and portable client devices in the 5.15-5.25 GHz band, the maximum conducted output power over the frequency band of operation shall not exceed 250 mW provided the maximum antenna gain does not exceed 6 dBi. In addition, the maximum power spectral density shall not exceed 11 dBm in any 1 megahertz band. If transmitting antennas of directional gain greater than 6 dBi are used, both the maximum conducted output power and the maximum power spectral density shall be reduced by the amount in dB that the directional gain of the antenna exceeds 6 dBi.

DIRECTIONAL ANTENNA GAIN

There is only one transmitter output therefore the directional gain is equal to the antenna gain.

RESULTS

Antenna Gain and Limits

Channel	Frequency (MHz)	Directional Gain for Power (dBi)	Directional Gain for PSD (dBi)	Power Limit (dBm)	PSD Limit (dBm)
Mid	5210	2.30	2.30	24.00	11.00

Duty Cycle CF (dB)	0.19	Included in Calculations of Corr'd Power & PSD
---------------------------	------	---

Output Power Results

Channel	Frequency (MHz)	Meas Power (dBm)	Total Corr'd Power (dBm)	Power Limit (dBm)	Power Margin (dB)
Mid	5210	12.81	13.00	24.00	-11.00

PSD Results

Channel	Frequency (MHz)	Meas PSD (dBm)	Total Corr'd PSD (dBm)	PSD Limit (dBm)	PSD Margin (dB)
Mid	5210	-4.14	-3.95	11.00	-14.95

PSD

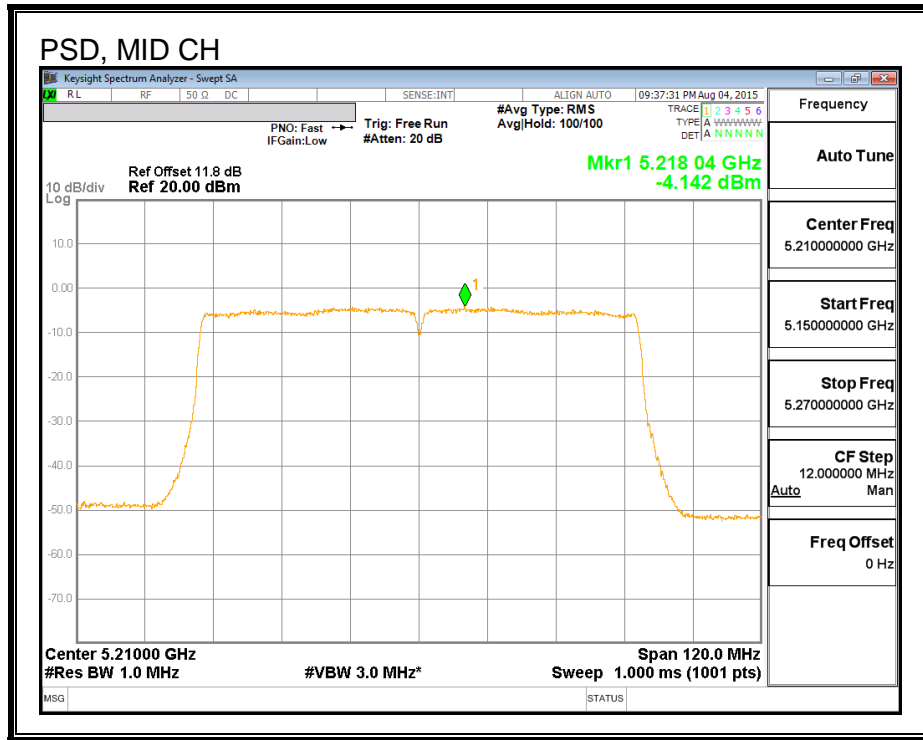

8.15. 802.11ac VHT80 2Tx CDD MODE IN THE 5.2 GHz BAND

8.15.1. 26 dB BANDWIDTH

LIMITS

None; for reporting purposes only.

RESULTS

Channel	Frequency (MHz)	26 dB BW Chain 0 (MHz)	26 dB BW Chain 1 (MHz)
Mid	5210	82.28	82.01

26 DB BANDWIDTH, CHAIN 0

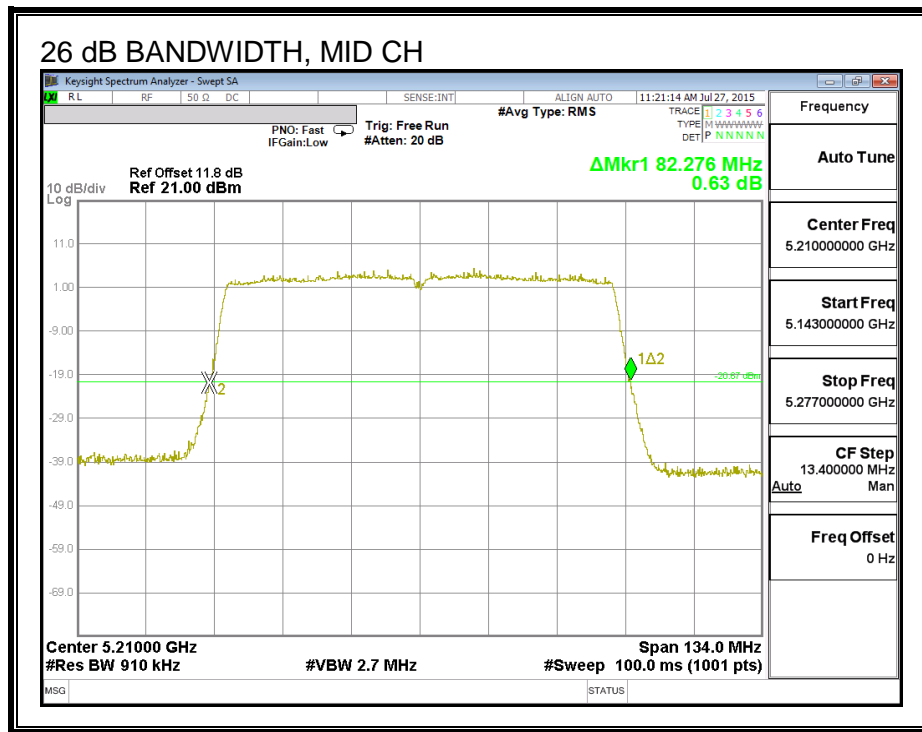

26 DB BANDWIDTH, CHAIN 1

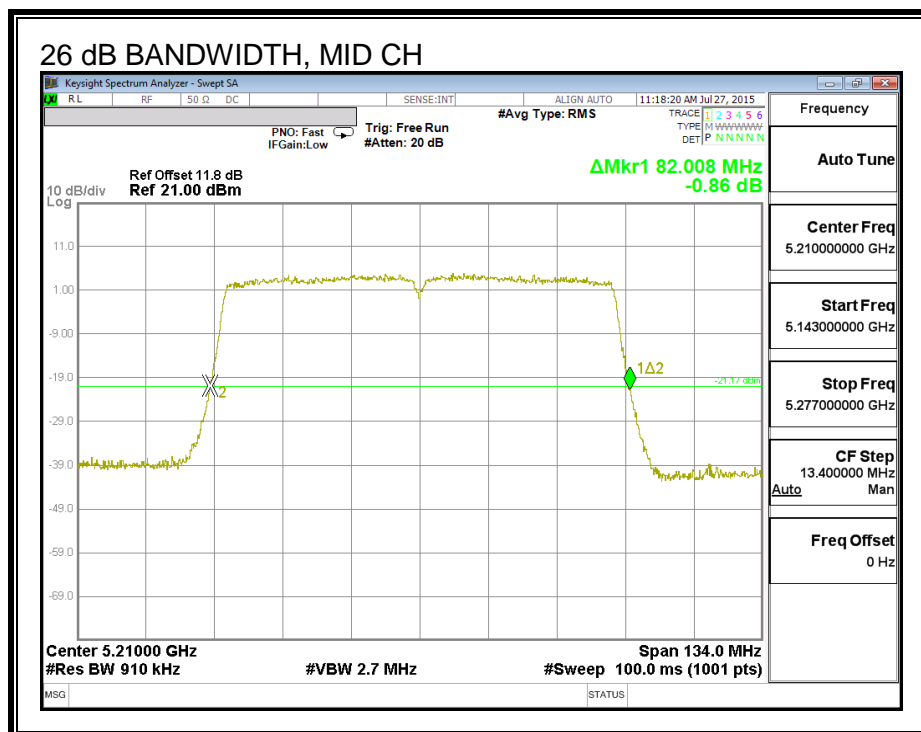

8.15.2. 99% BANDWIDTH

LIMITS

None; for reporting purposes only.

RESULTS

Channel	Frequency (MHz)	99% BW Chain 0 (MHz)	99% BW Chain 1 (MHz)
Mid	5210	75.905	75.532

99% BANDWIDTH, CHAIN 0

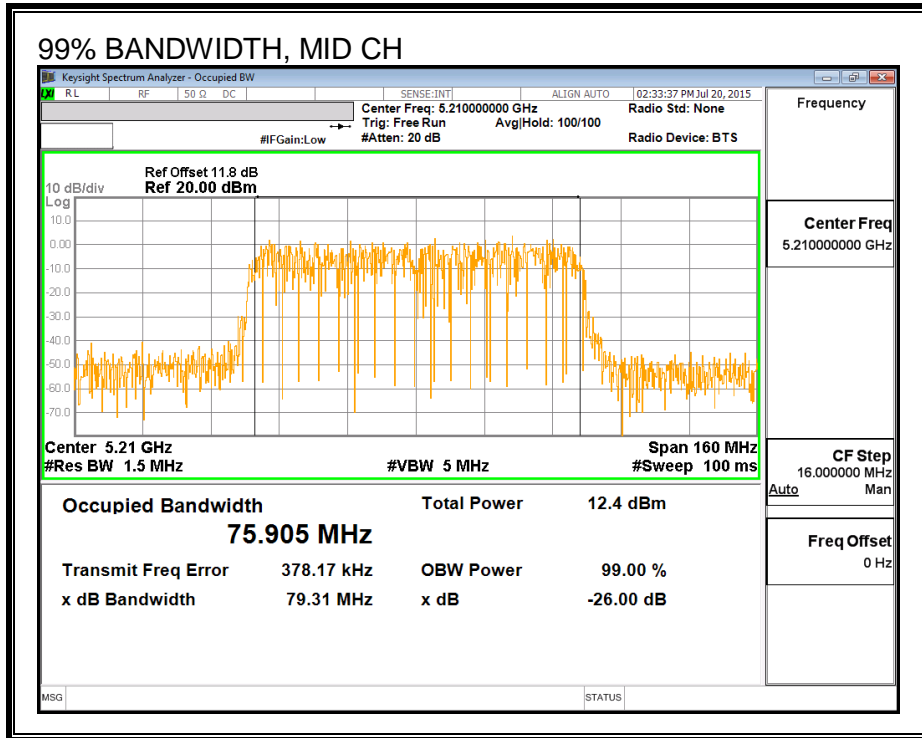

99% BANDWIDTH, CHAIN 1

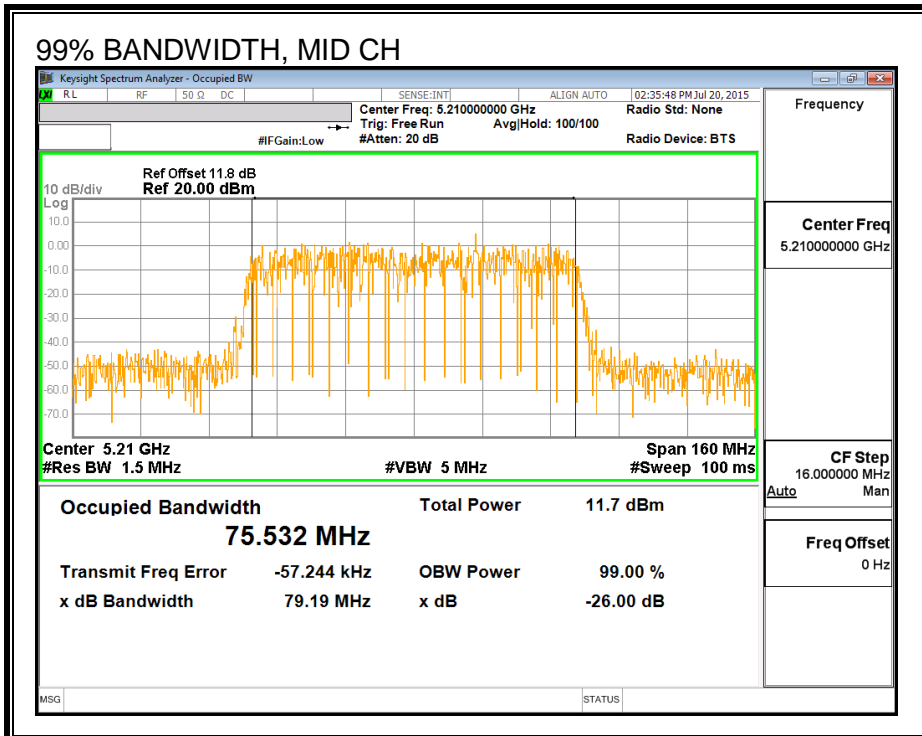

8.15.3. AVERAGE POWER

LIMITS

None; for reporting purposes only.

RESULTS

Average Power Results

Channel	Frequency (MHz)	Chain 0 Power (dBm)	Chain 1 Power (dBm)	Total Power (dBm)
Mid	5210	12.47	12.36	15.43

8.15.4. OUTPUT POWER AND PSD

LIMITS

FCC §15.407 (a) (1)

(i) For an outdoor access point operating in the band 5.15-5.25 GHz, the maximum conducted output power over the frequency band of operation shall not exceed 1 W provided the maximum antenna gain does not exceed 6 dBi. In addition, the maximum power spectral density shall not exceed 17 dBm in any 1 megahertz band. If transmitting antennas of directional gain greater than 6 dBi are used, both the maximum conducted output power and the maximum power spectral density shall be reduced by the amount in dB that the directional gain of the antenna exceeds 6 dBi. The maximum e.i.r.p. at any elevation angle above 30 degrees as measured from the horizon must not exceed 125 mW (21 dBm).

(ii) For an indoor access point operating in the band 5.15-5.25 GHz, the maximum conducted output power over the frequency band of operation shall not exceed 1 W provided the maximum antenna gain does not exceed 6 dBi. In addition, the maximum power spectral density shall not exceed 17 dBm in any 1 megahertz band. If transmitting antennas of directional gain greater than 6 dBi are used, both the maximum conducted output power and the maximum power spectral density shall be reduced by the amount in dB that the directional gain of the antenna exceeds 6 dBi.

(iii) For fixed point-to-point access points operating in the band 5.15-5.25 GHz, the maximum conducted output power over the frequency band of operation shall not exceed 1 W. Fixed point-to-point U-NII devices may employ antennas with directional gain up to 23 dBi without any corresponding reduction in the maximum conducted output power or maximum power spectral density. For fixed point-to-point transmitters that employ a directional antenna gain greater than 23 dBi, a 1 dB reduction in maximum conducted output power and maximum power spectral density is required for each 1 dB of antenna gain in excess of 23 dBi. Fixed, point-to-point operations exclude the use of point-to-multipoint systems, omnidirectional applications, and multiple collocated transmitters transmitting the same information. The operator of the U-NII device, or if the equipment is professionally installed, the installer, is responsible for ensuring that systems employing high gain directional antennas are used exclusively for fixed, point-to-point operations.

(iv) For mobile and portable client devices in the 5.15-5.25 GHz band, the maximum conducted output power over the frequency band of operation shall not exceed 250 mW provided the maximum antenna gain does not exceed 6 dBi. In addition, the maximum power spectral density shall not exceed 11 dBm in any 1 megahertz band. If transmitting antennas of directional gain greater than 6 dBi are used, both the maximum conducted output power and the maximum power spectral density shall be reduced by the amount in dB that the directional gain of the antenna exceeds 6 dBi.

DIRECTIONAL ANTENNA GAIN

The TX chains are uncorrelated and the antenna gain is unequal among the chains. The directional gain is:

Antenna Gain (dBi)	Antenna Gain (dBi)	Directional Gain (dBi)
1.90	2.30	2.10

The TX chains are correlated and the antenna gain is unequal among the chains. The directional gain is:

Antenna Gain (dBi)	Antenna Gain (dBi)	Directional Gain (dBi)
1.90	2.30	5.11

RESULTS

Antenna Gain and Limits

Channel	Frequency (MHz)	Directional Gain for Power (dBi)	Directional Gain for PSD (dBi)	Power Limit (dBm)	PSD Limit (dBm)
Mid	5210	2.10	5.11	24.00	11.00

Duty Cycle CF (dB)	0.22	Included in Calculations of Corr'd Power & PSD
---------------------------	------	---

Output Power Results

Channel	Frequency (MHz)	Chain 0 Meas Power (dBm)	Chain 1 Meas Power (dBm)	Total Corr'd Power (dBm)	Power Limit (dBm)	Power Margin (dB)
Mid	5210	12.25	12.14	15.43	24.00	-8.57

PSD Results

Channel	Frequency (MHz)	Chain 0 Meas PSD (dBm)	Chain 1 Meas PSD (dBm)	Total Corr'd PSD (dBm)	PSD Limit (dBm)	PSD Margin (dB)
Mid	5210	-4.11	-4.36	-1.00	11.00	-12.00

PSD, Chain 0

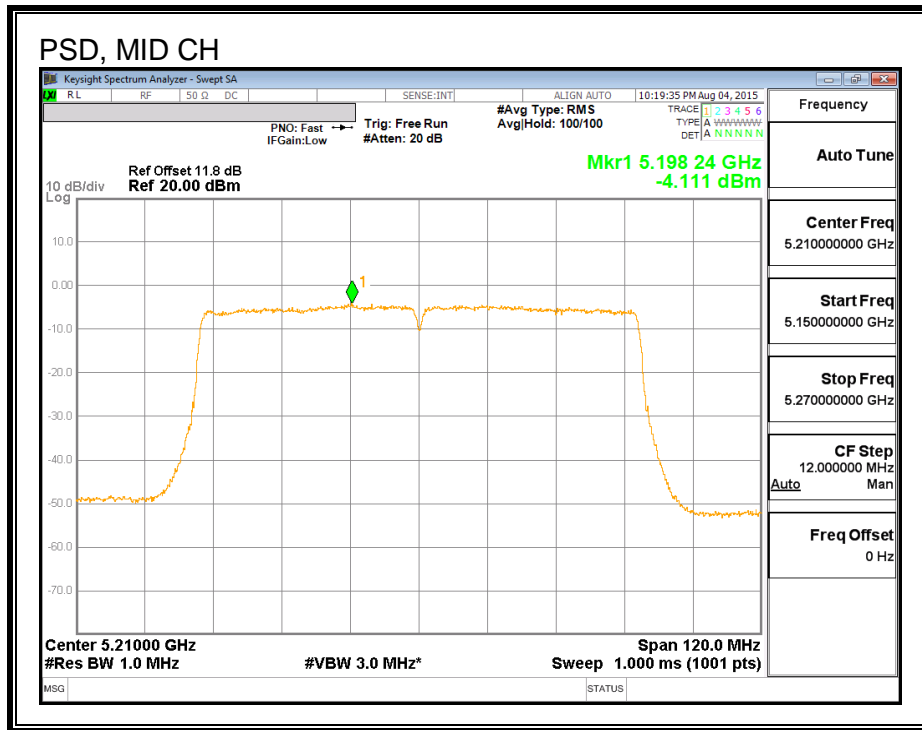

PSD, Chain 1

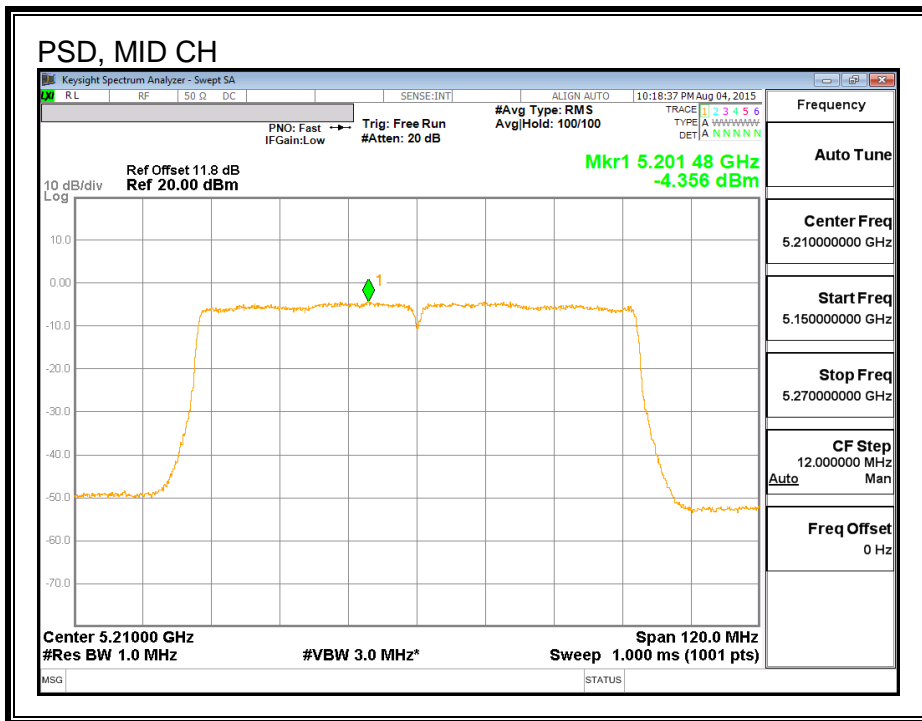

8.16. 802.11ac VHT80 2Tx STBC/SDM MODE IN THE 5.2 GHz BAND

Note: Covered by 802.11ac VHT80 2Tx CDD MODE