



**FCC 47 CFR PART 15 SUBPART C
INDUSTRY CANADA RSS-247 ISSUE 1**

CERTIFICATION TEST REPORT

FOR

TABLET DEVICE

MODEL NUMBER: A1584

FCC ID: BCGA1584

IC: 579C-A1584

REPORT NUMBER: 14U19185-E3V3

ISSUE DATE: SEPTEMBER 11, 2015

Prepared for

APPLE, INC.

1 INFINITE LOOP

CUPERTINO, CA 95014, U.S.A.

Prepared by

UL VERIFICATION SERVICES INC.

47173 BENICIA STREET

FREMONT, CA 94538, U.S.A.

TEL: (510) 771-1000

FAX: (510) 661-0888



NVLAP LAB CODE 200065-0

Revision History

<u>Rev.</u>	<u>Issue Date</u>	<u>Revisions</u>	<u>Revised By</u>
V1	09/03/2015	Initial Issue	M. Mekuria
V2	09/08/2015	Addressed TCB Questions	E. Yu
V3	09/11/2015	Updated antenna gain	C. Pang

TABLE OF CONTENTS

1. ATTESTATION OF TEST RESULTS	5
2. TEST METHODOLOGY	6
3. FACILITIES AND ACCREDITATION	6
4. CALIBRATION AND UNCERTAINTY	6
4.1. <i>MEASURING INSTRUMENT CALIBRATION</i>	<i>6</i>
4.2. <i>SAMPLE CALCULATION</i>	<i>6</i>
4.3. <i>MEASUREMENT UNCERTAINTY.....</i>	<i>7</i>
5. EQUIPMENT UNDER TEST	8
5.1. <i>DESCRIPTION OF EUT</i>	<i>8</i>
5.2. <i>MAXIMUM OUTPUT POWER.....</i>	<i>8</i>
5.3. <i>DESCRIPTION OF AVAILABLE ANTENNAS</i>	<i>8</i>
5.4. <i>SOFTWARE AND FIRMWARE.....</i>	<i>8</i>
5.5. <i>WORST-CASE CONFIGURATION AND MODE.....</i>	<i>9</i>
5.6. <i>DESCRIPTION OF TEST SETUP.....</i>	<i>10</i>
6. TEST AND MEASUREMENT EQUIPMENT	17
7. MEASUREMENT METHODS	18
8. ANTENNA PORT TEST RESULTS	19
8.1. <i>ON TIME AND DUTY CYCLE.....</i>	<i>19</i>
8.2. <i>802.11b SISO MODE IN THE 2.4 GHz BAND</i>	<i>23</i>
8.2.1. <i>6 dB BANDWIDTH.....</i>	<i>23</i>
8.2.2. <i>99% BANDWIDTH.....</i>	<i>29</i>
8.2.3. <i>AVERAGE POWER</i>	<i>35</i>
8.2.4. <i>OUTPUT POWER</i>	<i>36</i>
8.2.5. <i>POWER SPECTRAL DENSITY</i>	<i>39</i>
8.2.6. <i>OUT-OF-BAND EMISSIONS</i>	<i>45</i>
8.3. <i>802.11g SISO MODE IN THE 2.4 GHz BAND</i>	<i>58</i>
8.4. <i>802.11g 2TX MODE IN THE 2.4 GHz BAND</i>	<i>58</i>
8.5. <i>802.11n HT20 SISO MODE IN THE 2.4 GHz BAND.....</i>	<i>59</i>
8.5.1. <i>6 dB BANDWIDTH.....</i>	<i>59</i>
8.5.2. <i>99% BANDWIDTH.....</i>	<i>65</i>
8.5.3. <i>AVERAGE POWER</i>	<i>71</i>
8.5.4. <i>OUTPUT POWER</i>	<i>72</i>
8.5.5. <i>POWER SPECTRAL DENSITY</i>	<i>75</i>
8.5.6. <i>OUT-OF-BAND EMISSIONS</i>	<i>81</i>
8.6. <i>802.11n HT20 2TX CDD MODE IN THE 2.4 GHz BAND</i>	<i>94</i>
8.6.1. <i>6 dB BANDWIDTH.....</i>	<i>94</i>

8.6.2.	99% BANDWIDTH.....	103
8.6.3.	AVERAGE POWER.....	112
8.6.4.	OUTPUT POWER.....	113
8.6.5.	POWER SPECTRAL DENSITY.....	115
8.6.6.	OUT-OF-BAND EMISSIONS.....	124
9.	RADIATED TEST RESULTS.....	141
9.1.	<i>LIMITS AND PROCEDURE.....</i>	<i>141</i>
9.2.	<i>TRANSMITTER ABOVE 1 GHz.....</i>	<i>142</i>
9.2.1.	802.11b 1Tx MODE IN THE 2.4 GHz BAND CHAIN 0.....	142
9.2.2.	802.11b 1Tx MODE IN THE 2.4 GHz BAND CHAIN 1.....	156
9.2.3.	802.11n HT20 1Tx MODE IN THE 2.4 GHz BAND CHAIN 0.....	170
9.2.4.	802.11n HT20 1Tx MODE IN THE 2.4 GHz BAND CHAIN 1.....	184
9.2.5.	802.11n HT20 2TX MODE IN THE 2.4 GHz BAND.....	198
9.3.	<i>WORST-CASE BELOW 1 GHz.....</i>	<i>216</i>
9.4.	<i>WORST-CASE 18 to 26 GHz.....</i>	<i>218</i>
10.	AC POWER LINE CONDUCTED EMISSIONS.....	220
10.1.	<i>EUT POWERED BY AC/DC ADAPTER VIA USB CABLE.....</i>	<i>221</i>
10.2.	<i>EUT POWERED BY HOST PC VIA USB CABLE.....</i>	<i>223</i>
11.	SETUP PHOTOS.....	225

1. ATTESTATION OF TEST RESULTS

COMPANY NAME: APPLE, INC.
1 INFINITE LOOP
CUPERTINO, CA 95014, U.S.A.

EUT DESCRIPTION: TABLET DEVICE

MODEL: A1584

SERIAL NUMBER: DLXQ1008GPCP (Radiated); DLXQ1005GPCP (Conducted)

DATE TESTED: JULY 10, 2015 - AUGUST 07, 2015

APPLICABLE STANDARDS	
STANDARD	TEST RESULTS
CFR 47 Part 15 Subpart C	Pass

UL Verification Services Inc. tested the above equipment in accordance with the requirements set forth in the above standards. All indications of Pass/Fail in this report are opinions expressed by UL Verification Services Inc. based on interpretations and/or observations of test results. Measurement Uncertainties were not taken into account and are published for informational purposes only. The test results show that the equipment tested is capable of demonstrating compliance with the requirements as documented in this report.

Note: The results documented in this report apply only to the tested sample, under the conditions and modes of operation as described herein. This document may not be altered or revised in any way unless done so by UL Verification Services Inc. and all revisions are duly noted in the revisions section. Any alteration of this document not carried out by UL Verification Services Inc. will constitute fraud and shall nullify the document. This report must not be used by the client to claim product certification, approval, or endorsement by NVLAP, NIST, any agency of the Federal Government, or any agency of any government.

Approved & Released For
UL Verification Services Inc. By:

Tested By:

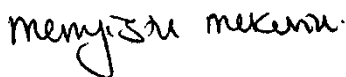

MENGISTU MEKURIA
PROJECT LEADER
UL VERIFICATION SERVICES INC.

FRANCISCO GUARNERO
EMC LAB ENGINEER
UL VERIFICATION SERVICES INC.

2. TEST METHODOLOGY

The tests documented in this report were performed in accordance with FCC CFR 47 Part 2, FCC CFR 47 Part 15, ANSI C63.10-2013, RSS-GEN Issue 4, and RSS-247 Issue 1.

3. FACILITIES AND ACCREDITATION

The test sites and measurement facilities used to collect data are located at 47173 and 47266 Benicia Street, Fremont, California, USA. Line conducted emissions are measured only at the 47173 address. The following table identifies which facilities were utilized for radiated emission measurements documented in this report. Specific facilities are also identified in the test results sections.

47173 Benicia Street	47266 Benicia Street
<input type="checkbox"/> Chamber A	<input checked="" type="checkbox"/> Chamber D
<input type="checkbox"/> Chamber B	<input checked="" type="checkbox"/> Chamber E
<input type="checkbox"/> Chamber C	<input type="checkbox"/> Chamber F
	<input checked="" type="checkbox"/> Chamber G
	<input type="checkbox"/> Chamber H

The above test sites and facilities are covered under FCC Test Firm Registration # 208313. Chambers A through H are covered under Industry Canada company address code 2324B with site numbers 2324B -1 through 2324B-8, respectively.

UL Verification Services Inc. is accredited by NVLAP, Laboratory Code 200065-0. The full scope of accreditation can be viewed at <http://ts.nist.gov/standards/scopes/2000650.htm>.

4. CALIBRATION AND UNCERTAINTY

4.1. MEASURING INSTRUMENT CALIBRATION

The measuring equipment utilized to perform the tests documented in this report has been calibrated in accordance with the manufacturer's recommendations, and is traceable to recognized national standards.

4.2. SAMPLE CALCULATION

Where relevant, the following sample calculation is provided:

$$\begin{aligned} \text{Field Strength (dBuV/m)} &= \text{Measured Voltage (dBuV)} + \text{Antenna Factor (dB/m)} + \\ &\text{Cable Loss (dB)} - \text{Preamp Gain (dB)} \\ 36.5 \text{ dBuV} + 18.7 \text{ dB/m} + 0.6 \text{ dB} - 26.9 \text{ dB} &= 28.9 \text{ dBuV/m} \end{aligned}$$

4.3. MEASUREMENT UNCERTAINTY

Where relevant, the following measurement uncertainty levels have been estimated for tests performed on the apparatus:

PARAMETER	UNCERTAINTY
Conducted Disturbance, 0.15 to 30 MHz	± 3.52 dB
Radiated Disturbance, 30 to 1000 MHz	± 4.94 dB
Radiated Disturbance, 1 to 6 GHz	± 3.86 dB
Radiated Disturbance, 6 to 18 GHz	± 4.23 dB
Radiated Disturbance, 18 to 26 GHz	± 5.30 dB
Radiated Disturbance, 26 to 40 GHz	± 5.23 dB

Uncertainty figures are valid to a confidence level of 95%.

5. EQUIPMENT UNDER TEST

5.1. DESCRIPTION OF EUT

The EUT is a tablet with multimedia functions (music, application support, and video), IEEE 802.11a/b/g/n/ac radio, and Bluetooth radio. The rechargeable battery is not user accessible.

5.2. MAXIMUM OUTPUT POWER

The transmitter has a maximum conducted output power as follows:

Frequency Range (MHz)	Mode	Output Power (dBm)	Output Power (mW)
2412 - 2472	802.11b 1TX	18.97	78.89
2412 - 2472	802.11g 1TX	Covered by 11n HT20 1TX	
2412 - 2472	802.11g 2TX	Covered by 11n HT20 2TX	
2412 - 2472	802.11n HT20 1TX	23.19	208.45
2412 - 2472	802.11n HT20 2TX	26.22	418.79

5.3. DESCRIPTION OF AVAILABLE ANTENNAS

Frequency Band (GHz)	Antenna Gain	
	Antenna 1	Antenna 2
2.4	-0.60	-0.50

5.4. SOFTWARE AND FIRMWARE

The software installed in the EUT during testing was 13B72.

5.5. WORST-CASE CONFIGURATION AND MODE

Radiated emission and power line conducted emission were performed with the EUT set to transmit at the channel with highest output power as worst-case scenario.

The fundamental of the EUT was investigated in three orthogonal orientations X/Y/Z, it was determined that Y (Landscape) orientation was worst-case orientation. Therefore, all final radiated testing was performed with the EUT in Y orientation.

Worst-case data rates as provided by the client were:

802.11b mode: 1 Mbps
802.11g mode: 6 Mbps
802.11n HT20mode: MCS0

The target power for 802.11g and 802.11n HT20 1TX are the same and use the same modulation (OFDM).

The following configurations were investigated on AC line conducted test

Configuration	Descriptions
1	EUT powered by AC/DC adapter via USB cable
2	EUT powered by host PC via USB cable

There are two vendors of the WiFi/Bluetooth radio modules: variant 1 and variant 2 and they have the same mechanical outline, same on board antenna, matching circuit, antenna structure and same specification. Baseline testing was performed on all two variants to determine the worst case on all conducted power and radiated emissions

5.6. DESCRIPTION OF TEST SETUP

SUPPORT EQUIPMENT

Support Equipment List				
Description	Manufacturer	Model	Serial Number	FCC ID
Laptop AC/DC adapter	Lenovo	92P1160	11S92P1160Z1ZBGH798B12	N/A
Laptop	Lenovo	7659	L3-AL664 08/03	N/A
Earphone	Apple	N/A	N/A	N/A
EUT AC/CD adapter	Apple	A1385	D293062F3WVDHLHCF	N/A

I/O CABLES (CONDUCTED TEST)

I/O Cable List						
Cable No	Port	# of identical ports	Connector Type	Cable Type	Cable Length (m)	Remarks
1	Antenna	1	SMA	Un-Shielded	0.2	To spectrum Analyzer
2	USB	1	USB	Shielded	1	N/A
3	AC	1	AC	Un-shielded	3	N/A

I/O CABLES (RADIATED ABOVE 1 GHZ)

I/O Cable List						
Cable No	Port	# of identical ports	Connector Type	Cable Type	Cable Length (m)	Remarks
None Used						

I/O CABLES (RADAITED BELOW 1 GHZ)

I/O Cable List						
Cable No	Port	# of identical	Connector Type	Cable Type	Cable Length (m)	Remarks
1	Headphones Jack	1	3.5mm Audio	Shielded	0.9	N/A
2	AC	1	AC	Un-shielded	3	N/A

I/O CABLES (AC LINE CONDUCTED: AC/DC ADAPTER)

I/O Cable List						
Cable No	Port	# of identical	Connector Type	Cable Type	Cable Length (m)	Remarks
1	Headphones Jack	1	3.5mm Audio	Shielded	0.9	N/A
2	AC	1	AC	Un-shielded	3	N/A

I/O CABLES (AC LINE CONDUCTED: LAPTOP CONFIGUARTION)

I/O Cable List						
Cable No	Port	# of identical	Connector Type	Cable Type	Cable Length (m)	Remarks
1	Headphones Jack	1	3.5mm Audio	Shielded	0.9	N/A
2	USB	1	USB	Shielded	1	N/A
3	AC	1	AC	Un-shielded	3	N/A

TEST SETUP - CONDUCTED TESTS

The EUT was tested connected to a host Laptop via USB cable adapter and spectrum analyzer to antenna port. Test software exercised the EUT.

SETUP DIAGRAM

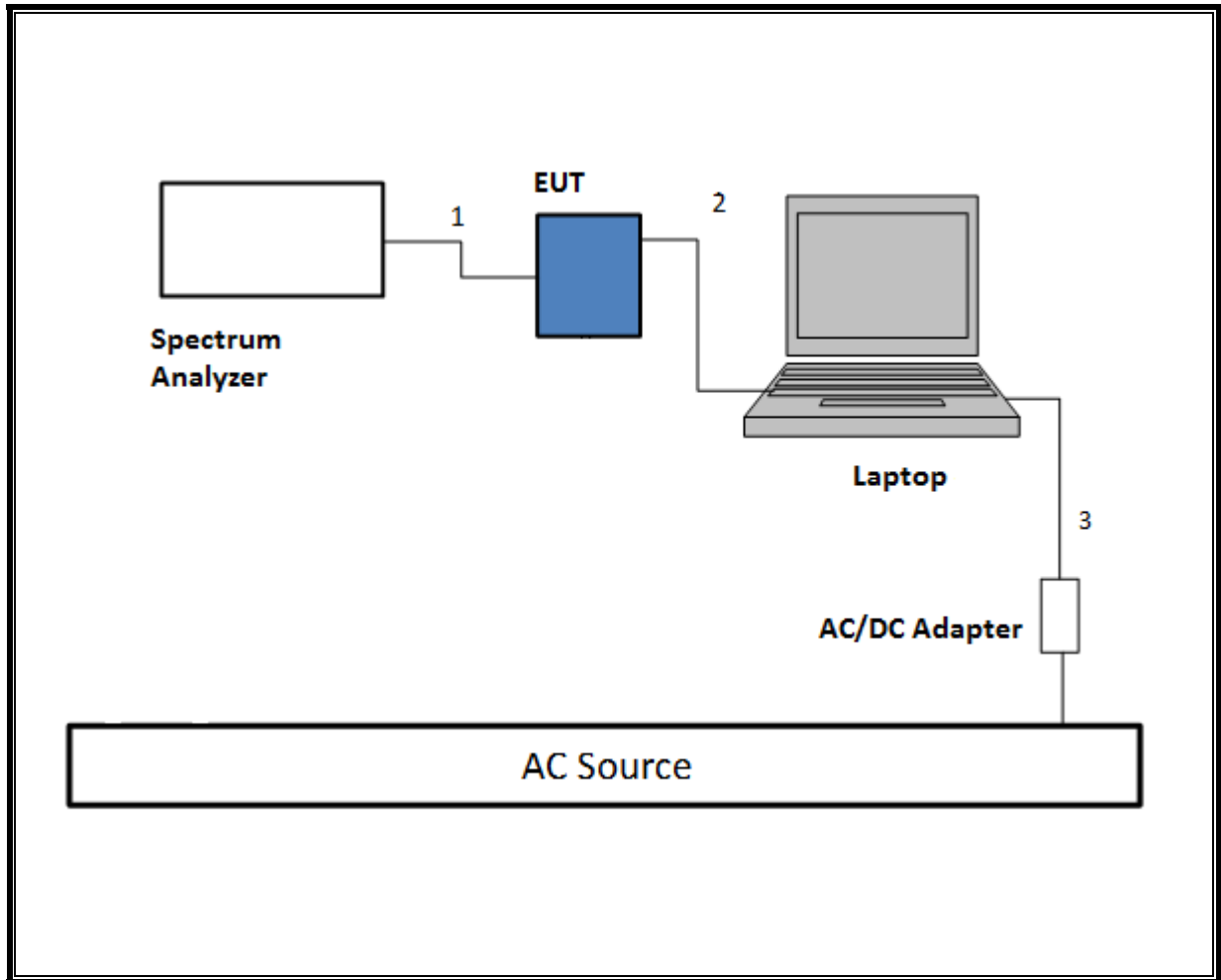

TEST SETUP- RADIATED-ABOVE 1 GHZ

The EUT was tested battery powered. Test software exercised the EUT.

SETUP DIAGRAM

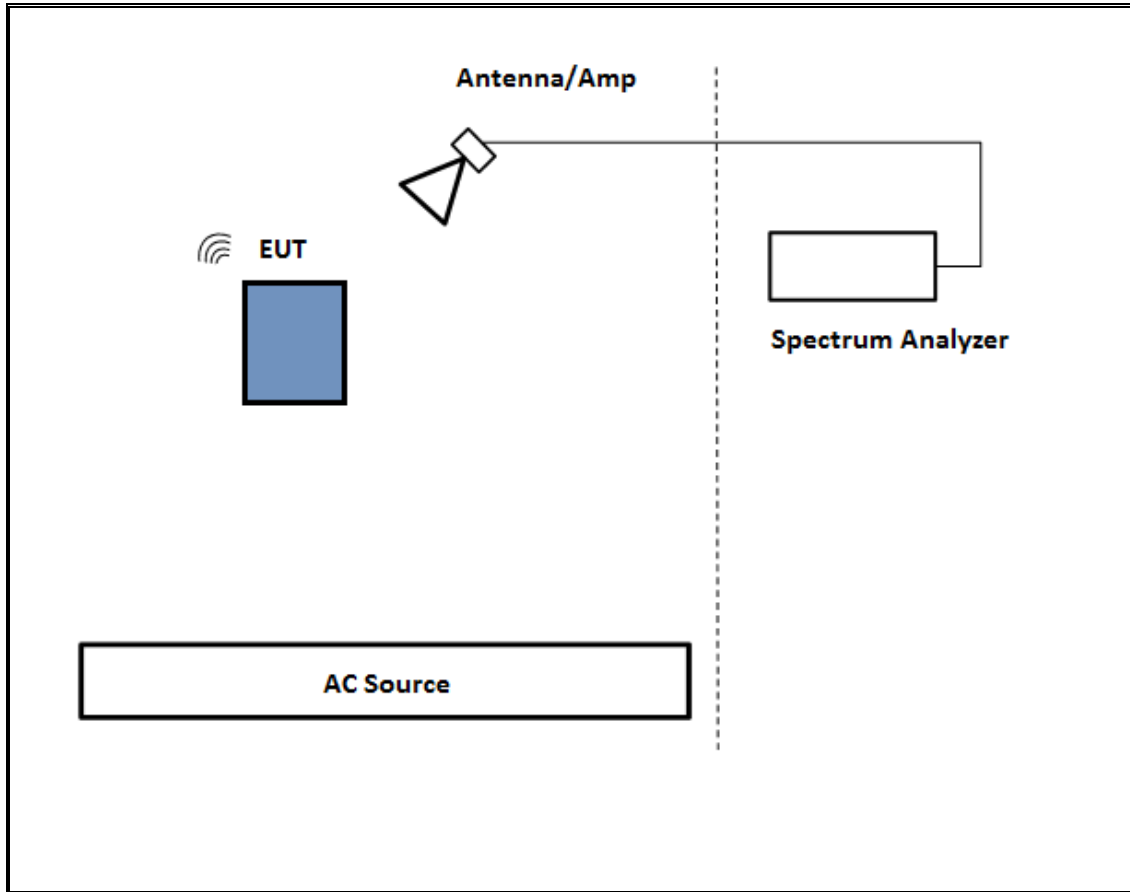

TEST SETUP- BELOW 1GHz

The EUT was tested with earphone connected and powered by AC adapter. Test software exercised the EUT.

SETUP DIAGRAM

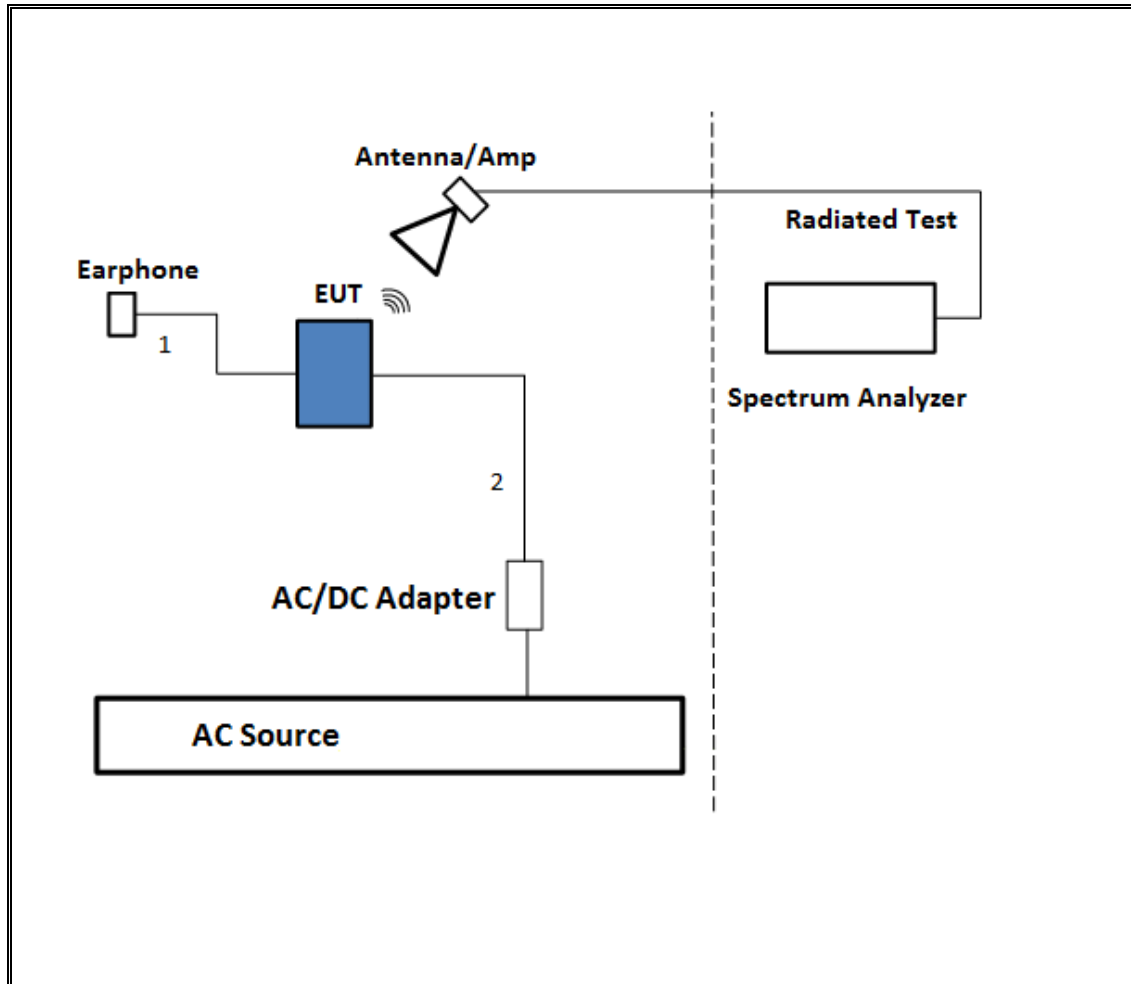

TEST SETUP- AC LINE CONDUCTED: AC/DC ADAPTER

The EUT was tested with earphone connected and powered by AC/DC adapter via USB cable. Test software exercised the EUT.

SETUP DIAGRAM

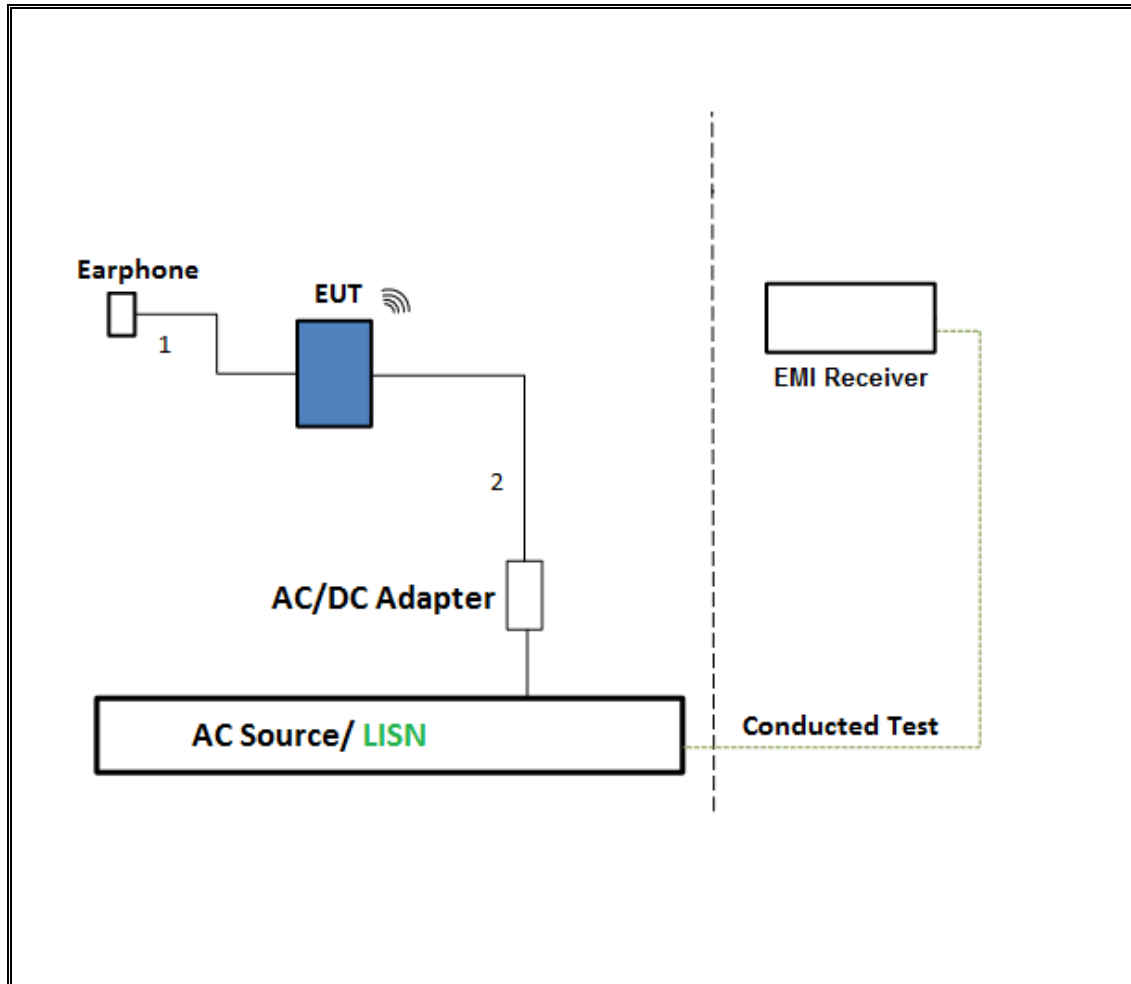

TEST SETUP- AC LINE CONDUCTED: LAPTOP CONFIGURATION

The EUT was tested with earphone connected and powered by host PC via USB cable. Test software exercised the EUT.

SETUP DIAGRAM

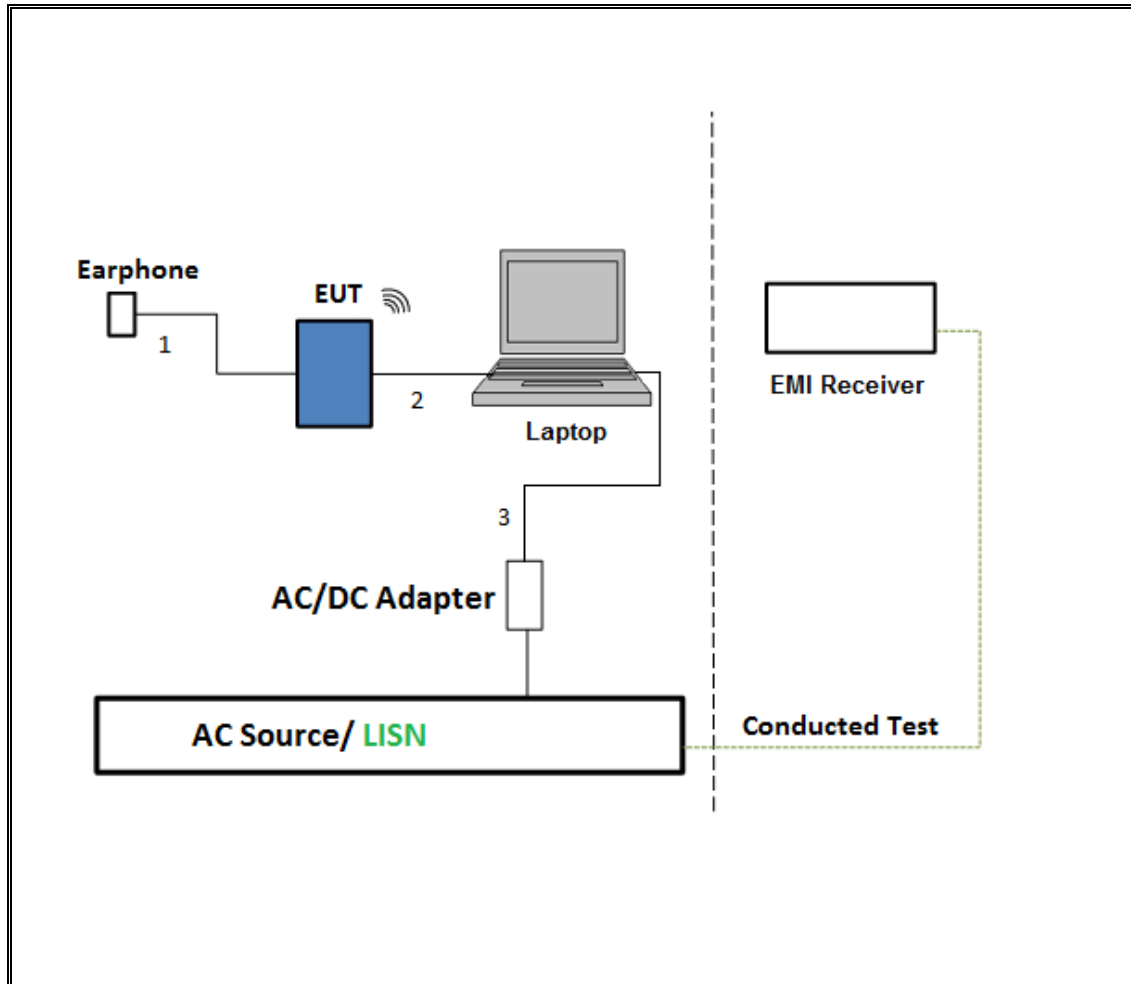

6. TEST AND MEASUREMENT EQUIPMENT

The following test and measurement equipment was utilized for the tests documented in this report:

Test Equipment List				
Description	Manufacturer	Model	Asset	Cal Due
Antenna, Horn 1-18GHz	ETS Lindgren	3117	00143448	2/10/2016
Antenna, Broadband Hybrid, 30MHz to 2000MHz	Sunol Sciences	JB3	A022813-1	1/14/2016
Amplifier, 1 - 18GHz	Miteq	AFS42-00101800-25-S-42	1782158	1/26/2016
Amplifier, 10KHz to 1GHz, 32dB	Sonoma	310N	171202	11/1/2015
Spectrum Analyzer, PXA, 3Hz to 50GHz	Agilent	N9030A	MY52350427	9/13/2015
Amplifier, 10KHz to 1GHz, 32dB	Sonoma	310N	325118	2/14/2016
Spectrum Analyzer, PXA, 3Hz to 44GHz	Agilent	N9030A	MY52350675	3/16/2016
Power Meter, P-series single channel	Agilent	N1911A	GB45100212	10/9/2015
Power Sensor, P - series, 50MHz to 18GHz, Wideband	Agilent	N1921A	MY53260010	4/7/2016
Antenna, Horn 18 to 26.5GHz	ARA	MWH-1826	1049	12/17/2015
Amplifier, 1 to 26.5GHz, 23.5dB Gain minimum	Agilent	8449B	3008A01114	10/4/2015
AC Line Conducted				
EMI Test Receiver 9KHz-7GHz	Rohde & Schwarz	ESC17	100935	9/16/2015
LISN for Conducted Emissions CISPR-16	FCC	50/250-25-2	114	1/16/2016
Power Cable, Line Conducted Emissions ANSI 63.4	U L	PG1	N/A	7/28/2015
UL SOFTWARE				
*Radiated Software	UL	UL EMC	Ver 9.5, July 22, 2014	
*Conducted Software	UL	UL EMC	Ver 2.2, March 31, 2015	
*AC Line Conducted Software	UL	UL EMC	Ver 9.5, April 3, 2015	

Note: * indicates automation software version used in the compliance certification testing

7. MEASUREMENT METHODS

6 dB BW: KDB 558074 D01 v03r03, Section 8.1.

Output Power: KDB 558074 D01 v03r03, Section 9.1.2

Power Spectral Density: KDB 558074 D01 v03r03, Section 10.2.

Out-of-band emissions in non-restricted bands: KDB 558074 D01 v03r03, Section 11.0.

Out-of-band emissions in restricted bands: KDB 558074 D01 v03r03, Section 12.1.

Band-edge: KDB 558074 D01 v03r03, Section 12.1

8. ANTENNA PORT TEST RESULTS

8.1. ON TIME AND DUTY CYCLE

LIMITS

None; for reporting purposes only.

PROCEDURE

KDB 558074 Zero-Span Spectrum Analyzer Method.

ON TIME AND DUTY CYCLE RESULTS

Mode	ON Time B (msec)	Period (msec)	Duty Cycle x (linear)	Duty Cycle (%)	Duty Cycle Correction Factor (dB)	1/B Minimum VBW (kHz)
2.4GHz Band						
802.11b, chain 0	1.000	1.000	1.000	100.00%	0.00	0.010
802.11b, chain 1	1.000	1.000	1.000	100.00%	0.00	0.010
802.11n HT20 1TX,chain 0	1.920	1.941	0.989	98.92%	0.00	0.010
802.11n HT20 1TX,chain 1	1.917	1.938	0.989	98.92%	0.00	0.010
802.11n HT20 CDD,chain 0	1.917	1.941	0.988	98.76%	0.00	0.010
802.11n HT20 CDD,chain 1	1.917	1.941	0.988	98.76%	0.00	0.010

DUTY CYCLE PLOTS

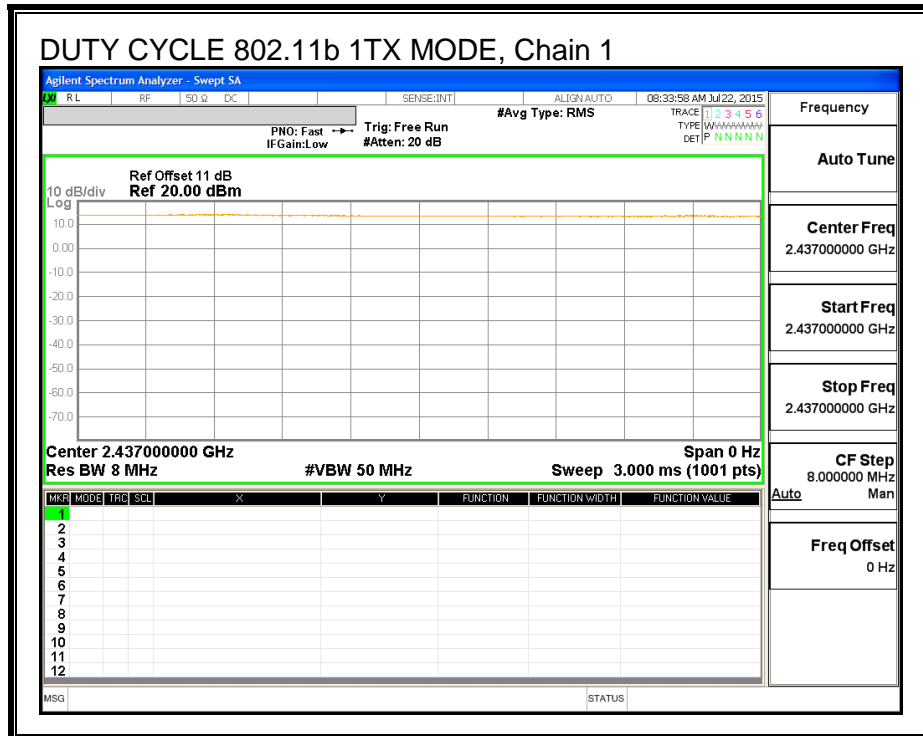
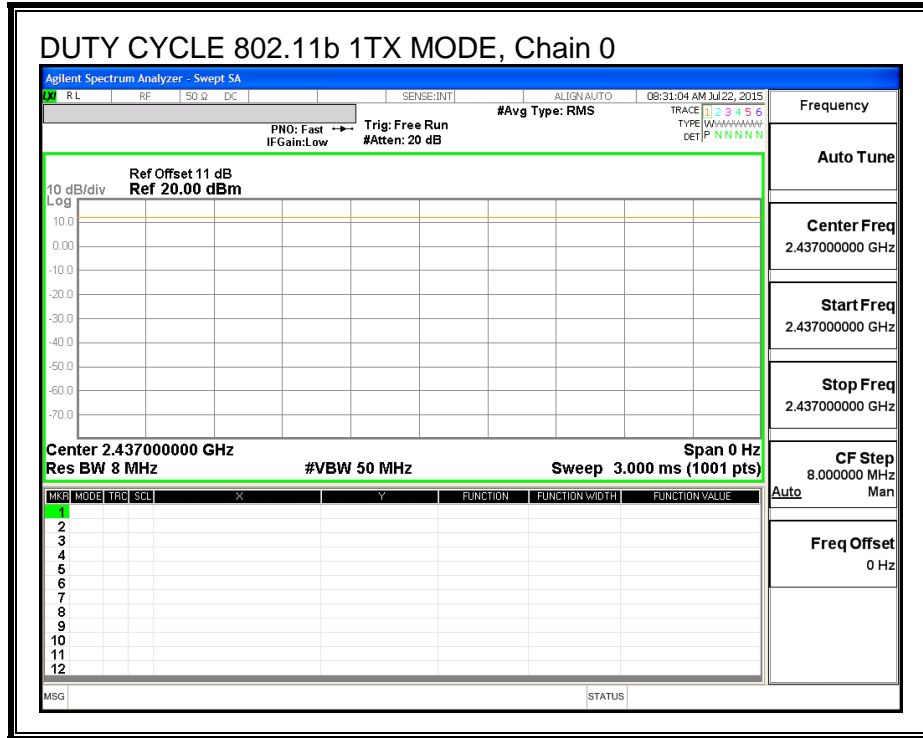

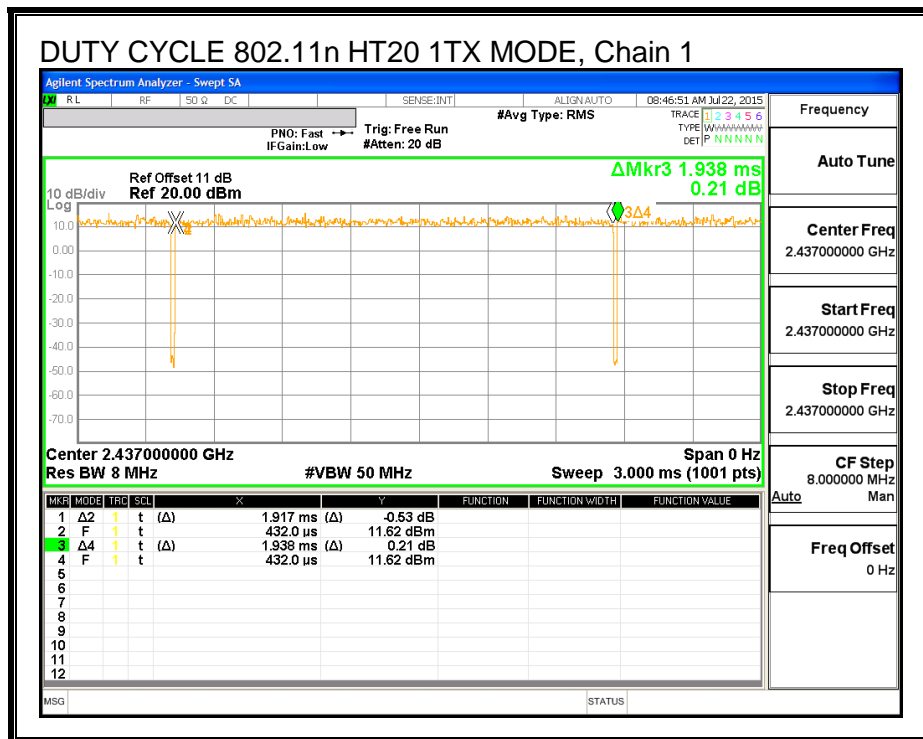
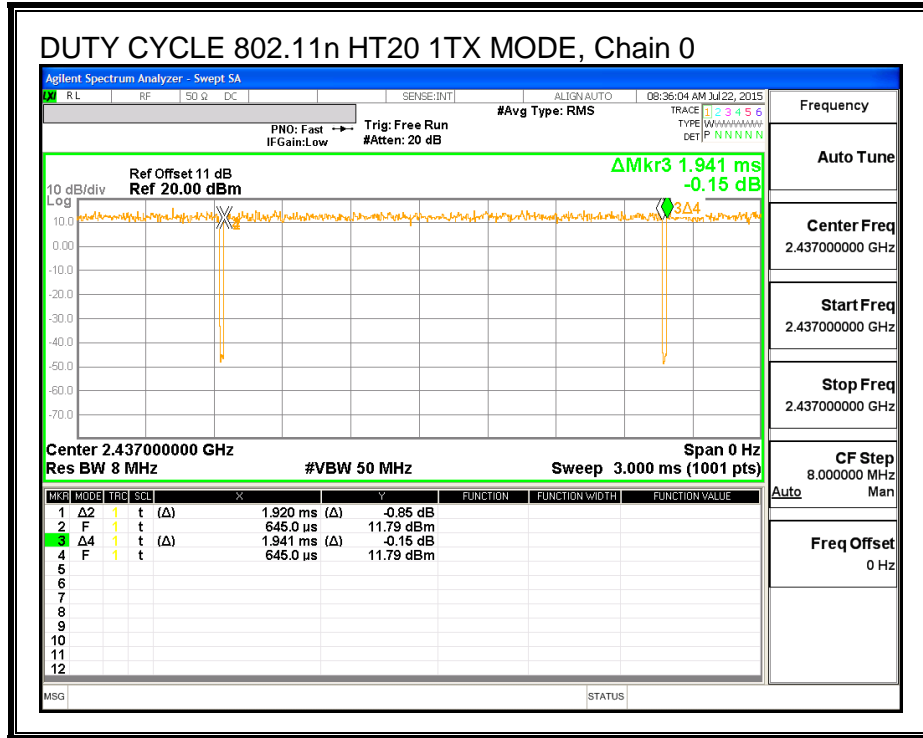

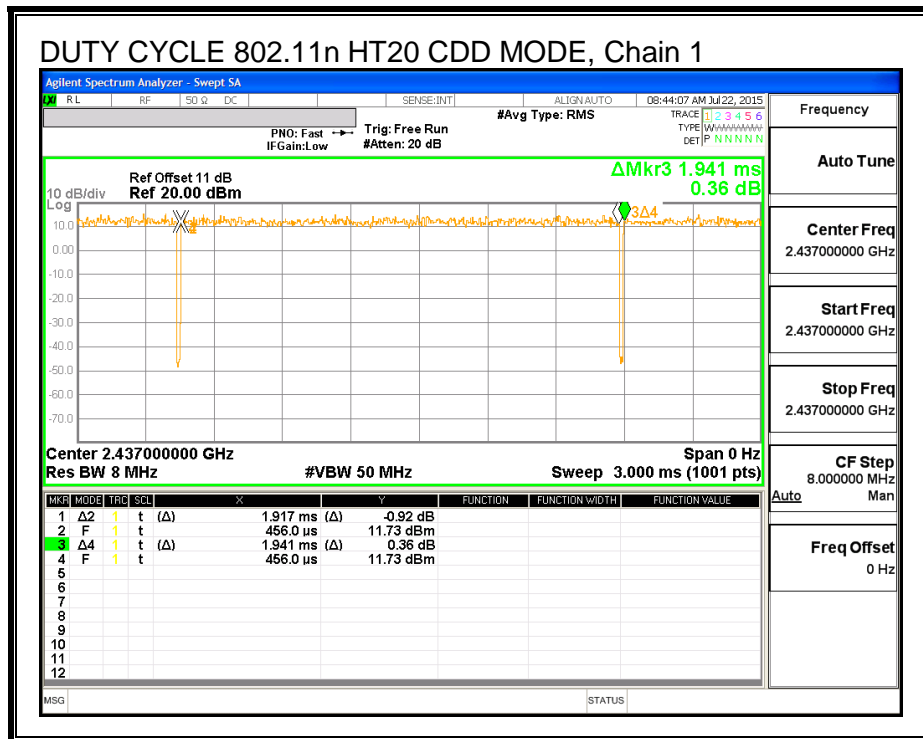
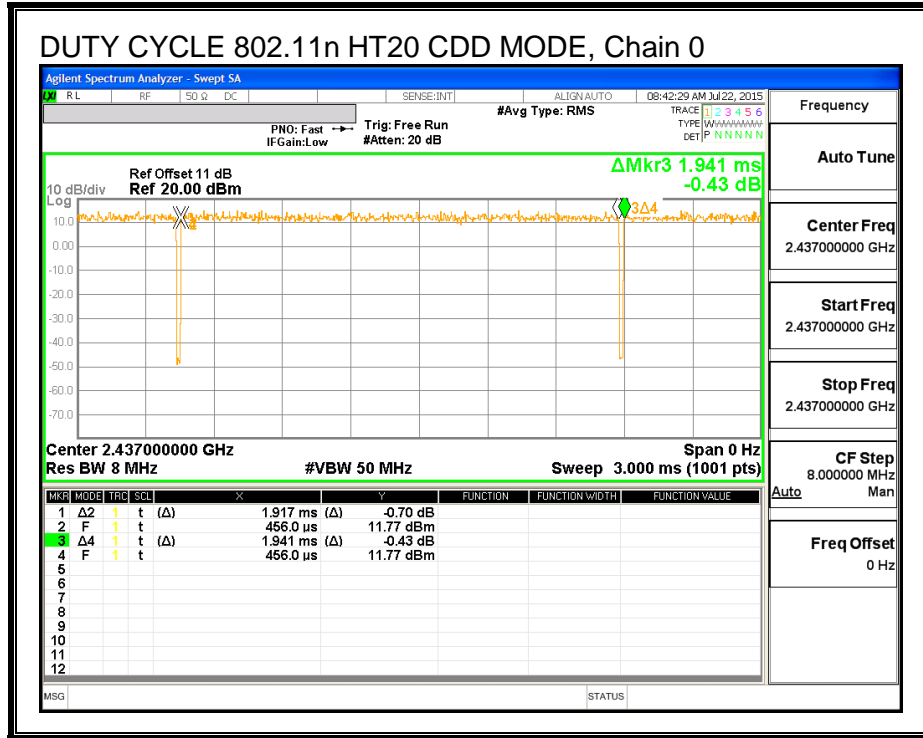

8.2. 802.11b SISO MODE IN THE 2.4 GHz BAND

8.2.1. 6 dB BANDWIDTH

LIMITS

FCC §15.247 (a) (2)

IC RSS-247 (5.2) (1)

The minimum 6 dB bandwidth shall be at least 500 kHz.

RESULTS for Chain 0

Channel	Frequency (MHz)	6 dB Bandwidth (MHz)	Minimum Limit (MHz)
Low	2412	9.075	0.5
Mid	2437	9.075	0.5
High_11	2462	9.030	0.5
High_12	2467	9.075	0.5
High_13	2472	9.075	0.5

RESULTS for Chain 1

Channel	Frequency (MHz)	6 dB Bandwidth (MHz)	Minimum Limit (MHz)
Low	2412	9.090	0.5
Mid	2437	9.090	0.5
High_11	2462	9.060	0.5
High_12	2467	9.090	0.5
High_13	2472	9.090	0.5

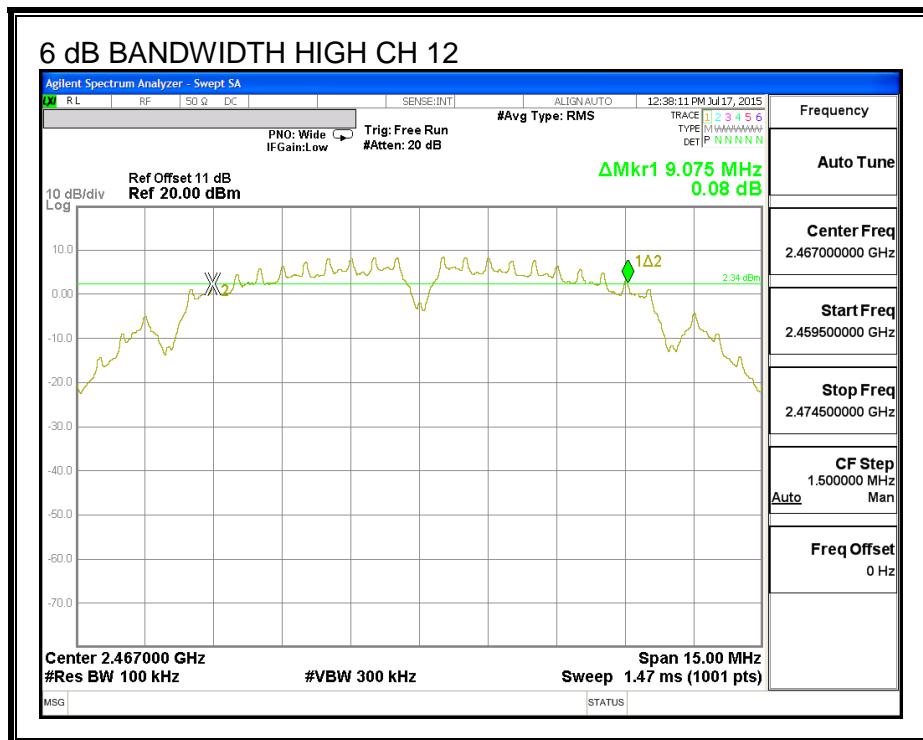
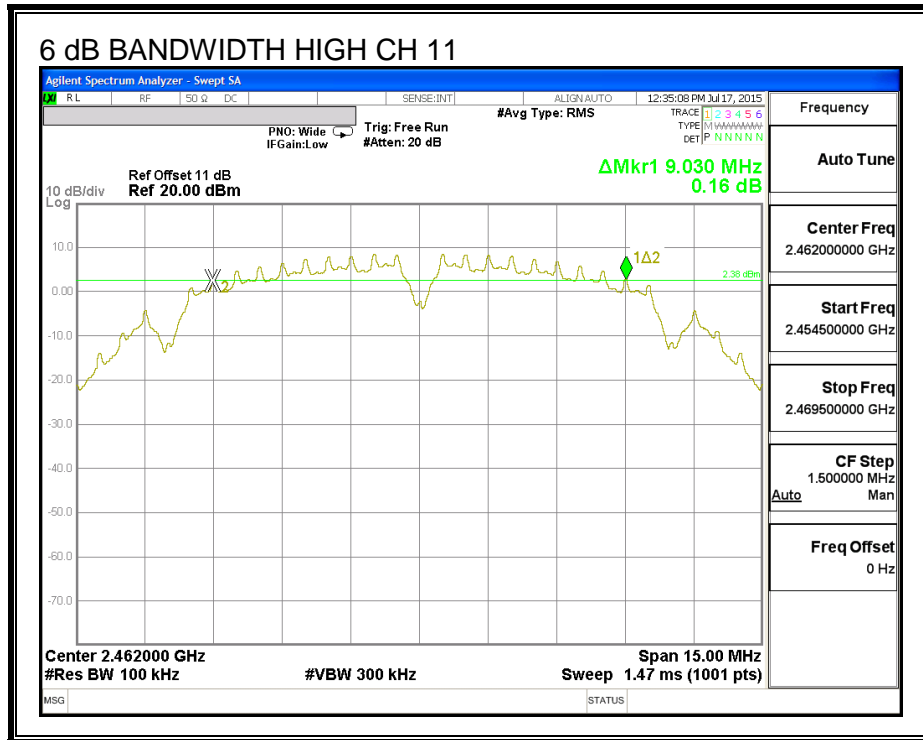

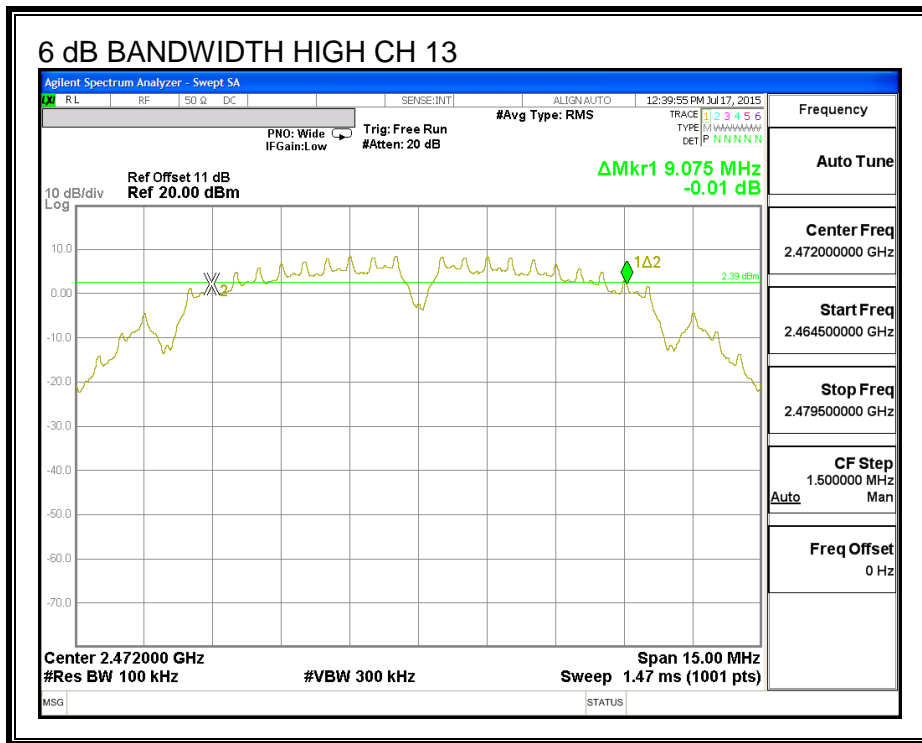

6 dB BANDWIDTH, Chain 1

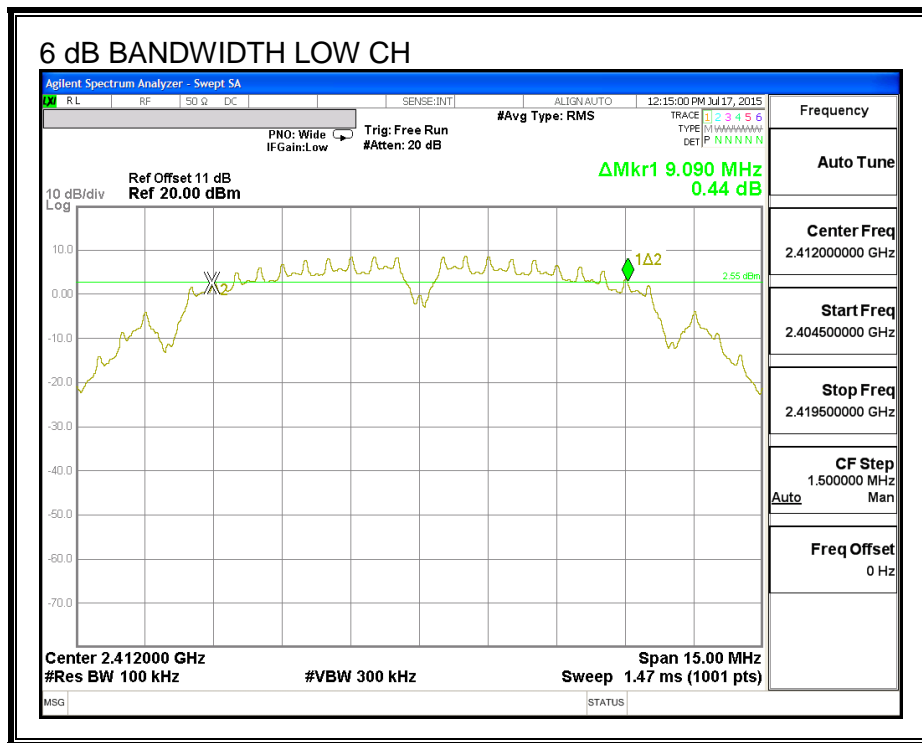

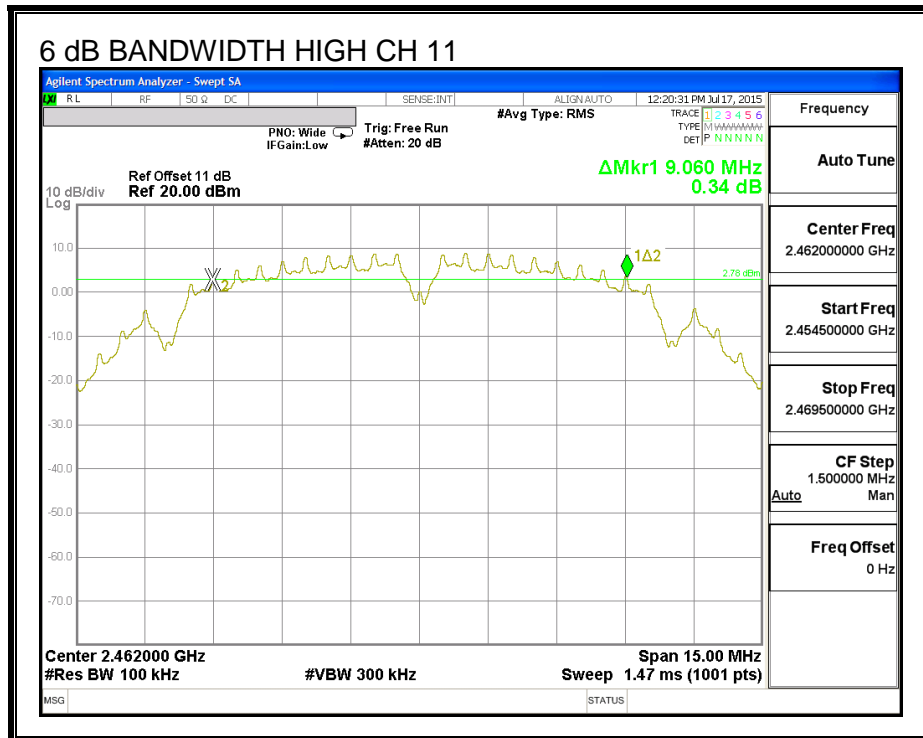
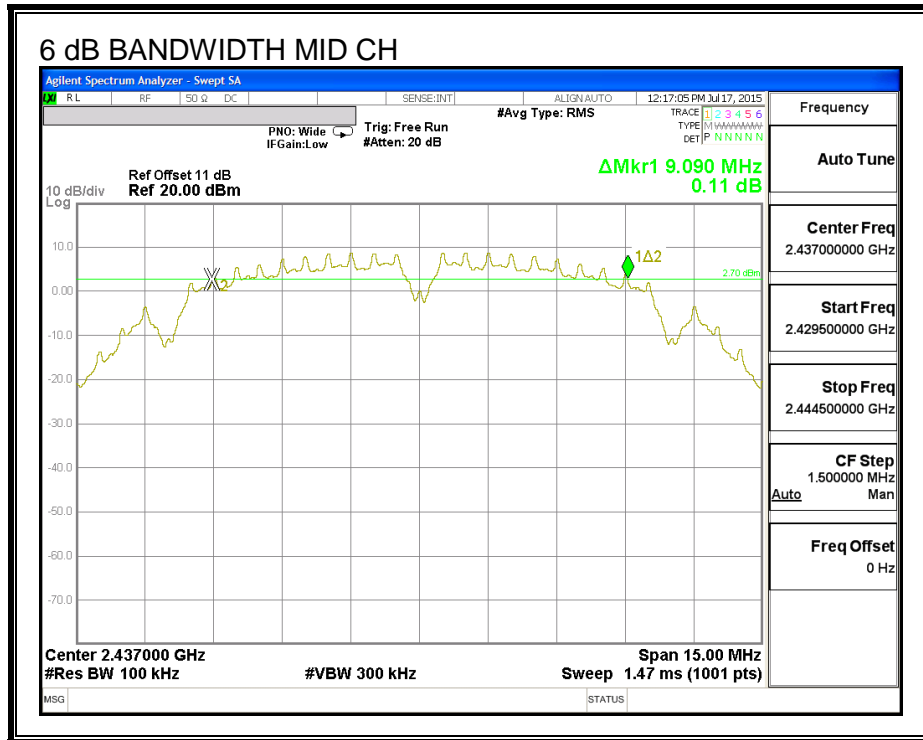

8.2.2. 99% BANDWIDTH

LIMITS

None; for reporting purposes only.

RESULTS for Chain 0

Channel	Frequency (MHz)	99% Bandwidth (MHz)
Low	2412	11.279
Mid	2437	11.899
High_11	2462	11.739
High_12	2467	11.553
High_13	2472	11.712

RESULTS for Chain 1

Channel	Frequency (MHz)	99% Bandwidth (MHz)
Low	2412	11.587
Mid	2437	11.829
High_11	2462	10.956
High_12	2467	11.290
High_13	2472	11.747

99% BANDWIDTH, Chain 0

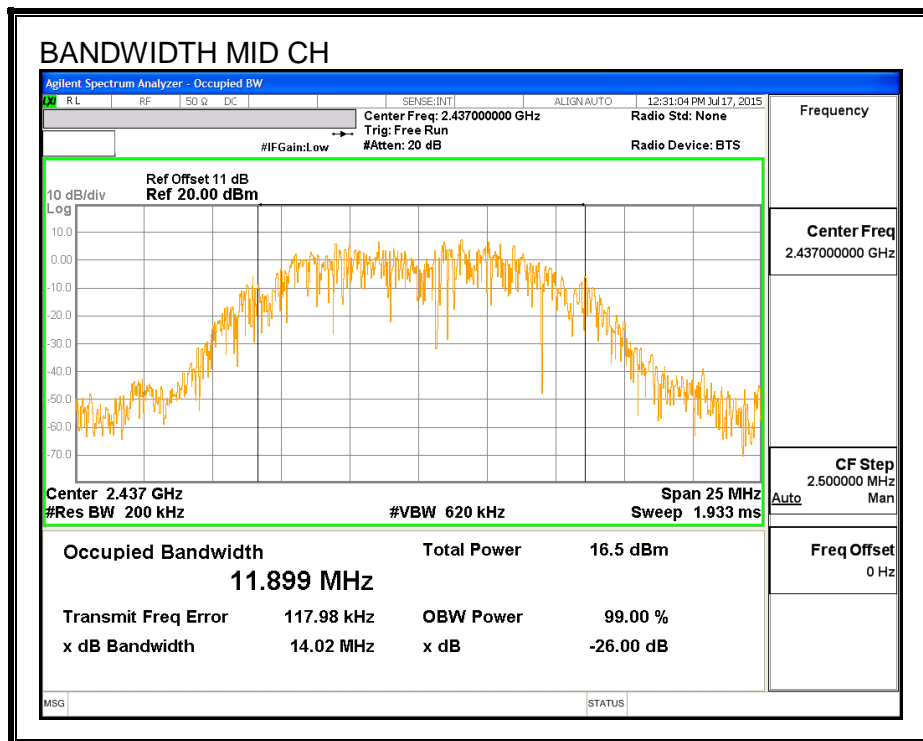
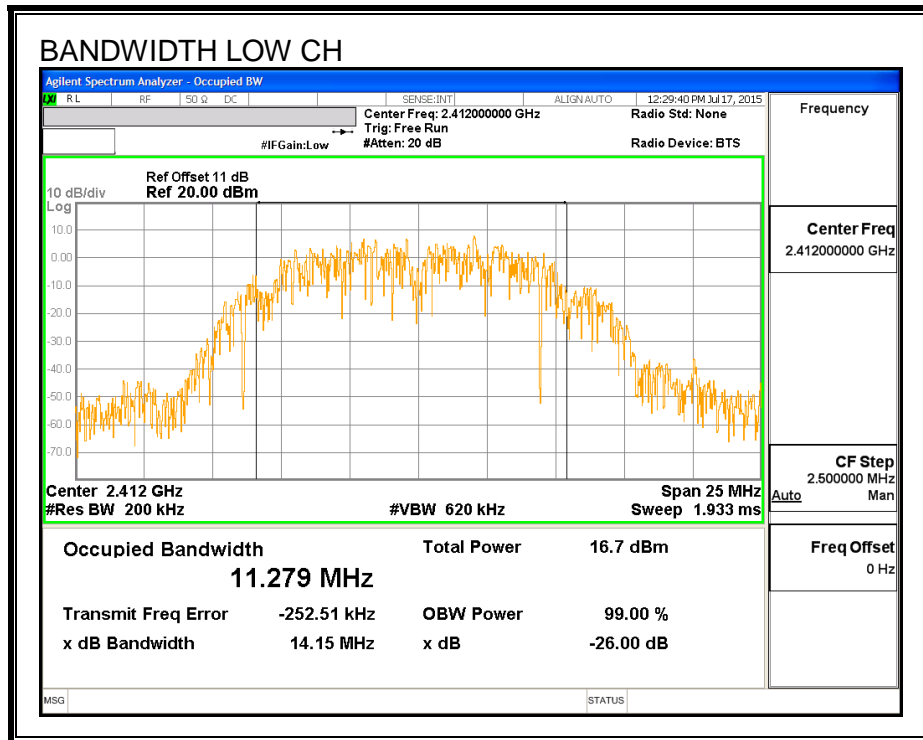

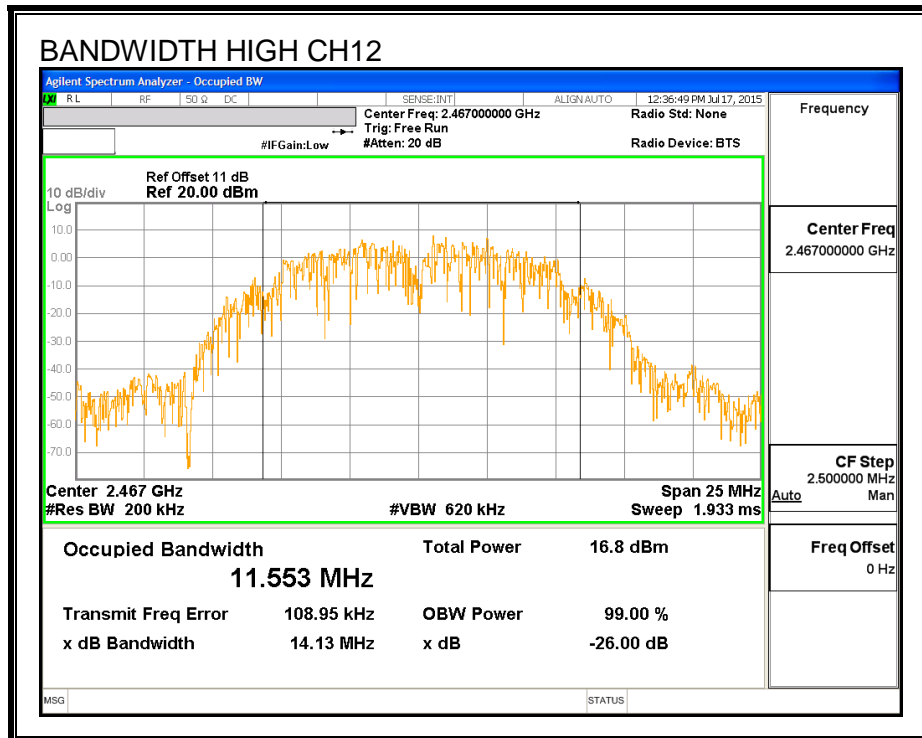
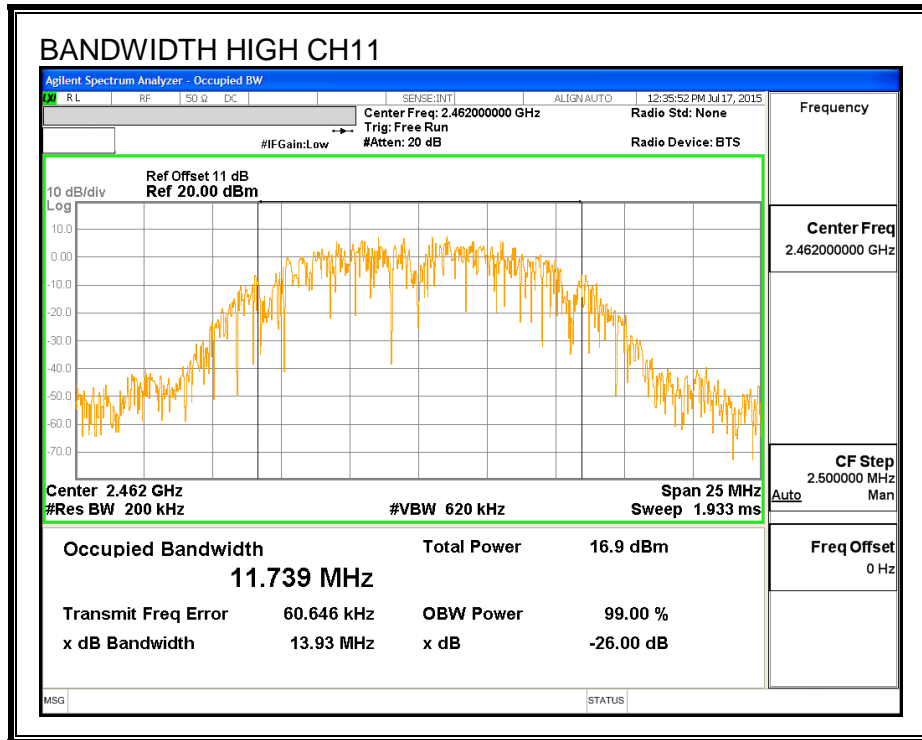

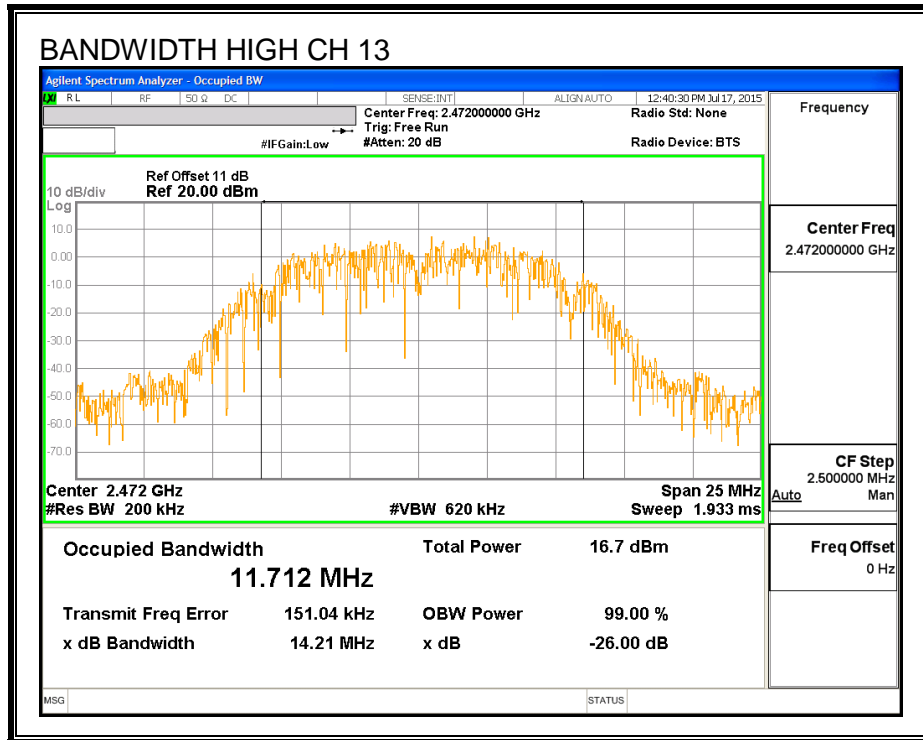

99% BANDWIDTH, Chain 1

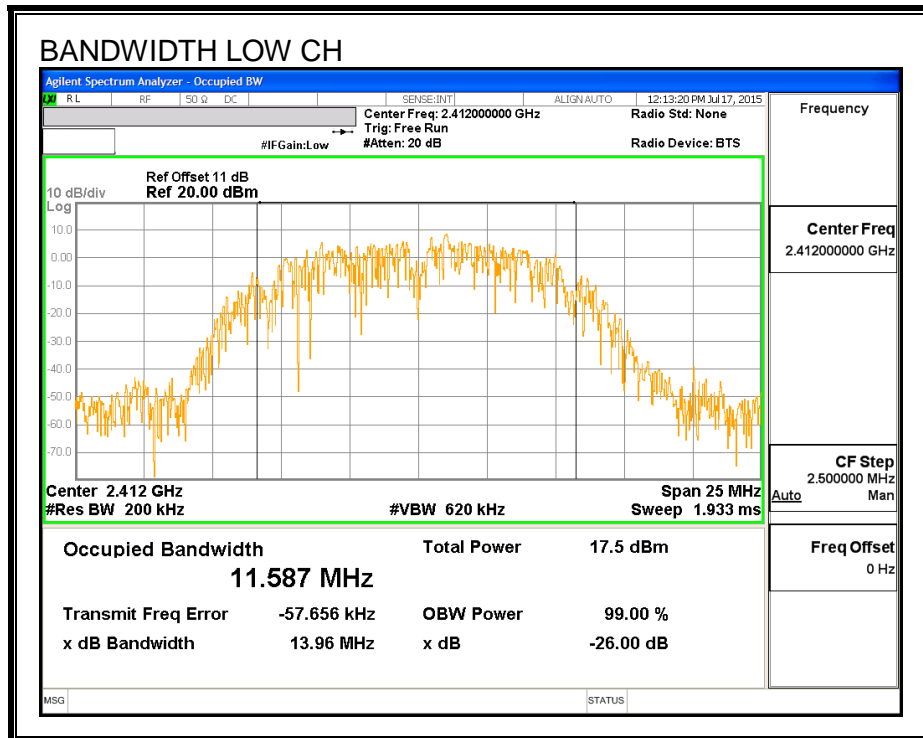

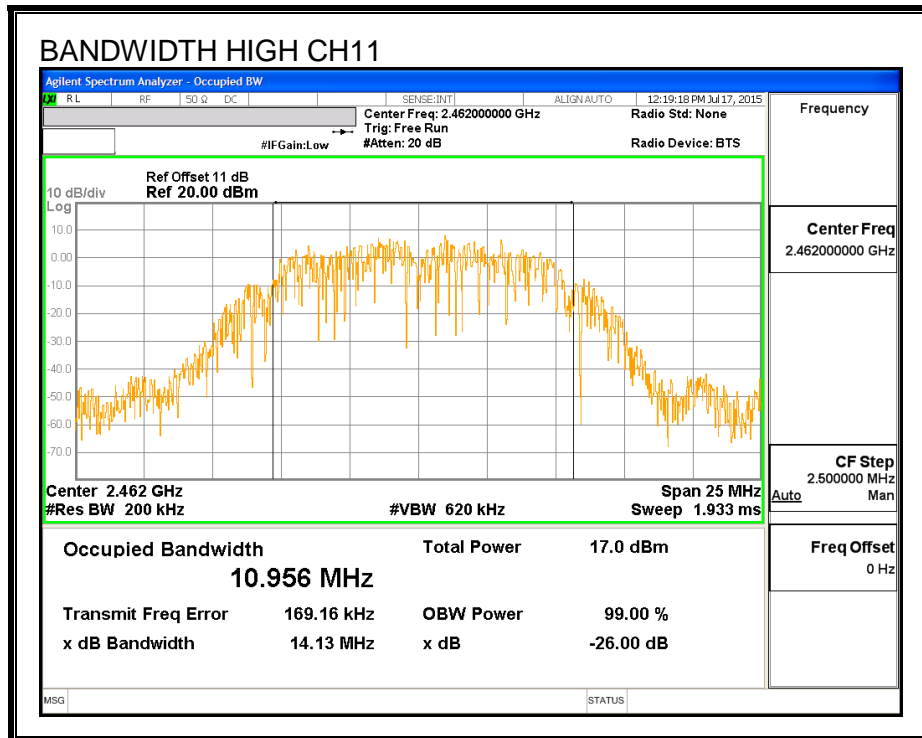
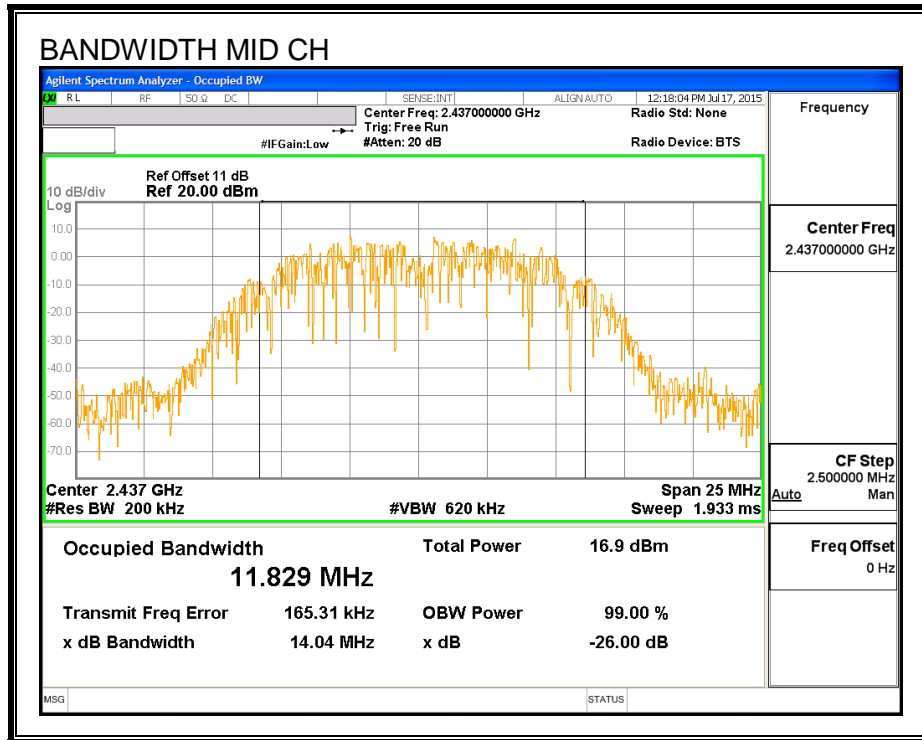

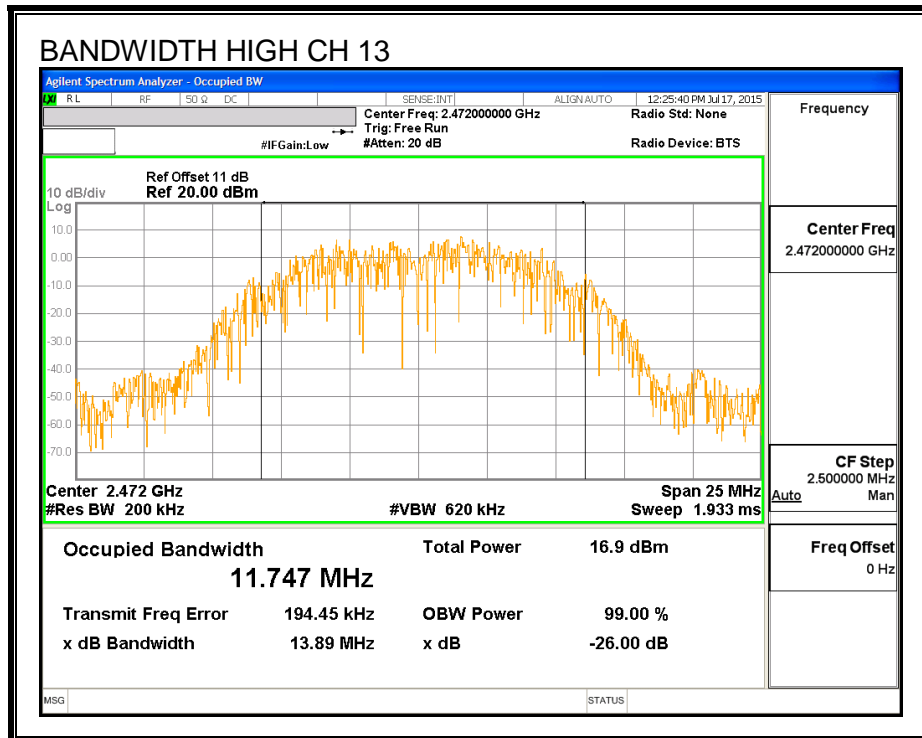
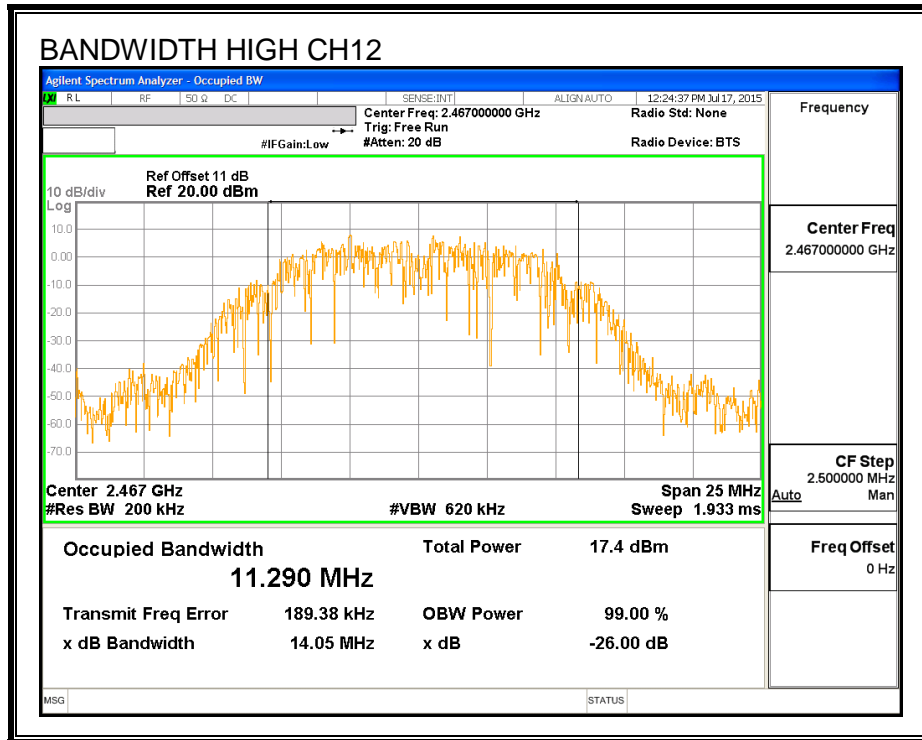

8.2.3. AVERAGE POWER

LIMITS

None; for reporting purposes only.

RESULTS for Chain 0

Channel	Frequency (MHz)	Power (dBm)
Low	2412	15.89
Mid	2437	16.00
High_11	2462	15.99
High_12	2467	15.98
High_13	2472	12.89

RESULTS for Chain 1

Channel	Frequency (MHz)	Power (dBm)
Low	2412	15.93
Mid	2437	15.83
High_11	2462	15.98
High_12	2467	15.96
High_13	2472	12.88

8.2.4. OUTPUT POWER

LIMITS

FCC §15.247

IC RSS-247 (5.4) (4)

For systems using digital modulation in the 2400–2483.5 MHz, and 5725–5850 MHz bands: 1 Watt, based on the use of antennas with directional gains that do not exceed 6 dBi. If transmitting antennas of directional gain greater than 6 dBi are used, the conducted output power from the intentional radiator shall be reduced by the amount in dB that the directional gain of the antenna exceeds 6 dBi.

DIRECTIONAL ANTENNA GAIN

There is only one transmitter output therefore the directional gain is equal to the antenna gain.

RESULTS for Chain 0

Limits

Channel	Frequency (MHz)	Directional Gain (dBi)	FCC Power Limit (dBm)	IC Power Limit (dBm)	IC EIRP Limit (dBm)	Max Power (dBm)
Low	2412	-0.60	30.00	30	36	30.00
Mid	2437	-0.60	30.00	30	36	30.00
High_11	2462	-0.60	30.00	30	36	30.00
High_12	2467	-0.60	30.00	30	36	30.00
High_13	2472	-0.60	30.00	30	36	30.00

Duty Cycle CF (dB)	0.00	Included in Calculations of Corr'd Power
---------------------------	------	---

Results

Channel	Frequency (MHz)	Chain 0 Meas Power (dBm)	Total Corr'd Power (dBm)	Power Limit (dBm)	Margin (dB)
Low	2412	18.83	18.83	30.00	-11.17
Mid	2437	18.97	18.97	30.00	-11.03
High_11	2462	18.96	18.96	30.00	-11.04
High_12	2467	18.93	18.93	30.00	-11.07
High_13	2472	15.82	15.82	30.00	-14.18

RESULTS for Chain 1

Limits

Channel	Frequency (MHz)	Directional Gain (dBi)	FCC Power Limit (dBm)	IC Power Limit (dBm)	IC EIRP Limit (dBm)	Max Power (dBm)
Low	2412	-0.50	30.00	30	36	30.00
Mid	2437	-0.50	30.00	30	36	30.00
High_11	2462	-0.50	30.00	30	36	30.00
High_12	2467	-0.50	30.00	30	36	30.00
High_13	2472	-0.50	30.00	30	36	30.00

Duty Cycle CF (dB)	0.00	Included in Calculations of Corr'd Power
---------------------------	------	---

Results

Channel	Frequency (MHz)	Chain 1 Meas Power (dBm)	Total Corr'd Power (dBm)	Power Limit (dBm)	Margin (dB)
Low	2412	18.95	18.95	30.00	-11.05
Mid	2437	18.86	18.86	30.00	-11.14
High_11	2462	18.94	18.94	30.00	-11.06
High_12	2467	18.91	18.91	30.00	-11.09
High_13	2472	15.78	15.78	30.00	-14.22

8.2.5. POWER SPECTRAL DENSITY

LIMITS

FCC §15.247

IC RSS-247 (5.2) (2)

For digitally modulated systems, the power spectral density conducted from the intentional radiator to the antenna shall not be greater than 8 dBm in any 3 KHz band during any time interval of continuous transmissions.

RESULTS for Chain 0

Duty Cycle CF (dB)	0.00	Included in Calculations of Corr'd PSD
---------------------------	------	---

PSD Results

Channel	Frequency (MHz)	Chain 0 Meas (dBm)	Total Corr'd PSD (dBm)	Limit (dBm)	Margin (dB)
Low	2412	-6.55	-6.55	8.0	-14.6
Mid	2437	-7.46	-7.46	8.0	-15.5
High_11	2462	-7.08	-7.08	8.0	-15.1
High_12	2467	-6.79	-6.79	8.0	-14.8
High_13	2472	-10.15	-10.15	8.0	-18.2

RESULTS for Chain 1

Duty Cycle CF (dB)	0.00	Included in Calculations of Corr'd PSD
---------------------------	------	---

PSD Results

Channel	Frequency (MHz)	Chain 1 Meas (dBm)	Total Corr'd PSD (dBm)	Limit (dBm)	Margin (dB)
Low	2412	-6.86	-6.86	8.0	-14.9
Mid	2437	-7.51	-7.51	8.0	-15.5
High_11	2462	-7.34	-7.34	8.0	-15.3
High_12	2467	-7.02	-7.02	8.0	-15.0
High_13	2472	-10.38	-10.38	8.0	-18.4

PSD, Chain 0

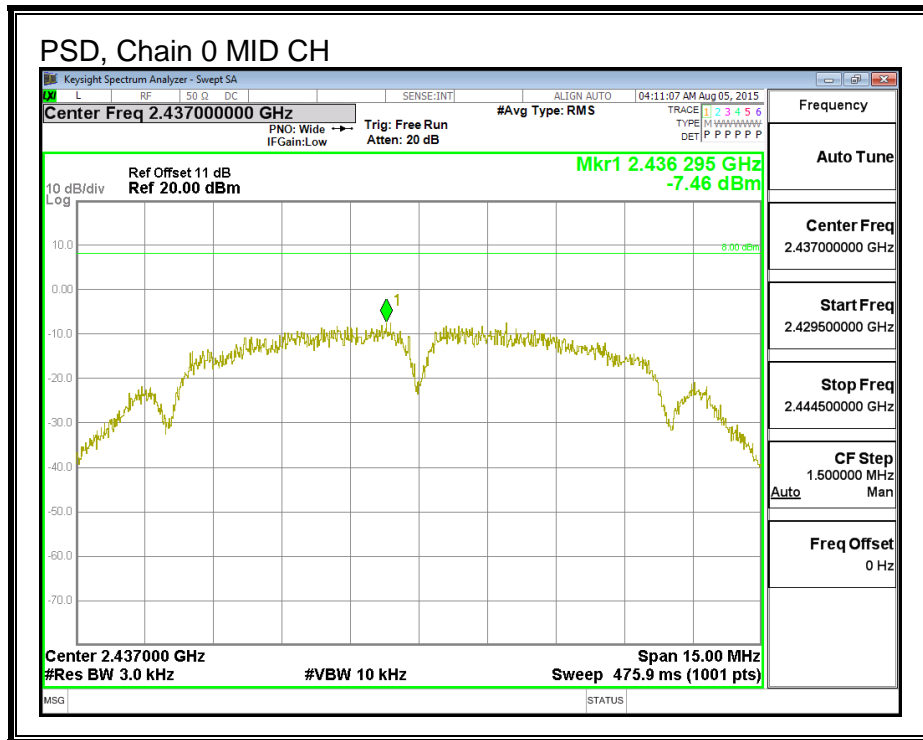
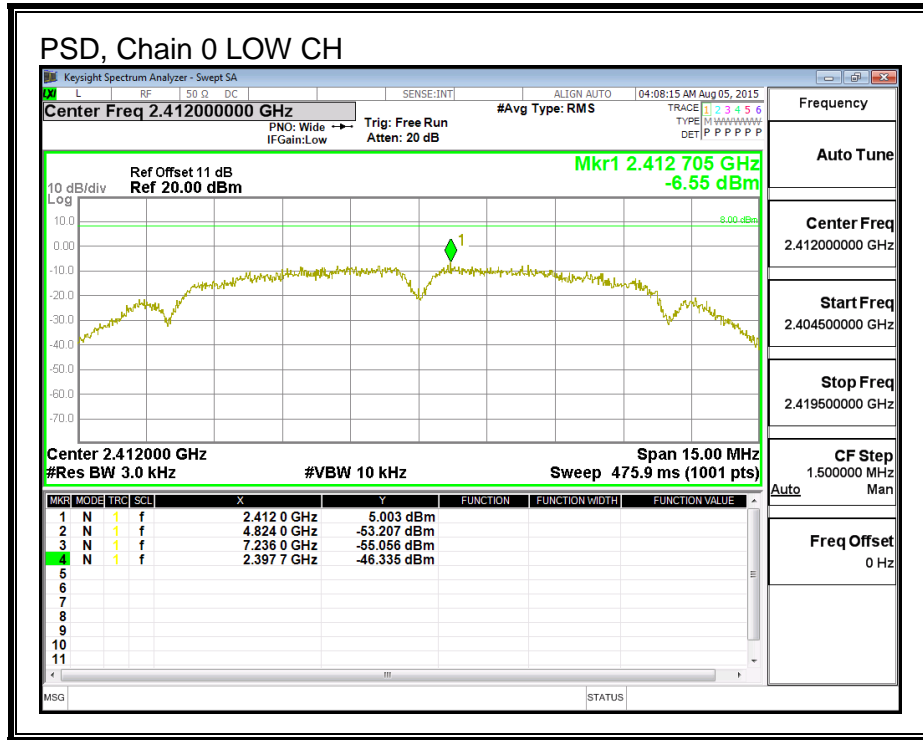

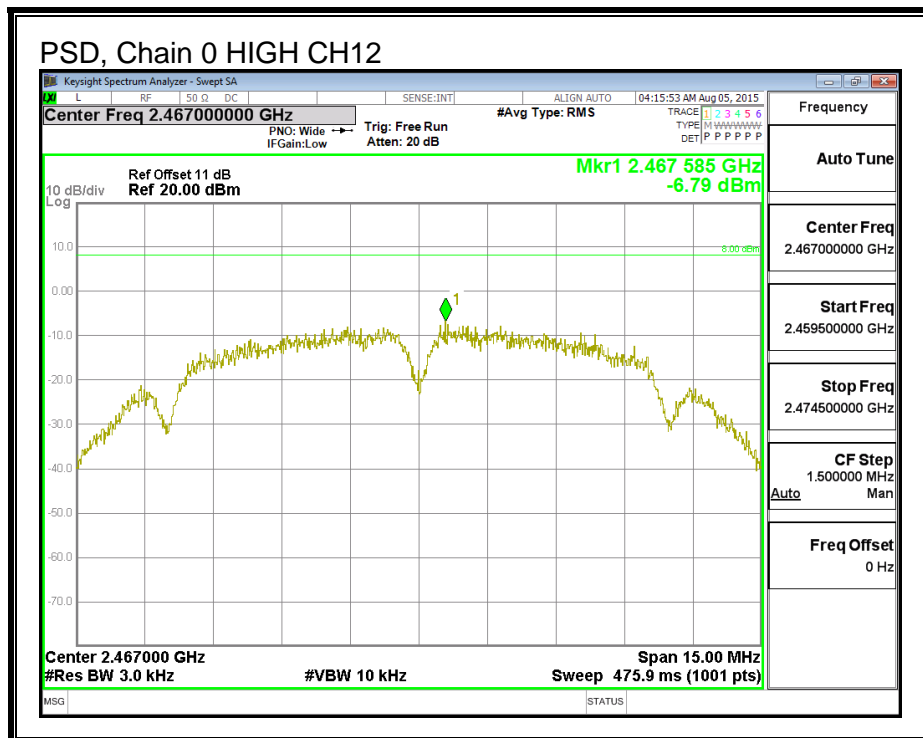
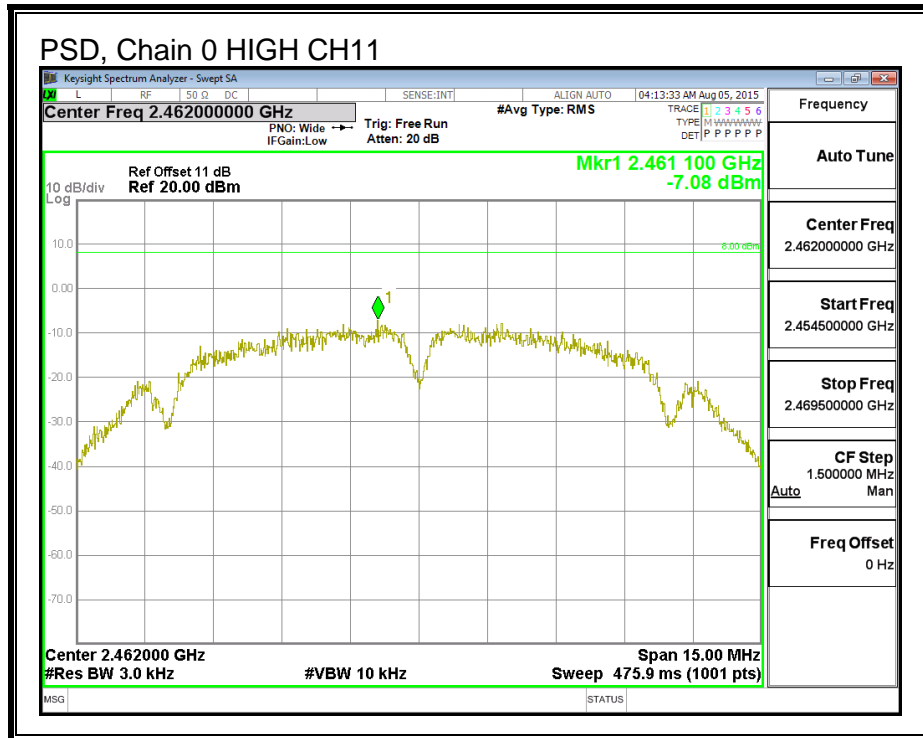

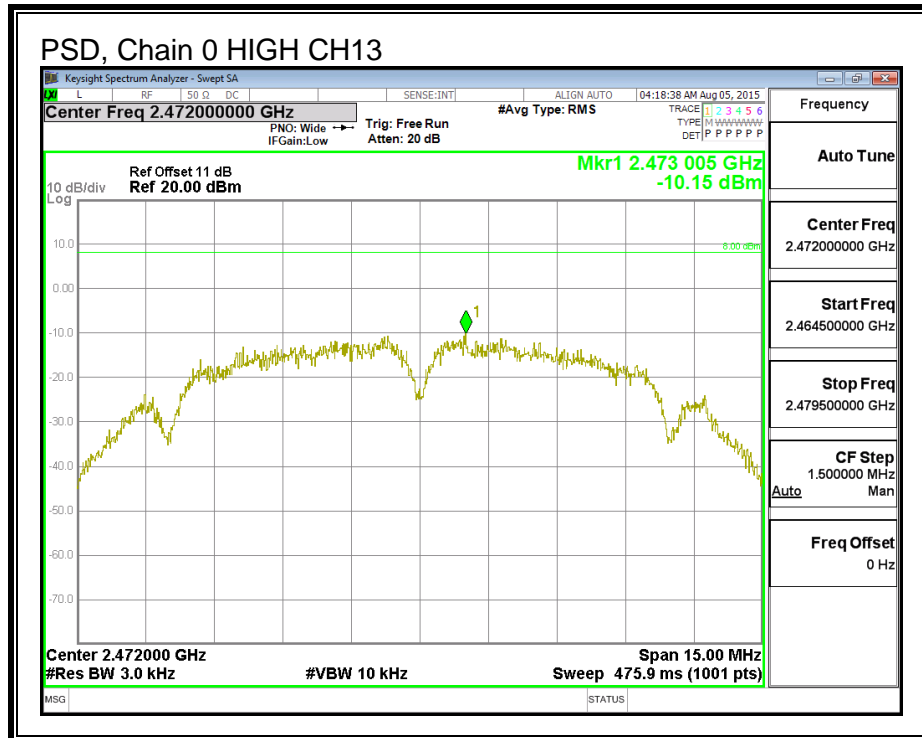

PSD, Chain 1

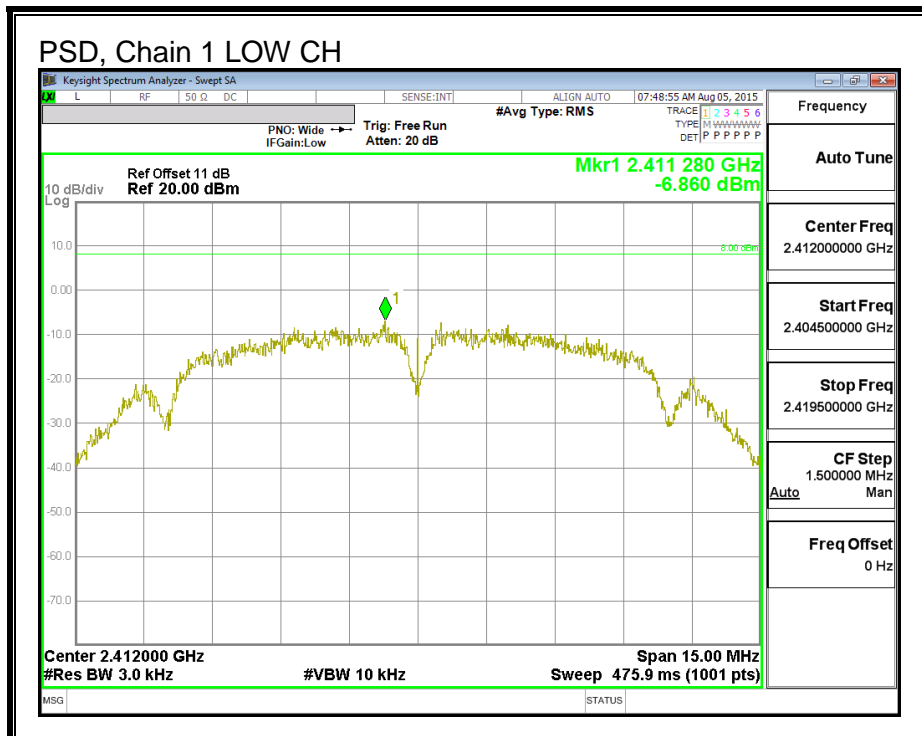

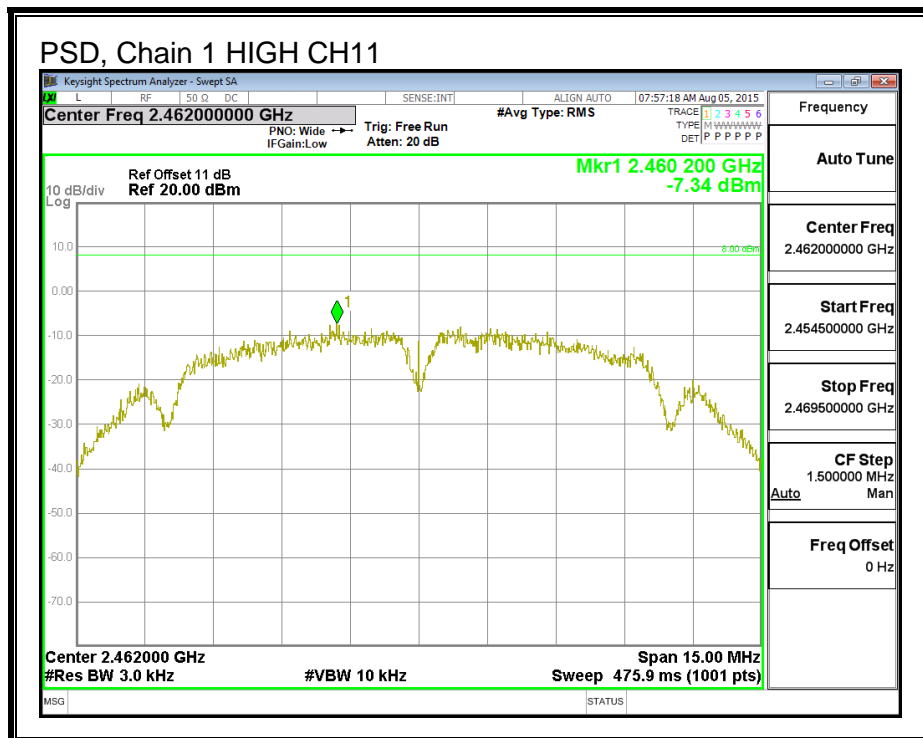
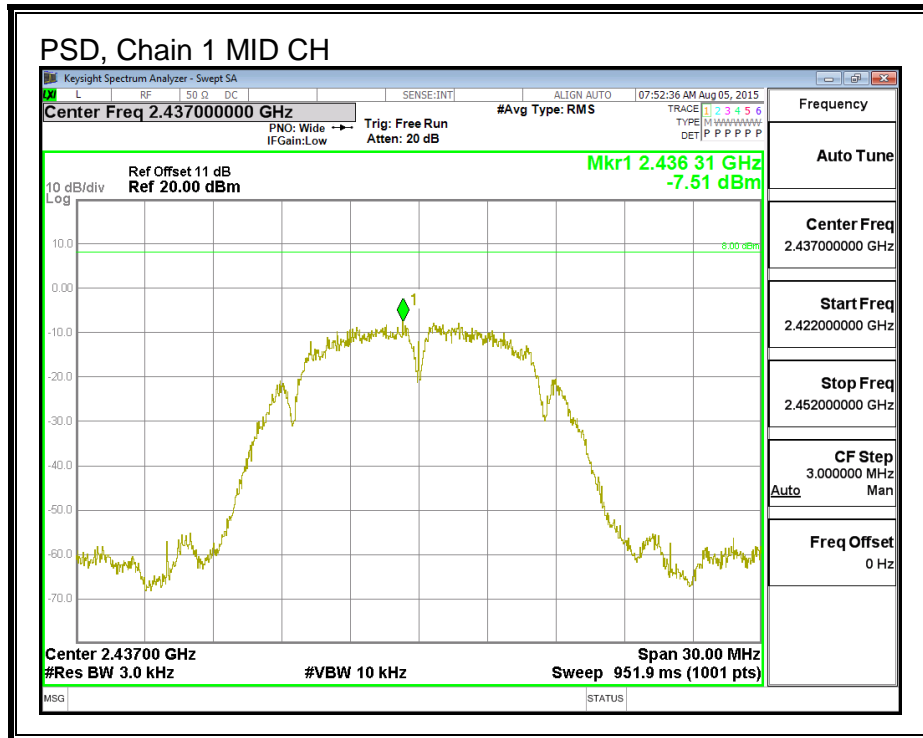

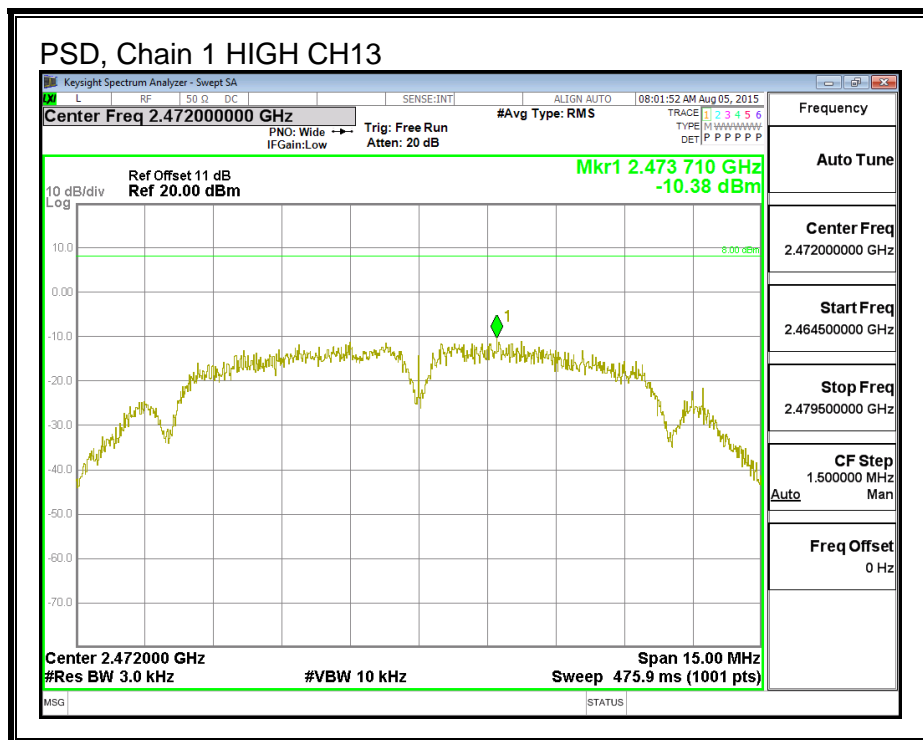
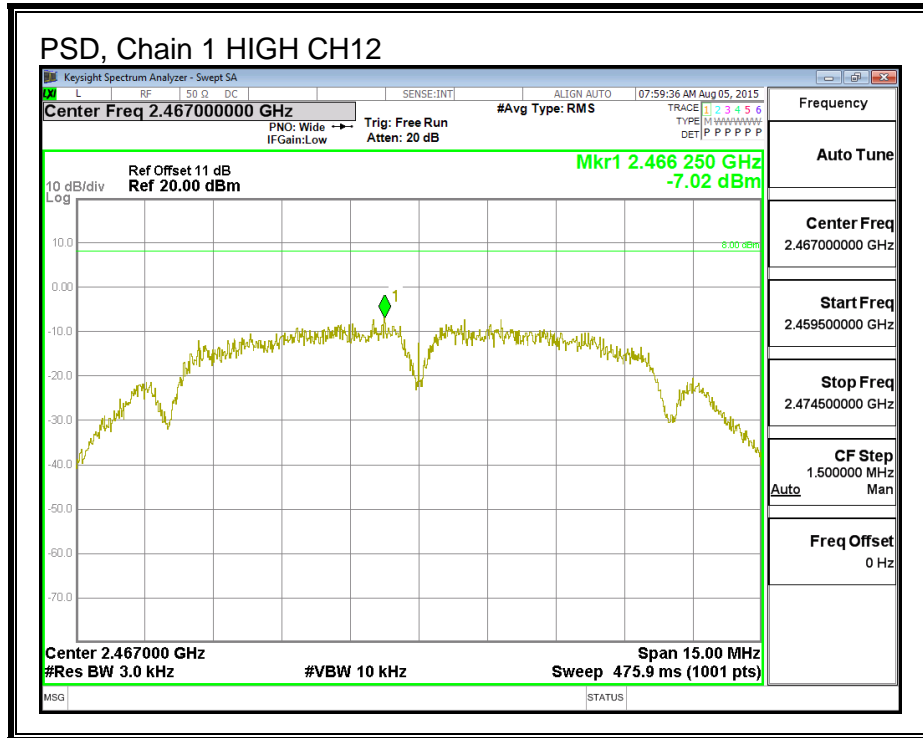

8.2.6. OUT-OF-BAND EMISSIONS

LIMITS

FCC §15.247 (d)

IC RSS-247 (5.5)

In any 100 kHz bandwidth outside the frequency band in which the spread spectrum or digitally modulated intentional radiator is operating, the radio frequency power that is produced by the intentional radiator shall be at least 20 dB below that in the 100 kHz bandwidth within the band that contains the highest level of the desired power, based on either an RF conducted or a radiated measurement, provided the transmitter demonstrates compliance with the peak conducted power limits. If the transmitter complies with the conducted power limits based on the use of RMS averaging over a time interval, as permitted under paragraph (b)(3) of this section, the attenuation required under this paragraph shall be 30 dB instead of 20 dB. Attenuation below the general limits specified in §15.209(a) is not required.

RESULTS for Chain 0

LOW CHANNEL BANDEDGE

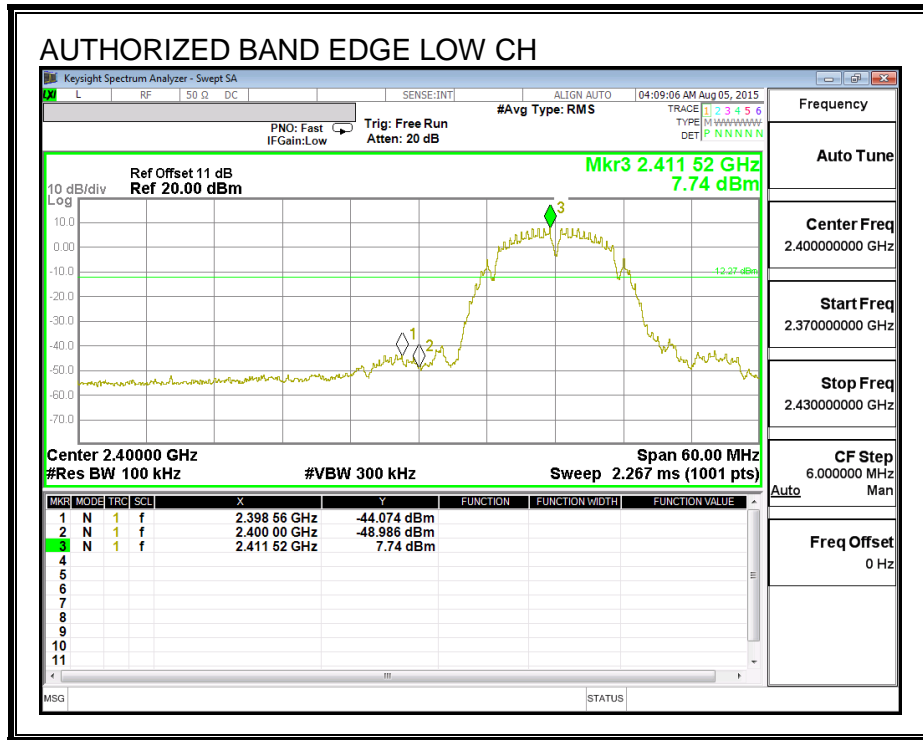

MID CHANNEL BANDEDGE

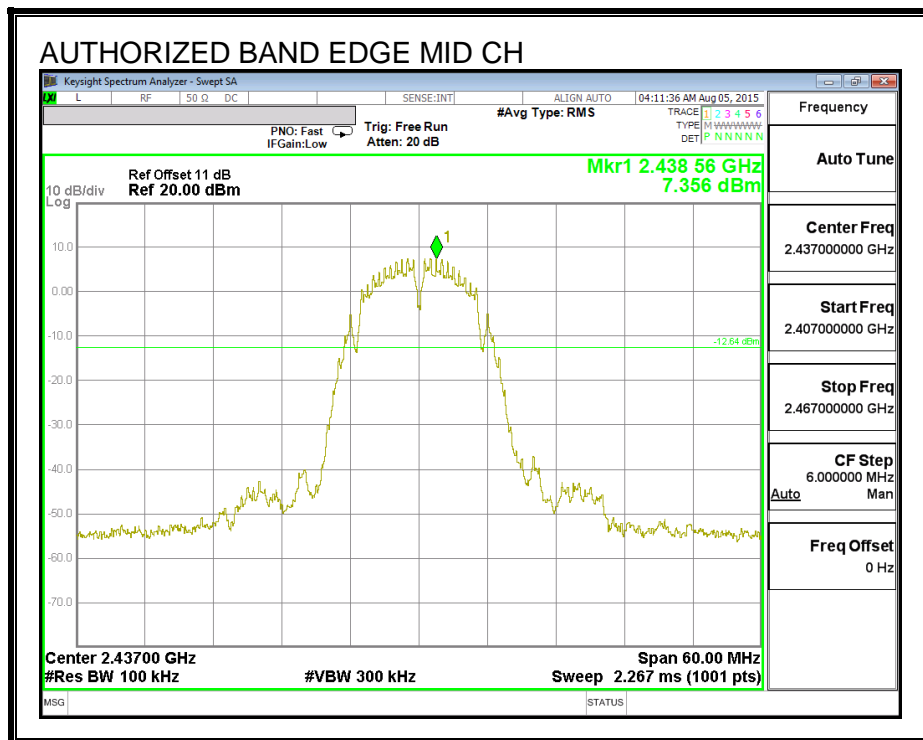

HIGH CHANNEL BANDEDGE

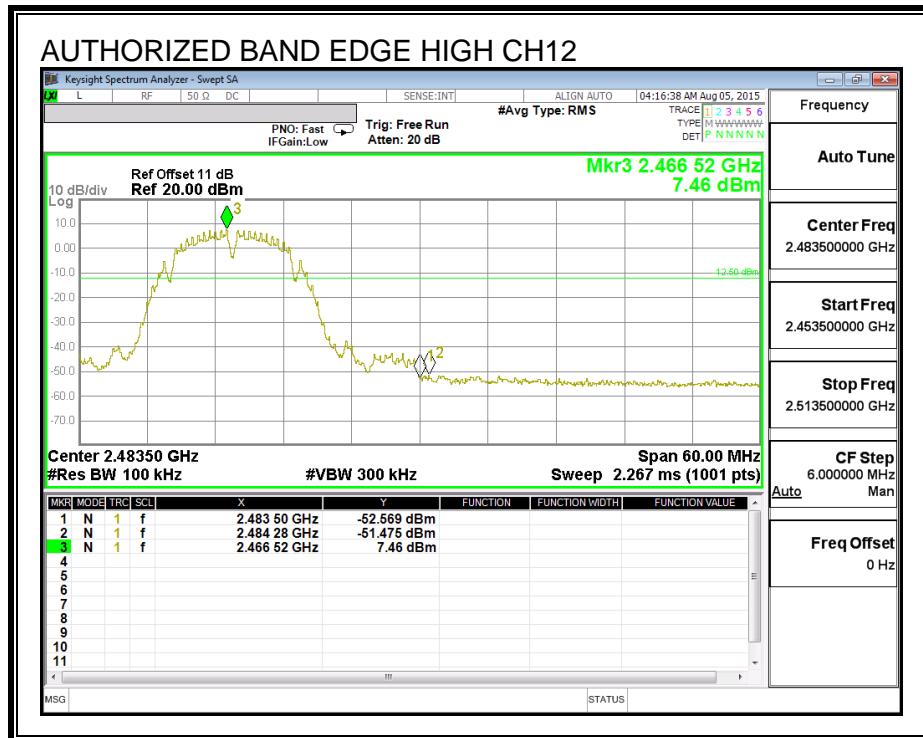
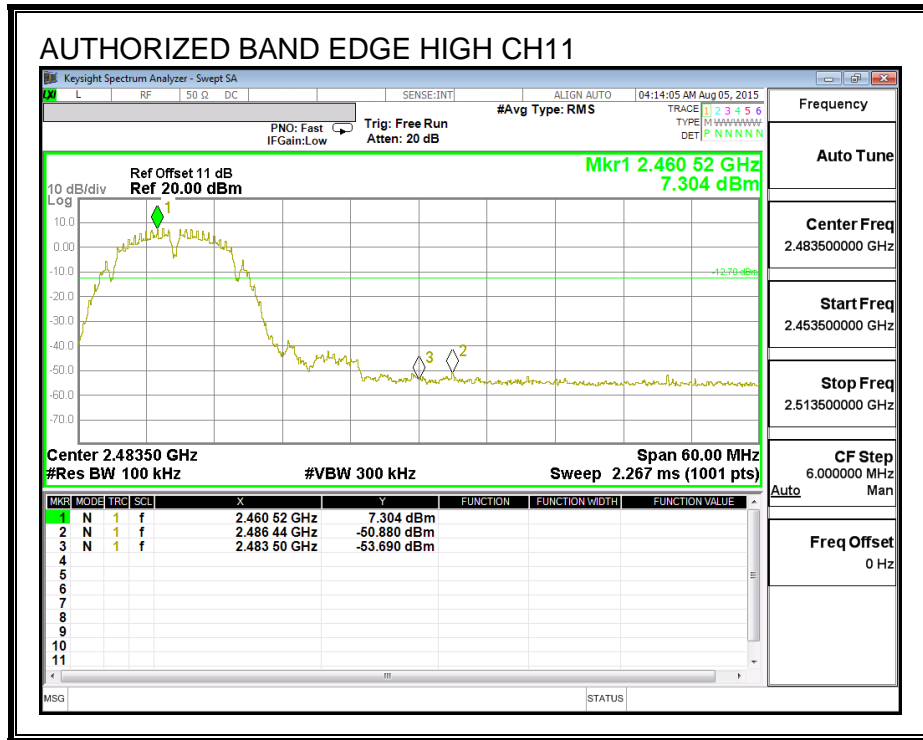

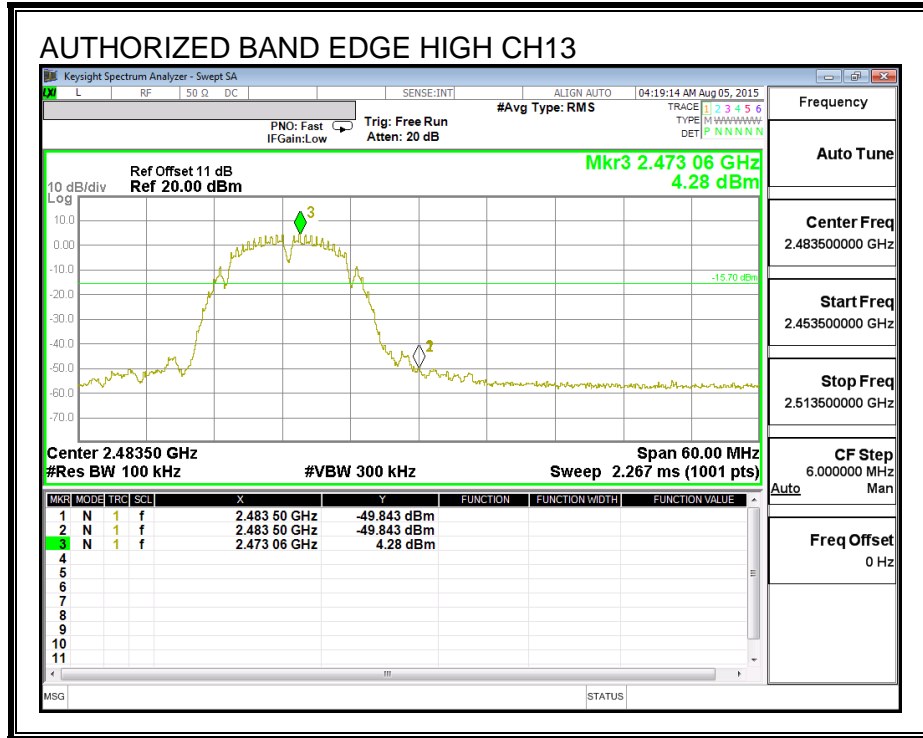

OUT-OF-BAND EMISSIONS

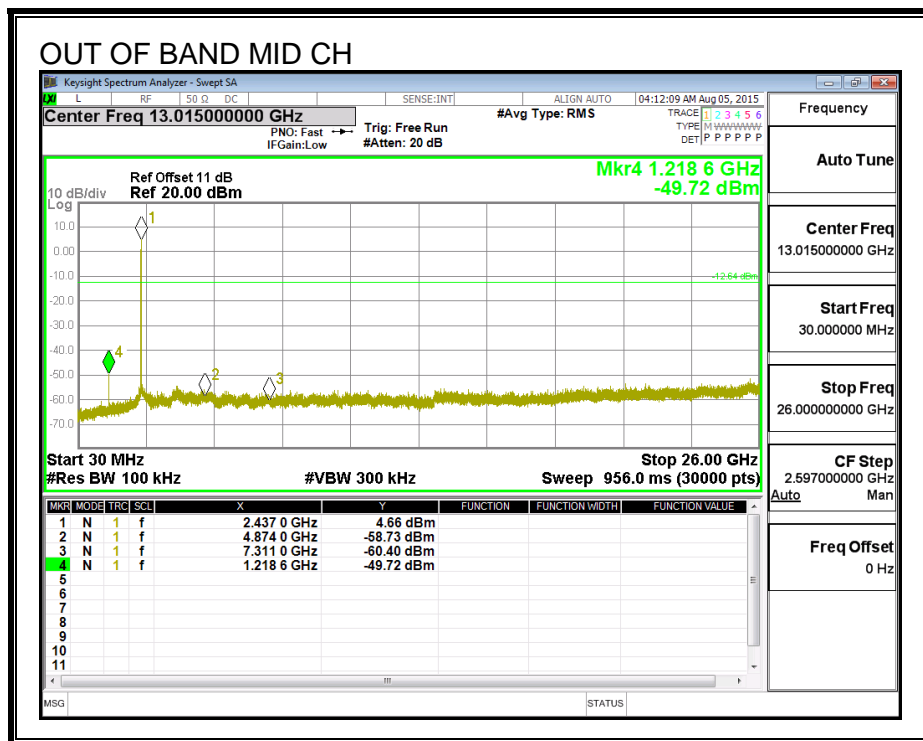
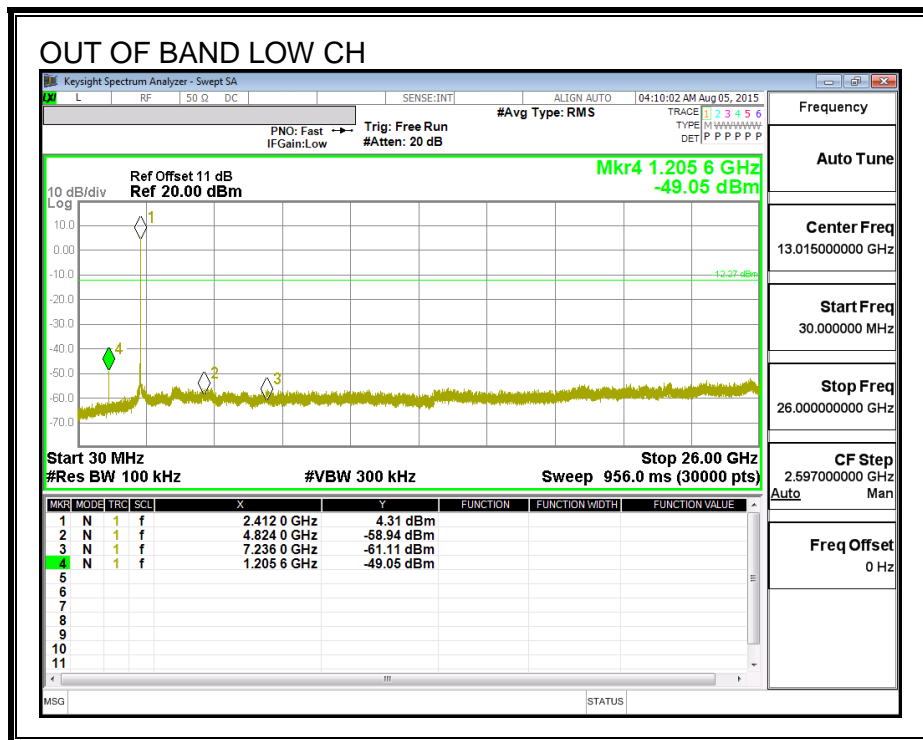

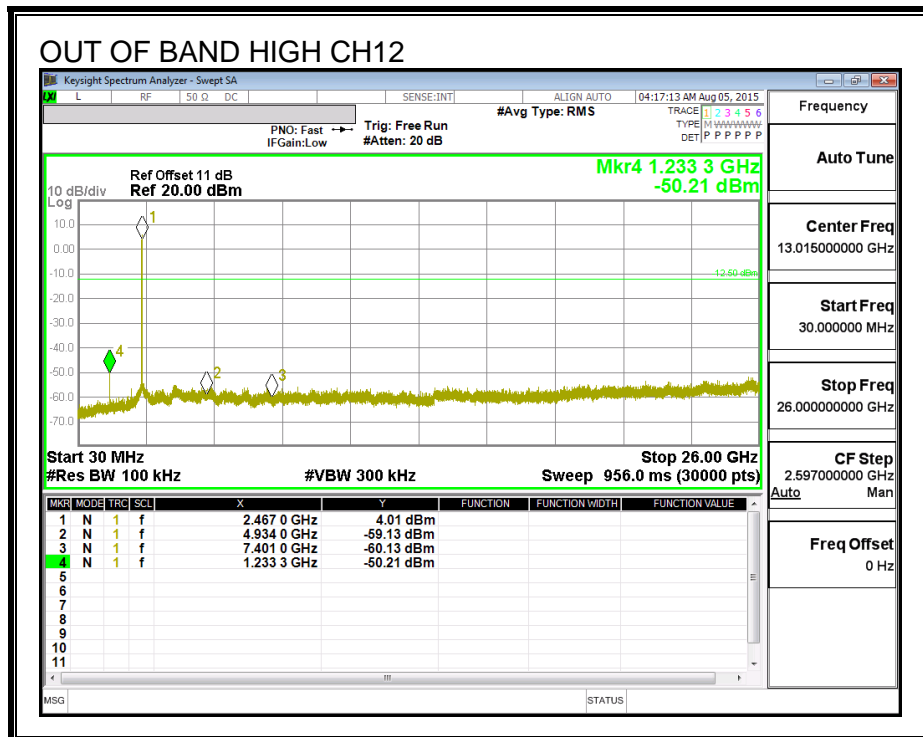
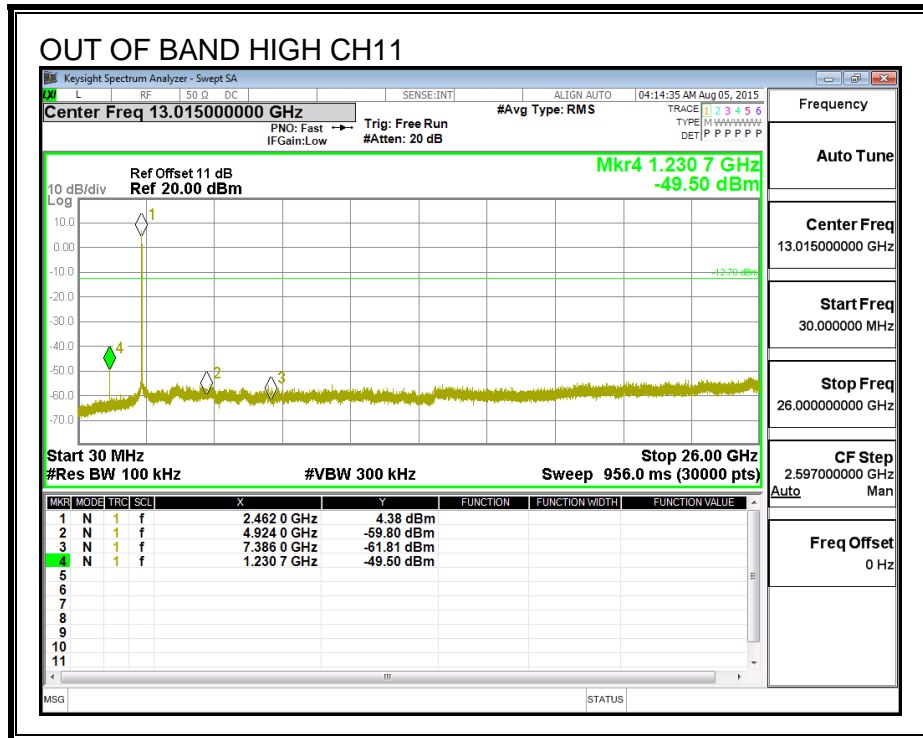

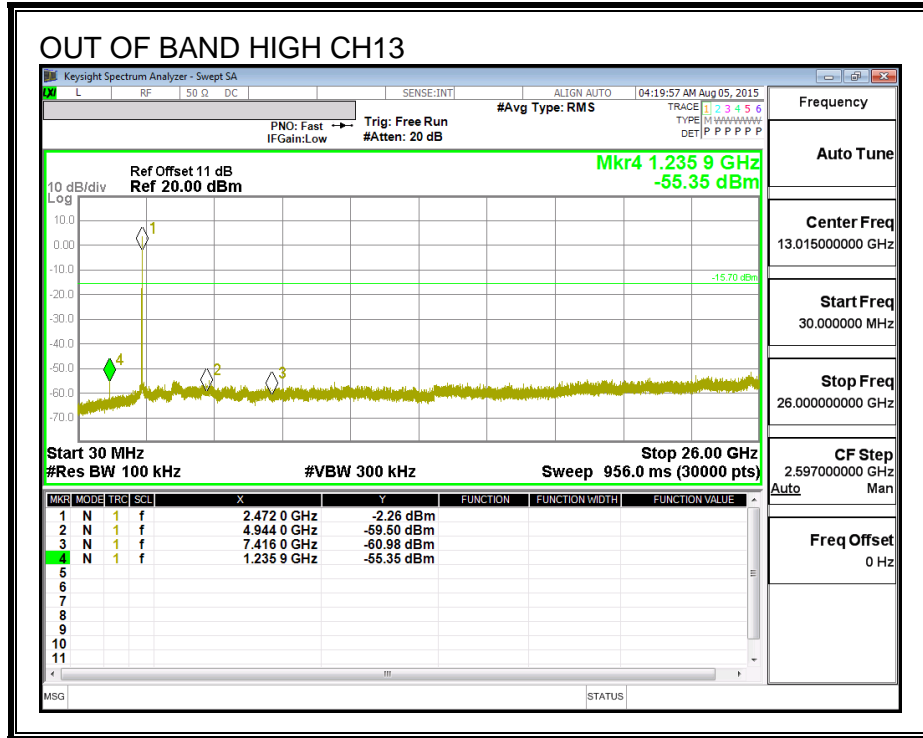

RESULTS for Chain 1

LOW CHANNEL BANDEDGE

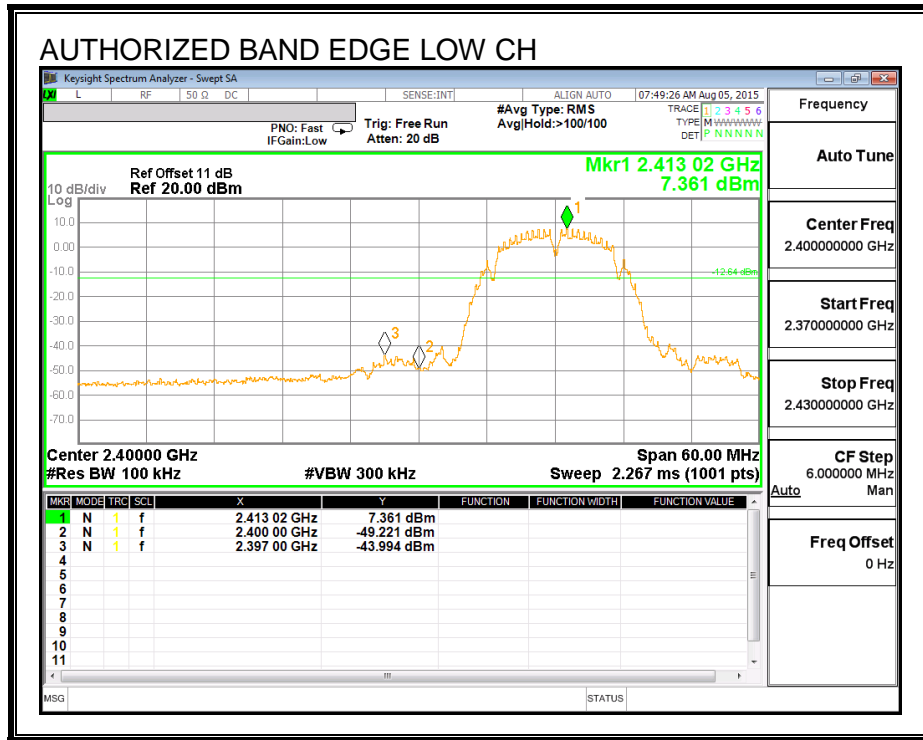

MID CHANNEL BANDEDGE

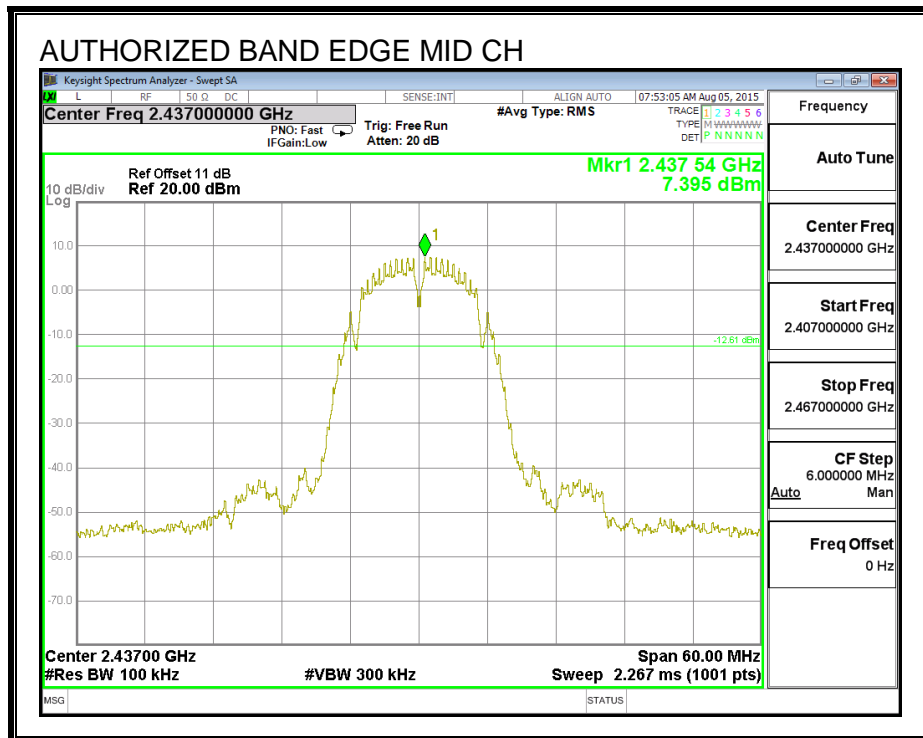

HIGH CHANNEL BANDEDGE

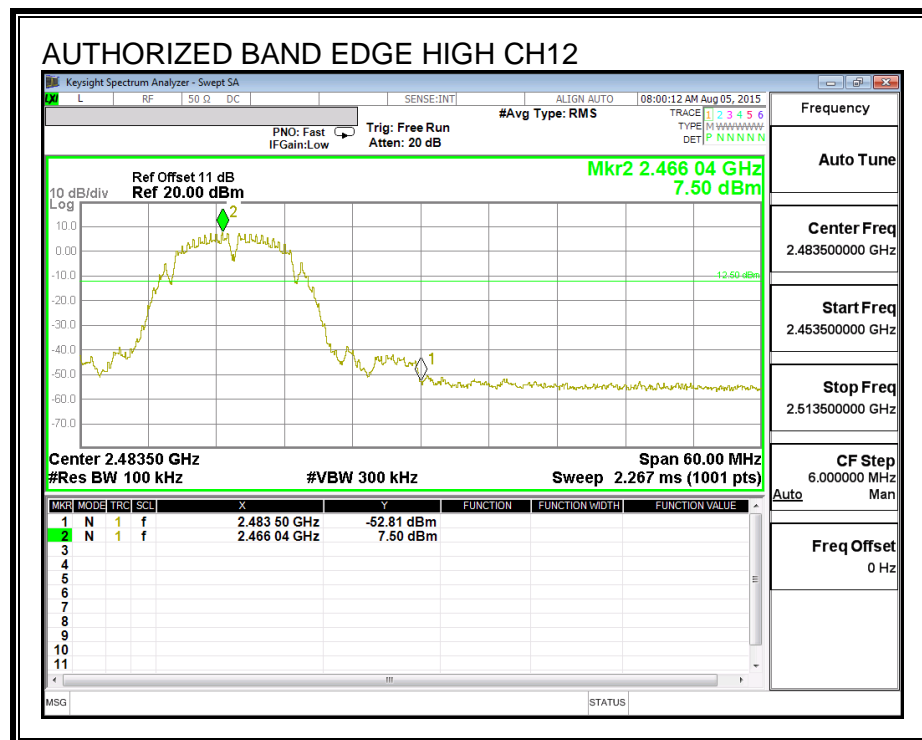
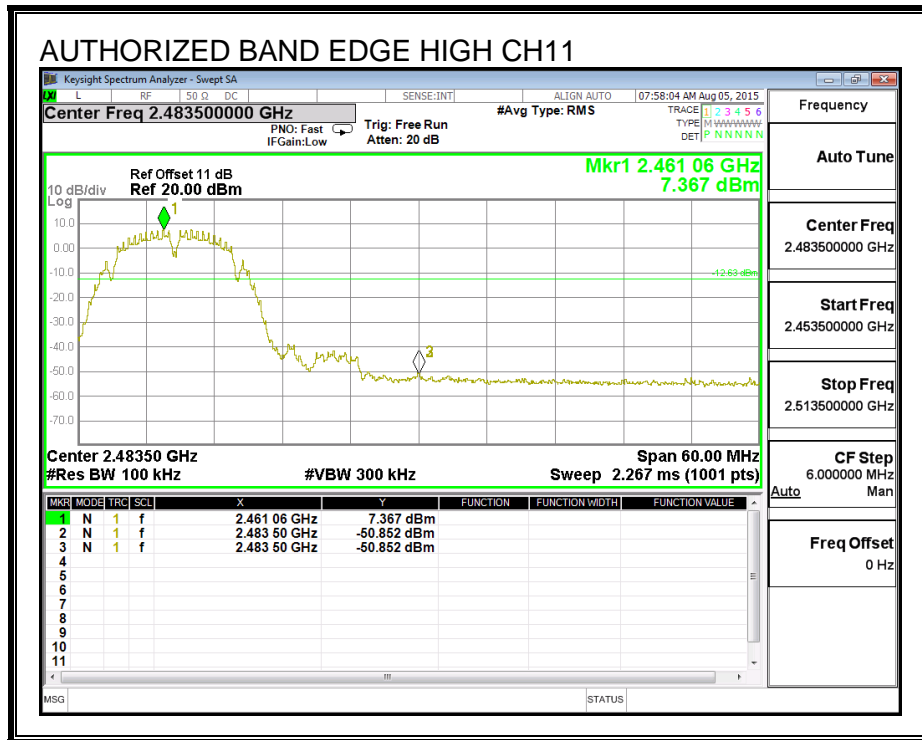

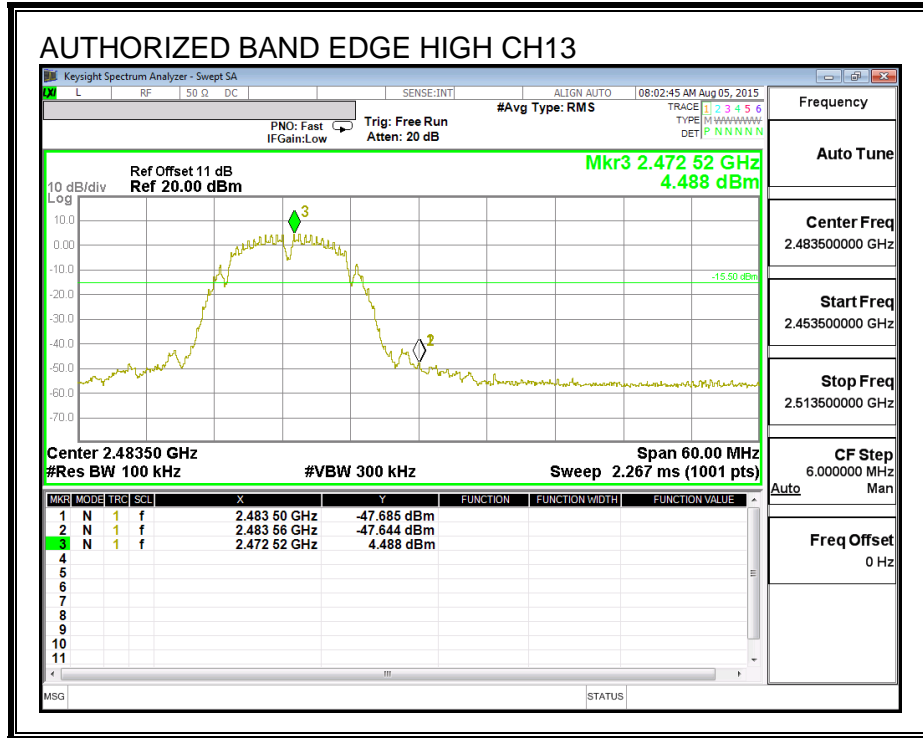

OUT-OF-BAND EMISSIONS

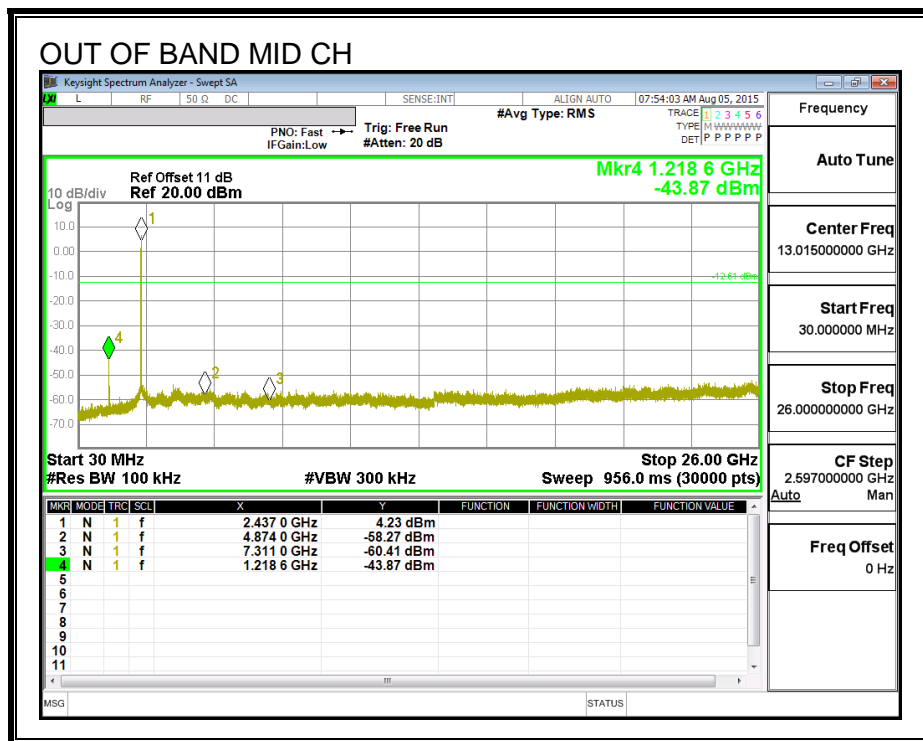
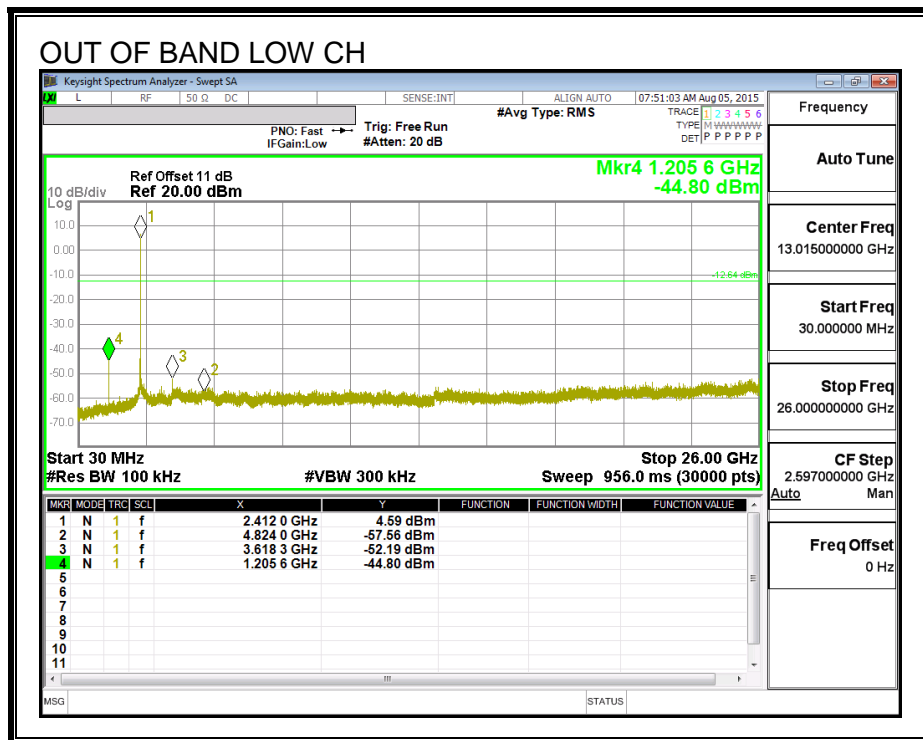

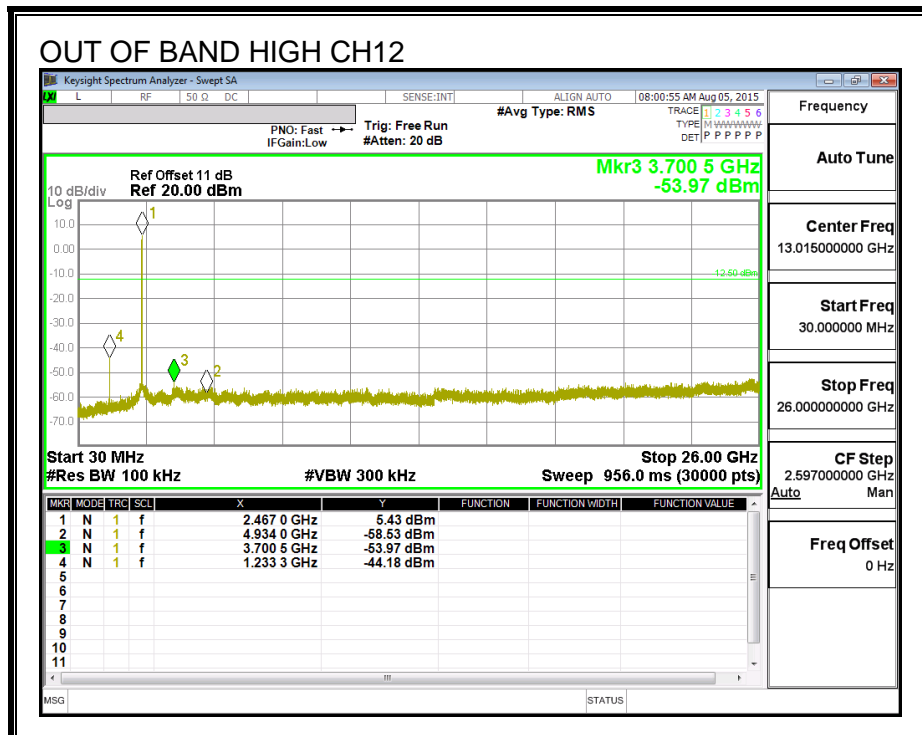
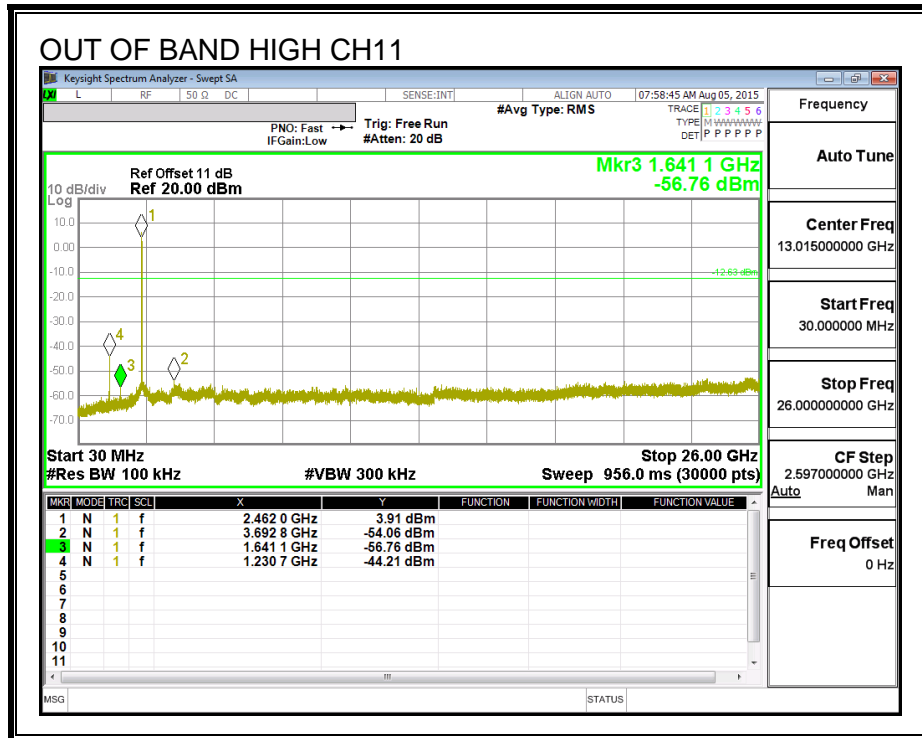

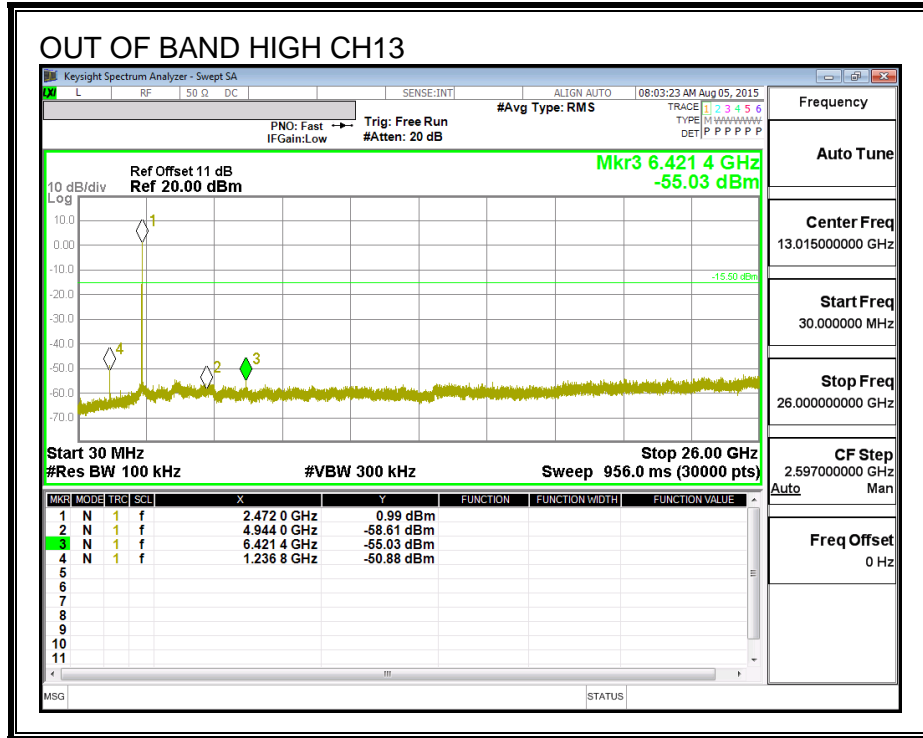

8.3. 802.11g SISO MODE IN THE 2.4 GHz BAND

Note: Covered by 802.11n HT20 SISO MODE.

8.4. 802.11g 2TX MODE IN THE 2.4 GHz BAND

Note: Covered by 802.11n HT20 2TX CDD MODE.