



**FCC 47 CFR PART 15 SUBPART C  
INDUSTRY CANADA RSS-247 ISSUE 1**

**CERTIFICATION TEST REPORT**

**FOR**

**TABLET DEVICE**

**MODEL NUMBER: A1584**

**FCC ID: BCGA1584**

**IC: 579C-A1584**

**REPORT NUMBER: 14U19185-E1V3**

**ISSUE DATE: SEPTEMBER 11, 2015**

*Prepared for*

**APPLE, INC.**

**1 INFINITE LOOP**

**CUPERTINO, CA 95014, U.S.A.**

*Prepared by*

**UL VERIFICATION SERVICES INC.**

**47173 BENICIA STREET**

**FREMONT, CA 94538, U.S.A.**

**TEL: (510) 771-1000**

**FAX: (510) 661-0888**

**NVLAP<sup>®</sup>**

**NVLAP LAB CODE 200065-0**

Revision History

<u>Rev.</u>	<u>Issue Date</u>	<u>Revisions</u>	<u>Revised By</u>
V1	09/03/2015	Initial Review	M. Mekuria
V2	09/08/2015	Addressed TCB Questions	E. Yu
V3	09/11/2015	Updated antenna gain	C. Pang

## TABLE OF CONTENTS

<b>1. ATTESTATION OF TEST RESULTS .....</b>	<b>5</b>
<b>2. TEST METHODOLOGY .....</b>	<b>6</b>
<b>3. FACILITIES AND ACCREDITATION .....</b>	<b>6</b>
<b>4. CALIBRATION AND UNCERTAINTY .....</b>	<b>7</b>
4.1. MEASURING INSTRUMENT CALIBRATION .....	7
4.2. SAMPLE CALCULATION .....	7
4.3. MEASUREMENT UNCERTAINTY.....	7
<b>5. EQUIPMENT UNDER TEST .....</b>	<b>8</b>
5.1. DESCRIPTION OF EUT .....	8
5.2. MAXIMUM OUTPUT POWER.....	8
5.3. DESCRIPTION OF AVAILABLE ANTENNAS .....	8
5.4. SOFTWARE AND FIRMWARE.....	8
5.5. WORST-CASE CONFIGURATION AND MODE.....	9
5.6. DESCRIPTION OF TEST SETUP.....	10
5.7. TEST AND MEASUREMENT EQUIPMENT.....	17
<b>6. ANTENNA PORT TEST RESULTS .....</b>	<b>18</b>
6.1. ON TIME AND DUTY CYCLE.....	18
6.2. BASIC DATA RATE GFSK MODULATION.....	20
6.2.1. 20 dB AND 99% BANDWIDTH .....	20
6.2.2. HOPPING FREQUENCY SEPARATION .....	23
6.2.3. NUMBER OF HOPPING CHANNELS.....	24
6.2.4. AVERAGE TIME OF OCCUPANCY .....	27
6.2.5. OUTPUT POWER .....	31
6.2.6. AVERAGE POWER.....	32
6.2.7. CONDUCTED SPURIOUS EMISSIONS.....	33
6.3. ENHANCED DATA RATE QPSK MODULATION.....	38
6.3.1. OUTPUT POWER .....	38
6.3.2. AVERAGE POWER.....	39
6.4. ENHANCED DATA RATE 8PSK MODULATION .....	40
6.4.1. 20 dB AND 99% BANDWIDTH .....	40
6.4.2. HOPPING FREQUENCY SEPARATION .....	43
6.4.3. NUMBER OF HOPPING CHANNELS.....	44
6.4.4. AVERAGE TIME OF OCCUPANCY .....	47
6.4.5. OUTPUT POWER .....	51
6.4.6. AVERAGE POWER.....	52
6.4.7. CONDUCTED SPURIOUS EMISSIONS.....	53
<b>7. RADIATED TEST RESULTS.....</b>	<b>58</b>
7.1. LIMITS AND PROCEDURE.....	58

---

7.2.	TRANSMITTER ABOVE 1 GHz .....	59
7.2.1.	BASIC DATA RATE GFSK MODULATION .....	59
7.2.2.	ENHANCED DATA RATE 8PSK MODULATION .....	69
7.3.	WORST CASE CO-LOCATION .....	79
7.4.	WORST-CASE BELOW 1 GHz.....	81
7.5.	WORST-CASE ABOVE 18 GHz .....	83
<b>8.</b>	<b>AC POWER LINE CONDUCTED EMISSIONS.....</b>	<b>85</b>
8.1.	EUT POWERED BY AC/DC ADAPTER VIA USB CABLE .....	86
8.2.	EUT POWERED BY HOST PC VIA USB CABLE .....	88
<b>9.</b>	<b>SETUP PHOTOS.....</b>	<b>90</b>

# 1. ATTESTATION OF TEST RESULTS

**COMPANY NAME:** APPLE, INC.  
1 INFINITE LOOP  
CUPERTINO, CA 95014, U.S.A.

**EUT DESCRIPTION:** TABLET DEVICE

**MODEL:** A1584

**SERIAL NUMBER:** DLXQ1005GPCT (Radiated); DLXQ1005GPCP (Conducted)

**DATE TESTED:** JULY 10, 2015 - AUGUST 19, 2015

APPLICABLE STANDARDS	
STANDARD	TEST RESULTS
CFR 47 Part 15 Subpart C	Pass
INDUSTRY CANADA RSS-247 Issue 1	Pass
INDUSTRY CANADA RSS-GEN Issue 4	Pass

UL Verification Services Inc. tested the above equipment in accordance with the requirements set forth in the above standards. All indications of Pass/Fail in this report are opinions expressed by UL Verification Services Inc. based on interpretations and/or observations of test results. Measurement Uncertainties were not taken into account and are published for informational purposes only. The test results show that the equipment tested is capable of demonstrating compliance with the requirements as documented in this report.

**Note:** The results documented in this report apply only to the tested sample, under the conditions and modes of operation as described herein. This document may not be altered or revised in any way unless done so by UL Verification Services Inc. and all revisions are duly noted in the revisions section. Any alteration of this document not carried out by UL Verification Services Inc. will constitute fraud and shall nullify the document. This report must not be used by the client to claim product certification, approval, or endorsement by NVLAP, NIST, any agency of the Federal Government, or any agency of any government.

Approved & Released For  
UL Verification Services Inc. By:

Tested By:



CHIN PANG  
SENIOR ENGINEER  
UL VERIFICATION SERVICES INC.

FRANCISCO GUARNERO  
EMC ENGINEER  
UL VERIFICATION SERVICES INC.

## 2. TEST METHODOLOGY

The tests documented in this report were performed in accordance with FCC CFR 47 Part 2, FCC CFR 47 Part 15, ANSI C63.10-2013, RSS-GEN Issue 4, and RSS-247 Issue 1.

## 3. FACILITIES AND ACCREDITATION

The test sites and measurement facilities used to collect data are located at 47173 and 47266 Benicia Street, Fremont, California, USA. Line conducted emissions are measured only at the 47173 address. The following table identifies which facilities were utilized for radiated emission measurements documented in this report. Specific facilities are also identified in the test results sections.

47173 Benicia Street	47266 Benicia Street
<input type="checkbox"/> Chamber A	<input checked="" type="checkbox"/> Chamber D
<input type="checkbox"/> Chamber B	<input type="checkbox"/> Chamber E
<input type="checkbox"/> Chamber C	<input type="checkbox"/> Chamber F
	<input checked="" type="checkbox"/> Chamber G
	<input type="checkbox"/> Chamber H

The above test sites and facilities are covered under FCC Test Firm Registration # 208313. Chambers A through H are covered under Industry Canada company address code 2324B with site numbers 2324B -1 through 2324B-8, respectively.

UL Verification Services Inc. is accredited by NVLAP, Laboratory Code 200065-0. The full scope of accreditation can be viewed at <http://ts.nist.gov/standards/scopes/2000650.htm>.

## 4. CALIBRATION AND UNCERTAINTY

### 4.1. MEASURING INSTRUMENT CALIBRATION

The measuring equipment utilized to perform the tests documented in this report has been calibrated in accordance with the manufacturer's recommendations, and is traceable to recognized national standards.

### 4.2. SAMPLE CALCULATION

Where relevant, the following sample calculation is provided:

$$\begin{aligned} \text{Field Strength (dBuV/m)} &= \text{Measured Voltage (dBuV)} + \text{Antenna Factor (dB/m)} + \\ &\text{Cable Loss (dB)} - \text{Preamp Gain (dB)} \\ 36.5 \text{ dBuV} + 18.7 \text{ dB/m} + 0.6 \text{ dB} - 26.9 \text{ dB} &= 28.9 \text{ dBuV/m} \end{aligned}$$

### 4.3. MEASUREMENT UNCERTAINTY

Where relevant, the following measurement uncertainty levels have been estimated for tests performed on the apparatus:

PARAMETER	UNCERTAINTY
Conducted Disturbance, 0.15 to 30 MHz	±3.52 dB
Radiated Disturbance, 30 to 1000 MHz	±4.94 dB

Uncertainty figures are valid to a confidence level of 95%.

## 5. EQUIPMENT UNDER TEST

### 5.1. DESCRIPTION OF EUT

The EUT is a tablet with multimedia functions (music, application support, and video), IEEE 802.11a/b/g/n/ac radio, and Bluetooth radio. The rechargeable battery is not user accessible.

### 5.2. MAXIMUM OUTPUT POWER

The transmitter has a maximum peak conducted output power as follows:

Frequency Range (MHz)	Mode	Output Power (dBm)	Output Power (mW)
2402 - 2480	Basic GFSK	10.22	10.52
2402 - 2480	DQPSK	11.98	15.78
2402 - 2480	Enhanced 8PSK	12.02	15.92

### 5.3. DESCRIPTION OF AVAILABLE ANTENNAS

Frequency Band (GHz)	Antenna Gain
2.4	-0.60

### 5.4. SOFTWARE AND FIRMWARE

The software installed in the EUT during testing was 13B72.



## 5.5. WORST-CASE CONFIGURATION AND MODE

Radiated emission and power line conducted emission were performed with the EUT set to transmit at the channel with highest output power as worst-case scenario.

The fundamental of the EUT was investigated in three orthogonal orientations X/Y/Z, it was determined that Y (Landscape) orientation was worst-case orientation. Therefore, all final radiated testing was performed with the EUT in Y orientation.

Worst-case data rates were:

GFSK mode: DH5  
8PSK mode: 3-DH5

DQPSK mode has been verified to have the lowest power.

For simultaneous transmission of multiple channels from the same antenna in BT/BLE and WLAN 5 GHz bands. Baseline testing was performed on various configurations to determine the worst case on radiated emissions.

The following configurations were investigated on AC line conducted test.

Configuration	Descriptions
1	EUT powered by AC/DC adapter via USB cable
2	EUT powered by host PC via USB cable

There are two vendors of the WiFi/Bluetooth radio modules: variant 1 and variant 2 and they have the same mechanical outline, same on board antenna, matching circuit, antenna structure and same specification. Baseline testing was performed on all two variants to determine the worst case on all conducted power and radiated emissions.

## 5.6. DESCRIPTION OF TEST SETUP

### SUPPORT EQUIPMENT

Support Equipment List				
Description	Manufacturer	Model	Serial Number	FCC ID
Laptop AC/DC adapter	Lenovo	92P1160	11S92P1160Z1ZBGH798B12	N/A
Laptop	Lenovo	7659	L3-AL664 08/03	N/A
Earphone	Apple	N/A	N/A	N/A
EUT AC/CD adapter	Apple	A1385	D293062F3WVDHLHCF	N/A

### I/O CABLES (CONDUCTED TEST)

I/O Cable List						
Cable No	Port	# of identical ports	Connector Type	Cable Type	Cable Length (m)	Remarks
1	Antenna	1	SMA	Un-Shielded	0.2	To spectrum Analyzer
2	USB	1	USB	Shielded	1	N/A
3	AC	1	AC	Un-shielded	3	N/A

### I/O CABLES (RADIATED ABOVE 1 GHZ)

I/O Cable List						
Cable No	Port	# of identical ports	Connector Type	Cable Type	Cable Length (m)	Remarks
None Used						

### I/O CABLES (RADAITED BELOW 1 GHZ)

I/O Cable List						
Cable No	Port	# of identical ports	Connector Type	Cable Type	Cable Length (m)	Remarks
1	Headphones Jack	1	3.5mm Audio	Shielded	0.9	N/A
2	AC	1	AC	Un-shielded	3	N/A

**I/O CABLES (AC LINE CONDUCTED: AC/DC ADAPTER)**

I/O Cable List						
Cable No	Port	# of identical ports	Connector Type	Cable Type	Cable Length (m)	Remarks
1	Headphones Jack	1	3.5mm Audio	Shielded	0.9	N/A
2	AC	1	AC	Un-shielded	3	N/A

**I/O CABLES (AC LINE CONDUCTED: LAPTOP CONFIGUARTION)**

I/O Cable List						
Cable No	Port	# of identical ports	Connector Type	Cable Type	Cable Length (m)	Remarks
1	Headphones Jack	1	3.5mm Audio	Shielded	0.9	N/A
2	USB	1	USB	Shielded	1	N/A
3	AC	1	AC	Un-shielded	3	N/A

**TEST SETUP - CONDUCTED TESTS**

The EUT was tested connected to a host Laptop via USB cable adapter and spectrum analyzer to antenna port. Test software exercised the EUT.

**SETUP DIAGRAM**

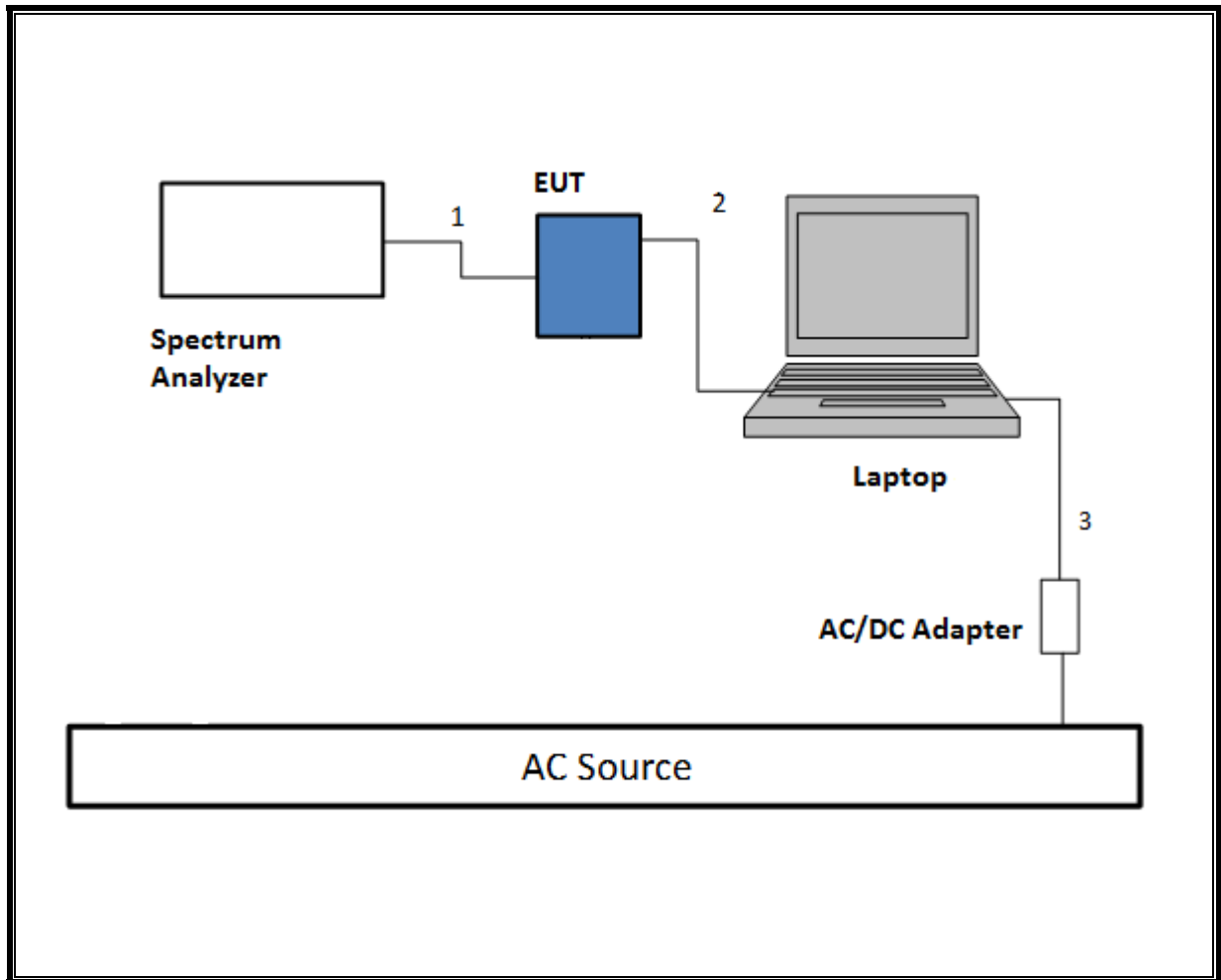

**TEST SETUP- RADIATED-ABOVE 1 GHZ**

The EUT was tested battery powered. Test software exercised the EUT.

**SETUP DIAGRAM**

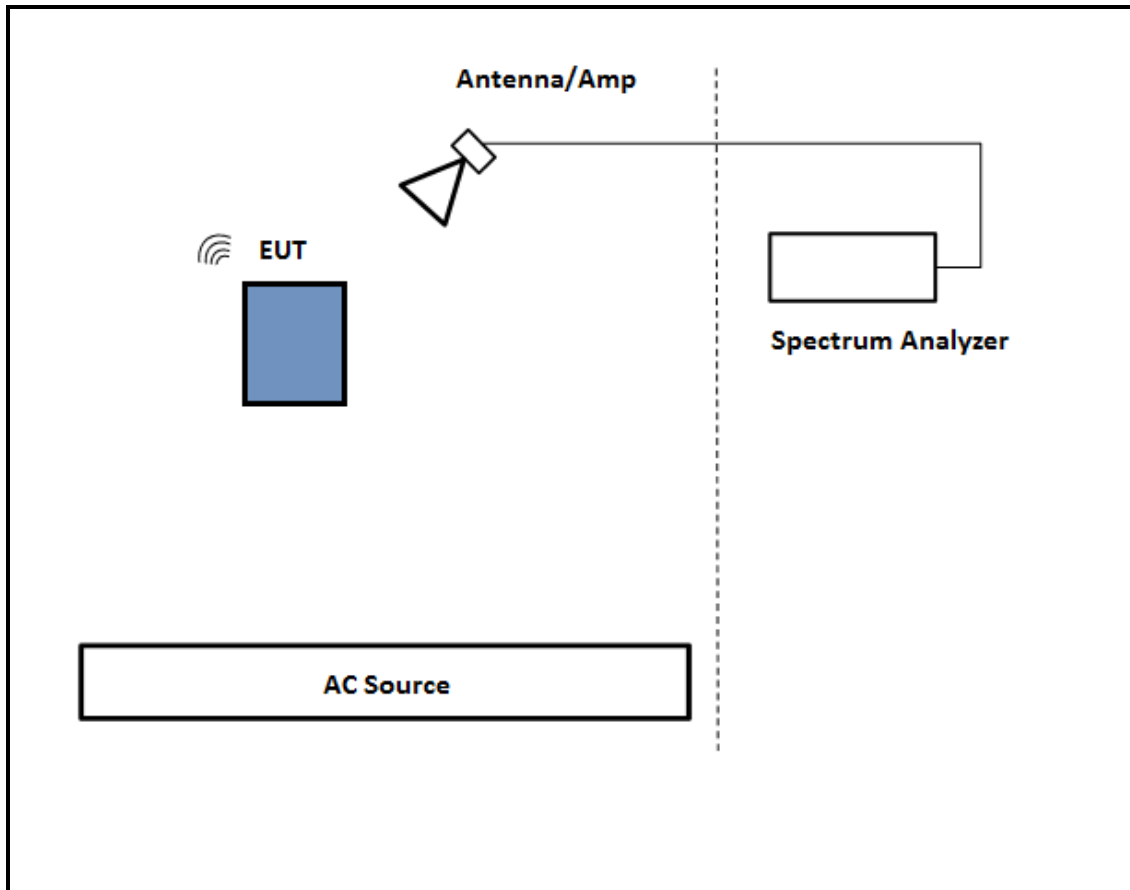

**TEST SETUP- BELOW 1GHz**

The EUT was tested with earphone connected and powered by AC adapter. Test software exercised the EUT.

**SETUP DIAGRAM**

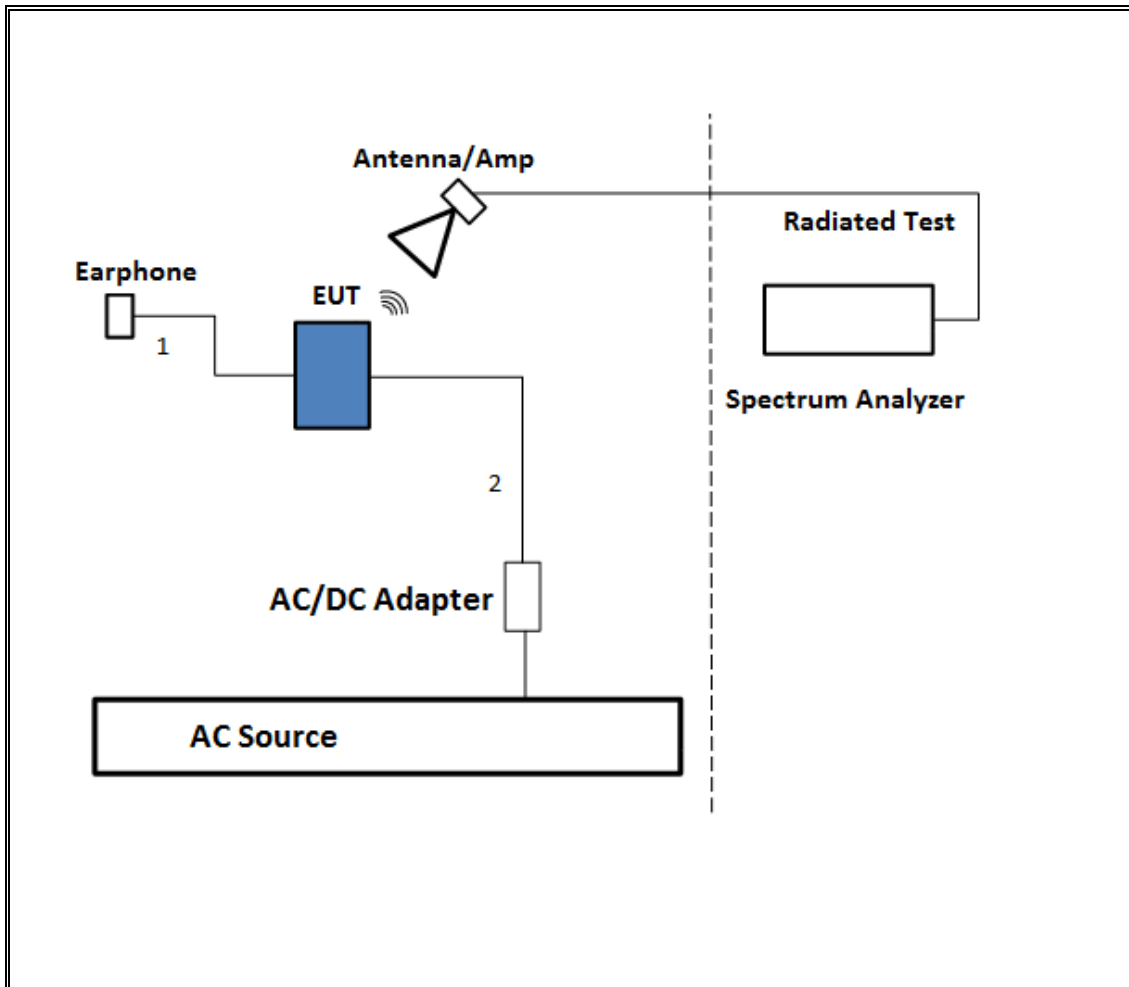

**TEST SETUP- AC LINE CONDUCTED: AC/DC ADAPTER**

The EUT was tested with earphone connected and powered by AC/DC adapter via USB cable. Test software exercised the EUT.

**SETUP DIAGRAM**

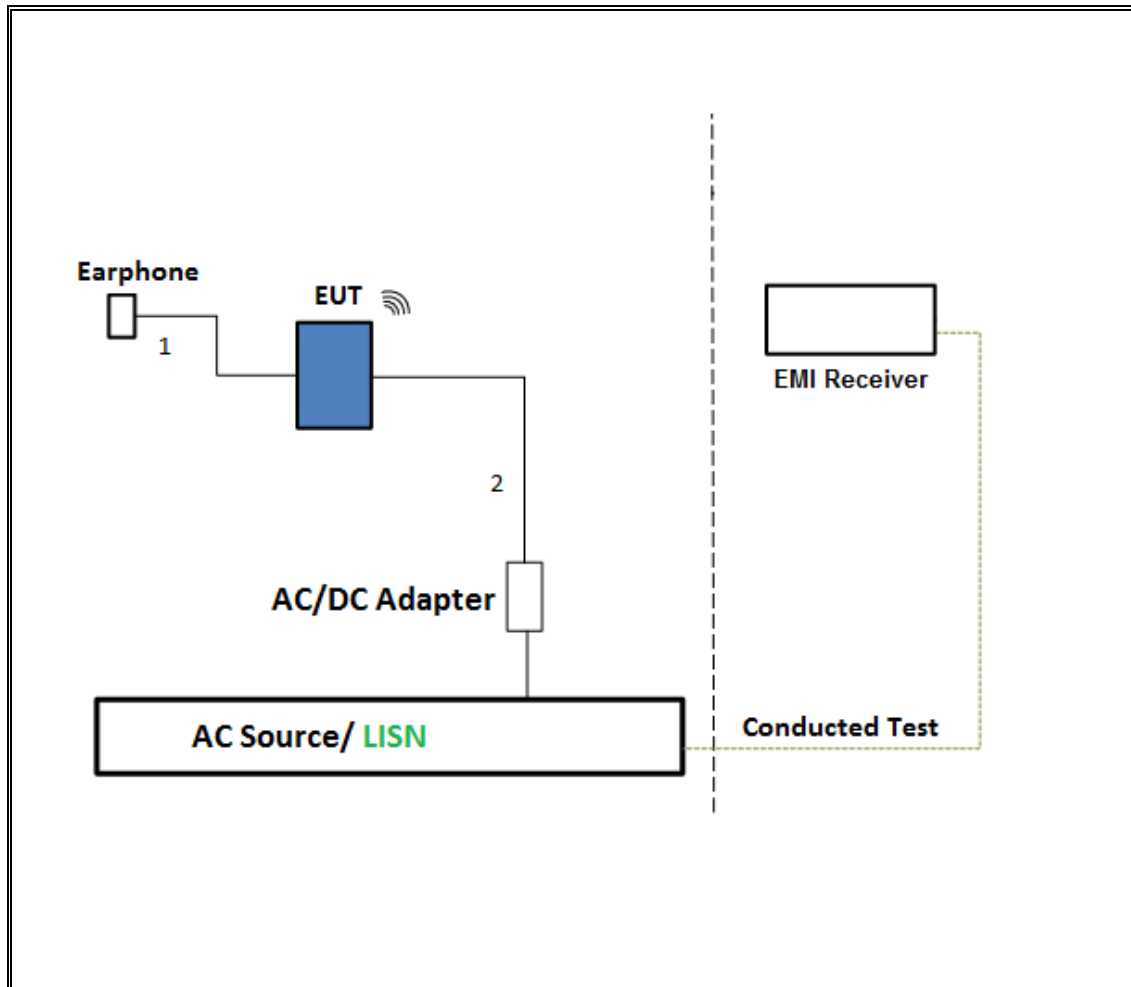

**TEST SETUP- AC LINE CONDUCTED: LAPTOP CONFIGURATION**

The EUT was tested with earphone connected and powered by host PC via USB cable. Test software exercised the EUT.

**SETUP DIAGRAM**

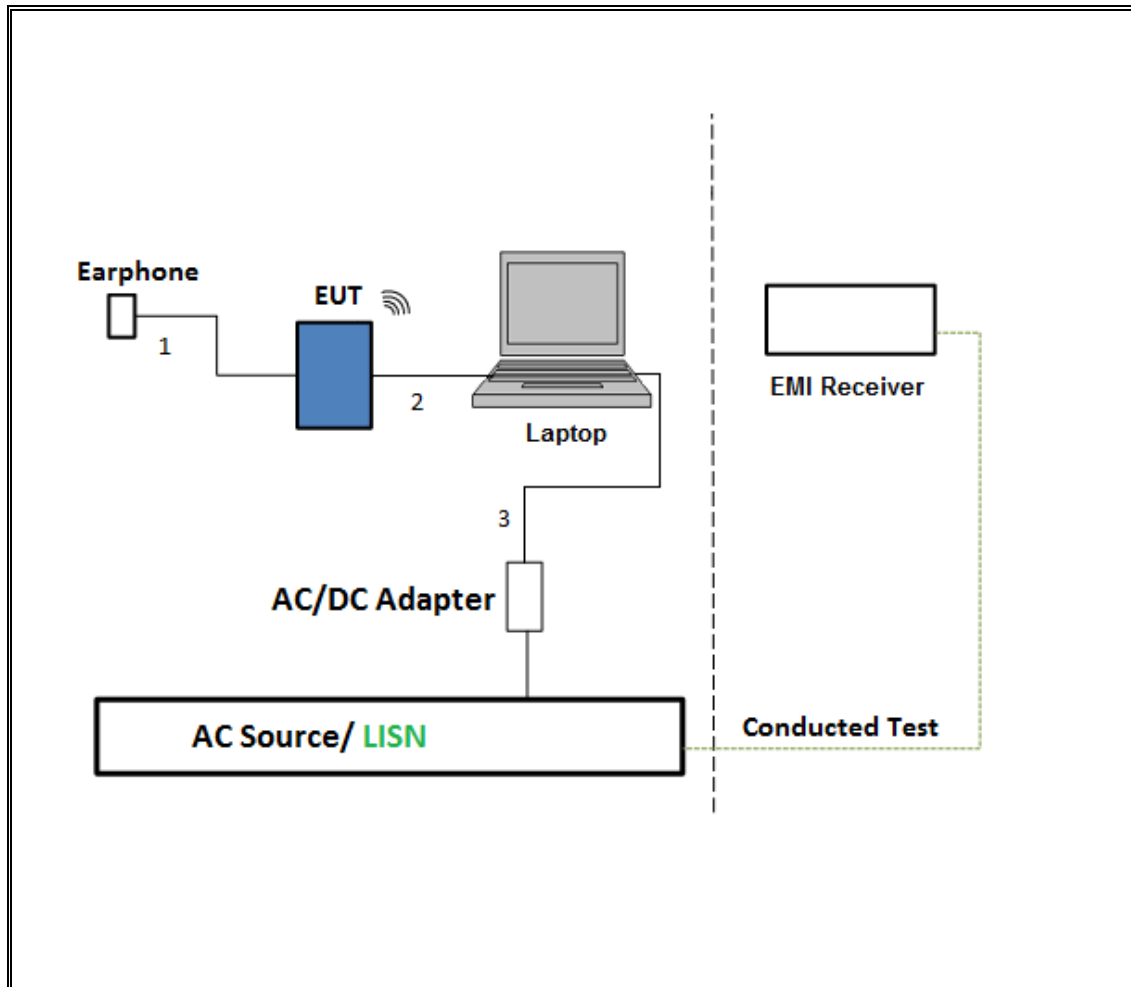



## 5.7. TEST AND MEASUREMENT EQUIPMENT

The following test and measurement equipment was utilized for the tests documented in this report:

Test Equipment List				
Description	Manufacturer	Model	Asset	Cal Due
Antenna, Horn 1-18GHz	ETS Lindgren	3117	00143448	2/10/2016
Antenna, Broadband Hybrid, 30MHz to 2000MHz	Sunol Sciences	JB3	A022813-1	1/14/2016
Amplifier, 1 - 18GHz	Miteq	AFS42-00101800-25-S-42	1782158	1/26/2016
Amplifier, 10KHz to 1GHz, 32dB	Sonoma	310N	171202	11/1/2015
Spectrum Analyzer, PXA, 3Hz to 50GHz	Agilent	N9030A	MY52350427	9/13/2015
Amplifier, 10KHz to 1GHz, 32dB	Sonoma	310N	325118	2/14/2016
Spectrum Analyzer, PXA, 3Hz to 44GHz	Agilent	N9030A	MY52350675	3/16/2016
Power Meter, P-series single channel	Agilent	N1911A	GB45100212	10/9/2015
Power Sensor, P - series, 50MHz to 18GHz, Wideband	Agilent	N1921A	MY53260010	4/7/2016
Antenna, Horn 18 to 26.5GHz	ARA	MWH-1826	1049	12/17/2015
Amplifier, 1 to 26.5GHz, 23.5dB Gain minimum	Agilent	8449B	3008A01114	10/4/2015
Amplifier, 26 to 40GHz	Miteq	NSP4000-SP2	1029	9/3/2015
AC Line Conducted				
EMI Test Receiver 9Khz-7GHz	Rohde & Schwarz	ESCI7	100935	9/16/2015
LISN for Conducted Emissions CISPR-16	FCC	50/250-25-2	114	1/16/2016
Power Cable, Line Conducted Emissions ANSI 63.4	U L	PG1	N/A	7/28/2015
UL SOFTWARE				
*Radiated Software	UL	UL EMC	Ver 9.5, July 22, 2014	
*Conducted Software	UL	UL EMC	Ver 2.2, March 31, 2015	
*AC Line Conducted Software	UL	UL EMC	Ver 9.5, April 3, 2015	

Note: \* indicates automation software version used in the compliance certification testing

## 6. ANTENNA PORT TEST RESULTS

### 6.1. ON TIME AND DUTY CYCLE

#### LIMITS

None; for reporting purposes only.

#### PROCEDURE

KDB 558074 Zero-Span Spectrum Analyzer Method.

#### ON TIME AND DUTY CYCLE RESULTS

Mode	ON Time B (msec)	Period (msec)	Duty Cycle x (linear)	Duty Cycle (%)	Duty Cycle Correction Factor (dB)	1/B Minimum VBW (kHz)
Bluetooth GFSK	100.000	100.000	1.000	100.00%	0.00	0.010
Bluetooth 8PSK	100.000	100.000	1.000	100.00%	0.00	0.010

### DUTY CYCLE PLOTS

#### HOPPING OFF

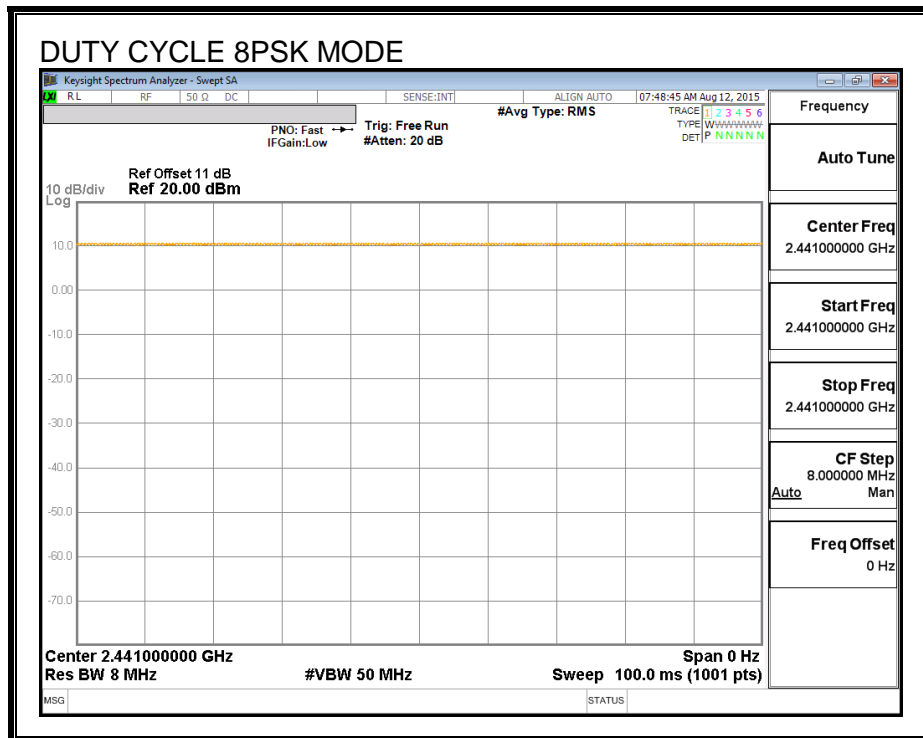
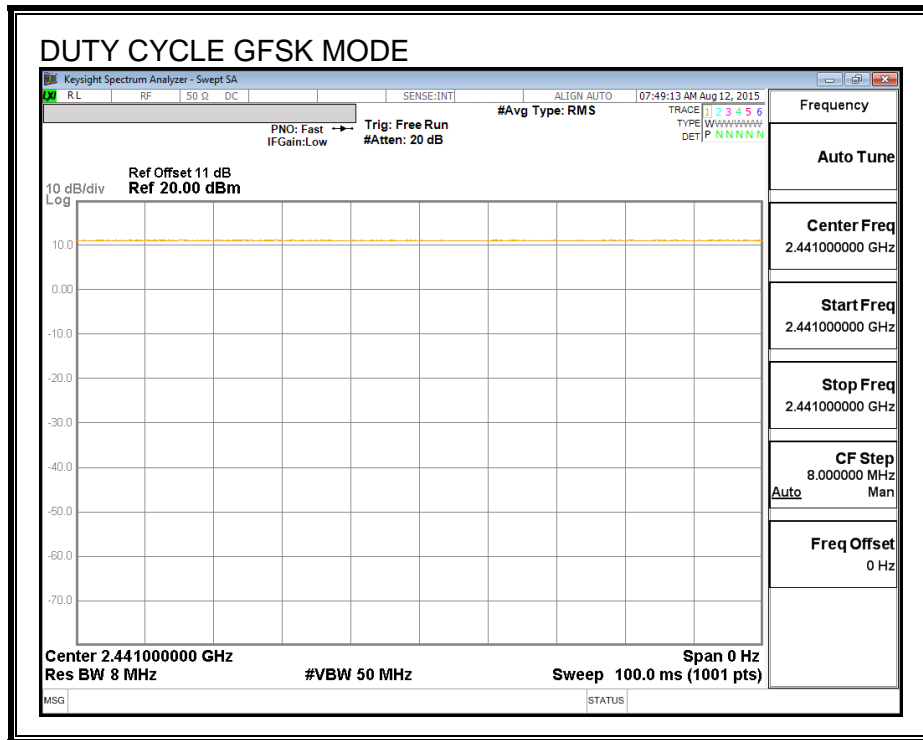

## 6.2. BASIC DATA RATE GFSK MODULATION

### 6.2.1. 20 dB AND 99% BANDWIDTH

#### LIMIT

None; for reporting purposes only.

#### TEST PROCEDURE

The transmitter output is connected to a spectrum analyzer. The RBW is set to  $\geq 1\%$  of the 20 dB bandwidth. The VBW is set to  $\geq$  RBW. The sweep time is coupled.

#### RESULTS

Channel	Frequency (MHz)	20 dB Bandwidth (KHz)	99% Bandwidth (KHz)
Low	2402	911.4	888.47
Middle	2441	920.9	901.40
High	2480	928.5	900.83

**20 dB AND 99% BANDWIDTH**

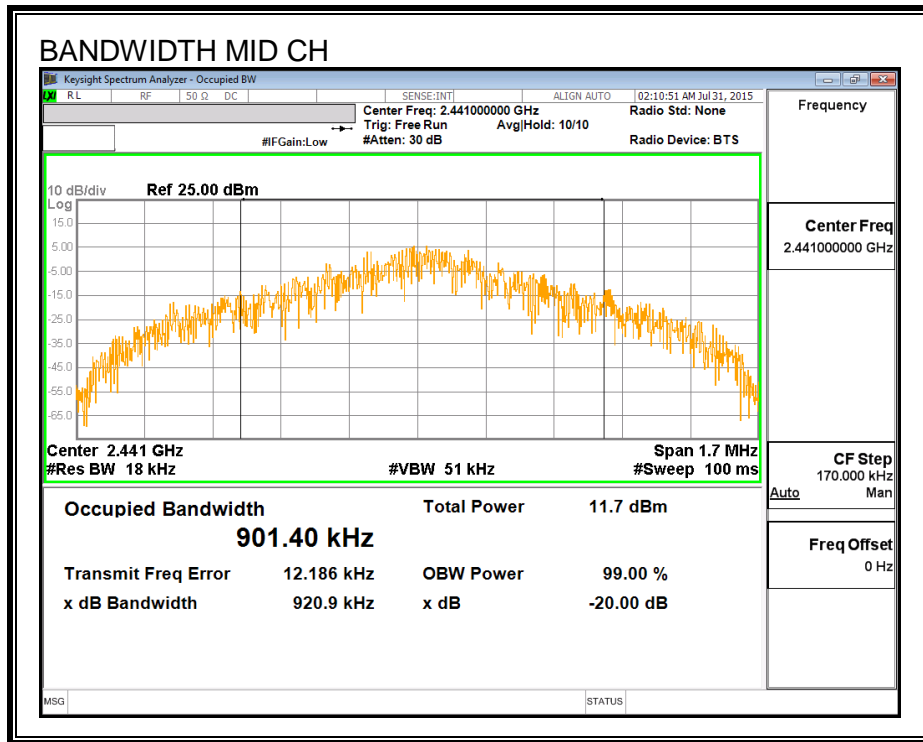
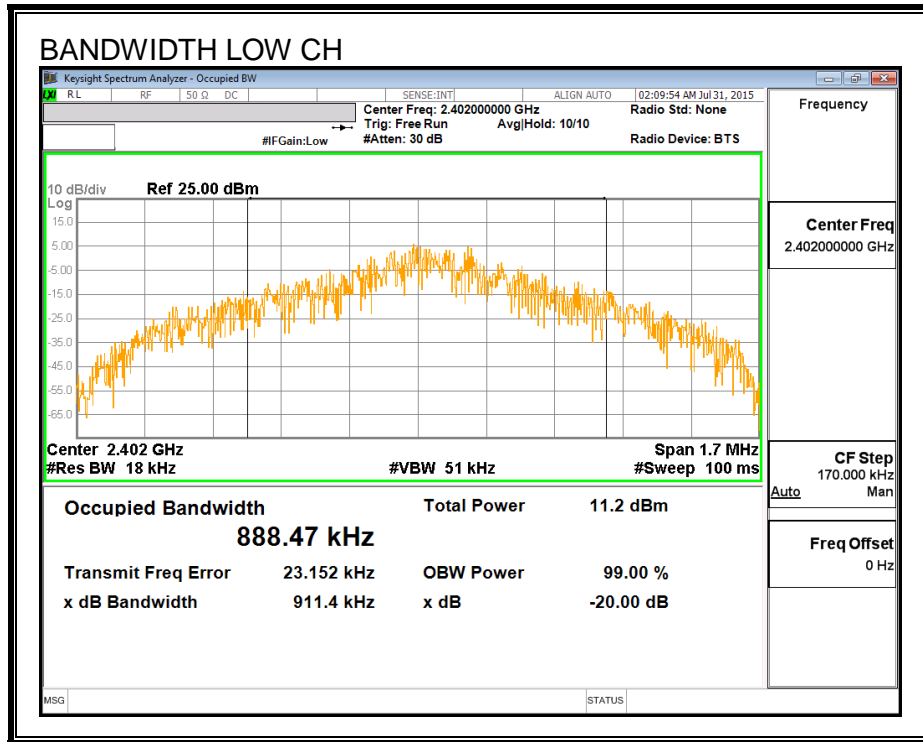

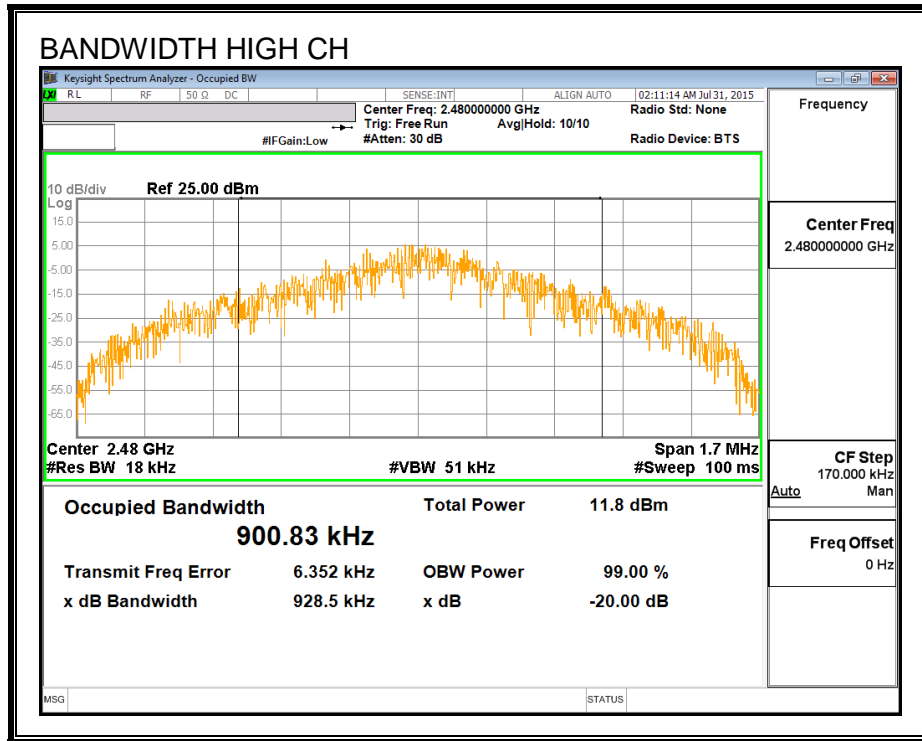

## 6.2.2. HOPPING FREQUENCY SEPARATION

### LIMIT

FCC §15.247 (a) (1)

IC RSS-247 (5.1) (2)

Frequency hopping systems shall have hopping channel carrier frequencies separated by a minimum of 25 kHz or the 20 dB bandwidth of the hopping channel, whichever is greater.

Alternatively, frequency hopping systems operating in the 2400-2483.5 MHz band may have hopping channel carrier frequencies that are separated by 25 kHz or two-thirds of the 20 dB bandwidth of the hopping channel, whichever is greater, provided the systems operate with an output power no greater than 125 mW.

### TEST PROCEDURE

The transmitter output is connected to a spectrum analyzer. The RBW is set to 300 kHz and the VBW is set to 910 kHz. The sweep time is coupled.

### RESULTS

#### HOPPING FREQUENCY SEPARATION

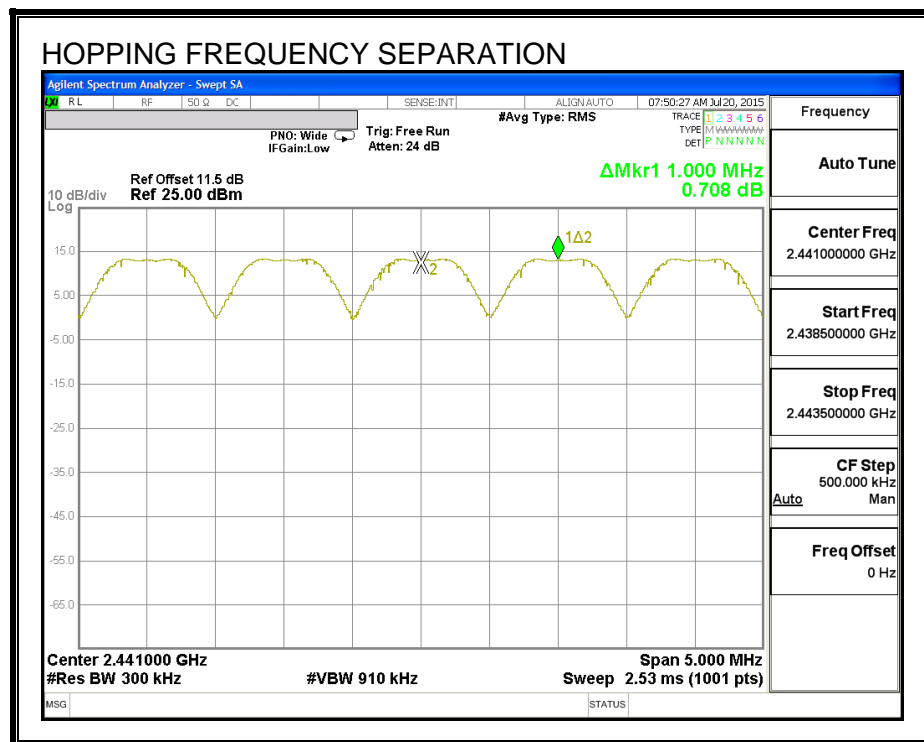

### **6.2.3. NUMBER OF HOPPING CHANNELS**

#### **LIMIT**

FCC §15.247 (a) (1) (iii)

IC RSS-247 (5.1) (4)

Frequency hopping systems in the 2400 – 2483.5 MHz band shall use at least 15 non-overlapping channels.

#### **TEST PROCEDURE**

The transmitter output is connected to a spectrum analyzer. The span is set to cover the entire authorized band, in either a single sweep or in multiple contiguous sweeps. The RBW is set to a maximum of 1 % of the span. The analyzer is set to Max Hold.

#### **RESULTS**

Normal Mode: 79 Channels observed.



**NUMBER OF HOPPING CHANNELS**

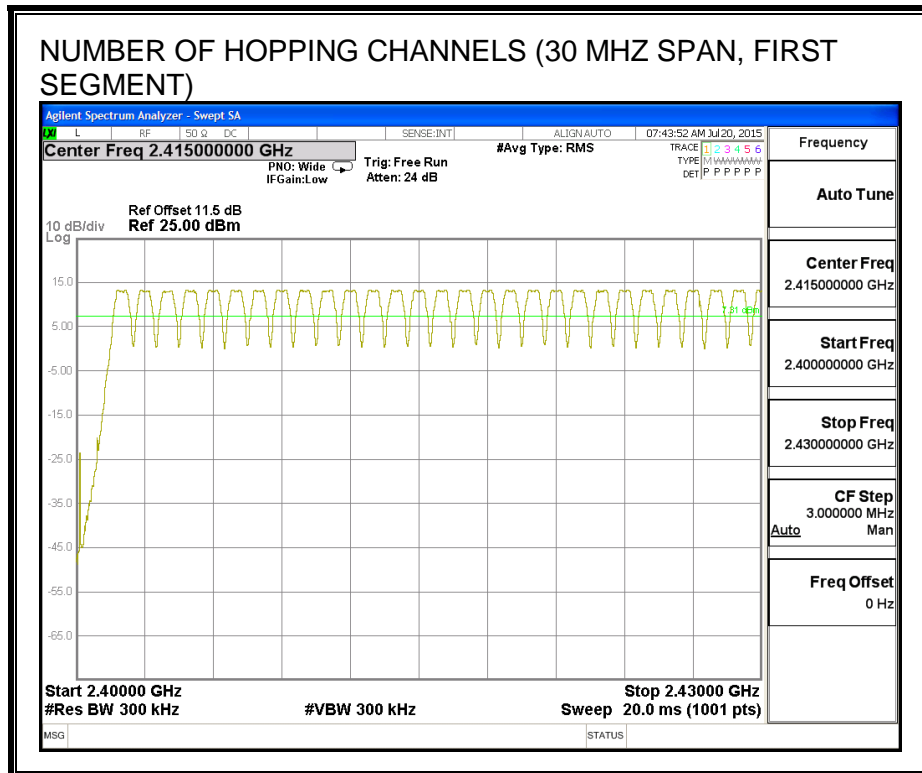
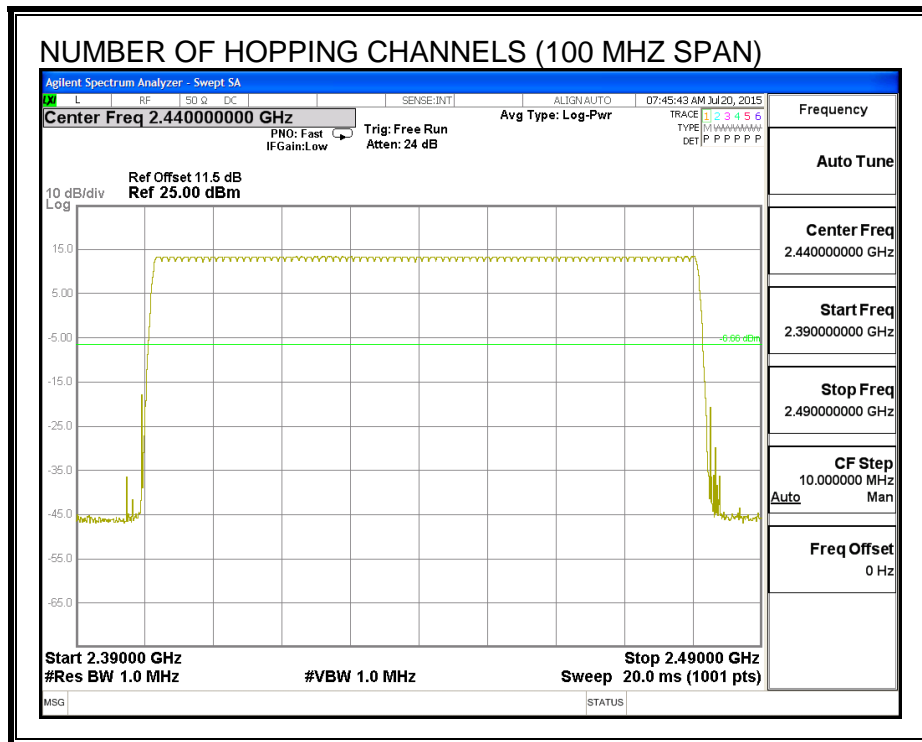

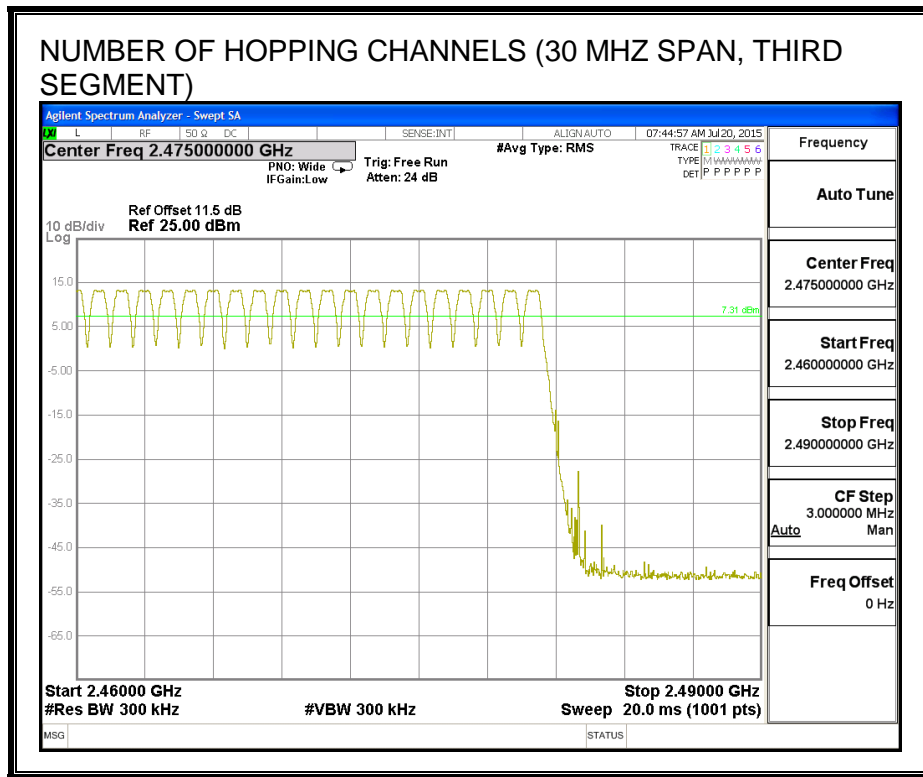
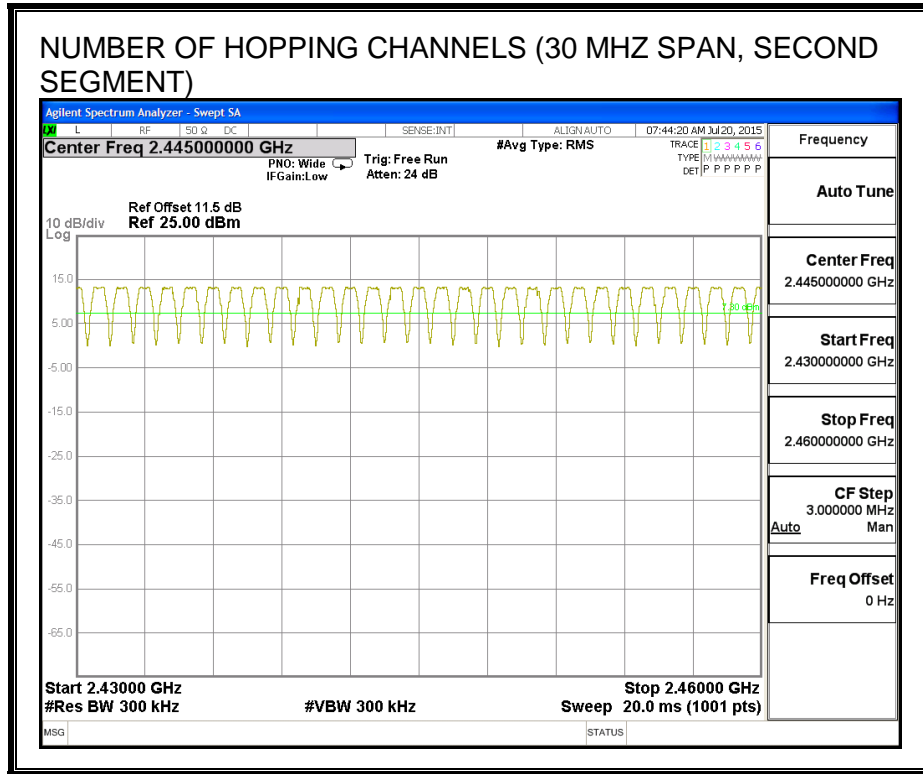

## 6.2.4. AVERAGE TIME OF OCCUPANCY

### LIMIT

FCC §15.247 (a) (1) (iii)

IC RSS-247 (5.1) (4)

The average time of occupancy on any channel shall not be greater than 0.4 seconds within a period of 0.4 seconds multiplied by the number of hopping channels employed.

### TEST PROCEDURE

The transmitter output is connected to a spectrum analyzer. The span is set to 0 Hz, centered on a single, selected hopping channel. The width of a single pulse is measured in a fast scan. The number of pulses is measured in a 3.16 second scan, to enable resolution of each occurrence.

The average time of occupancy in the specified 31.6 second period (79 channels \* 0.4 s) is equal to  $10 * (\# \text{ of pulses in } 3.16 \text{ s}) * \text{ pulse width}$ .

For AFH mode, the average time of occupancy in the specified 8 second period (20 channels \* 0.4 seconds) is equal to  $10 * (\# \text{ of pulses in } 0.8 \text{ s}) * \text{ pulse width}$ .

### RESULTS

DH Packet	Pulse Width (msec)	Number of Pulses in 3.16 seconds	Average Time of Occupancy (sec)	Limit (sec)	Margin (sec)
GFSK Normal Mode					
DH1	0.418	33	0.138	0.4	-0.262
DH3	1.668	20	0.334	0.4	-0.066
DH5	2.922	13	0.380	0.4	-0.020





**PULSE WIDTH – DH5**

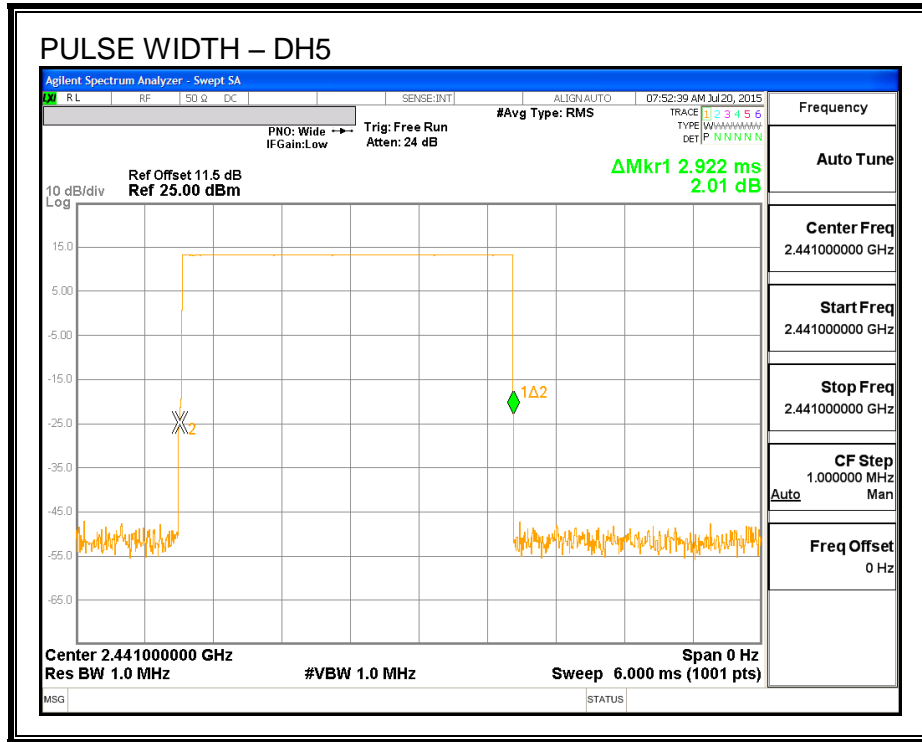

**NUMBER OF PULSES IN 3.16 SECOND OBSERVATION PERIOD – DH5**

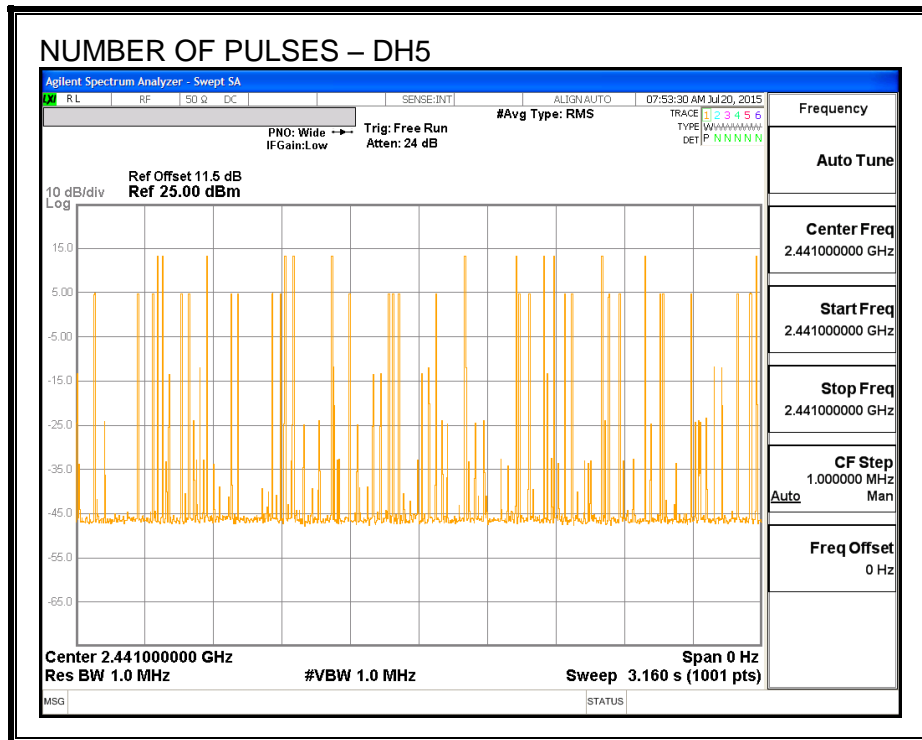

## 6.2.5. OUTPUT POWER

### LIMIT

§15.247 (b) (1)

RSS-247 (5.4) (2)

The maximum antenna gain is less than 6 dBi, therefore the limit is 30 dBm.

### TEST PROCEDURE

The transmitter output is connected to a wideband peak and average power meter.

### RESULTS

Channel	Frequency (MHz)	Output Power (dBm)	Limit (dBm)	Margin (dB)
Low	2402	10.16	30	-19.84
Middle	2441	10.18	30	-19.82
High	2480	10.22	30	-19.78

### 6.2.6. AVERAGE POWER

#### LIMIT

None; for reporting purposes only.

#### TEST PROCEDURE

The transmitter output is connected to a power meter.

#### RESULTS

The cable assembly insertion loss of 11 dB (including 10 dB pad and 1 dB cable) was entered as an offset in the power meter to allow for direct reading of power.

Channel	Frequency (MHz)	Average Power (dBm)
Low	2402	9.97
Middle	2441	9.98
High	2480	10.00



## **6.2.7. CONDUCTED SPURIOUS EMISSIONS**

### **LIMITS**

FCC §15.247 (d)

IC RSS-247 (5.5)

Limit = -20 dBc

### **TEST PROCEDURE**

The transmitter output is connected to a spectrum analyzer. The resolution bandwidth is set to 100 kHz. The video bandwidth is set to 300 kHz.

The spectrum from 30 MHz to 26 GHz is investigated with the transmitter set to the lowest, middle, and highest channels.

The bandedges at 2.4 and 2.4835 GHz are investigated with the transmitter set to the normal hopping mode.

### **RESULTS**

**SPURIOUS EMISSIONS, LOW CHANNEL**

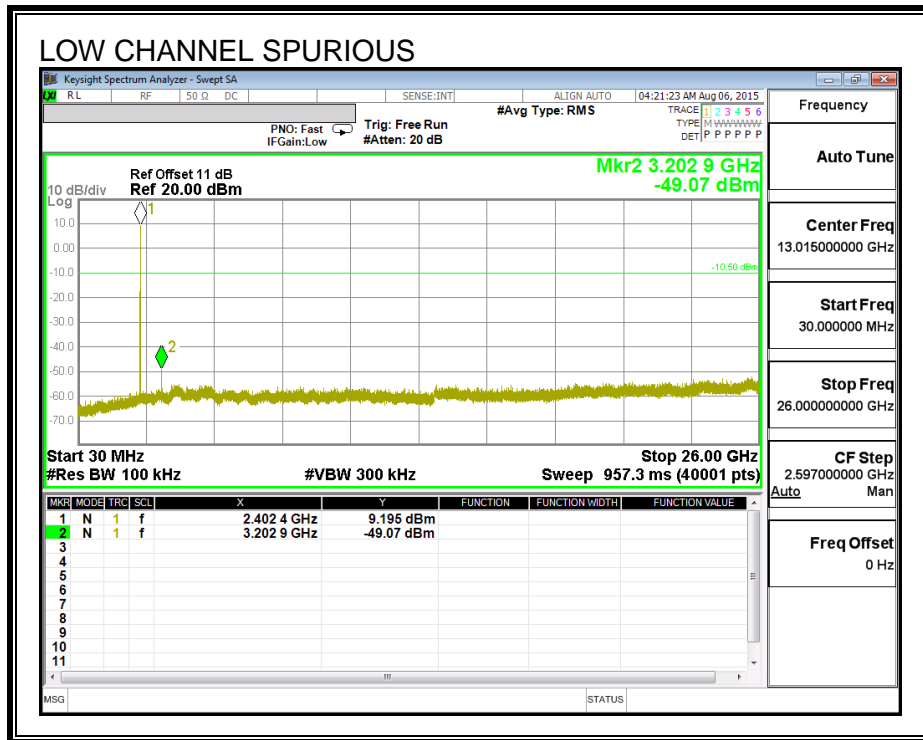
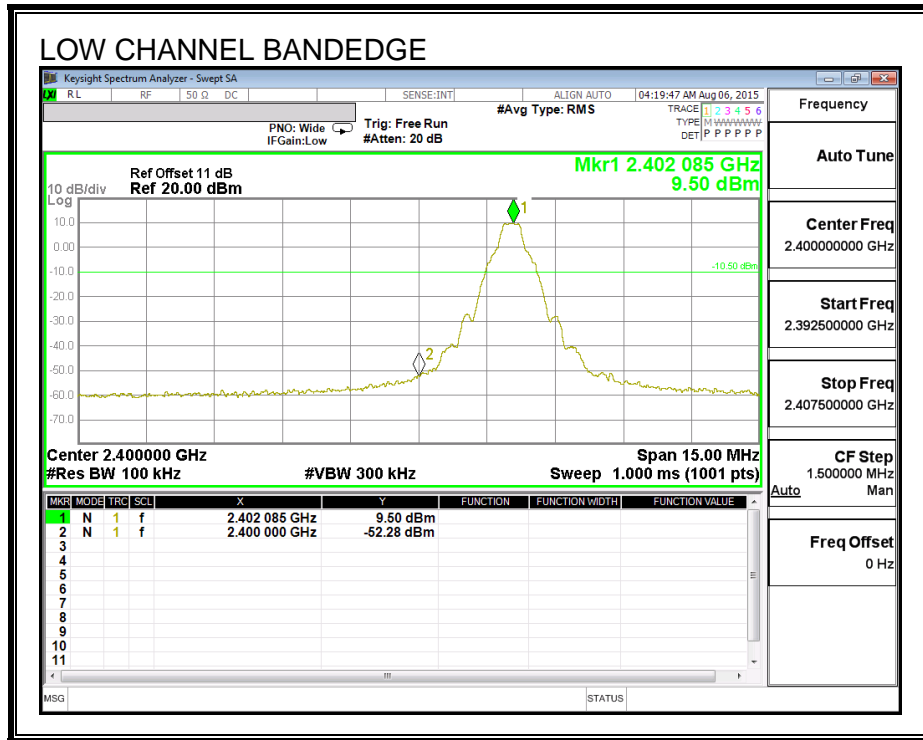

**SPURIOUS EMISSIONS, MID CHANNEL**

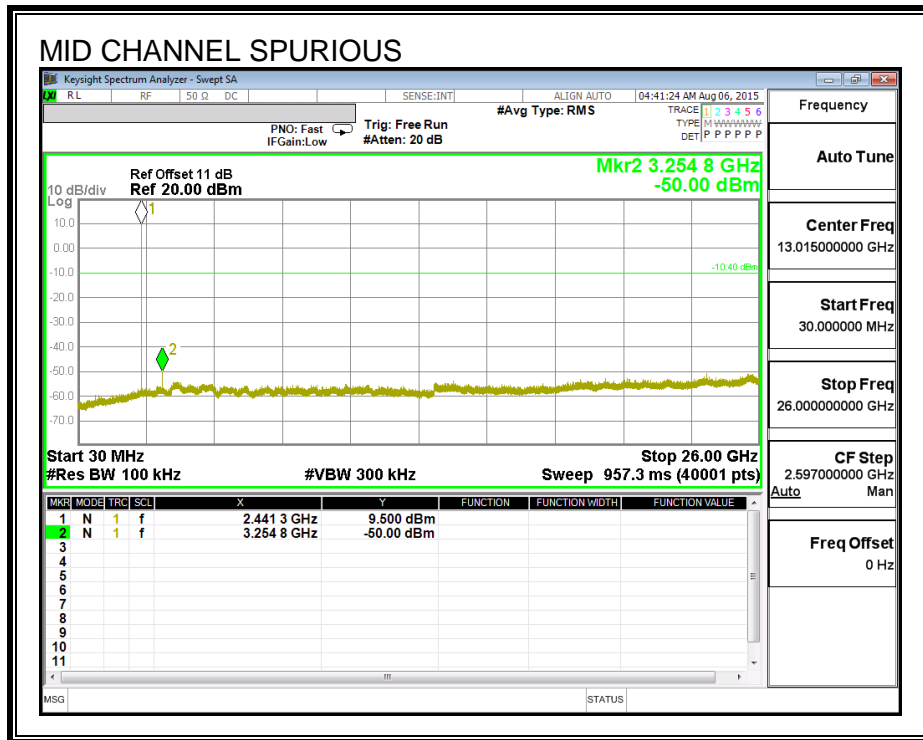
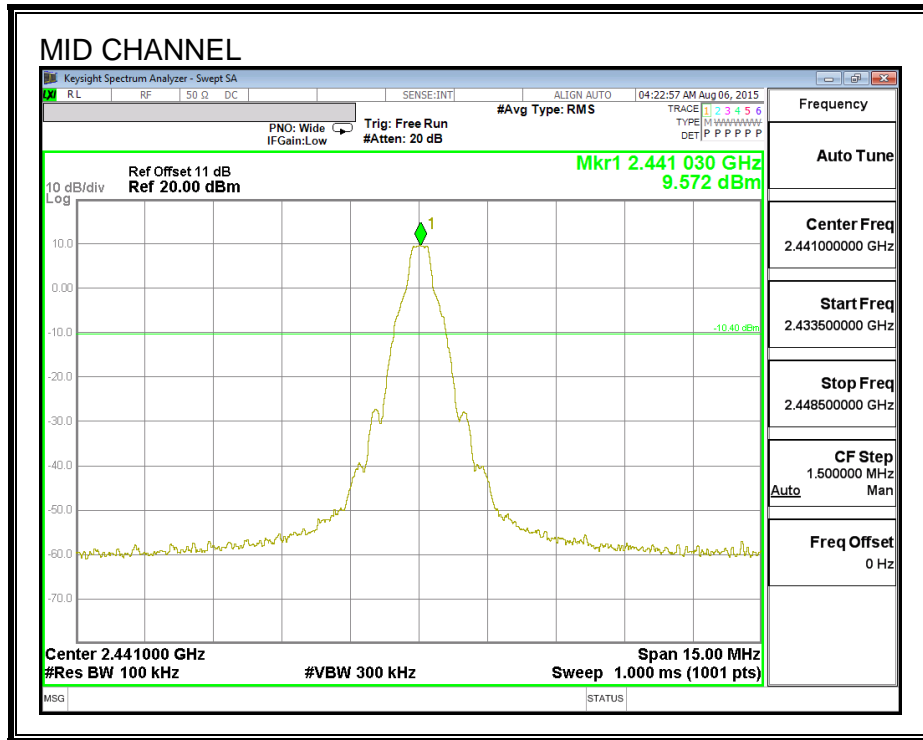

**SPURIOUS EMISSIONS, HIGH CHANNEL**

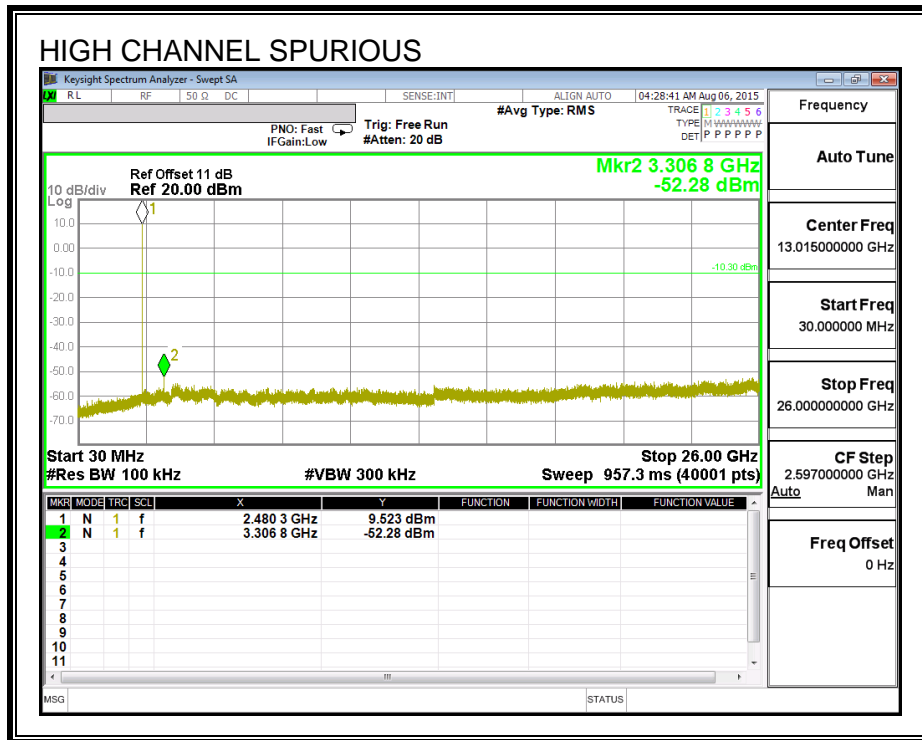
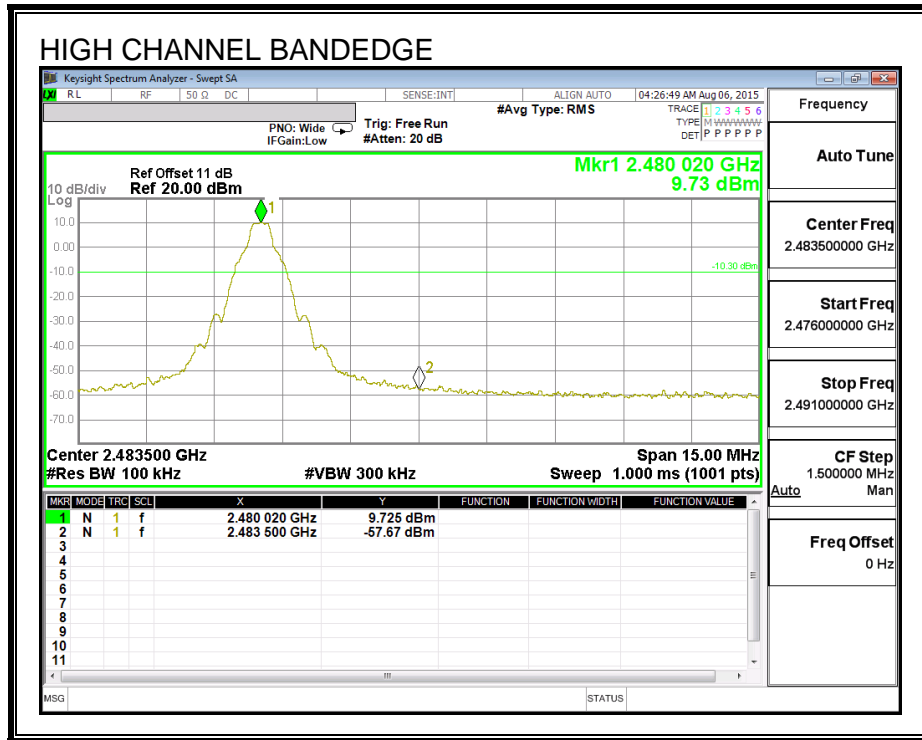

**SPURIOUS BANDEGE EMISSIONS WITH HOPPING ON**

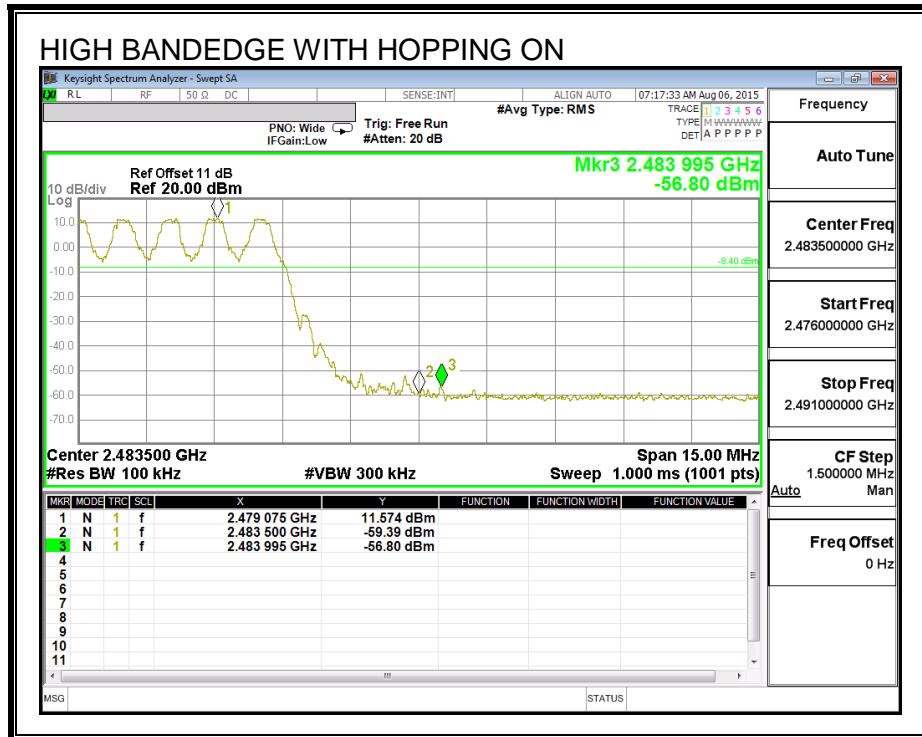
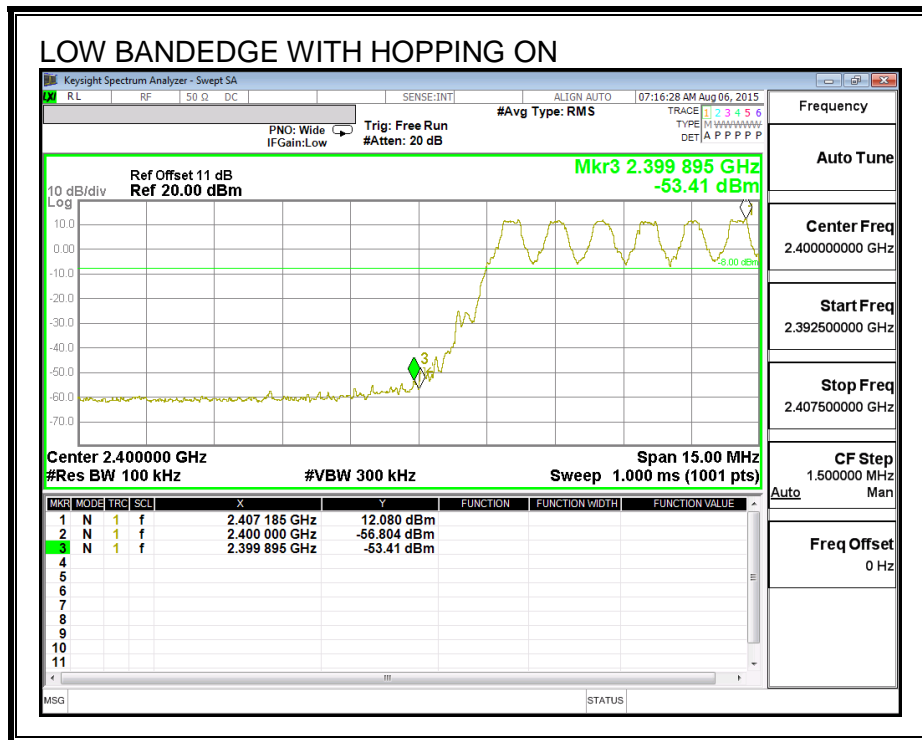

### 6.3. ENHANCED DATA RATE QPSK MODULATION

#### 6.3.1. OUTPUT POWER

##### LIMIT

§15.247 (b) (1)

RSS-247 (5.4) (2)

The maximum antenna gain is less than 6 dBi, therefore the limit is 30 dBm.

Alternatively, frequency hopping systems operating in the 2400-2483.5 MHz band may have hopping channel carrier frequencies that are separated by 25 kHz or two-thirds of the 20 dB bandwidth of the hopping channel, whichever is greater, provided the systems operate with an output power no greater than 125 mW.

##### TEST PROCEDURE

The transmitter output is connected to a wideband peak and average power meter.

##### RESULTS

Channel	Frequency (MHz)	Output Power (dBm)	Limit (dBm)	Margin (dB)
Low	2402	11.46	21	-9.51
Middle	2441	11.89	21	-9.08
High	2480	11.98	21	-8.99

### 6.3.2. AVERAGE POWER

#### LIMIT

None; for reporting purposes only.

#### TEST PROCEDURE

The transmitter output is connected to a power meter.

#### RESULTS

The cable assembly insertion loss of 11 dB (including 10 dB pad and 1 dB cable) was entered as an offset in the power meter to allow for direct reading of power.

Channel	Frequency (MHz)	Average Power (dBm)
Low	2402	9.26
Middle	2441	9.84
High	2480	9.96

## 6.4. ENHANCED DATA RATE 8PSK MODULATION

### 6.4.1. 20 dB AND 99% BANDWIDTH

#### LIMIT

None; for reporting purposes only.

#### TEST PROCEDURE

The transmitter output is connected to a spectrum analyzer. The RBW is set to  $\geq 1\%$  of the 20 dB bandwidth. The VBW is set to  $\geq$  RBW. The sweep time is coupled.

#### RESULTS

Channel	Frequency (MHz)	20 dB Bandwidth (KHz)	99% Bandwidth (KHz)
Low	2402	1360.0	1219.4
Middle	2441	1362.0	1224.3
High	2480	1333.0	1232.4



**20 dB AND 99% BANDWIDTH**

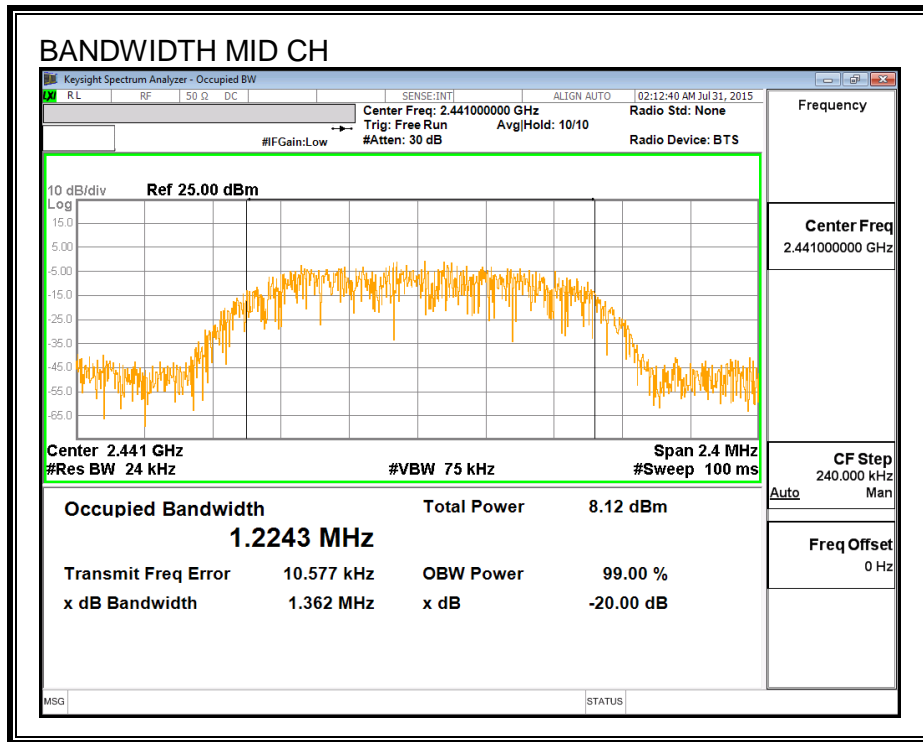
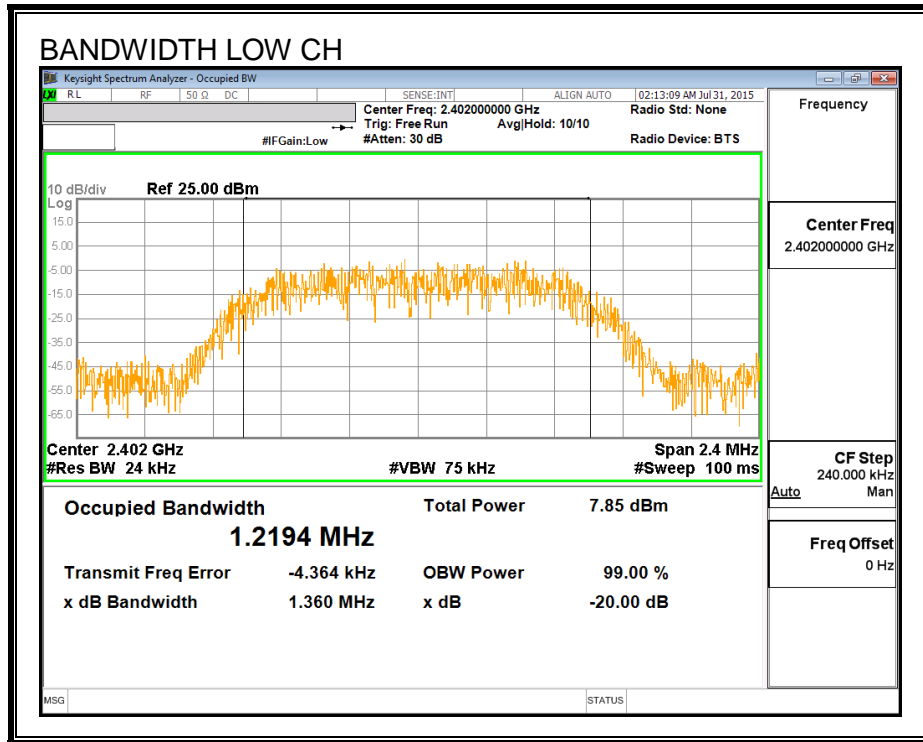

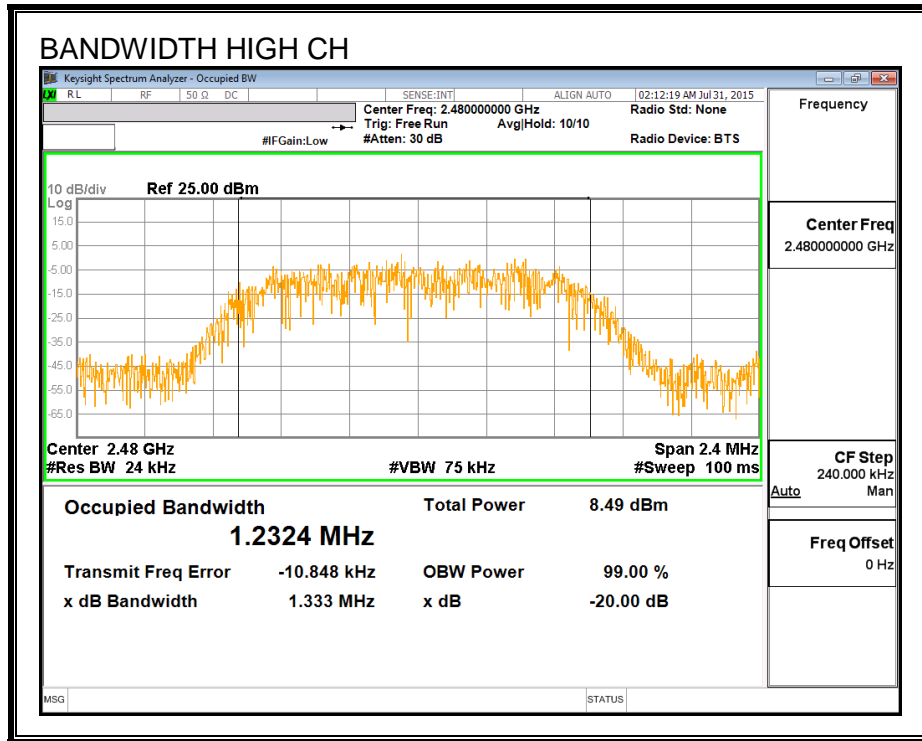

### 6.4.2. HOPPING FREQUENCY SEPARATION

#### LIMIT

FCC §15.247 (a) (1)

IC RSS-247 (5.1) (2)

Frequency hopping systems shall have hopping channel carrier frequencies separated by a minimum of 25 kHz or the 20 dB bandwidth of the hopping channel, whichever is greater.

Alternatively, frequency hopping systems operating in the 2400-2483.5 MHz band may have hopping channel carrier frequencies that are separated by 25 kHz or two-thirds of the 20 dB bandwidth of the hopping channel, whichever is greater, provided the systems operate with an output power no greater than 125 mW.

#### TEST PROCEDURE

The transmitter output is connected to a spectrum analyzer. The RBW is set to 300 kHz and the VBW is set to 910 kHz. The sweep time is coupled.

#### RESULTS

#### HOPPING FREQUENCY SEPARATION

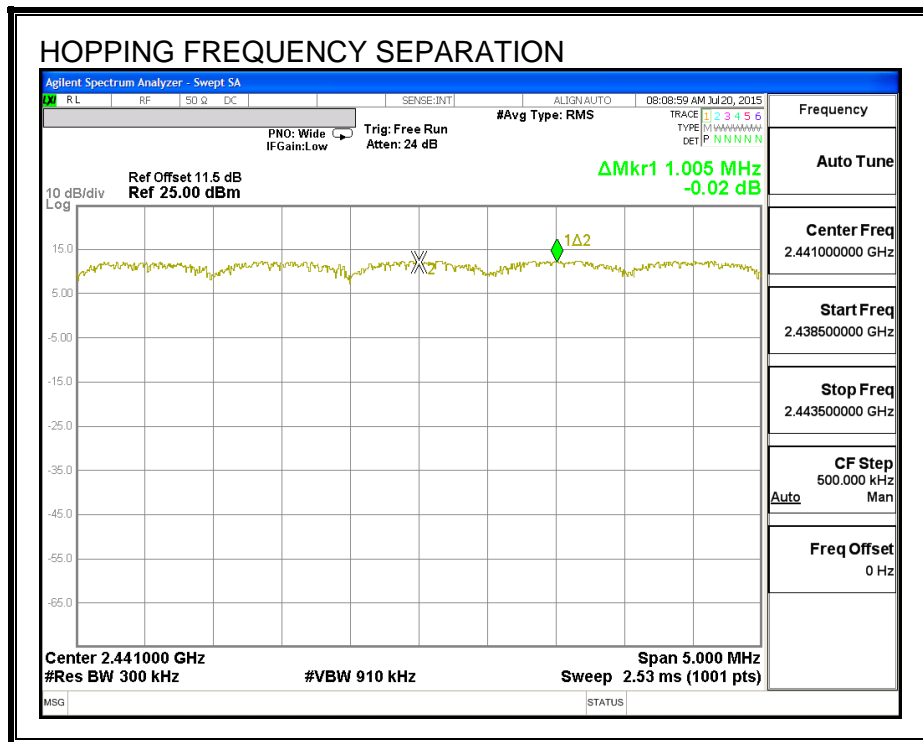

### **6.4.3. NUMBER OF HOPPING CHANNELS**

#### **LIMIT**

FCC §15.247 (a) (1) (iii)

IC RSS-247 (5.1) (4)

Frequency hopping systems in the 2400 – 2483.5 MHz band shall use at least 15 non-overlapping channels.

#### **TEST PROCEDURE**

The transmitter output is connected to a spectrum analyzer. The span is set to cover the entire authorized band, in either a single sweep or in multiple contiguous sweeps. The RBW is set to a maximum of 1 % of the span. The analyzer is set to Max Hold.

#### **RESULTS**

Normal Mode: 79 Channels observed.

**NUMBER OF HOPPING CHANNELS**

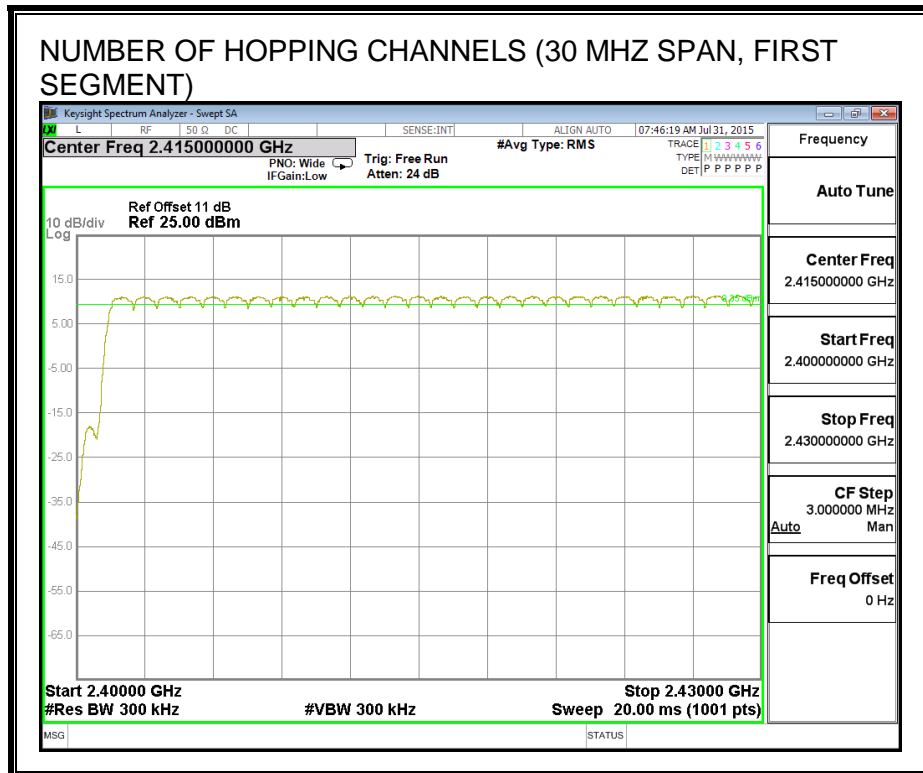
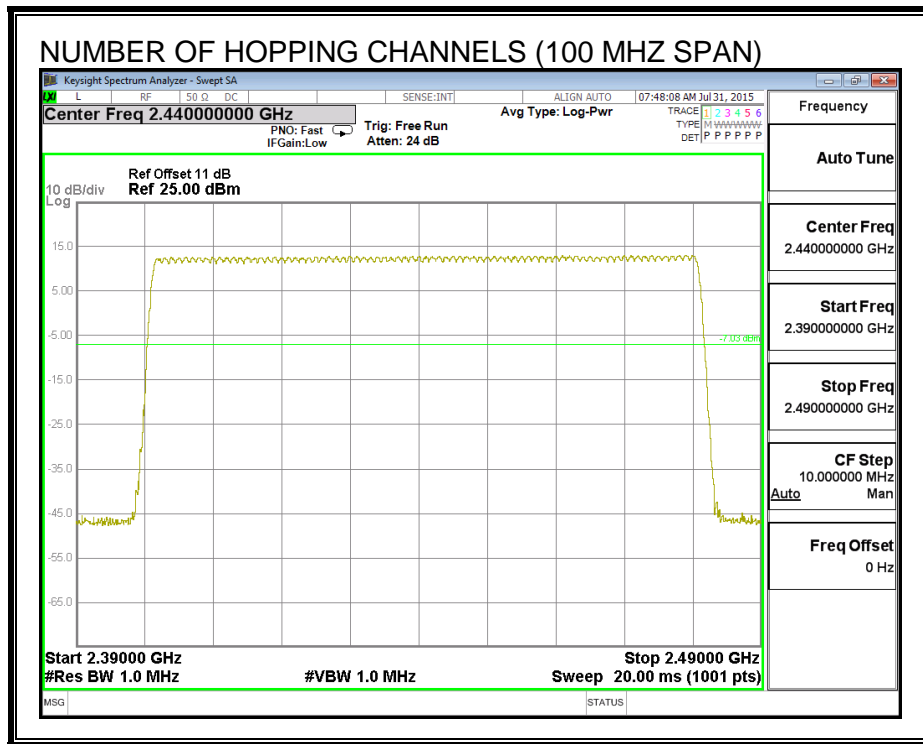

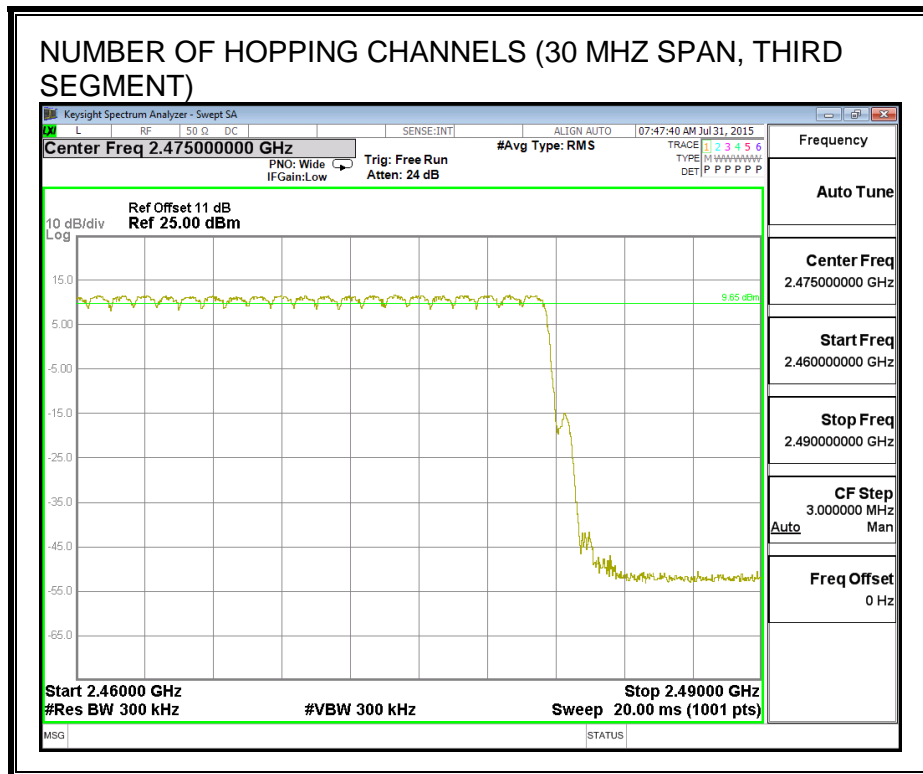
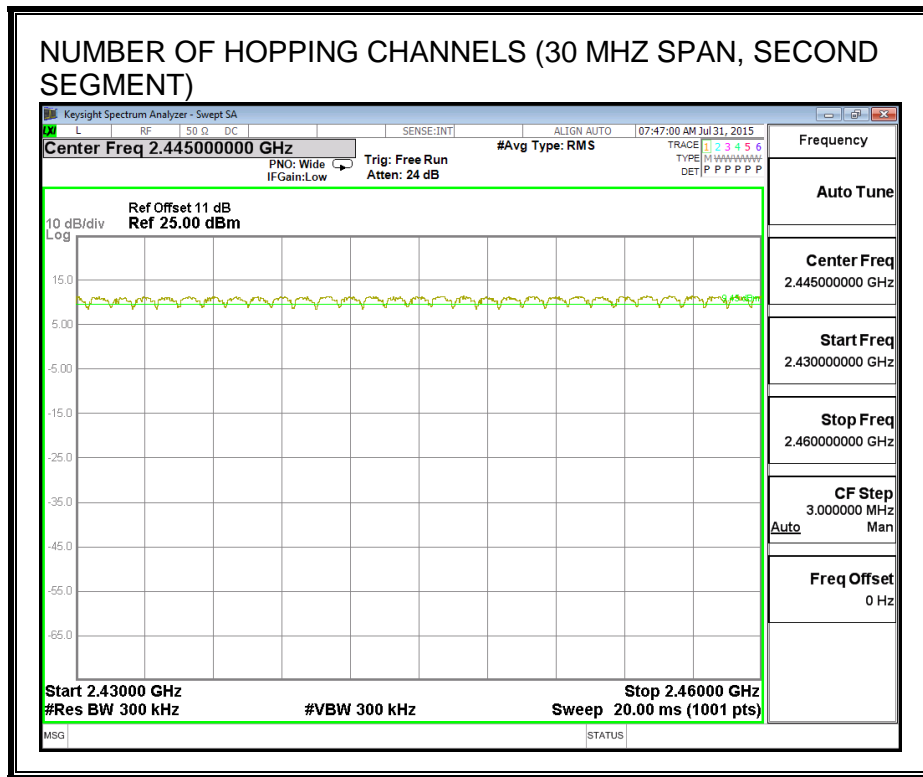

### 6.4.4. AVERAGE TIME OF OCCUPANCY

#### LIMIT

FCC §15.247 (a) (1) (iii)

IC RSS-247 (5.1) (4)

The average time of occupancy on any channel shall not be greater than 0.4 seconds within a period of 0.4 seconds multiplied by the number of hopping channels employed.

#### TEST PROCEDURE

The transmitter output is connected to a spectrum analyzer. The span is set to 0 Hz, centered on a single, selected hopping channel. The width of a single pulse is measured in a fast scan. The number of pulses is measured in a 3.16 second scan, to enable resolution of each occurrence.

The average time of occupancy in the specified 31.6 second period (79 channels \* 0.4 s) is equal to  $10 * (\# \text{ of pulses in } 3.16 \text{ s}) * \text{ pulse width}$ .

#### RESULTS

##### 8PSK (EDR) Mode

DH Packet	Pulse Width (msec)	Number of Pulses in 3.16 seconds	Average Time of (sec)	Limit (sec)	Margin (sec)
3DH1	0.422	33	0.139	0.4	-0.261
3DH3	1.677	19	0.319	0.4	-0.081
3DH5	2.933	13	0.381	0.4	-0.019







**PULSE WIDTH – 3DH5**

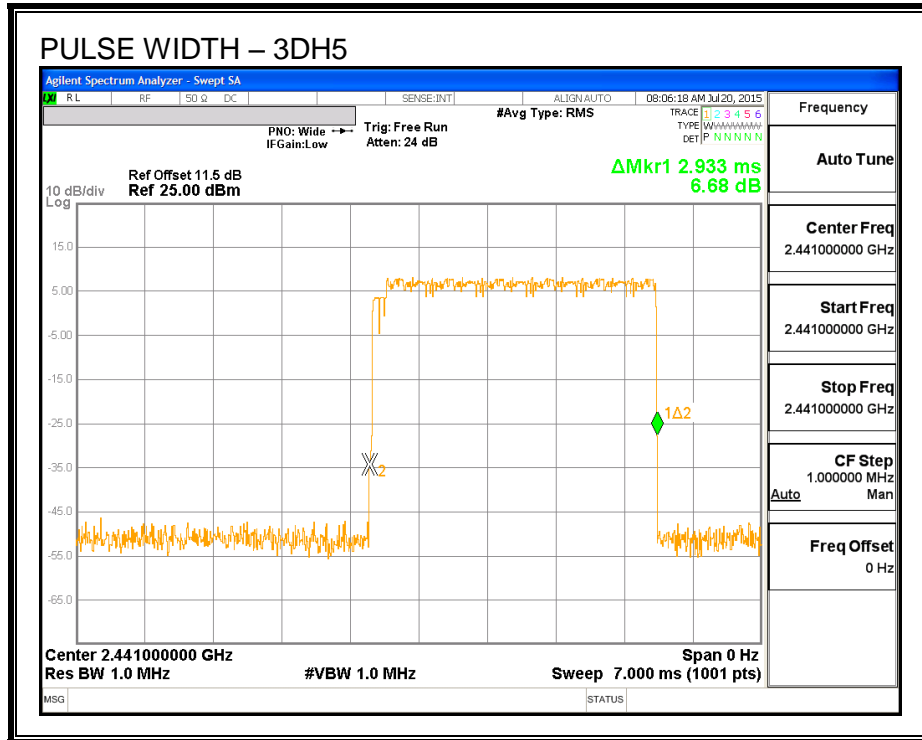

**NUMBER OF PULSES IN 3.16 SECOND OBSERVATION PERIOD – 3DH5**

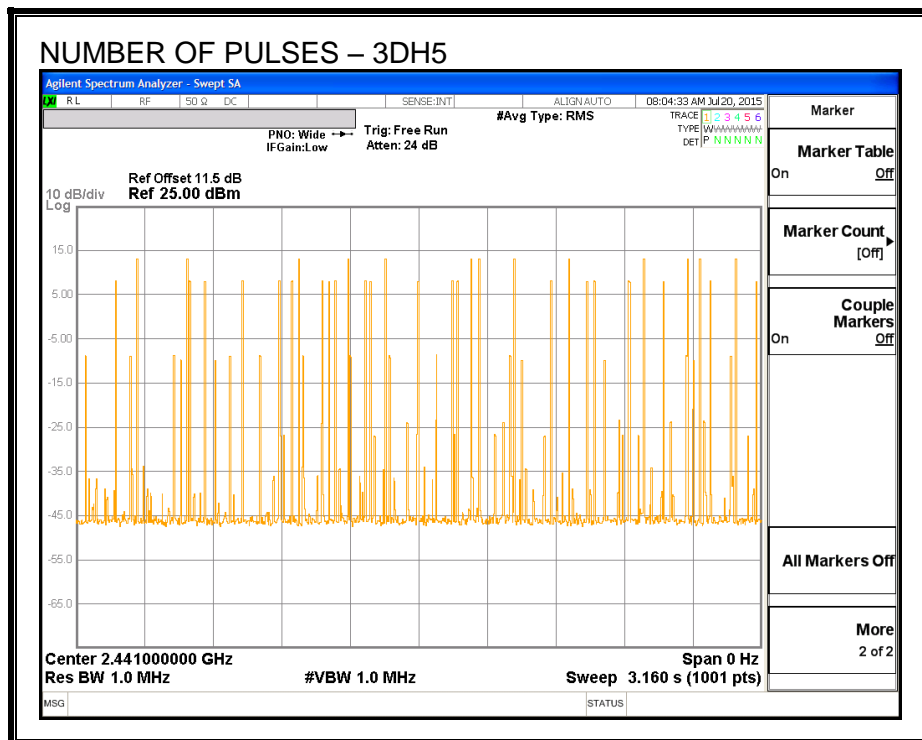

## 6.4.5. OUTPUT POWER

### LIMIT

§15.247 (b) (1)

RSS-247 (5.4) (2)

The maximum antenna gain is less than 6 dBi, therefore the limit is 30 dBm.

Alternatively, frequency hopping systems operating in the 2400-2483.5 MHz band may have hopping channel carrier frequencies that are separated by 25 kHz or two-thirds of the 20 dB bandwidth of the hopping channel, whichever is greater, provided the systems operate with an output power no greater than 125 mW.

### TEST PROCEDURE

The transmitter output is connected to a wideband peak and average power meter.

### RESULTS

Channel	Frequency (MHz)	Output Power (dBm)	Limit (dBm)	Margin (dB)
Low	2402	11.52	21	-9.45
Middle	2441	11.91	21	-9.06
High	2480	12.02	21	-8.95

### 6.4.6. AVERAGE POWER

#### LIMIT

None; for reporting purposes only.

#### TEST PROCEDURE

The transmitter output is connected to a power meter.

#### RESULTS

The cable assembly insertion loss of 11 dB (including 10 dB pad and 1 dB cable) was entered as an offset in the power meter to allow for direct reading of power.

Channel	Frequency (MHz)	Average Power (dBm)
Low	2402	9.29
Middle	2441	9.85
High	2480	10.00

## **6.4.7. CONDUCTED SPURIOUS EMISSIONS**

### **LIMITS**

FCC §15.247 (d)

IC RSS-247 (5.5)

Limit = -20 dBc

### **TEST PROCEDURE**

The transmitter output is connected to a spectrum analyzer. The resolution bandwidth is set to 100 kHz. The video bandwidth is set to 300 kHz.

The spectrum from 30 MHz to 26 GHz is investigated with the transmitter set to the lowest, middle, and highest channels.

The bandedges at 2.4 and 2.4835 GHz are investigated with the transmitter set to the normal hopping mode.

### **RESULTS**

**SPURIOUS EMISSIONS, LOW CHANNEL**

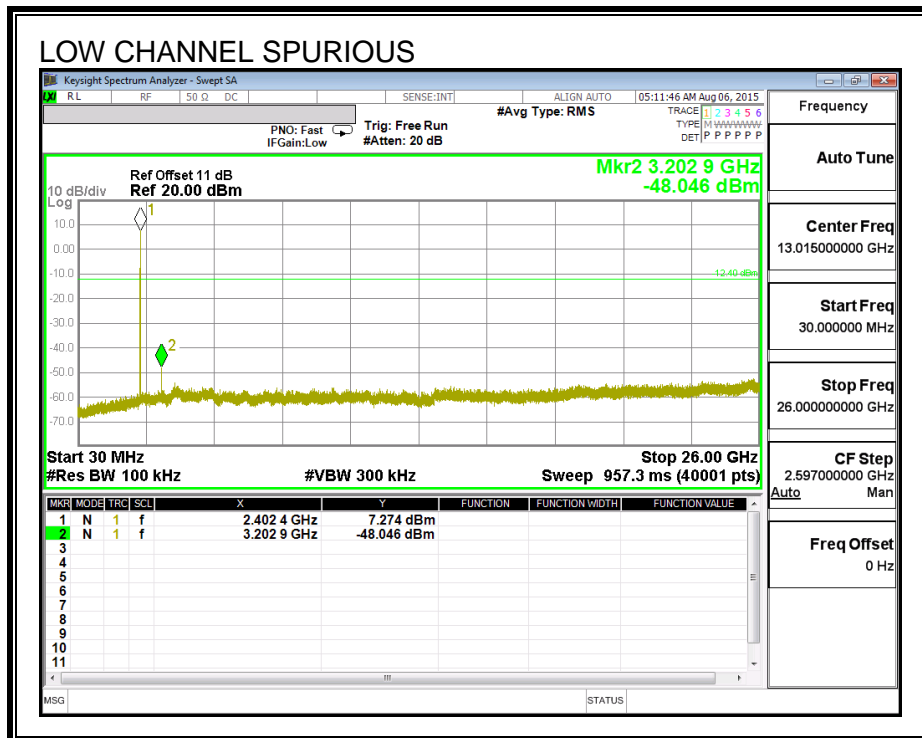
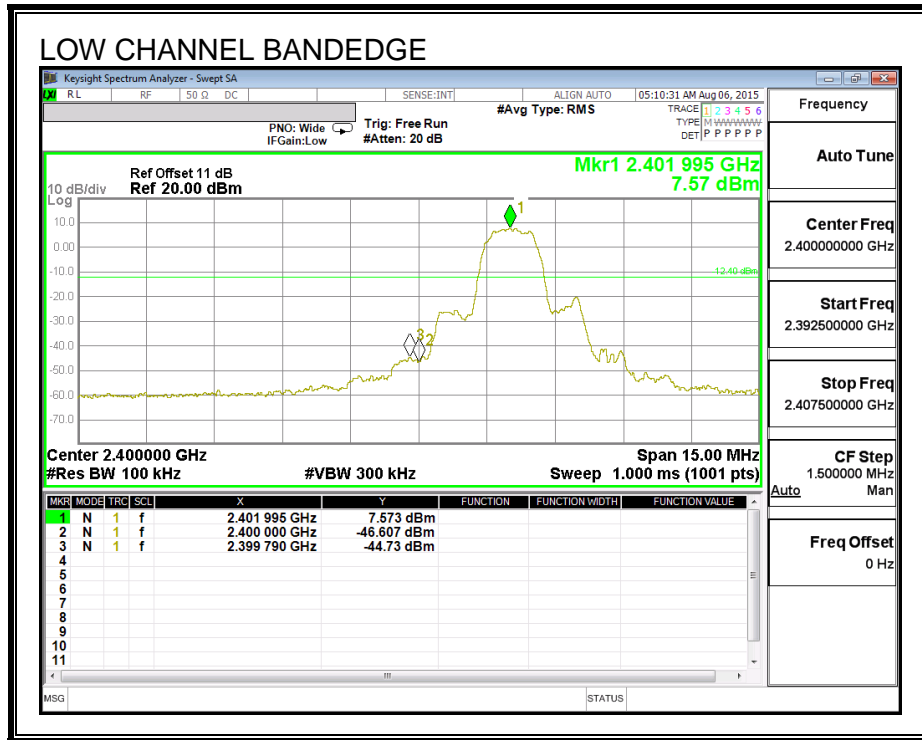

**SPURIOUS EMISSIONS, MID CHANNEL**

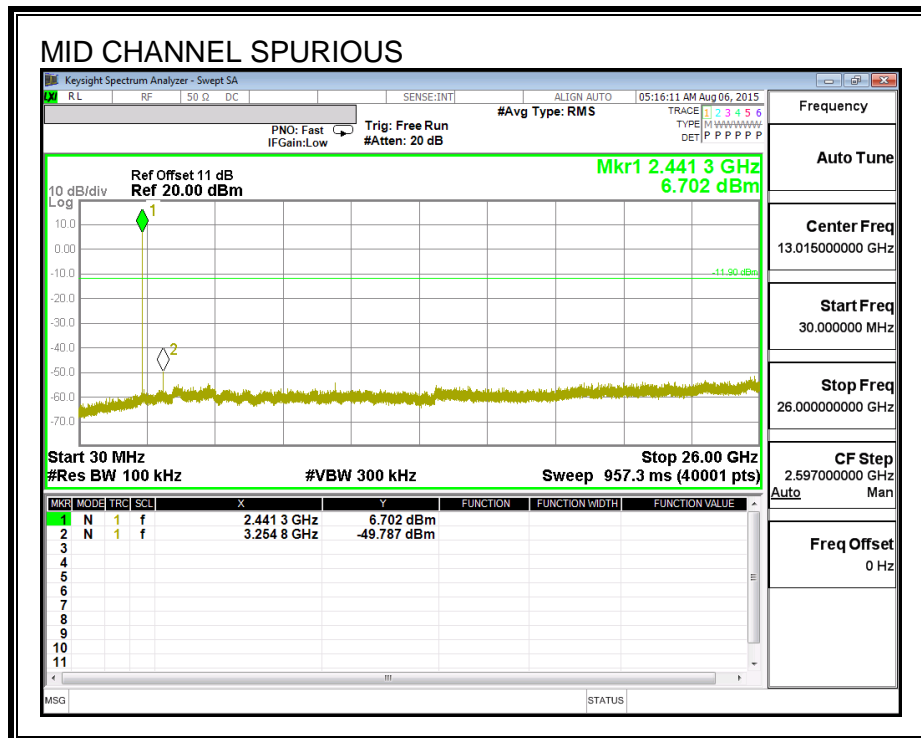
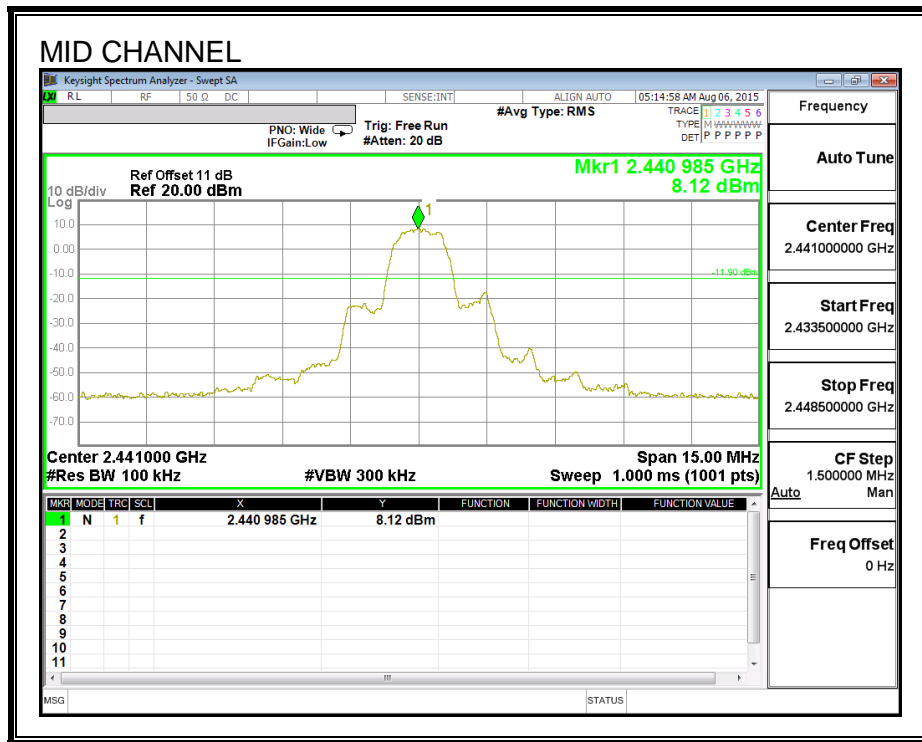

**SPURIOUS EMISSIONS, HIGH CHANNEL**

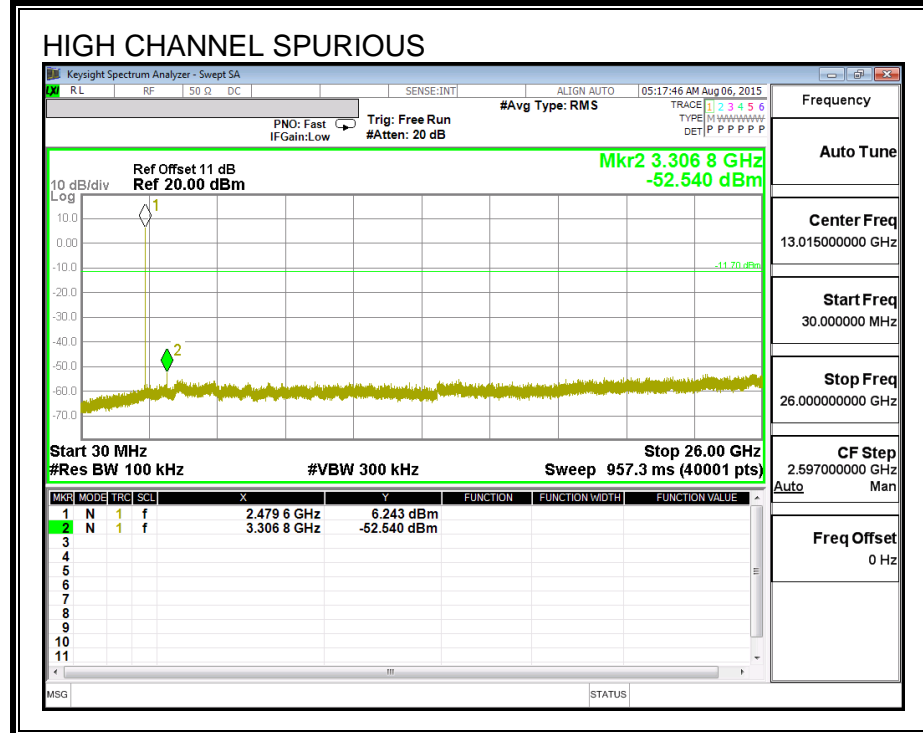
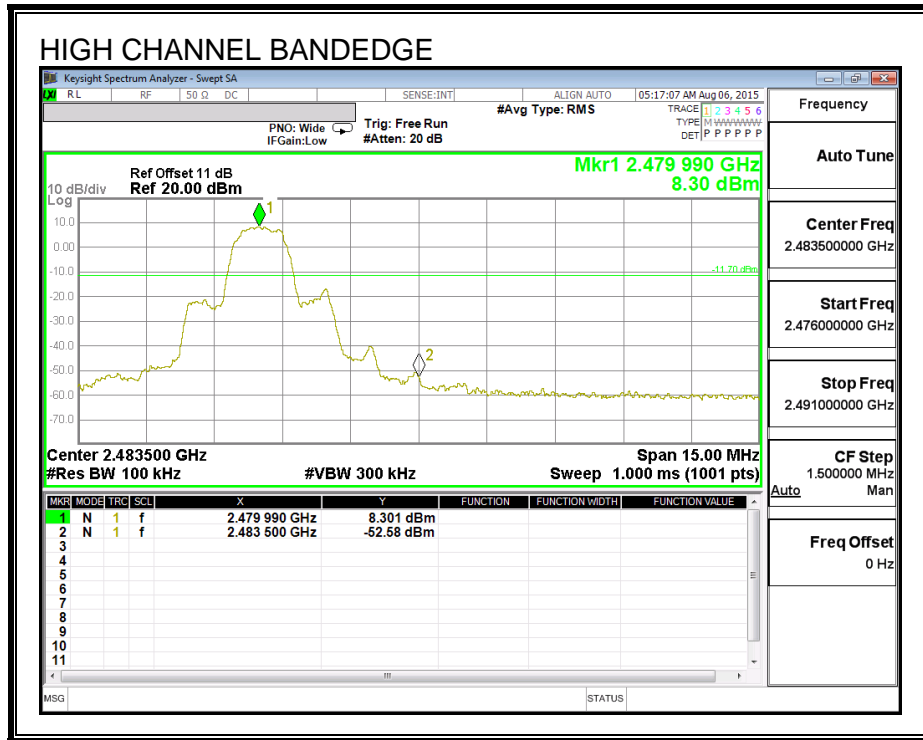



**SPURIOUS BANDEGE EMISSIONS WITH HOPPING ON**

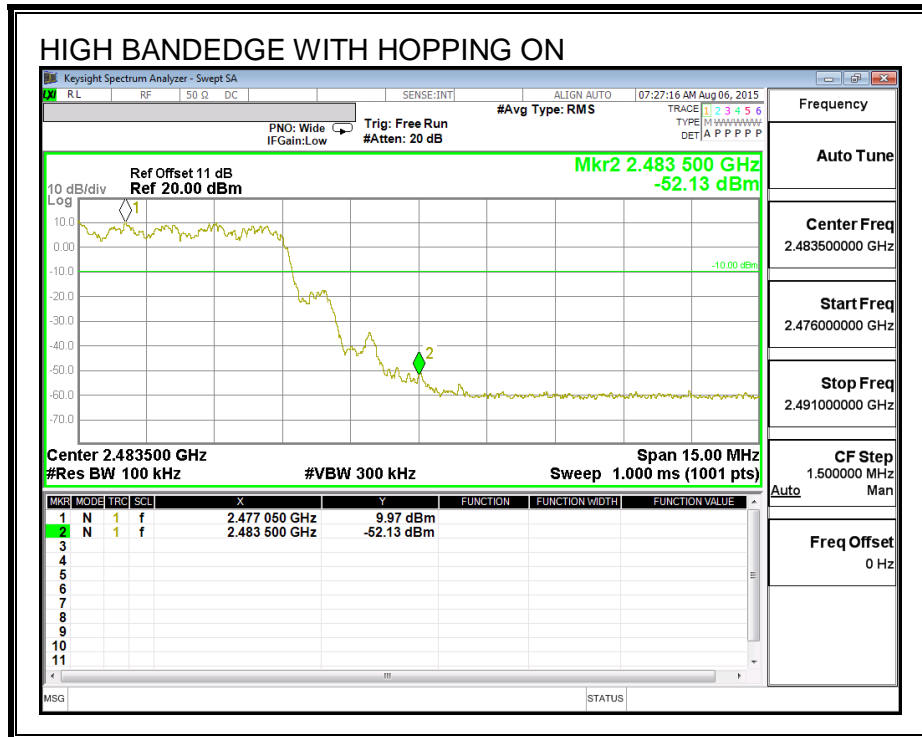
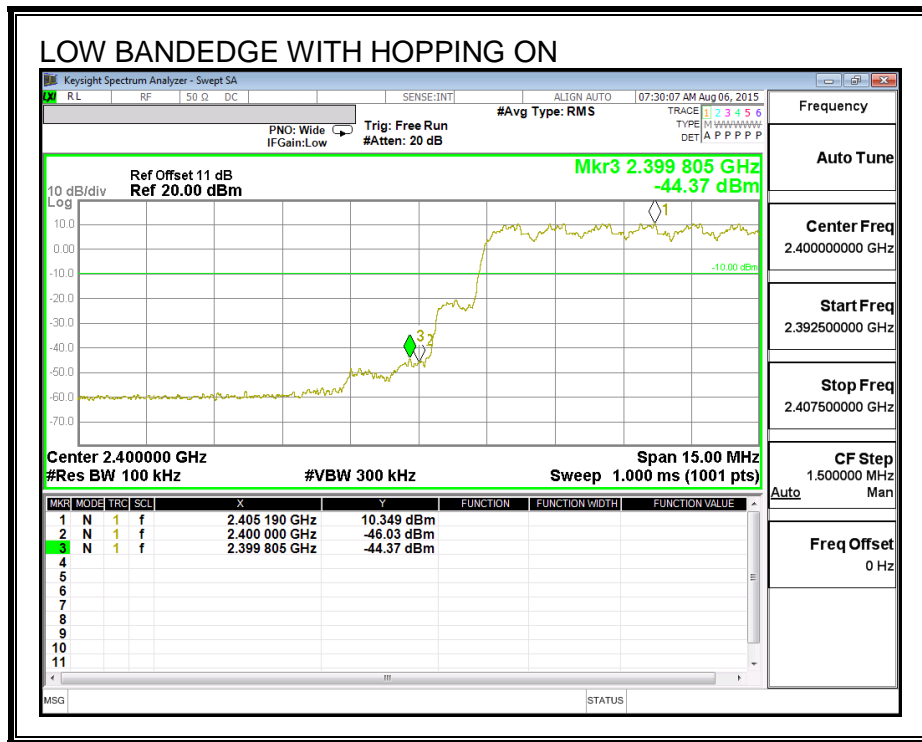

## 7. RADIATED TEST RESULTS

### 7.1. LIMITS AND PROCEDURE

#### LIMITS

FCC §15.205 and §15.209

IC RSS-GEN, Section 8.9 and 8.10.

Frequency Range (MHz)	Field Strength Limit (uV/m) at 3 m	Field Strength Limit (dBuV/m) at 3 m
30 - 88	100	40
88 - 216	150	43.5
216 - 960	200	46
Above 960	500	54

#### TEST PROCEDURE

The EUT is placed on a non-conducting table 80 cm above the ground plane for measurement below 1GHz; 1.5 m above the ground plane for measurement above 1GHz. The antenna to EUT distance is 3 meters. The EUT is configured in accordance with ANSI C63.10. The EUT is set to transmit in a continuous mode.

For measurements below 1 GHz the resolution bandwidth is set to 100 kHz for peak detection measurements or 120 kHz for quasi-peak detection measurements. Peak detection is used unless otherwise noted as quasi-peak.

For measurements above 1 GHz the resolution bandwidth is set to 1 MHz, then the video bandwidth is set to 3 MHz for peak measurements and 1 MHz resolution bandwidth with 1/T (10 Hz) video bandwidth with peak detector for average measurements.

The spectrum from 30 MHz to 26 GHz is investigated with the transmitter set to the lowest, middle, and highest channels in the 2.4 GHz band.

The frequency range of interest is monitored at a fixed antenna height and EUT azimuth. The EUT is rotated through 360 degrees to maximize emissions received. The antenna is scanned from 1 to 4 meters above the ground plane to further maximize the emission. Measurements are made with the antenna polarized in both the vertical and the horizontal positions.

#### RESULTS

## 7.2. TRANSMITTER ABOVE 1 GHz

### 7.2.1. BASIC DATA RATE GFSK MODULATION

#### RESTRICTED BANDEDGE (LOW CHANNEL, HORIZONTAL)

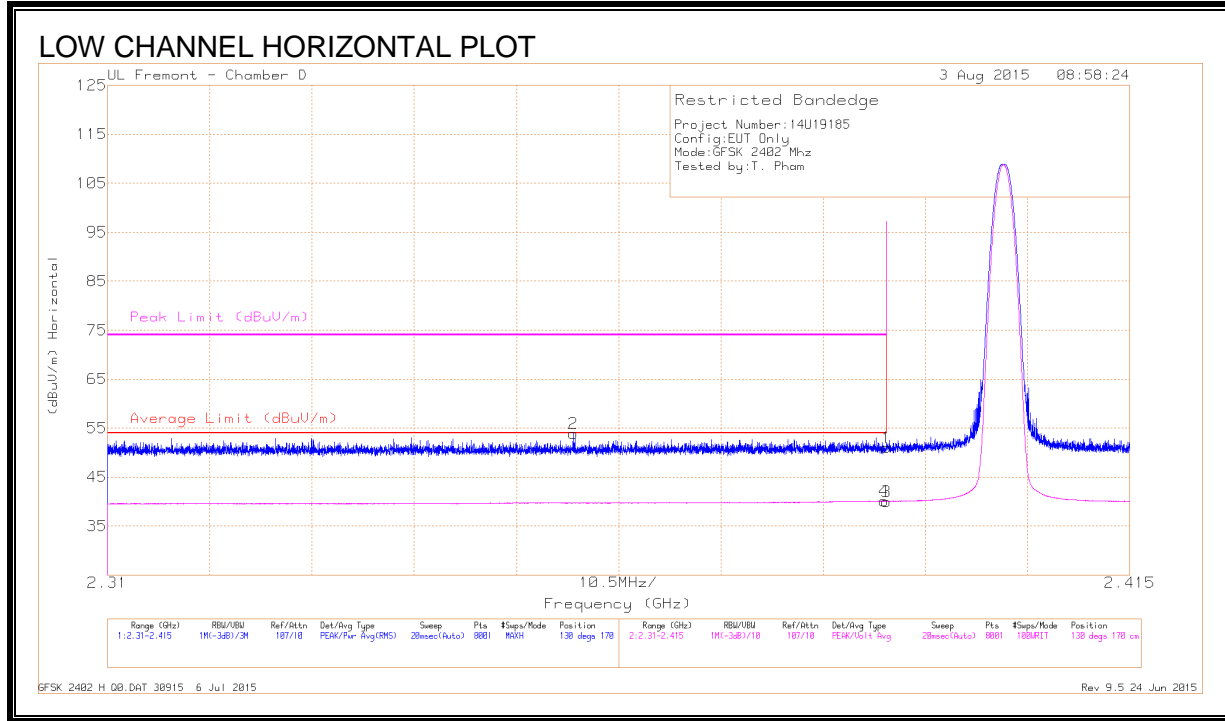

#### DATA

Marker	Frequency (GHz)	Meter Reading (dBuV)	Det	AF T344 (dB/m)	Amp/Cbl/Filtr/Pad (dB)	Corrected Reading (dBuV/m)	Average Limit (dBuV/m)	Margin (dB)	Peak Limit (dBuV/m)	PK Margin (dB)	Azimuth (Degs)	Height (cm)	Polarity
1	* 2.39	39.62	PK	32.1	-20.7	51.02	-	-	74	-22.98	130	170	H
2	* 2.358	42.8	PK	32	-20.9	53.9	-	-	74	-20.1	130	170	H
3	* 2.39	28.64	VA1T	32.1	-20.7	40.04	54	-13.96	-	-	130	170	H
4	* 2.39	28.67	VA1T	32.1	-20.7	40.07	54	-13.93	-	-	130	170	H

\* - indicates frequency in CFR 47, Part 15 and Industry Canada RSS-Restricted Band.

PK - Peak detector

VB1T - FHSS Method: VB=1/Ton, Voltage Averaging Max Hold where: Ton is the duration of the packet

**RESTRICTED BANDEDGE (LOW CHANNEL, VERTICAL)**

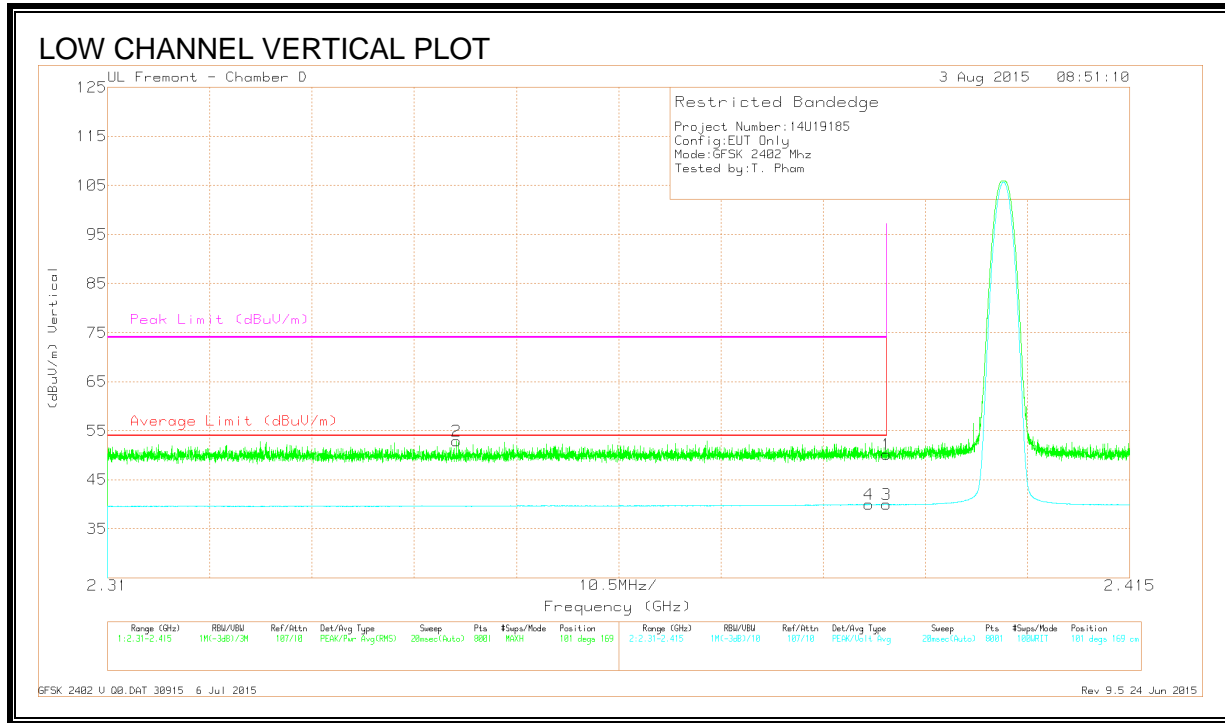

**DATA**

Marker	Frequency (GHz)	Meter Reading (dBuV)	Det	AF T344 (dB/m)	Amp/Cbl/Fitr/Pad (dB)	Corrected Reading (dBuV/m)	Average Limit (dBuV/m)	Margin (dB)	Peak Limit (dBuV/m)	PK Margin (dB)	Azimuth (Degs)	Height (cm)	Polarity
1	* 2.39	38.77	Pk	32.1	-20.7	50.17	-	-	74	-23.83	101	169	V
2	* 2.346	41.83	Pk	32	-20.9	52.93	-	-	74	-21.07	101	169	V
3	* 2.39	28.55	VA1T	32.1	-20.7	39.95	54	-14.05	-	-	101	169	V
4	* 2.388	28.67	VA1T	32.1	-20.8	39.97	54	-14.03	-	-	101	169	V

\* - indicates frequency in CFR 47, Part 15 and Industry Canada RSS-Restricted Band.

PK - Peak detector

VB1T - FHSS Method: VB=1/Ton, Voltage Averaging Max Hold where: Ton is the duration of the packet

**RESTRICTED BANDEDGE (HIGH CHANNEL, HORIZONTAL)**

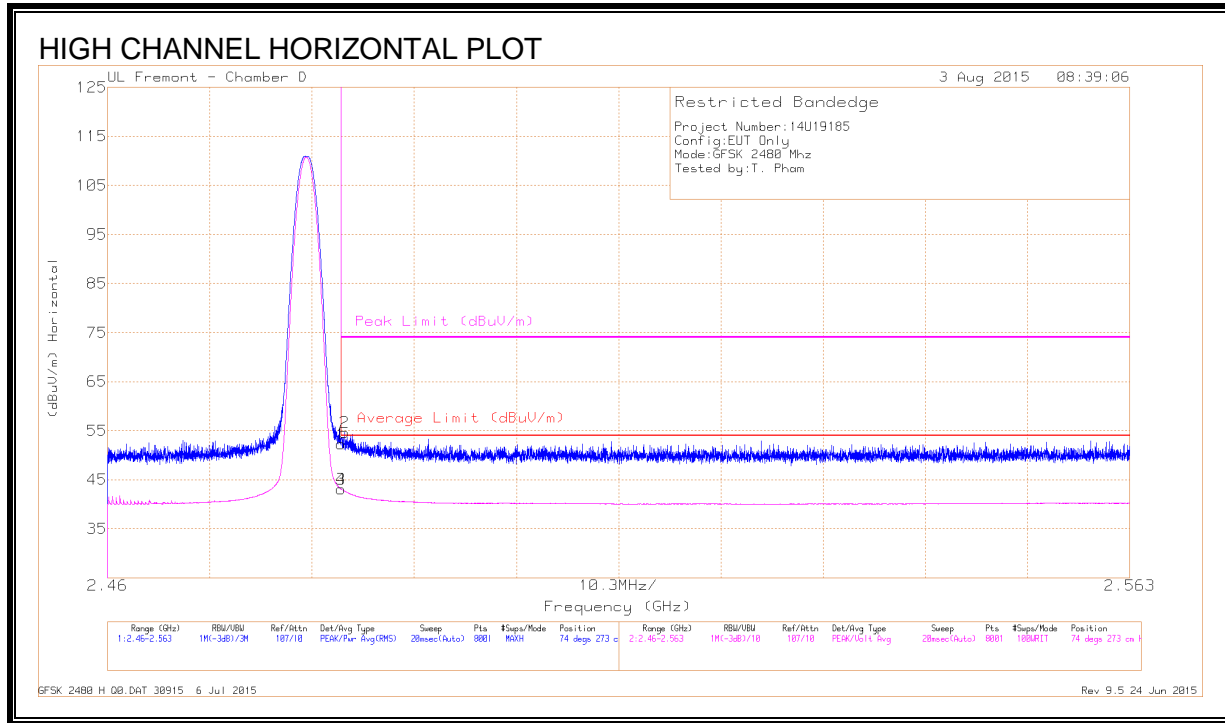

**DATA**

Marker	Frequency (GHz)	Meter Reading (dBuV)	Det	AF T344 (dB/m)	Amp/Cbl/ Fitr/Pad (dB)	Corrected Reading (dBuV/m)	Average Limit (dBuV/m)	Margin (dB)	Peak Limit (dBuV/m)	PK Margin (dB)	Azimuth (Degs)	Height (cm)	Polarity
1	* 2.484	40.83	Pk	32.2	-20.8	52.23	-	-	74	-21.77	74	273	H
2	* 2.484	43.27	Pk	32.2	-20.8	54.67	-	-	74	-19.33	74	273	H
3	* 2.484	31.7	VA1T	32.2	-20.8	43.1	54	-10.9	-	-	74	273	H
4	* 2.484	31.69	VA1T	32.2	-20.8	43.09	54	-10.91	-	-	74	273	H

\* - indicates frequency in CFR 47, Part 15 and Industry Canada RSS-Restricted Band.

PK - Peak detector

VB1T - FHSS Method: VB=1/Ton, Voltage Averaging Max Hold where: Ton is the duration of the packet

**RESTRICTED BANDEDGE (HIGH CHANNEL, VERTICAL)**

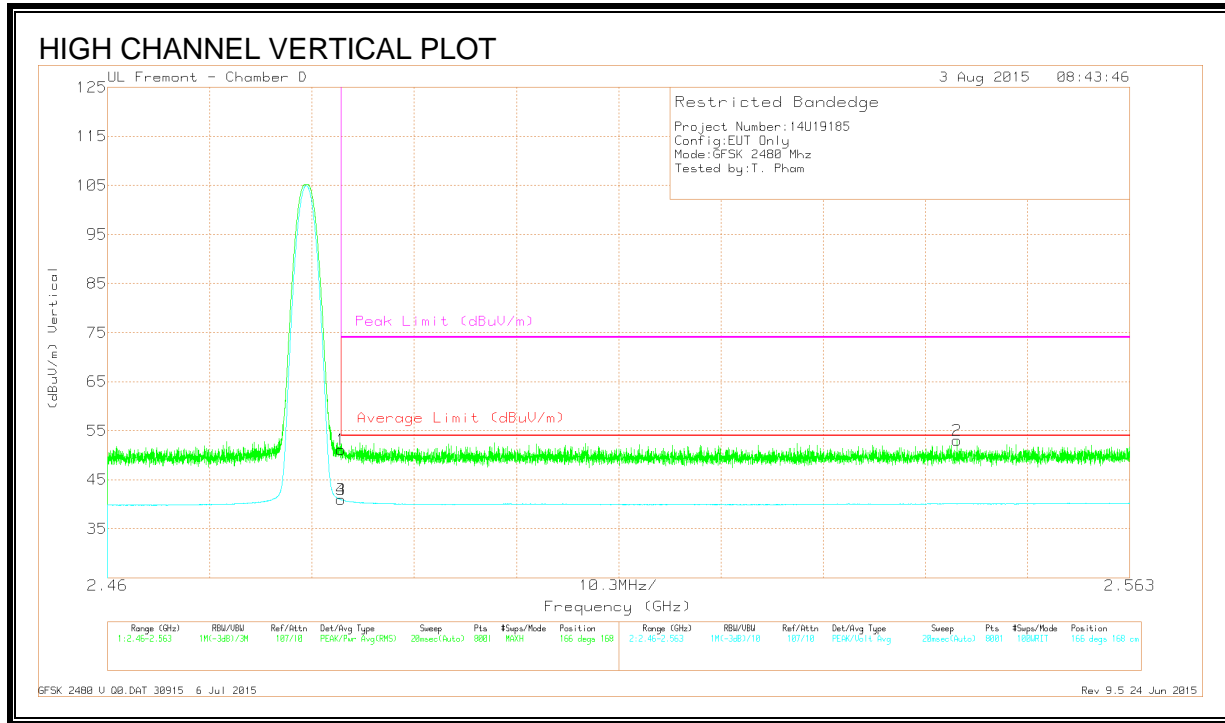

**DATA**

Marker	Frequency (GHz)	Meter Reading (dBuV)	Det	AF T344 (dB/m)	Amp/Cbl/Fitr/Pad (dB)	Corrected Reading (dBuV/m)	Average Limit (dBuV/m)	Margin (dB)	Peak Limit (dBuV/m)	PK Margin (dB)	Azimuth (Degs)	Height (cm)	Polarity
1	* 2.484	39.8	Pk	32.2	-20.8	51.2	-	-	74	-22.8	166	168	V
2	2.546	41.45	Pk	32.3	-20.7	53.05	-	-	74	-20.95	166	168	V
3	* 2.484	29.53	VA1T	32.2	-20.8	40.93	54	-13.07	-	-	166	168	V
4	* 2.484	29.53	VA1T	32.2	-20.8	40.93	54	-13.07	-	-	166	168	V

\* - indicates frequency in CFR 47, Part 15 and Industry Canada RSS-Restricted Band.

PK - Peak detector

VB1T - FHSS Method: VB=1/Ton, Voltage Averaging Max Hold where: Ton is the duration of the packet

**HARMONICS AND SPURIOUS EMISSIONS**

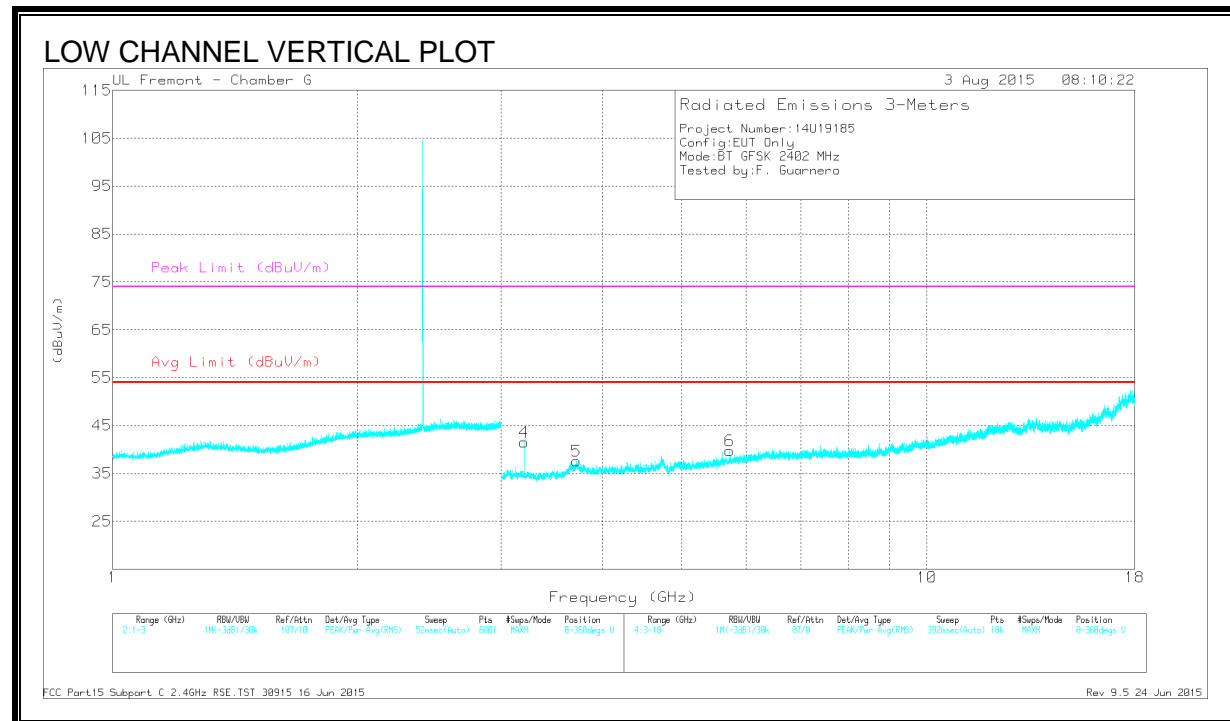
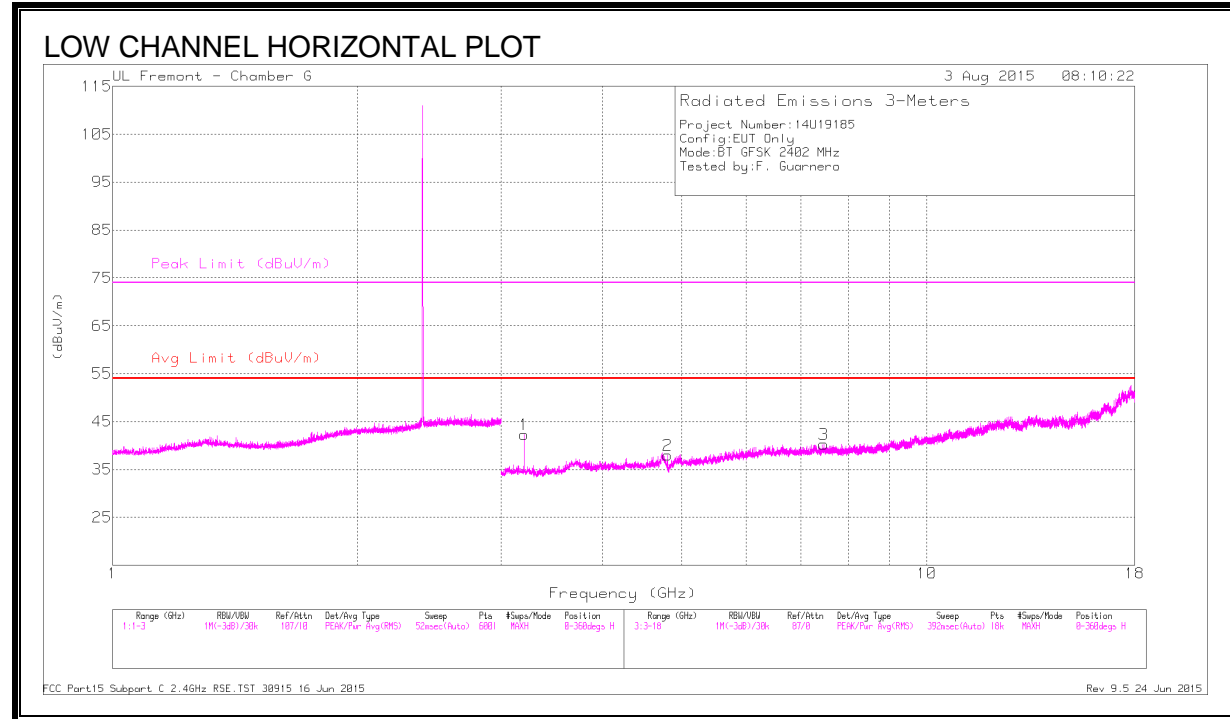

**DATA**

Markers	Frequency (GHz)	Meter Reading (dBuV)	Det	AF T862 (dB/m)	Amp/Cbl/Filtr/Pad (dB)	Corrected Reading (dBuV/m)	Avg Limit (dBuV/m)	Margin (dB)	Peak Limit (dBuV/m)	PK Margin (dB)	Azimuth (Degs)	Height (cm)	Polarity
1	3.203	46.97	PK2	33.1	-33.3	46.77	-	-	-	-	239	299	H
2	* 4.804	43.99	PK2	34	-32.7	45.29	-	-	74	-28.71	290	101	H
	* 4.804	33.41	VA1T	34	-32.7	34.71	54	-19.29	-	-	290	101	H
3	* 7.467	41.53	PK2	35.5	-30.1	46.93	-	-	74	-27.07	12	217	H
	* 7.466	28.36	VA1T	35.5	-30.1	33.76	54	-20.24	-	-	12	217	H
4	3.203	46.5	PK2	33.1	-33.3	46.3	-	-	-	-	302	100	V
5	* 3.712	41.86	PK2	33	-31.4	43.46	-	-	74	-30.54	128	158	V
	* 3.712	29.15	VA1T	33	-31.4	30.75	54	-23.25	-	-	128	158	V
6	5.727	41.94	PK2	35	-31.6	45.34	-	-	-	-	232	244	V

\* - indicates frequency in CFR 47, Part 15 and Industry Canada RSS-Restricted Band.

PK3 - FHSS Method: Maximum Peak

VB10Hz - FHSS Method: 10Hz Video Bandwidth



**HARMONICS AND SPURIOUS EMISSIONS**

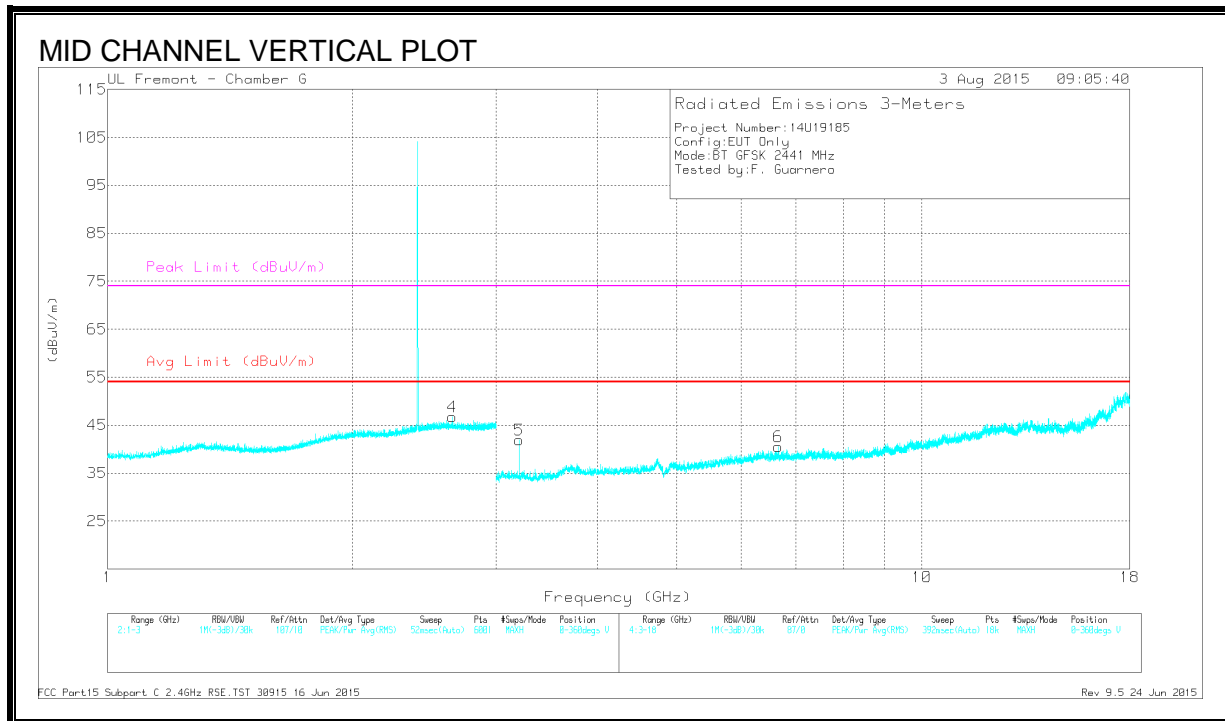
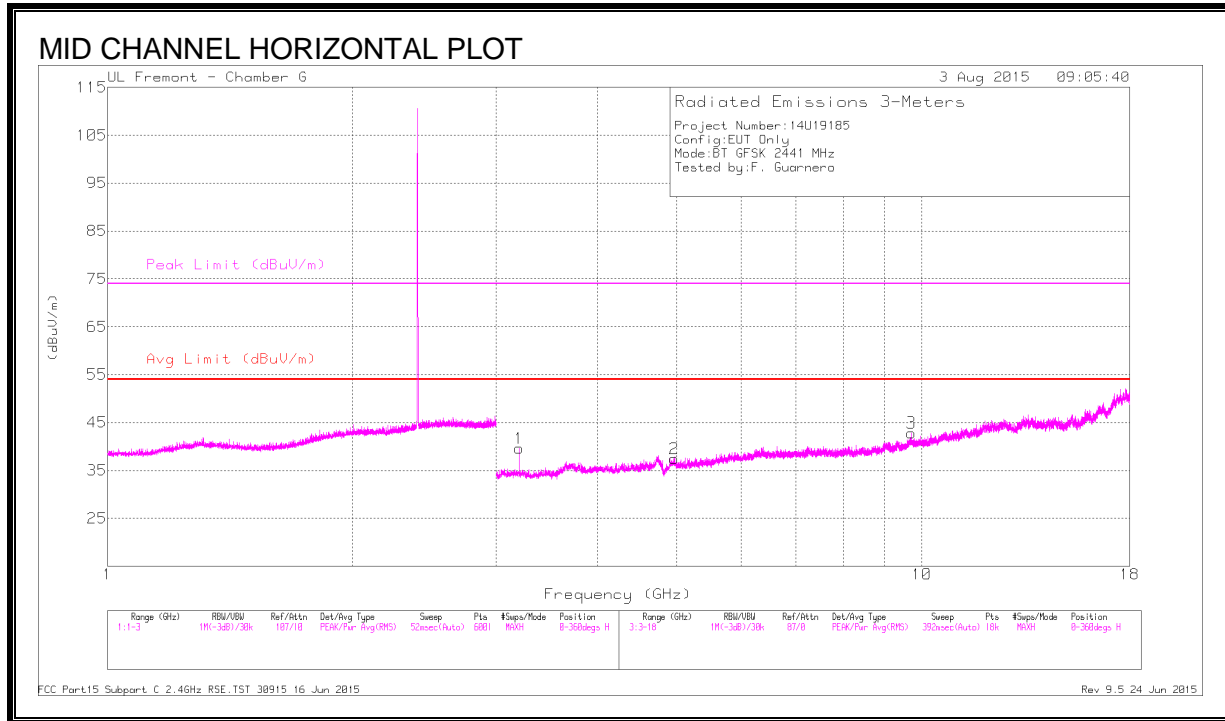

**DATA**

Marker	Frequency (GHz)	Meter Reading (dBuV)	Det	AF T862 (dB/m)	Amp/Cbl/ Fitr/Pad (dB)	Corrected Reading (dBuV/m)	Avg Limit (dBuV/m)	Margin (dB)	Peak Limit (dBuV/m)	PK Margin (dB)	Azimuth (Degs)	Height (cm)	Polarity
1	3.203	46.55	PK2	33.1	-33.3	46.35	-	-	-	-	63	240	H
2	* 4.964	43.49	PK2	34.2	-32.4	45.29	-	-	74	-28.71	106	109	H
	* 4.966	30.4	VA1T	34.2	-32.4	32.2	54	-21.8	-	-	106	109	H
3	9.702	39.23	PK2	36.8	-27.5	48.53	-	-	-	-	126	197	H
4	2.651	44.19	PK2	32.4	-24.4	52.19	-	-	-	-	13	152	V
5	3.203	46.39	PK2	33.1	-33.3	46.19	-	-	-	-	128	102	V
6	6.656	41.4	PK2	35.7	-30.9	46.2	-	-	-	-	25	109	V

\* - indicates frequency in CFR 47, Part 15 and Industry Canada RSS-Restricted Band.

PK3 - FHSS Method: Maximum Peak

VB10Hz - FHSS Method: 10Hz Video Bandwidth

**HARMONICS AND SPURIOUS EMISSIONS**

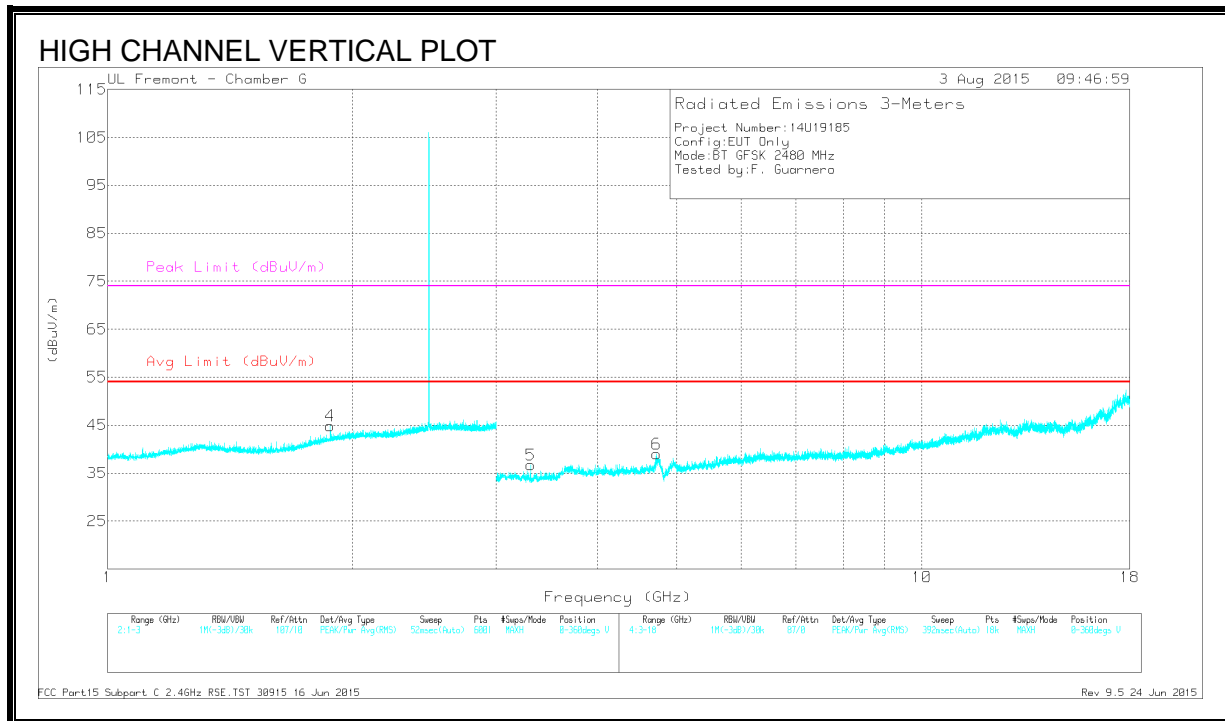
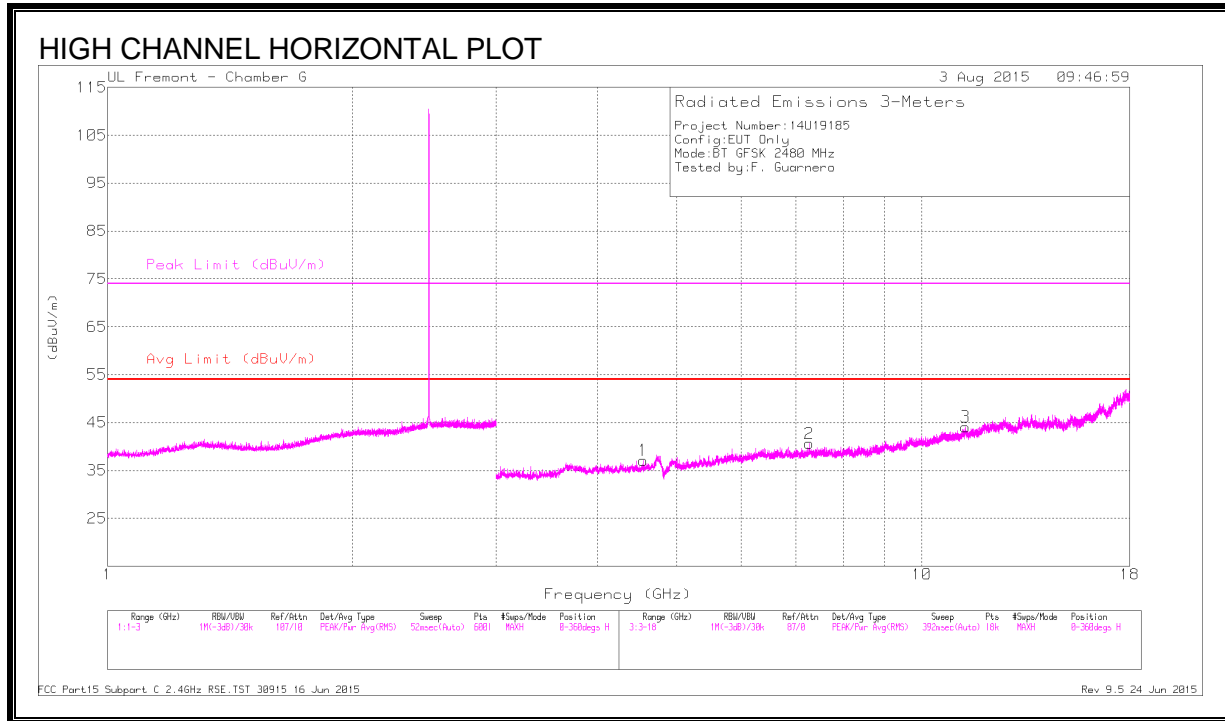

**DATA**

Marker	Frequency (GHz)	Meter Reading (dBuV)	Det	AF T862 (dB/m)	Amp/Cbl/ Fitr/Pad (dB)	Corrected Reading (dBuV/m)	Avg Limit (dBuV/m)	Margin (dB)	Peak Limit (dBuV/m)	PK Margin (dB)	Azimuth (Degs)	Height (cm)	Polarity
1	* 4.547	42.31	PK2	33.7	-32.6	43.41	-	-	74	-30.59	270	189	H
	* 4.547	29.2	VA1T	33.7	-32.6	30.3	54	-23.7	-	-	270	189	H
2	* 7.269	41.1	PK2	35.6	-29.9	46.8	-	-	74	-27.2	133	216	H
	* 7.266	28.11	VA1T	35.6	-30	33.71	54	-20.29	-	-	133	216	H
3	* 11.31	37.96	PK2	38	-25	50.96	-	-	74	-23.04	207	124	H
	* 11.309	25.03	VA1T	38	-25.1	37.93	54	-16.07	-	-	207	124	H
4	1.879	44.3	PK2	30.8	-25.1	50	-	-	-	-	34	126	V
5	3.307	44.38	PK2	32.7	-33.1	43.98	-	-	-	-	298	104	V
6	* 4.719	43.7	PK2	33.9	-32.3	45.3	-	-	74	-28.7	190	228	V
	* 4.72	31.3	VA1T	33.9	-32.3	32.9	54	-21.1	-	-	190	228	V

\* - indicates frequency in CFR 47, Part 15 and Industry Canada RSS-Restricted Band.

PK3 - FHSS Method: Maximum Peak

VB10Hz - FHSS Method: 10Hz Video Bandwidth

## 7.2.2. ENHANCED DATA RATE 8PSK MODULATION

### RESTRICTED BANDEDGE (LOW CHANNEL, HORIZONTAL)

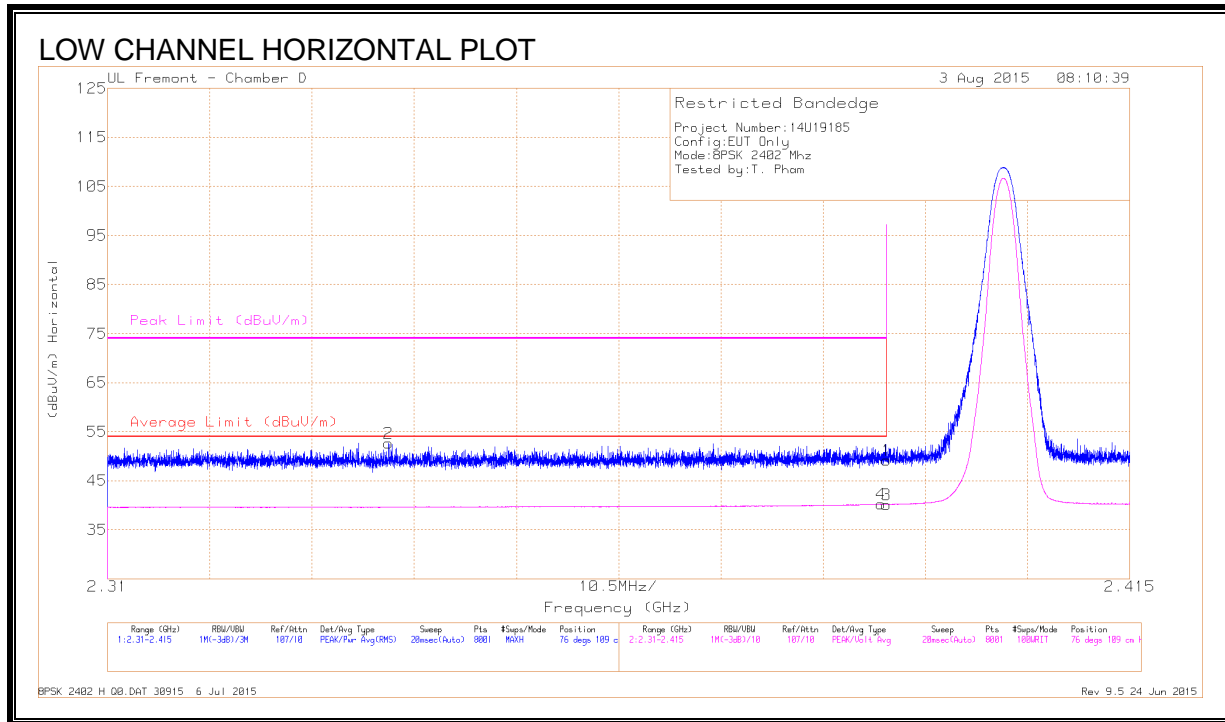

### DATA

Marker	Frequency (GHz)	Meter Reading (dBuV)	Det	AF T344 (dB/m)	Amp/Cbl/Fitr/Pad (dB)	Corrected Reading (dBuV/m)	Average Limit (dBuV/m)	Margin (dB)	Peak Limit (dBuV/m)	PK Margin (dB)	Azimuth (Degs)	Height (cm)	Polarity
1	* 2.39	37.78	Pk	32.1	-20.7	49.18	-	-	74	-24.82	76	109	H
2	* 2.339	41.57	Pk	32	-20.9	52.67	-	-	74	-21.33	76	109	H
3	* 2.39	28.76	VA1T	32.1	-20.7	40.16	54	-13.84	-	-	76	109	H
4	* 2.389	28.79	VA1T	32.1	-20.7	40.19	54	-13.81	-	-	76	109	H

\* - indicates frequency in CFR 47, Part 15 and Industry Canada RSS-Restricted Band.

PK - Peak detector

VB1T - FHSS Method: VB=1/Ton, Voltage Averaging Max Hold where: Ton is the duration of the packet

**RESTRICTED BANDEGE (LOW CHANNEL, VERTICAL)**

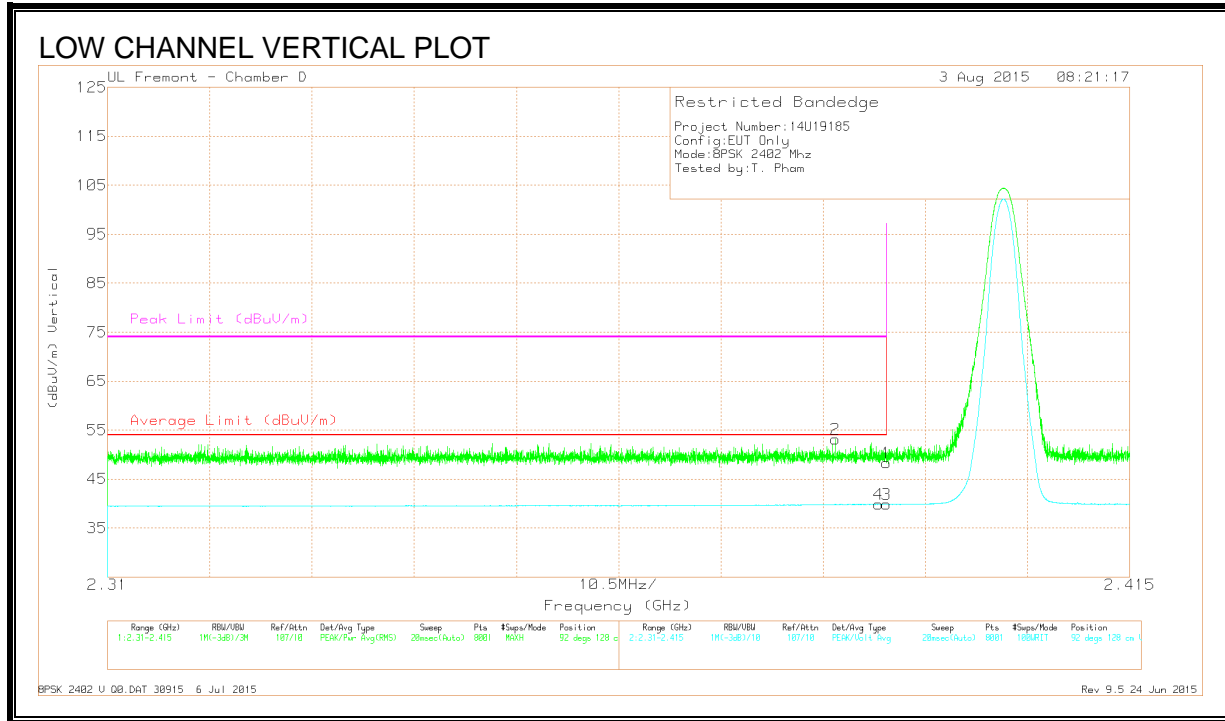

**DATA**

Marker	Frequency (GHz)	Meter Reading (dBuV)	Det	AF T344 (dB/m)	Amp/Cbl/Fitr/Pad (dB)	Corrected Reading (dBuV/m)	Average Limit (dBuV/m)	Margin (dB)	Peak Limit (dBuV/m)	PK Margin (dB)	Azimuth (Degs)	Height (cm)	Polarity
1	* 2.39	36.91	Pk	32.1	-20.7	48.31	-	-	74	-25.69	92	128	V
2	* 2.385	41.8	Pk	32.1	-20.8	53.1	-	-	74	-20.9	92	128	V
3	* 2.39	28.46	VA1T	32.1	-20.7	39.86	54	-14.14	-	-	92	128	V
4	* 2.389	28.46	VA1T	32.1	-20.7	39.86	54	-14.14	-	-	92	128	V

\* - indicates frequency in CFR 47, Part 15 and Industry Canada RSS-Restricted Band.

PK - Peak detector

VB1T - FHSS Method: VB=1/Ton, Voltage Averaging Max Hold where: Ton is the duration of the packet

**RESTRICTED BANDEDGE (HIGH CHANNEL, HORIZONTAL)**

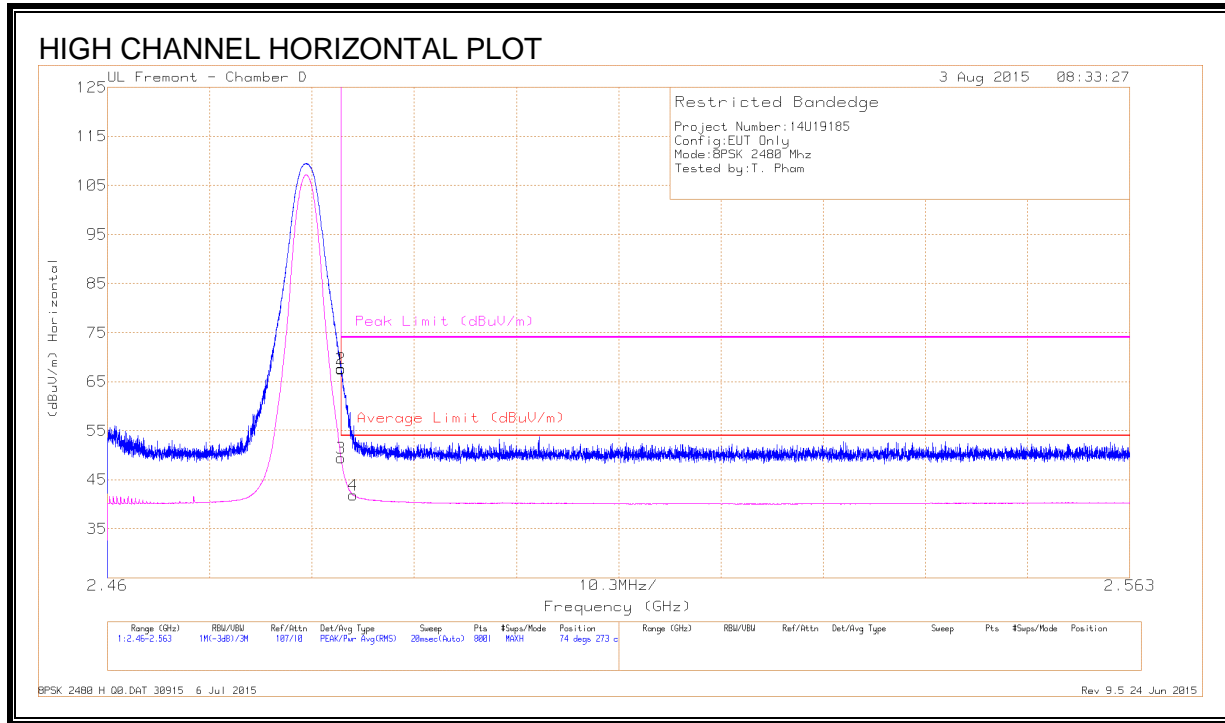

**DATA**

Marker	Frequency (GHz)	Meter Reading (dBuV)	Det	AF T344 (dB/m)	Amp/Cb/ Ftr/Pad (dB)	Corrected Reading (dBuV/m)	Average Limit (dBuV/m)	Margin (dB)	Peak Limit (dBuV/m)	PK Margin (dB)	Azimuth (Degs)	Height (cm)	Polarity
1	* 2.484	56.12	Pk	32.2	-20.8	67.52	-	-	74	-6.48	74	273	H
2	* 2.484	56.31	Pk	32.2	-20.8	67.71	-	-	74	-6.29	74	273	H
3	* 2.484	38	VA1T	32.2	-20.8	49.4	54	-4.6	-	-	74	273	H
4	* 2.485	30.4	VA1T	32.2	-20.8	41.8	54	-12.2	-	-	74	273	H

\* - indicates frequency in CFR 47, Part 15 and Industry Canada RSS-Restricted Band.

PK - Peak detector

VB1T - FHSS Method: VB=1/Ton, Voltage Averaging Max Hold where: Ton is the duration of the packet

**RESTRICTED BANDEDGE (HIGH CHANNEL, VERTICAL)**

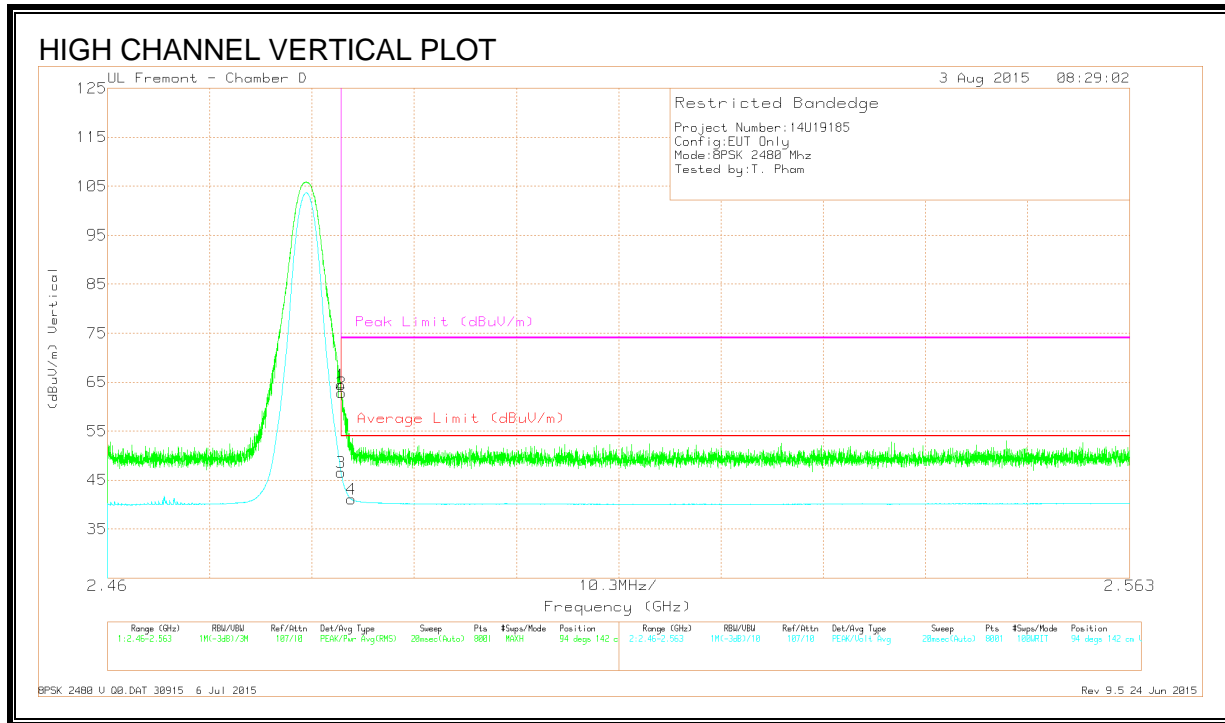

**DATA**

Marker	Frequency (GHz)	Meter Reading (dBuV)	Det	AF T344 (dB/m)	Amp/Cbl/Fitr/Pad (dB)	Corrected Reading (dBuV/m)	Average Limit (dBuV/m)	Margin (dB)	Peak Limit (dBuV/m)	PK Margin (dB)	Azimuth (Degs)	Height (cm)	Polarity
1	* 2.484	53.07	Pk	32.2	-20.8	64.47	-	-	74	-9.53	94	142	V
2	* 2.484	51.43	Pk	32.2	-20.8	62.83	-	-	74	-11.17	94	142	V
3	* 2.484	35.18	VA1T	32.2	-20.8	46.58	54	-7.42	-	-	94	142	V
4	* 2.485	29.66	VA1T	32.2	-20.8	41.06	54	-12.94	-	-	94	142	V

\* - indicates frequency in CFR 47, Part 15 and Industry Canada RSS-Restricted Band.

PK - Peak detector

VB1T - FHSS Method: VB=1/Ton, Voltage Averaging Max Hold where: Ton is the duration of the packet



**HARMONICS AND SPURIOUS EMISSIONS**

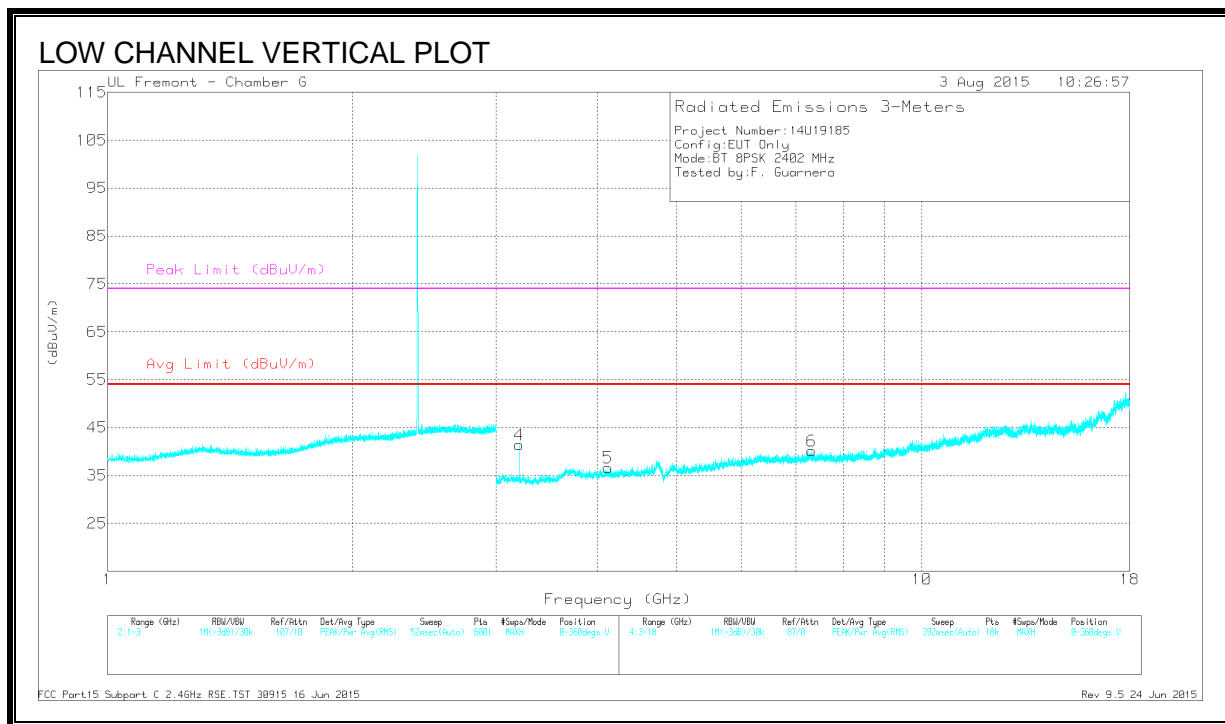
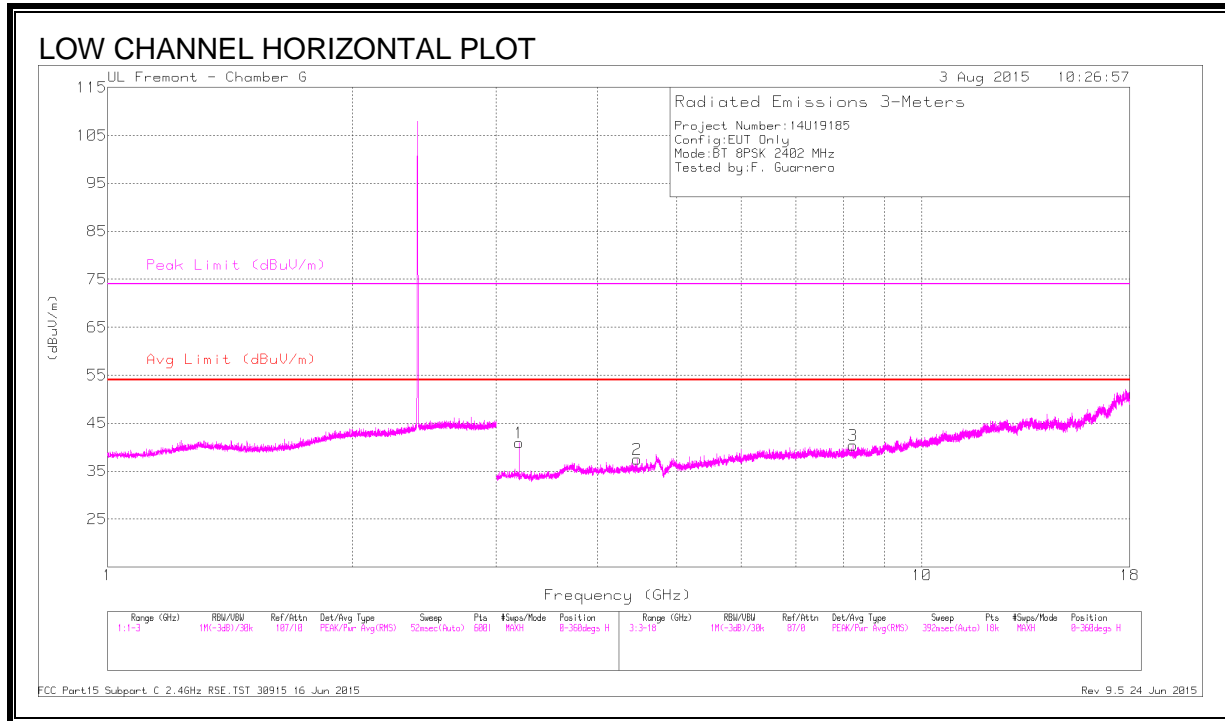

**DATA**

Marker	Frequency (GHz)	Meter Reading (dBuV)	Det	AF T862 (dB/m)	Amp/Cbl/ Fitr/Pad (dB)	Corrected Reading (dBuV/m)	Avg Limit (dBuV/m)	Margin (dB)	Peak Limit (dBuV/m)	PK Margin (dB)	Azimuth (Degs)	Height (cm)	Polarity
1	3.203	48.3	PK2	33.1	-33.3	48.1	-	-	-	-	62	240	H
2	4.467	42.92	PK2	33.6	-32.8	43.72	-	-	-	-	273	235	H
3	* 8.236	40.48	PK2	35.7	-30	46.18	-	-	74	-27.82	258	111	H
	* 8.234	27.46	VA1T	35.7	-30	33.16	54	-20.84	-	-	258	111	H
4	3.203	47.44	PK2	33.1	-33.3	47.24	-	-	-	-	131	103	V
5	* 4.111	42.44	PK2	33.3	-32.7	43.04	-	-	74	-30.96	69	209	V
	* 4.114	29.66	VA1T	33.3	-32.7	30.26	54	-23.74	-	-	69	209	V
6	* 7.329	41.23	PK2	35.6	-30.7	46.13	-	-	74	-27.87	151	229	V
	* 7.326	28.45	VA1T	35.6	-30.6	33.45	54	-20.55	-	-	151	229	V

\* - indicates frequency in CFR 47, Part 15 and Industry Canada RSS-Restricted Band.

PK3 - FHSS Method: Maximum Peak

VB10Hz - FHSS Method: 10Hz Video Bandwidth

**HARMONICS AND SPURIOUS EMISSIONS**

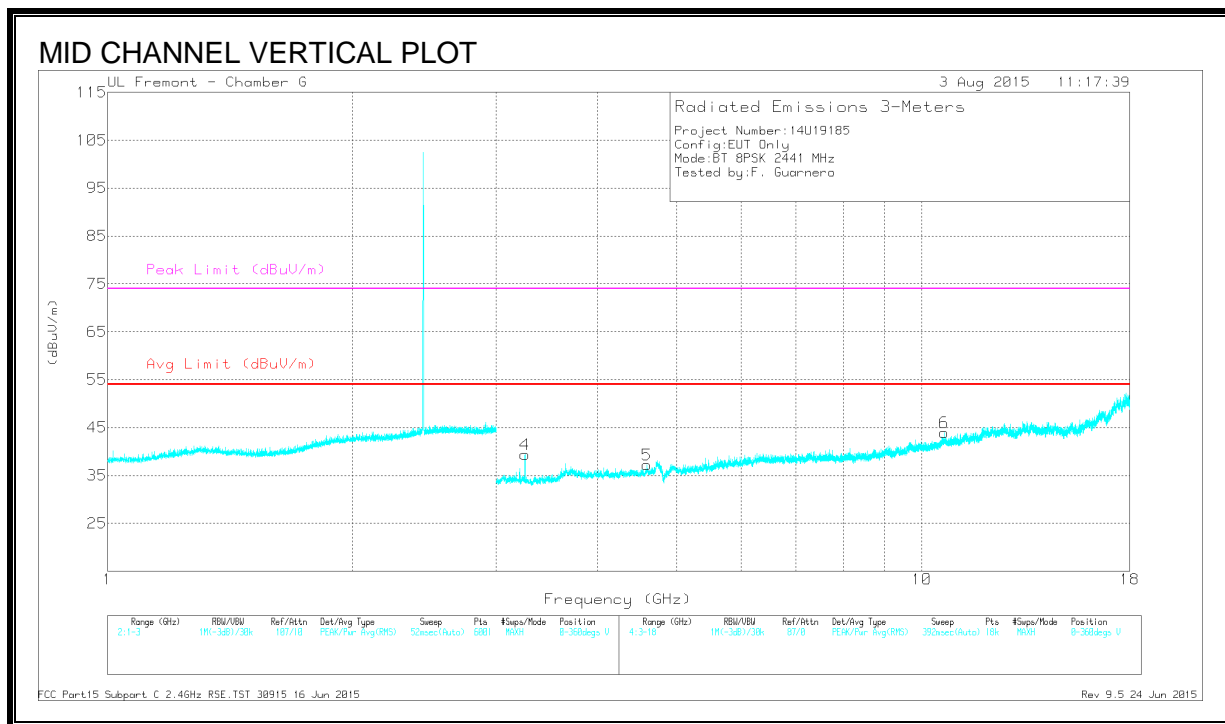
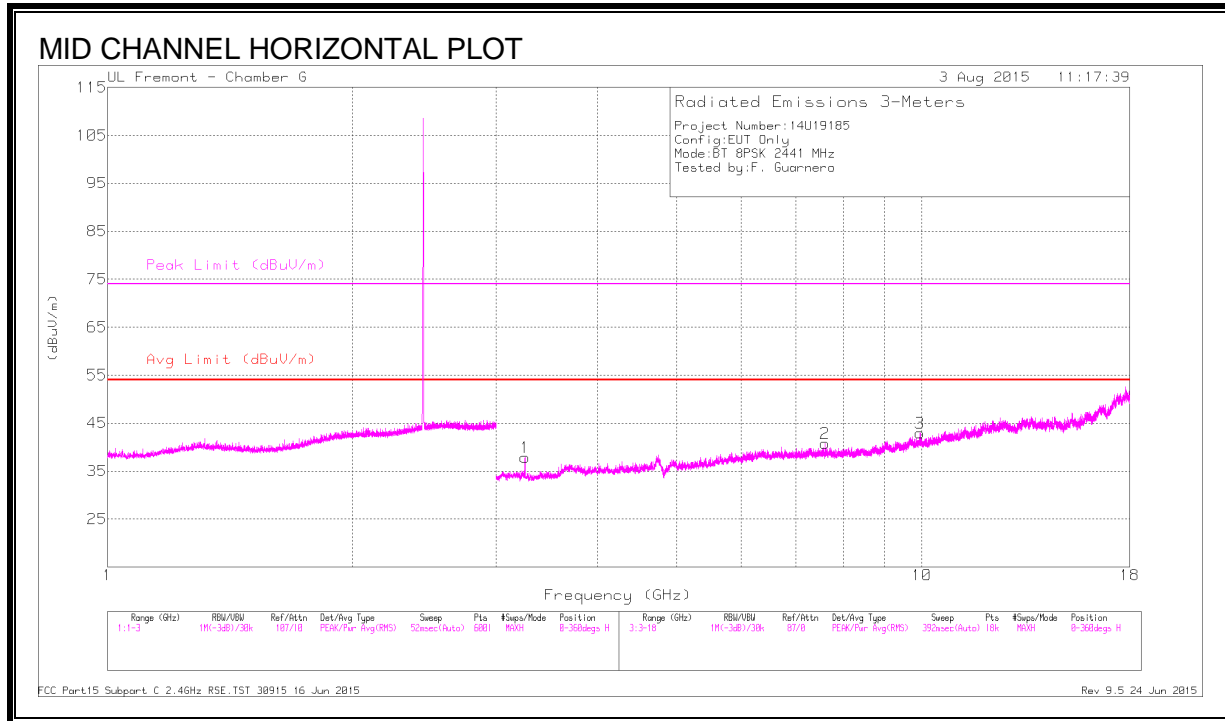

**DATA**

Marker	Frequency (GHz)	Meter Reading (dBuV)	Det	AF T862 (dB/m)	Amp/Cbl/ Fitr/Pad (dB)	Corrected Reading (dBuV/m)	Avg Limit (dBuV/m)	Margin (dB)	Peak Limit (dBuV/m)	PK Margin (dB)	Azimuth (Degs)	Height (cm)	Polarity
1	3.255	46.6	PK2	32.9	-33.1	46.4	-	-	-	-	69	253	H
2	* 7.608	40.54	PK2	35.6	-29.9	46.24	-	-	74	-27.76	170	210	H
	* 7.606	27.69	VA1T	35.6	-29.9	33.39	54	-20.61	-	-	170	210	H
3	9.953	38.86	PK2	37	-27.4	48.46	-	-	-	-	53	114	H
4	3.255	46.01	PK2	32.9	-33.1	45.81	-	-	-	-	129	101	V
5	* 4.59	42.43	PK2	33.8	-32.5	43.73	-	-	74	-30.27	111	213	V
	* 4.593	29.63	VA1T	33.8	-32.5	30.93	54	-23.07	-	-	111	213	V
6	* 10.647	38.48	PK2	37.8	-26	50.28	-	-	74	-23.72	59	156	V
	* 10.647	25.3	VA1T	37.8	-26	37.1	54	-16.9	-	-	59	156	V

\* - indicates frequency in CFR 47, Part 15 and Industry Canada RSS-Restricted Band.

PK3 - FHSS Method: Maximum Peak

VB10Hz - FHSS Method: 10Hz Video Bandwidth

**HARMONICS AND SPURIOUS EMISSIONS**

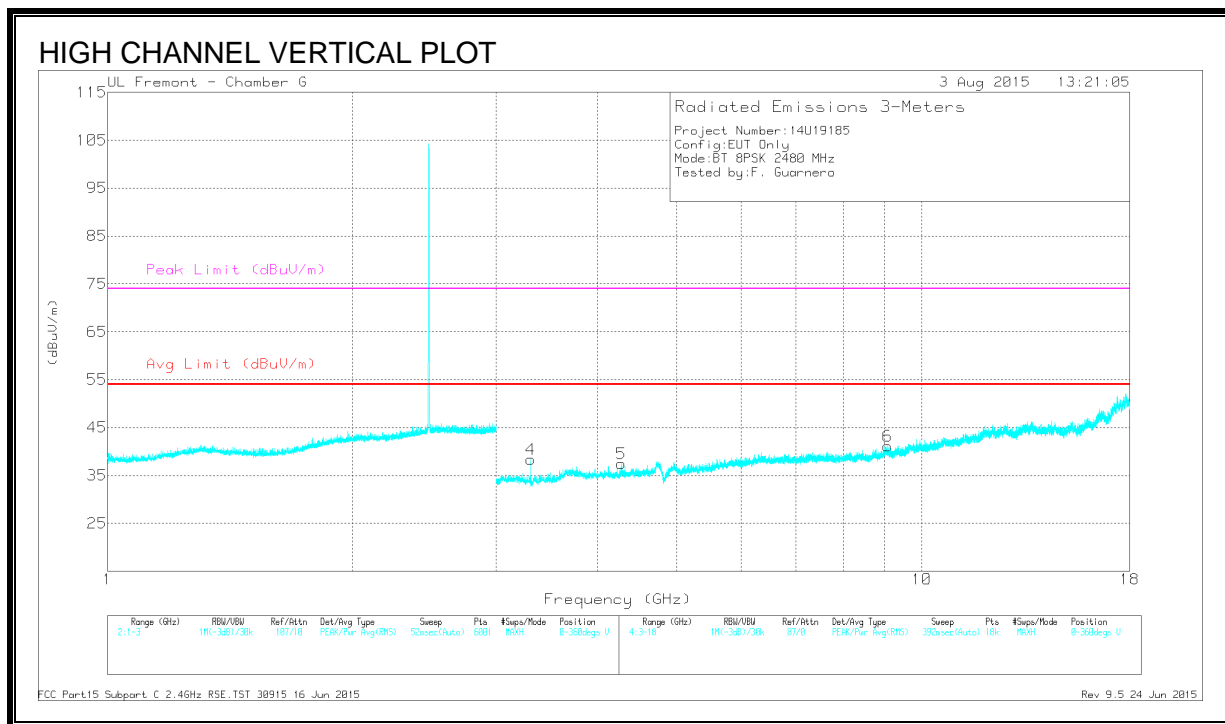
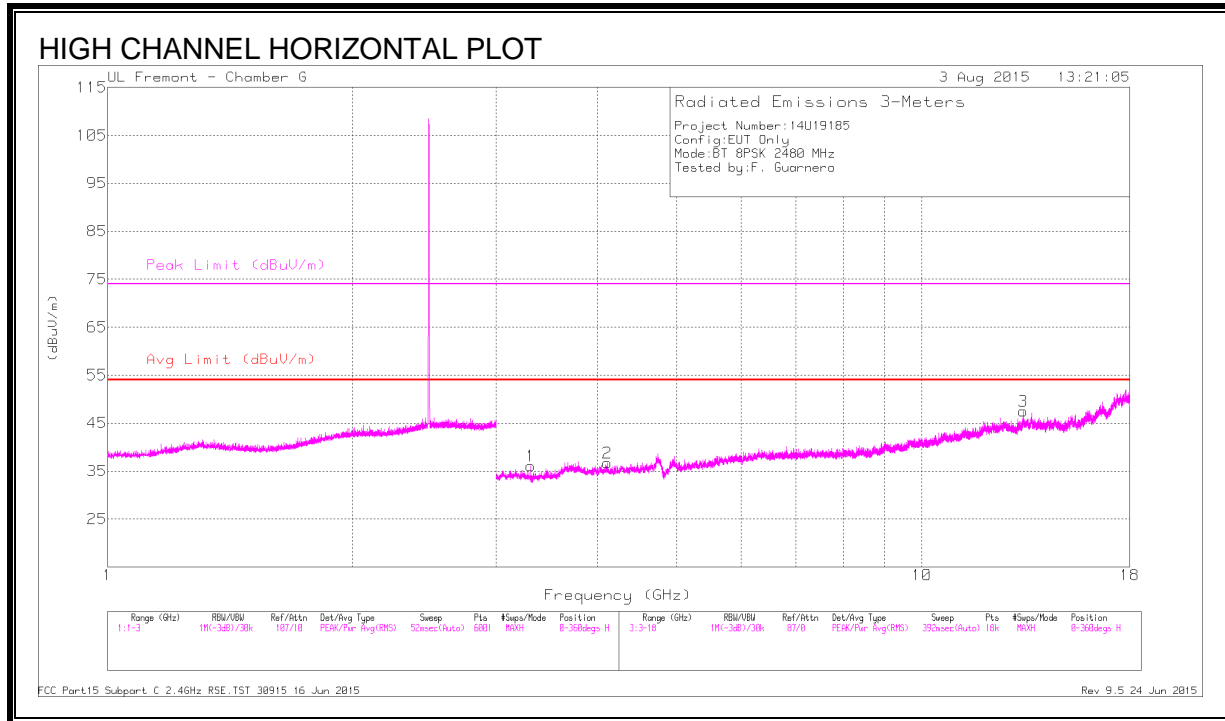

**DATA**

Marker	Frequency (GHz)	Meter Reading (dBuV)	Det	AF T862 (dB/m)	Amp/Cbl/ Fitr/Pad (dB)	Corrected Reading (dBuV/m)	Avg Limit (dBuV/m)	Margin (dB)	Peak Limit (dBuV/m)	PK Margin (dB)	Azimuth (Degs)	Height (cm)	Polarity
1	3.307	44.56	PK2	32.7	-33.1	44.16	-	-	-	-	318	233	H
2	* 4.105	42.51	PK2	33.3	-32.7	43.11	-	-	74	-30.89	4	231	H
	* 4.104	29.52	VA1T	33.3	-32.7	30.12	54	-23.88	-	-	4	231	H
3	* 13.329	39.22	PK2	39.6	-25.4	53.42	-	-	74	-20.58	94	161	H
	* 13.328	25.78	VA1T	39.6	-25.3	40.08	54	-13.92	-	-	94	161	H
4	3.307	44.57	PK2	32.7	-33.1	44.17	-	-	-	-	294	110	V
5	* 4.276	41.89	PK2	33.5	-32	43.39	-	-	74	-30.61	160	238	V
	* 4.279	29.04	VA1T	33.5	-32	30.54	54	-23.46	-	-	160	238	V
6	* 9.076	39.39	PK2	36.2	-28.4	47.19	-	-	74	-26.81	144	258	V
	* 9.075	26.79	VA1T	36.2	-28.4	34.59	54	-19.41	-	-	144	258	V

\* - indicates frequency in CFR 47, Part 15 and Industry Canada RSS-Restricted Band.

PK3 - FHSS Method: Maximum Peak

VB10Hz - FHSS Method: 10Hz Video Bandwidth

### 7.3. WORST CASE CO-LOCATION

#### BLUETOOTH AND 802.11 HT20 2Tx CDD MODE IN THE 5.6GHz BAND

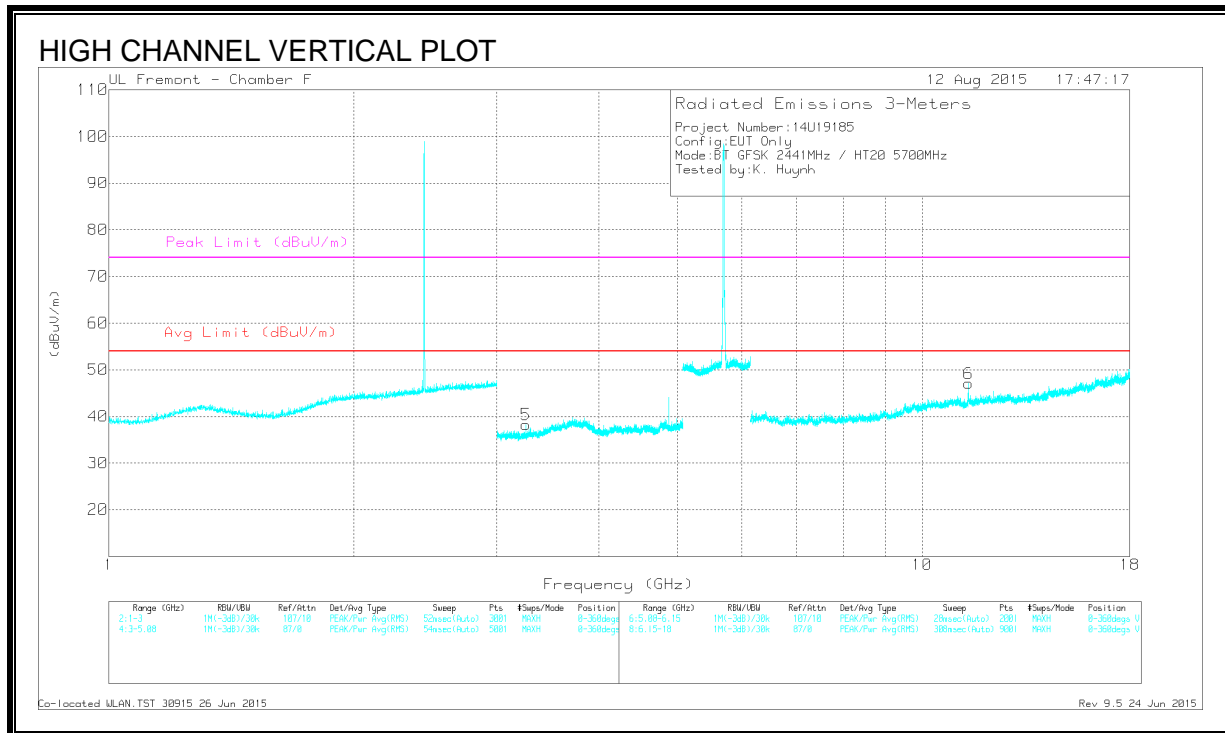
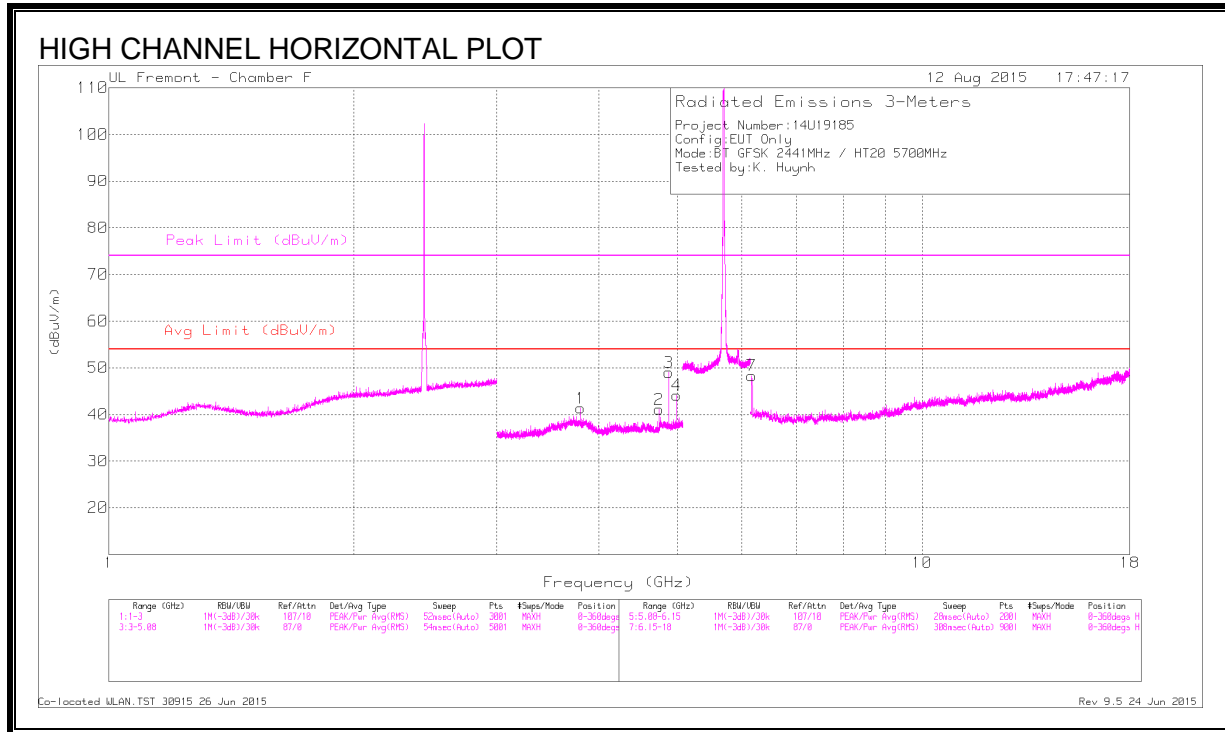

**DATA**

Marker	Frequency (GHz)	Meter Reading (dBuV)	Det	AF T120 (dB/m)	Amp/Cb/F ltr/Pad (dB)	Corrected Reading (dBuV/m)	Avg Limit (dBuV/m)	Margin (dB)	Peak Limit (dBuV/m)	Margin (dB)	Azimuth (Degs)	Height (cm)	Polarity
1	* 3.8	39.82	PK	34.1	-28.9	45.02	-	-	74	-28.98	151	103	H
	* 3.8	31.14	VB1T	34.1	-28.9	36.34	53.97	-17.63	-	-	151	103	H
2	* 4.75	39.83	PK	34.1	-28.4	45.53	-	-	74	-28.47	18	116	H
	* 4.75	32.03	VB1T	34.1	-28.4	37.73	53.97	-16.24	-	-	18	116	H
3	* 4.882	43.9	PK	34.1	-27.9	50.1	-	-	74	-23.9	38	204	H
	* 4.882	38.72	VB1T	34.1	-27.9	44.92	53.97	-9.05	-	-	38	204	H
4	* 4.987	42.84	PK	34.1	-28.9	48.04	-	-	74	-25.96	98	102	H
	* 4.987	35.75	VB1T	34.1	-28.9	40.95	53.97	-13.02	-	-	98	102	H
5	3.255	41.93	PK	33.2	-29.1	46.03	-	-	74	-27.97	120	159	V
	3.255	30.71	VB1T	33.2	-29.1	34.81	53.97	-19.16	-	-	120	159	V
6	* 11.403	38.03	PK	38.4	-22.4	54.03	-	-	74	-19.97	99	151	V
	* 11.4	26.14	VB1T	38.4	-22.5	42.04	53.97	-11.93	-	-	99	151	V
7	6.171	44.71	PK	35.7	-26.7	53.71	-	-	74	-20.29	139	181	H
	6.172	34.65	VB1T	35.7	-26.7	43.65	53.97	-10.32	-	-	139	181	H

\* - indicates frequency in CFR15.205/IC8.10 Restricted Band

PK - Peak detector

VB1T - FHSS Method: VB=1/Ton, Voltage Averaging Max Hold where: Ton is the duration of the packet



### 7.4. WORST-CASE BELOW 1 GHz

#### SPURIOUS EMISSIONS 30 TO 1000 MHz (WORST-CASE CONFIGURATION, HORIZONTAL)

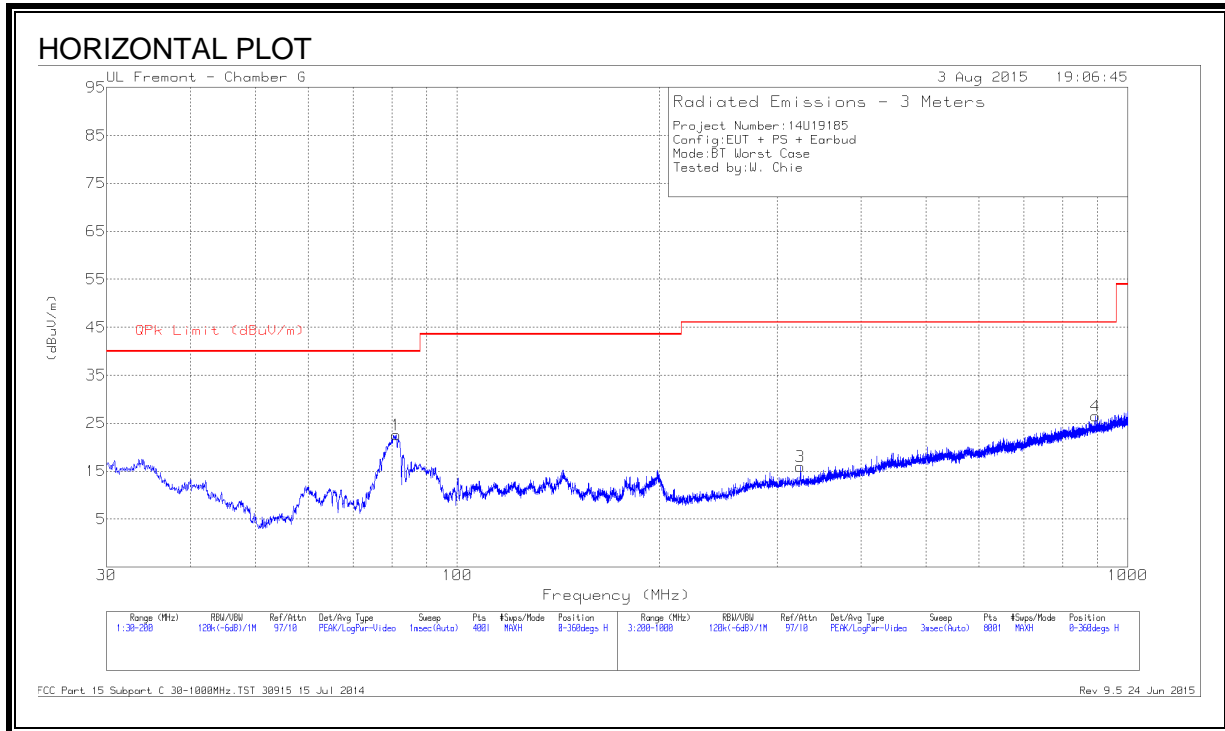

#### SPURIOUS EMISSIONS 30 TO 1000 MHz (WORST-CASE CONFIGURATION, VERTICAL)

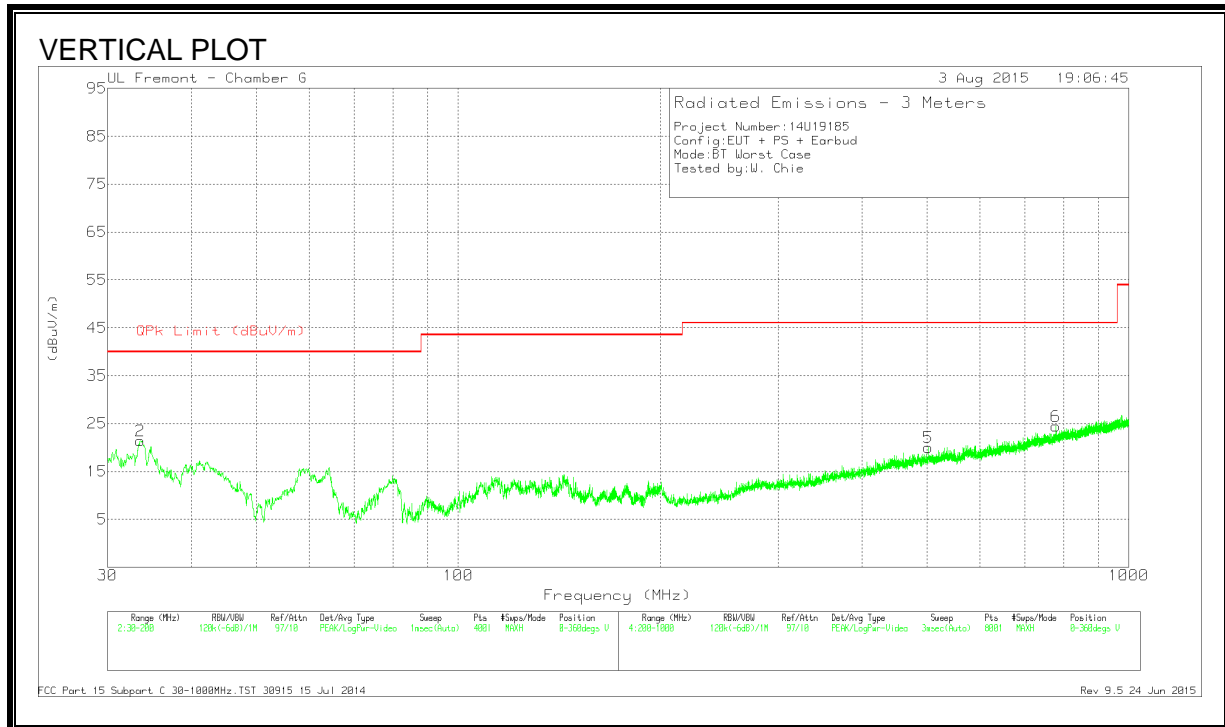

**DATA**

Marker	Frequency (MHz)	Meter Reading (dBuV)	Det	AF T899 (dB/m)	Amp Cbl (dB)	Corrected Reading (dBuV/m)	QPk Limit (dBuV/m)	Margin (dB)	Azimuth (Degs)	Height (cm)	Polarity
1	81.0425	45.68	Pk	7.6	-30.7	22.58	40	-17.42	0-360	201	H
2	33.57	33.46	Pk	19.2	-31.3	21.36	40	-18.64	0-360	100	V
3	* 324.9	30.9	Pk	13.8	-28.7	16	46.02	-30.02	0-360	100	H
4	895.4	30.52	Pk	22	-26	26.52	46.02	-19.5	0-360	401	H
5	502.1	30.2	Pk	17.7	-27.9	20	46.02	-26.02	0-360	100	V
6	777.7	30.5	Pk	20.9	-26.9	24.5	46.02	-21.52	0-360	301	V

\* - indicates frequency in CFR15.205/IC8.10 Restricted Band

Pk - Peak detector

### 7.5. WORST-CASE ABOVE 18 GHz

#### SPURIOUS EMISSIONS 18 TO 26 GHz (WORST-CASE CONFIGURATION, HORIZONTAL)

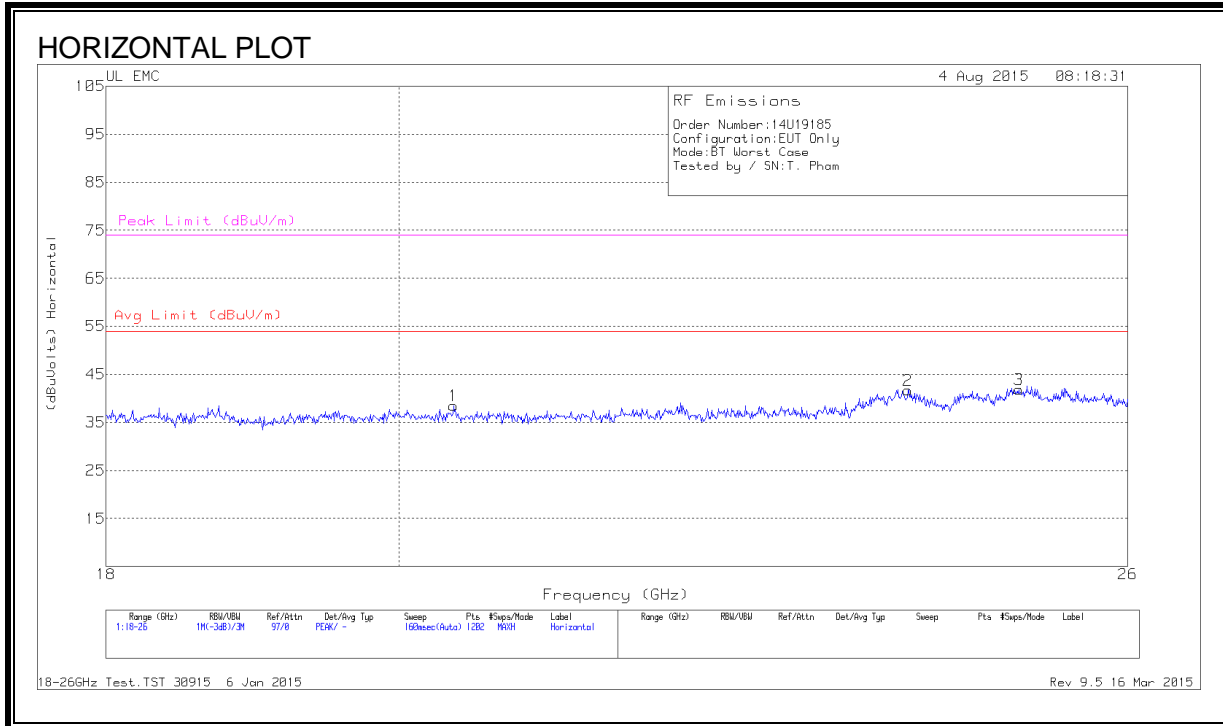

#### SPURIOUS EMISSIONS 18 TO 26 GHz (WORST-CASE CONFIGURATION, VERTICAL)

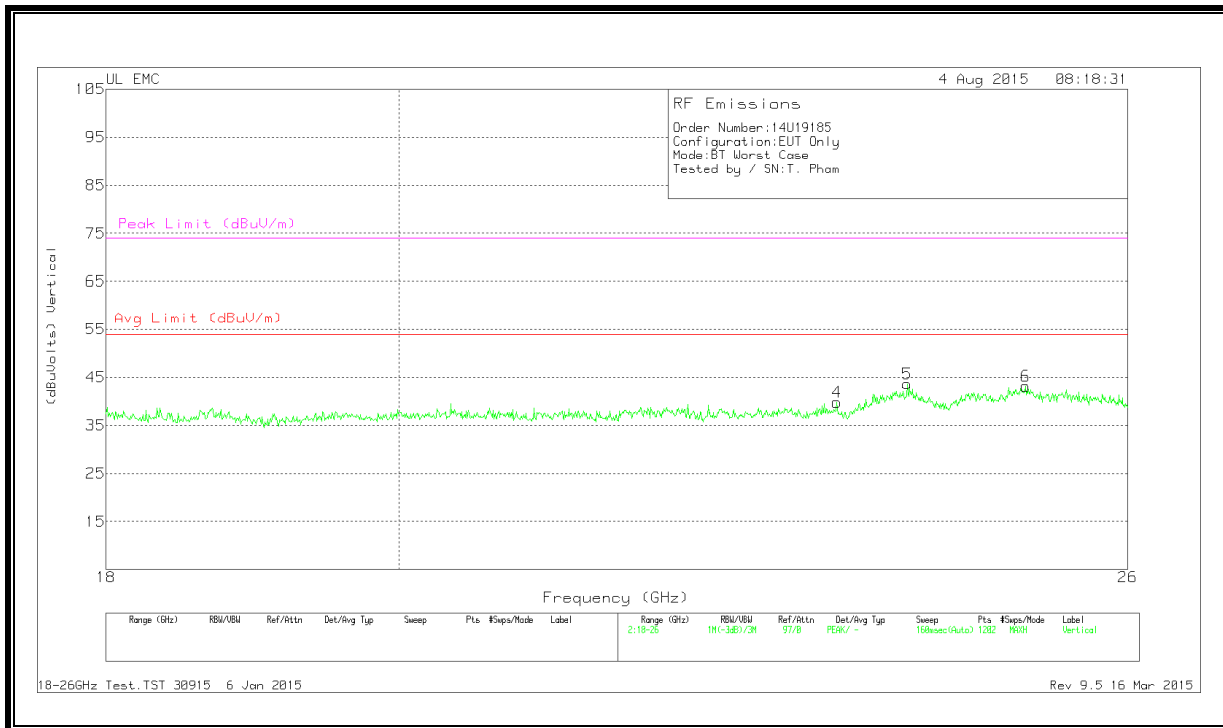

**Data**

Marker	Frequency (GHz)	Meter Reading (dBuV)	Det	T89 AF (dB/m)	Amp/Cbl (dB)	Dist Corr (dB)	Corrected Reading (dBuVolts)	Avg Limit (dBuV/m)	Margin (dB)	Peak Limit (dBuV/m)	PK Margin (dB)
1	20.398	40.5	Pk	32.6	-25.1	-9.5	38.5	54	-15.5	74	-35.5
2	24.022	42.07	Pk	33.3	-24.2	-9.5	41.67	54	-12.33	74	-32.33
3	25.001	41.73	Pk	34.2	-24.6	-9.5	41.83	54	-12.17	74	-32.17
4	23.415	40.43	Pk	33.3	-24.4	-9.5	39.83	54	-14.17	74	-34.17
5	24.015	44.17	Pk	33.3	-24.3	-9.5	43.67	54	-10.33	74	-30.33
6	25.061	43.67	Pk	34	-25	-9.5	43.17	54	-10.83	74	-30.83

Pk - Peak detector

## 8. AC POWER LINE CONDUCTED EMISSIONS

### LIMITS

FCC §15.207 (a)

RSS-Gen 8.8

Frequency of Emission (MHz)	Conducted Limit (dB $\mu$ V)	
	Quasi-peak	Average
0.15-0.5	66 to 56 *	56 to 46 *
0.5-5	56	46
5-30	60	50

\*Decreases with the logarithm of the frequency.

### TEST PROCEDURE

The EUT is placed on a non-conducting table 40 cm from the vertical ground plane and 80 cm above the horizontal ground plane. The EUT is configured in accordance with ANSI C63.10.

The receiver is set to a resolution bandwidth of 9 kHz. Peak detection is used unless otherwise noted as quasi-peak or average.

Line conducted data is recorded for both NEUTRAL and HOT lines.

## 8.1. EUT POWERED BY AC/DC ADAPTER VIA USB CABLE

### 6 WORST EMISSIONS

Range 1: Line-L1 .15 - 30MHz

7	Frequency (MHz)	Meter Reading (dBuV)	Det	T24 IL L1	LC Cables 1&3	Corrected Reading dBuV	CISPR 22 Class B QP	Margin (dB)	CISPR 22 Class B Avg	Margin (dB)
1	.177	37.5	Pk	1.1	0	38.6	64.63	-26.03	-	-
2	.1815	27.5	Av	1.1	0	28.6	-	-	54.42	-25.82
3	.2265	36.17	Pk	.8	0	36.97	62.58	-25.61	-	-
4	.2265	26.97	Av	.8	0	27.77	-	-	52.58	-24.81
5	.2715	35.38	Pk	.6	0	35.98	61.07	-25.09	-	-
6	.2715	26.33	Av	.6	0	26.93	-	-	51.07	-24.14
7	.61125	37.64	Pk	.3	0	37.94	56	-18.06	-	-
8	.609	27.67	Av	.3	0	27.97	-	-	46	-18.03
9	19.2525	41.78	Pk	.3	.2	42.28	60	-17.72	-	-
10	19.0275	25.27	Av	.3	.2	25.77	-	-	50	-24.23

Range 2: Line-L2 .15 - 30MHz

Marker	Frequency (MHz)	Meter Reading (dBuV)	Det	T24 IL L2	LC Cables 2&3	Corrected Reading dBuV	CISPR 22 Class B QP	Margin (dB)	CISPR 22 Class B Avg	Margin (dB)
11	.1815	38.8	Pk	1.2	0	40	64.42	-24.42	-	-
12	.1815	25.01	Av	1.2	0	26.21	-	-	54.42	-28.21
13	.222	38.01	Pk	.9	0	38.91	62.74	-23.83	-	-
14	.2265	23.3	Av	.9	0	24.2	-	-	52.58	-28.38
15	.276	37.14	Pk	.7	0	37.84	60.94	-23.1	-	-
16	.2715	21.95	Av	.7	0	22.65	-	-	51.07	-28.42
17	.6135	32.95	Pk	.3	0	33.25	56	-22.75	-	-
18	.609	19.04	Av	.3	0	19.34	-	-	46	-26.66
19	8.16	30.91	Pk	.2	.1	31.21	60	-28.79	-	-
20	8.124	20.96	Av	.2	.1	21.26	-	-	50	-28.74

Pk - Peak detector  
 Av - Average detection

**LINE 1 RESULTS**

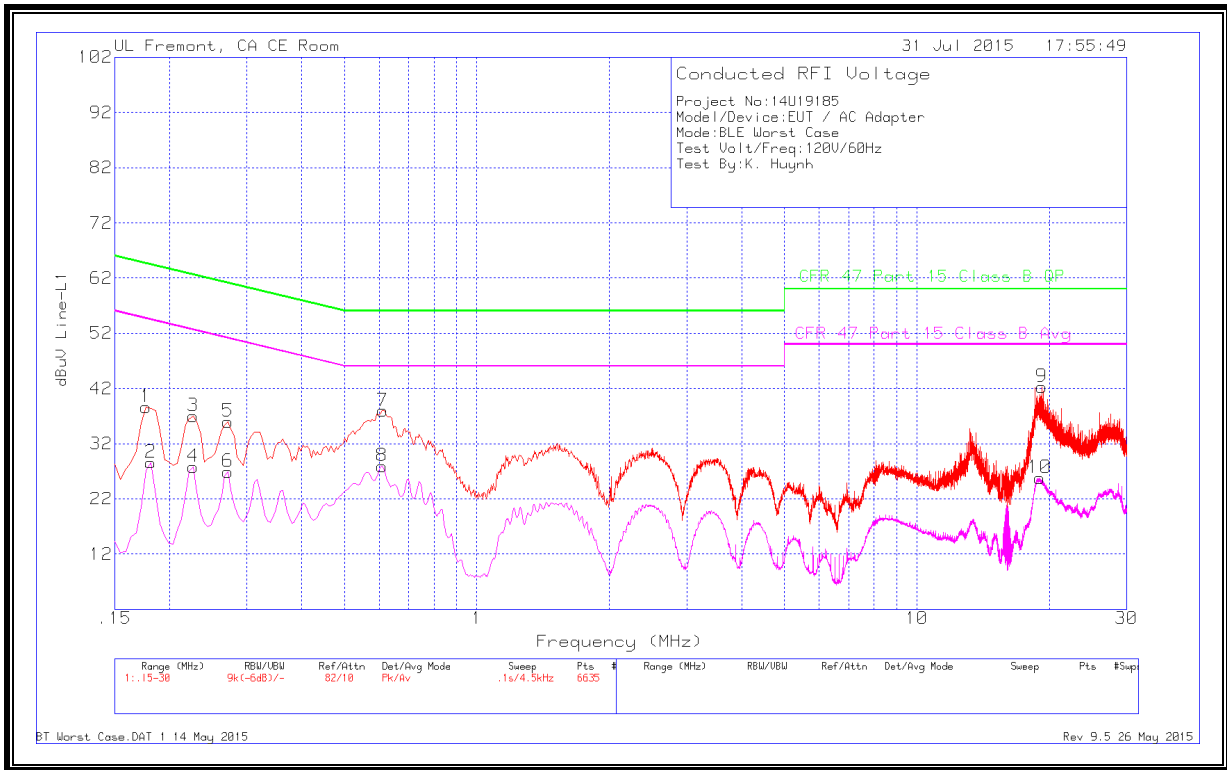

**LINE 2 RESULTS**

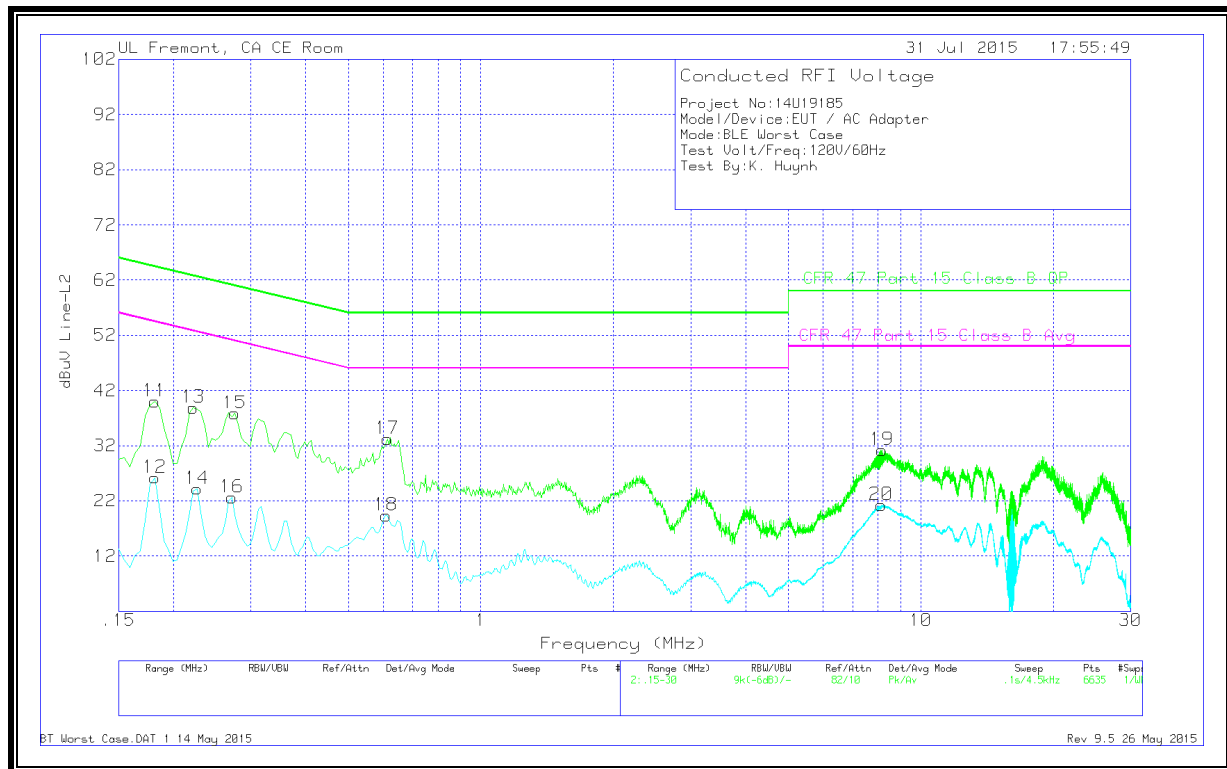

## 8.2. EUT POWERED BY HOST PC VIA USB CABLE

### 6 WORST EMISSIONS

Range 1: Line-L1 .15 - 30MHz

Marker	Frequency (MHz)	Meter Reading (dBuV)	Det	T24 IL L1	LC Cables 1&3	Corrected Reading dBuV	CISPR 22 Class B QP	Margin (dB)	CISPR 22 Class B Avg	Margin (dB)
1	.159	52.59	Pk	1.3	0	53.89	65.52	-11.63	-	-
2	.1545	40.09	Av	1.3	0	41.39	-	-	55.75	-14.36
3	.204	39.91	Pk	.9	0	40.81	63.45	-22.64	-	-
4	.2085	23.24	Av	.9	0	24.14	-	-	53.26	-29.12
5	.465	32.72	Pk	.4	0	33.12	56.6	-23.48	-	-
6	.465	17.77	Av	.4	0	18.17	-	-	46.6	-28.43
7	.7305	34.85	Pk	.3	0	35.15	56	-20.85	-	-
8	.7395	21.3	Av	.3	0	21.6	-	-	46	-24.4
9	1.0545	36.36	Pk	.2	0	36.56	56	-19.44	-	-
10	1.0365	21.69	Av	.2	0	21.89	-	-	46	-24.11
11	13.4385	50.2	Pk	.2	.2	50.6	60	-9.4	-	-
12	13.308	35.06	Av	.2	.2	35.46	-	-	50	-14.54
13	19.014	44.27	Pk	.3	.2	44.77	60	-15.23	-	-
14	19.032	29.32	Av	.3	.2	29.82	-	-	50	-20.18

Range 2: Line-L2 .15 - 30MHz

Marker	Frequency (MHz)	Meter Reading (dBuV)	Det	T24 IL L2	LC Cables 2&3	Corrected Reading dBuV	CISPR 22 Class B QP	Margin (dB)	CISPR 22 Class B Avg	Margin (dB)
15	.15	50.58	Pk	1.5	0	52.08	66	-13.92	-	-
16	.15	40.96	Av	1.5	0	42.46	-	-	56	-13.54
17	.681	34.18	Pk	.3	0	34.48	56	-21.52	-	-
18	.681	20.72	Av	.3	0	21.02	-	-	46	-24.98
19	13.3845	51.12	Pk	.2	.2	51.52	60	-8.48	-	-
20	13.3845	36.07	Av	.2	.2	36.47	-	-	50	-13.53
21	18.9195	47.19	Pk	.3	.2	47.69	60	-12.31	-	-
22	18.969	30.32	Av	.3	.2	30.82	-	-	50	-19.18

Pk - Peak detector  
 Av - Average detection



**LINE 1 RESULTS**

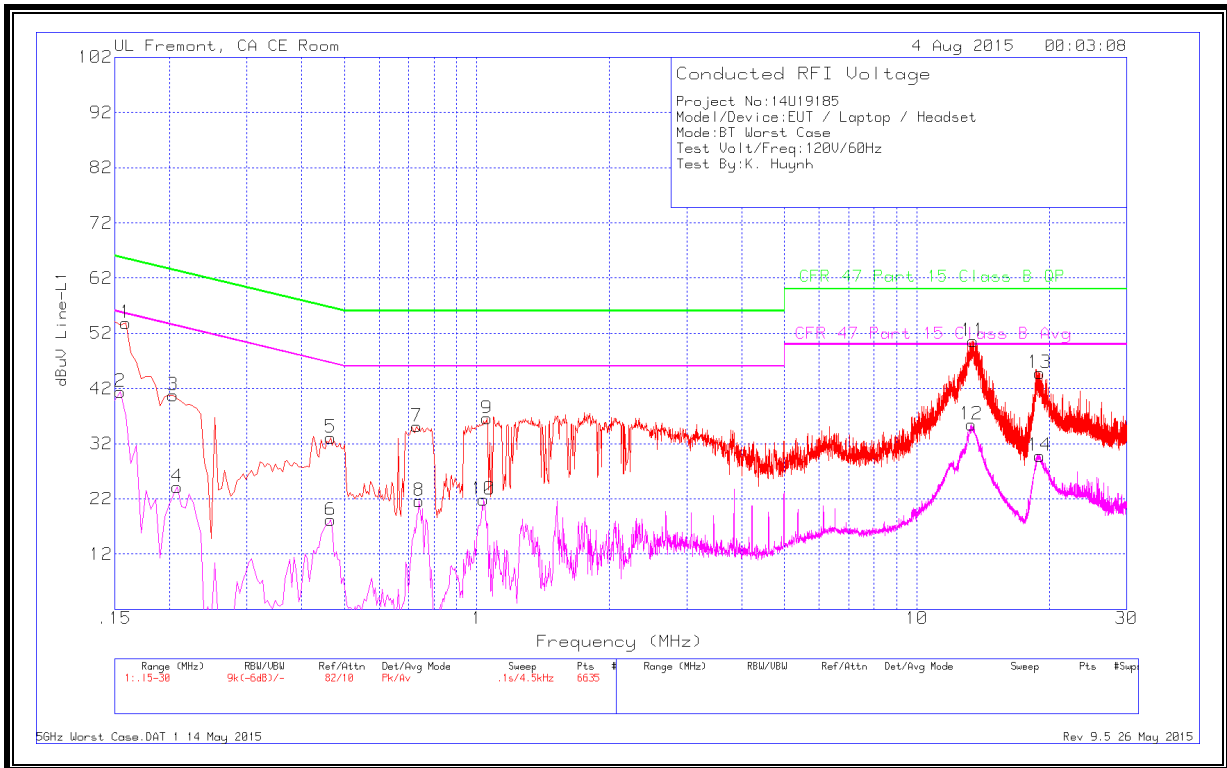

**LINE 2 RESULTS**

