



FCC 47 CFR PART 15 SUBPART E

CERTIFICATION TEST REPORT

FOR

TABLET DEVICE

MODEL NUMBER: A1550

FCC ID: BCGA1550

REPORT NUMBER: 14U19187-E5, REVISION B

ISSUE DATE: JUNE 01, 2015

Prepared for

APPLE, INC.

1 INFINITE LOOP

CUPERTINO, CA 95014, U.S.A.

Prepared by

UL VERIFICATION SERVICES INC.

47173 BENICIA STREET

FREMONT, CA 94538, U.S.A.

TEL: (510) 771-1000

FAX: (510) 661-0888



NVLAP LAB CODE 200065-0

Revision History

<u>Rev.</u>	<u>Issue Date</u>	<u>Revisions</u>	<u>Revised By</u>
--	04/21/2015	Initial Issue	M. Mekuria
A	05/18/2015	Revised report to address TCB questions	T. Chu
B	06/01/2015	Revised Section 2	T. Chu

TABLE OF CONTENTS

1. ATTESTATION OF TEST RESULTS	9
2. TEST METHODOLOGY	10
3. FACILITIES AND ACCREDITATION	10
4. CALIBRATION AND UNCERTAINTY	11
4.1. <i>MEASURING INSTRUMENT CALIBRATION</i>	<i>11</i>
4.2. <i>SAMPLE CALCULATION</i>	<i>11</i>
4.3. <i>MEASUREMENT UNCERTAINTY.....</i>	<i>11</i>
5. EQUIPMENT UNDER TEST	12
5.1. <i>DESCRIPTION OF EUT</i>	<i>12</i>
5.2. <i>MAXIMUM OUTPUT POWER</i>	<i>12</i>
5.3. <i>DESCRIPTION OF AVAILABLE ANTENNAS</i>	<i>14</i>
5.4. <i>SOFTWARE AND FIRMWARE.....</i>	<i>14</i>
5.5. <i>WORST-CASE CONFIGURATION AND MODE.....</i>	<i>15</i>
5.6. <i>DESCRIPTION OF TEST SETUP.....</i>	<i>16</i>
6. TEST AND MEASUREMENT EQUIPMENT	20
7. ON TIME, DUTY CYCLE AND MEASUREMENT METHODS	21
7.1. <i>ON TIME AND DUTY CYCLE.....</i>	<i>21</i>
7.2. <i>MEASUREMENT METHODS</i>	<i>25</i>
8. ANTENNA PORT TEST RESULTS.....	26
8.1. <i>802.11n HT20 SISO MODE IN THE 5.2 GHz BAND.....</i>	<i>26</i>
8.1.1. <i>26 dB BANDWIDTH.....</i>	<i>26</i>
8.1.2. <i>99% BANDWIDTH.....</i>	<i>28</i>
8.1.3. <i>AVERAGE POWER.....</i>	<i>30</i>
8.1.4. <i>OUTPUT POWER AND PSD.....</i>	<i>31</i>
8.2. <i>802.11n HT20 2Tx CDD MODE IN THE 5.2 GHz BAND.....</i>	<i>35</i>
8.2.1. <i>26 dB BANDWIDTH.....</i>	<i>35</i>
8.2.2. <i>99% BANDWIDTH.....</i>	<i>39</i>
8.2.3. <i>AVERAGE POWER.....</i>	<i>43</i>
8.2.4. <i>OUTPUT POWER AND PSD.....</i>	<i>44</i>
8.3. <i>802.11n HT20 2Tx STBC MODE IN THE 5.2 GHz BAND.....</i>	<i>50</i>
8.3.1. <i>26 dB BANDWIDTH.....</i>	<i>50</i>
8.3.2. <i>99% BANDWIDTH.....</i>	<i>54</i>
8.3.3. <i>AVERAGE POWER.....</i>	<i>58</i>
8.3.4. <i>OUTPUT POWER AND PSD.....</i>	<i>59</i>
8.4. <i>802.11n HT40 SISO MODE IN THE 5.2 GHz BAND.....</i>	<i>65</i>
8.4.1. <i>26 dB BANDWIDTH.....</i>	<i>65</i>

8.4.2. 99% BANDWIDTH..... 67
8.4.3. AVERAGE POWER..... 69
8.4.4. OUTPUT POWER AND PSD..... 70
8.5. 802.11n HT40 2Tx CDD MODE IN THE 5.2 GHz BAND..... 73
8.5.1. 26 dB BANDWIDTH..... 73
8.5.2. 99% BANDWIDTH..... 76
8.5.3. AVERAGE POWER..... 79
8.5.4. OUTPUT POWER AND PSD..... 80
8.6. 802.11n HT40 2Tx STBC MODE IN THE 5.2 GHz BAND..... 85
8.6.1. 26 dB BANDWIDTH..... 85
8.6.2. 99% BANDWIDTH..... 88
8.6.3. AVERAGE POWER..... 91
8.6.4. OUTPUT POWER AND PSD..... 92
8.7. 802.11ac VHT80 SISO MODE IN THE 5.2 GHz BAND..... 97
8.7.1. 26 dB BANDWIDTH..... 97
8.7.2. 99% BANDWIDTH..... 98
8.7.3. AVERAGE POWER..... 99
8.7.4. OUTPUT POWER AND PSD..... 100
8.8. 802.11ac VHT80 2Tx CDD MODE IN THE 5.2 GHz BAND..... 103
8.8.1. 26 dB BANDWIDTH..... 103
8.8.2. 99% BANDWIDTH..... 105
8.8.3. AVERAGE POWER..... 107
8.8.4. OUTPUT POWER AND PSD..... 108
8.9. 802.11n HT20 SISO MODE IN THE 5.3 GHz BAND..... 112
8.9.1. 26 dB BANDWIDTH..... 112
8.9.2. 99% BANDWIDTH..... 115
8.9.3. AVERAGE POWER..... 118
8.9.4. OUTPUT POWER AND PSD..... 119
8.10. 802.11n HT20 2Tx CDD MODE IN THE 5.3 GHz BAND..... 123
8.10.1. 26 dB BANDWIDTH..... 123
8.10.2. 99% BANDWIDTH..... 127
8.10.3. AVERAGE POWER..... 131
8.10.4. OUTPUT POWER AND PSD..... 132
8.11. 802.11n HT20 2Tx STBC MODE IN THE 5.3 GHz BAND..... 137
8.11.1. 26 dB BANDWIDTH..... 137
8.11.2. 99% BANDWIDTH..... 141
8.11.3. AVERAGE POWER..... 145
8.11.4. OUTPUT POWER AND PSD..... 146
8.12. 802.11n HT40 SISO MODE IN THE 5.3 GHz BAND..... 151
8.12.1. 26 dB BANDWIDTH..... 151
8.12.2. 99% BANDWIDTH..... 153
8.12.3. AVERAGE POWER..... 155
8.12.4. OUTPUT POWER AND PSD..... 156
8.13. 802.11n HT40 2Tx CDD MODE IN THE 5.3 GHz BAND..... 159
8.13.1. 26 dB BANDWIDTH..... 159
8.13.2. 99% BANDWIDTH..... 162
8.13.3. AVERAGE POWER..... 165
8.13.4. OUTPUT POWER AND PSD..... 166

8.14. 802.11n HT40 2Tx STBC MODE IN THE 5.3 GHz BAND 170
8.14.1. 26 dB BANDWIDTH 170
8.14.2. 99% BANDWIDTH 173
8.14.3. AVERAGE POWER 176
8.14.4. OUTPUT POWER AND PSD 177

8.15. 802.11ac VHT80 SISO MODE IN THE 5.3 GHz BAND 181
8.15.1. 26 dB BANDWIDTH 181
8.15.2. 99% BANDWIDTH 183
8.15.3. AVERAGE POWER 185
8.15.4. OUTPUT POWER AND PSD 186

8.16. 802.11ac VHT80 2Tx CDD MODE IN THE 5.3 GHz BAND 189
8.16.1. 26 dB BANDWIDTH 189
8.16.2. 99% BANDWIDTH 191
8.16.3. AVERAGE POWER 193
8.16.4. OUTPUT POWER AND PSD 194

8.17. 802.11n HT20 SISO MODE IN THE 5.6 GHz BAND 197
8.17.1. 26 dB BANDWIDTH 197
8.17.2. 99% BANDWIDTH 200
8.17.3. AVERAGE POWER 203
8.17.4. OUTPUT POWER AND PSD 204

8.18. 802.11n HT20 2Tx CDD MODE IN THE 5.6 GHz BAND 213
8.18.1. 26 dB BANDWIDTH 213
8.18.2. 99% BANDWIDTH 218
8.18.3. AVERAGE POWER 223
8.18.4. OUTPUT POWER AND PSD 224

8.19. 802.11n HT20 2Tx STBC MODE IN THE 5.6 GHz BAND 235
8.19.1. 26 dB BANDWIDTH 235
8.19.2. 99% BANDWIDTH 240
8.19.3. AVERAGE POWER 245
8.19.4. OUTPUT POWER AND PSD 246

8.20. 802.11n HT40 SISO MODE IN THE 5.6 GHz BAND 257
8.20.1. 26 dB BANDWIDTH 257
8.20.2. 99% BANDWIDTH 260
8.20.3. AVERAGE POWER 263
8.20.4. OUTPUT POWER AND PSD 264

8.21. 802.11n HT40 2Tx CDD MODE IN THE 5.6 GHz BAND 273
8.21.1. 26 dB BANDWIDTH 273
8.21.2. 99% BANDWIDTH 278
8.21.3. AVERAGE POWER 283
8.21.4. OUTPUT POWER AND PSD 284

8.22. 802.11n HT40 2Tx STBC MODE IN THE 5.6 GHz BAND 295
8.22.1. 26 dB BANDWIDTH 295
8.22.2. 99% BANDWIDTH 300
8.22.3. AVERAGE POWER 305
8.22.4. OUTPUT POWER AND PSD 306

8.23. 802.11ac HT80 SISO MODE IN THE 5.6 GHz BAND 317
8.23.1. 26 dB BANDWIDTH 317
8.23.2. 99% BANDWIDTH 320

8.23.3. AVERAGE POWER 323
8.23.4. OUTPUT POWER AND PSD 324
8.24. 802.11ac HT80 2Tx CDD MODE IN THE 5.6 GHz BAND 332
8.24.1. 26 dB BANDWIDTH 332
8.24.2. 99% BANDWIDTH 337
8.24.3. AVERAGE POWER 342
8.24.4. OUTPUT POWER AND PSD 343
8.25. 802.11n HT20 SISO MODE IN THE 5.8 GHz BAND 353
8.25.1. 6 dB BANDWIDTH 353
8.25.2. 26 dB BANDWIDTH 356
8.25.3. 99% BANDWIDTH 359
8.25.4. AVERAGE POWER 362
8.25.5. OUTPUT POWER..... 363
8.25.6. Maximum Power Spectral Density (PSD) 365
8.26. 802.11n HT20 2Tx CDD MODE IN THE 5.8 GHz BAND 369
8.26.1. 6 dB BANDWIDTH 369
8.26.2. 26 dB BANDWIDTH 373
8.26.3. 99% BANDWIDTH 377
8.26.4. AVERAGE POWER 381
8.26.5. OUTPUT POWER..... 382
8.26.6. Maximum Power Spectral Density (PSD) 384
8.27. 802.11n HT40 SISO MODE IN THE 5.8 GHz BAND 389
8.27.1. 6 dB BANDWIDTH 389
8.27.2. 26 dB BANDWIDTH 391
8.27.3. 99% BANDWIDTH 393
8.27.4. AVERAGE POWER 395
8.27.5. OUTPUT POWER..... 396
8.27.6. Maximum Power Spectral Density (PSD) 398
8.28. 802.11n HT40 2Tx CDD MODE IN THE 5.8 GHz BAND 401
8.28.1. 6 dB BANDWIDTH 401
8.28.2. 26 dB BANDWIDTH 404
8.28.3. 99% BANDWIDTH 407
8.28.4. AVERAGE POWER 410
8.28.5. OUTPUT POWER..... 411
8.28.6. Maximum Power Spectral Density (PSD) 413
8.29. 802.11ac VHT80 SISO MODE IN THE 5.8 GHz BAND 417
8.29.1. 6 dB BANDWIDTH 417
8.29.2. 26 dB BANDWIDTH 419
8.29.3. 99% BANDWIDTH 421
8.29.4. AVERAGE POWER 423
8.29.5. OUTPUT POWER..... 424
8.29.6. Maximum Power Spectral Density (PSD) 426
8.30. 802.11ac VHT80 2Tx CDD MODE IN THE 5.8 GHz BAND 429
8.30.1. 6 dB BANDWIDTH 429
8.30.2. 26 dB BANDWIDTH 431
8.30.3. 99% BANDWIDTH 433
8.30.4. AVERAGE POWER 435
8.30.5. OUTPUT POWER..... 436
8.30.6. Maximum Power Spectral Density (PSD) 438

9. RADIATED TEST RESULTS..... 441

- 9.1. *LIMITS AND PROCEDURE..... 441*
- 9.2. *802.11n HT20 SISO MODE IN THE 5.2 GHz BAND..... 442*
- 9.3. *802.11n HT20 2Tx CDD MODE IN THE 5.2 GHz BAND..... 450*
- 9.4. *802.11n HT40 SISO MODE IN THE 5.2 GHz BAND..... 458*
- 9.5. *802.11n HT40 2Tx CDD MODE IN THE 5.2 GHz BAND..... 464*
- 9.6. *802.11ac VHT80 1TX SISO MODE IN THE 5.2 GHz BAND..... 470*
- 9.7. *802.11ac VHT80 2TX CDD MODE IN THE 5.2 GHz BAND..... 474*
- 9.8. *802.11n HT20 SISO MODE IN THE 5.3 GHz BAND..... 478*
- 9.9. *802.11n HT20 2Tx CDD MODE IN THE 5.3 GHz BAND..... 486*
- 9.10. *802.11n HT40 SISO MODE IN THE 5.3 GHz BAND..... 494*
- 9.11. *802.11n HT40 2Tx CDD MODE IN THE 5.3 GHz BAND..... 500*
- 9.12. *802.11ac VHT80 SISO MODE IN THE 5.3 GHz BAND..... 506*
- 9.13. *802.11ac VHT80 2TX CDD MODE IN THE 5.3 GHz BAND..... 510*
- 9.14. *802.11n HT20 SISO MODE IN THE 5.6 GHz BAND..... 514*
- 9.15. *802.11n HT20 2Tx CDD MODE IN THE 5.6 GHz BAND..... 526*
- 9.16. *802.11n HT40 SISO MODE IN THE 5.6 GHz BAND..... 538*
- 9.17. *802.11n HT40 2Tx CDD MODE IN THE 5.6 GHz BAND..... 550*
- 9.18. *802.11ac VHT80 SISO MODE IN THE 5.6 GHz BAND..... 562*
- 9.19. *802.11ac VHT80 2TX CDD MODE IN THE 5.6 GHz BAND..... 570*
- 9.20. *802.11n HT20 SISO MODE IN THE 5.8 GHz BAND..... 578*
- 9.21. *802.11n HT20 2Tx CDD MODE IN THE 5.8 GHz BAND..... 588*
- 9.22. *802.11n HT40 SISO MODE IN THE 5.8 GHz BAND..... 598*
- 9.23. *802.11n HT40 2Tx CDD MODE IN THE 5.8 GHz BAND..... 606*
- 9.24. *802.11ac 80Mhz 1Tx SISO MODE IN THE 5.8 GHz BAND..... 614*
- 9.25. *802.11ac 80Mhz 2Tx CDD MODE IN THE 5.8 GHz BAND..... 620*
- 9.26. *WORST-CASE BELOW 1 GHz..... 626*
- 9.27. *WORST-CASE ABOVE 18 GHz..... 628*

10. AC POWER LINE CONDUCTED EMISSIONS 630

11. DYNAMIC FREQUENCY SELECTION 635

- 11.1. *OVERVIEW..... 635*
 - 11.1.1. *LIMITS..... 635*
 - 11.1.1. *TEST AND MEASUREMENT SYSTEM..... 639*
 - 11.1.2. *SETUP OF EUT (CLIENT MODE)..... 642*
 - 11.1.3. *SETUP OF EUT (CLIENT-TO-CLIENT COMMUNICATIONS MODE)..... 643*
 - 11.1.4. *DESCRIPTION OF EUT..... 644*
- 11.2. *CLIENT MODE RESULTS FOR 20 MHz BANDWIDTH..... 646*

11.2.1.	TEST CHANNEL.....	646
11.2.2.	RADAR WAVEFORM AND TRAFFIC	646
11.2.3.	OVERLAPPING CHANNEL TESTS	649
11.2.4.	MOVE AND CLOSING TIME.....	649
11.3.	<i>CLIENT MODE RESULTS FOR 40 MHz BANDWIDTH.....</i>	<i>653</i>
11.3.1.	TEST CHANNEL.....	653
11.3.2.	RADAR WAVEFORM AND TRAFFIC	653
11.3.3.	OVERLAPPING CHANNEL TESTS	656
11.3.4.	MOVE AND CLOSING TIME.....	656
11.4.	<i>CLIENT MODE RESULTS FOR 80 MHz BANDWIDTH.....</i>	<i>660</i>
11.4.1.	TEST CHANNEL.....	660
11.4.2.	RADAR WAVEFORM AND TRAFFIC	660
11.4.3.	OVERLAPPING CHANNEL TESTS	663
11.4.4.	MOVE AND CLOSING TIME.....	663
11.4.5.	10-MINUTE BEACON MONITORING PERIOD.....	667
11.5.	<i>CLIENT-TO-CLIENT COMMUNICATIONS MODE RESULTS FOR 20 MHz BANDWIDTH</i>	<i>668</i>
11.5.1.	TEST CHANNEL.....	668
11.5.2.	RADAR WAVEFORM AND TRAFFIC	668
11.5.3.	OVERLAPPING CHANNEL TESTS	671
11.5.4.	MOVE AND CLOSING TIME.....	671
11.6.	<i>CLIENT-TO-CLIENT COMMUNICATIONS MODE RESULTS FOR 40 MHz BANDWIDTH</i>	<i>675</i>
11.6.1.	TEST CHANNEL.....	675
11.6.2.	RADAR WAVEFORM AND TRAFFIC	675
11.6.3.	OVERLAPPING CHANNEL TESTS	678
11.6.4.	MOVE AND CLOSING TIME.....	678
11.7.	<i>CLIENT-TO-CLIENT COMMUNICATIONS MODE RESULTS FOR 80 MHz BANDWIDTH</i>	<i>683</i>
11.7.1.	TEST CHANNEL.....	683
11.7.2.	RADAR WAVEFORM AND TRAFFIC	683
11.7.3.	OVERLAPPING CHANNEL TESTS	686
11.7.4.	MOVE AND CLOSING TIME.....	686
11.7.5.	10-MINUTE BEACON MONITORING PERIOD.....	690
12.	SETUP PHOTOS	691

1. ATTESTATION OF TEST RESULTS

COMPANY NAME: APPLE
1 INFINITE LOOP
CUPERTINO, CA 95014, U.S.A.

EUT DESCRIPTION: TABLET DEVICE

MODEL: A1550

SERIAL NUMBER: F4KPC009GJK2 (CONDUCTED);
F4KP604KGJK5 (RADIATED);
F4KNX021GG40 (DFS)

DATE TESTED: FEBRUARY 16, 2015- MAY 07, 2015

APPLICABLE STANDARDS	
STANDARD	TEST RESULTS
CFR 47 Part 15 Subpart E	Pass

UL Verification Services Inc. tested the above equipment in accordance with the requirements set forth in the above standards. All indications of Pass/Fail in this report are opinions expressed by UL Verification Services Inc. based on interpretations and/or observations of test results. Measurement Uncertainties were not taken into account and are published for informational purposes only. The test results show that the equipment tested is capable of demonstrating compliance with the requirements as documented in this report.

Note: The results documented in this report apply only to the tested sample, under the conditions and modes of operation as described herein. This document may not be altered or revised in any way unless done so by UL Verification Services Inc. and all revisions are duly noted in the revisions section. Any alteration of this document not carried out by UL Verification Services Inc. will constitute fraud and shall nullify the document. This report must not be used by the client to claim product certification, approval, or endorsement by NVLAP, NIST, any agency of the Federal Government, or any agency of any government.

Approved & Released For
UL Verification Services Inc. By:

Tested By:

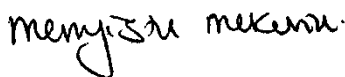

MEMGISTU MEKURIA
SENIOR ENGINEER
UL VERIFICATION SERVICES INC.

TRI PHAM
LAB TECHNICIAN
UL VERIFICATION SERVICES INC.

2. TEST METHODOLOGY

The tests documented in this report were performed in accordance with FCC CFR 47 Part 2, FCC CFR 47 Part 15, FCC 14-30, FCC KDB 662911 D01 v02r01, FCC KDB 905462 D02 v01r01/D03 v01r01/D06 v01, FCC KDB 789033 D02, FCC KDB 644545 D03 v01 ANSI C63.10-2009.

3. FACILITIES AND ACCREDITATION

The test sites and measurement facilities used to collect data are located at 47173 and 47266 Benicia Street, Fremont, California, USA. Line conducted emissions are measured only at the 47173 address. The following table identifies which facilities were utilized for radiated emission measurements documented in this report. Specific facilities are also identified in the test results sections.

47173 Benicia Street	47266 Benicia Street
<input type="checkbox"/> Chamber A	<input type="checkbox"/> Chamber D
<input type="checkbox"/> Chamber B	<input checked="" type="checkbox"/> Chamber E
<input type="checkbox"/> Chamber C	<input type="checkbox"/> Chamber F
	<input type="checkbox"/> Chamber G
	<input type="checkbox"/> Chamber H

The above test sites and facilities are covered under FCC Test Firm Registration # 208313. Chambers A through H are covered under Industry Canada company address code 2324B with site numbers 2324B - 1 through 2324B-8, respectively.

UL Verification Services Inc. is accredited by NVLAP, Laboratory Code 200065-0. The full scope of accreditation can be viewed at <http://ts.nist.gov/standards/scopes/2000650.htm>.

4. CALIBRATION AND UNCERTAINTY

4.1. MEASURING INSTRUMENT CALIBRATION

The measuring equipment utilized to perform the tests documented in this report has been calibrated in accordance with the manufacturer's recommendations, and is traceable to recognized national standards.

4.2. SAMPLE CALCULATION

Where relevant, the following sample calculation is provided:

$$\begin{aligned} \text{Field Strength (dBuV/m)} &= \text{Measured Voltage (dBuV)} + \text{Antenna Factor (dB/m)} + \text{Cable} \\ &\text{Loss (dB)} - \text{Preamp Gain (dB)} \\ 36.5 \text{ dBuV} + 18.7 \text{ dB/m} + 0.6 \text{ dB} - 26.9 \text{ dB} &= 28.9 \text{ dBuV/m} \end{aligned}$$

4.3. MEASUREMENT UNCERTAINTY

Where relevant, the following measurement uncertainty levels have been estimated for tests performed on the apparatus:

PARAMETER	UNCERTAINTY
Conducted Disturbance, 0.15 to 30 MHz	± 3.52 dB
Radiated Disturbance, 30 to 1000 MHz	± 4.94 dB
Radiated Disturbance, 1 to 6 GHz	± 3.86 dB
Radiated Disturbance, 6 to 18 GHz	± 4.23 dB
Radiated Disturbance, 18 to 26 GHz	± 5.30 dB
Radiated Disturbance, 26 to 40 GHz	± 5.23 dB

Uncertainty figures are valid to a confidence level of 95%.

5. EQUIPMENT UNDER TEST

5.1. DESCRIPTION OF EUT

The EUT is a tablet with multimedia functions (music, application support, and video), Cellular GSM/GPRS/EGPRS/CDMA2000 1xRTT/1x Advanced/EVDO Rev.A/EVDO Rev.B /WCDMA /HSPA+/DC-HSDPA/LTE FDD & Carrier Aggregation/TDD/TD-SCDMA radio, IEEE 802.11a/b/g/n/ac radio, and Bluetooth radio. The rechargeable battery is not user accessible.

5.2. MAXIMUM OUTPUT POWER

The transmitter has a maximum conducted output power as follows:

5.2GHz Band

Frequency Range (MHz)	Mode	Antenna	Output Power (dBm)	Output Power (mW)
5180 - 5240	802.11a SISO	Covered by 802.11n HT20 SISO		
	802.11a CDD 2TX	Covered by 802.11n HT20 CDD 2TX		
	802.11n HT20 SISO	Antenna B	17.87	61.24
	802.11n HT20 CDD 2TX	Antenna B + A	18.88	77.27
	802.11n HT20 STBC 2TX	Antenna B + A	19.88	97.27
	802.11n HT20 SDM 2TX	Covered by 802.11n HT20 STBC 2TX		
5190 - 5230	802.11n HT40 SISO	Antenna B	17.94	62.23
	802.11n HT40 CDD 2TX	Antenna B + A	18.96	78.70
	802.11n HT40 STBC 2TX	Antenna B + A	20.40	109.65
	802.11n HT40 SDM 2TX	Covered by 802.11n HT40 STBC 2TX		
5210	802.11ac VHT80 SISO	Antenna B	13.01	20.00
	802.11ac VHT80 CDD 2TX	Antenna B + A	15.57	36.06
	802.11ac VHT80 STBC 2TX	Covered by 802.11ac VHT80 CDD 2TX		
	802.11ac VHT80 SDM 2TX	Covered by 802.11ac VHT80 CDD 2TX		

5.3GHz Band

Frequency Range (MHz)	Mode	Antenna	Output Power (dBm)	Output Power (mW)
5260 - 5320	802.11a SISO	Covered by 802.11n HT20 SISO		
	802.11a CDD 2TX	Covered by 802.11n HT20 CDD 2TX		
	802.11n HT20 SISO	Antenna B	16.83	48.19
	802.11n HT20 CDD 2TX	Antenna B + A	18.42	69.50
	802.11n HT20 STBC 2TX	Antenna B + A	19.51	89.33
	802.11n HT20 SDM 2TX	Covered by 802.11n HT20 STBC 2TX		
5270 - 5310	802.11n HT40 SISO	Antenna B	16.85	48.42
	802.11n HT40 CDD 2TX	Antenna B + A	18.50	70.79
	802.11n HT40 STBC 2TX	Antenna B + A	19.53	89.74
	802.11n HT40 SDM 2TX	Covered by 802.11n HT40 STBC 2TX		
5290	802.11ac VHT80 SISO	Antenna B	15.01	31.70
	802.11ac VHT80 CDD 2TX	Antenna B + A	15.62	36.48
	802.11ac VHT80 STBC 2TX	Covered by 802.11n HT80 CDD 2TX		
	802.11ac VHT80 SDM 2TX	Covered by 802.11n HT80 CDD 2TX		

5.6GHz Band

Frequency Range (MHz)	Mode	Antenna	Output Power (dBm)	Output Power (mW)
5500 - 5700	802.11a SISO	Covered by 802.11n HT20 SISO		
5720	802.11a SISO	Covered by 802.11n HT20 SISO		
5500 - 5700	802.11a CDD 2TX	Covered by 802.11n HT20 CDD 2TX		
5720	802.11a CDD 2TX	Covered by 802.11n HT20 CDD 2TX		
5500 - 5700	802.11n HT20 SISO	Antenna B	15.44	34.99
5720	802.11n HT20 SISO	Antenna B	14.42	27.67
5500 - 5700	802.11n HT20 CDD 2TX	Antenna B + A	17.77	59.84
5720	802.11n HT20 CDD 2TX	Antenna B + A	16.75	47.32
5500 - 5700	802.11n HT20 STBC 2TX	Antenna B + A	18.46	70.15
5500 - 5700	802.11n HT20 SDM 2TX	Covered by 802.11n HT20 STBC 2TX		
5720	802.11n HT20 STBC 2TX	Antenna B + A	17.45	55.59
5720	802.11n HT20 SDM 2TX	Covered by 802.11n HT20 STBC 2TX		
5510 - 5670	802.11n HT40 SISO	Antenna B	15.49	35.40
5710	802.11n HT40 SISO	Antenna B	14.64	29.11
5510 - 5670	802.11n HT40 CDD 2TX	Antenna B + A	18.00	63.10
5710	802.11n HT40 CDD 2TX	Antenna B + A	16.60	45.71
5510 - 5670	802.11n HT40 STBC 2TX	Antenna B + A	18.48	70.47
5510 - 5670	802.11n HT40 SDM 2TX	Covered by 802.11n HT40 STBC 2TX		
5710	802.11n HT40 STBC 2TX	Antenna B + A	16.59	45.60
5710	802.11n HT40 SDM 2TX	Covered by 802.11n HT40 STBC 2TX		
5530-5610	802.11ac VHT80 SISO	Antenna B	15.70	37.15
5690	802.11ac VHT80 SISO	Antenna B	15.52	35.65
5530-5610	802.11ac VHT80 CDD 2TX	Antenna B + A	18.62	72.78
5690	802.11ac VHT80 CDD 2TX	Antenna B + A	18.61	72.61
5530-5610	802.11ac VHT80 STBC 2TX	Covered by 802.11n HT80 CDD 2TX		
5530-5610	802.11ac VHT80 SDM 2TX	Covered by 802.11n HT80 CDD 2TX		
5690	802.11ac VHT80 STBC 2TX	Covered by 802.11n HT80 CDD 2TX		
5690	802.11ac VHT80 SDM 2TX	Covered by 802.11n HT80 CDD 2TX		

5.8GHz Band

Frequency Range (MHz)	Mode	Antenna	Output Power (dBm)	Output Power (mW)
5745 - 5825	802.11a SISO	Covered by 802.11n HT20 SISO		
	802.11a CDD 2TX	Covered by 802.11n HT20 CDD 2TX		
	802.11n HT20 SISO	Antenna B	16.92	49.20
	802.11n HT20 CDD 2TX	Antenna B + A	19.86	96.83
	802.11n HT20 STBC 2TX	Covered by 802.11n HT20 CDD 2TX		
	802.11n HT20 SDM 2TX	Covered by 802.11n HT20 CDD 2TX		
5755 - 5795	802.11n HT40 SISO	Antenna B	16.00	39.81
	802.11n HT40 CDD 2TX	Antenna B + A	18.05	63.83
	802.11n HT40 STBC 2TX	Covered by 802.11n HT40 CDD 2TX		
	802.11n HT40 SDM 2TX	Covered by 802.11n HT40 CDD 2TX		
5775	802.11ac VHT80 SISO	Antenna B	14.02	25.23
	802.11ac VHT80 CDD 2TX	Antenna B + A	16.04	40.18
	802.11ac VHT80 STBC 2TX	Covered by 802.11ac VHT80 CDD 2TX		
	802.11ac VHT80 SDM 2TX	Covered by 802.11ac VHT80 CDD 2TX		

5.3. DESCRIPTION OF AVAILABLE ANTENNAS

Frequency Band (GHz)	Antenna Peak Gain		
	Antenna B	Antenna D	Antenna A
5.2G	3.2	-	2.1
5.3G	3.3	-	3.1
5.5G	3.9	-	3.2
5.8G	3.7	-	3.4

5.4. SOFTWARE AND FIRMWARE

The firmware installed in the EUT during testing was 12H33.

5.5. WORST-CASE CONFIGURATION AND MODE

Radiated emission and power line conducted emission were performed with the EUT set to transmit at the channel with highest output power as worst-case scenario.

The following configurations were investigated and EUT powered by AC/DC adapter was the worst-case scenario. AC power line and below 1G radiated tests were conducted on configuration 1.

Configuration	Descriptions
1	EUT powered by AC/DC adapter via USB cable
2	EUT powered by host PC via USB cable

For SISO modes, there are two transmission antennas. The antenna used in any given time can be either antenna A or antenna B. For MIMO modes, both antenna A and antenna B used at the same time.

The fundamental of the EUT was investigated in three orthogonal orientations X/Y/Z. After the investigation it was determined that the below orientations was considered as the worst-case for each mode. Then all final radiated testing was performed with the EUT at the worst-case orientation

Frequency Band (GHz)	Mode	Antenna Port	Worst-case Orientation
5.2-5.8	1TX SISO	Antenna A	X-Flatbed
		Antenna B	Y-Landscape
	2TX MIMO	Antenna A + Antenna B	Y-Landscape

Worst-case data rates as provided by the client were:

- 802.11a mode: 6 Mbps
- 802.11n HT20 mode: MCS0
- 802.11n HT40 mode: MCS0
- 802.11ac VHT20 mode: MCS0
- 802.11ac VHT40 mode: MCS0
- 802.11ac VHT80 mode: MCS0

802.11ac VHT20 and VHT40 mode are different from 802.11nHT20 and HT40 only in control messages and have the same power settings.

Radiated emissions for EUT with antenna was performed and passed; therefore, antenna port spurious was not performed.

For the co-located test, no other emissions were found after have been investigated from the conducted measurement with all different combination frequencies between BT & 5GHz bands.

5.6. DESCRIPTION OF TEST SETUP

SUPPORT EQUIPMENT

Support Equipment List				
Description	Manufacturer	Model	Serial Number	FCC ID
Laptop AC/DC adapter	Lenovo	92P1160	11S92P1160Z1ZBGH798B12	NA
Laptop	Lenovo	7659	L3-AL664 08/03	NA
Earphone	Apple	NA	NA	NA
EUT AC/DC adapter	Apple	MD836LL/A	NA	NA

I/O CABLES (CONDUCTED TEST)

I/O Cable List						
Cable No	Port	# of identical ports	Connector Type	Cable Type	Cable Length (m)	Remarks
1	Antenna	1	SMA	Un-Shielded	0.2	To spectrum Analyzer
2	USB	1	USB	Shielded	1	N/A

I/O CABLES (RADIATED ABOVE 1 GHZ)

I/O Cable List						
Cable No	Port	# of identical ports	Connector Type	Cable Type	Cable Length (m)	Remarks
None used						

I/O CABLES (AC POWER CONDUCTED TEST and below 1 GHZ)

I/O Cable List						
Cable No	Port	# of identical ports	Connector Type	Cable Type	Cable Length (m)	Remarks
1	AC	1	US115	Un-Shielded	0.8	NA
2	DC	1	lightning	Un-Shielded	1	NA
3	Audio	1	Jack	Un-Shielded	0.5	NA

TEST SETUP- CONDUCTED PORT

The EUT was tested connected to a host Laptop via USB cable adapter and spectrum analyzer to antenna port. Test software exercised the EUT.

SETUP DIAGRAM

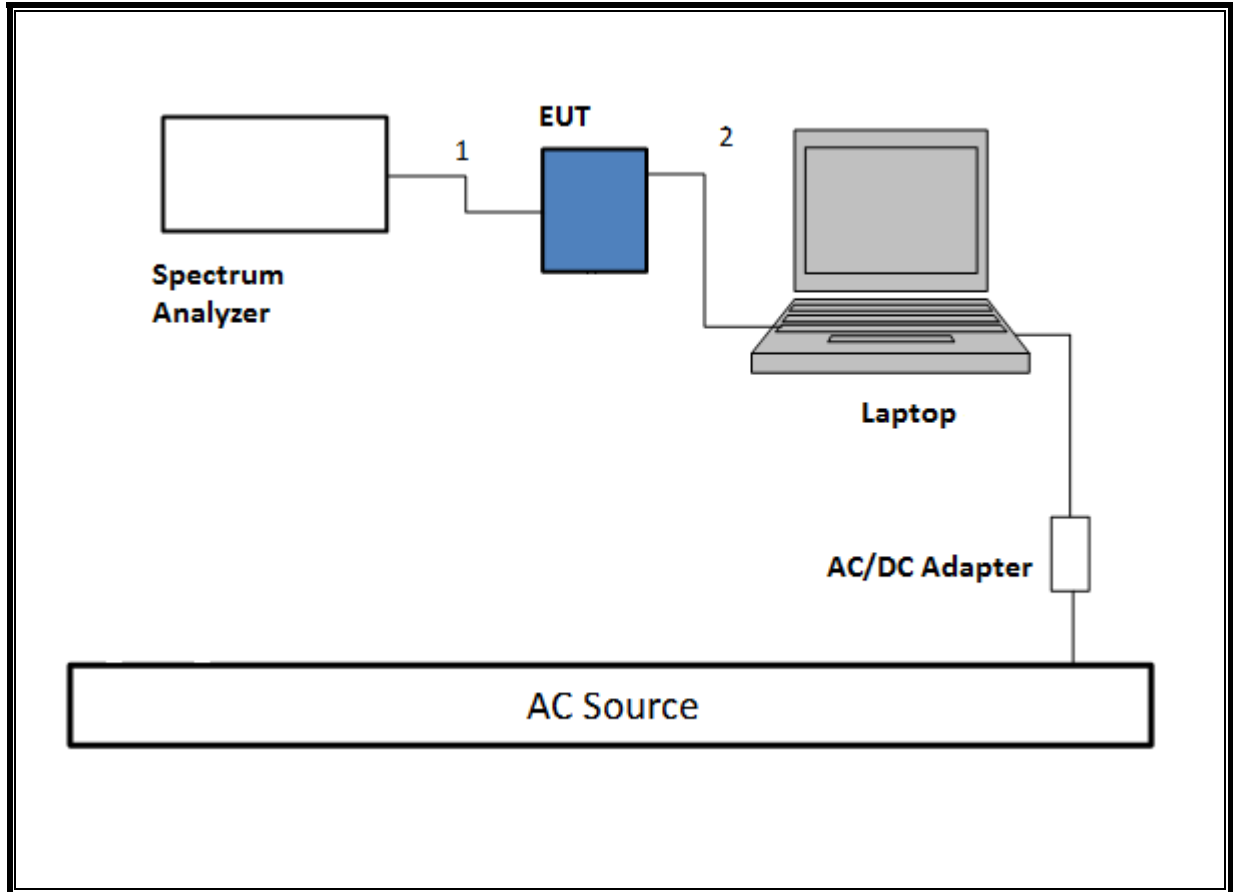

TEST SETUP- RADIATED-ABOVE 1 GHZ

The EUT was tested battery powered. Test software exercised the EUT.

SETUP DIAGRAM

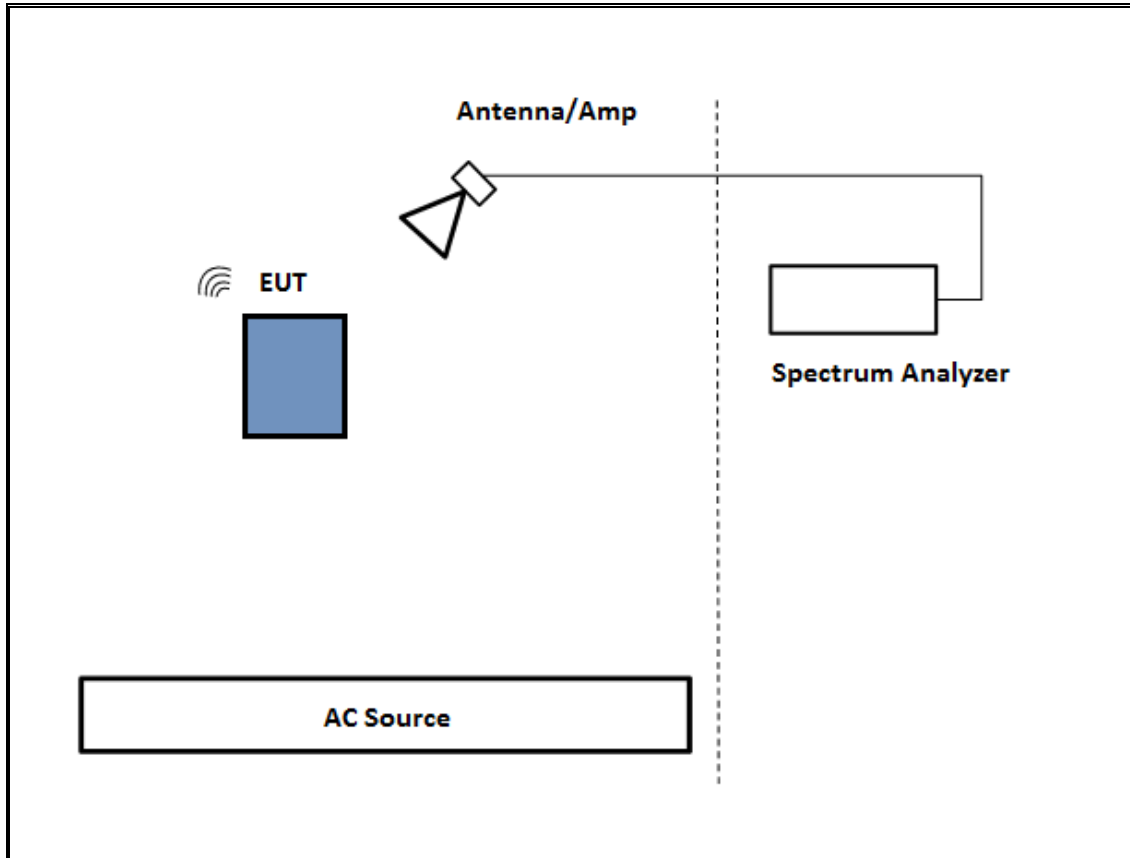

TEST SETUP- BELOW 1GHZ & AC LINE CONDUCTED TESTS

The EUT was tested with earphone connected and powered by AC adapter. Test software exercised the EUT.

SETUP DIAGRAM

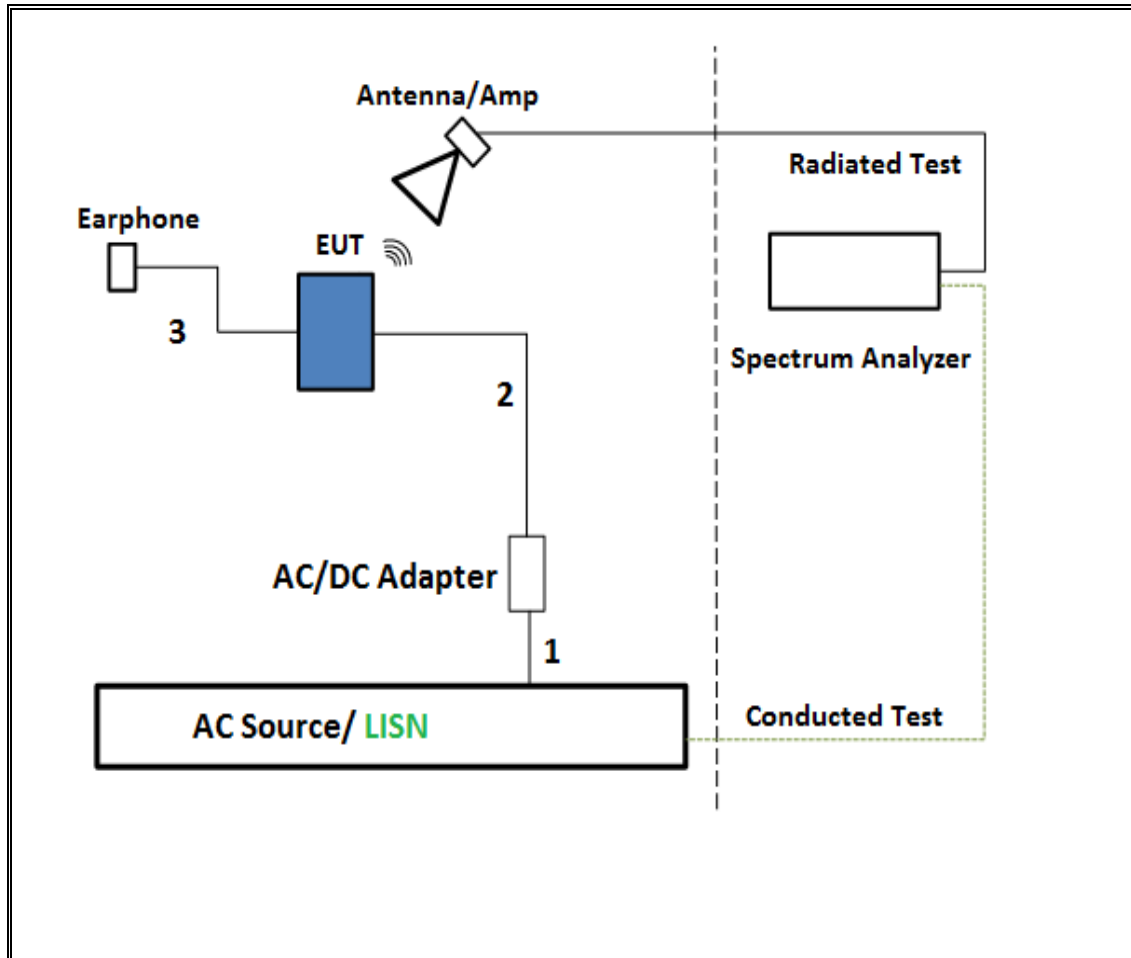

6. TEST AND MEASUREMENT EQUIPMENT

The following test and measurement equipment was utilized for the tests documented in this report:

Test Equipment List				
Description	Manufacturer	Model	Asset	Cal Due
Antenna, Horn 1-18GHz	ETS Lindgren	3117	00143449	2/10/2016
Antenna, Broadband Hybrid, 30MHz to 2000MHz	Sunol Sciences	JB3	A022813-1	1/14/2016
Amplifier, 1 - 18GHz	Miteq	AFS42-00101800-25-S-42	1782153	6/23/2015
Amplifier, 10KHz to 1GHz, 32dB	Sonoma	310N	323561	5/28/2015
*Spectrum Analyzer, PXA, 3Hz to 44GHz	Agilent	N9030A	US51350187	5/2/2015
Power Meter, P-series single channel	Agilent	N1911A	MY53060010	4/7/2016
Power Sensor, P - series, 50MHz to 18GHz, Wideband	Agilent	N1921A	MY53260010	7/12/2015
Antenna, Horn 18 to 26.5GHz	ARA	MWH-1826	1049	12/17/2015
Spectrum Analyzer, 40 GHz	Agilent	8564E	3943A01643	8/6/2015
Amplifier, 1 to 26.5GHz, 23.5dB Gain minimum	Agilent	8449B	3008A04710	4/13/2016
Horn Antenna, 40GHz	ARA	MWH-2640/B	1029	7/15/2015
Amplifier, 26 to 40GHz	Miteq	NSP4000-SP2	1029	9/3/2015
AC Line Conducted				
EMI Test Receiver 9Khz-7GHz	Rohde & Schwarz	ECSI7	100935	09/16/15
LISN for Conducted Emissions CISPR-16	FCC	50/250-25-2	114	01/16/16
Power Cable, Line Conducted Emissions ANSI 63.4	UL	PG1	N/A	7/28/2015
UL SOFTWARE				
Radiated Software	UL	UL EMC	Ver 9.5, July 22, 2014	
Conducted Software	UL	UL EMC	Ver 2.2, March 31, 2015	
AC Line Conducted Software	UL	UL EMC	Ver 9.5, April 3, 2015	

* Equipment was used before expiration date.

7. ON TIME, DUTY CYCLE AND MEASUREMENT METHODS

7.1. ON TIME AND DUTY CYCLE

LIMITS

None; for reporting purposes only.

PROCEDURE

KDB 789033 Zero-Span Spectrum Analyzer Method.

RESULTS

Mode	ON Time B (msec)	Period (msec)	Duty Cycle x (linear)	Duty Cycle (%)	Duty Cycle Correction Factor (dB)	1/B Minimum VBW (kHz)
802.11n HT20 1TX	1.920	1.941	0.989	98.92%	0.00	0.010
802.11n HT20 CDD	1.917	1.938	0.989	98.92%	0.00	0.010
802.11n HT40 1TX	1.124	1.142	0.984	98.42%	0.00	0.010
802.11n HT40 CDD	1.122	1.140	0.984	98.42%	0.00	0.010
802.11ac VHT80 1TX	0.458	0.481	0.952	95.22%	0.21	2.183
802.11ac VHT80 CDD	0.460	0.483	0.952	95.24%	0.21	2.174

DUTY CYCLE PLOTS

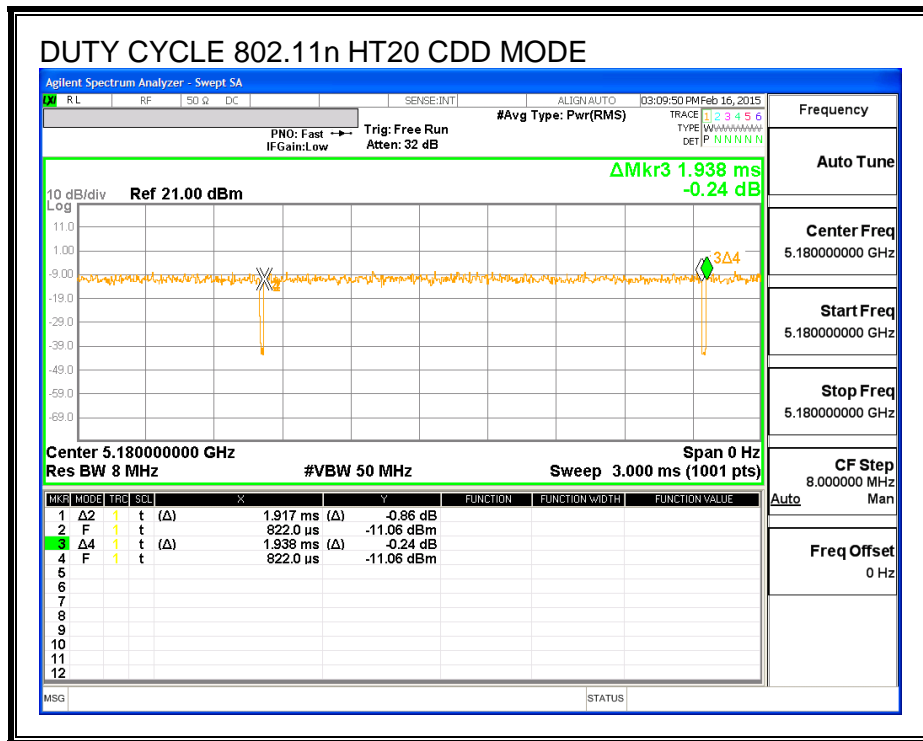
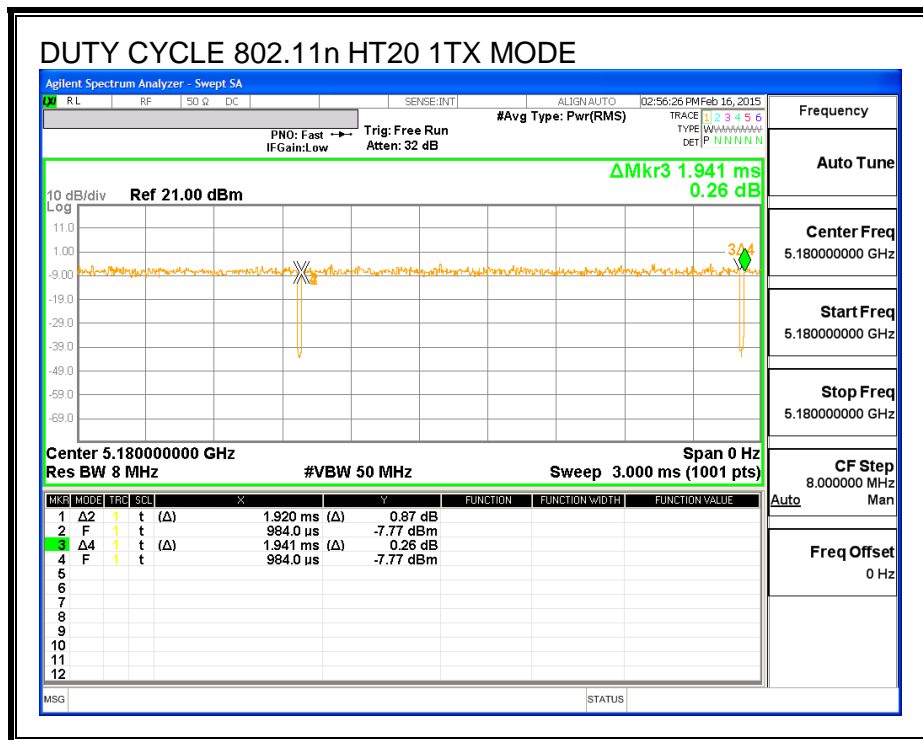

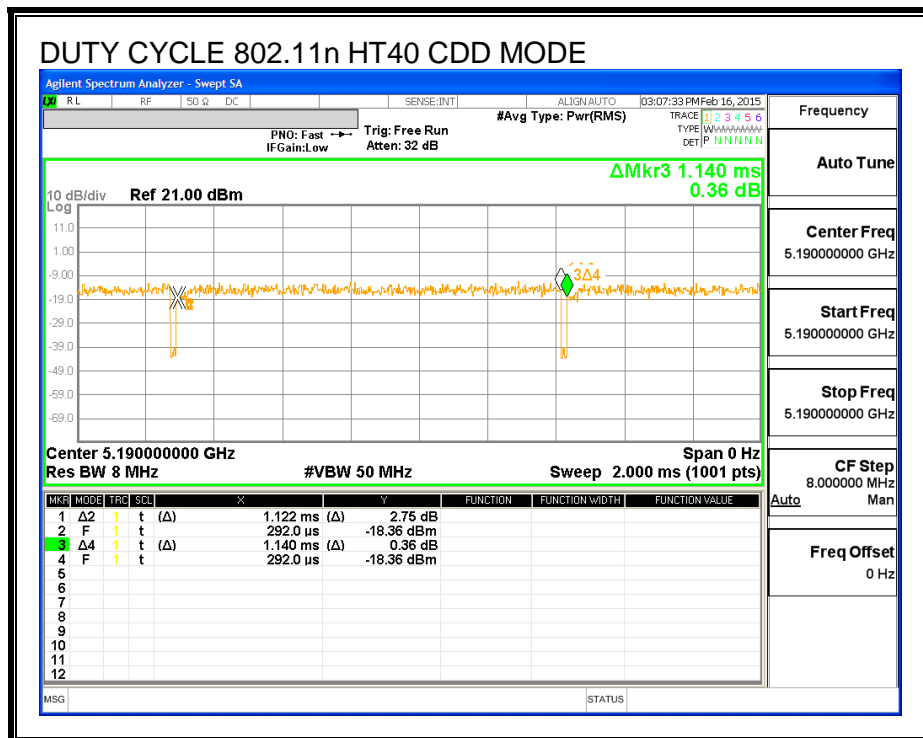
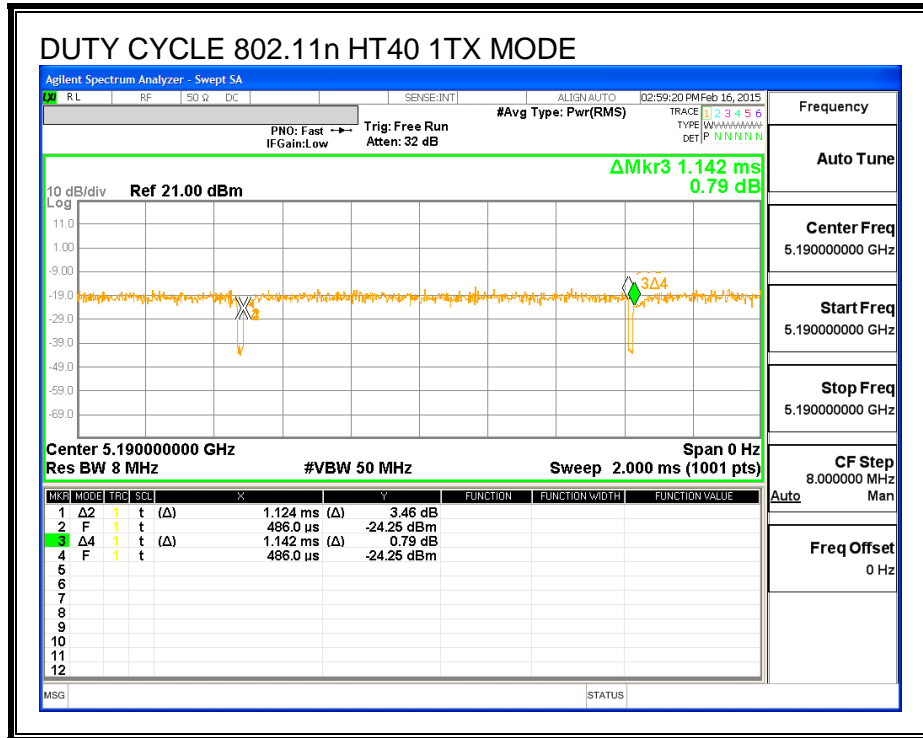

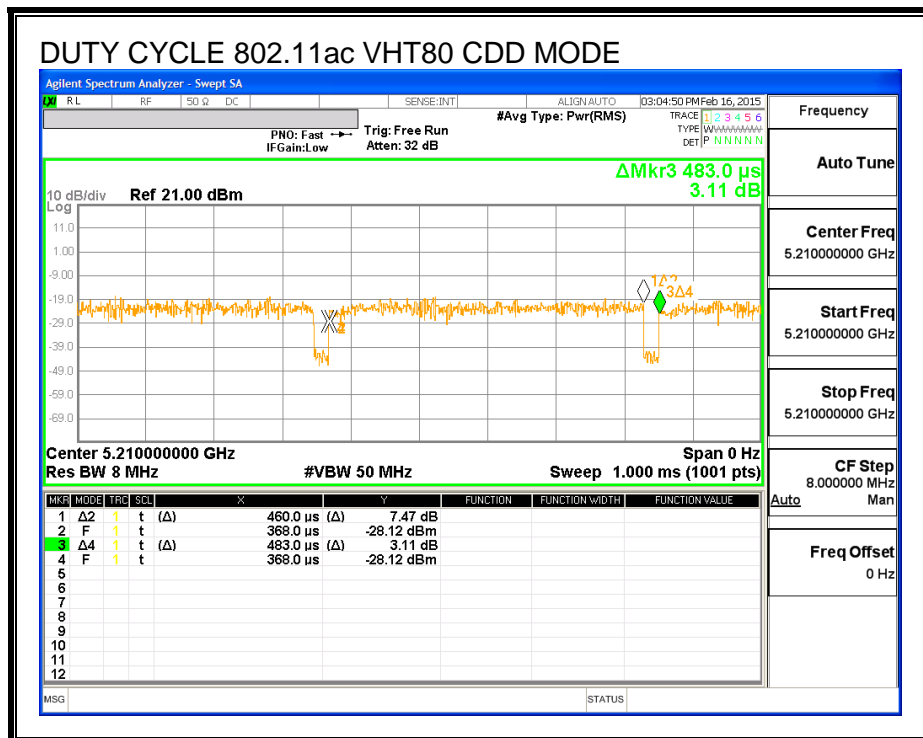
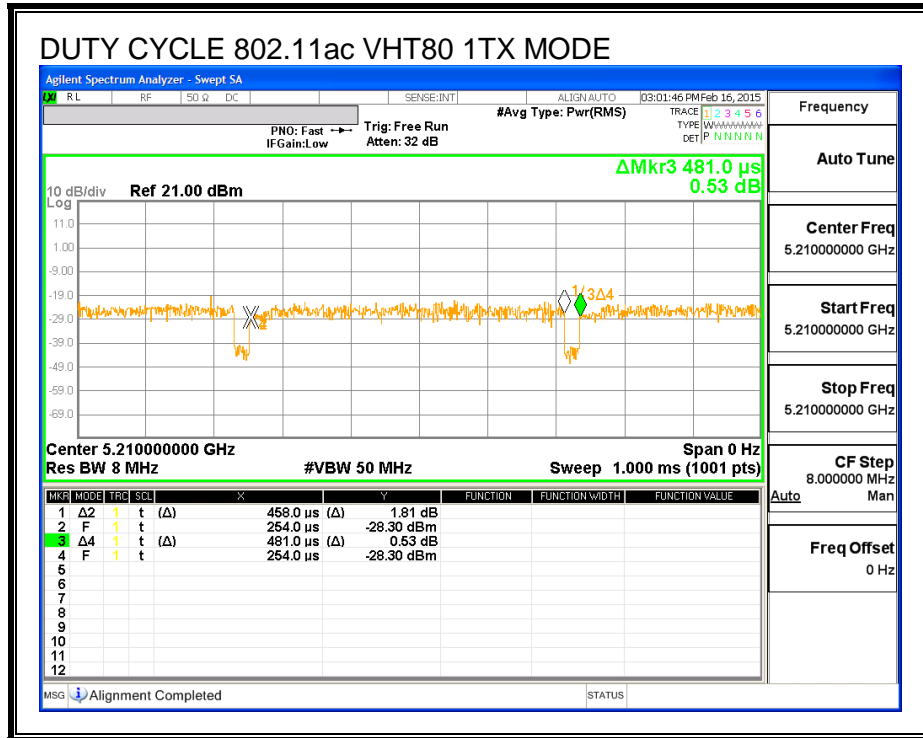

7.2. MEASUREMENT METHODS

26 dB Emission BW: KDB 789033 D02 v01, Section C.

99% Occupied BW: KDB 789033 D02 v01, Section D.

Conducted Output Power: KDB 789033 D02 v01, Section E.3.a (Method PM).

Power Spectral Density: KDB 789033 D02 v01, Section F.

Unwanted emissions in restricted bands: KDB 789033 D02 v01, Sections G.3, G.4, G.5, and G.6.

Unwanted emissions in non-restricted bands: KDB 789033 D02 v01, Sections G.3, G.4, and G.5.

8. ANTENNA PORT TEST RESULTS

8.1. 802.11n HT20 SISO MODE IN THE 5.2 GHz BAND

8.1.1. 26 dB BANDWIDTH

LIMITS

None; for reporting purposes only.

RESULTS

Channel	Frequency (MHz)	26 dB Bandwidth (MHz)
Low	5180	21.85
Mid	5200	21.85
High	5240	21.90

26 dB BANDWIDTH

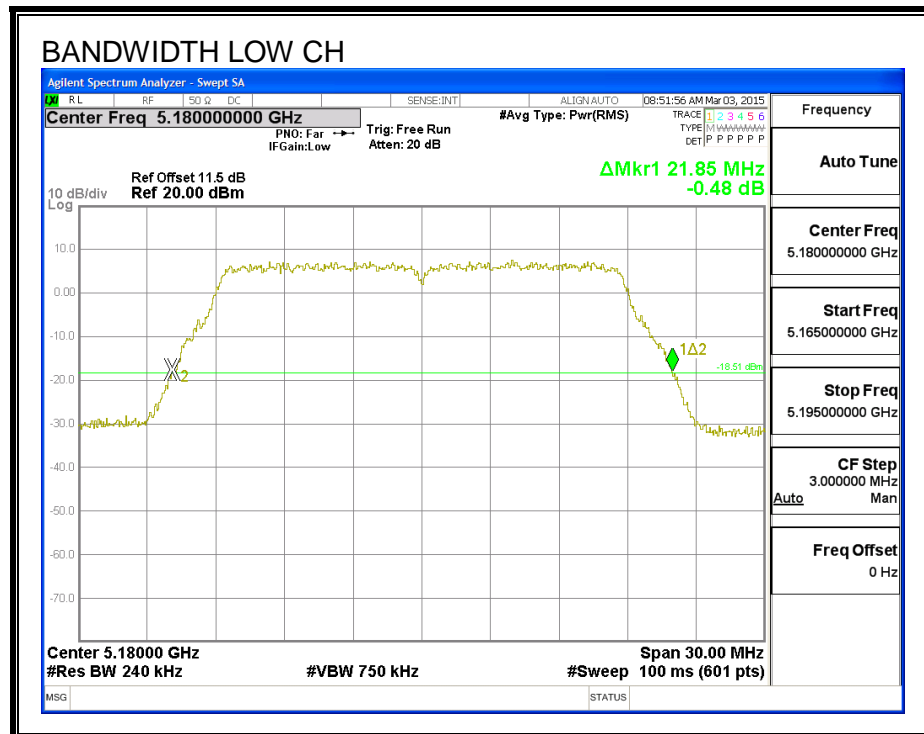

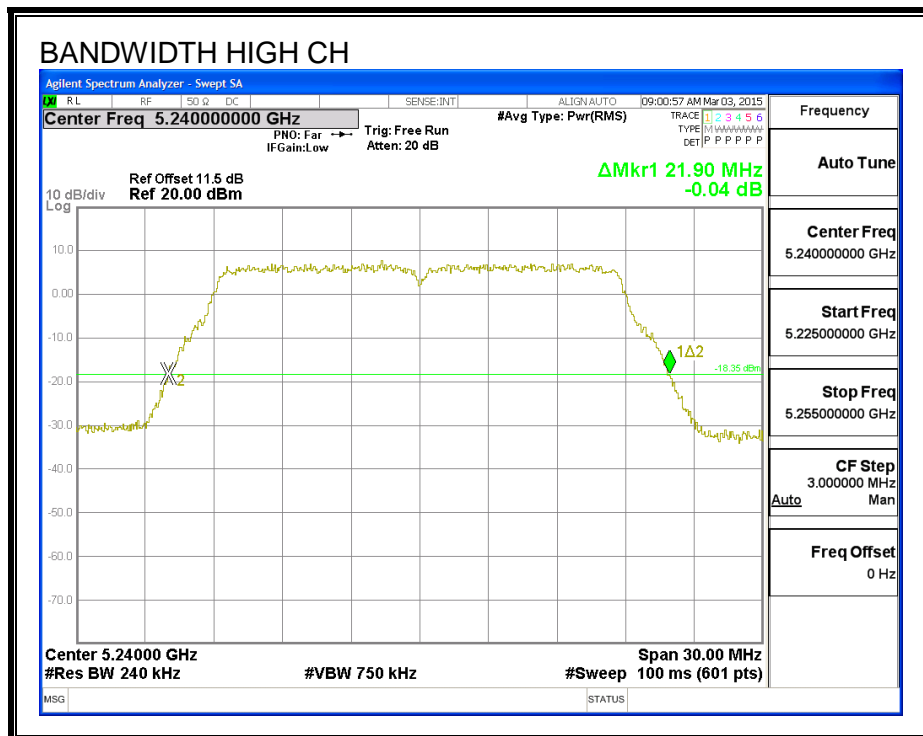
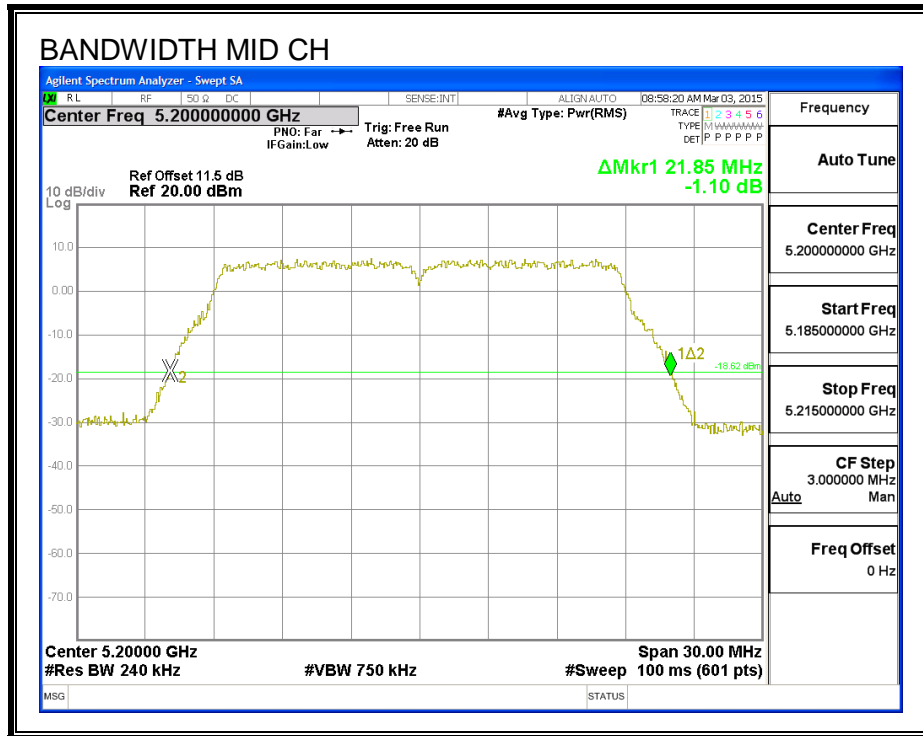

8.1.2. 99% BANDWIDTH

LIMITS

None; for reporting purposes only.

RESULTS

Channel	Frequency (MHz)	99% BW (MHz)
Low	5180	17.9010
Mid	5200	17.8180
High	5240	17.7990

99% BANDWIDTH, ANTENNA A

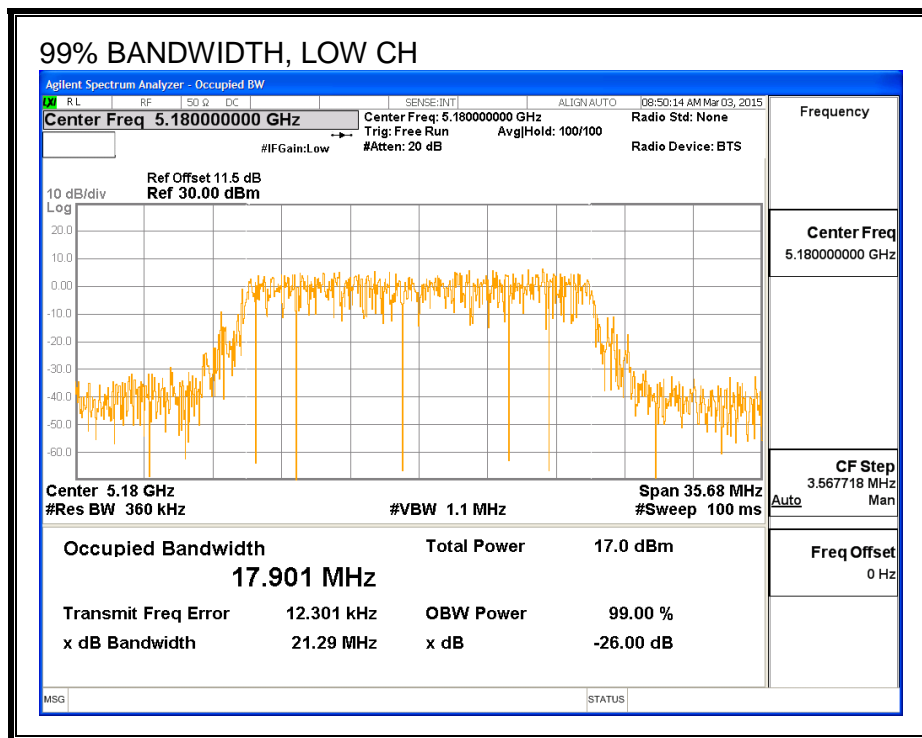

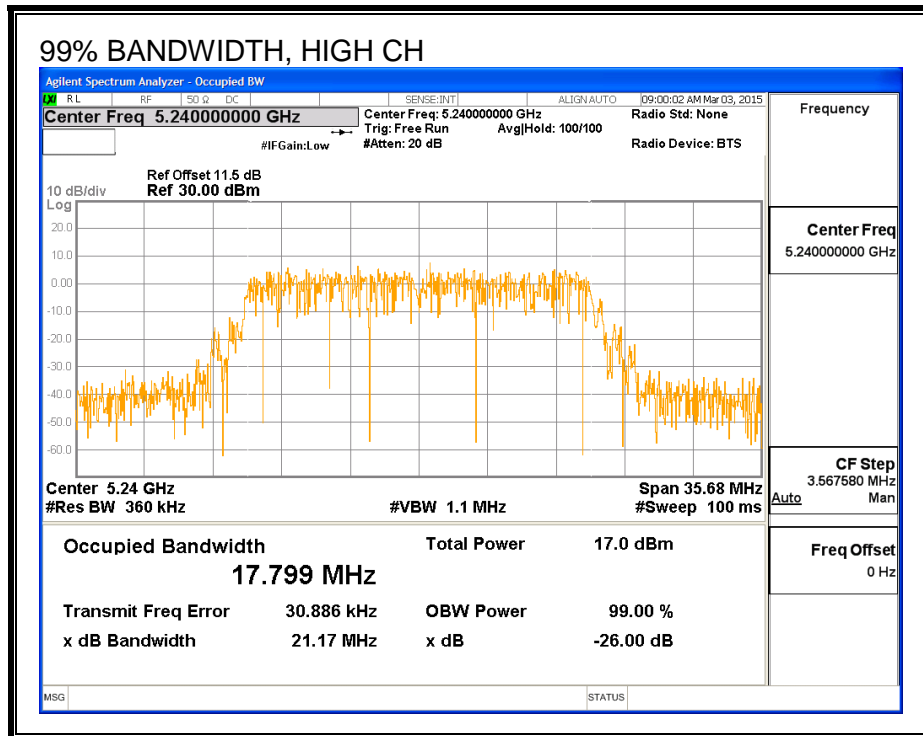
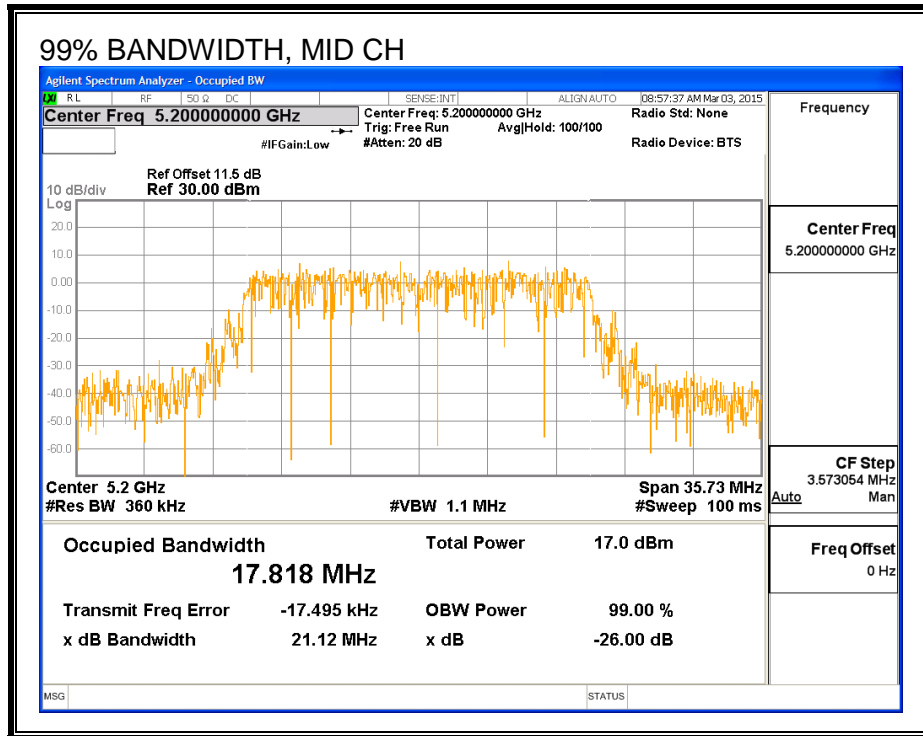

8.1.3. AVERAGE POWER

LIMITS

None; for reporting purposes only.

RESULTS

Channel	Frequency (MHz)	Power (dBm)
Low	5180	15.88
Mid	5200	17.87
High	5240	17.74

8.1.4. OUTPUT POWER AND PSD

LIMITS

FCC §15.407 (a) (1)

(i) For an outdoor access point operating in the band 5.15-5.25 GHz, the maximum conducted output power over the frequency band of operation shall not exceed 1 W provided the maximum antenna gain does not exceed 6 dBi. In addition, the maximum power spectral density shall not exceed 17 dBm in any 1 megahertz band. If transmitting antennas of directional gain greater than 6 dBi are used, both the maximum conducted output power and the maximum power spectral density shall be reduced by the amount in dB that the directional gain of the antenna exceeds 6 dBi. The maximum e.i.r.p. at any elevation angle above 30 degrees as measured from the horizon must not exceed 125 mW (21 dBm).

(ii) For an indoor access point operating in the band 5.15-5.25 GHz, the maximum conducted output power over the frequency band of operation shall not exceed 1 W provided the maximum antenna gain does not exceed 6 dBi. In addition, the maximum power spectral density shall not exceed 17 dBm in any 1 megahertz band. If transmitting antennas of directional gain greater than 6 dBi are used, both the maximum conducted output power and the maximum power spectral density shall be reduced by the amount in dB that the directional gain of the antenna exceeds 6 dBi.

(iii) For fixed point-to-point access points operating in the band 5.15-5.25 GHz, the maximum conducted output power over the frequency band of operation shall not exceed 1 W. Fixed point-to-point U-NII devices may employ antennas with directional gain up to 23 dBi without any corresponding reduction in the maximum conducted output power or maximum power spectral density. For fixed point-to-point transmitters that employ a directional antenna gain greater than 23 dBi, a 1 dB reduction in maximum conducted output power and maximum power spectral density is required for each 1 dB of antenna gain in excess of 23 dBi. Fixed, point-to-point operations exclude the use of point-to-multipoint systems, omnidirectional applications, and multiple collocated transmitters transmitting the same information. The operator of the U-NII device, or if the equipment is professionally installed, the installer, is responsible for ensuring that systems employing high gain directional antennas are used exclusively for fixed, point-to-point operations.

(iv) For mobile and portable client devices in the 5.15-5.25 GHz band, the maximum conducted output power over the frequency band of operation shall not exceed 250 mW provided the maximum antenna gain does not exceed 6 dBi. In addition, the maximum power spectral density shall not exceed 11 dBm in any 1 megahertz band. If transmitting antennas of directional gain greater than 6 dBi are used, both the maximum conducted output power and the maximum power spectral density shall be reduced by the amount in dB that the directional gain of the antenna exceeds 6 dBi.

DIRECTIONAL ANTENNA GAIN

There is only one transmitter output therefore the directional gain is equal to the antenna gain.

RESULTS

Antenna Gain and Limits

Channel	Frequency (MHz)	Directional Gain for Power (dBi)	Directional Gain for PSD (dBi)	Power Limit (dBm)	PSD Limit (dBm)
Low	5180	3.20	3.20	24.00	11.00
Mid	5200	3.20	3.20	24.00	11.00
High	5240	3.20	3.20	24.00	11.00

Duty Cycle CF (dB)	0.00	Included in Calculations of Corr'd Power & PSD
---------------------------	------	---

Output Power Results

Channel	Frequency (MHz)	Antenna B Meas Power (dBm)	Total Corr'd Power (dBm)	Power Limit (dBm)	Power Margin (dB)
Low	5180	15.88	15.88	24.00	-8.12
Mid	5200	17.87	17.87	24.00	-6.13
High	5240	17.74	17.74	24.00	-6.26

PSD Results

Channel	Frequency (MHz)	Antenna B Meas PSD (dBm)	Total Corr'd PSD (dBm)	PSD Limit (dBm)	PSD Margin (dB)
Low	5180	3.90	3.90	11.00	-7.10
Mid	5200	5.90	5.90	11.00	-5.10
High	5240	5.79	5.79	11.00	-5.21

PSD, ANTENNA B

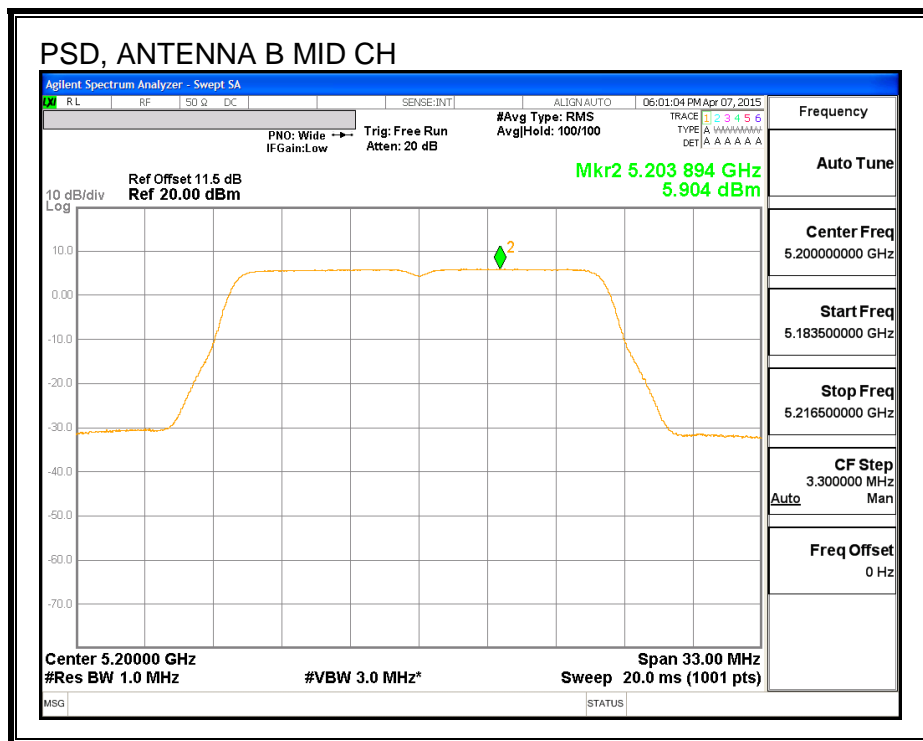
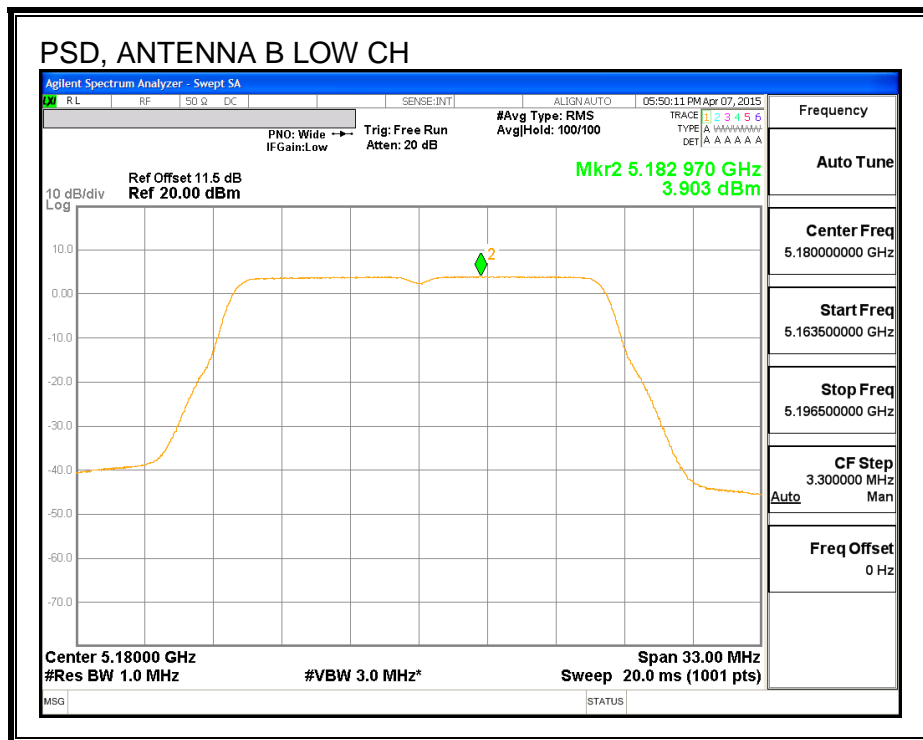

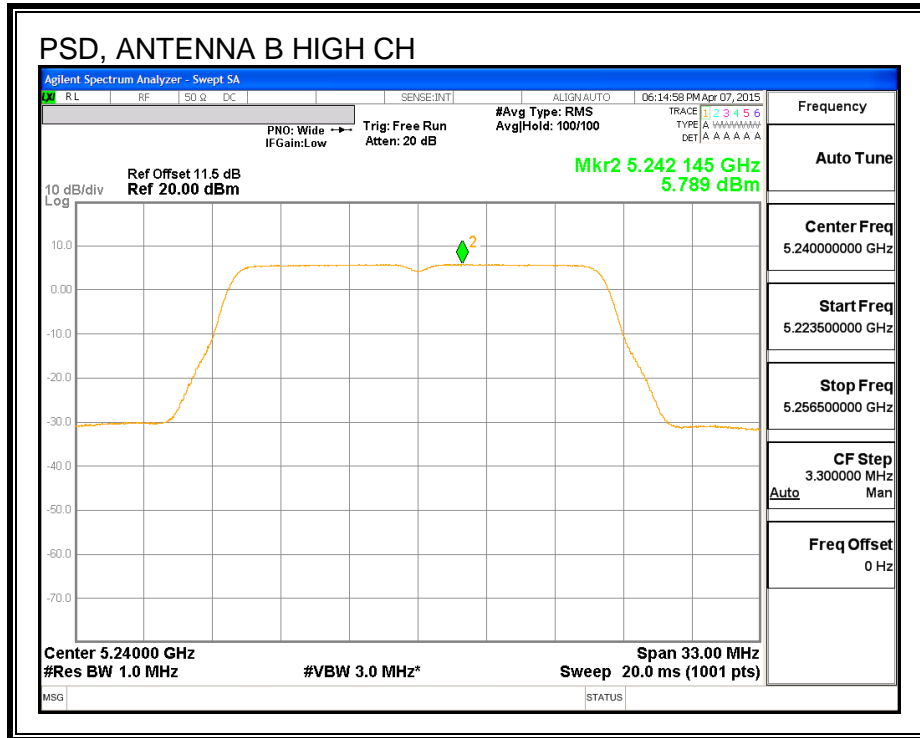

8.2. 802.11n HT20 2Tx CDD MODE IN THE 5.2 GHz BAND

8.2.1. 26 dB BANDWIDTH

LIMITS

None; for reporting purposes only.

RESULTS

Channel	Frequency (MHz)	26 dB BW Antenna B (MHz)	26 dB BW Antenna A (MHz)
Low	5180	22.00	21.95
Mid	5200	21.90	21.95
High	5240	21.85	21.80

26 dB BANDWIDTH, ANTENNA B

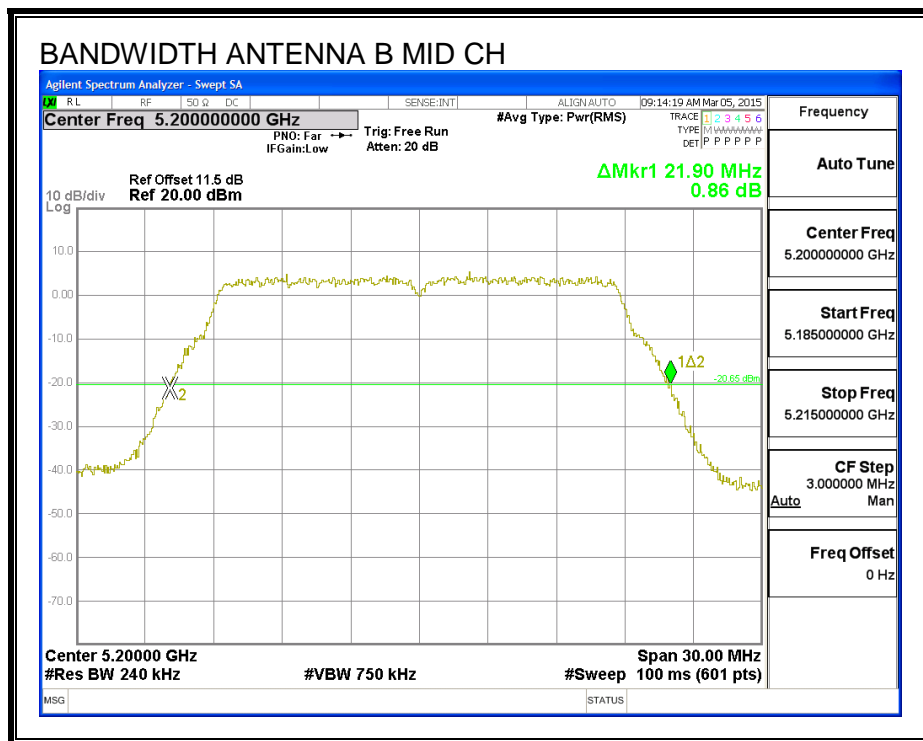
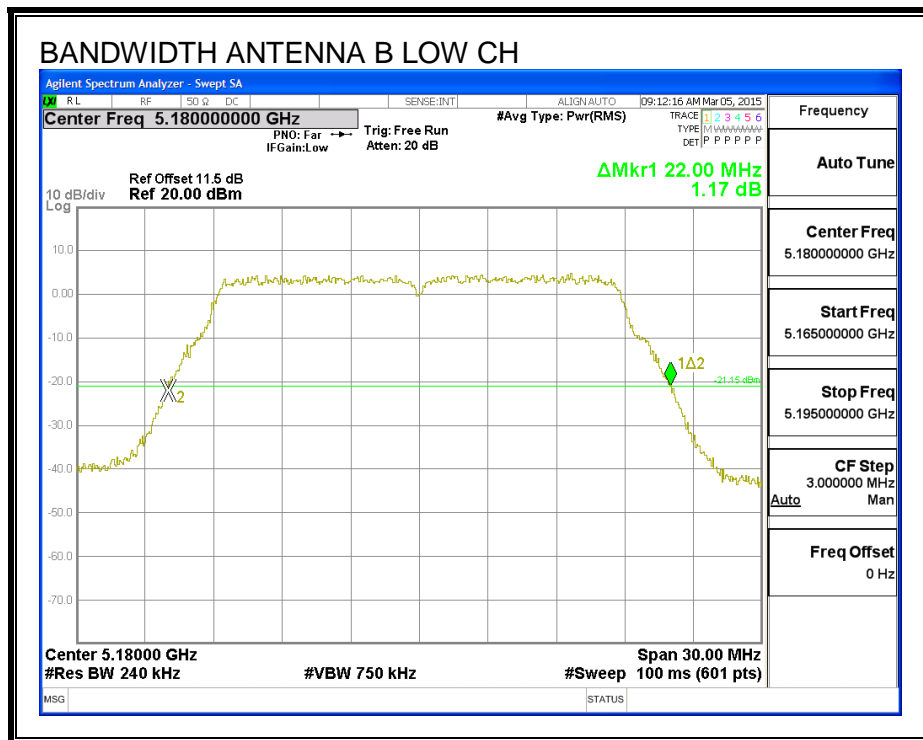

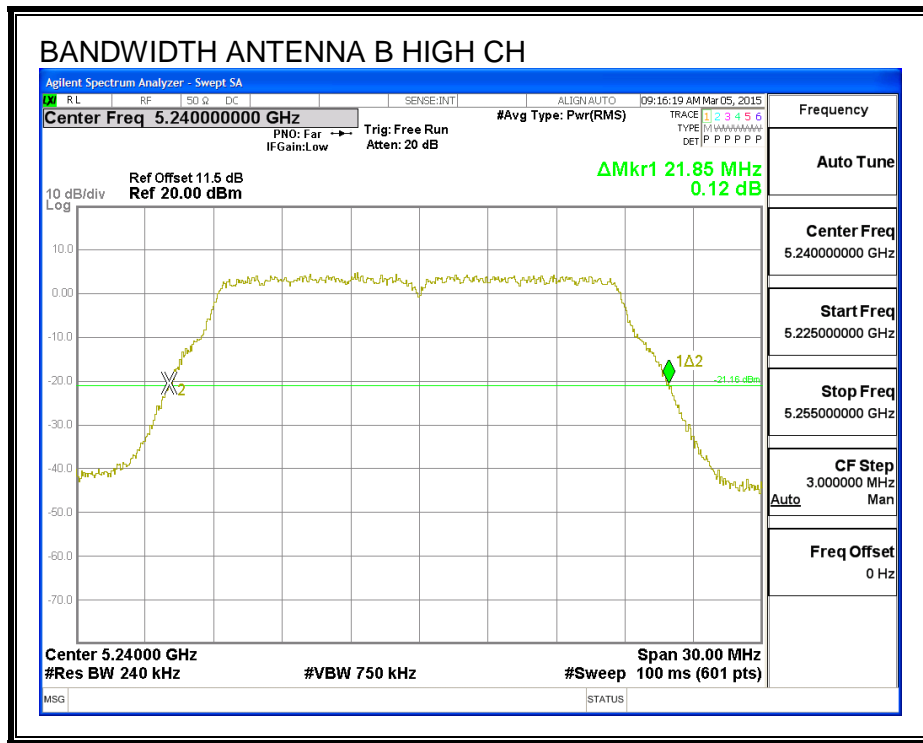

26 dB BANDWIDTH, ANTENNA A

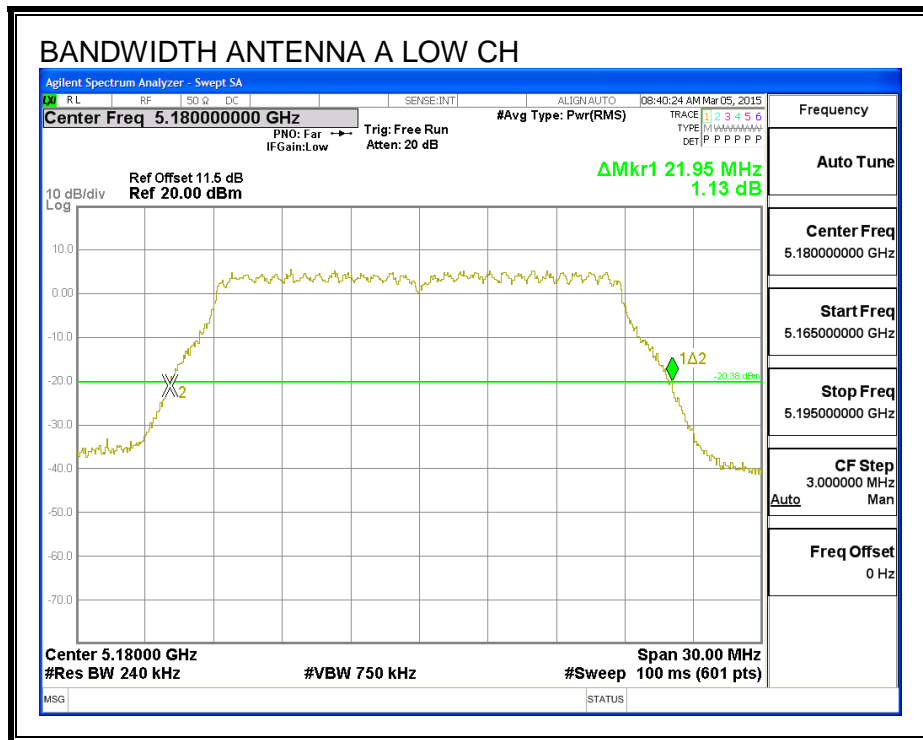

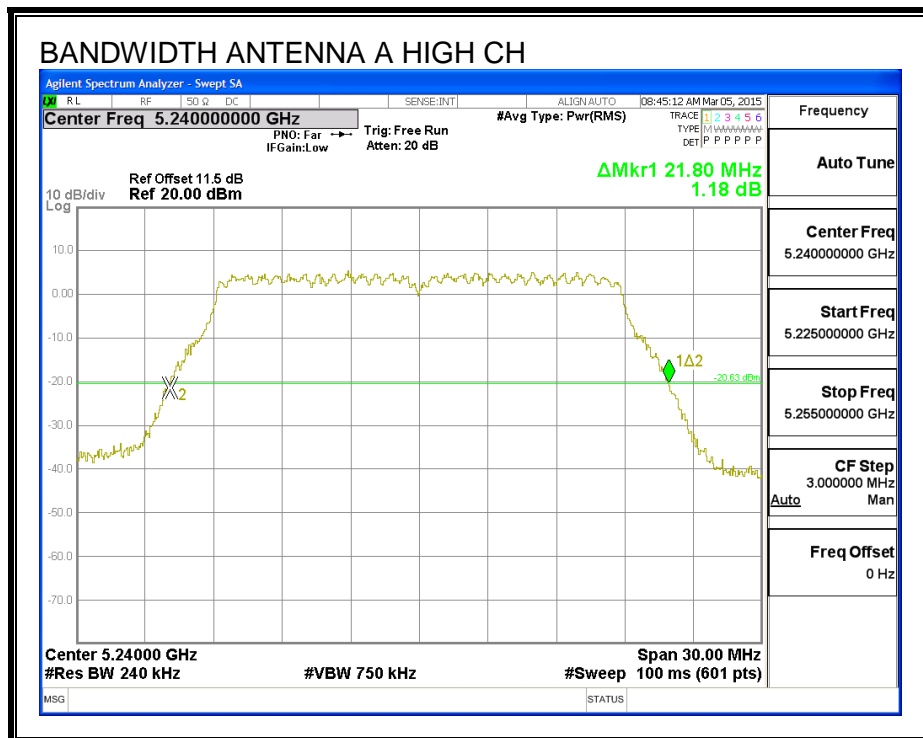
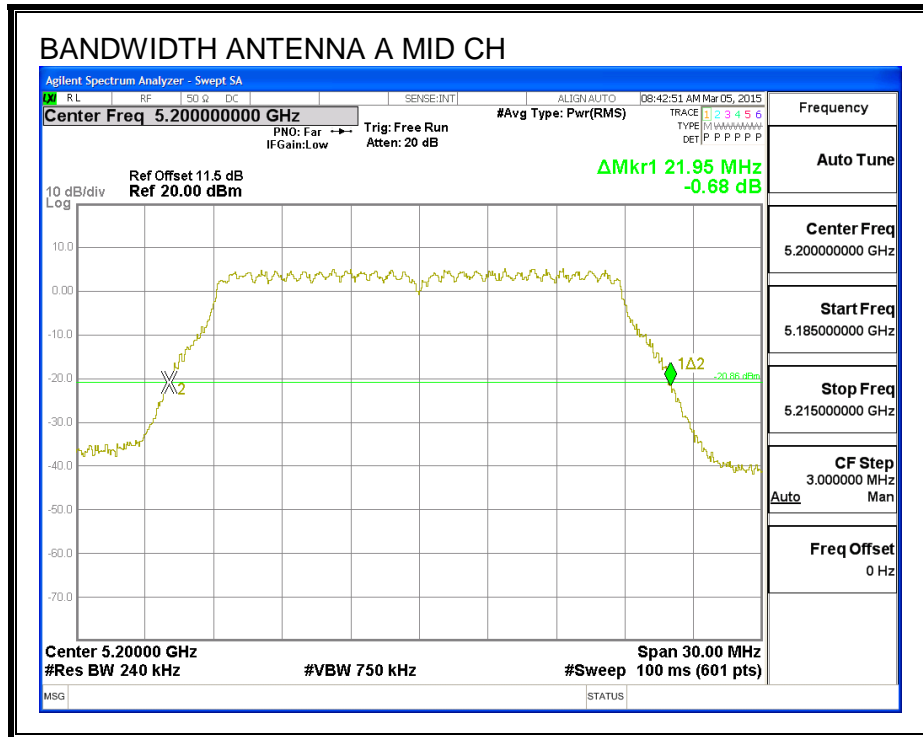

8.2.2. 99% BANDWIDTH

LIMITS

None; for reporting purposes only.

RESULTS

Channel	Frequency (MHz)	99% BW Antenna B (MHz)	99% BW Antenna A (MHz)
Low	5180	17.75	17.97
Mid	5200	17.98	17.70
High	5240	17.97	17.81

99% BANDWIDTH, ANTENNA B

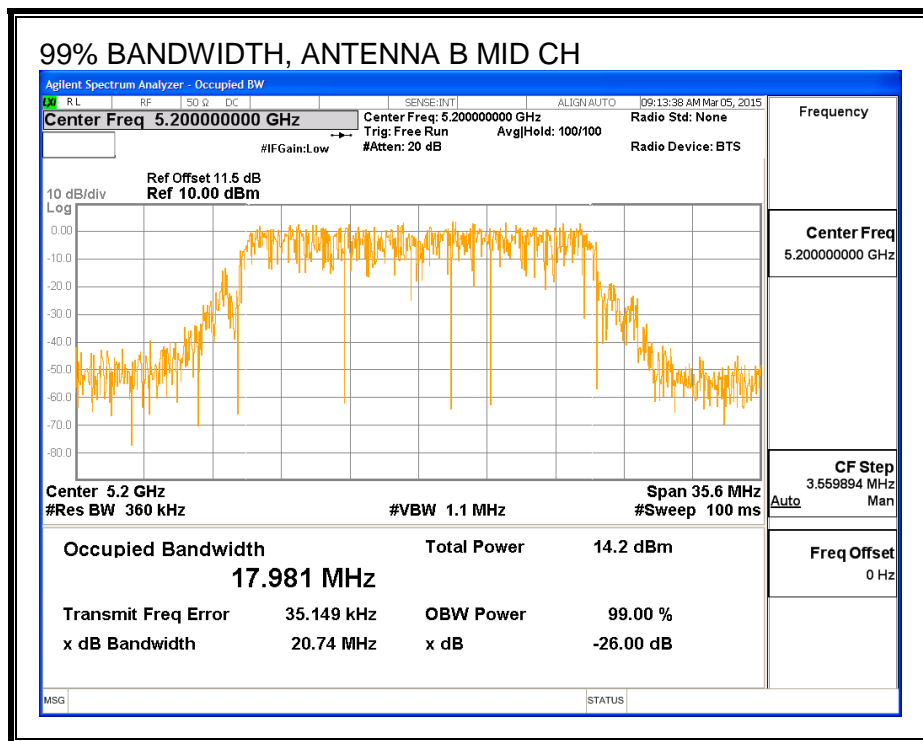
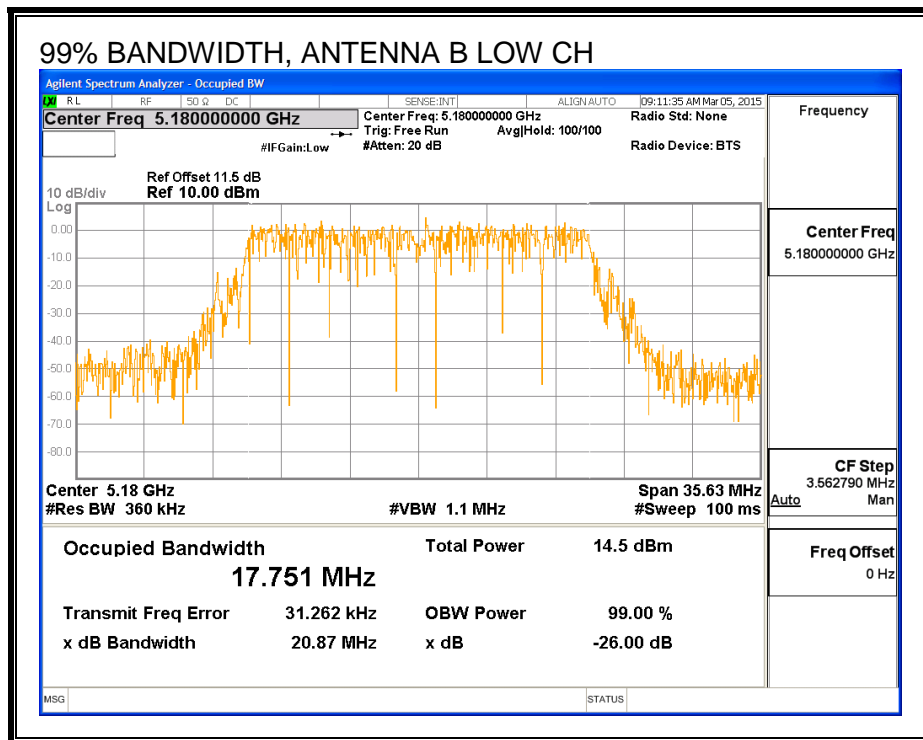

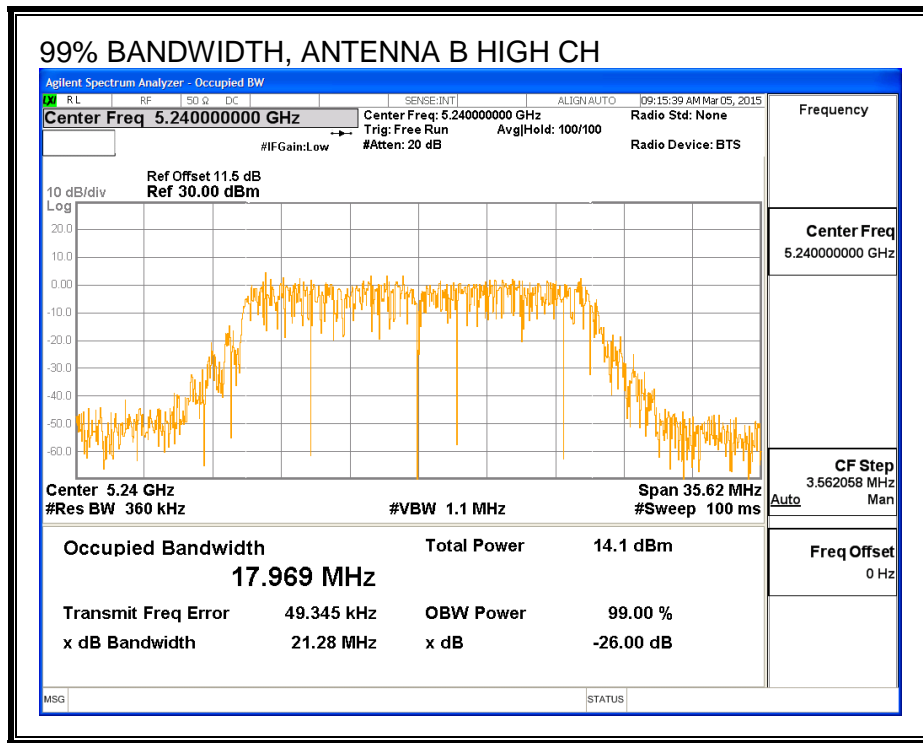

99% BANDWIDTH, ANTENNA A

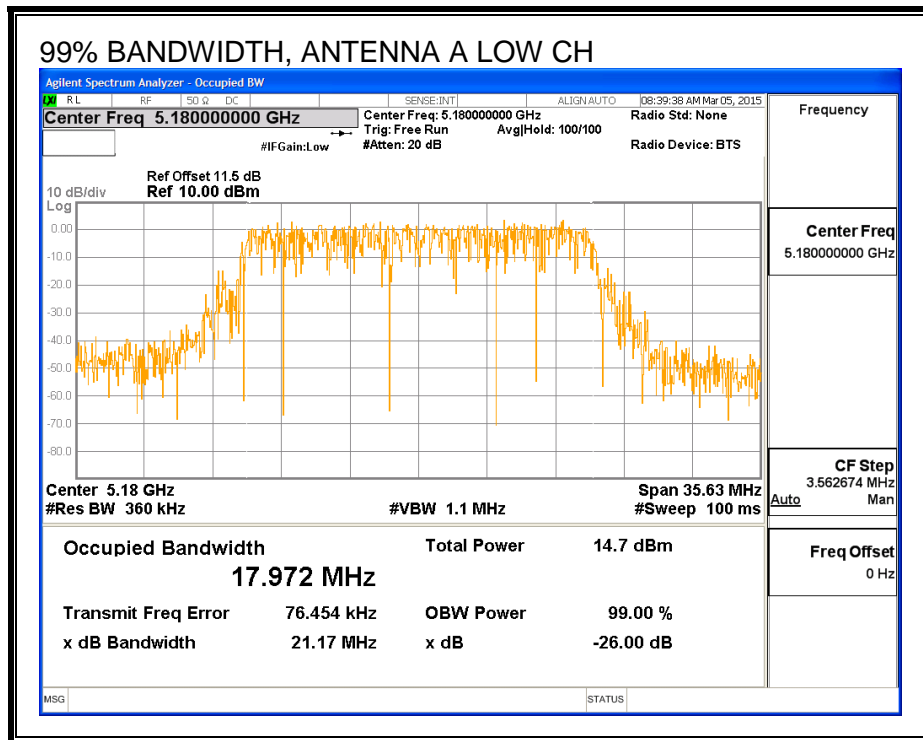

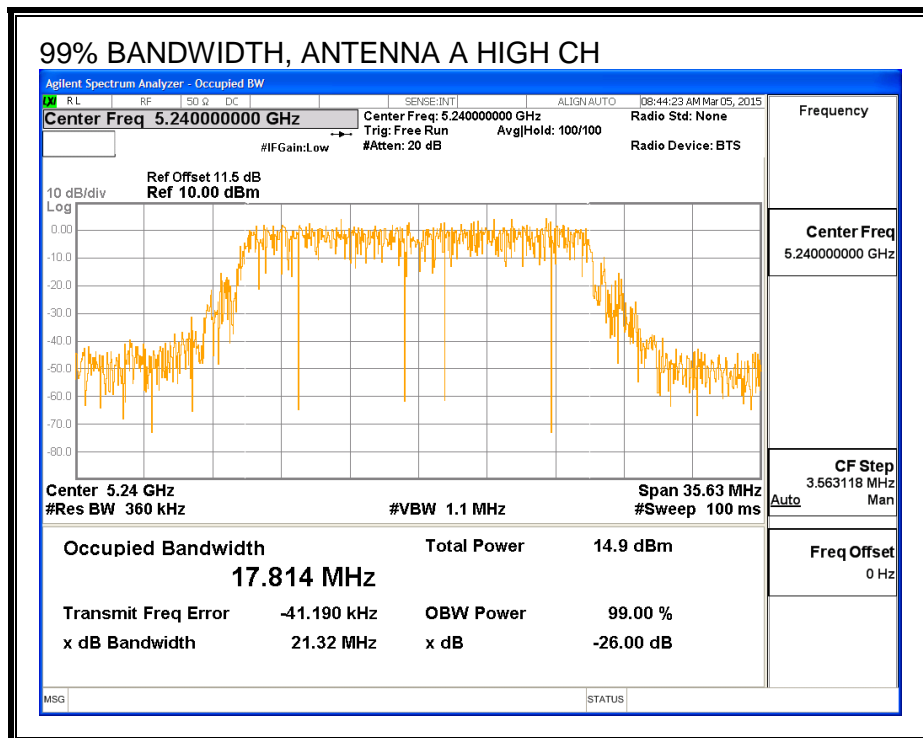
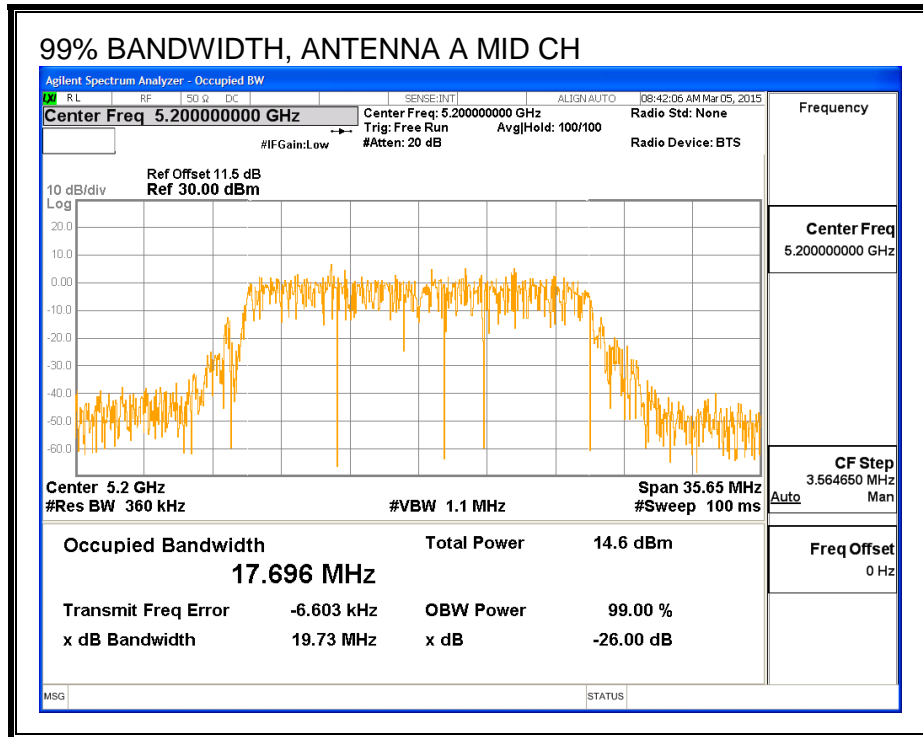

8.2.3. AVERAGE POWER

LIMITS

None; for reporting purposes only.

RESULTS

Average Power Results

Channel	Frequency (MHz)	Antenna B Power (dBm)	Antenna A Power (dBm)	Total Power (dBm)
Low	5180	14.87	14.97	17.93
Mid	5200	15.90	15.84	18.88
High	5240	15.75	15.92	18.85

8.2.4. OUTPUT POWER AND PSD

LIMITS

FCC §15.407 (a) (1)

(i) For an outdoor access point operating in the band 5.15-5.25 GHz, the maximum conducted output power over the frequency band of operation shall not exceed 1 W provided the maximum antenna gain does not exceed 6 dBi. In addition, the maximum power spectral density shall not exceed 17 dBm in any 1 megahertz band. If transmitting antennas of directional gain greater than 6 dBi are used, both the maximum conducted output power and the maximum power spectral density shall be reduced by the amount in dB that the directional gain of the antenna exceeds 6 dBi. The maximum e.i.r.p. at any elevation angle above 30 degrees as measured from the horizon must not exceed 125 mW (21 dBm).

(ii) For an indoor access point operating in the band 5.15-5.25 GHz, the maximum conducted output power over the frequency band of operation shall not exceed 1 W provided the maximum antenna gain does not exceed 6 dBi. In addition, the maximum power spectral density shall not exceed 17 dBm in any 1 megahertz band. If transmitting antennas of directional gain greater than 6 dBi are used, both the maximum conducted output power and the maximum power spectral density shall be reduced by the amount in dB that the directional gain of the antenna exceeds 6 dBi.

(iii) For fixed point-to-point access points operating in the band 5.15-5.25 GHz, the maximum conducted output power over the frequency band of operation shall not exceed 1 W. Fixed point-to-point U-NII devices may employ antennas with directional gain up to 23 dBi without any corresponding reduction in the maximum conducted output power or maximum power spectral density. For fixed point-to-point transmitters that employ a directional antenna gain greater than 23 dBi, a 1 dB reduction in maximum conducted output power and maximum power spectral density is required for each 1 dB of antenna gain in excess of 23 dBi. Fixed, point-to-point operations exclude the use of point-to-multipoint systems, omnidirectional applications, and multiple collocated transmitters transmitting the same information. The operator of the U-NII device, or if the equipment is professionally installed, the installer, is responsible for ensuring that systems employing high gain directional antennas are used exclusively for fixed, point-to-point operations.

(iv) For mobile and portable client devices in the 5.15-5.25 GHz band, the maximum conducted output power over the frequency band of operation shall not exceed 250 mW provided the maximum antenna gain does not exceed 6 dBi. In addition, the maximum power spectral density shall not exceed 11 dBm in any 1 megahertz band. If transmitting antennas of directional gain greater than 6 dBi are used, both the maximum conducted output power and the maximum power spectral density shall be reduced by the amount in dB that the directional gain of the antenna exceeds 6 dBi.

DIRECTIONAL ANTENNA GAIN

The TX chains are uncorrelated and the antenna gain is unequal among the chains. The directional gain is:

Antenna B	Antenna A	Uncorrelated Chains
Gain (dBi)	Gain (dBi)	Directional Gain (dBi)
3.20	2.10	2.68

The TX chains are correlated and the antenna gain is unequal among the chains. The directional gain is:

Antenna B	Antenna A	Correlated Chains
Gain (dBi)	Gain (dBi)	Directional Gain (dBi)
3.20	2.10	5.68

RESULTS

Antenna Gain and Limits

Channel	Frequency (MHz)	Directional Gain for Power (dBi)	Directional Gain for PSD (dBi)	Power Limit (dBm)	PSD Limit (dBm)
Low	5180	2.68	5.68	24.00	11.00
Mid	5200	2.68	5.68	24.00	11.00
High	5240	2.68	5.68	24.00	11.00

Duty Cycle CF (dB)	0.00	Included in Calculations of Corr'd Power & PSD
---------------------------	------	---

Output Power Results

Channel	Frequency (MHz)	Antenna B Meas Power (dBm)	Antenna A Meas Power (dBm)	Total Corr'd Power (dBm)	Power Limit (dBm)	Power Margin (dB)
Low	5180	14.87	14.97	17.93	24.00	-6.07
Mid	5200	15.90	15.84	18.88	24.00	-5.12
High	5240	15.75	15.92	18.85	24.00	-5.15

PSD Results

Channel	Frequency (MHz)	Antenna B Meas PSD (dBm)	Antenna A Meas PSD (dBm)	Total Corr'd PSD (dBm)	PSD Limit (dBm)	PSD Margin (dB)
Low	5180	2.93	2.99	5.97	11.00	-5.03
Mid	5200	3.97	3.90	6.95	11.00	-4.05
High	5240	3.78	3.94	6.87	11.00	-4.13

PSD, ANTENNA B

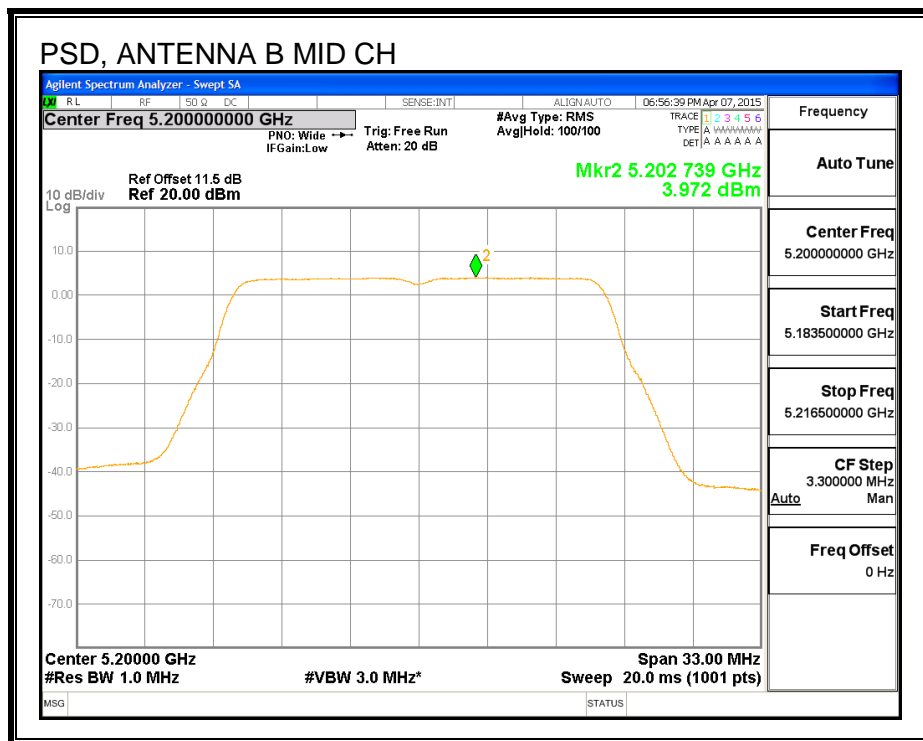
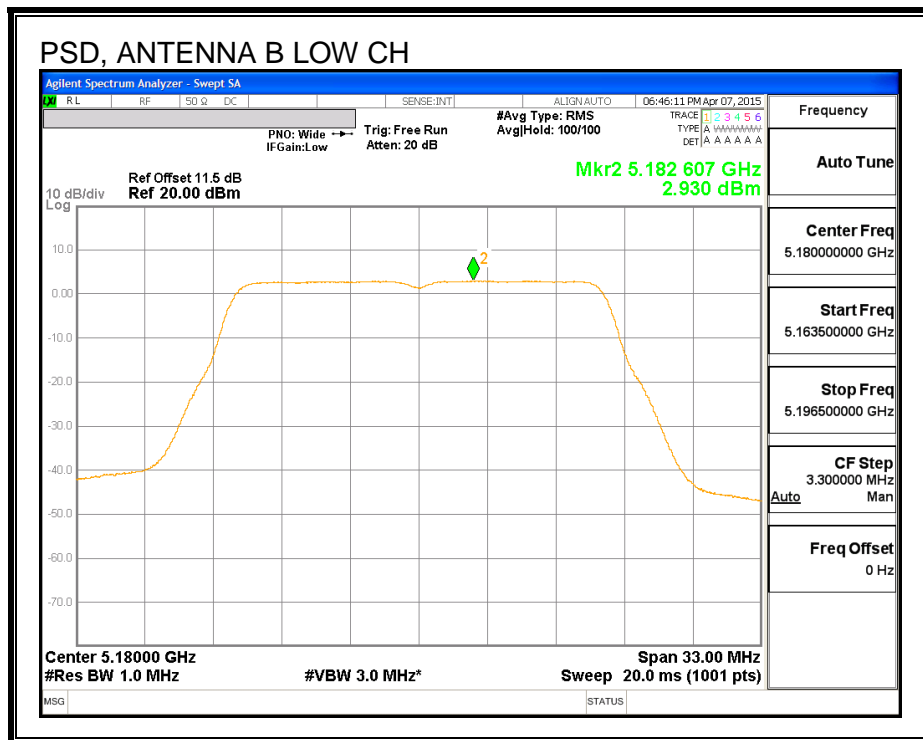

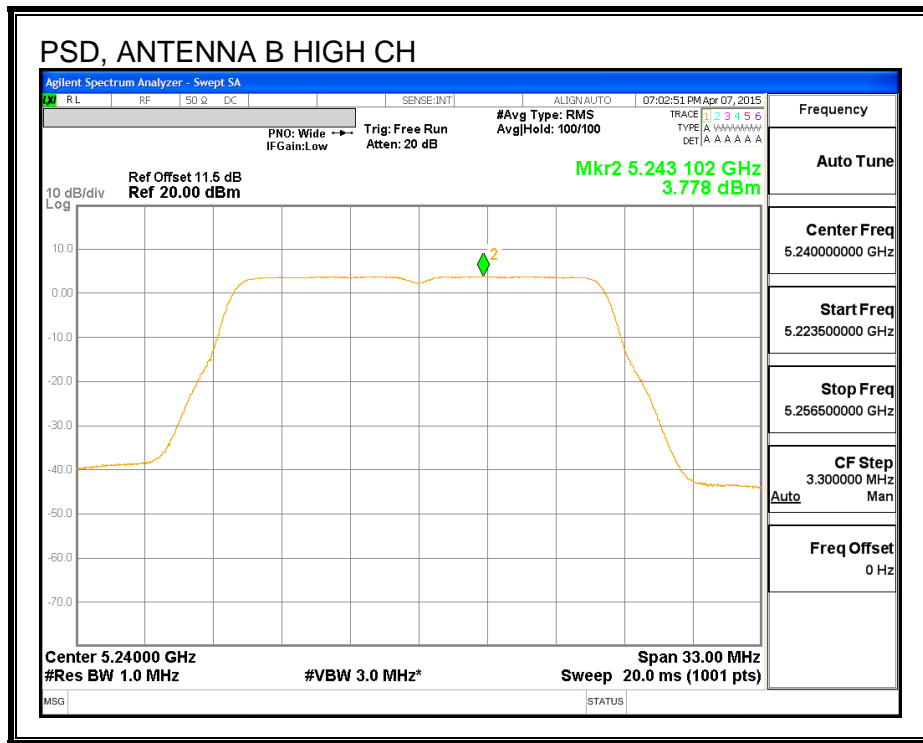

PSD, ANTENNA A

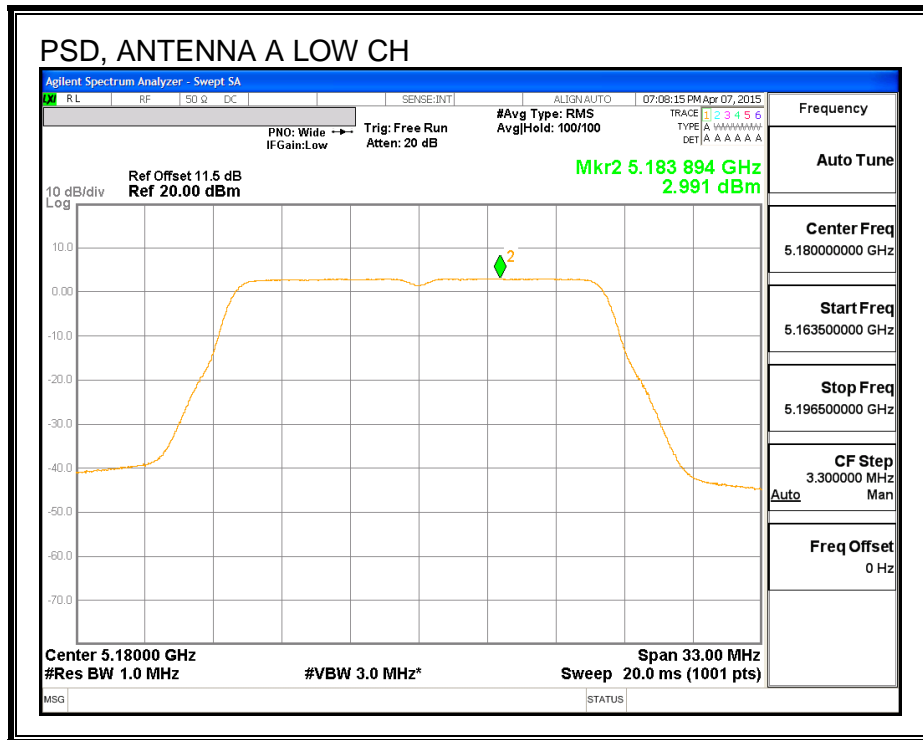

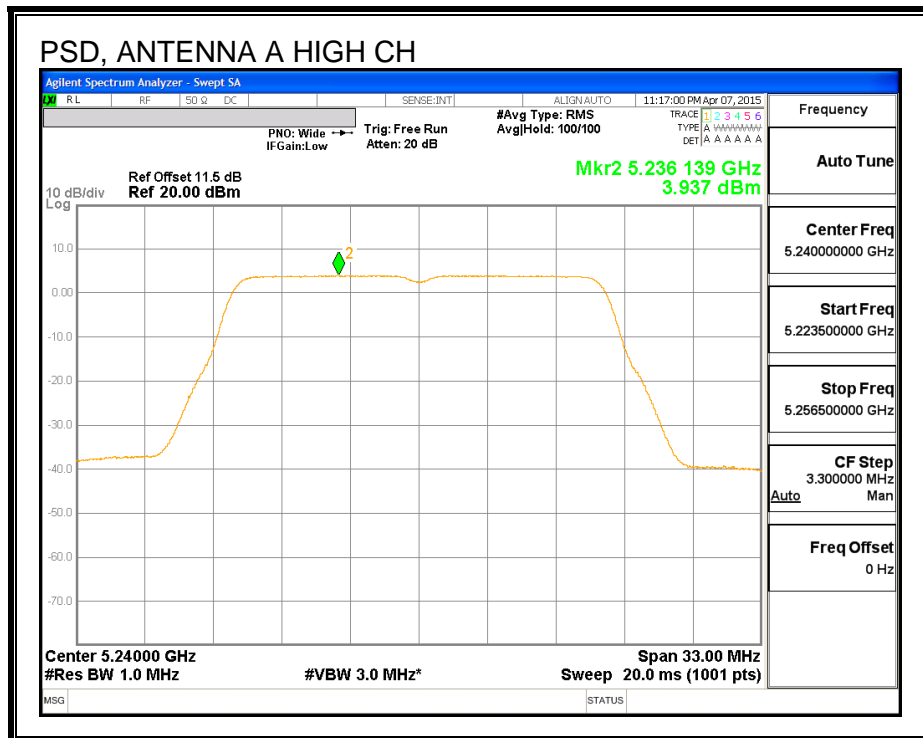
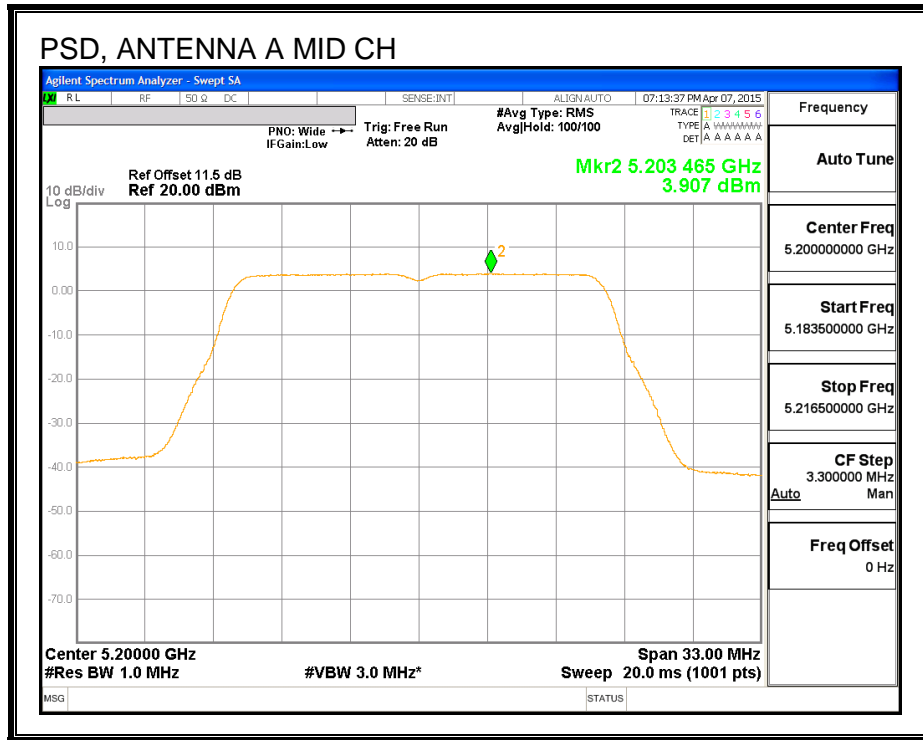

8.3. 802.11n HT20 2Tx STBC MODE IN THE 5.2 GHz BAND

8.3.1. 26 dB BANDWIDTH

LIMITS

None; for reporting purposes only.

RESULTS

Channel	Frequency (MHz)	26 dB BW Antenna B (MHz)	26 dB BW Antenna A (MHz)
Low	5180	21.96	21.93
Mid	5200	21.96	21.78
High	5240	21.84	21.96

26 dB BANDWIDTH, ANTENNA B

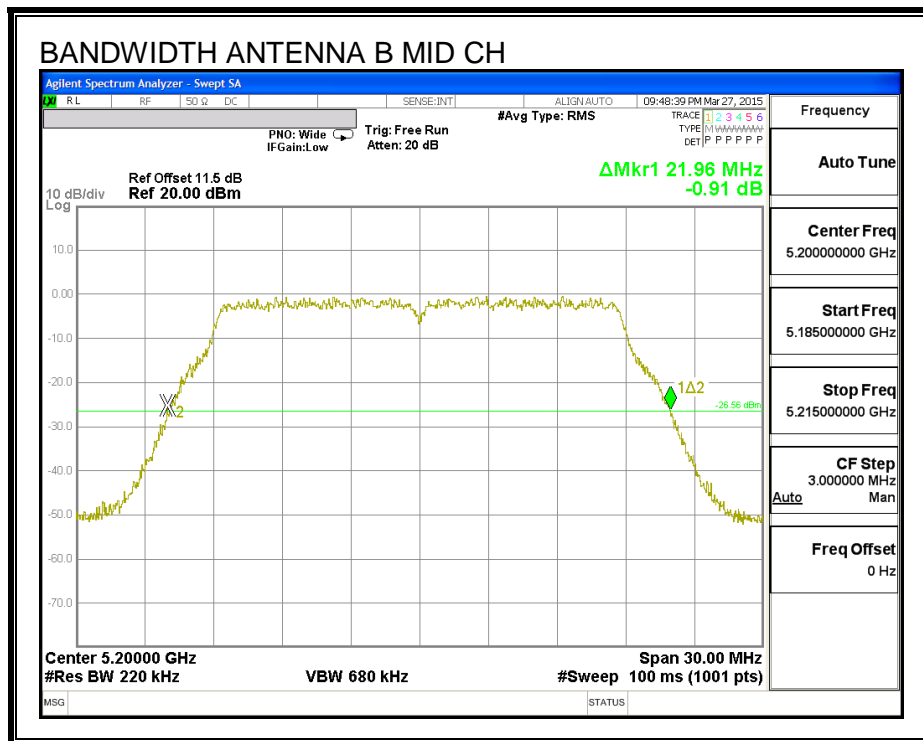
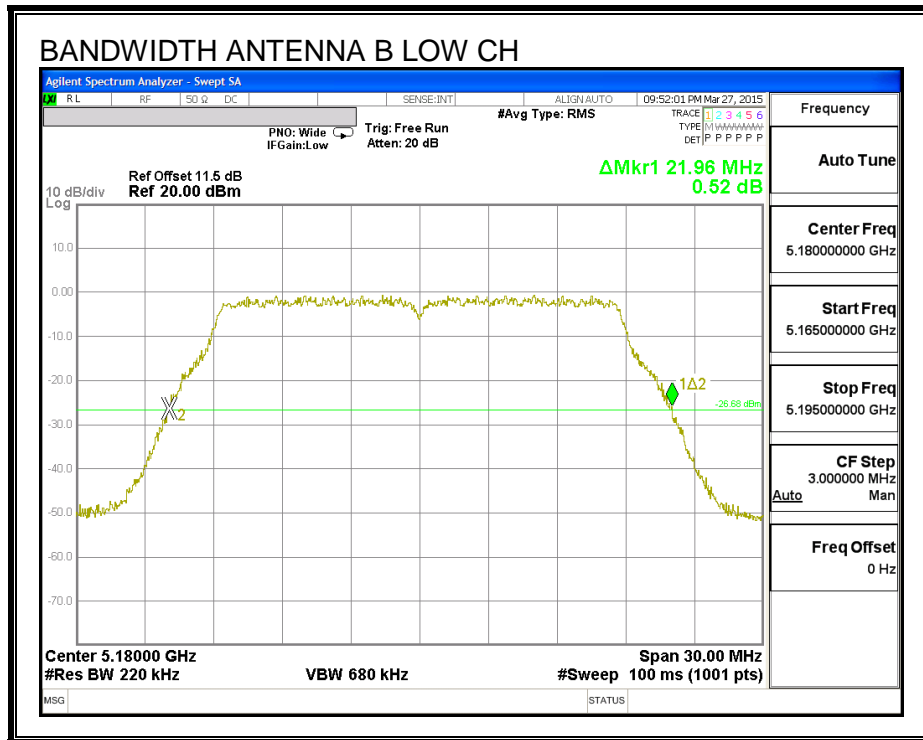

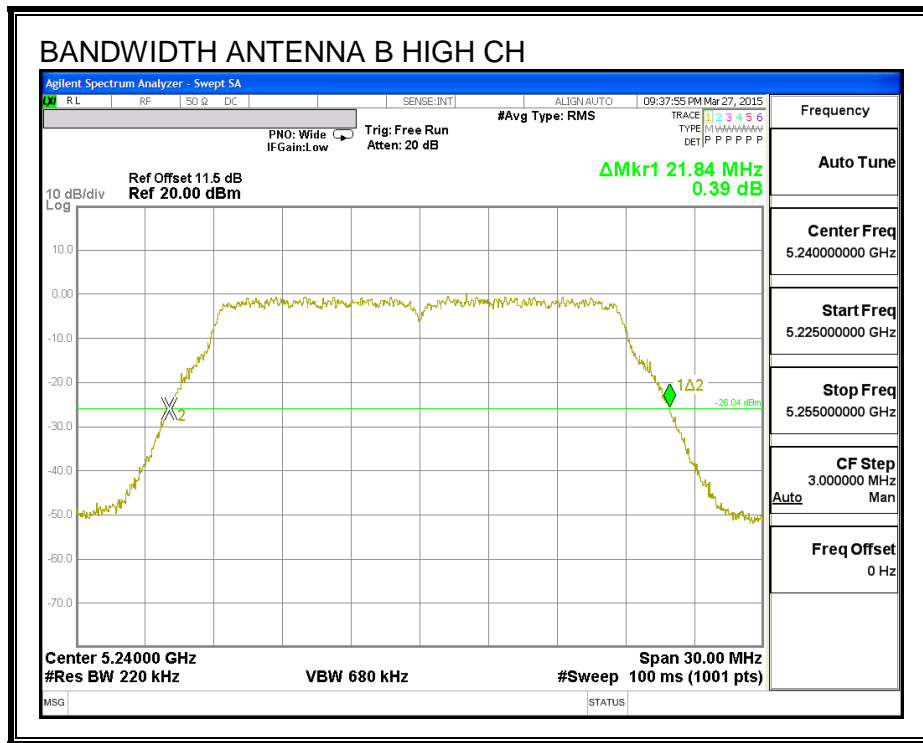

26 dB BANDWIDTH, ANTENNA A

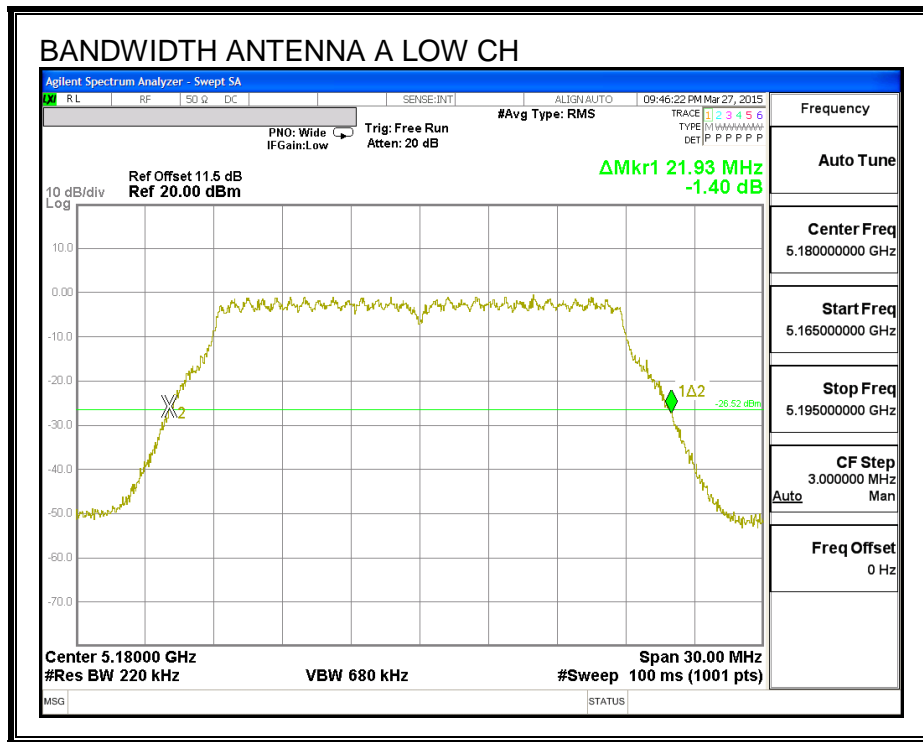

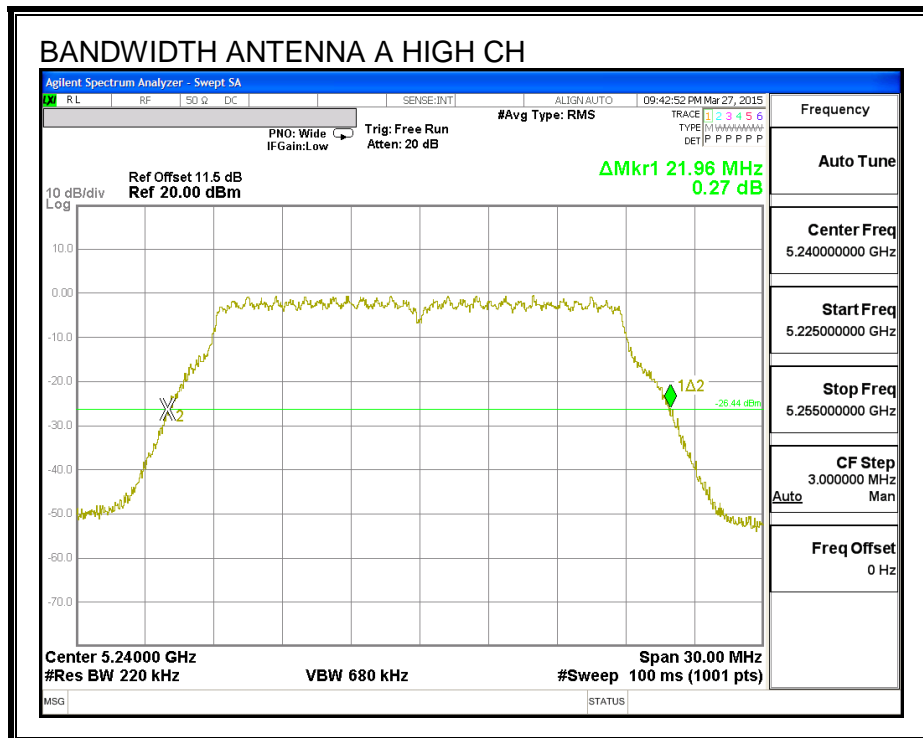
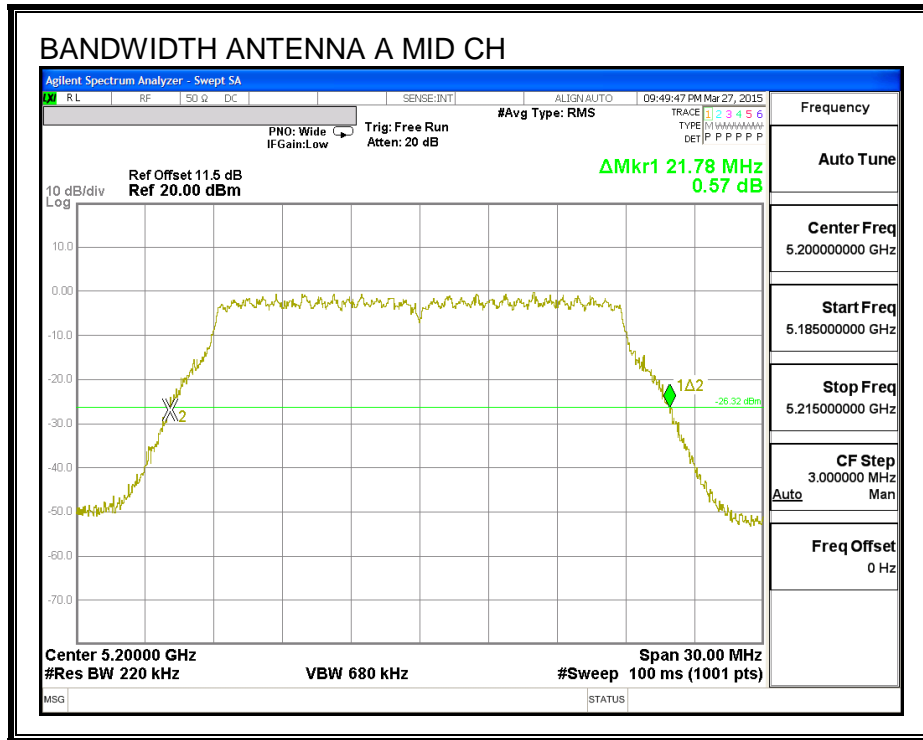

8.3.2. 99% BANDWIDTH

LIMITS

None; for reporting purposes only.

RESULTS

Channel	Frequency (MHz)	99% BW Antenna B (MHz)	99% BW Antenna A (MHz)
Low	5180	17.735	17.923
Mid	5200	17.880	17.914
High	5240	17.893	17.794

99% BANDWIDTH, ANTENNA B

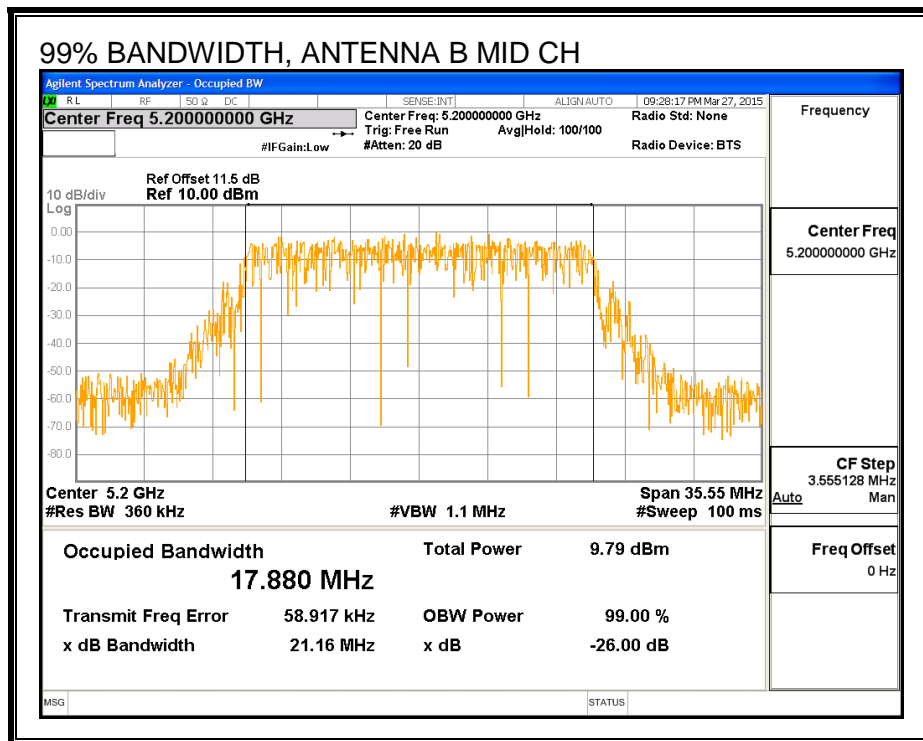
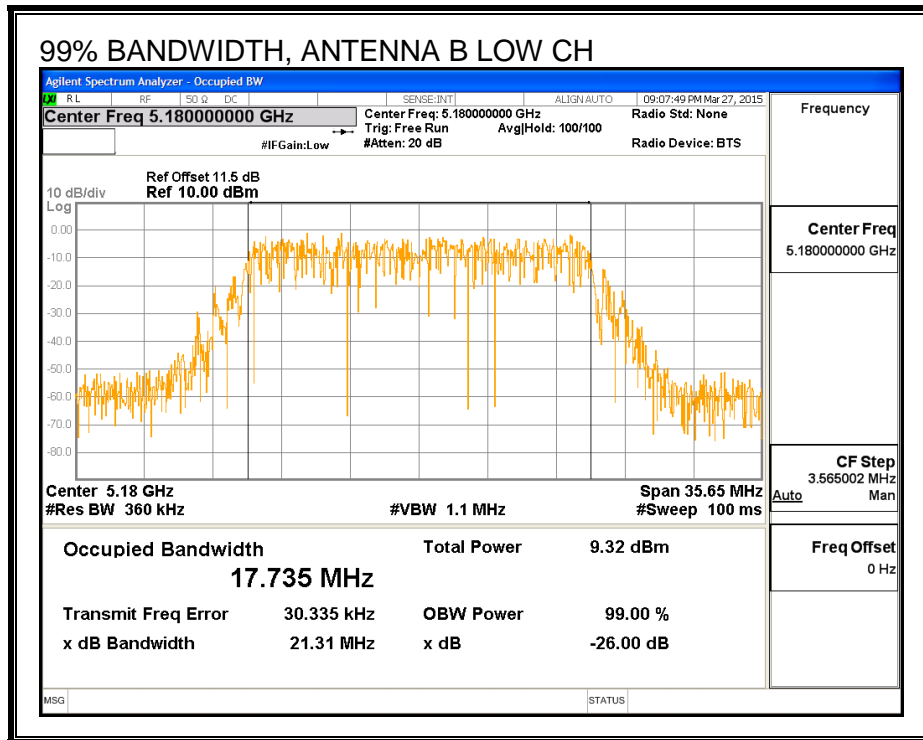

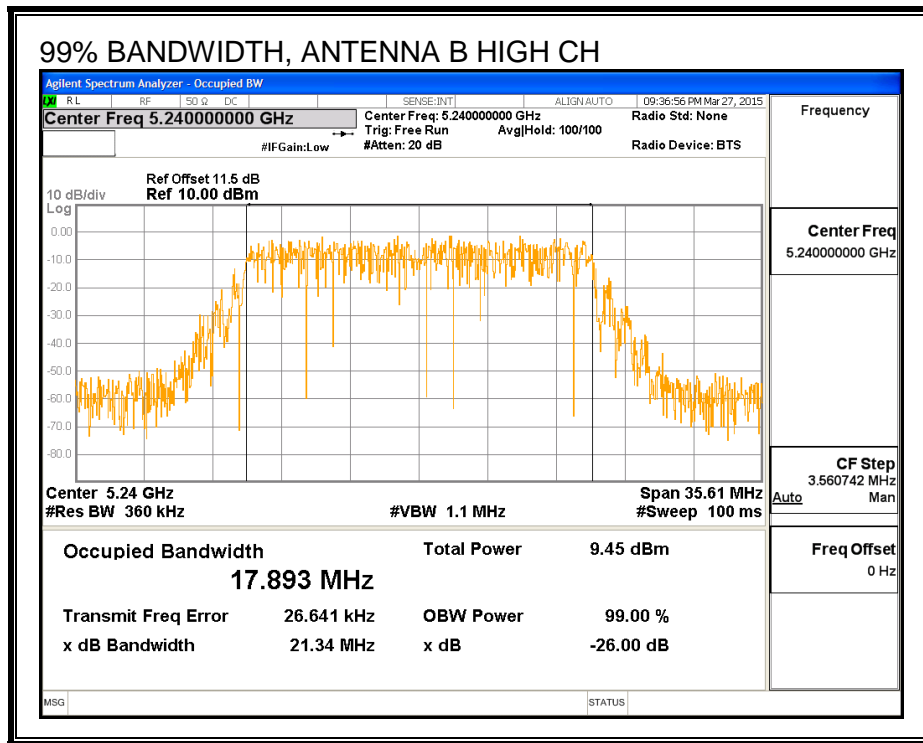

99% BANDWIDTH, ANTENNA A

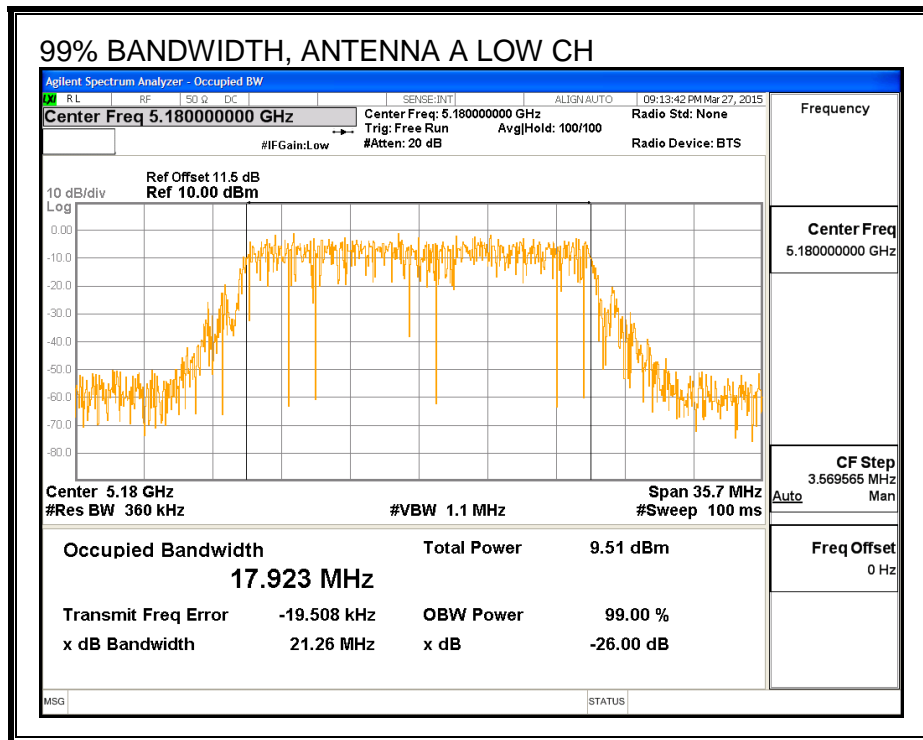

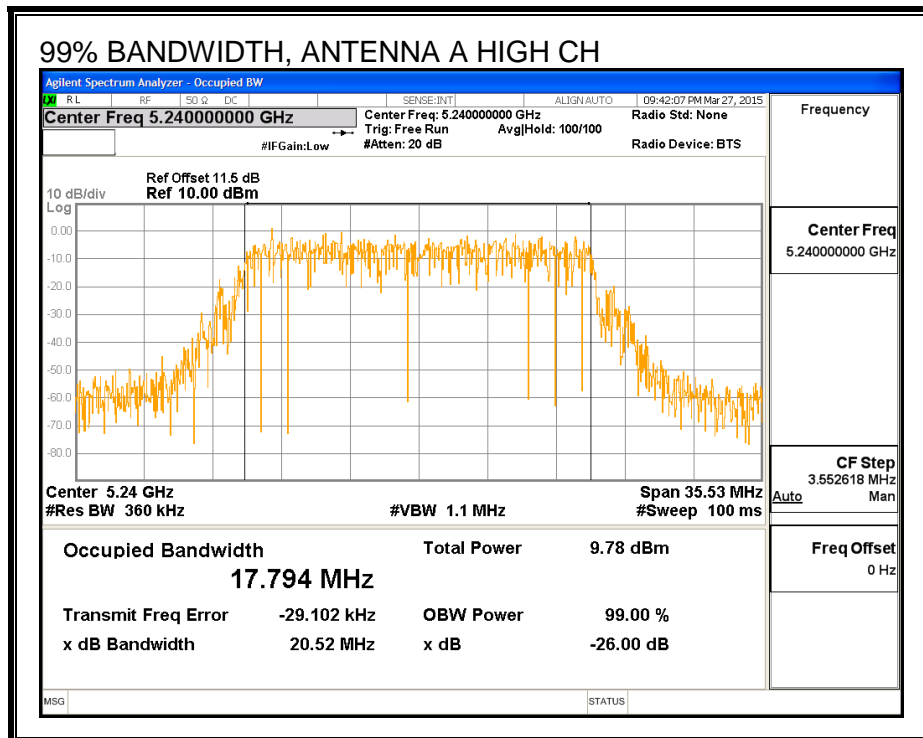
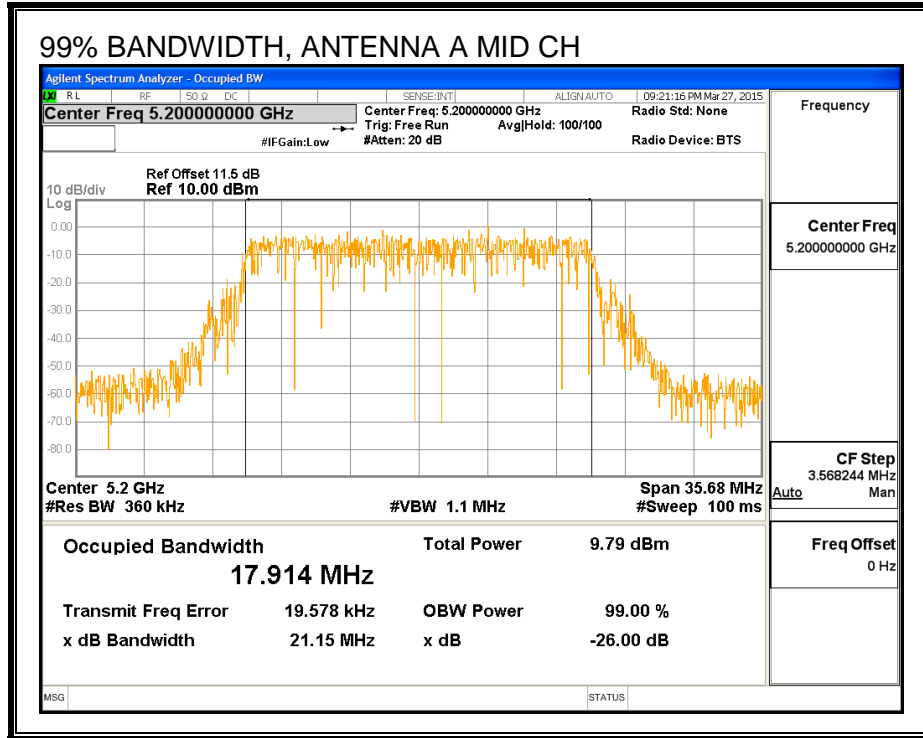

8.3.3. AVERAGE POWER

LIMITS

None; for reporting purposes only.

RESULTS

Average Power Results

Channel	Frequency (MHz)	Antenna B Power (dBm)	Antenna A Power (dBm)	Total Power (dBm)
Low	5180	14.95	14.94	17.95
Mid	5200	16.90	16.85	19.88
High	5240	16.81	17.00	19.91

8.3.4. OUTPUT POWER AND PSD

LIMITS

FCC §15.407 (a) (1)

(i) For an outdoor access point operating in the band 5.15-5.25 GHz, the maximum conducted output power over the frequency band of operation shall not exceed 1 W provided the maximum antenna gain does not exceed 6 dBi. In addition, the maximum power spectral density shall not exceed 17 dBm in any 1 megahertz band. If transmitting antennas of directional gain greater than 6 dBi are used, both the maximum conducted output power and the maximum power spectral density shall be reduced by the amount in dB that the directional gain of the antenna exceeds 6 dBi. The maximum e.i.r.p. at any elevation angle above 30 degrees as measured from the horizon must not exceed 125 mW (21 dBm).

(ii) For an indoor access point operating in the band 5.15-5.25 GHz, the maximum conducted output power over the frequency band of operation shall not exceed 1 W provided the maximum antenna gain does not exceed 6 dBi. In addition, the maximum power spectral density shall not exceed 17 dBm in any 1 megahertz band. If transmitting antennas of directional gain greater than 6 dBi are used, both the maximum conducted output power and the maximum power spectral density shall be reduced by the amount in dB that the directional gain of the antenna exceeds 6 dBi.

(iii) For fixed point-to-point access points operating in the band 5.15-5.25 GHz, the maximum conducted output power over the frequency band of operation shall not exceed 1 W. Fixed point-to-point U-NII devices may employ antennas with directional gain up to 23 dBi without any corresponding reduction in the maximum conducted output power or maximum power spectral density. For fixed point-to-point transmitters that employ a directional antenna gain greater than 23 dBi, a 1 dB reduction in maximum conducted output power and maximum power spectral density is required for each 1 dB of antenna gain in excess of 23 dBi. Fixed, point-to-point operations exclude the use of point-to-multipoint systems, omnidirectional applications, and multiple collocated transmitters transmitting the same information. The operator of the U-NII device, or if the equipment is professionally installed, the installer, is responsible for ensuring that systems employing high gain directional antennas are used exclusively for fixed, point-to-point operations.

(iv) For mobile and portable client devices in the 5.15-5.25 GHz band, the maximum conducted output power over the frequency band of operation shall not exceed 250 mW provided the maximum antenna gain does not exceed 6 dBi. In addition, the maximum power spectral density shall not exceed 11 dBm in any 1 megahertz band. If transmitting antennas of directional gain greater than 6 dBi are used, both the maximum conducted output power and the maximum power spectral density shall be reduced by the amount in dB that the directional gain of the antenna exceeds 6 dBi.

DIRECTIONAL ANTENNA GAIN

The TX chains are uncorrelated and the antenna gain is unequal among the chains. The directional gain is:

Antenna B Antenna Gain (dBi)	Antenna A Antenna Gain (dBi)	Uncorrelated Chains Directional Gain (dBi)
3.20	2.10	2.68

The TX chains are correlated and the antenna gain is unequal among the chains. The directional gain is:

Antenna B Antenna Gain (dBi)	Antenna A Antenna Gain (dBi)	Correlated Chains Directional Gain (dBi)
3.20	2.10	5.68

RESULTS

Antenna Gain and Limits

Channel	Frequency (MHz)	Directional Gain for Power (dBi)	Directional Gain for PSD (dBi)	Power Limit (dBm)	PSD Limit (dBm)
Low	5180	2.68	2.68	24.00	11.00
Mid	5200	2.68	2.68	24.00	11.00
High	5240	2.68	2.68	24.00	11.00

Duty Cycle CF (dB)	0.00	Included in Calculations of Corr'd Power & PSD
---------------------------	------	---

Output Power Results

Channel	Frequency (MHz)	Antenna B Meas Power (dBm)	Antenna A Meas Power (dBm)	Total Corr'd Power (dBm)	Power Limit (dBm)	Power Margin (dB)
Low	5180	14.95	14.94	17.95	24.00	-6.05
Mid	5200	16.90	16.85	19.88	24.00	-4.12
High	5240	16.81	17.00	19.91	24.00	-4.09

PSD Results

Channel	Frequency (MHz)	Antenna B Meas PSD (dBm)	Antenna A Meas PSD (dBm)	Total Corr'd PSD (dBm)	PSD Limit (dBm)	PSD Margin (dB)
Low	5180	2.99	2.99	6.00	11.00	-5.00
Mid	5200	5.05	4.86	7.97	11.00	-3.03
High	5240	4.84	5.03	7.94	11.00	-3.06

PSD, ANTENNA B

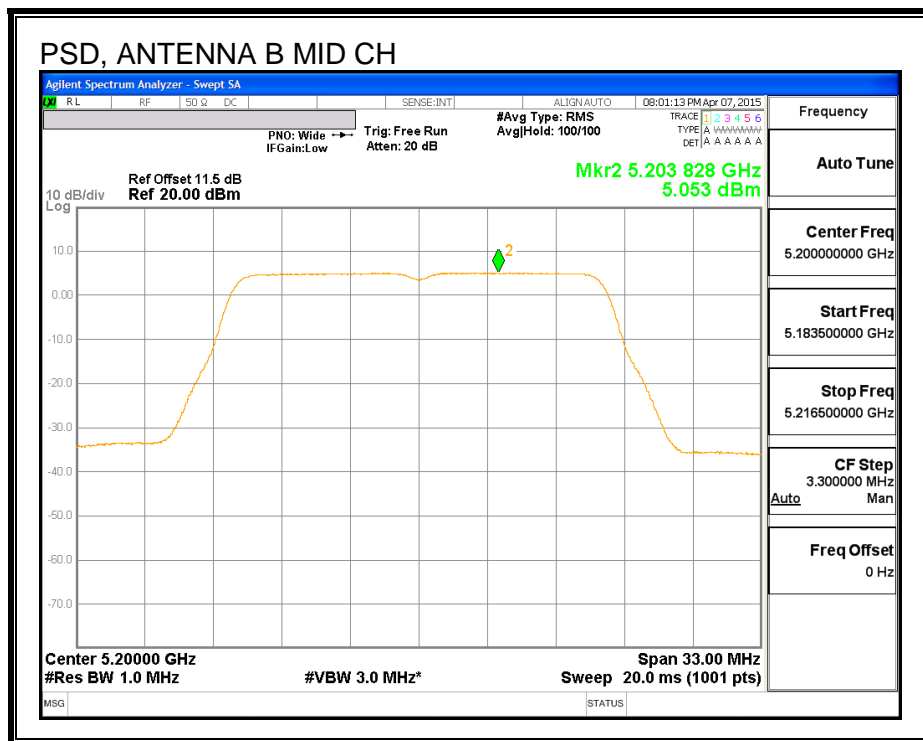
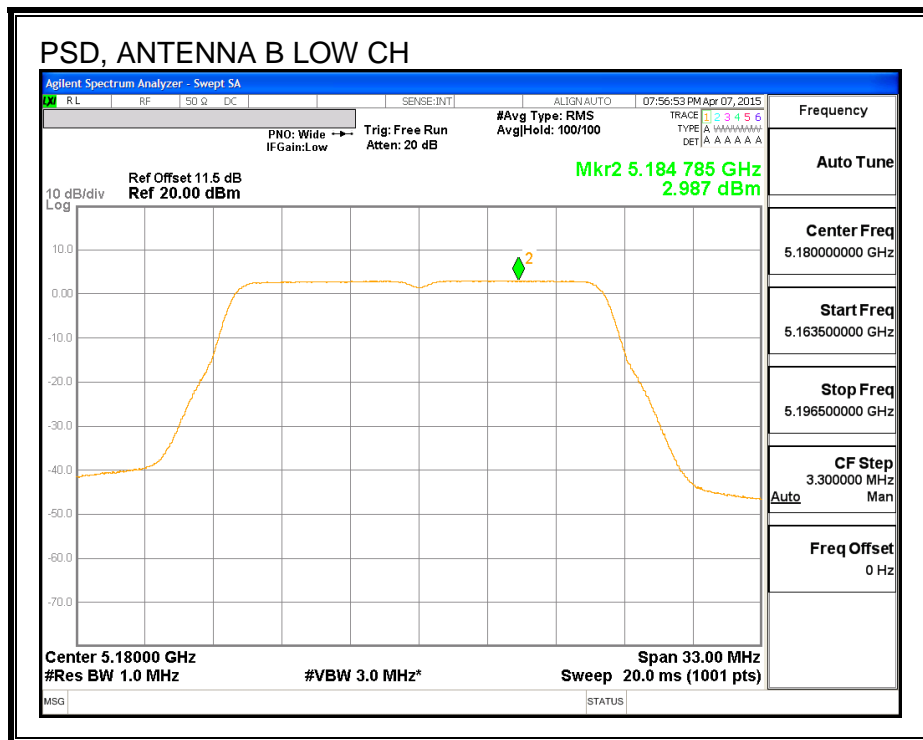

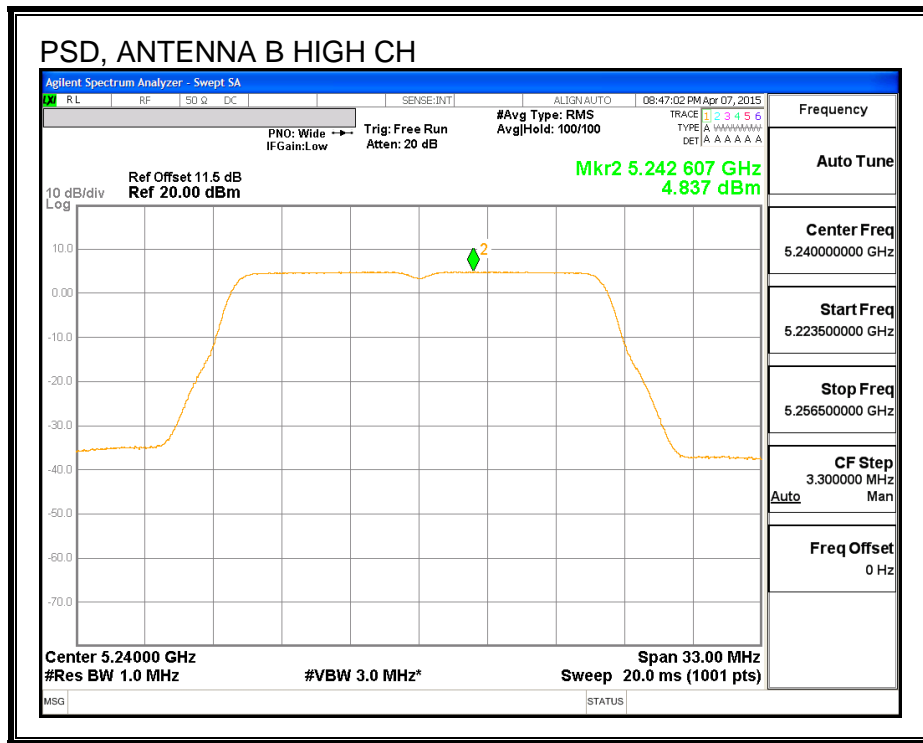

PSD, ANTENNA A

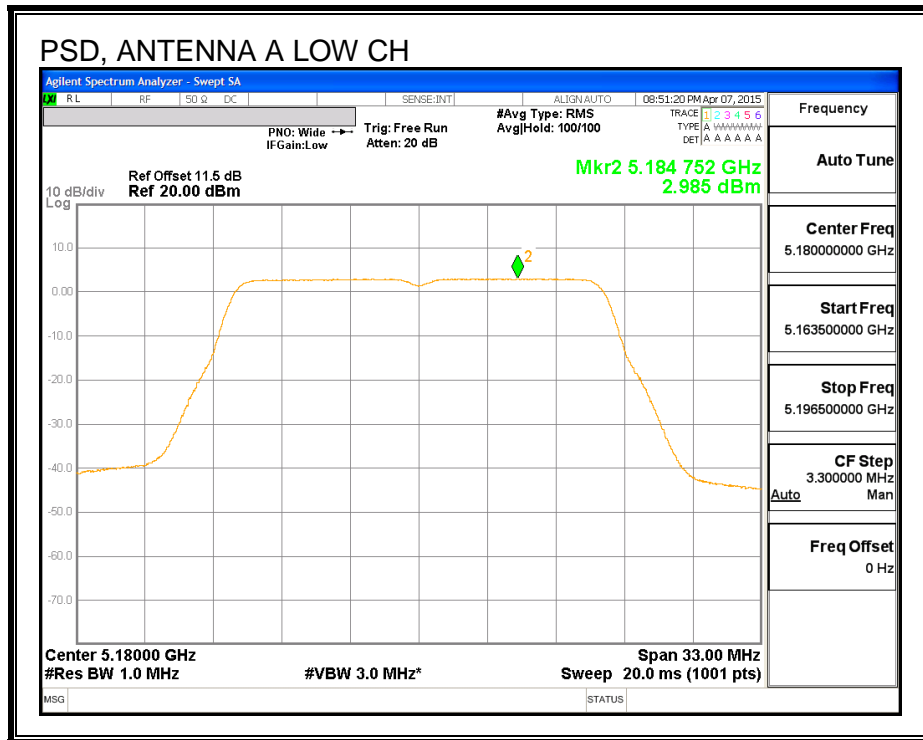

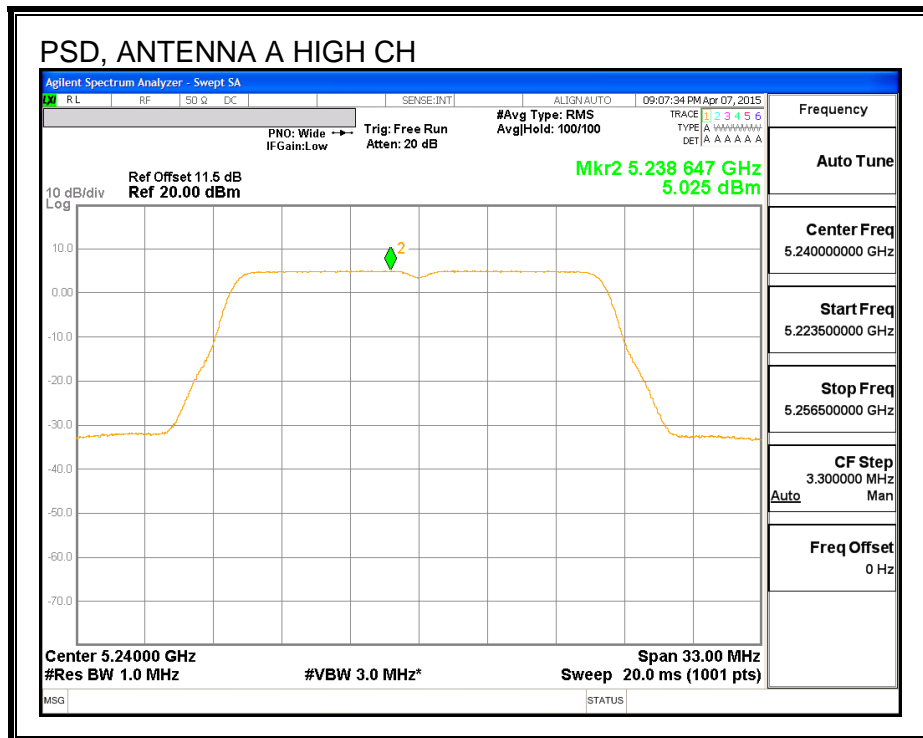
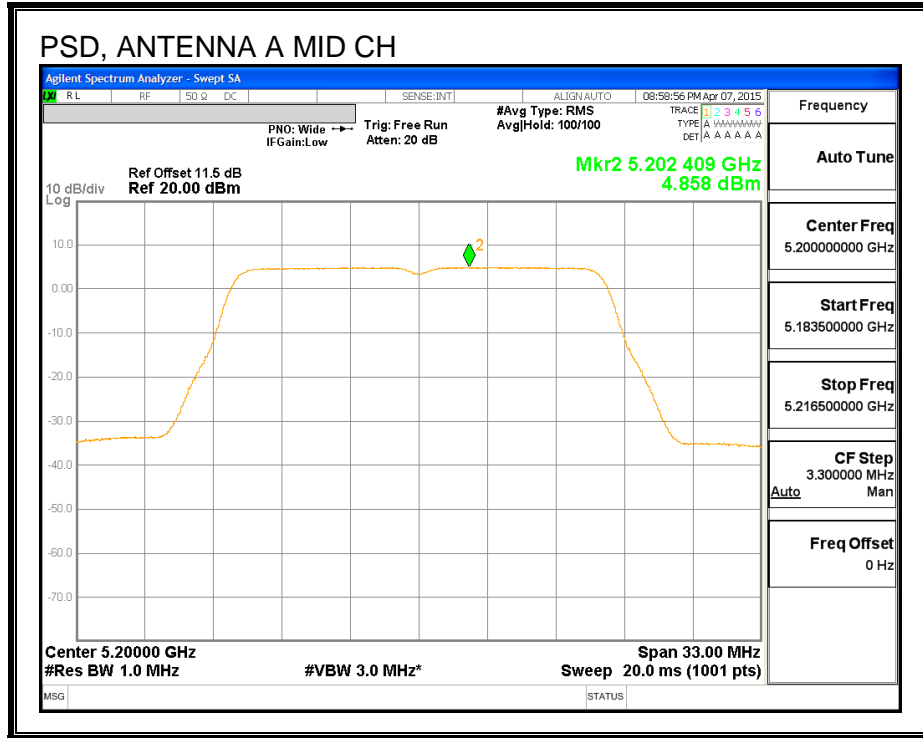

8.4. 802.11n HT40 SISO MODE IN THE 5.2 GHz BAND

8.4.1. 26 dB BANDWIDTH

LIMITS

None; for reporting purposes only.

RESULTS

Channel	Frequency (MHz)	26 dB Bandwidth (MHz)
Low	5190	40.40
High	5230	40.30

26 dB BANDWIDTH

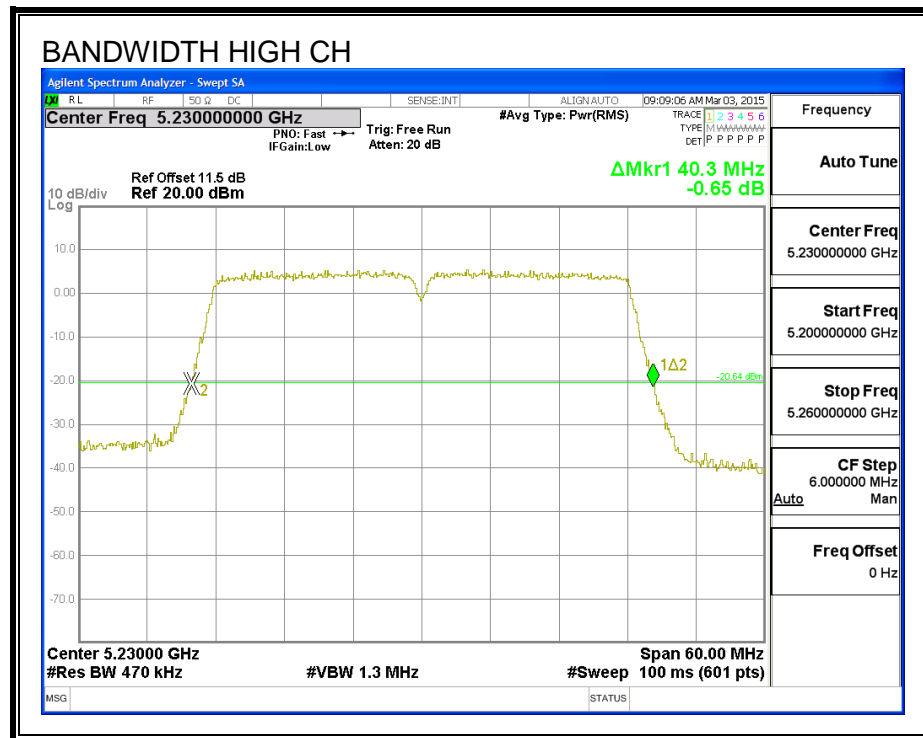
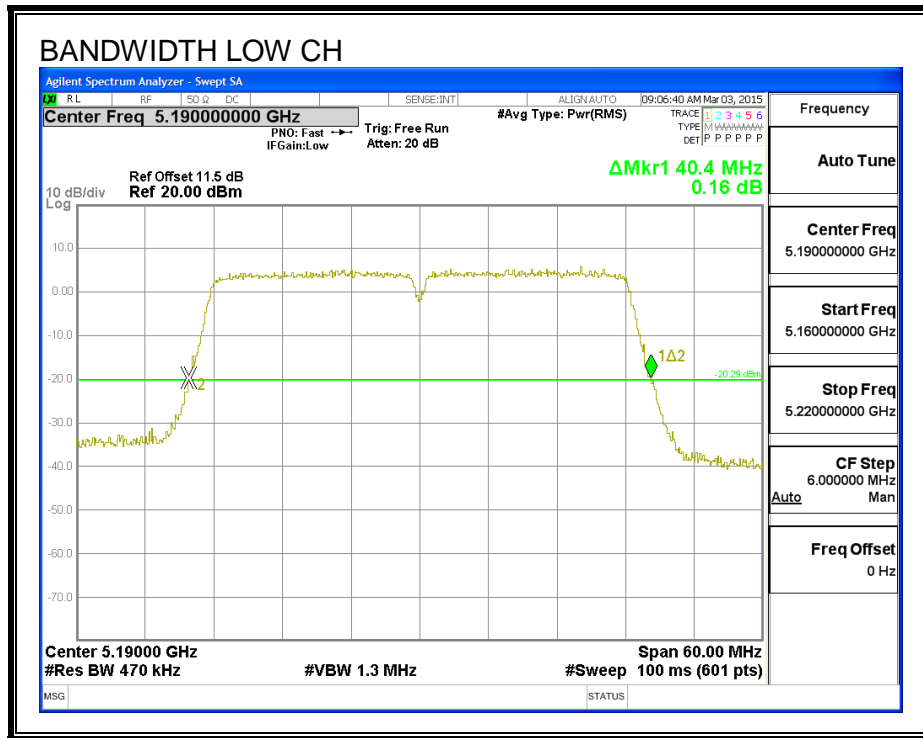

8.4.2. 99% BANDWIDTH

LIMITS

None; for reporting purposes only.

RESULTS

Channel	Frequency (MHz)	99% Bandwidth (MHz)
Low	5190	36.2360
High	5230	36.3100

99% BANDWIDTH

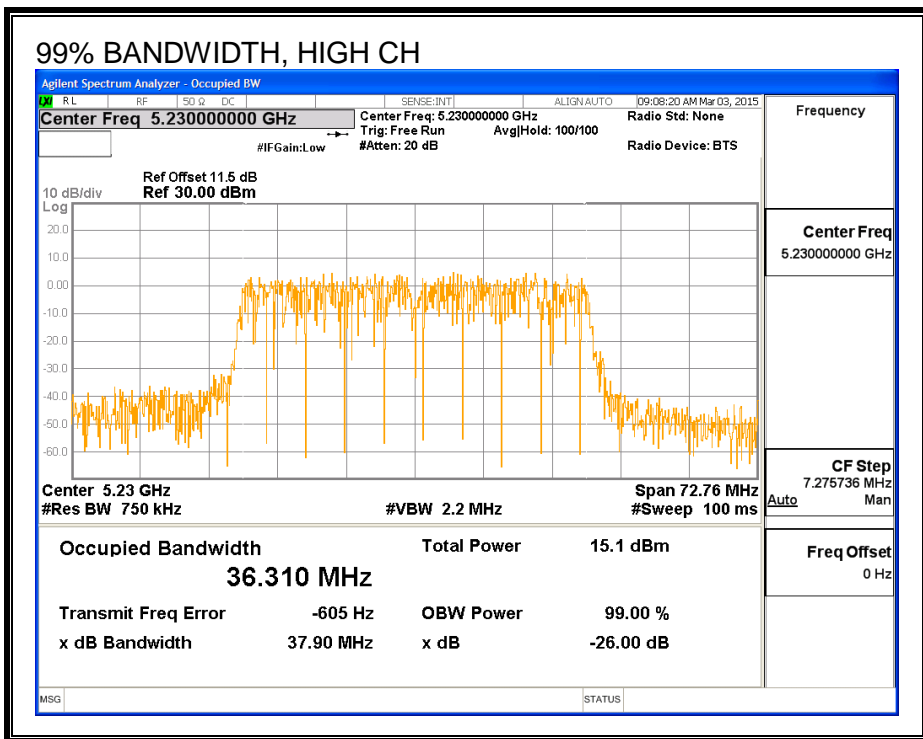
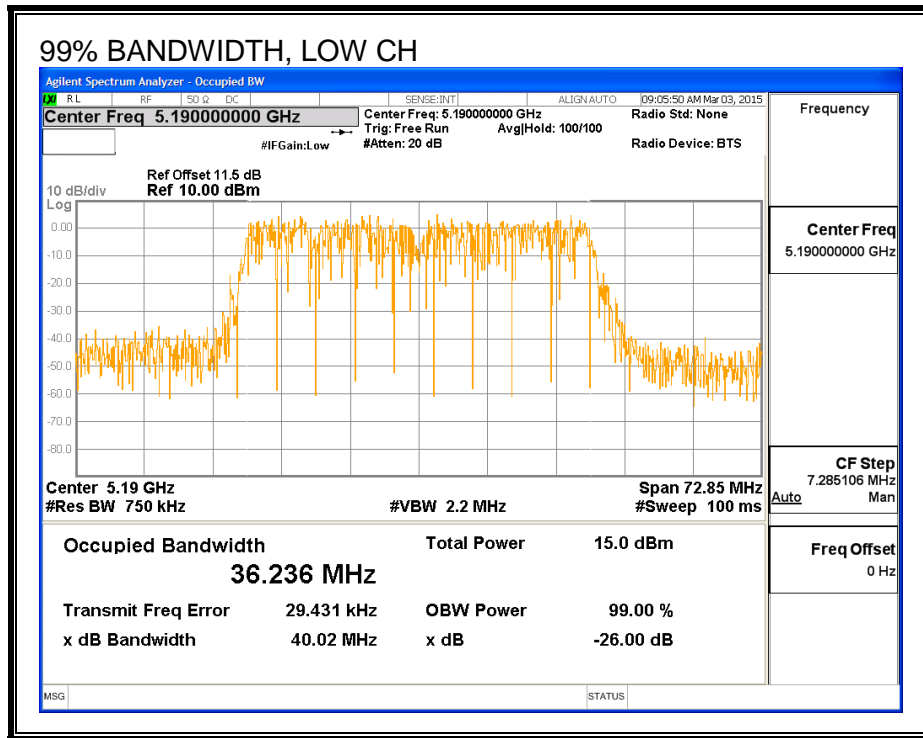

8.4.3. AVERAGE POWER

LIMITS

None; for reporting purposes only.

RESULTS

Channel	Frequency (MHz)	Power (dBm)
Low	5190	14.00
High	5230	17.94

8.4.4. OUTPUT POWER AND PSD

LIMITS

FCC §15.407 (a) (1)

(i) For an outdoor access point operating in the band 5.15-5.25 GHz, the maximum conducted output power over the frequency band of operation shall not exceed 1 W provided the maximum antenna gain does not exceed 6 dBi. In addition, the maximum power spectral density shall not exceed 17 dBm in any 1 megahertz band. If transmitting antennas of directional gain greater than 6 dBi are used, both the maximum conducted output power and the maximum power spectral density shall be reduced by the amount in dB that the directional gain of the antenna exceeds 6 dBi. The maximum e.i.r.p. at any elevation angle above 30 degrees as measured from the horizon must not exceed 125 mW (21 dBm).

(ii) For an indoor access point operating in the band 5.15-5.25 GHz, the maximum conducted output power over the frequency band of operation shall not exceed 1 W provided the maximum antenna gain does not exceed 6 dBi. In addition, the maximum power spectral density shall not exceed 17 dBm in any 1 megahertz band. If transmitting antennas of directional gain greater than 6 dBi are used, both the maximum conducted output power and the maximum power spectral density shall be reduced by the amount in dB that the directional gain of the antenna exceeds 6 dBi.

(iii) For fixed point-to-point access points operating in the band 5.15-5.25 GHz, the maximum conducted output power over the frequency band of operation shall not exceed 1 W. Fixed point-to-point U-NII devices may employ antennas with directional gain up to 23 dBi without any corresponding reduction in the maximum conducted output power or maximum power spectral density. For fixed point-to-point transmitters that employ a directional antenna gain greater than 23 dBi, a 1 dB reduction in maximum conducted output power and maximum power spectral density is required for each 1 dB of antenna gain in excess of 23 dBi. Fixed, point-to-point operations exclude the use of point-to-multipoint systems, omnidirectional applications, and multiple collocated transmitters transmitting the same information. The operator of the U-NII device, or if the equipment is professionally installed, the installer, is responsible for ensuring that systems employing high gain directional antennas are used exclusively for fixed, point-to-point operations.

(iv) For mobile and portable client devices in the 5.15-5.25 GHz band, the maximum conducted output power over the frequency band of operation shall not exceed 250 mW provided the maximum antenna gain does not exceed 6 dBi. In addition, the maximum power spectral density shall not exceed 11 dBm in any 1 megahertz band. If transmitting antennas of directional gain greater than 6 dBi are used, both the maximum conducted output power and the maximum power spectral density shall be reduced by the amount in dB that the directional gain of the antenna exceeds 6 dBi.

DIRECTIONAL ANTENNA GAIN

There is only one transmitter output therefore the directional gain is equal to the antenna gain.

RESULTS

Antenna Gain and Limits

Channel	Frequency (MHz)	Directional Gain for Power (dBi)	Directional Gain for PSD (dBi)	Power Limit (dBm)	PSD Limit (dBm)
Low	5190	3.20	3.20	24.00	11.00
High	5230	3.20	3.20	24.00	11.00

Duty Cycle CF (dB)	0.00	Included in Calculations of Corr'd Power & PSD
---------------------------	------	---

Output Power Results

Channel	Frequency (MHz)	Antenna B Meas Power (dBm)	Total Corr'd Power (dBm)	Power Limit (dBm)	Power Margin (dB)
Low	5190	14.00	14.00	24.00	-10.00
High	5230	17.94	17.94	24.00	-6.06

PSD Results

Channel	Frequency (MHz)	Antenna B Meas PSD (dBm)	Total Corr'd PSD (dBm)	PSD Limit (dBm)	PSD Margin (dB)
Low	5190	-0.87	-0.87	11.00	-11.87
High	5230	3.13	3.13	11.00	-7.87

PSD, ANTENNA B

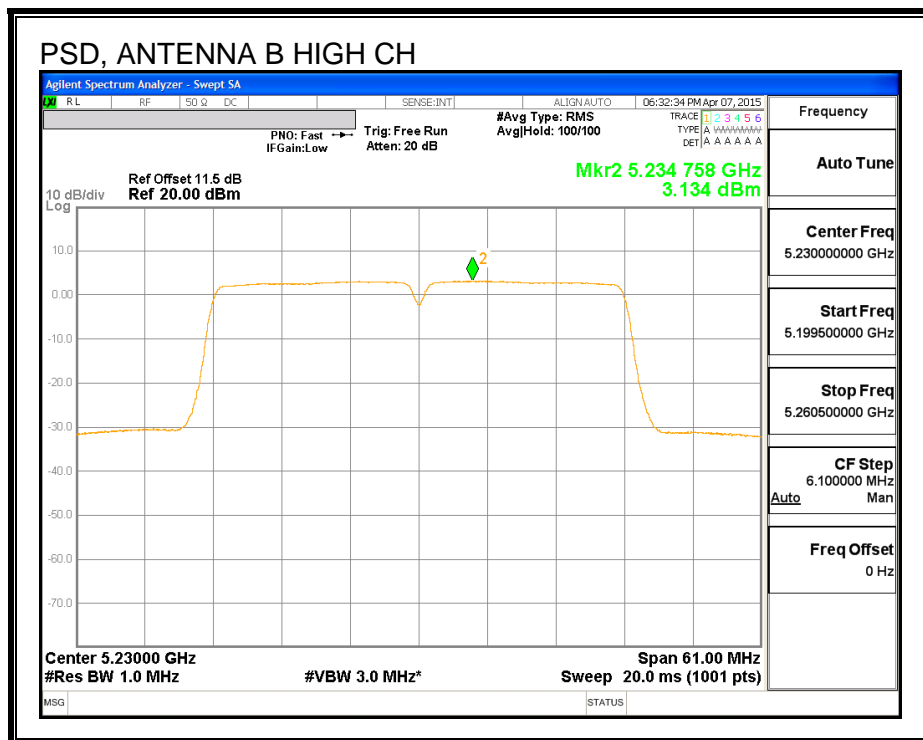
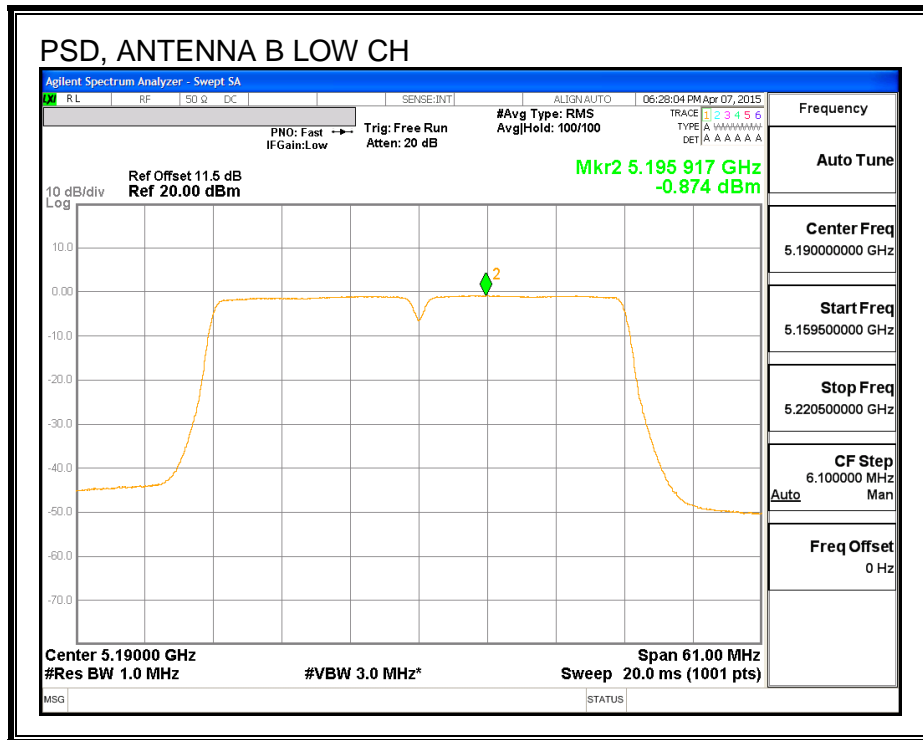

8.5. 802.11n HT40 2Tx CDD MODE IN THE 5.2 GHz BAND

8.5.1. 26 dB BANDWIDTH

LIMITS

None; for reporting purposes only.

RESULTS

Channel	Frequency (MHz)	26 dB BW Antenna B (MHz)	26 dB BW Antenna A (MHz)
Low	5190	40.30	39.90
High	5230	40.40	39.90

26 dB BANDWIDTH, ANTENNA B

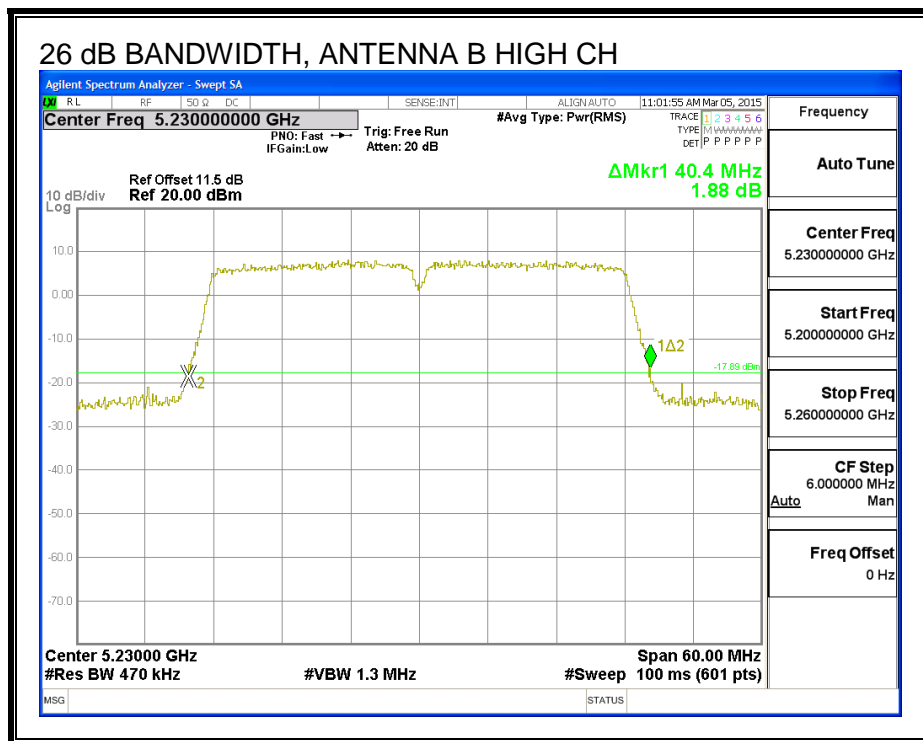
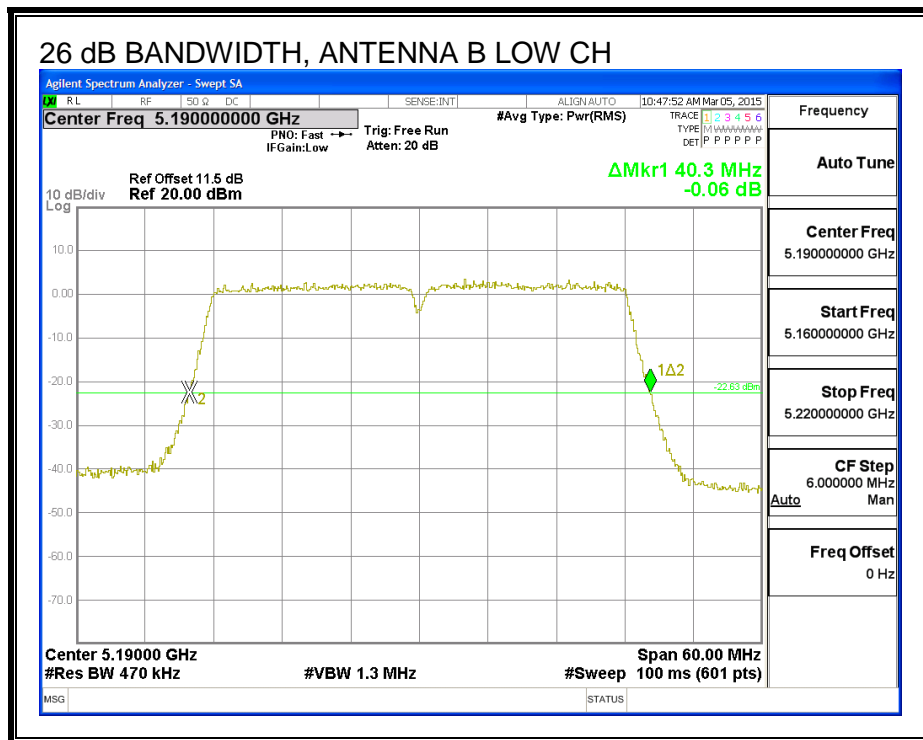

26 dB BANDWIDTH, ANTENNA A

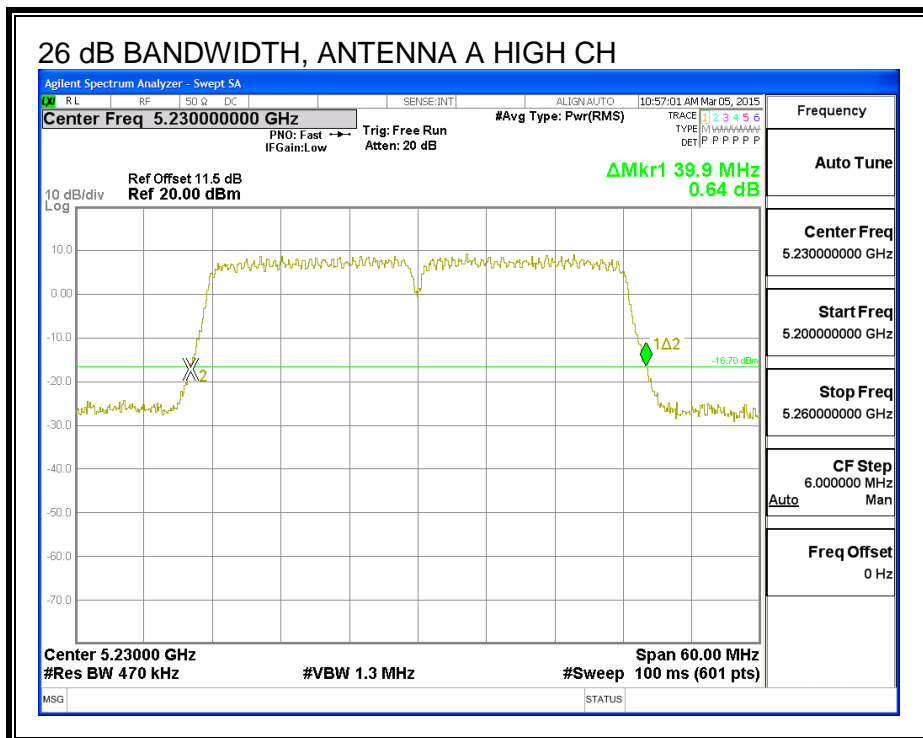
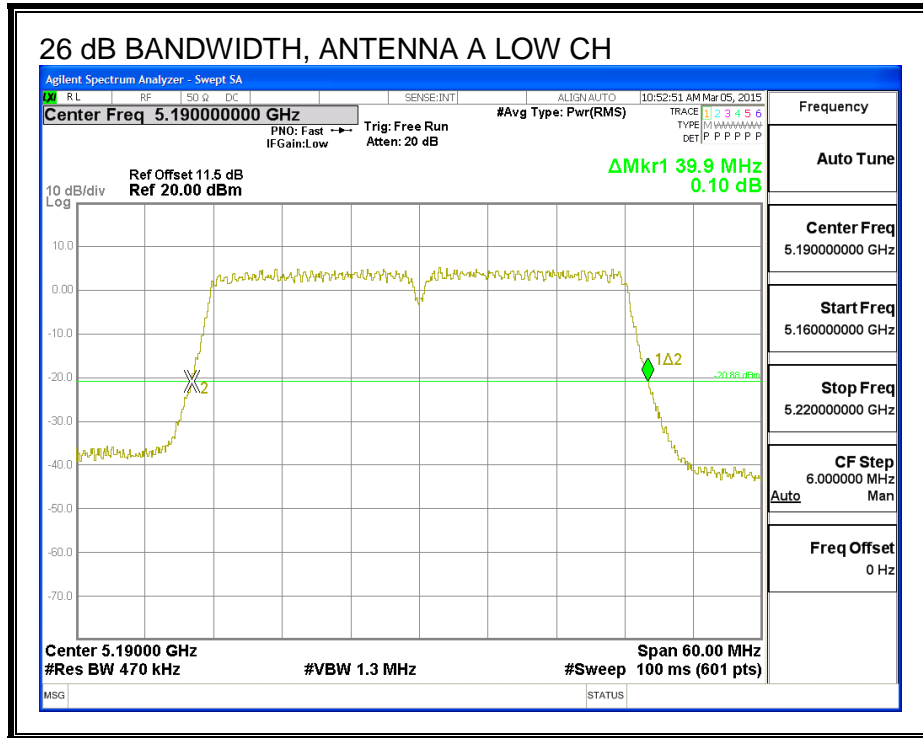

8.5.2. 99% BANDWIDTH

LIMITS

None; for reporting purposes only.

RESULTS

Channel	Frequency (MHz)	99% BW Antenna B (MHz)	99% BW Antenna A (MHz)
Low	5190	36.43	36.56
High	5230	36.44	36.57

99% BANDWIDTH, ANTENNA B

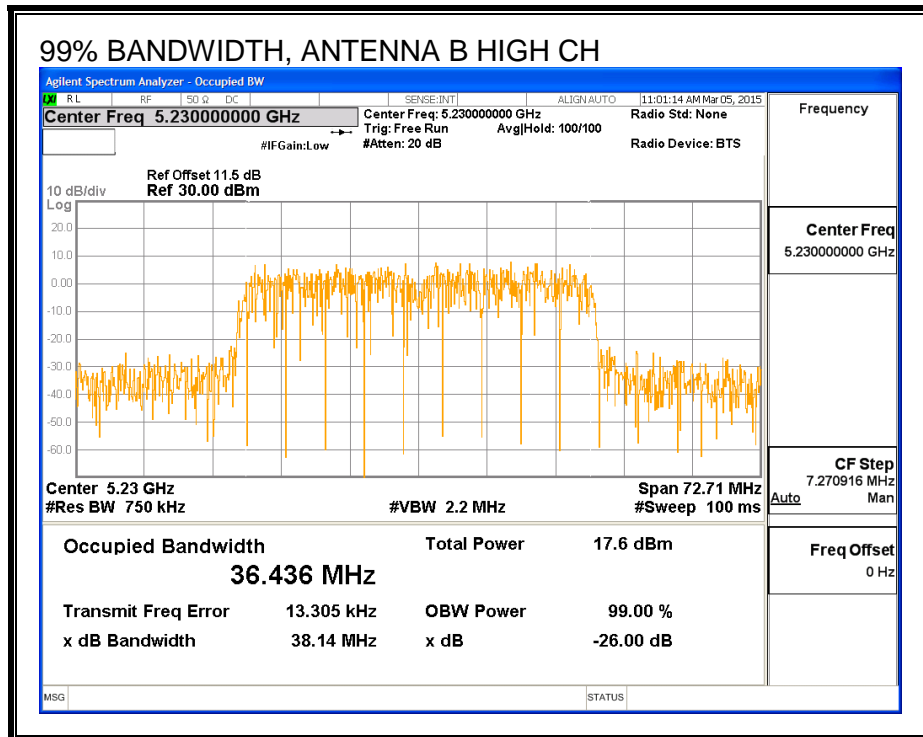
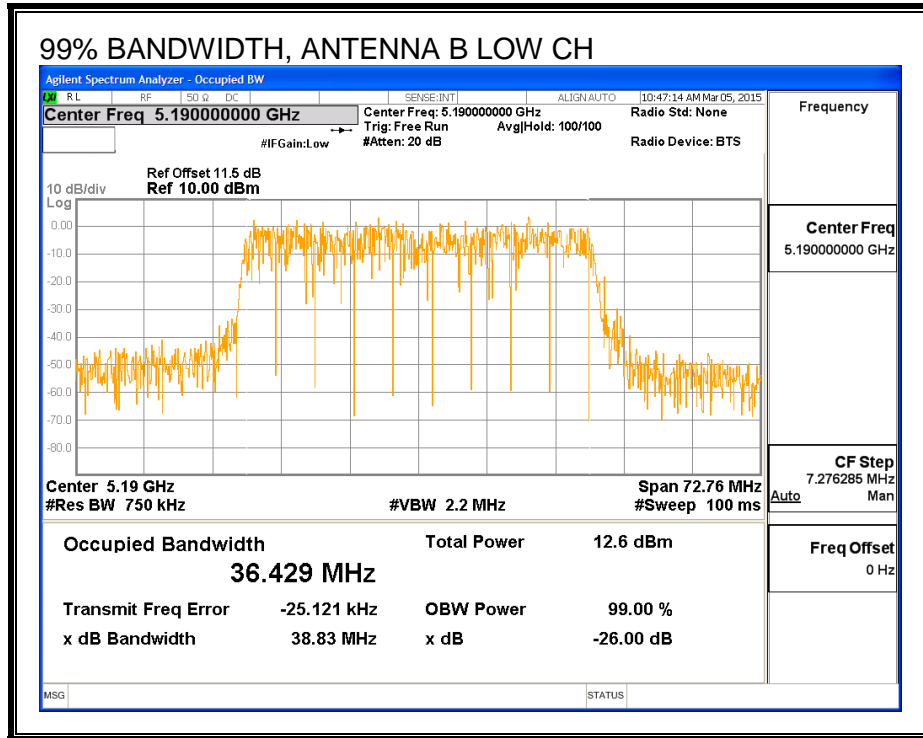

99% BANDWIDTH, ANTENNA A

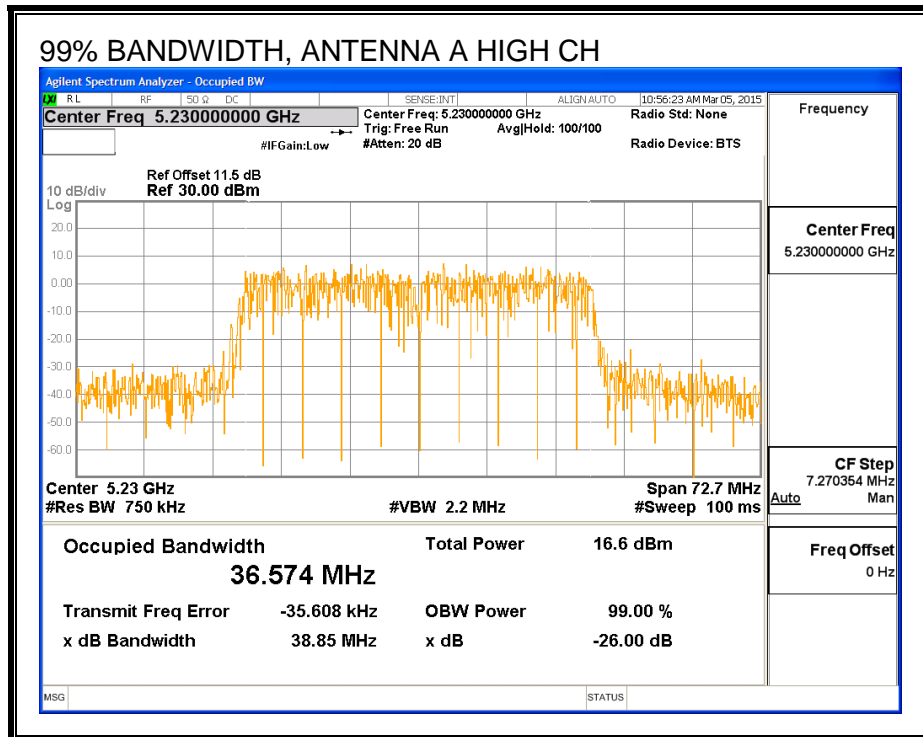
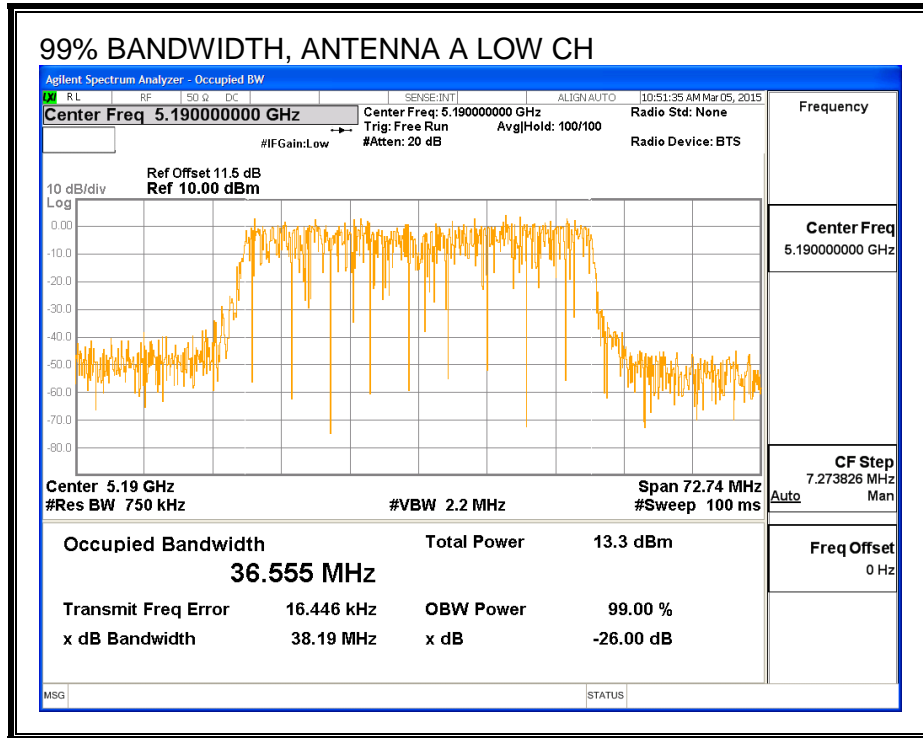

8.5.3. AVERAGE POWER

LIMITS

None; for reporting purposes only.

RESULTS

Average Power Results

Channel	Frequency (MHz)	Antenna B Power (dBm)	Antenna A Power (dBm)	Total Power (dBm)
Low	5190	12.85	12.98	15.92
High	5230	15.96	15.94	18.96

8.5.4. OUTPUT POWER AND PSD

LIMITS

FCC §15.407 (a) (1)

(i) For an outdoor access point operating in the band 5.15-5.25 GHz, the maximum conducted output power over the frequency band of operation shall not exceed 1 W provided the maximum antenna gain does not exceed 6 dBi. In addition, the maximum power spectral density shall not exceed 17 dBm in any 1 megahertz band. If transmitting antennas of directional gain greater than 6 dBi are used, both the maximum conducted output power and the maximum power spectral density shall be reduced by the amount in dB that the directional gain of the antenna exceeds 6 dBi. The maximum e.i.r.p. at any elevation angle above 30 degrees as measured from the horizon must not exceed 125 mW (21 dBm).

(ii) For an indoor access point operating in the band 5.15-5.25 GHz, the maximum conducted output power over the frequency band of operation shall not exceed 1 W provided the maximum antenna gain does not exceed 6 dBi. In addition, the maximum power spectral density shall not exceed 17 dBm in any 1 megahertz band. If transmitting antennas of directional gain greater than 6 dBi are used, both the maximum conducted output power and the maximum power spectral density shall be reduced by the amount in dB that the directional gain of the antenna exceeds 6 dBi.

(iii) For fixed point-to-point access points operating in the band 5.15-5.25 GHz, the maximum conducted output power over the frequency band of operation shall not exceed 1 W. Fixed point-to-point U-NII devices may employ antennas with directional gain up to 23 dBi without any corresponding reduction in the maximum conducted output power or maximum power spectral density. For fixed point-to-point transmitters that employ a directional antenna gain greater than 23 dBi, a 1 dB reduction in maximum conducted output power and maximum power spectral density is required for each 1 dB of antenna gain in excess of 23 dBi. Fixed, point-to-point operations exclude the use of point-to-multipoint systems, omnidirectional applications, and multiple collocated transmitters transmitting the same information. The operator of the U-NII device, or if the equipment is professionally installed, the installer, is responsible for ensuring that systems employing high gain directional antennas are used exclusively for fixed, point-to-point operations.

(iv) For mobile and portable client devices in the 5.15-5.25 GHz band, the maximum conducted output power over the frequency band of operation shall not exceed 250 mW provided the maximum antenna gain does not exceed 6 dBi. In addition, the maximum power spectral density shall not exceed 11 dBm in any 1 megahertz band. If transmitting antennas of directional gain greater than 6 dBi are used, both the maximum conducted output power and the maximum power spectral density shall be reduced by the amount in dB that the directional gain of the antenna exceeds 6 dBi.

DIRECTIONAL ANTENNA GAIN

The TX chains are uncorrelated and the antenna gain is unequal among the chains. The directional gain is:

Antenna B Antenna Gain (dBi)	Antenna A Antenna Gain (dBi)	Uncorrelated Chains Directional Gain (dBi)
3.20	2.10	2.68

The TX chains are correlated and the antenna gain is unequal among the chains. The directional gain is:

Antenna B Antenna Gain (dBi)	Antenna A Antenna Gain (dBi)	Correlated Chains Directional Gain (dBi)
3.20	2.10	5.68

RESULTS

Antenna Gain and Limits

Channel	Frequency (MHz)	Directional Gain for Power (dBi)	Directional Gain for PSD (dBi)	Power Limit (dBm)	PSD Limit (dBm)
Low	5190	2.68	5.68	24.00	11.00
High	5230	2.68	5.68	24.00	11.00

Duty Cycle CF (dB)	0.00	Included in Calculations of Corr'd Power & PSD
---------------------------	------	---

Output Power Results

Channel	Frequency (MHz)	Antenna B Meas Power (dBm)	Antenna A Meas Power (dBm)	Total Corr'd Power (dBm)	Power Limit (dBm)	Power Margin (dB)
Low	5190	12.85	12.98	15.92	24.00	-8.08
High	5230	15.96	15.94	18.96	24.00	-5.04

PSD Results

Channel	Frequency (MHz)	Antenna B Meas PSD (dBm)	Antenna A Meas PSD (dBm)	Total Corr'd PSD (dBm)	PSD Limit (dBm)	PSD Margin (dB)
Low	5190	-1.95	-1.90	1.09	11.00	-9.91
High	5230	1.18	1.14	4.17	11.00	-6.83

PSD, ANTENNA B

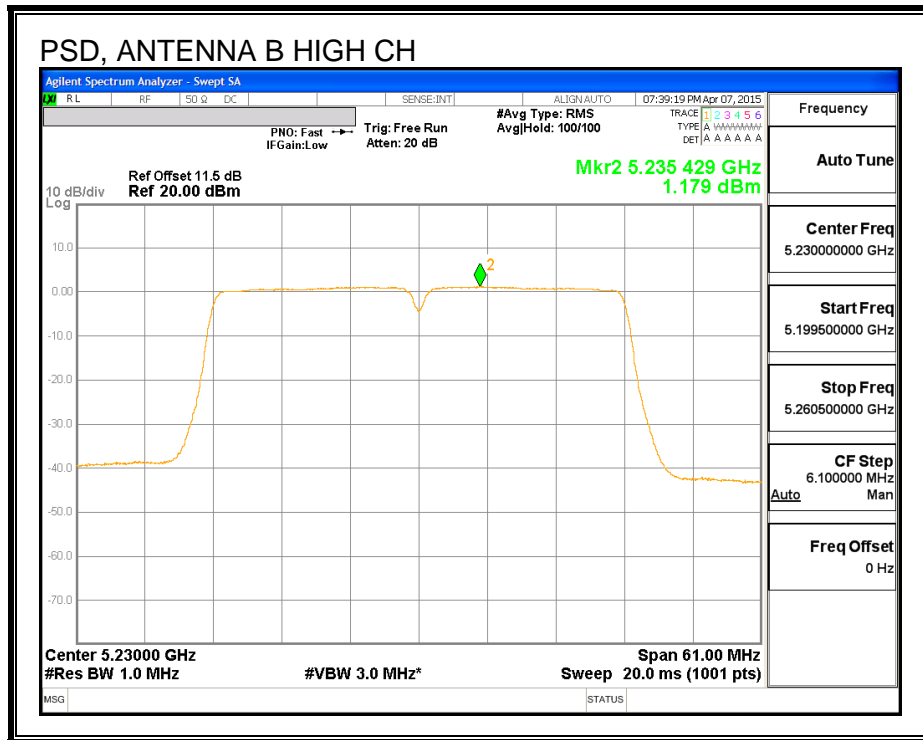
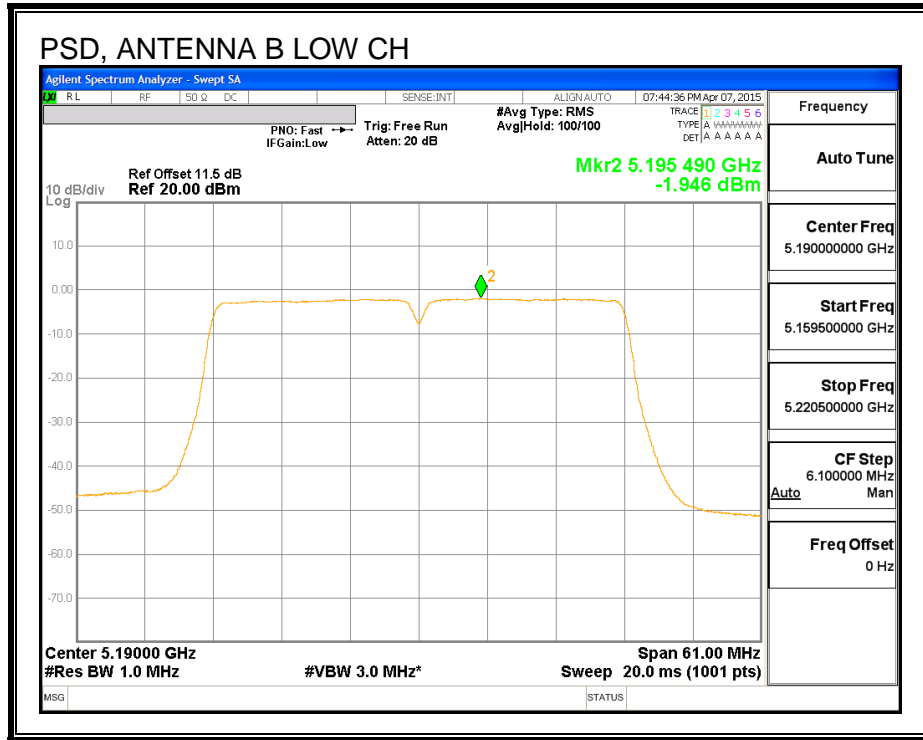

PSD, ANTENNA A

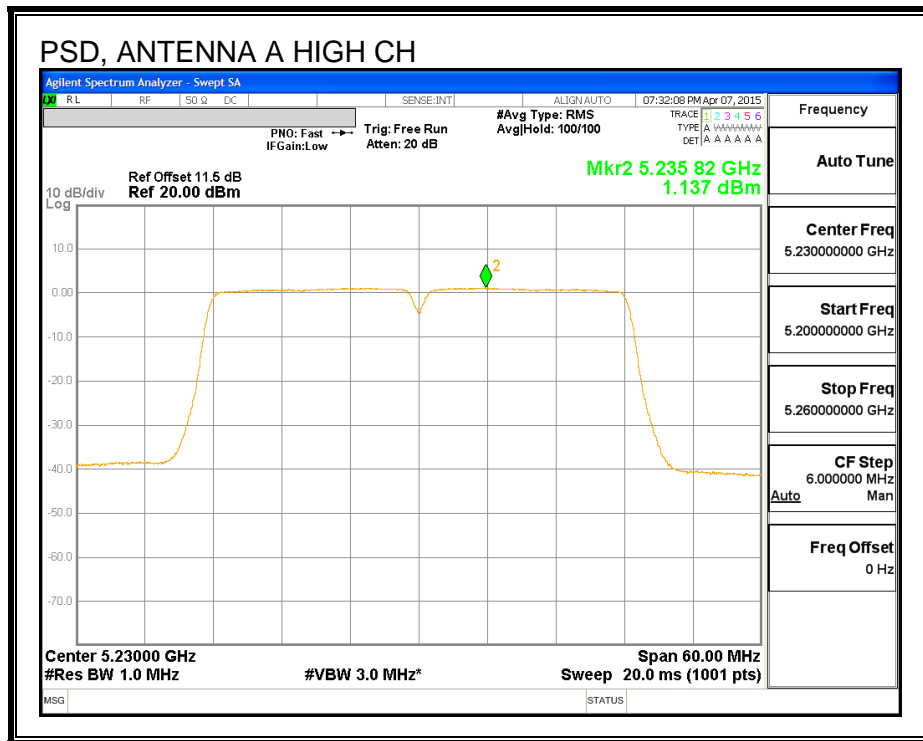
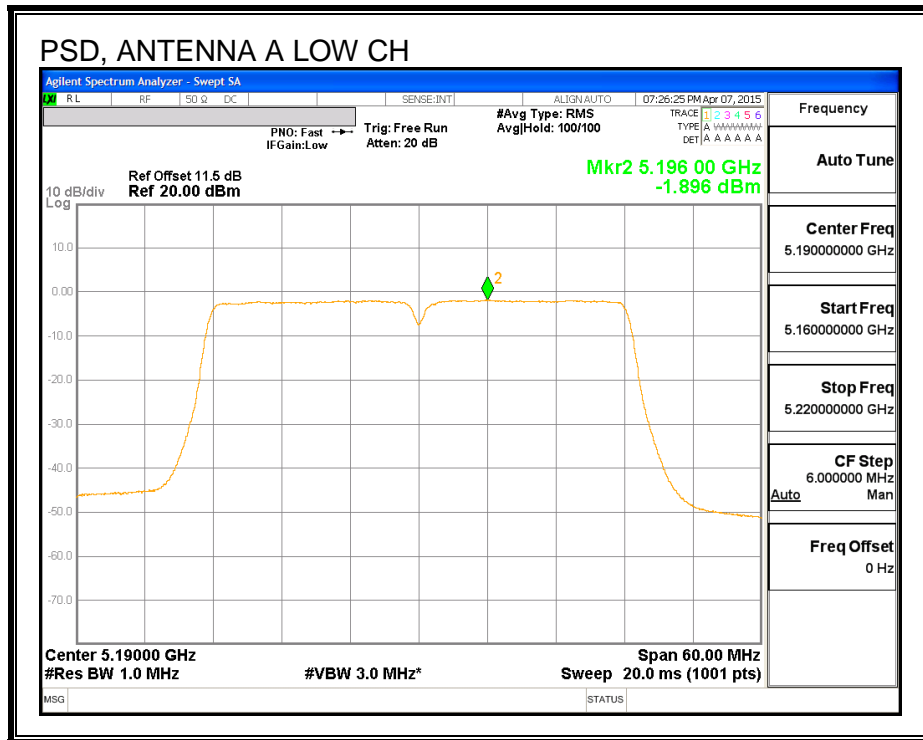

8.6. 802.11n HT40 2Tx STBC MODE IN THE 5.2 GHz BAND

8.6.1. 26 dB BANDWIDTH

LIMITS

None; for reporting purposes only.

RESULTS

Channel	Frequency (MHz)	26 dB BW Antenna B (MHz)	26 dB BW Antenna A (MHz)
Low	5190	40.07	39.78
High	5230	40.02	39.66

26 dB BANDWIDTH, ANTENNA B

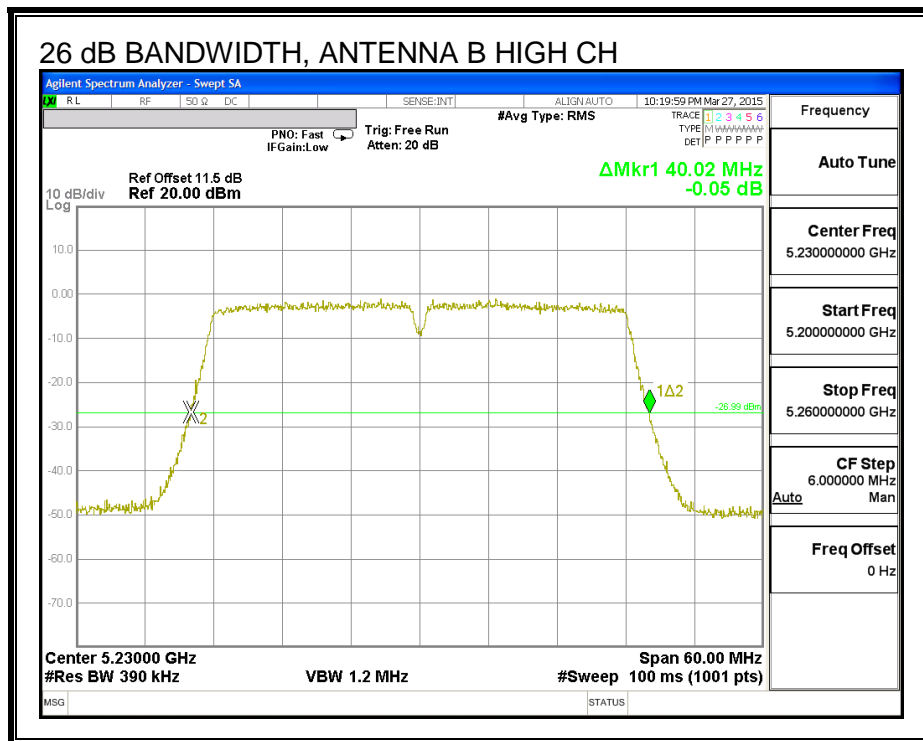
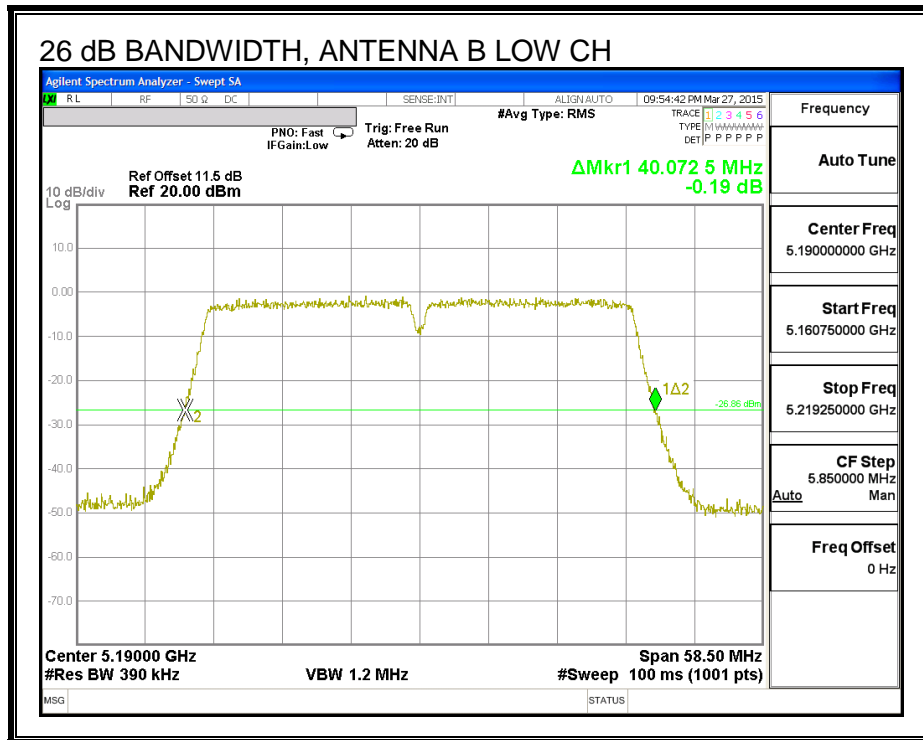

26 dB BANDWIDTH, ANTENNA A

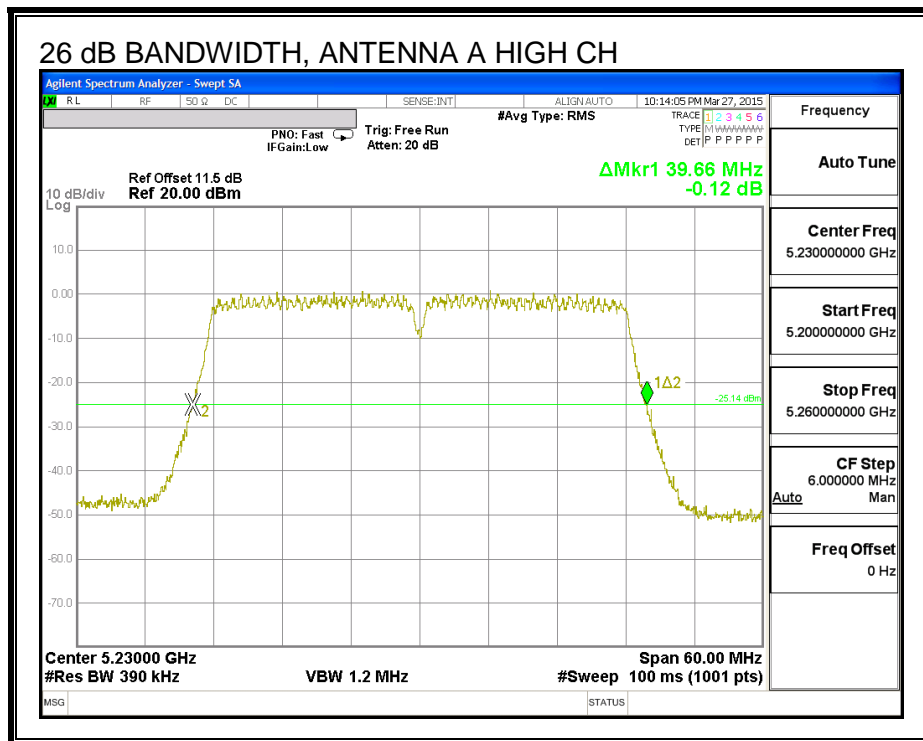
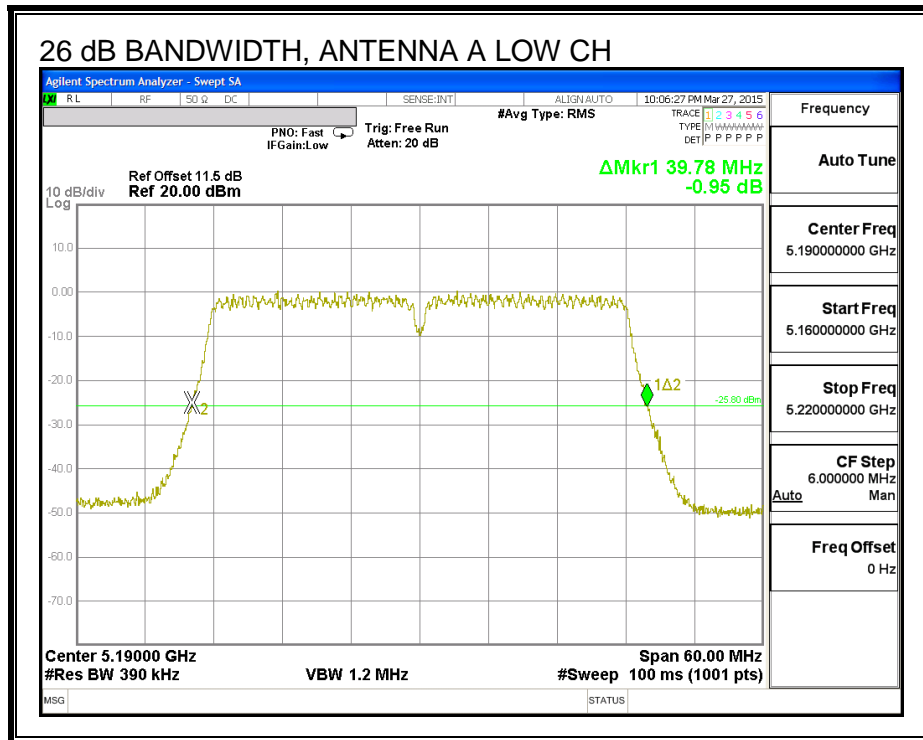

8.6.2. 99% BANDWIDTH

LIMITS

None; for reporting purposes only.

RESULTS

Channel	Frequency (MHz)	99% BW Antenna B (MHz)	99% BW Antenna A (MHz)
Low	5190	36.414	36.325
High	5230	36.506	36.341

99% BANDWIDTH, ANTENNA B

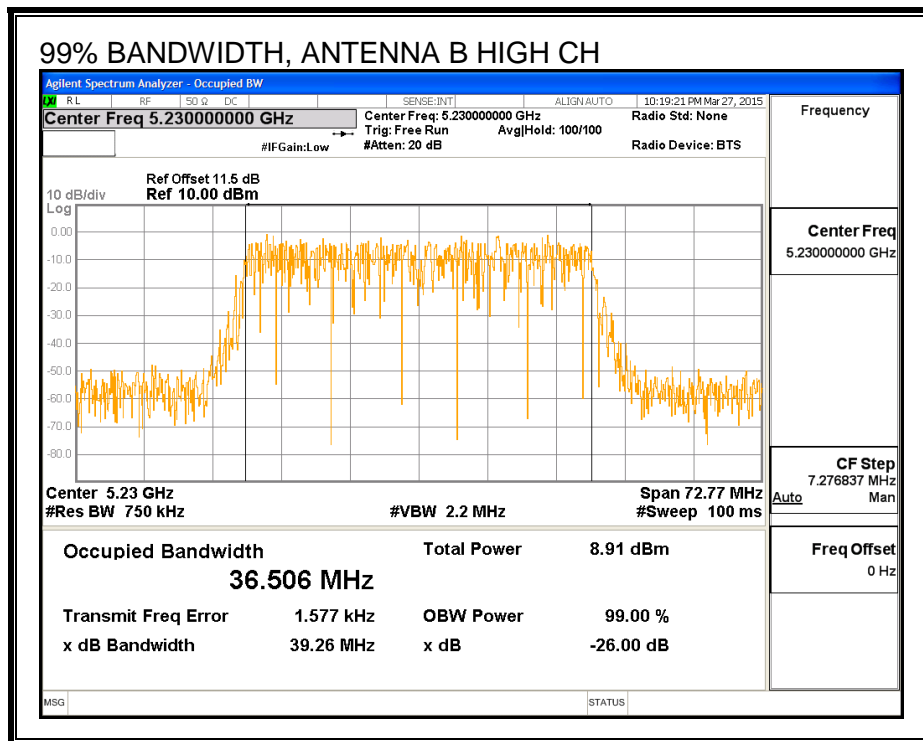
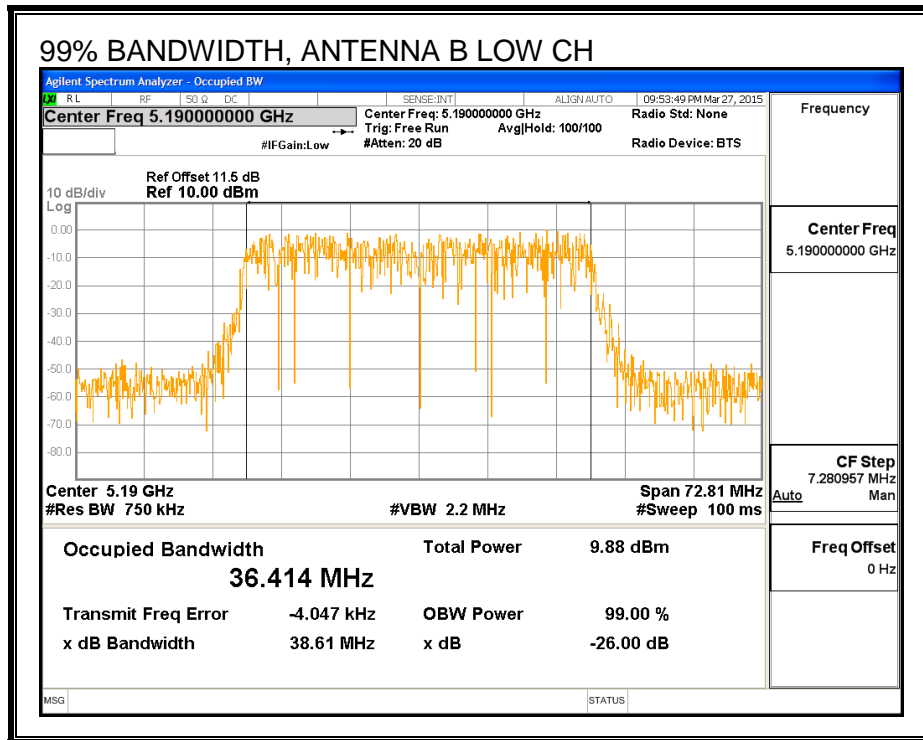

99% BANDWIDTH, ANTENNA A

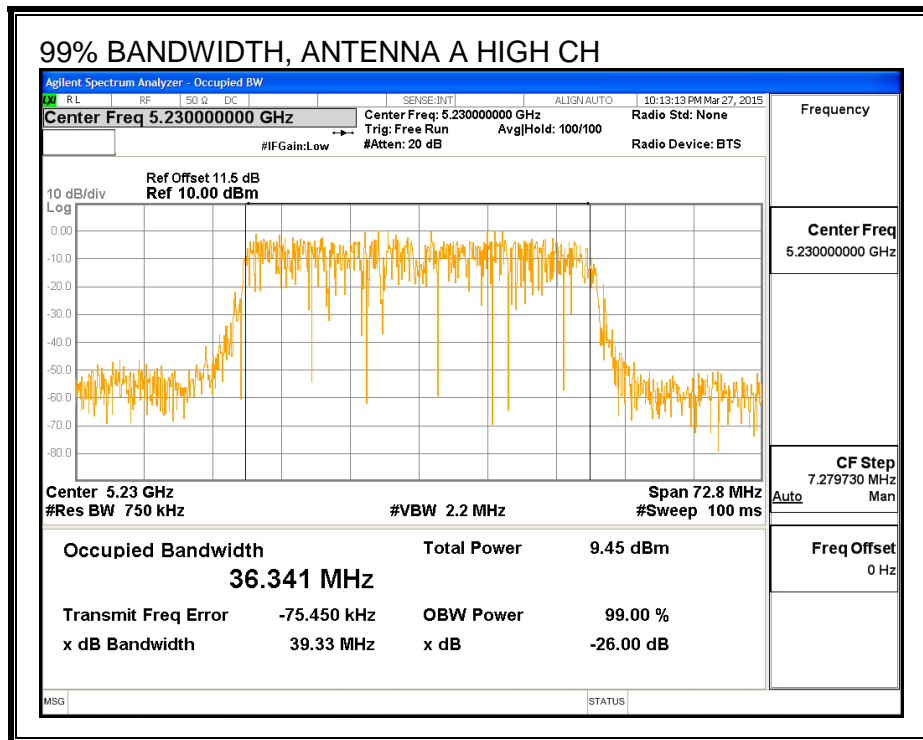
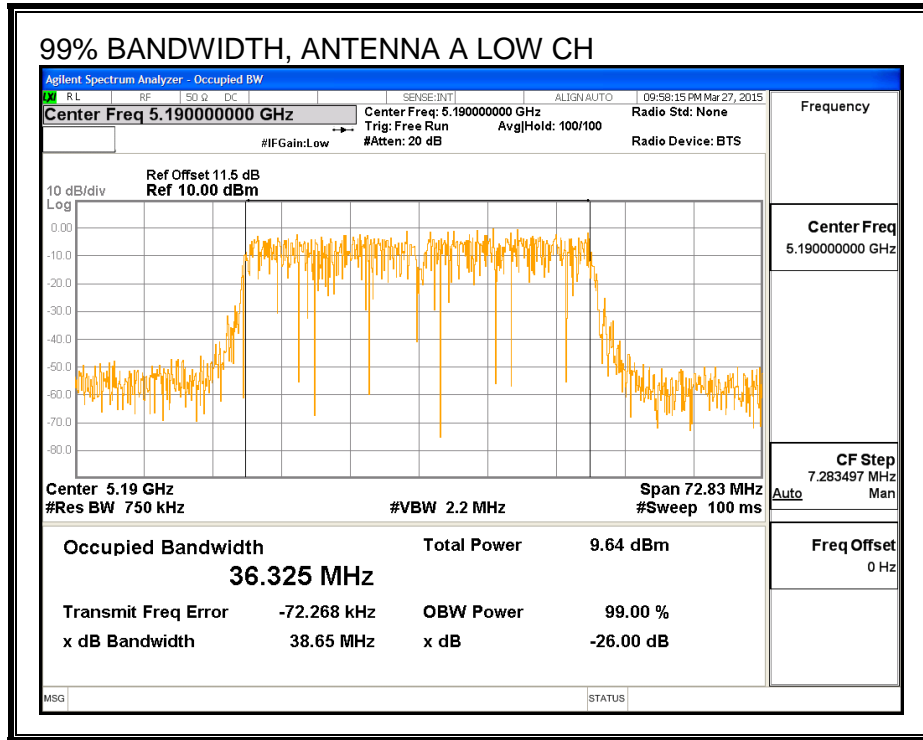

8.6.3. AVERAGE POWER

LIMITS

None; for reporting purposes only.

RESULTS

Average Power Results

Channel	Frequency (MHz)	Antenna B Power (dBm)	Antenna A Power (dBm)	Total Power (dBm)
Low	5190	12.83	12.95	15.90
High	5230	17.88	16.83	20.40

8.6.4. OUTPUT POWER AND PSD

LIMITS

FCC §15.407 (a) (1)

(i) For an outdoor access point operating in the band 5.15-5.25 GHz, the maximum conducted output power over the frequency band of operation shall not exceed 1 W provided the maximum antenna gain does not exceed 6 dBi. In addition, the maximum power spectral density shall not exceed 17 dBm in any 1 megahertz band. If transmitting antennas of directional gain greater than 6 dBi are used, both the maximum conducted output power and the maximum power spectral density shall be reduced by the amount in dB that the directional gain of the antenna exceeds 6 dBi. The maximum e.i.r.p. at any elevation angle above 30 degrees as measured from the horizon must not exceed 125 mW (21 dBm).

(ii) For an indoor access point operating in the band 5.15-5.25 GHz, the maximum conducted output power over the frequency band of operation shall not exceed 1 W provided the maximum antenna gain does not exceed 6 dBi. In addition, the maximum power spectral density shall not exceed 17 dBm in any 1 megahertz band. If transmitting antennas of directional gain greater than 6 dBi are used, both the maximum conducted output power and the maximum power spectral density shall be reduced by the amount in dB that the directional gain of the antenna exceeds 6 dBi.

(iii) For fixed point-to-point access points operating in the band 5.15-5.25 GHz, the maximum conducted output power over the frequency band of operation shall not exceed 1 W. Fixed point-to-point U-NII devices may employ antennas with directional gain up to 23 dBi without any corresponding reduction in the maximum conducted output power or maximum power spectral density. For fixed point-to-point transmitters that employ a directional antenna gain greater than 23 dBi, a 1 dB reduction in maximum conducted output power and maximum power spectral density is required for each 1 dB of antenna gain in excess of 23 dBi. Fixed, point-to-point operations exclude the use of point-to-multipoint systems, omnidirectional applications, and multiple collocated transmitters transmitting the same information. The operator of the U-NII device, or if the equipment is professionally installed, the installer, is responsible for ensuring that systems employing high gain directional antennas are used exclusively for fixed, point-to-point operations.

(iv) For mobile and portable client devices in the 5.15-5.25 GHz band, the maximum conducted output power over the frequency band of operation shall not exceed 250 mW provided the maximum antenna gain does not exceed 6 dBi. In addition, the maximum power spectral density shall not exceed 11 dBm in any 1 megahertz band. If transmitting antennas of directional gain greater than 6 dBi are used, both the maximum conducted output power and the maximum power spectral density shall be reduced by the amount in dB that the directional gain of the antenna exceeds 6 dBi.

DIRECTIONAL ANTENNA GAIN

The TX chains are uncorrelated and the antenna gain is unequal among the chains. The directional gain is:

Antenna B Antenna Gain (dBi)	Antenna A Antenna Gain (dBi)	Uncorrelated Chains Directional Gain (dBi)
3.20	2.10	2.68

The TX chains are correlated and the antenna gain is unequal among the chains. The directional gain is:

Antenna B Antenna Gain (dBi)	Antenna A Antenna Gain (dBi)	Correlated Chains Directional Gain (dBi)
3.20	2.10	5.68

RESULTS

Antenna Gain and Limits

Channel	Frequency (MHz)	Directional Gain for Power (dBi)	Directional Gain for PSD (dBi)	Power Limit (dBm)	PSD Limit (dBm)
Low	5190	2.68	2.68	24.00	11.00
High	5230	2.68	2.68	24.00	11.00

Duty Cycle CF (dB)	0.00	Included in Calculations of Corr'd Power & PSD
---------------------------	------	---

Output Power Results

Channel	Frequency (MHz)	Antenna B Meas Power (dBm)	Antenna A Meas Power (dBm)	Total Corr'd Power (dBm)	Power Limit (dBm)	Power Margin (dB)
Low	5190	12.89	12.87	15.89	24.00	-8.11
High	5230	17.88	16.83	20.40	24.00	-3.60

PSD Results

Channel	Frequency (MHz)	Antenna B Meas PSD (dBm)	Antenna A Meas PSD (dBm)	Total Corr'd PSD (dBm)	PSD Limit (dBm)	PSD Margin (dB)
Low	5190	-2.03	-1.94	1.02	11.00	-9.98
High	5230	3.06	1.93	5.54	11.00	-5.46

PSD, ANTENNA B

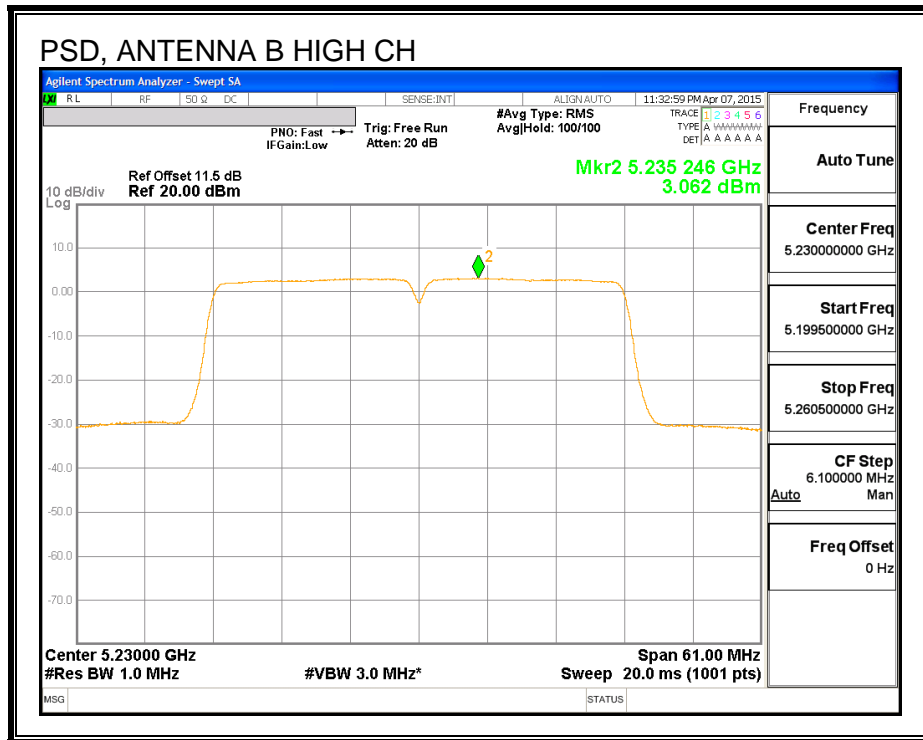
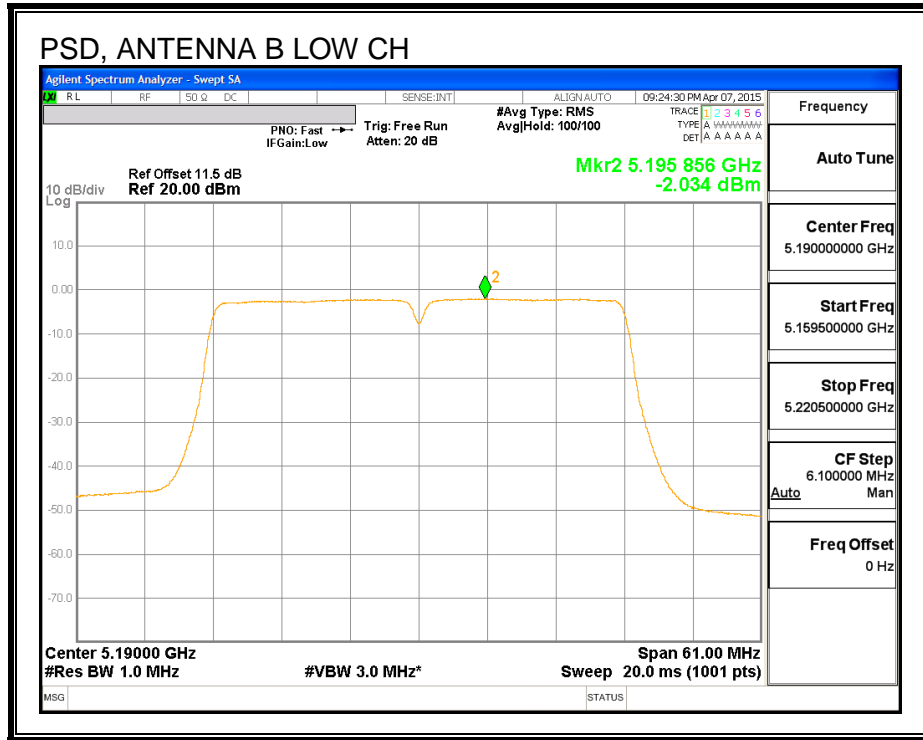

PSD, ANTENNA A

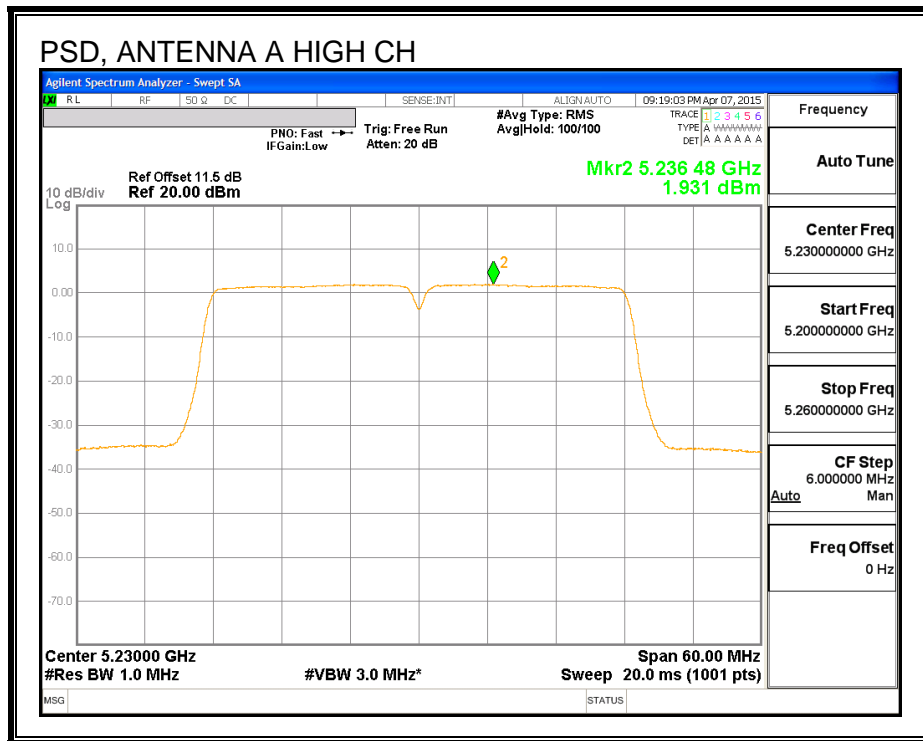
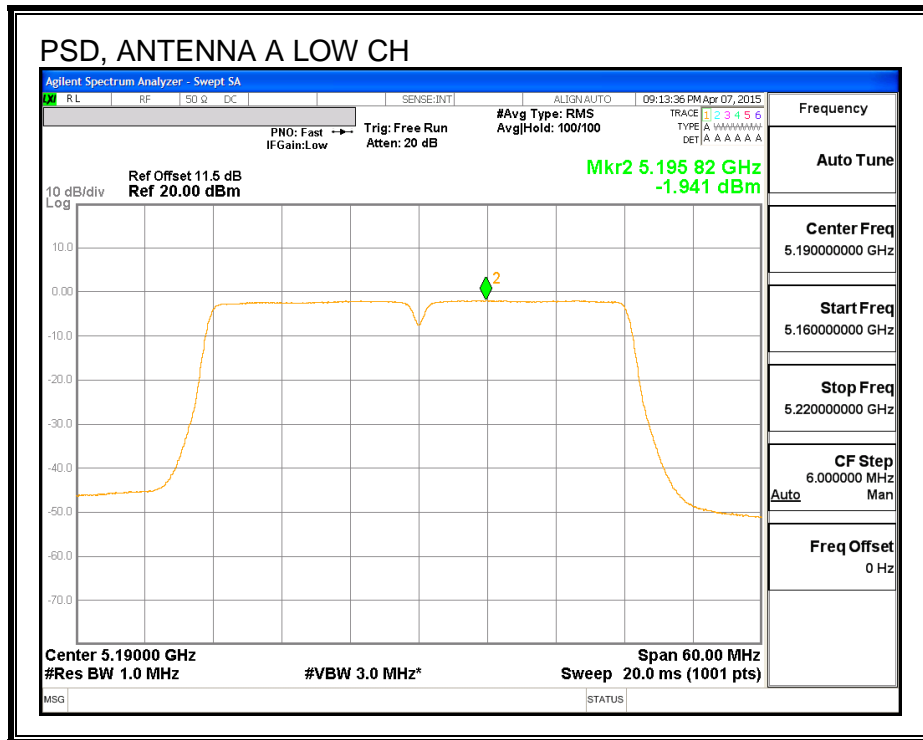

8.7. 802.11ac VHT80 SISO MODE IN THE 5.2 GHz BAND

8.7.1. 26 dB BANDWIDTH

LIMITS

None; for reporting purposes only.

RESULTS

Channel	Frequency (MHz)	26 dB Bandwidth (MHz)
Mid	5210	82.20

26 dB BANDWIDTH

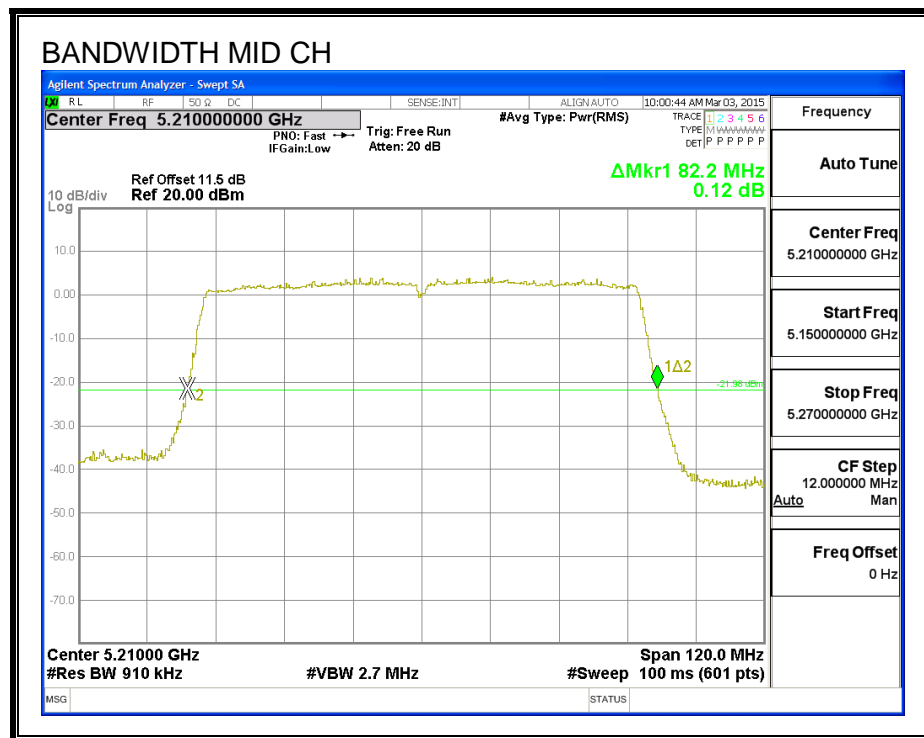

8.7.2. 99% BANDWIDTH

LIMITS

None; for reporting purposes only.

RESULTS

Channel	Frequency (MHz)	99% Bandwidth (MHz)
Mid	5210	75.6860

99% BANDWIDTH

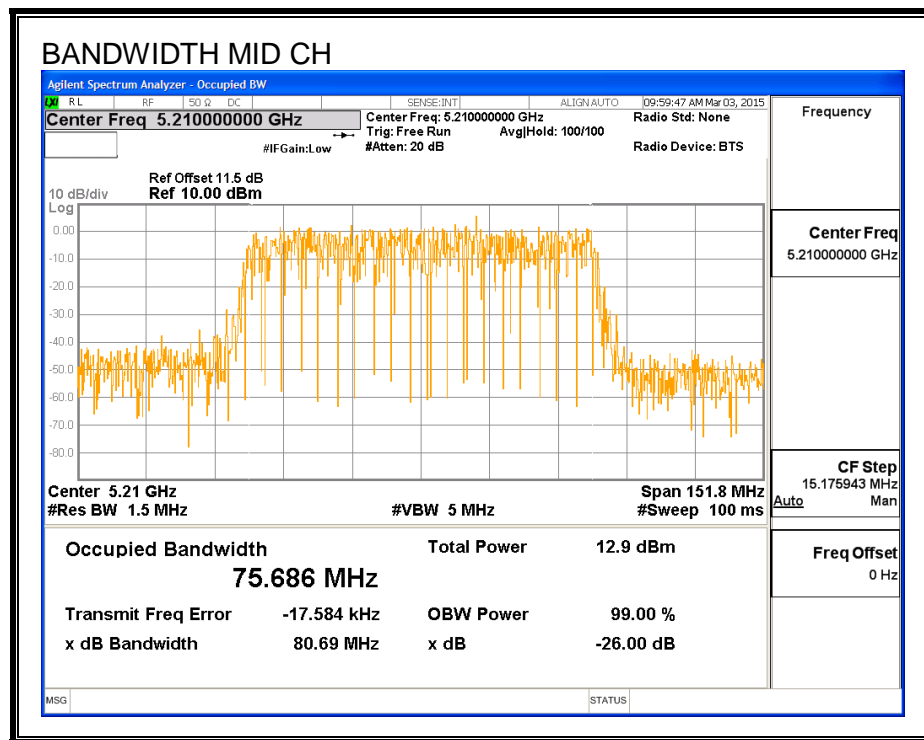

8.7.3. AVERAGE POWER

LIMITS

None; for reporting purposes only.

RESULTS

Channel	Frequency (MHz)	Power (dBm)
Mid	5210	12.80

8.7.4. OUTPUT POWER AND PSD

LIMITS

FCC §15.407 (a) (1)

(i) For an outdoor access point operating in the band 5.15-5.25 GHz, the maximum conducted output power over the frequency band of operation shall not exceed 1 W provided the maximum antenna gain does not exceed 6 dBi. In addition, the maximum power spectral density shall not exceed 17 dBm in any 1 megahertz band. If transmitting antennas of directional gain greater than 6 dBi are used, both the maximum conducted output power and the maximum power spectral density shall be reduced by the amount in dB that the directional gain of the antenna exceeds 6 dBi. The maximum e.i.r.p. at any elevation angle above 30 degrees as measured from the horizon must not exceed 125 mW (21 dBm).

(ii) For an indoor access point operating in the band 5.15-5.25 GHz, the maximum conducted output power over the frequency band of operation shall not exceed 1 W provided the maximum antenna gain does not exceed 6 dBi. In addition, the maximum power spectral density shall not exceed 17 dBm in any 1 megahertz band. If transmitting antennas of directional gain greater than 6 dBi are used, both the maximum conducted output power and the maximum power spectral density shall be reduced by the amount in dB that the directional gain of the antenna exceeds 6 dBi.

(iii) For fixed point-to-point access points operating in the band 5.15-5.25 GHz, the maximum conducted output power over the frequency band of operation shall not exceed 1 W. Fixed point-to-point U-NII devices may employ antennas with directional gain up to 23 dBi without any corresponding reduction in the maximum conducted output power or maximum power spectral density. For fixed point-to-point transmitters that employ a directional antenna gain greater than 23 dBi, a 1 dB reduction in maximum conducted output power and maximum power spectral density is required for each 1 dB of antenna gain in excess of 23 dBi. Fixed, point-to-point operations exclude the use of point-to-multipoint systems, omnidirectional applications, and multiple collocated transmitters transmitting the same information. The operator of the U-NII device, or if the equipment is professionally installed, the installer, is responsible for ensuring that systems employing high gain directional antennas are used exclusively for fixed, point-to-point operations.

(iv) For mobile and portable client devices in the 5.15-5.25 GHz band, the maximum conducted output power over the frequency band of operation shall not exceed 250 mW provided the maximum antenna gain does not exceed 6 dBi. In addition, the maximum power spectral density shall not exceed 11 dBm in any 1 megahertz band. If transmitting antennas of directional gain greater than 6 dBi are used, both the maximum conducted output power and the maximum power spectral density shall be reduced by the amount in dB that the directional gain of the antenna exceeds 6 dBi.

DIRECTIONAL ANTENNA GAIN

There is only one transmitter output therefore the directional gain is equal to the antenna gain.

RESULTS

Antenna Gain and Limits

Channel	Frequency (MHz)	Directional Gain for Power (dBi)	Directional Gain for PSD (dBi)	Power Limit (dBm)	PSD Limit (dBm)
Mid	5210	3.20	3.20	24.00	11.00

Duty Cycle CF (dB)	0.21	Included in Calculations of Corr'd Power & PSD
---------------------------	------	---

Output Power Results

Channel	Frequency (MHz)	Antenna B Meas Power (dBm)	Total Corr'd Power (dBm)	Power Limit (dBm)	Power Margin (dB)
Mid	5210	12.80	13.01	24.00	-11.00

PSD Results

Channel	Frequency (MHz)	Antenna B Meas PSD (dBm)	Total Corr'd PSD (dBm)	PSD Limit (dBm)	PSD Margin (dB)
Mid	5210	-4.22	-4.01	11.00	-15.01

PSD, ANTENNA B

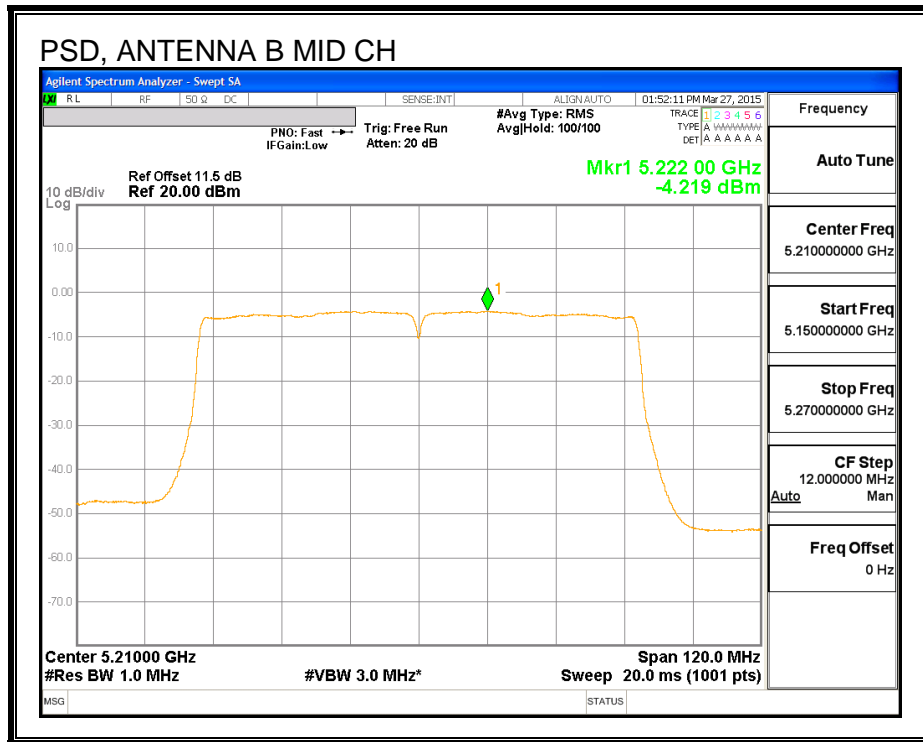

8.8. 802.11ac VHT80 2Tx CDD MODE IN THE 5.2 GHz BAND

8.8.1. 26 dB BANDWIDTH

LIMITS

None; for reporting purposes only.

RESULTS

Channel	Frequency (MHz)	26 dB BW Antenna B (MHz)	26 dB BW Antenna A (MHz)
Mid	5210	82.20	81.60

26 dB BANDWIDTH, ANTENNA B

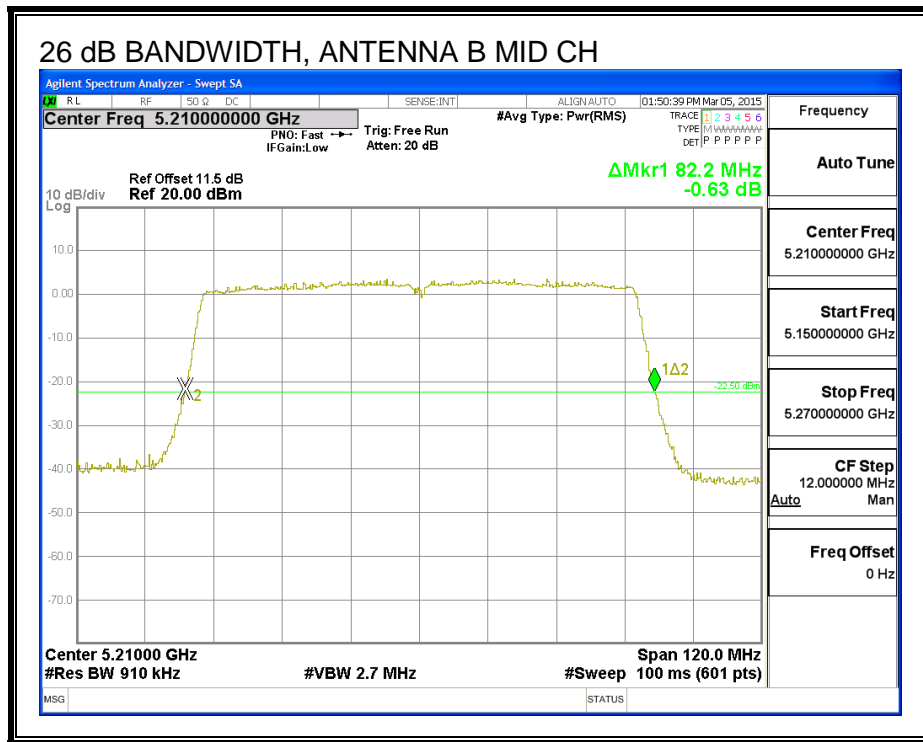

26 dB BANDWIDTH, ANTENNA A

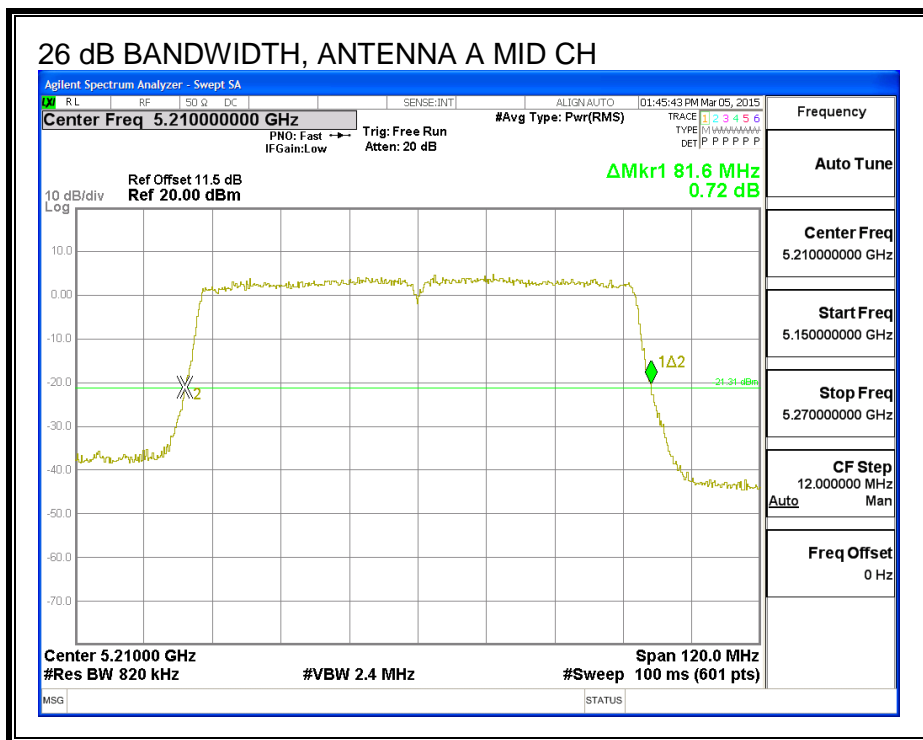

8.8.2. 99% BANDWIDTH

LIMITS

None; for reporting purposes only.

RESULTS

Channel	Frequency (MHz)	99% BW Antenna B (MHz)	99% BW Antenna A (MHz)
Mid	5210	75.3600	76.2500

99% BANDWIDTH, ANTENNA B

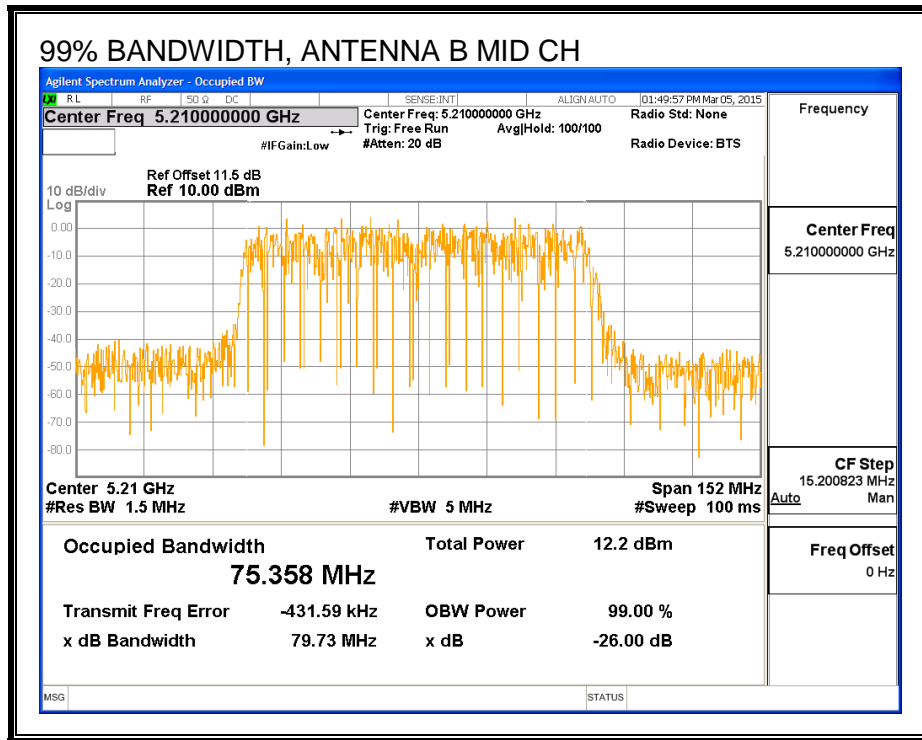

99% BANDWIDTH, ANTENNA A

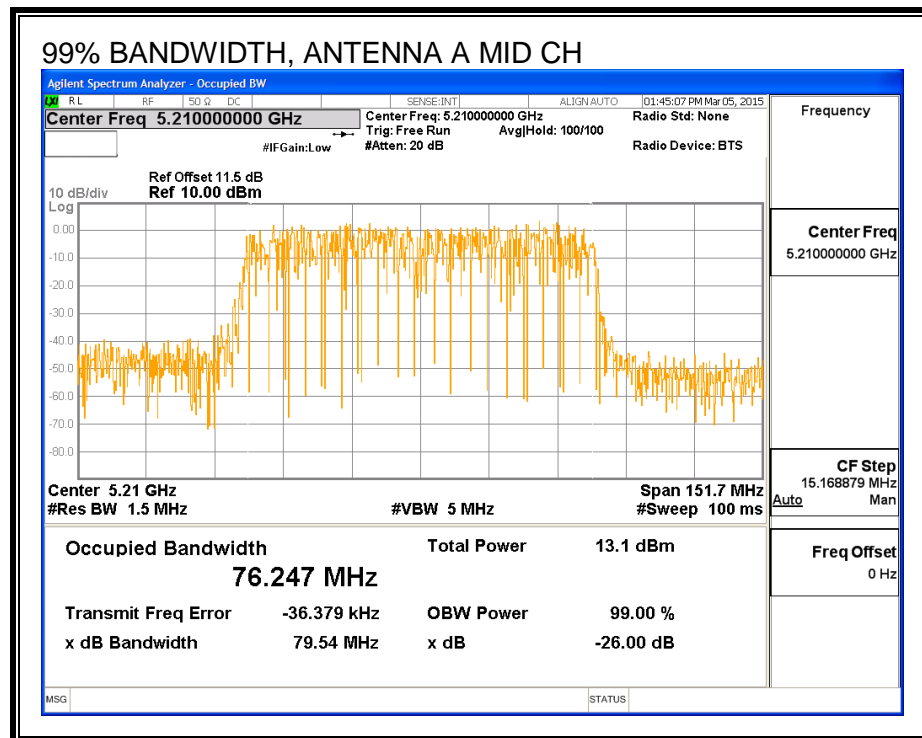

8.8.3. AVERAGE POWER

LIMITS

None; for reporting purposes only.

RESULTS

Average Power Results

Channel	Frequency (MHz)	Antenna B Power (dBm)	Antenna A Power (dBm)	Total Power (dBm)
Mid	5210	12.47	12.23	15.36

8.8.4. OUTPUT POWER AND PSD

LIMITS

FCC §15.407 (a) (1)

(i) For an outdoor access point operating in the band 5.15-5.25 GHz, the maximum conducted output power over the frequency band of operation shall not exceed 1 W provided the maximum antenna gain does not exceed 6 dBi. In addition, the maximum power spectral density shall not exceed 17 dBm in any 1 megahertz band. If transmitting antennas of directional gain greater than 6 dBi are used, both the maximum conducted output power and the maximum power spectral density shall be reduced by the amount in dB that the directional gain of the antenna exceeds 6 dBi. The maximum e.i.r.p. at any elevation angle above 30 degrees as measured from the horizon must not exceed 125 mW (21 dBm).

(ii) For an indoor access point operating in the band 5.15-5.25 GHz, the maximum conducted output power over the frequency band of operation shall not exceed 1 W provided the maximum antenna gain does not exceed 6 dBi. In addition, the maximum power spectral density shall not exceed 17 dBm in any 1 megahertz band. If transmitting antennas of directional gain greater than 6 dBi are used, both the maximum conducted output power and the maximum power spectral density shall be reduced by the amount in dB that the directional gain of the antenna exceeds 6 dBi.

(iii) For fixed point-to-point access points operating in the band 5.15-5.25 GHz, the maximum conducted output power over the frequency band of operation shall not exceed 1 W. Fixed point-to-point U-NII devices may employ antennas with directional gain up to 23 dBi without any corresponding reduction in the maximum conducted output power or maximum power spectral density. For fixed point-to-point transmitters that employ a directional antenna gain greater than 23 dBi, a 1 dB reduction in maximum conducted output power and maximum power spectral density is required for each 1 dB of antenna gain in excess of 23 dBi. Fixed, point-to-point operations exclude the use of point-to-multipoint systems, omnidirectional applications, and multiple collocated transmitters transmitting the same information. The operator of the U-NII device, or if the equipment is professionally installed, the installer, is responsible for ensuring that systems employing high gain directional antennas are used exclusively for fixed, point-to-point operations.

(iv) For mobile and portable client devices in the 5.15-5.25 GHz band, the maximum conducted output power over the frequency band of operation shall not exceed 250 mW provided the maximum antenna gain does not exceed 6 dBi. In addition, the maximum power spectral density shall not exceed 11 dBm in any 1 megahertz band. If transmitting antennas of directional gain greater than 6 dBi are used, both the maximum conducted output power and the maximum power spectral density shall be reduced by the amount in dB that the directional gain of the antenna exceeds 6 dBi.

DIRECTIONAL ANTENNA GAIN

The TX chains are uncorrelated and the antenna gain is unequal among the chains. The directional gain is:

Antenna B	Antenna A	Uncorrelated Chains
Antenna Gain (dBi)	Antenna Gain (dBi)	Directional Gain (dBi)
3.20	2.10	2.68

The TX chains are correlated and the antenna gain is unequal among the chains. The directional gain is:

Antenna B	Antenna A	Correlated Chains
Antenna Gain (dBi)	Antenna Gain (dBi)	Directional Gain (dBi)
3.20	2.10	5.68

RESULTS

Antenna Gain and Limits

Channel	Frequency (MHz)	Directional Gain for Power (dBi)	Directional Gain for PSD (dBi)	Power Limit (dBm)	PSD Limit (dBm)
Mid	5210	2.68	5.68	24.00	11.00

Duty Cycle CF (dB)	0.21	Included in Calculations of Corr'd Power & PSD
---------------------------	------	---

Output Power Results

Channel	Frequency (MHz)	Antenna B Meas Power (dBm)	Antenna A Meas Power (dBm)	Total Corr'd Power (dBm)	Power Limit (dBm)	Power Margin (dB)
Mid	5210	12.47	12.23	15.57	24.00	-8.43

PSD Results

Channel	Frequency (MHz)	Antenna B Meas PSD (dBm)	Antenna A Meas PSD (dBm)	Total Corr'd PSD (dBm)	PSD Limit (dBm)	PSD Margin (dB)
Mid	5210	-4.52	-4.67	-1.37	11.00	-12.37

PSD, ANTENNA B

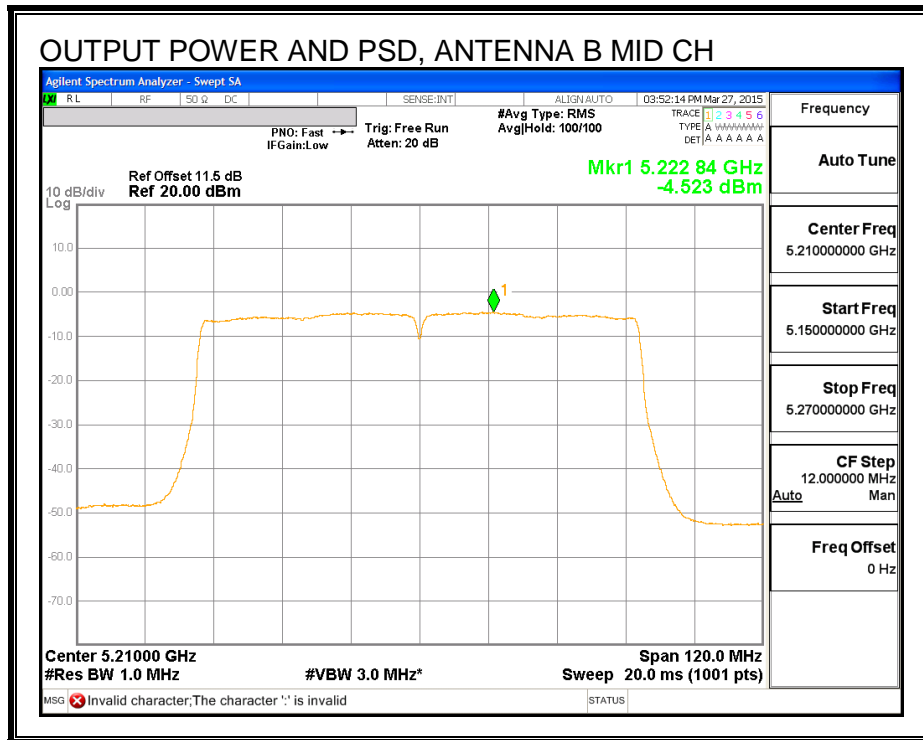

PSD, ANTENNA A

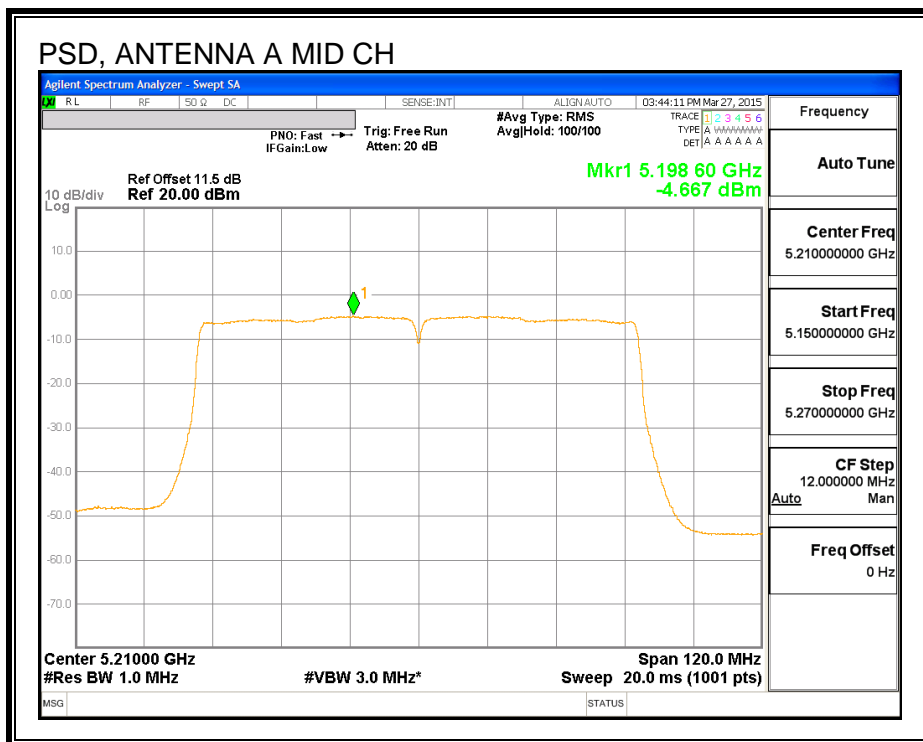

8.9. 802.11n HT20 SISO MODE IN THE 5.3 GHz BAND

8.9.1. 26 dB BANDWIDTH

LIMITS

None; for reporting purposes only.

RESULTS

Channel	Frequency (MHz)	26 dB Bandwidth (MHz)
Low	5260	22.00
Mid	5300	22.00
High	5320	21.95

26 dB BANDWIDTH

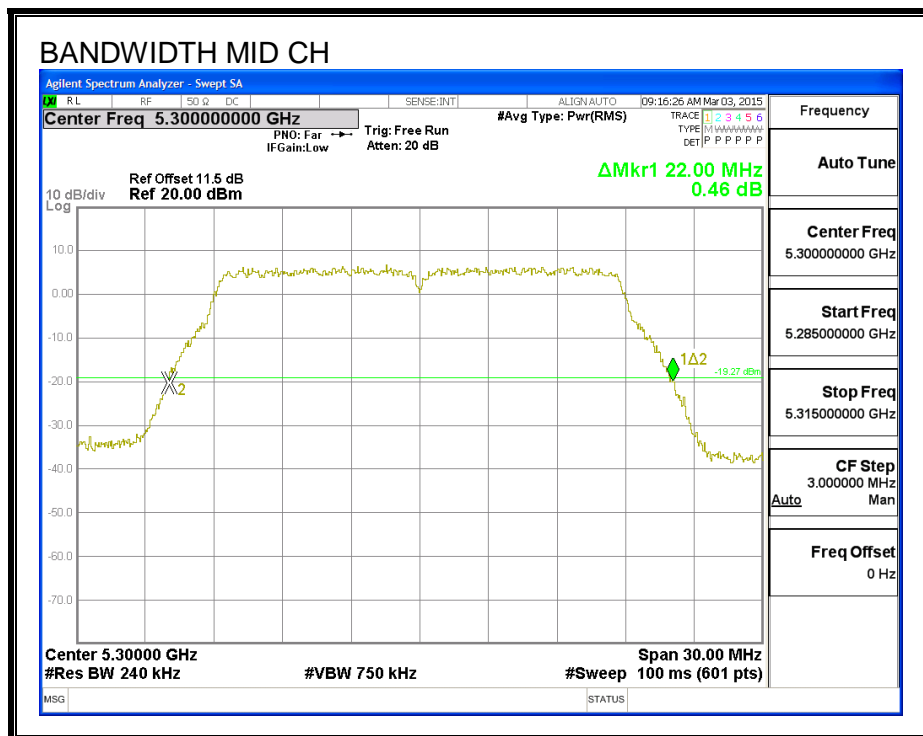
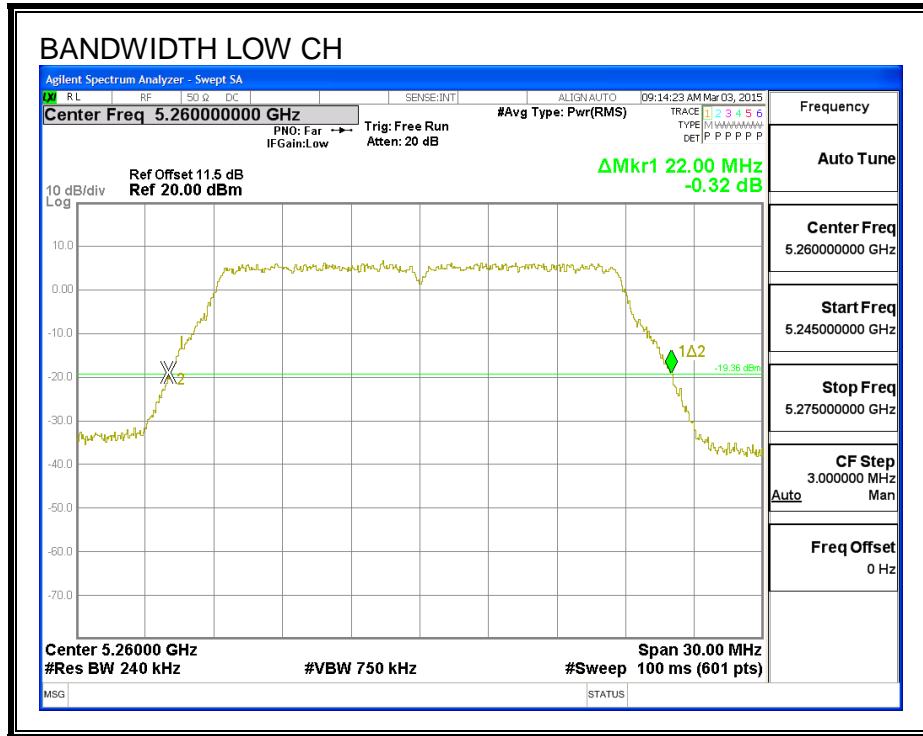

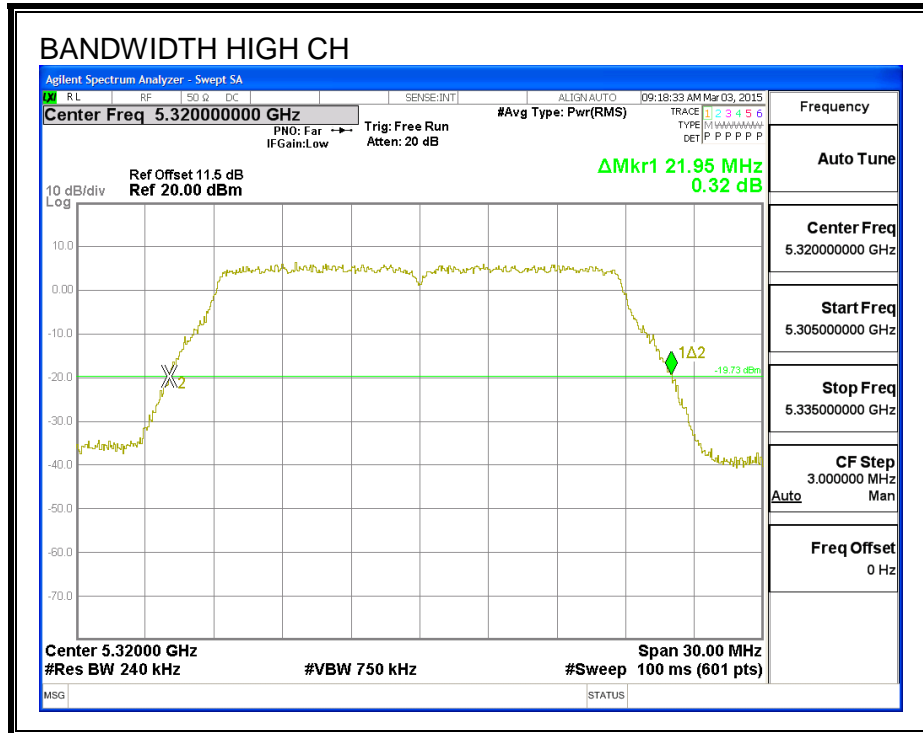

8.9.2. 99% BANDWIDTH

LIMITS

None; for reporting purposes only.

RESULTS

Channel	Frequency (MHz)	99% Bandwidth (MHz)
Low	5260	17.783
Mid	5300	17.949
High	5320	17.727

99% BANDWIDTH

