



**FCC 47 CFR PART 15 SUBPART C**

**CERTIFICATION TEST REPORT**

**FOR**

**TABLET DEVICE**

**MODEL NUMBER: A1550**

**FCC ID: BCGA1550**

**REPORT NUMBER: 14U19187-E3, REVISION B**

**ISSUE DATE: JUNE 17, 2015**

*Prepared for*

**APPLE, INC.**

**1 INFINITE LOOP**

**CUPERTINO, CA 95014, U.S.A.**

*Prepared by*

**UL VERIFICATION SERVICES INC.**

**47173 BENICIA STREET**

**FREMONT, CA 94538, U.S.A.**

**TEL: (510) 771-1000**

**FAX: (510) 661-0888**



**NVLAP LAB CODE 200065-0**

Revision History

<u>Rev.</u>	<u>Issue Date</u>	<u>Revisions</u>	<u>Revised By</u>
--	04/21/2015	Initial Issue	T. Chan
A	06/01/2015	Revised Section 2 and Section 7.2	T. Chu
B	06/17/2015	Updated Section 7.2 KDB version	T. Chu

## TABLE OF CONTENTS

<b>1. ATTESTATION OF TEST RESULTS .....</b>	<b>6</b>
<b>2. TEST METHODOLOGY .....</b>	<b>7</b>
<b>3. FACILITIES AND ACCREDITATION .....</b>	<b>7</b>
<b>4. CALIBRATION AND UNCERTAINTY .....</b>	<b>7</b>
4.1. <i>MEASURING INSTRUMENT CALIBRATION .....</i>	<i>7</i>
4.2. <i>SAMPLE CALCULATION .....</i>	<i>7</i>
4.3. <i>MEASUREMENT UNCERTAINTY.....</i>	<i>8</i>
<b>5. EQUIPMENT UNDER TEST .....</b>	<b>9</b>
5.1. <i>DESCRIPTION OF EUT .....</i>	<i>9</i>
5.2. <i>MAXIMUM OUTPUT POWER.....</i>	<i>9</i>
5.3. <i>DESCRIPTION OF AVAILABLE ANTENNAS .....</i>	<i>9</i>
5.4. <i>SOFTWARE AND FIRMWARE.....</i>	<i>9</i>
5.5. <i>WORST-CASE CONFIGURATION AND MODE.....</i>	<i>10</i>
5.6. <i>DESCRIPTION OF TEST SETUP.....</i>	<i>11</i>
<b>6. TEST AND MEASUREMENT EQUIPMENT .....</b>	<b>15</b>
<b>7. ON TIME, DUTY CYCLE AND MEASUREMENT METHODS .....</b>	<b>16</b>
7.1. <i>ON TIME AND DUTY CYCLE RESULTS.....</i>	<i>16</i>
7.2. <i>MEASUREMENT METHODS .....</i>	<i>17</i>
7.3. <i>DUTY CYCLE PLOTS .....</i>	<i>18</i>
<b>8. ANTENNA PORT TEST RESULTS .....</b>	<b>20</b>
8.1. <i>802.11b SISO MODE IN THE 2.4 GHz BAND (ANTENNA A).....</i>	<i>20</i>
8.1.1. <i>6 dB BANDWIDTH.....</i>	<i>20</i>
8.1.2. <i>99% BANDWIDTH.....</i>	<i>24</i>
8.1.3. <i>AVERAGE POWER .....</i>	<i>28</i>
8.1.4. <i>OUTPUT POWER .....</i>	<i>29</i>
8.1.5. <i>PSD .....</i>	<i>31</i>
8.1.6. <i>OUT-OF-BAND EMISSIONS .....</i>	<i>35</i>
8.2. <i>802.11b SISO MODE IN THE 2.4 GHz BAND (ANTENNA B).....</i>	<i>42</i>
8.2.1. <i>6 dB BANDWIDTH.....</i>	<i>42</i>
8.2.2. <i>99% BANDWIDTH.....</i>	<i>46</i>
8.2.3. <i>AVERAGE POWER .....</i>	<i>50</i>
8.2.4. <i>OUTPUT POWER .....</i>	<i>51</i>
8.2.5. <i>PSD .....</i>	<i>53</i>
8.2.6. <i>OUT-OF-BAND EMISSIONS .....</i>	<i>57</i>

8.3. 802.11b SISO MODE IN THE 2.4 GHz BAND (ANTENNA D).....64

8.3.1. 6 dB BANDWIDTH.....64

8.3.2. 99% BANDWIDTH.....68

8.3.3. AVERAGE POWER.....72

8.3.4. OUTPUT POWER.....73

8.3.5. PSD.....75

8.3.6. OUT-OF-BAND EMISSIONS.....79

8.4. 802.11n HT20 SISO MODE IN THE 2.4 GHz BAND (ANTENNA A).....86

8.4.1. 6 dB BANDWIDTH.....86

8.4.2. 99% BANDWIDTH.....90

8.4.3. AVERAGE POWER.....94

8.4.4. OUTPUT POWER.....95

8.4.5. PSD.....97

8.4.6. OUT-OF-BAND EMISSIONS.....101

8.5. 802.11n HT20 SISO MODE IN THE 2.4 GHz BAND (ANTENNA B).....108

8.5.1. 6 dB BANDWIDTH.....108

8.5.2. 99% BANDWIDTH.....112

8.5.3. AVERAGE POWER.....116

8.5.4. OUTPUT POWER.....117

8.5.5. PSD.....119

8.5.6. OUT-OF-BAND EMISSIONS.....123

8.6. 802.11n HT20 SISO MODE IN THE 2.4 GHz BAND (ANTENNA D).....130

8.6.1. 6 dB BANDWIDTH.....130

8.6.2. 99% BANDWIDTH.....134

8.6.3. AVERAGE POWER.....138

8.6.4. OUTPUT POWER.....139

8.6.5. PSD.....141

8.6.6. OUT-OF-BAND EMISSIONS.....145

8.7. 802.11n HT20 2TX CDD MODE IN THE 2.4 GHz BAND (ANTENNA B & A).....152

8.7.1. 6 dB BANDWIDTH.....152

8.7.2. 99% BANDWIDTH.....158

8.7.3. AVERAGE POWER.....165

8.7.4. OUTPUT POWER.....166

8.7.5. PSD.....168

8.7.6. OUT-OF-BAND EMISSIONS.....174

8.8. 802.11n HT20 2TX CDD MODE IN THE 2.4 GHz BAND (ANTENNA D & A).....186

8.8.1. 6 dB BANDWIDTH.....186

8.8.2. 99% BANDWIDTH.....192

8.8.3. AVERAGE POWER.....199

8.8.4. OUTPUT POWER.....200

8.8.5. PSD.....202

8.8.6. OUT-OF-BAND EMISSIONS.....208

**9. RADIATED TEST RESULTS.....220**

9.1. LIMITS AND PROCEDURE.....220

9.2. 802.11b 1Tx ANTENNA A MODE IN THE 2.4 GHz BAND.....221

9.3. 802.11b 1Tx ANTENNA B MODE IN THE 2.4 GHz BAND.....239

9.4. 802.11b 1Tx ANTENNA D MODE IN THE 2.4 GHz BAND.....257

---

9.5.	802.11n HT20 1Tx ANTENNA A MODE IN THE 2.4 GHz BAND .....	275
9.6.	802.11n HT20 1Tx ANTENNA BMODE IN THE 2.4 GHz BAND .....	293
9.7.	802.11n HT20 1Tx ANTENNA D MODE IN THE 2.4 GHz BAND .....	311
9.8.	802.11n HT20 2Tx ANTENNA A & B MODE IN THE 2.4 GHz BAND.....	329
9.9.	802.11n HT20 2Tx ANTENNA A & D MODE IN THE 2.4 GHz BAND .....	347
9.10.	WORST-CASE BELOW 1 GHz .....	365
9.11.	WORST-CASE ABOVE 18 GHz.....	368
<b>10.</b>	<b>AC POWER LINE CONDUCTED EMISSIONS .....</b>	<b>369</b>
<b>11.</b>	<b>SETUP PHOTOS .....</b>	<b>374</b>

# 1. ATTESTATION OF TEST RESULTS

**COMPANY NAME:** APPLE  
1 INFINITE LOOP  
CUPERTINO, CA 95014, U.S.A.

**EUT DESCRIPTION:** TABLET DEVICE

**MODEL:** A1550

**SERIAL NUMBER:** F4KPC009GJK2 (CONDUCTED);  
F4KP604KGJK5 (RADIATED);

**DATE TESTED:** FEBRUARY 19, 2015 – APRIL 07, 2015

APPLICABLE STANDARDS	
STANDARD	TEST RESULTS
CFR 47 Part 15 Subpart C	Pass

UL Verification Services Inc. tested the above equipment in accordance with the requirements set forth in the above standards. All indications of Pass/Fail in this report are opinions expressed by UL Verification Services Inc. based on interpretations and/or observations of test results. Measurement Uncertainties were not taken into account and are published for informational purposes only. The test results show that the equipment tested is capable of demonstrating compliance with the requirements as documented in this report.

**Note:** The results documented in this report apply only to the tested sample, under the conditions and modes of operation as described herein. This document may not be altered or revised in any way unless done so by UL Verification Services Inc. and all revisions are duly noted in the revisions section. Any alteration of this document not carried out by UL Verification Services Inc. will constitute fraud and shall nullify the document. This report must not be used by the client to claim product certification, approval, or endorsement by NVLAP, NIST, any agency of the Federal Government, or any agency of any government.

Approved & Released For  
UL Verification Services Inc. By:

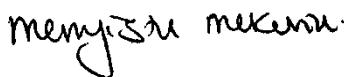

---

MENGISTU MEKURIA  
SENIOR ENGINEER  
UL Verification Services Inc.

Tested By:



---

TRI PHAM  
EMC ENGINEER  
UL Verification Services Inc.

## 2. TEST METHODOLOGY

The tests documented in this report were performed in accordance with FCC CFR 47 Part 2, FCC CFR 47 Part 15, ANSI C63.10-2009 and KDB 558074 D01.

## 3. FACILITIES AND ACCREDITATION

The test sites and measurement facilities used to collect data are located at 47173 and 47266 Benicia Street, Fremont, California, USA. Line conducted emissions are measured only at the 47173 address. The following table identifies which facilities were utilized for radiated emission measurements documented in this report. Specific facilities are also identified in the test results sections.

47173 Benicia Street	47266 Benicia Street
<input type="checkbox"/> Chamber A	<input type="checkbox"/> Chamber D
<input type="checkbox"/> Chamber B	<input checked="" type="checkbox"/> Chamber E
<input type="checkbox"/> Chamber C	<input type="checkbox"/> Chamber F
	<input type="checkbox"/> Chamber G
	<input type="checkbox"/> Chamber H

The above test sites and facilities are covered under FCC Test Firm Registration # 208313. Chambers A through H are covered under Industry Canada company address code 2324B with site numbers 2324B -1 through 2324B-8, respectively.

UL Verification Services Inc. is accredited by NVLAP, Laboratory Code 200065-0. The full scope of accreditation can be viewed at <http://ts.nist.gov/standards/scopes/2000650.htm>.

## 4. CALIBRATION AND UNCERTAINTY

### 4.1. MEASURING INSTRUMENT CALIBRATION

The measuring equipment utilized to perform the tests documented in this report has been calibrated in accordance with the manufacturer's recommendations, and is traceable to recognized national standards.

### 4.2. SAMPLE CALCULATION

Where relevant, the following sample calculation is provided:

$$\begin{aligned} \text{Field Strength (dBuV/m)} &= \text{Measured Voltage (dBuV)} + \text{Antenna Factor (dB/m)} + \\ &\text{Cable Loss (dB)} - \text{Preamp Gain (dB)} \\ 36.5 \text{ dBuV} + 18.7 \text{ dB/m} + 0.6 \text{ dB} - 26.9 \text{ dB} &= 28.9 \text{ dBuV/m} \end{aligned}$$

### 4.3. MEASUREMENT UNCERTAINTY

Where relevant, the following measurement uncertainty levels have been estimated for tests performed on the apparatus:

PARAMETER	UNCERTAINTY
Conducted Disturbance, 0.15 to 30 MHz	$\pm 3.52$ dB
Radiated Disturbance, 30 to 1000 MHz	$\pm 4.94$ dB
Radiated Disturbance, 1 to 6 GHz	$\pm 3.86$ dB
Radiated Disturbance, 6 to 18 GHz	$\pm 4.23$ dB
Radiated Disturbance, 18 to 26 GHz	$\pm 5.30$ dB
Radiated Disturbance, 26 to 40 GHz	$\pm 5.23$ dB

Uncertainty figures are valid to a confidence level of 95%.



## 5. EQUIPMENT UNDER TEST

### 5.1. DESCRIPTION OF EUT

The EUT is a tablet with multimedia functions (music, application support, and video), Cellular GSM/GPRS/EGPRS/CDMA2000 1xRTT/1x Advanced/EVDO Rev.A/EVDO Rev.B /WCDMA /HSPA+/DC-HSDPA/LTE FDD & Carrier Aggregation/TDD/TD-SCDMA radio, IEEE 802.11a/b/g/n/ac radio, and Bluetooth radio. The rechargeable battery is not user accessible.

### 5.2. MAXIMUM OUTPUT POWER

The transmitter has a maximum conducted output power as follows:

Frequency Range (MHz)	Mode	Antenna A Output Power	Antenna A Output Power	Antenna B Output Power	Antenna B Output Power	Antenna D Output Power	Antenna D Output Power
2412 - 2472	802.11b	17.93	62.09	19.36	86.30	14.95	31.26
2412 - 2472	802.11g	Covered by 802.11n HT20 1TX					
2412 - 2472	802.11g 2TX	Covered by 802.11n HT20 2TX					
2412 - 2472	802.11n HT20 1TX	23.29	213.30	24.72	296.48	20.83	121.06

Frequency Range (MHz)	Mode	Antenna B + Antenna A Output Power (dBm)	Antenna B + Antenna A Output Power (mW)	Antenna D + Antenna A Output Power (dBm)	Antenna D + Antenna A Output Power (mW)
2412 - 2472	802.11n HT20 2TX CDD	27.43	553.35	26.13	410.20
2412 - 2472	802.11n HT20 2TX STBC	Covered by 802.11n HT20 2TX CDD			
2412 - 2472	802.11n HT20 2TX SDM	Covered by 802.11n HT20 2TX CDD			

Note: The output power on covered modes is equal to or less than one referenced.

### 5.3. DESCRIPTION OF AVAILABLE ANTENNAS

Frequency Band (GHz)	Antenna Gain		
	Antenna A	Antenna B	Antenna D
2.4	0.20	-1.00	2.50

### 5.4. SOFTWARE AND FIRMWARE

The firmware installed in the EUT during testing was 12H33.

## 5.5. WORST-CASE CONFIGURATION AND MODE

Radiated emission and power line conducted emission were performed with the EUT set to transmit at the channel with highest output power as worst-case scenario.

The following configurations were investigated and EUT powered by AC/DC adapter was the worst-case scenario. AC power line and below 1G radiated tests were conducted on configuration 1.

Configuration	Descriptions
1	EUT powered by AC/DC adapter via USB cable
2	EUT powered by host PC via USB cable

For SISO modes there are three transmission antennas, only one port of A, B or D operates at a time. For MIMO modes only two ports operate at a time, A&B or A&D.

The fundamental of the EUT was investigated in three orthogonal orientations X/Y/Z, it was determined the following was the worst-case orientation for each mode, all final radiated testing was performed with the EUT at the worst-case orientation.

Frequency Band (GHz)	Mode	Antenna Port	Worst-case Orientation
2.4	1TX SISO	Antenna A	Y-Landscape
		Antenna B	X-Flatbed
		Antenna D	X-Flatbed
	2TX MIMO	Antenna A + Antenna D	X-Flatbed
		Antenna A + Antenna B	X-Flatbed

Worst-case data rates as provided by the client were:

802.11b mode: 1 Mbps  
 802.11g mode: 6 Mbps  
 802.11n HT20mode: MCS0

The target power for 802.11g and 802.11n HT20 1TX are the same and use the same modulation (OFDM).

Radiated emissions for EUT with antenna was performed and passed; therefore, antenna port spurious was not performed.

## 5.6. DESCRIPTION OF TEST SETUP

### SUPPORT EQUIPMENT

Support Equipment List				
Description	Manufacturer	Model	Serial Number	FCC ID
Laptop AC/DC adapter	Lenovo	92P1160	11S92P1160Z1ZBGH798B12	NA
Laptop	Lenovo	7659	L3-AL664 08/03	NA
Earphone	Apple	NA	NA	NA
EUT AC/DC adapter	Apple	MD836LL/A	NA	NA

### I/O CABLES (CONDUCTED TEST)

I/O Cable List						
Cable No	Port	# of identical ports	Connector Type	Cable Type	Cable Length (m)	Remarks
1	Antenna	1	SMA	Un-Shielded	0.2	To spectrum Analyzer
2	USB	1	USB	Shielded	1	N/A

### I/O CABLES (RADIATED ABOVE 1 GHZ)

I/O Cable List						
Cable No	Port	# of identical ports	Connector Type	Cable Type	Cable Length (m)	Remarks
None used						

### I/O CABLES (AC POWER CONDUCTED TEST and below 1 GHZ)

I/O Cable List						
Cable No	Port	# of identical ports	Connector Type	Cable Type	Cable Length (m)	Remarks
1	AC	1	US115	Un-Shielded	0.8	NA
2	DC	1	lightning	Un-Shielded	1	NA
3	Audio	1	Jack	Un-Shielded	0.5	NA

**TEST SETUP- CONDUCTED PORT**

The EUT was tested connected to a host Laptop via USB cable adapter and spectrum analyzer to antenna port. Test software exercised the EUT.

**SETUP DIAGRAM**

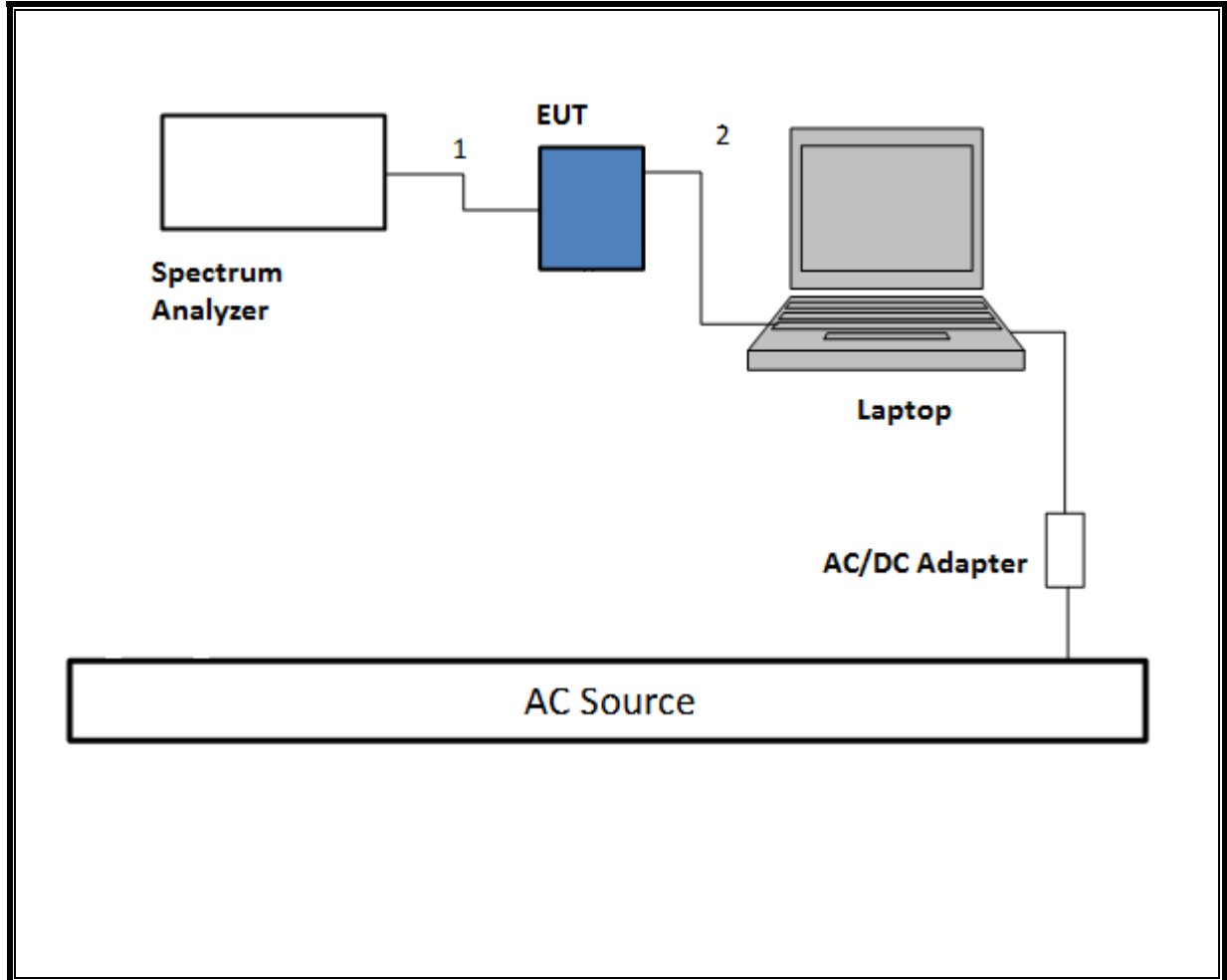

**TEST SETUP- RADIATED-ABOVE 1 GHZ**

The EUT was tested battery powered. Test software exercised the EUT.

**SETUP DIAGRAM**

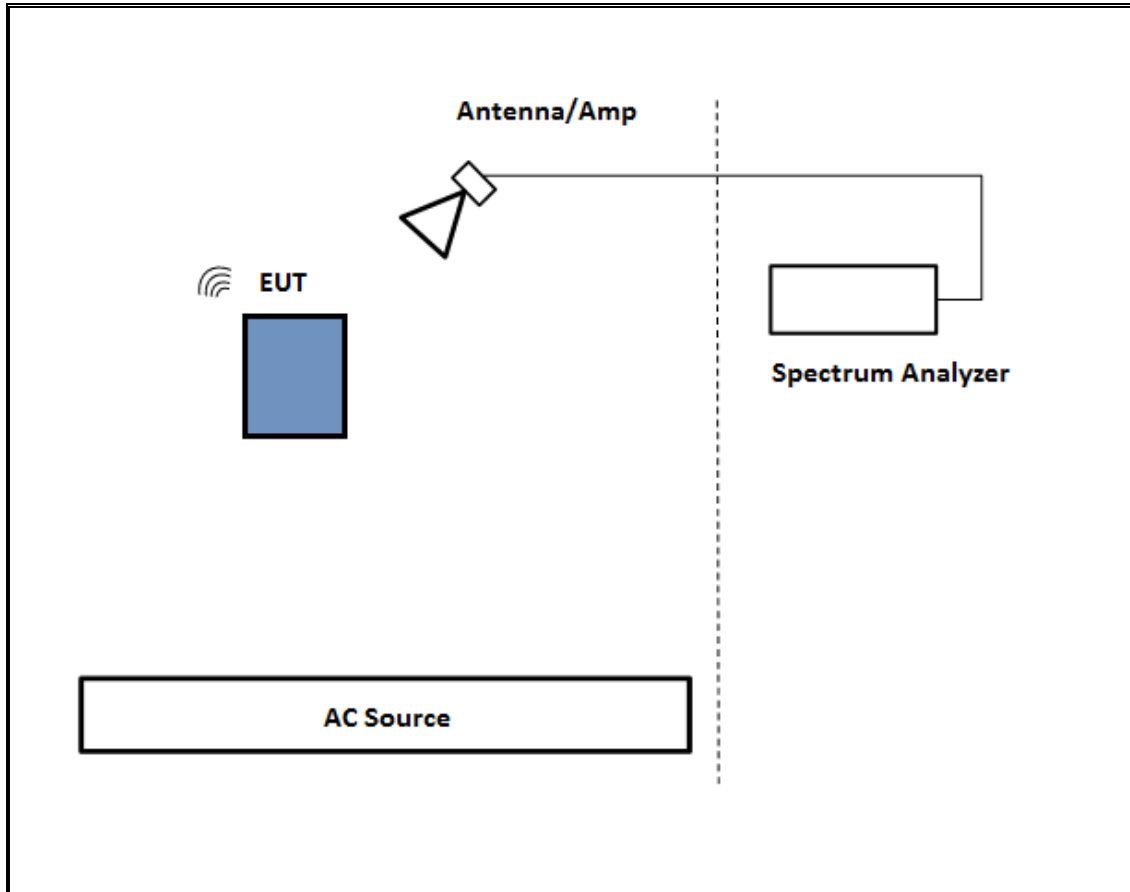

**TEST SETUP- BELOW 1GHZ & AC LINE CONDUCTED TESTS**

The EUT was tested with earphone connected and powered by AC adapter. Test software exercised the EUT.

**SETUP DIAGRAM**

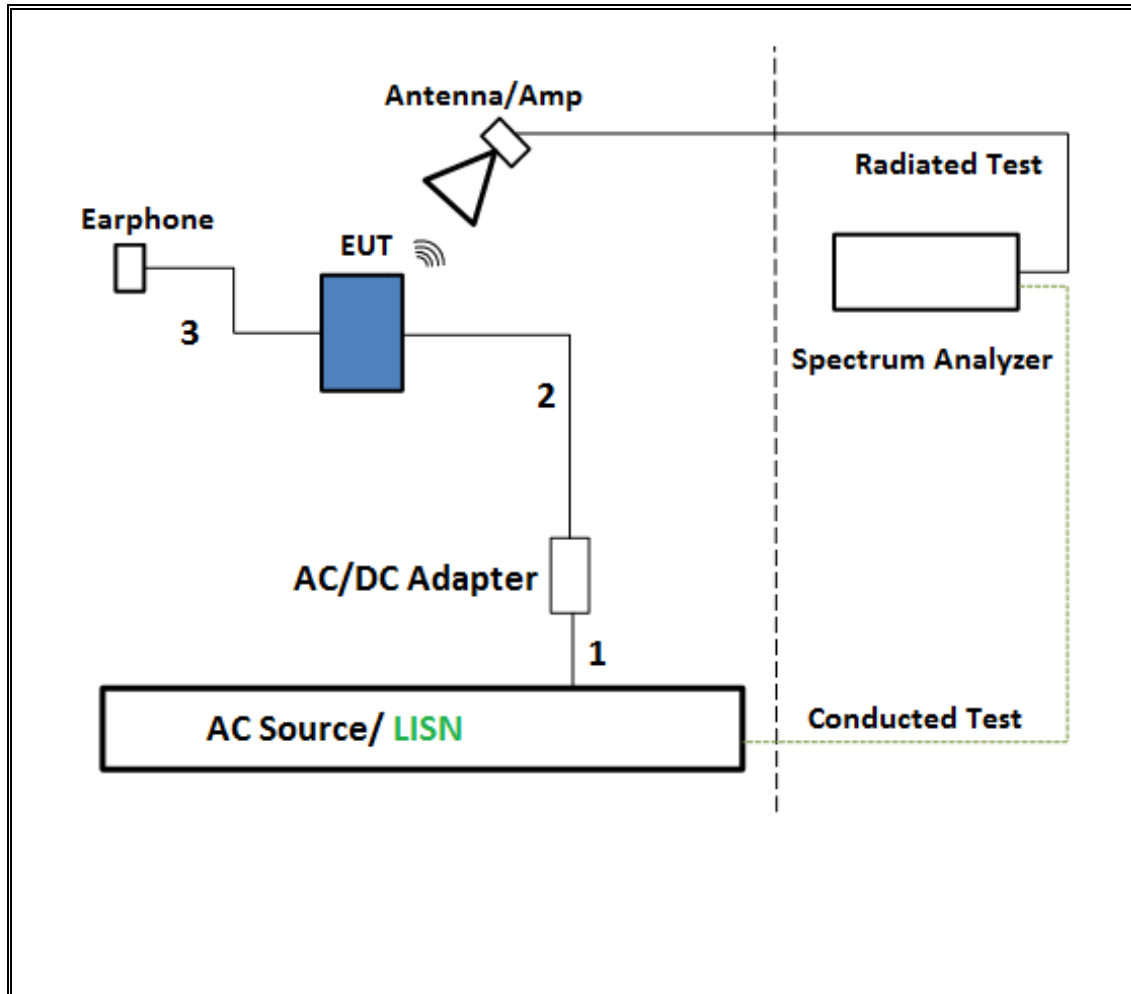

## 6. TEST AND MEASUREMENT EQUIPMENT

The following test and measurement equipment was utilized for the tests documented in this report:

Test Equipment List				
Description	Manufacturer	Model	Asset	Cal Due
Antenna, Horn 1-18GHz	ETS Lindgren	3117	00143449	2/10/2016
Antenna, Broadband Hybrid, 30MHz to 2000MHz	Sunol Sciences	JB3	A022813-1	1/14/2016
Amplifier, 1 - 18GHz	Miteq	AFS42-00101800-25-S-42	1782158	1/26/2016
Amplifier, 10KHz to 1GHz, 32dB	Sonoma	310N	323561	5/28/2015
Spectrum Analyzer, PXA, 3Hz to 44GHz	Agilent	N9030A	US51350187	5/2/2015
Antenna, Broadband Hybrid, 30MHz to 2000MHz	Sunol Sciences	JB1	A121003	2/13/2016
Amplifier, 10KHz to 1GHz, 32dB	Sonoma	310N	185623	6/7/2015
Spectrum Analyzer, PXA, 3Hz to 44GHz	Agilent	N9030A	MY51380911	2/20/2016
Power Meter, P-series single channel	Agilent	N1911A	GB45100212	10/9/2015
Power Sensor, P - series, 50MHz to 18GHz, Wideband	Agilent	N1921A	MY53260010	7/12/2015
Antenna, Horn 18 to 26.5GHz	ARA	MWH-1826	1049	12/17/2015
Spectrum Analyzer, 40 GHz	Agilent	8564E	3943A01643	8/6/2015
Amplifier, 1 to 26.5GHz, 23.5dB Gain minimum	Agilent	8449B	3008A01114	10/4/2015
AC Line Conducted				
EMI Test Receiver 9Khz-7GHz	Rohde & Schwarz	ESCI7	100935	9/16/2015
LISN for Conducted Emissions CISPR-16	FCC	50/250-25-2	114	1/16/2016
Power Cable, Line Conducted Emissions ANSI 63.4	UL	PG1	N/A	7/28/2015
UL SOFTWARE				
Radiated Software	UL	UL EMC	Ver 9.5, July 22, 2014	
Conducted Software	UL	UL EMC	Ver 2.2, March 31, 2015	
AC Line Conducted Software	UL	UL EMC	Ver 9.5, February 26, 2015	

## 7. ON TIME, DUTY CYCLE AND MEASUREMENT METHODS

### LIMITS

None; for reporting purposes only.

### PROCEDURE

KDB 558074 Zero-Span Spectrum Analyzer Method.

### 7.1. ON TIME AND DUTY CYCLE RESULTS

### LIMITS

None; for reporting purposes only.

### PROCEDURE

KDB 558074 Zero-Span Spectrum Analyzer Method.

Mode	ON Time B (msec)	Period (msec)	Duty Cycle x (linear)	Duty Cycle (%)	Duty Cycle Correction Factor (dB)	1/B Minimum VBW (kHz)
<b>2.4GHz Band</b>						
802.11b 1TX	1.000	1.000	1.000	100.00%	0.00	0.010
802.11n HT20 1TX	1.920	1.941	0.989	98.92%	0.00	0.010
802.11n HT20 CDD	1.920	1.940	0.990	98.97%	0.00	0.010



---

## 7.2. MEASUREMENT METHODS

6 dB BW: KDB 558074 D01 v03r03, Section 8.1.

Output Power: KDB 558074 D01 v03r03, Section 9.1.2

Power Spectral Density: KDB 558074 D01 v03r03, Section 10.2.

Out-of-band emissions in non-restricted bands: KDB 558074 D01 v03r03, Section 11.0.

Out-of-band emissions in restricted bands: KDB 558074 D01 v03r03, Section 12.1.

Band-edge: KDB 558074 D01 v03r03, Section 12.1

### 7.3. DUTY CYCLE PLOTS

#### 2.4 GHz BAND

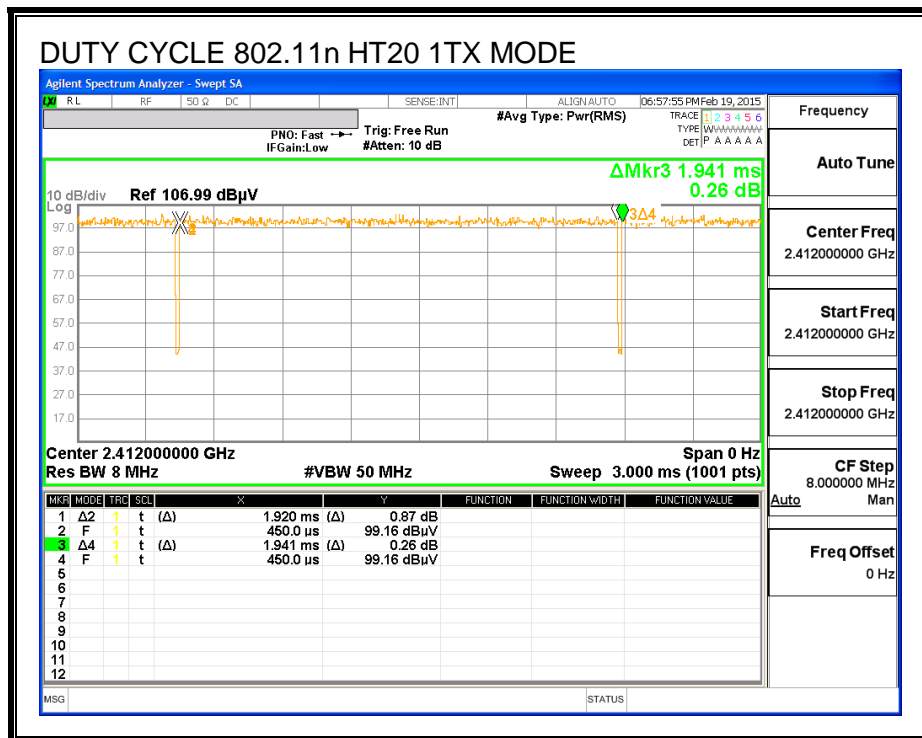
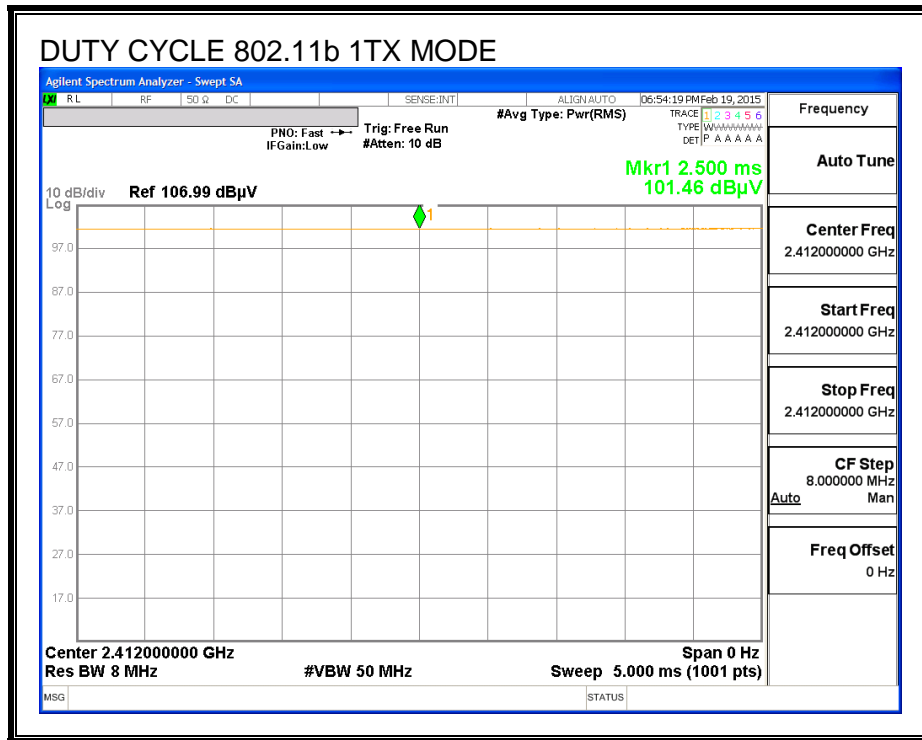

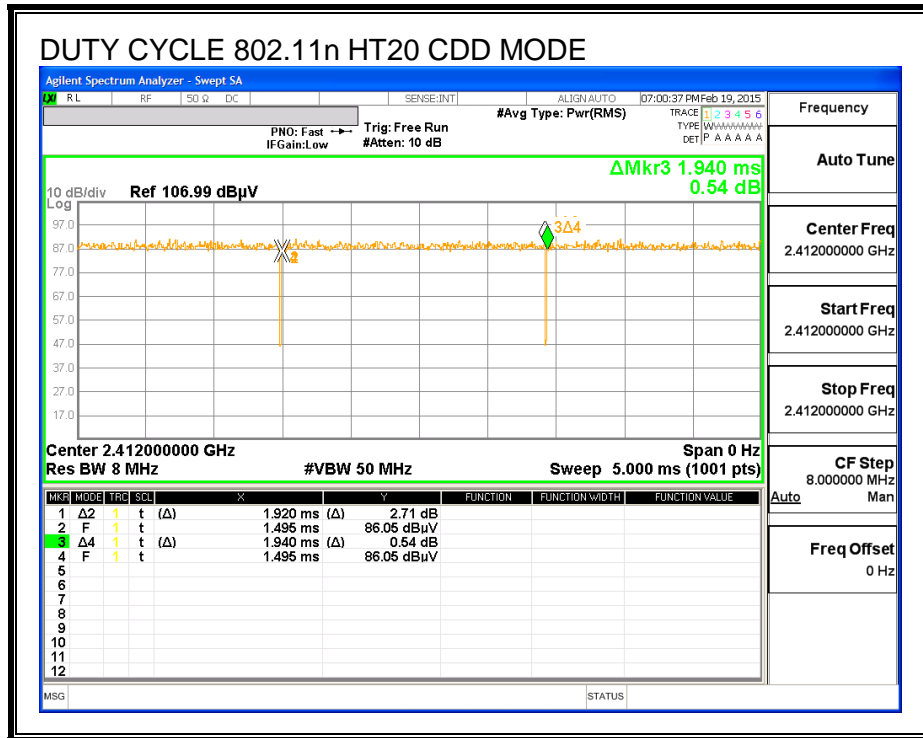

## 8. ANTENNA PORT TEST RESULTS

### 8.1. 802.11b SISO MODE IN THE 2.4 GHz BAND (ANTENNA A)

#### 8.1.1. 6 dB BANDWIDTH

##### LIMITS

FCC §15.247 (a) (2)

The minimum 6 dB bandwidth shall be at least 500 kHz.

##### RESULTS

Channel	Frequency (MHz)	6 dB Bandwidth (MHz)	Minimum Limit (MHz)
Low	2412	9.064	0.5
Mid	2437	9.068	0.5
High	2462	9.082	0.5
High	2467	9.064	0.5
High	2472	9.068	0.5

**6 dB BANDWIDTH**

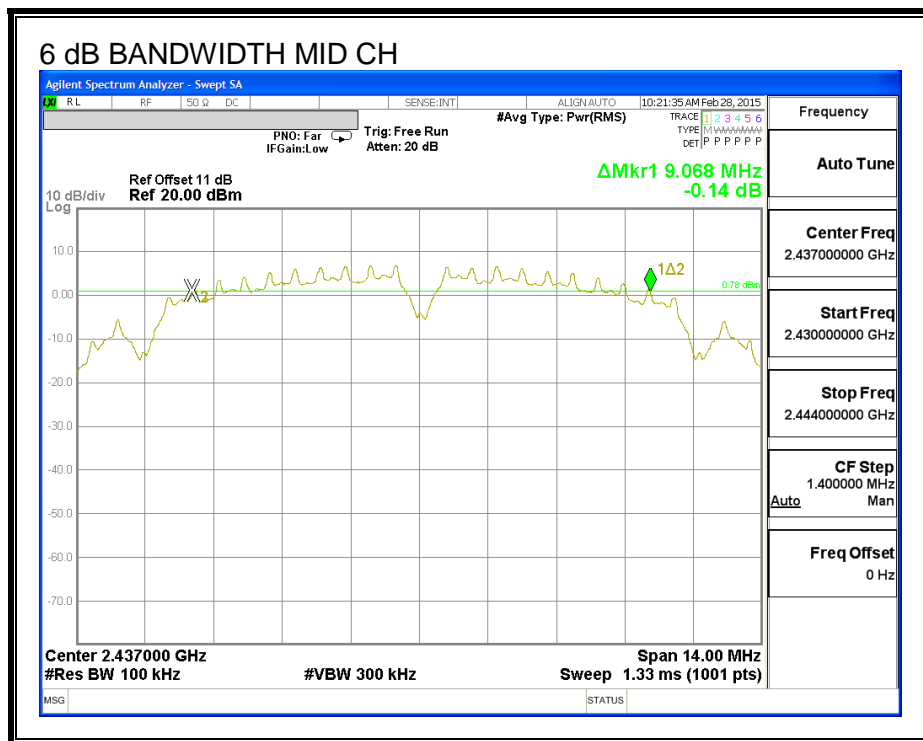
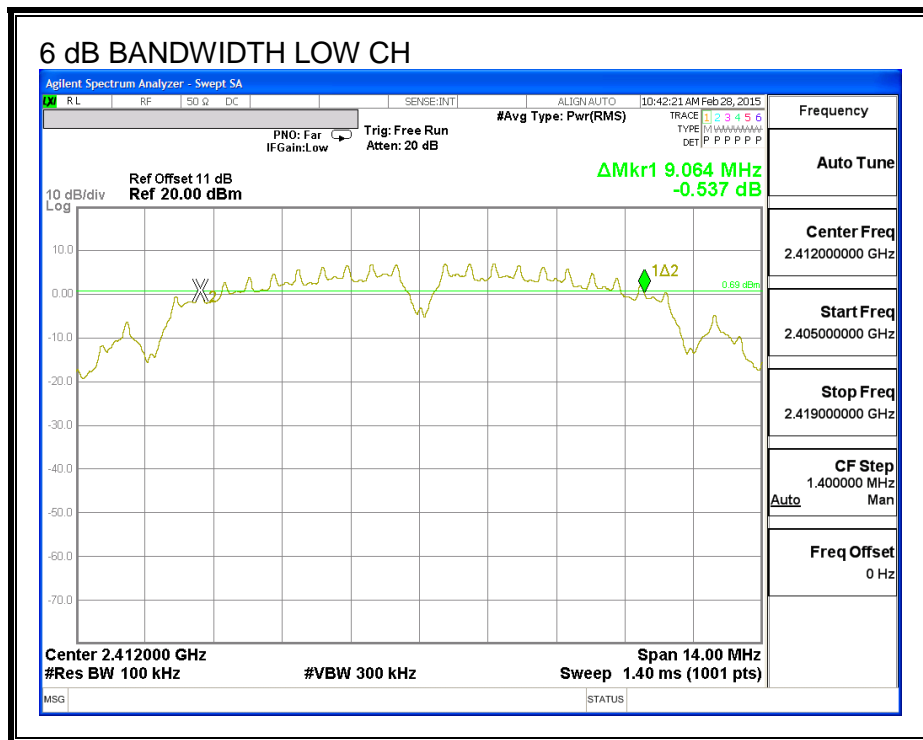

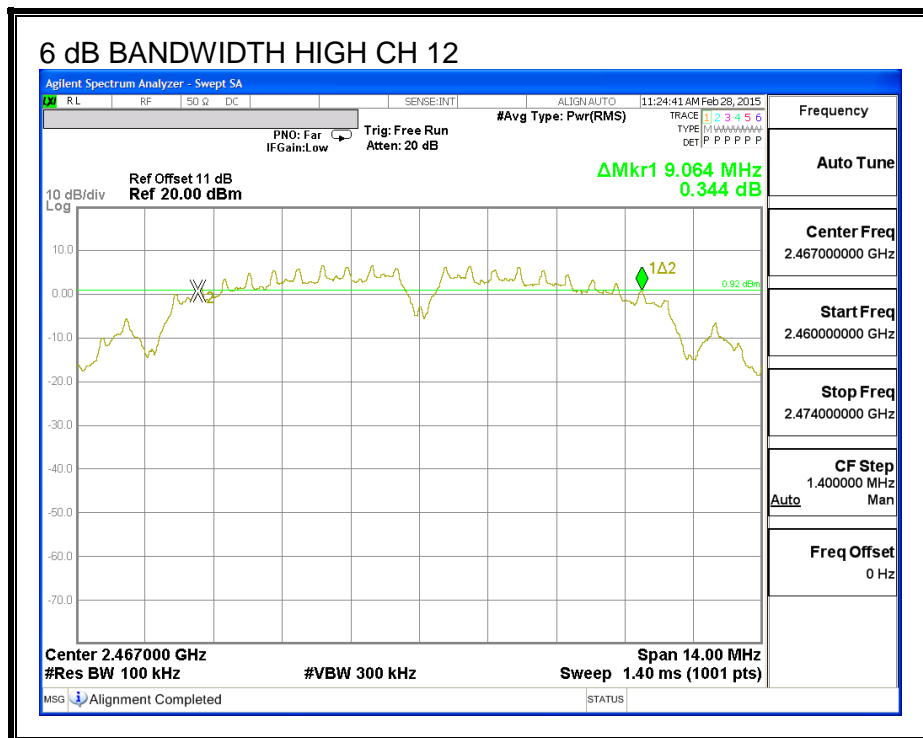
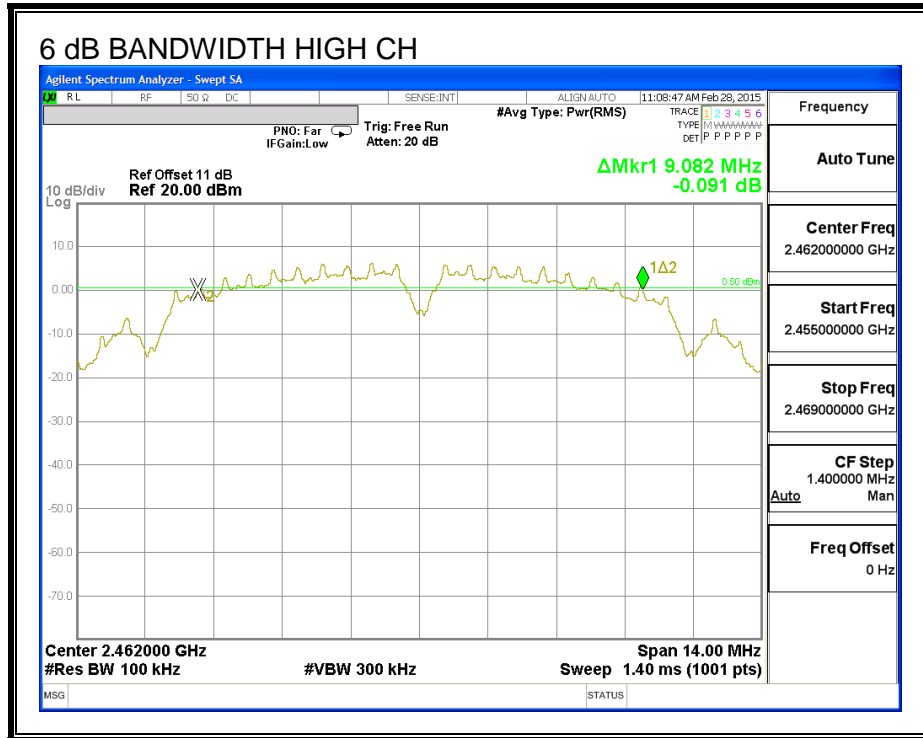

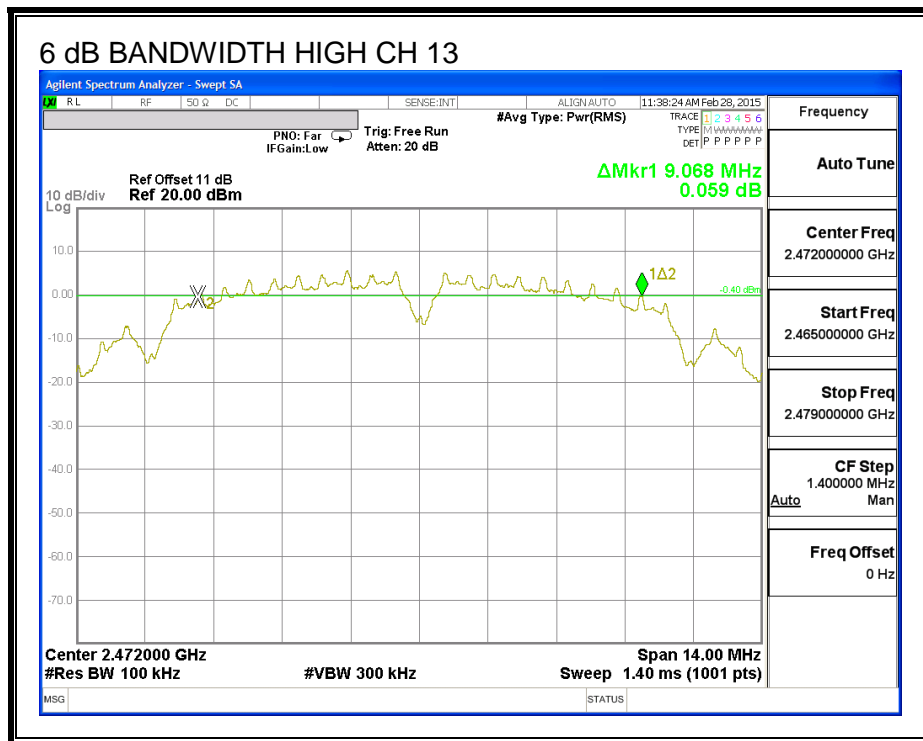

### 8.1.2. 99% BANDWIDTH

#### LIMITS

None; for reporting purposes only.

#### RESULTS

Channel	Frequency (MHz)	99% Bandwidth (MHz)
Low	2412	11.380
Mid	2437	11.481
High	2462	11.497
High	2467	11.776
High	2472	11.299



**99% BANDWIDTH**

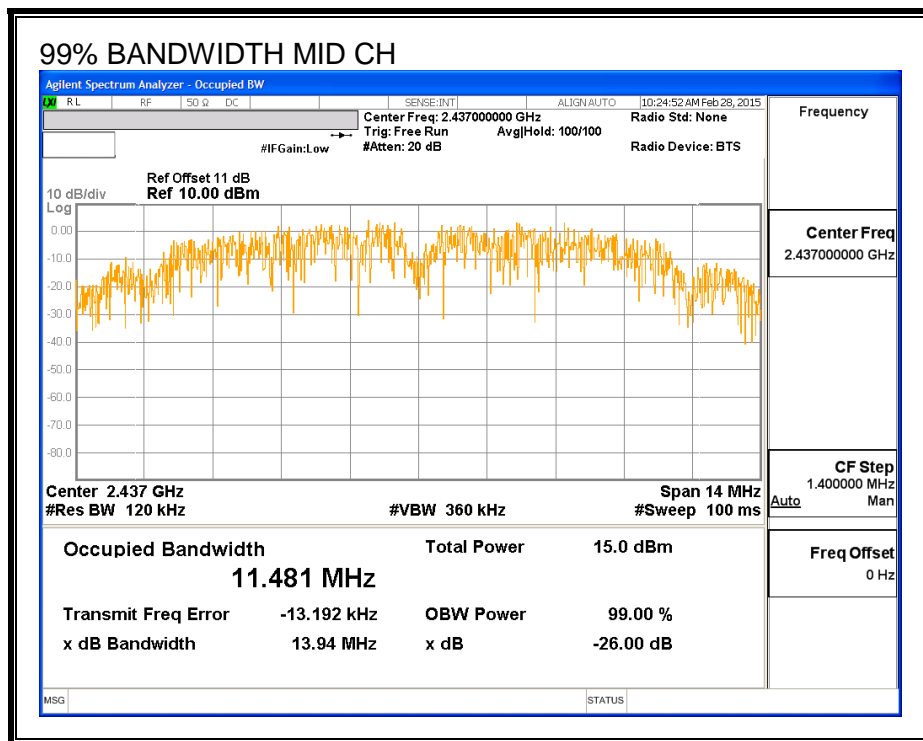
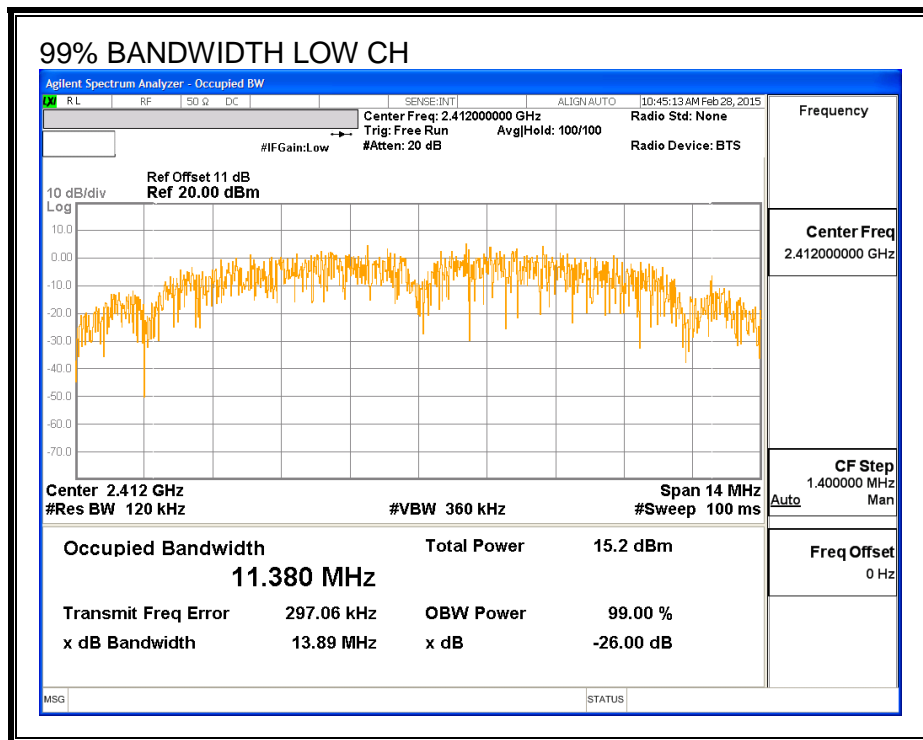

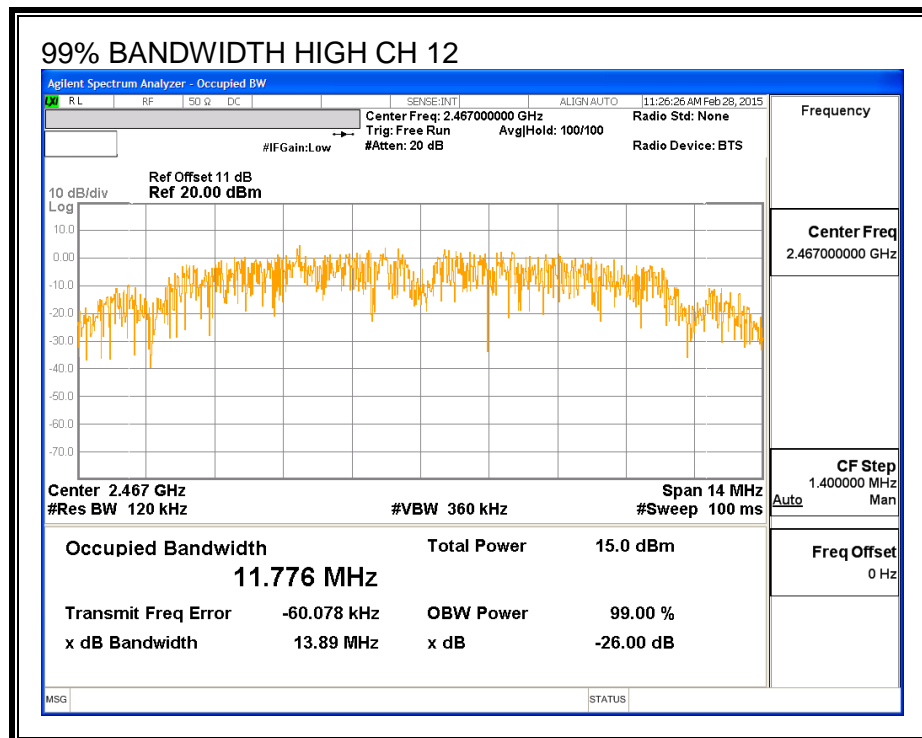
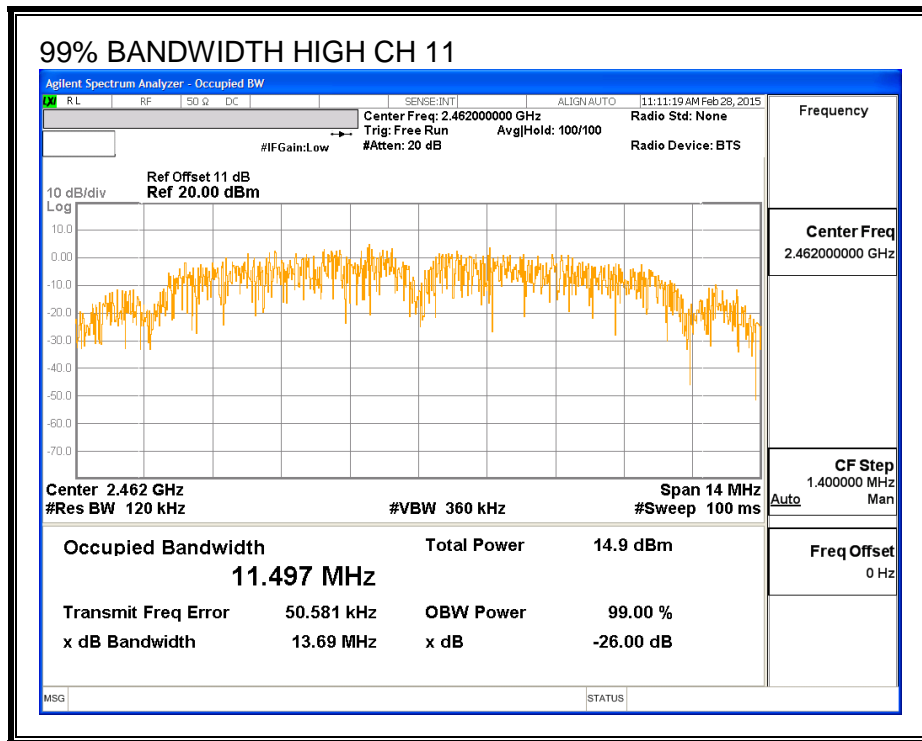

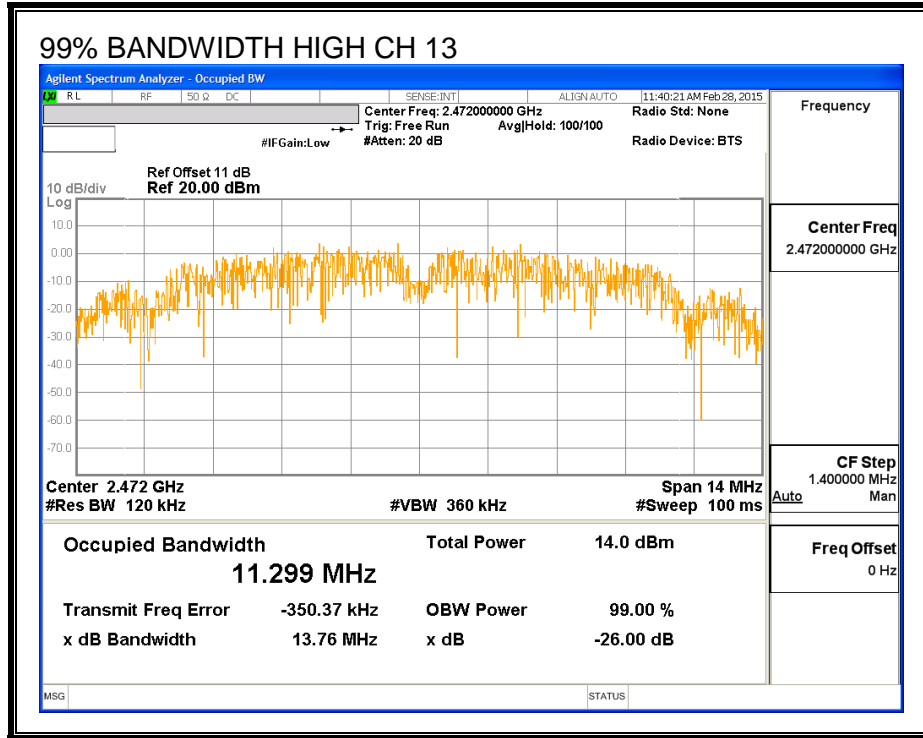

### 8.1.3. AVERAGE POWER

#### LIMITS

None; for reporting purposes only.

#### RESULTS

Channel	Frequency (MHz)	Power (dBm)
Low	2412	14.95
Mid	2437	14.98
High	2462	14.75
High	2467	14.82
High	2472	12.50

---

## 8.1.4. OUTPUT POWER

### LIMITS

FCC §15.247

For systems using digital modulation in 2400–2483.5 MHz, and 5725–5850 MHz bands: 1 Watt, based on the use of antennas with directional gains that do not exceed 6 dBi. If transmitting antennas of directional gain greater than 6 dBi are used, the conducted output power from the intentional radiator shall be reduced by the amount in dB that the directional gain of the antenna exceeds 6 dBi.

### DIRECTIONAL ANTENNA GAIN

There is only one transmitter output therefore the directional gain is equal to the antenna gain.

**RESULTS**

**Limits**

Channel	Frequency (MHz)	Directional Gain (dBi)	FCC Power Limit (dBm)	IC Power Limit (dBm)	IC EIRP Limit (dBm)	Max Power (dBm)
Low	2412	0.20	30.00	30	36	30.00
Mid	2437	0.20	30.00	30	36	30.00
High	2462	0.20	30.00	30	36	30.00
High	2467	0.20	30.00	30	36	30.00
High	2472	0.20	30.00	30	36	30.00

**Results**

Channel	Frequency (MHz)	Antenna A Meas Power (dBm)	Total Corr'd Power (dBm)	Power Limit (dBm)	Margin (dB)
Low	2412	17.90	17.90	30.00	-12.10
Mid	2437	17.93	17.93	30.00	-12.07
High	2462	17.57	17.57	30.00	-12.43
High	2467	17.90	17.90	30.00	-12.10
High	2472	15.20	15.20	30.00	-14.80

### 8.1.5. PSD

#### LIMITS

FCC §15.247

#### RESULTS

Channel	Frequency (MHz)	Antenna A Meas (dBm)	Limit (dBm)	Margin (dB)
Low	2412	-7.61	8.0	-15.6
Mid	2437	-7.46	8.0	-15.5
High	2462	-7.60	8.0	-15.6
High	2467	-7.53	8.0	-15.5
High	2472	-9.77	8.0	-17.8

PSD

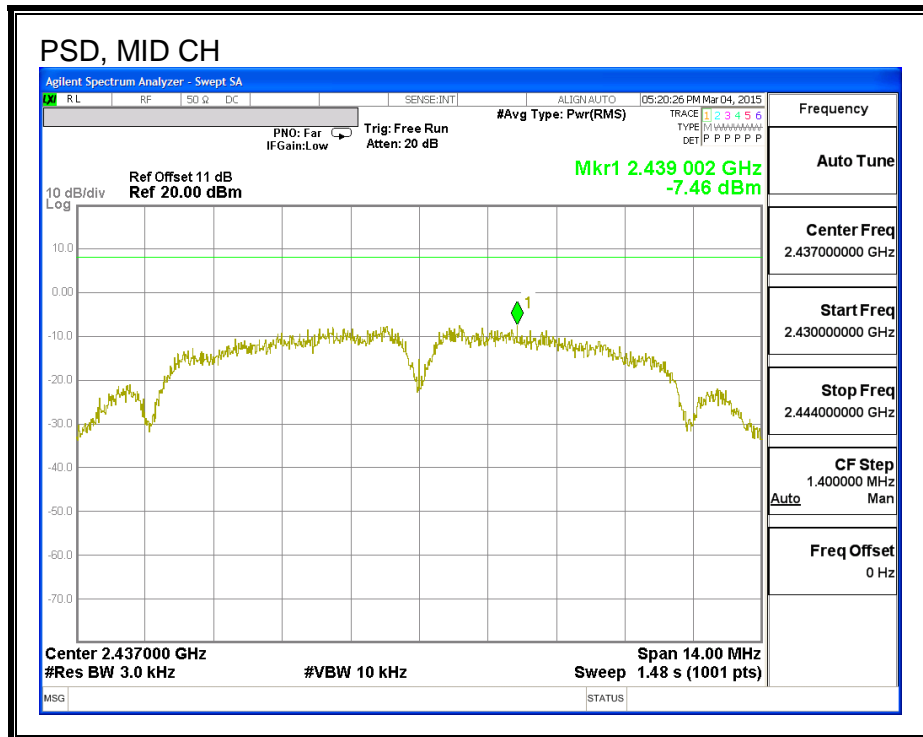
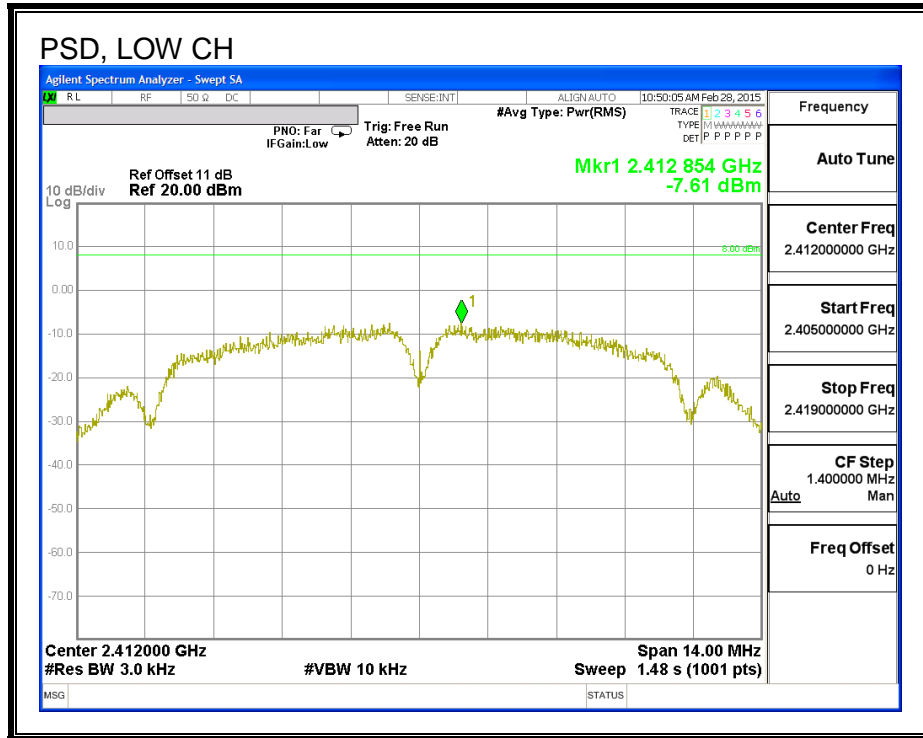



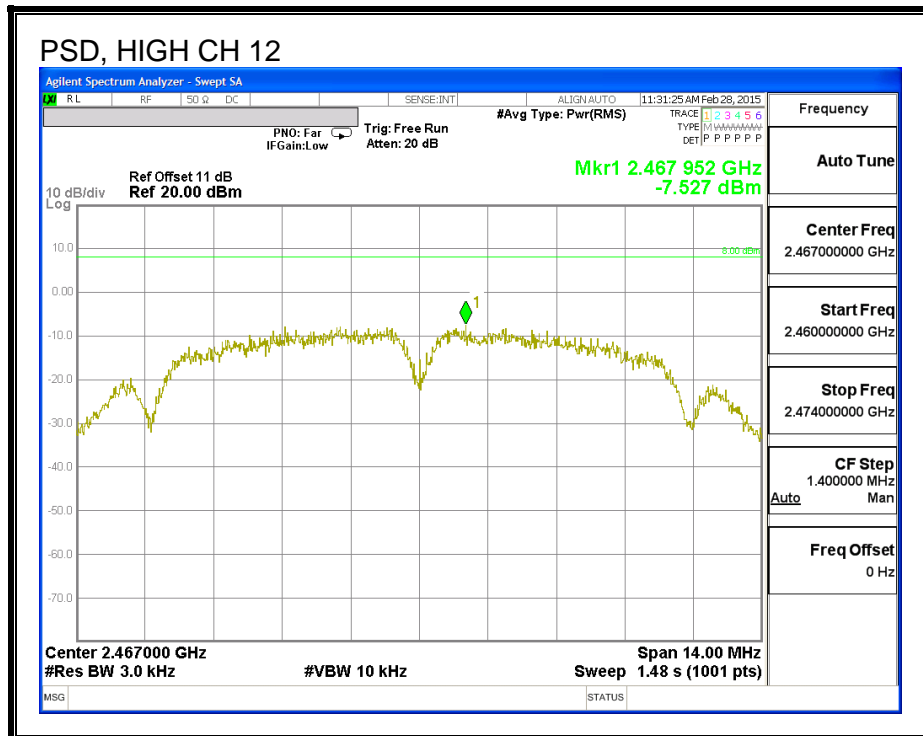
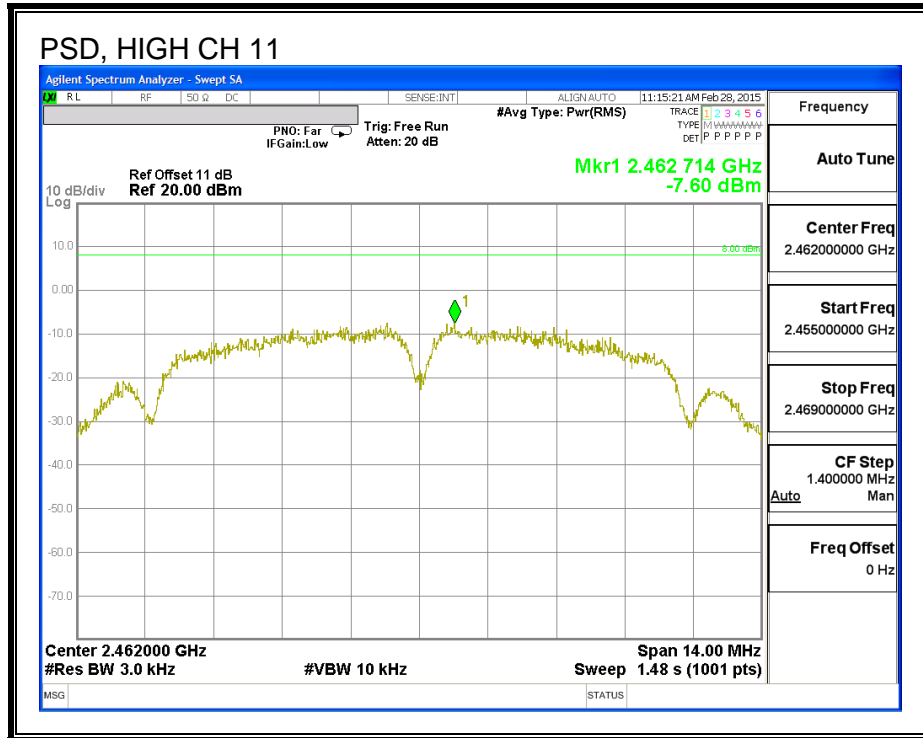

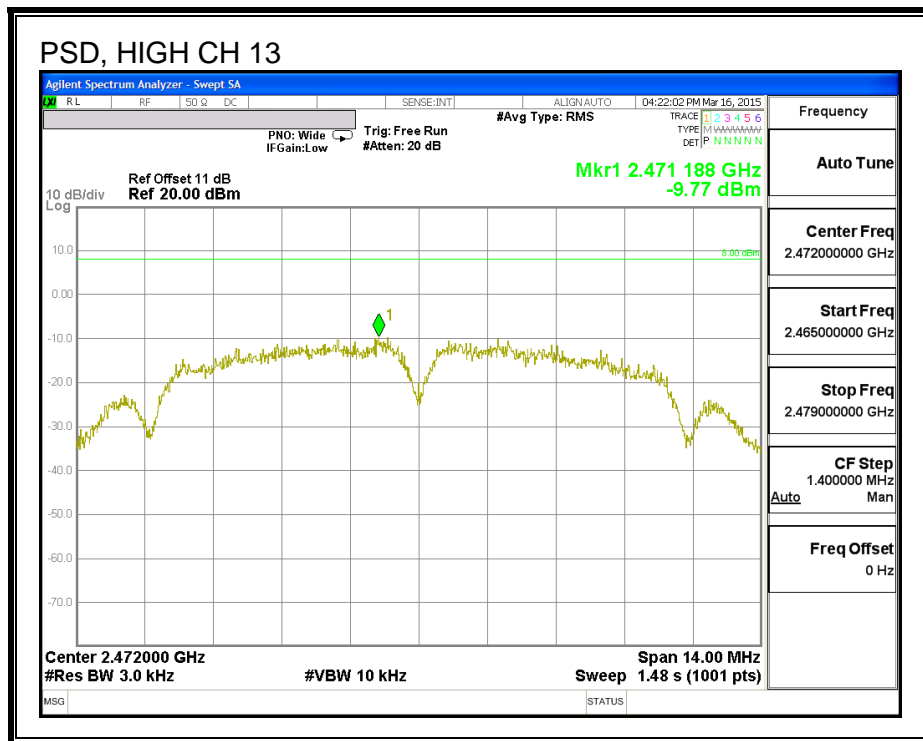

---

## 8.1.6. OUT-OF-BAND EMISSIONS

### LIMITS

FCC §15.247 (d)

In any 100 kHz bandwidth outside the frequency band in which the spread spectrum or digitally modulated intentional radiator is operating, the radio frequency power that is produced by the intentional radiator shall be at least 20 dB below that in the 100 kHz bandwidth within the band that contains the highest level of the desired power, based on either an RF conducted or a radiated measurement, provided the transmitter demonstrates compliance with the peak conducted power limits. If the transmitter complies with the conducted power limits based on the use of RMS averaging over a time interval, as permitted under paragraph (b)(3) of this section, the attenuation required under this paragraph shall be 30 dB instead of 20 dB. Attenuation below the general limits specified in §15.209(a) is not required.

**RESULTS**

**IN-BAND REFERENCE LEVEL**

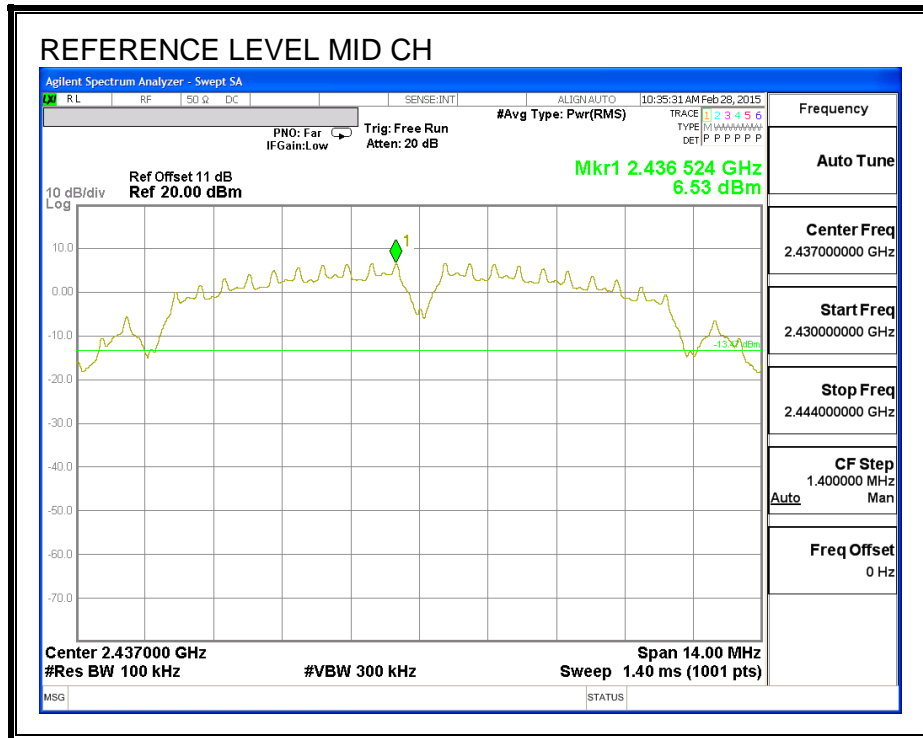

**LOW CHANNEL BANDEGE**

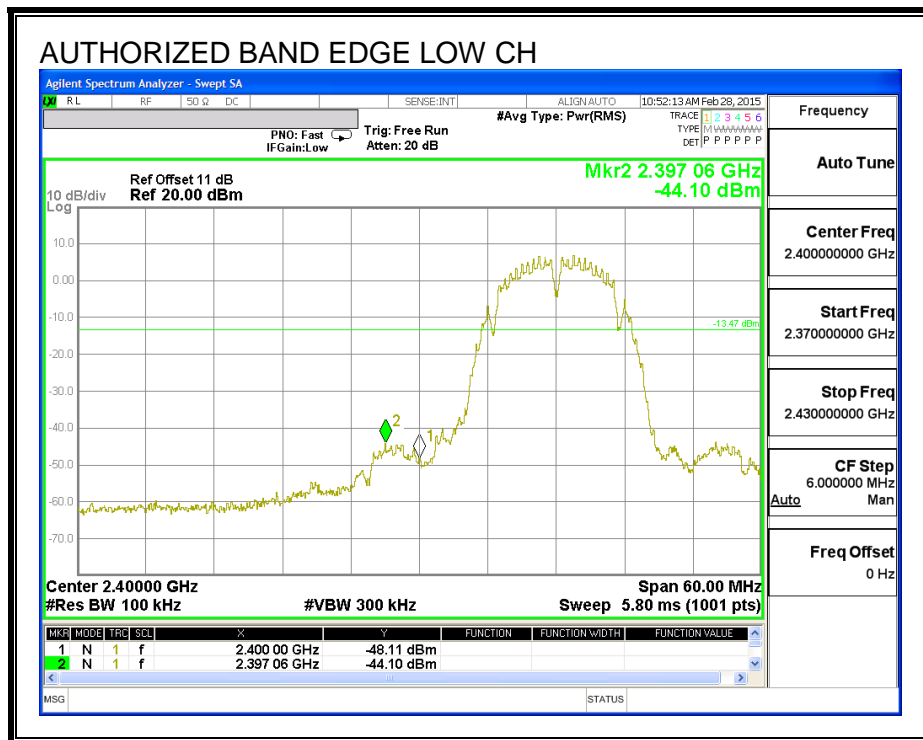

**HIGH CHANNEL BANDEGE**

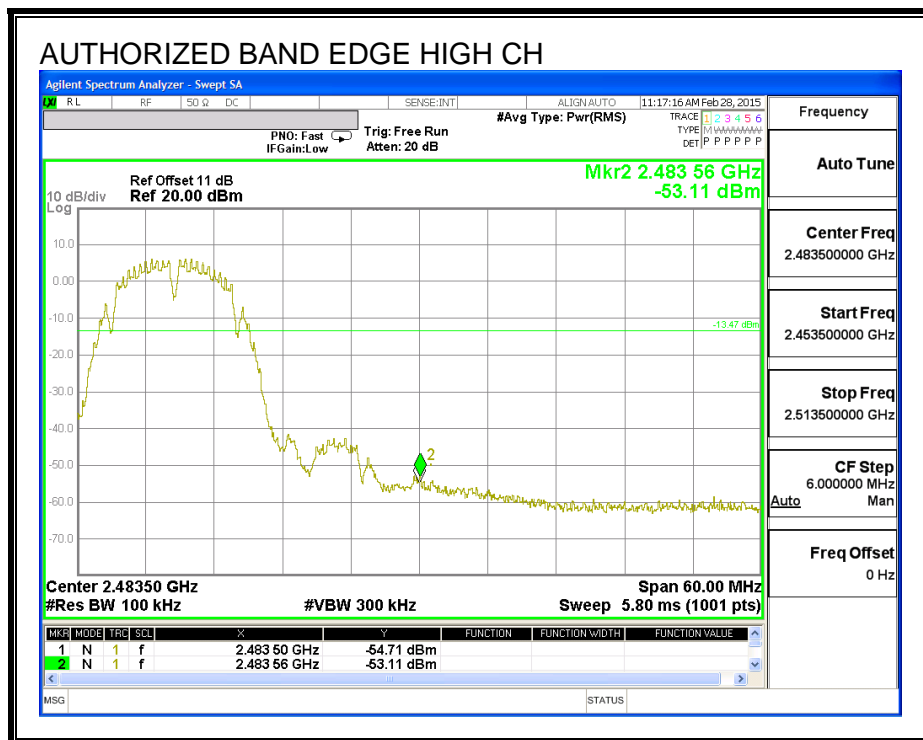

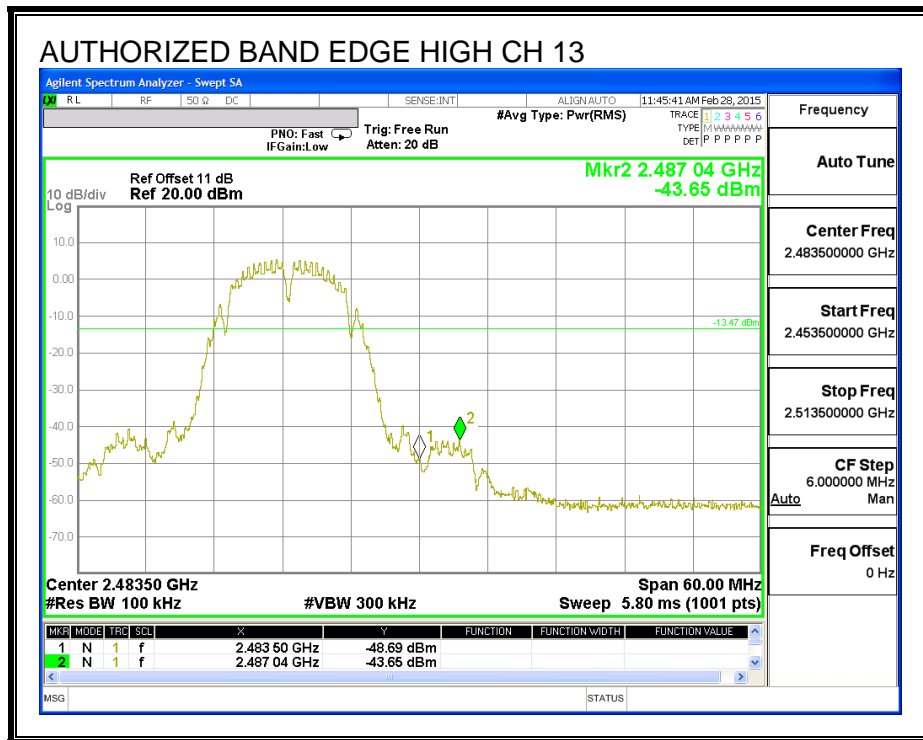
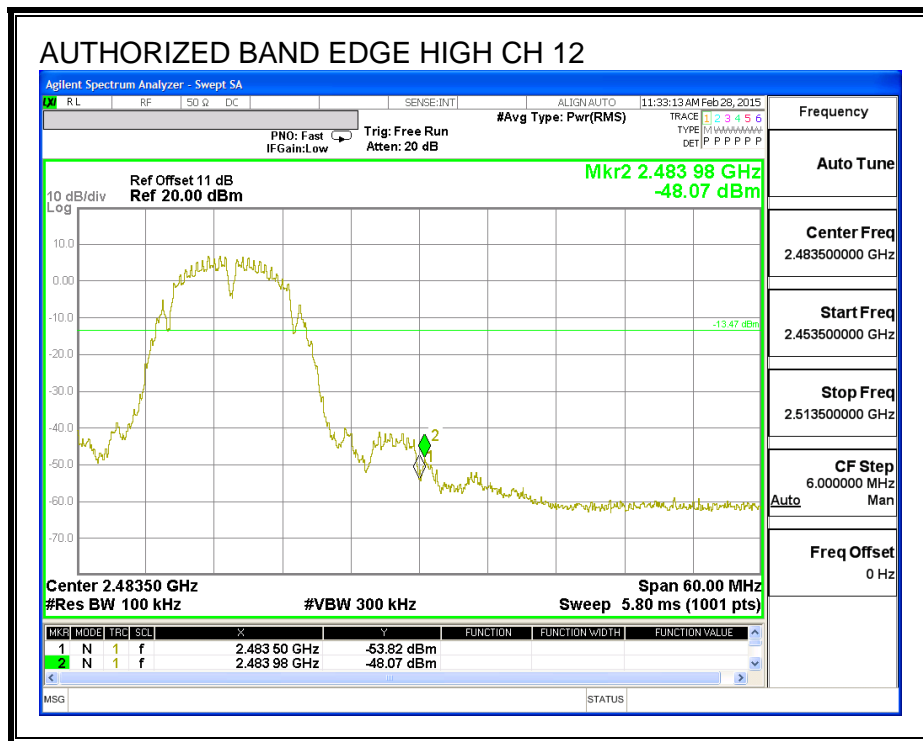

**OUT-OF-BAND EMISSIONS**

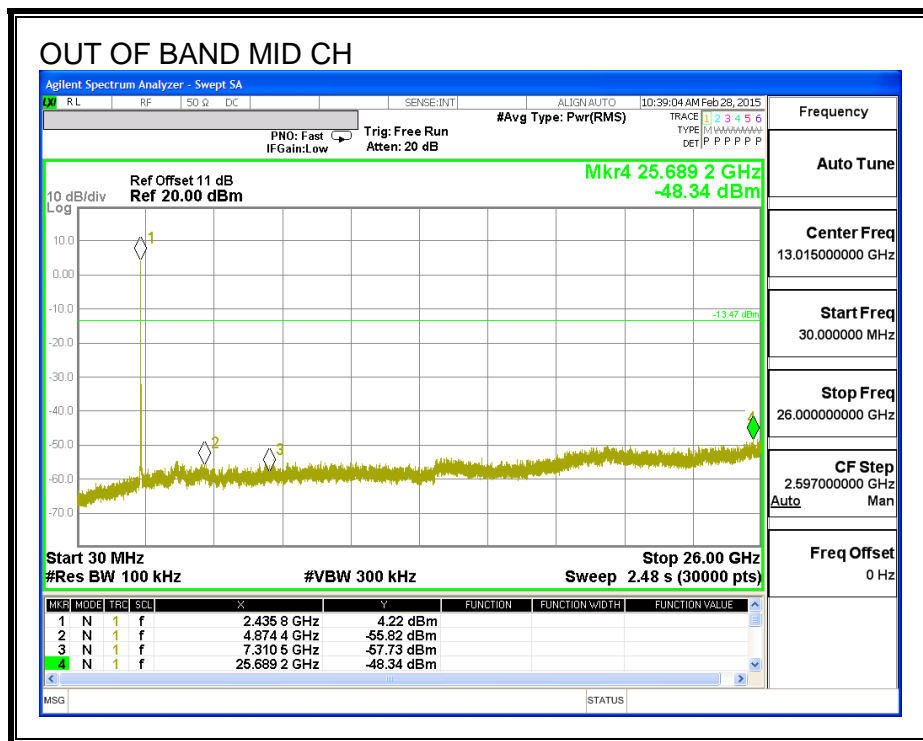
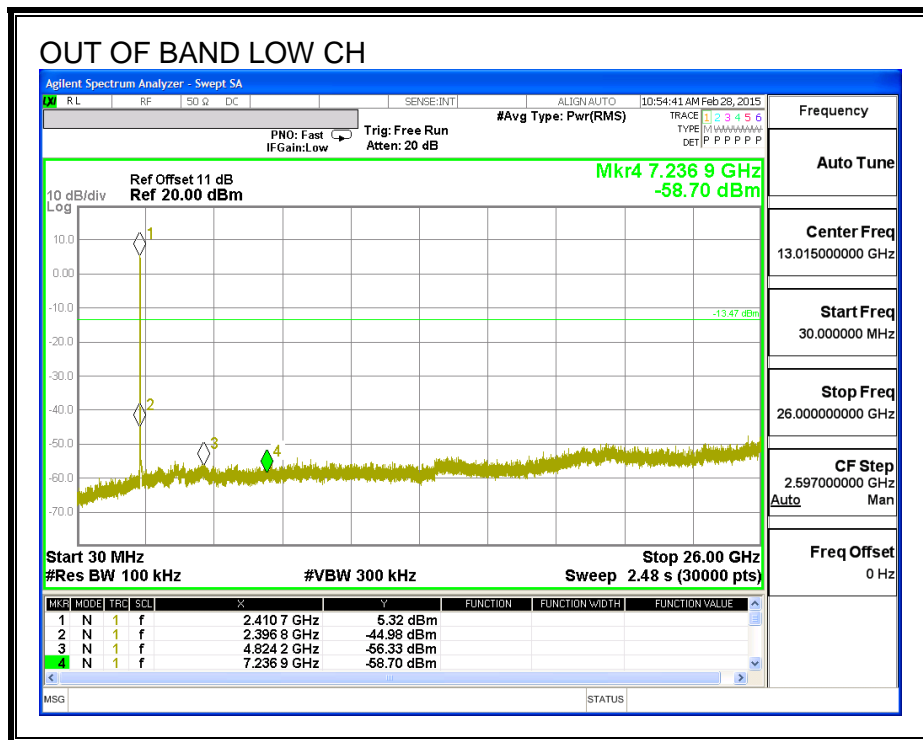

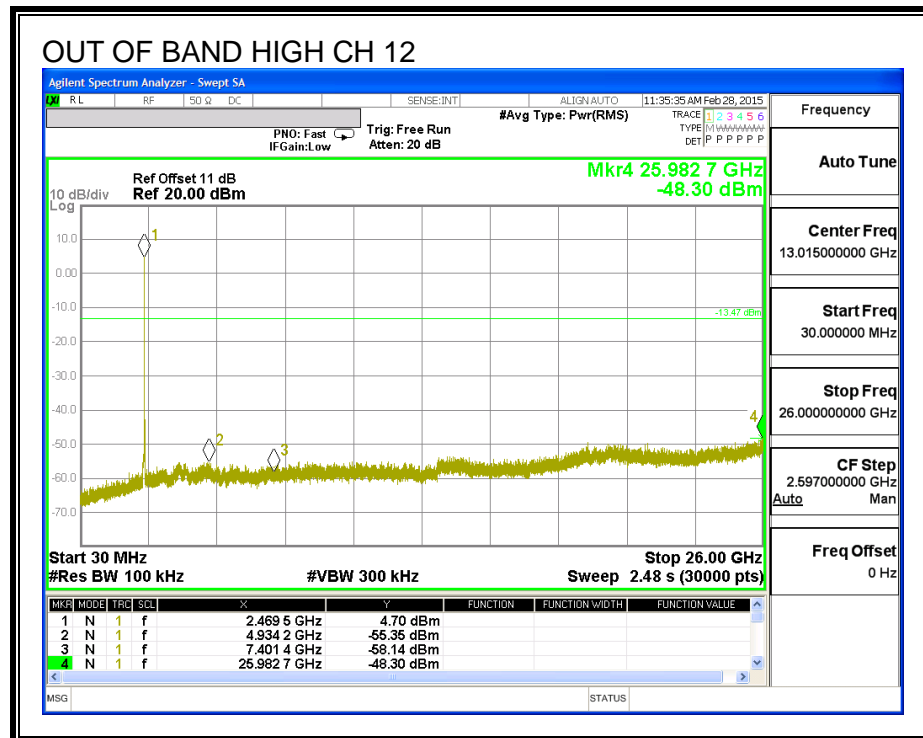
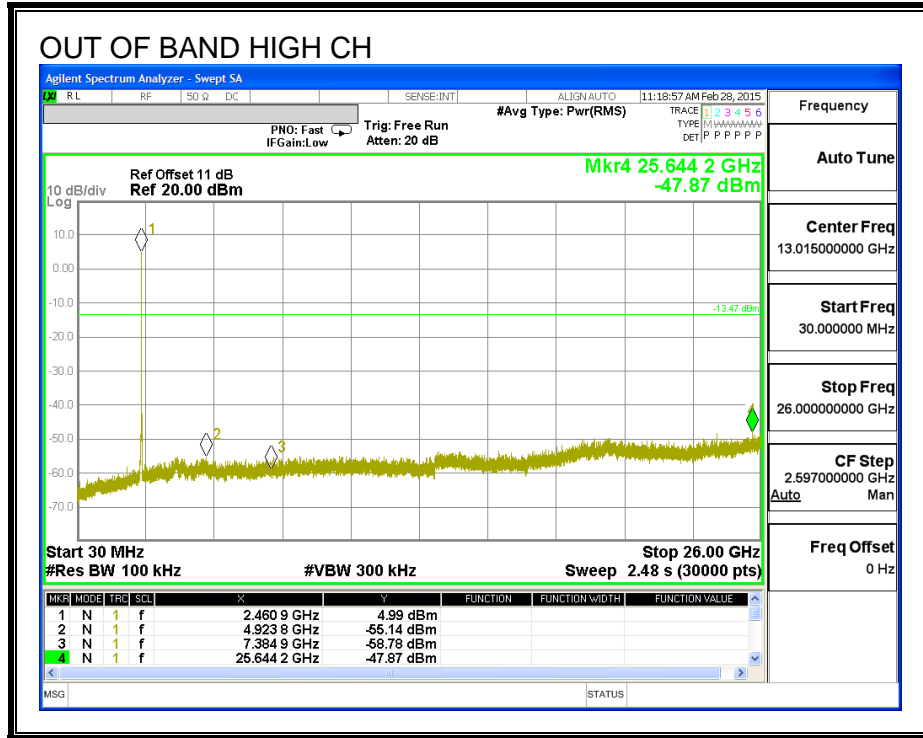



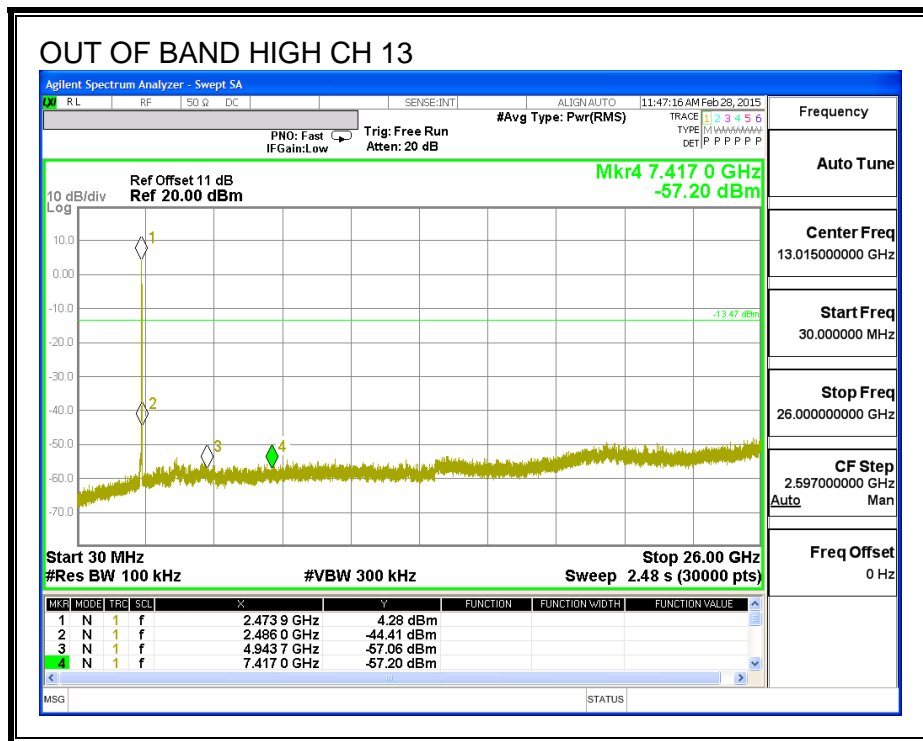

## 8.2. 802.11b SISO MODE IN THE 2.4 GHZ BAND (ANTENNA B)

### 8.2.1. 6 dB BANDWIDTH

#### LIMITS

FCC §15.247 (a) (2)

The minimum 6 dB bandwidth shall be at least 500 kHz.

#### RESULTS

Channel	Frequency (MHz)	6 dB Bandwidth (MHz)	Minimum Limit (MHz)
Low	2412	8.589	0.5
Mid	2437	8.593	0.5
High	2462	8.579	0.5
High	2467	8.579	0.5
High	2472	8.602	0.5

**6 dB BANDWIDTH**

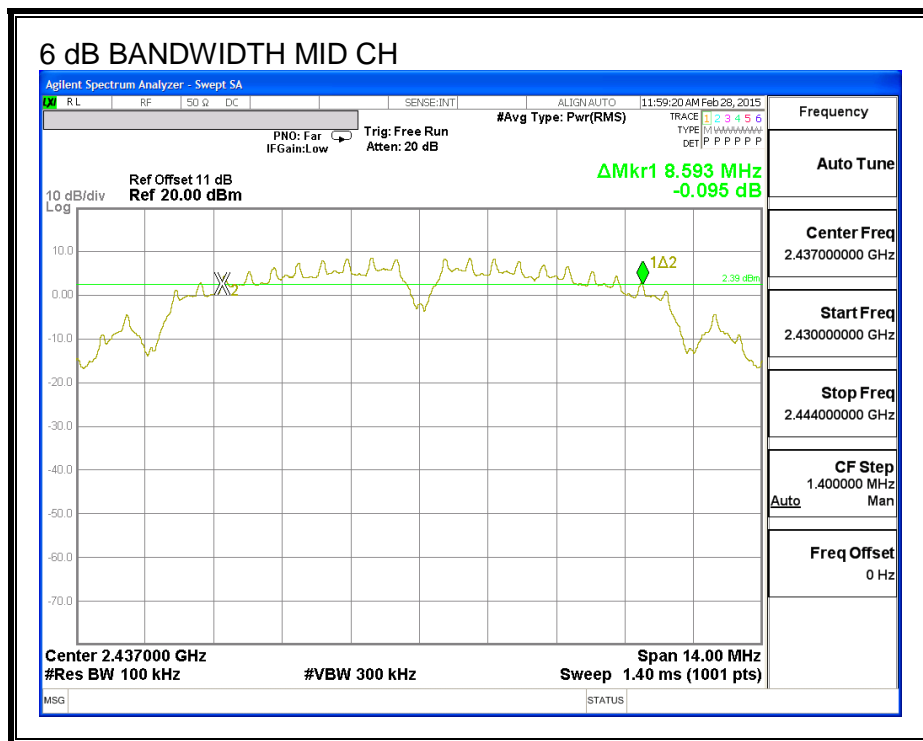
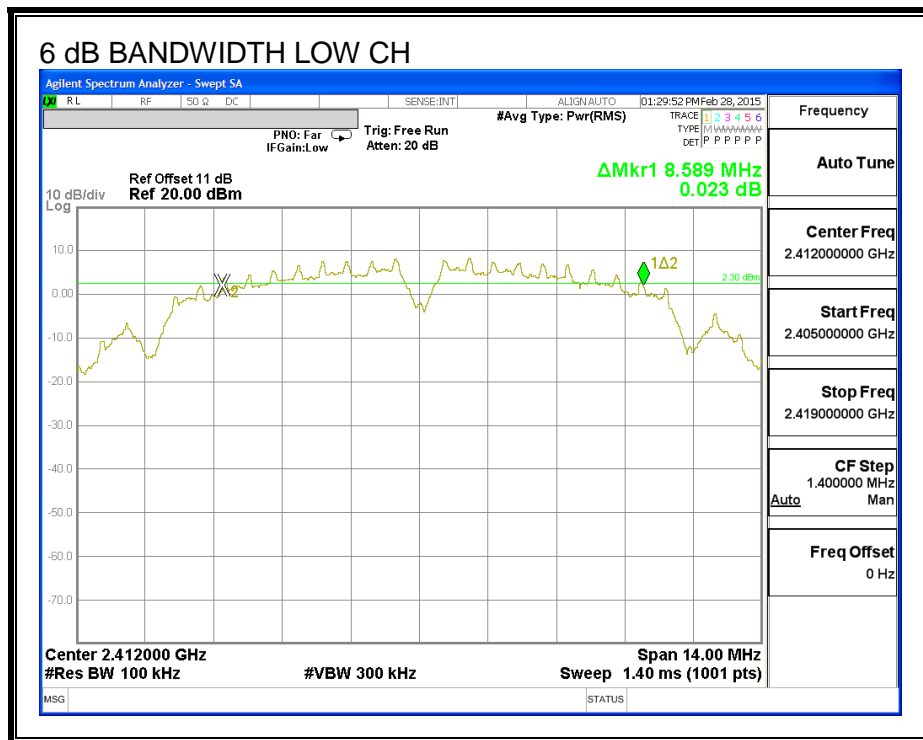

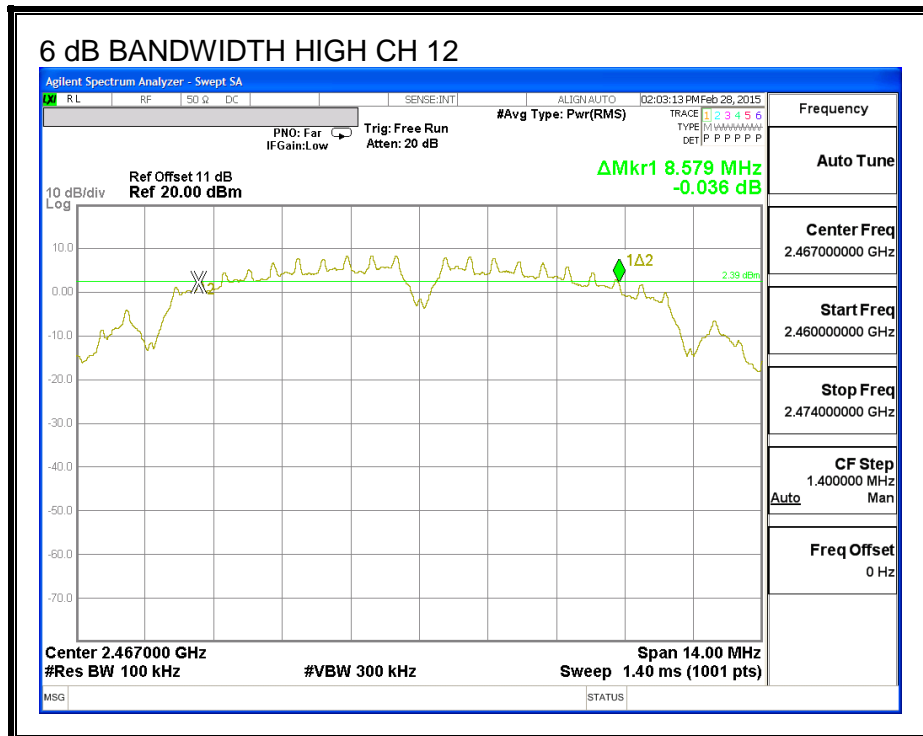
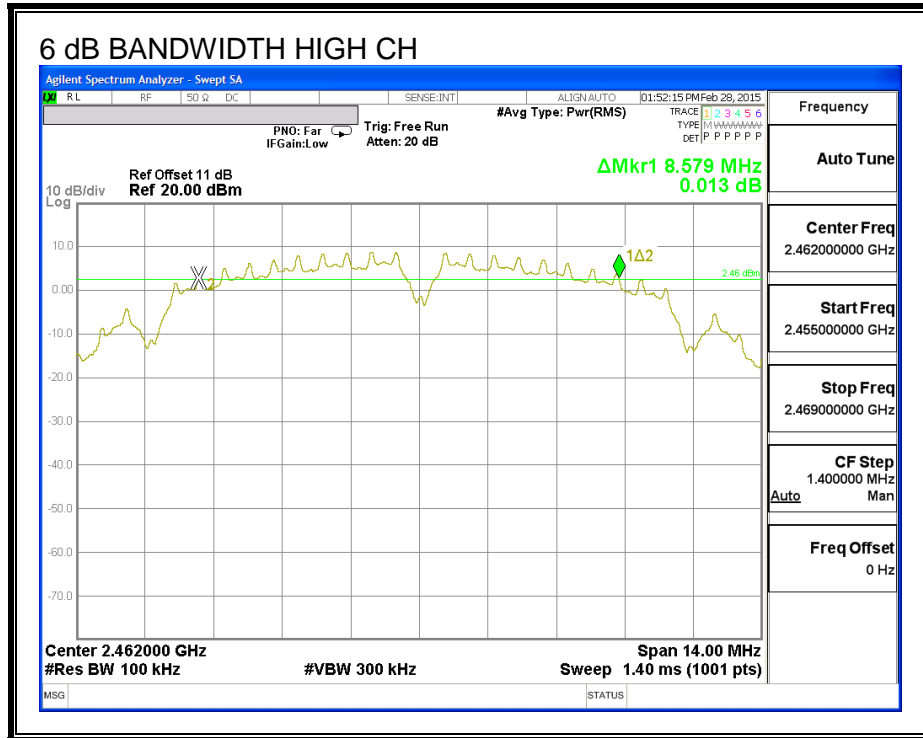

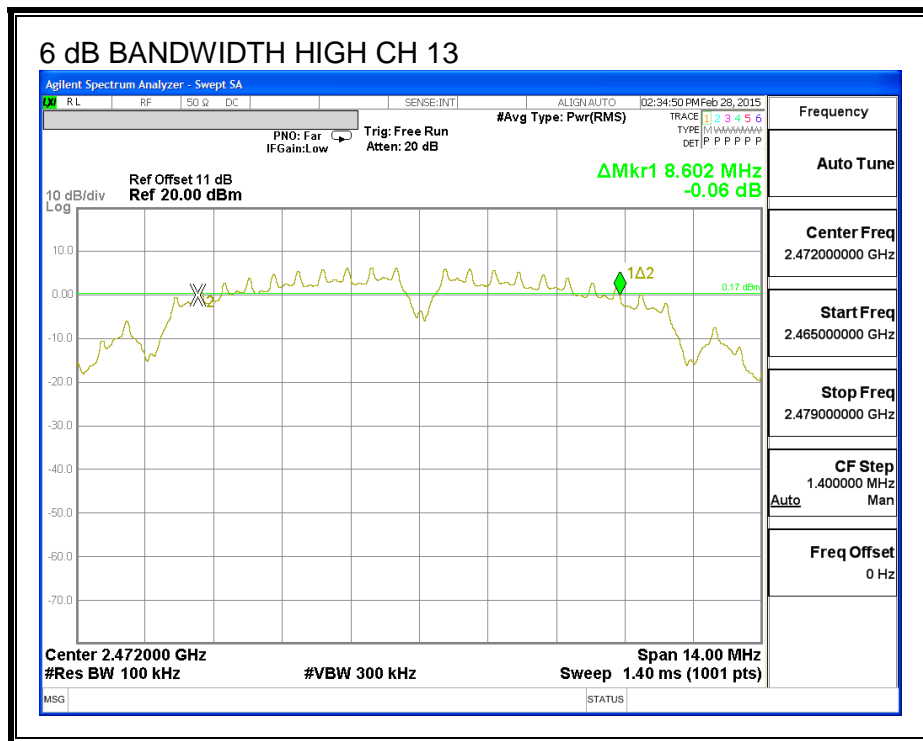

## 8.2.2. 99% BANDWIDTH

### LIMITS

None; for reporting purposes only.

### RESULTS

Channel	Frequency (MHz)	99% Bandwidth (MHz)
Low	2412	11.150
Mid	2437	11.628
High	2462	11.532
High	2467	11.552
High	2472	11.507

**99% BANDWIDTH**

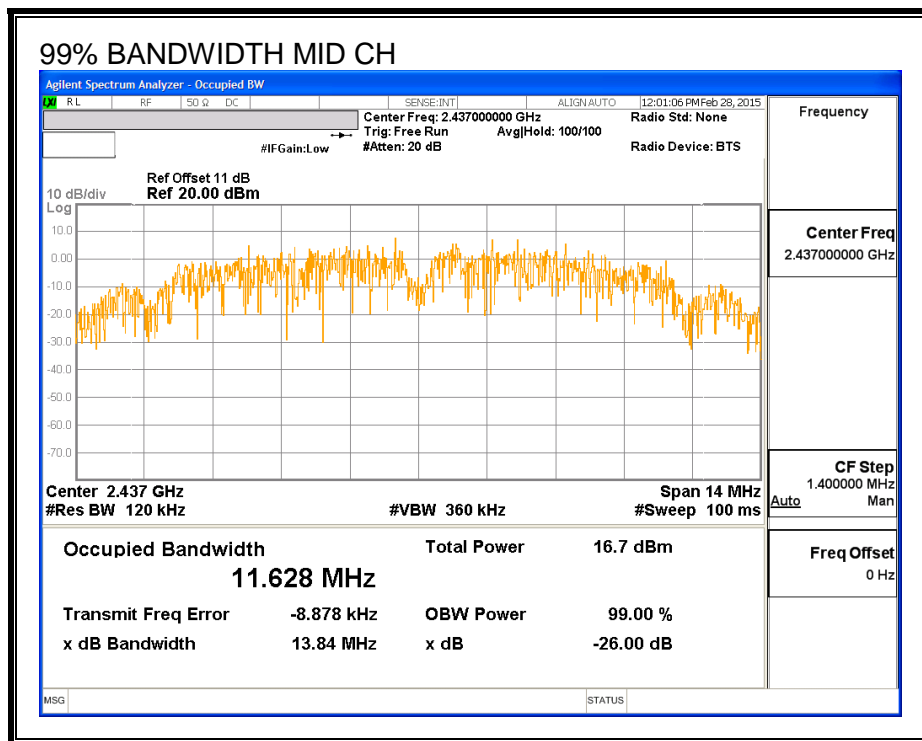
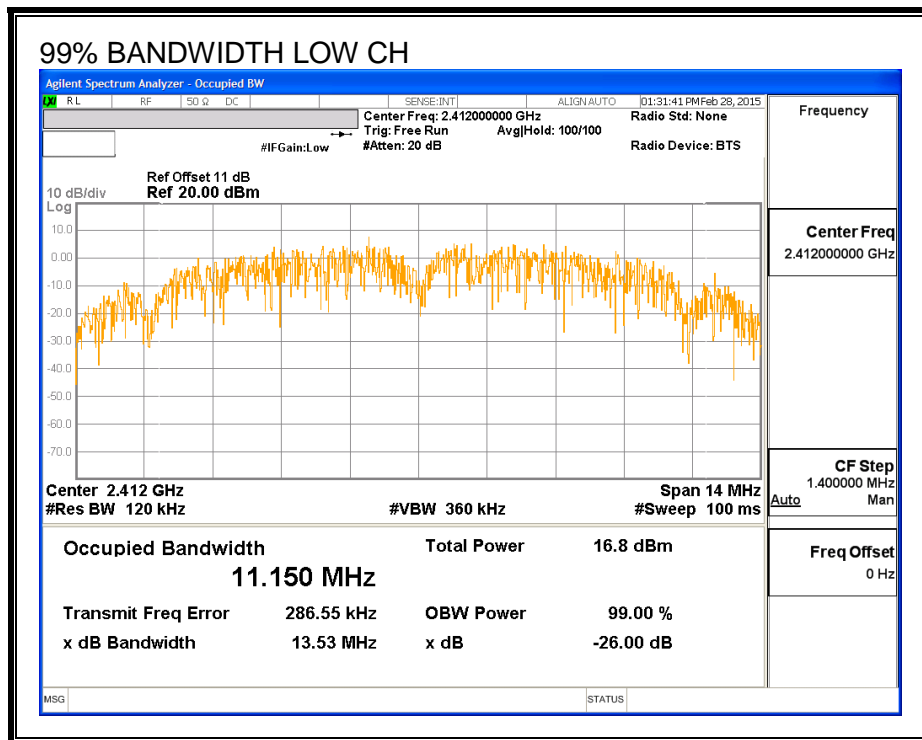

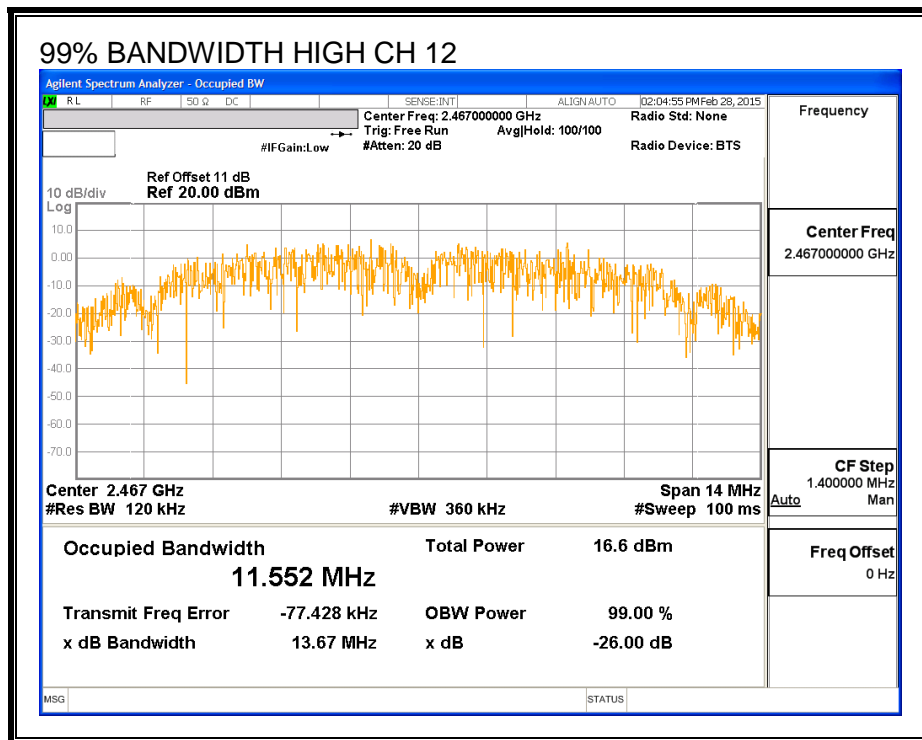
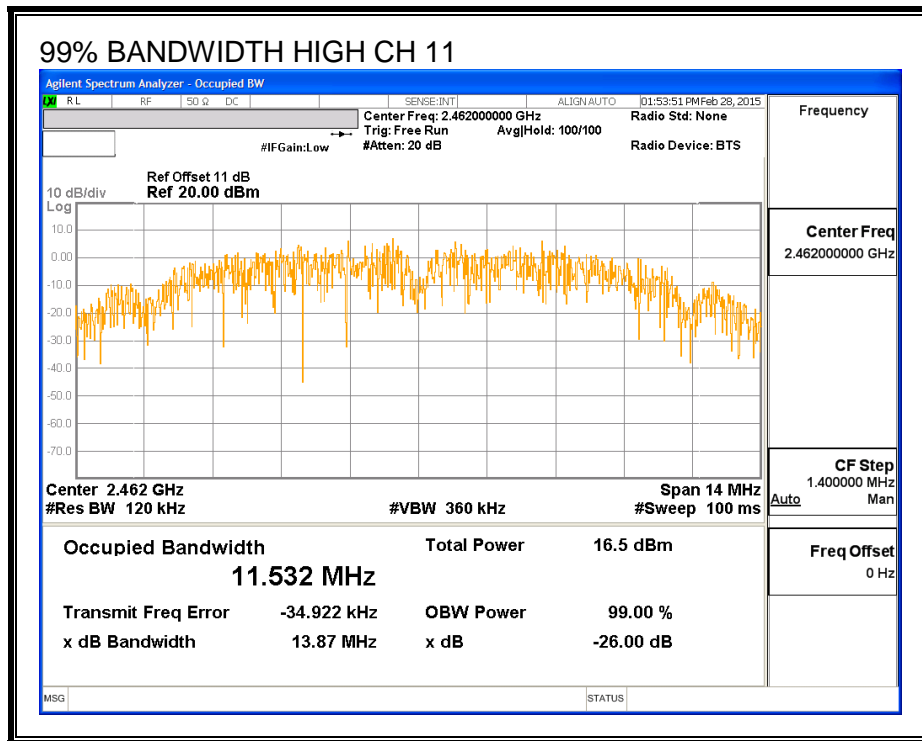



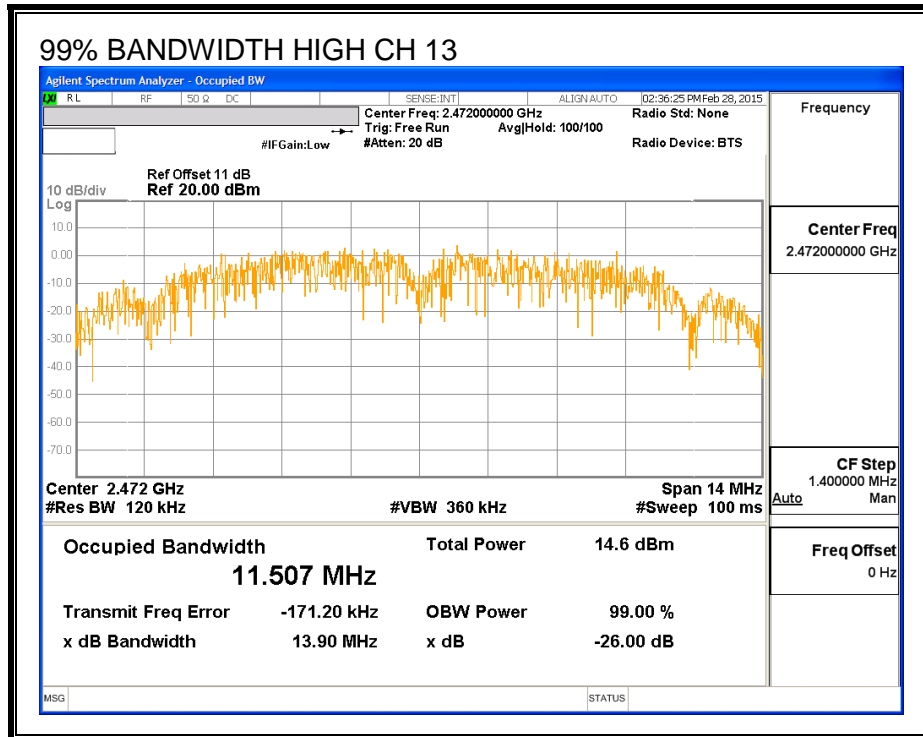

### 8.2.3. AVERAGE POWER

#### LIMITS

None; for reporting purposes only.

#### RESULTS

Channel	Frequency (MHz)	Power (dBm)
Low	2412	16.28
Mid	2437	16.46
High	2462	16.37
High	2467	16.34
High	2472	12.42

---

## 8.2.4. OUTPUT POWER

### LIMITS

FCC §15.247

For systems using digital modulation in the 902–928 MHz, 2400–2483.5 MHz, and 5725–5850 MHz bands: 1 Watt, based on the use of antennas with directional gains that do not exceed 6 dBi. If transmitting antennas of directional gain greater than 6 dBi are used, the conducted output power from the intentional radiator shall be reduced by the amount in dB that the directional gain of the antenna exceeds 6 dBi.

### DIRECTIONAL ANTENNA GAIN

There is only one transmitter output therefore the directional gain is equal to the antenna gain.

**RESULTS**

**Limits**

Channel	Frequency (MHz)	Directional Gain (dBi)	FCC Power Limit (dBm)	IC Power Limit (dBm)	IC EIRP Limit (dBm)	Max Power (dBm)
Low	2412	-1.00	30.00	30	36	30.00
Mid	2437	-1.00	30.00	30	36	30.00
High	2462	-1.00	30.00	30	36	30.00
High	2467	-1.00	30.00	30	36	30.00
High	2472	-1.00	30.00	30	36	30.00

**Results**

Channel	Frequency (MHz)	Antenna B Meas Power (dBm)	Total Corr'd Power (dBm)	Power Limit (dBm)	Margin (dB)
Low	2412	19.08	19.08	30.00	-10.92
Mid	2437	19.36	19.36	30.00	-10.64
High	2462	19.34	19.34	30.00	-10.66
High	2467	19.30	19.30	30.00	-10.70
High	2472	16.05	16.05	30.00	-13.95

### 8.2.5. PSD

#### LIMITS

FCC §15.247

#### RESULTS

Channel	Frequency (MHz)	Antenna B Meas (dBm)	Limit (dBm)	Margin (dB)
Low	2412	-5.45	8.0	-13.5
Mid	2437	-4.60	8.0	-12.6
High	2462	-5.71	8.0	-13.7
High	2467	-5.96	8.0	-14.0
High	2472	-9.51	8.0	-17.5

PSD

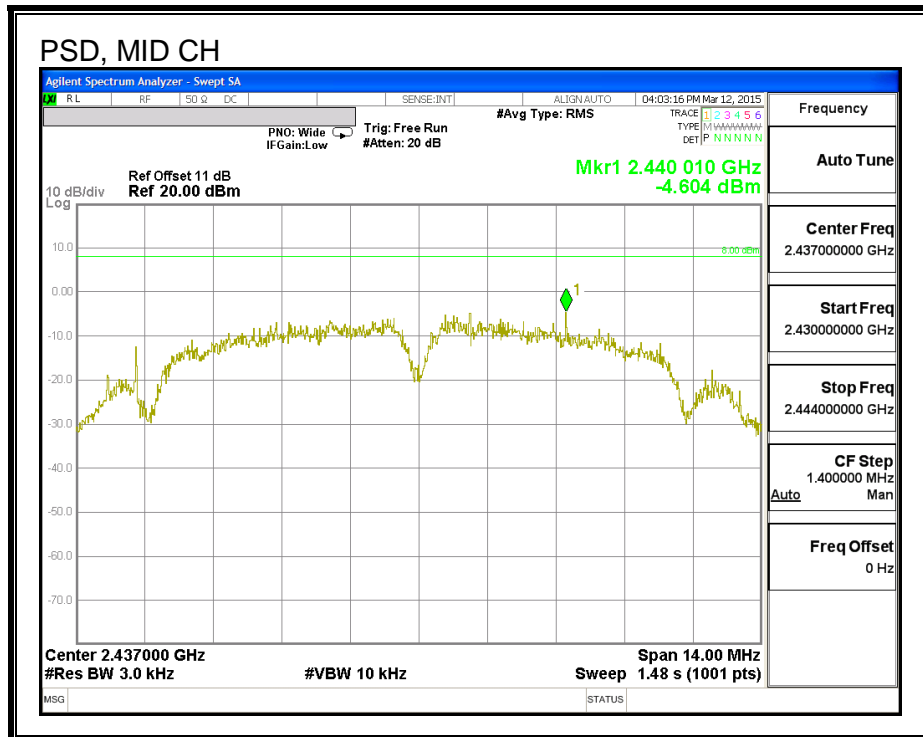
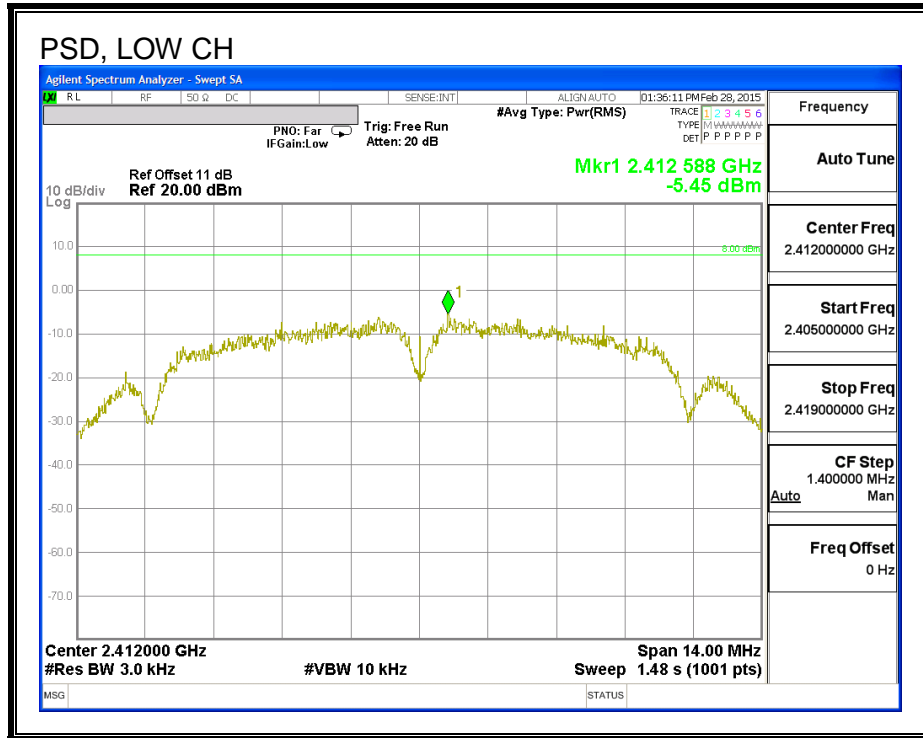

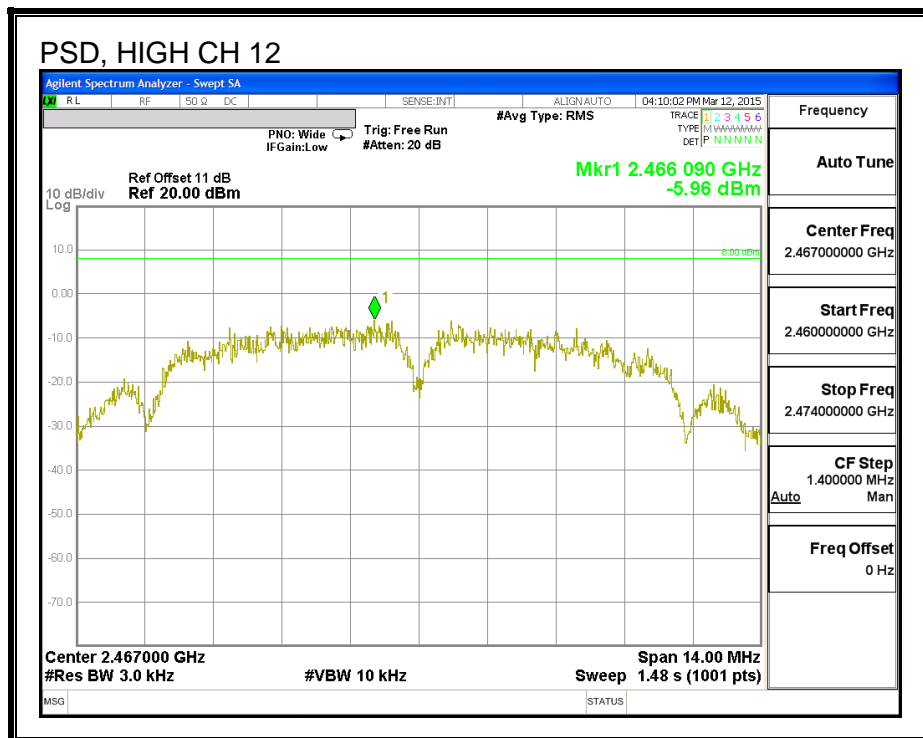
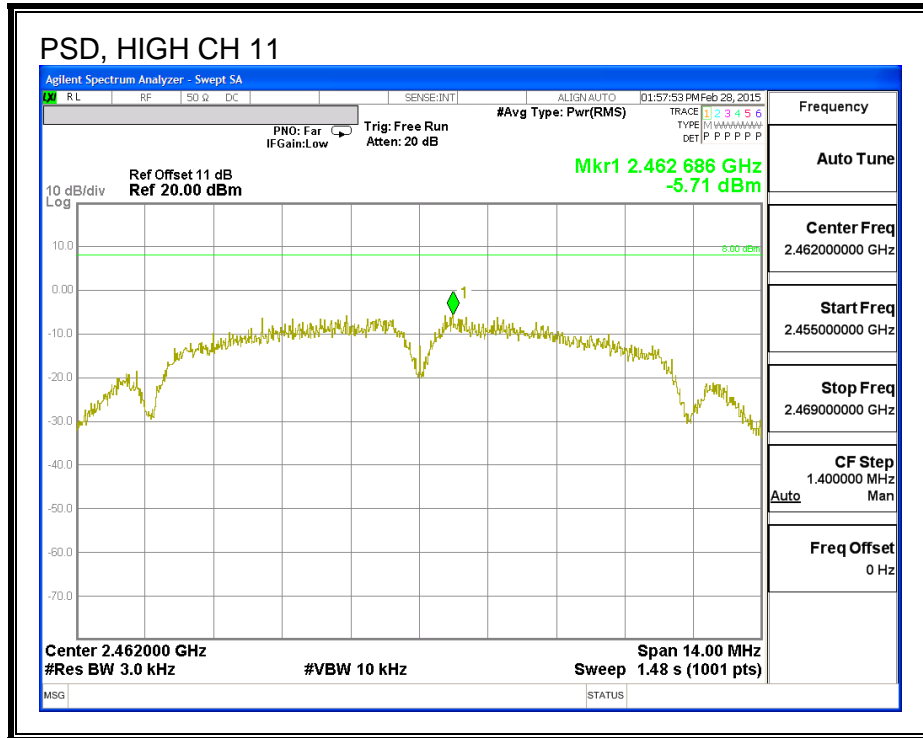

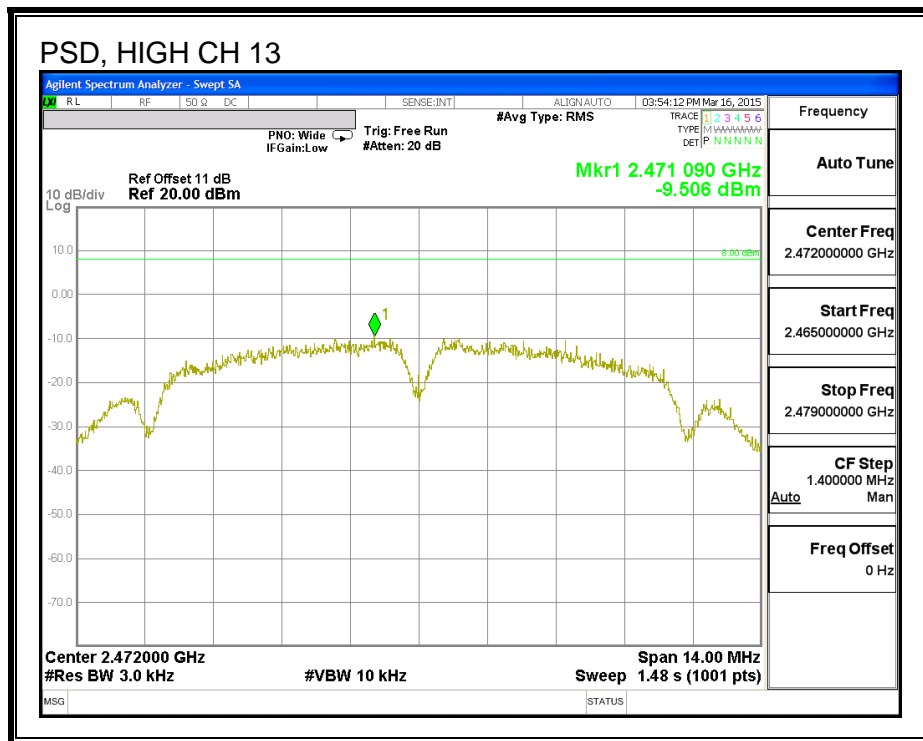



## 8.2.6. OUT-OF-BAND EMISSIONS

### LIMITS

FCC §15.247 (d)

In any 100 kHz bandwidth outside the frequency band in which the spread spectrum or digitally modulated intentional radiator is operating, the radio frequency power that is produced by the intentional radiator shall be at least 20 dB below that in the 100 kHz bandwidth within the band that contains the highest level of the desired power, based on either an RF conducted or a radiated measurement, provided the transmitter demonstrates compliance with the peak conducted power limits. If the transmitter complies with the conducted power limits based on the use of RMS averaging over a time interval, as permitted under paragraph (b)(3) of this section, the attenuation required under this paragraph shall be 30 dB instead of 20 dB. Attenuation below the general limits specified in §15.209(a) is not required.

**RESULTS**

**IN-BAND REFERENCE LEVEL**

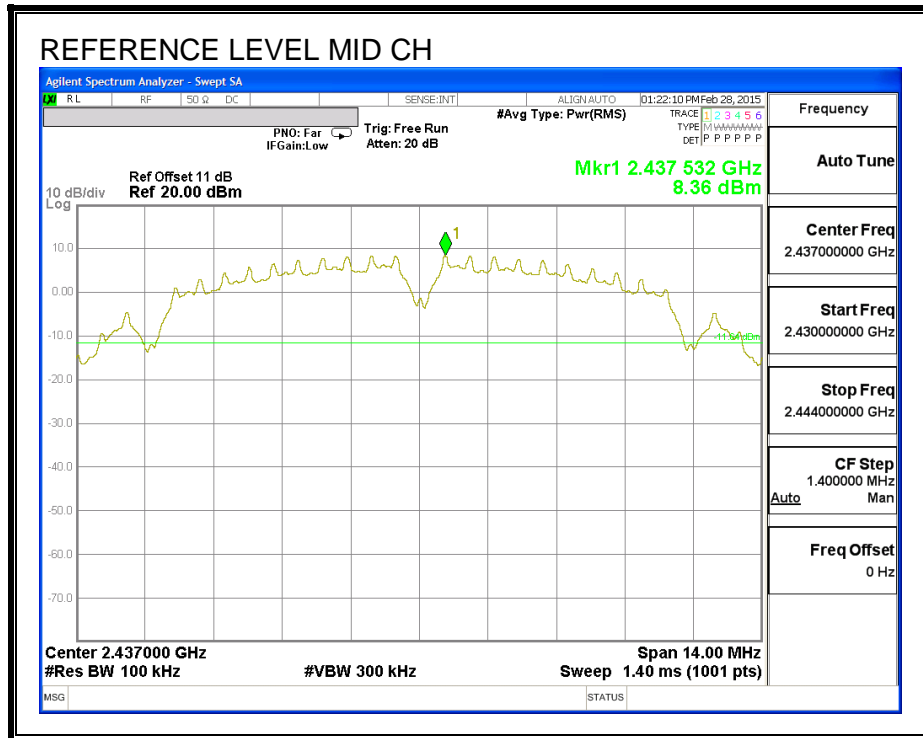

**LOW CHANNEL BANDEGE**

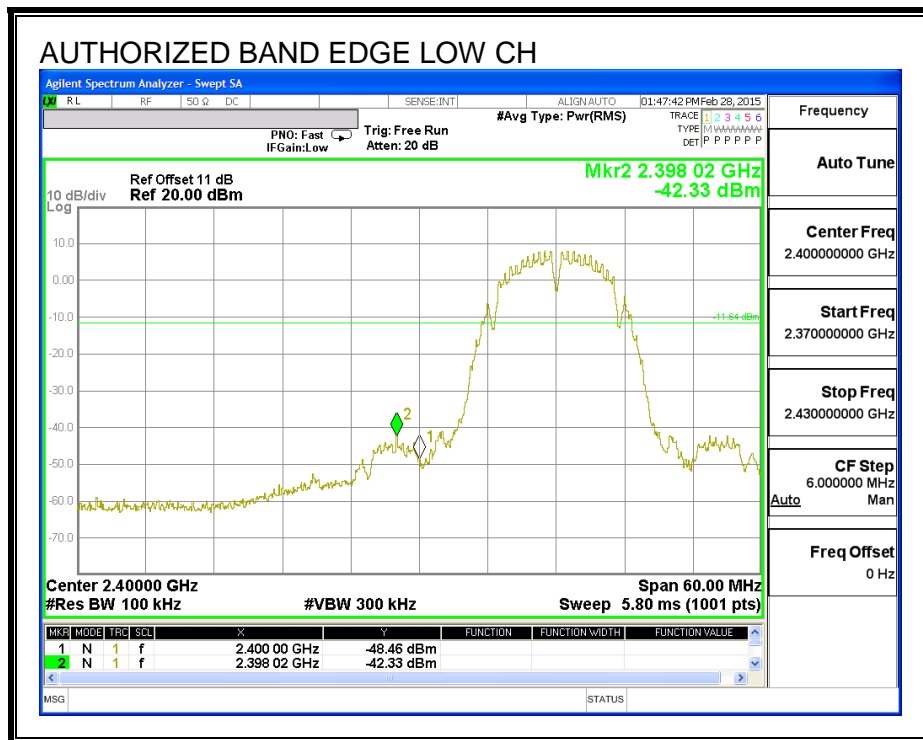

**HIGH CHANNEL BANDEGE**

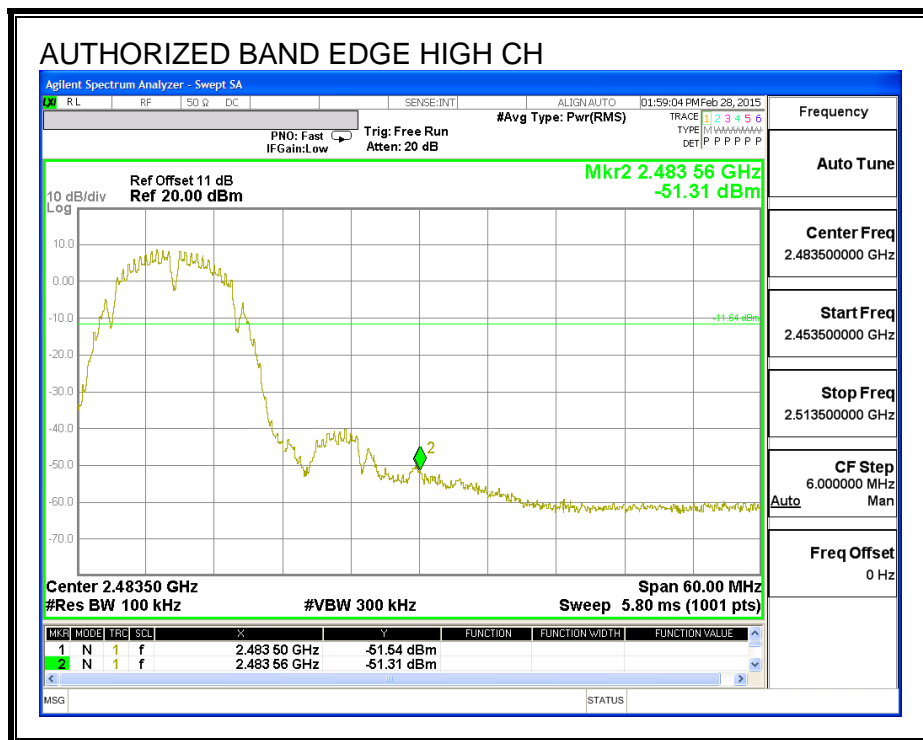

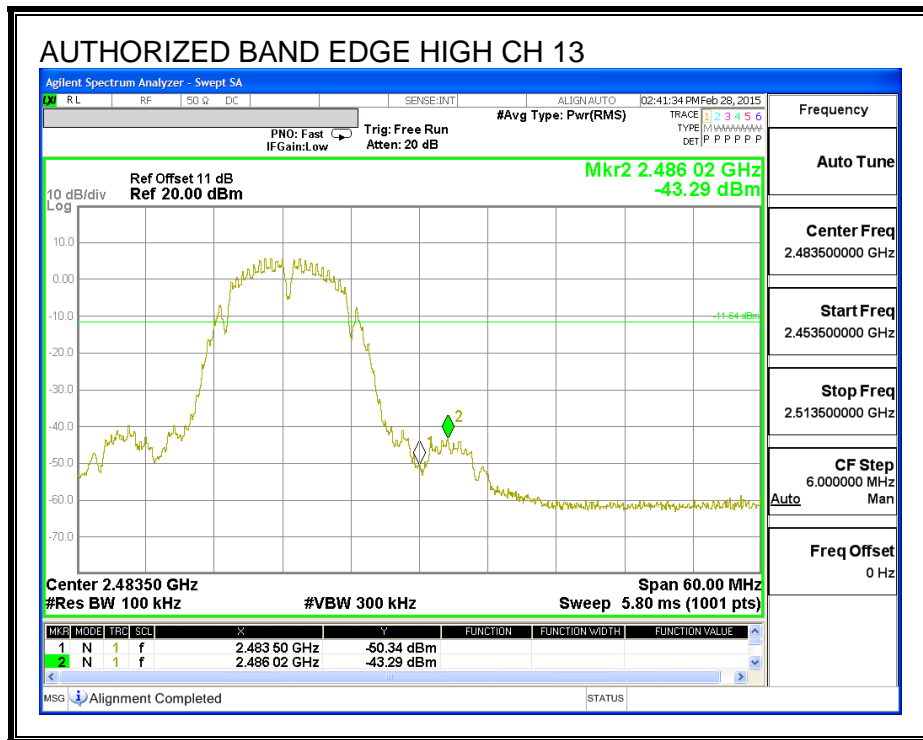
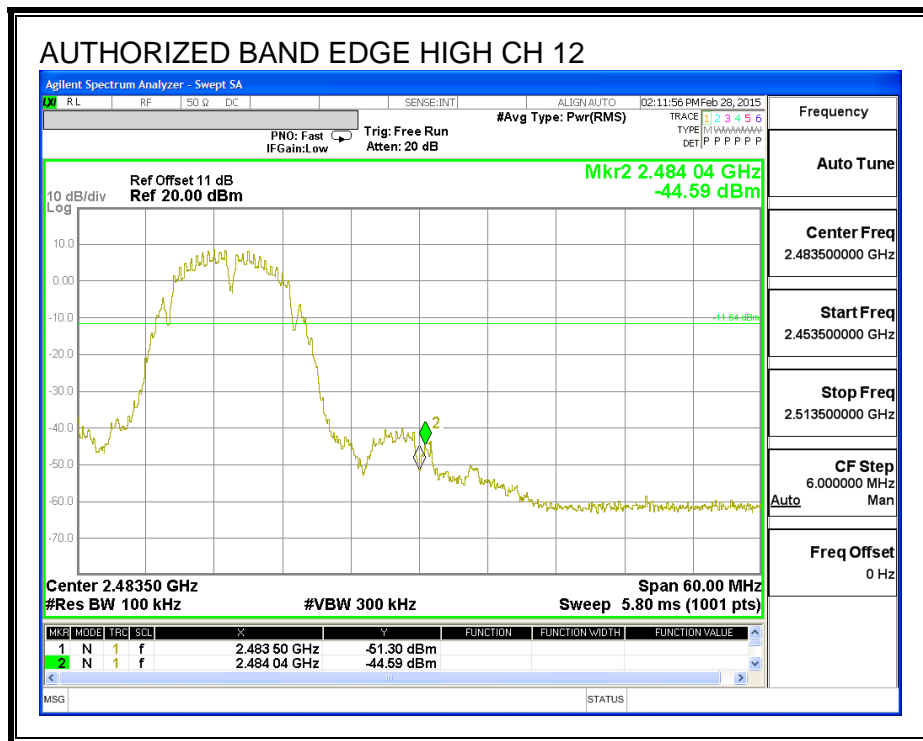

**OUT-OF-BAND EMISSIONS**

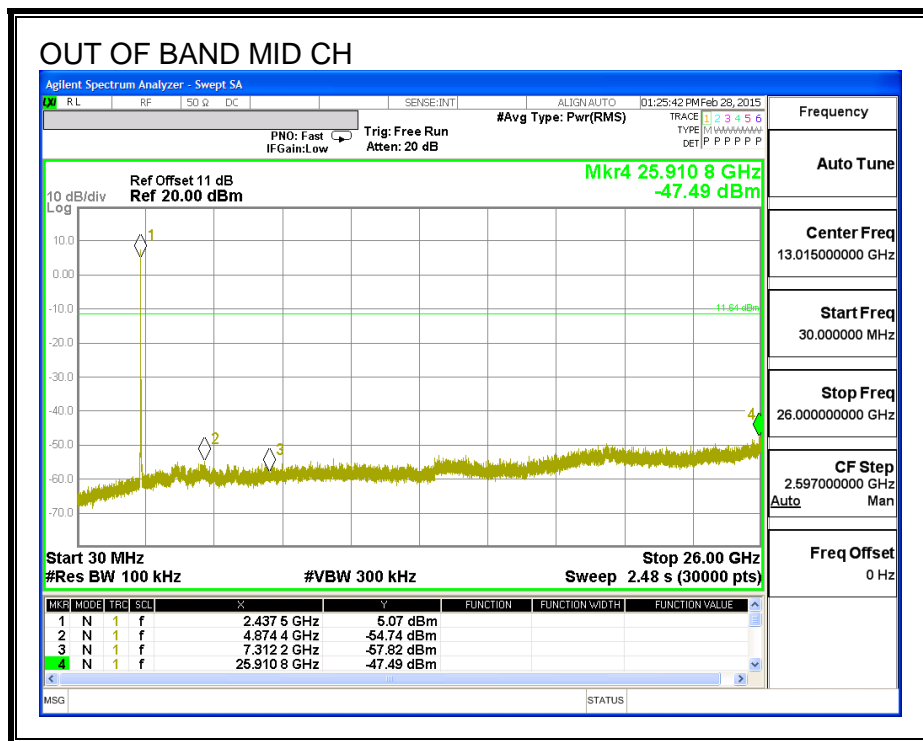
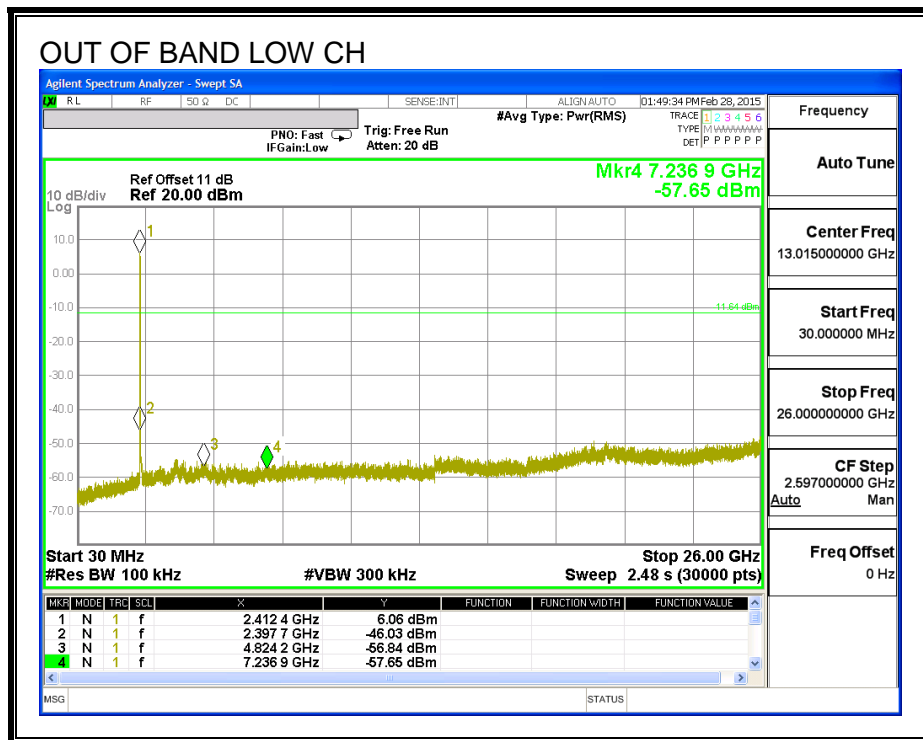

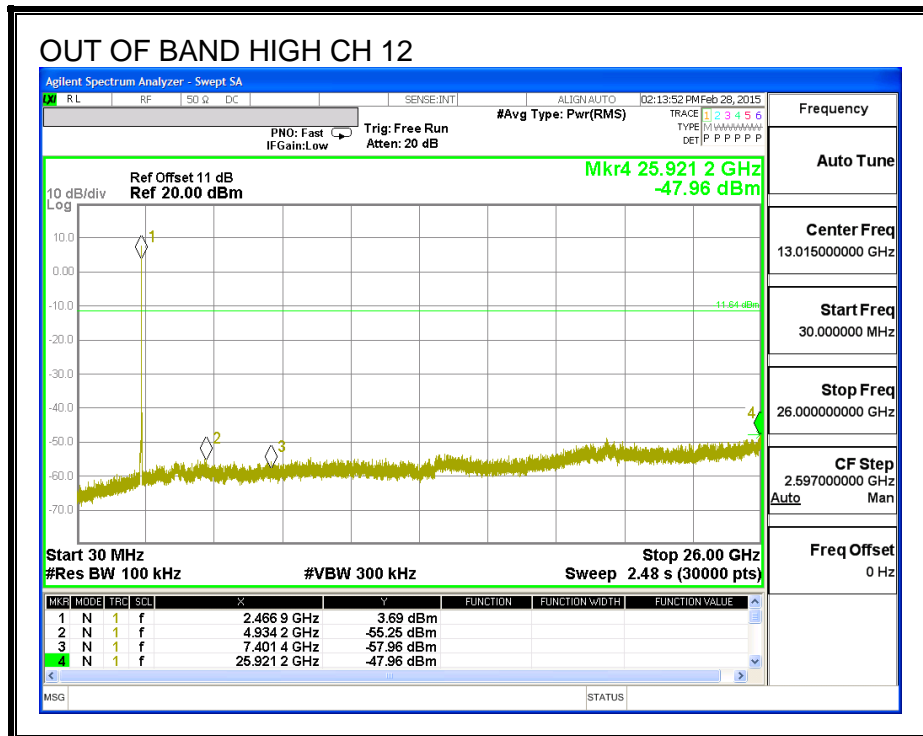
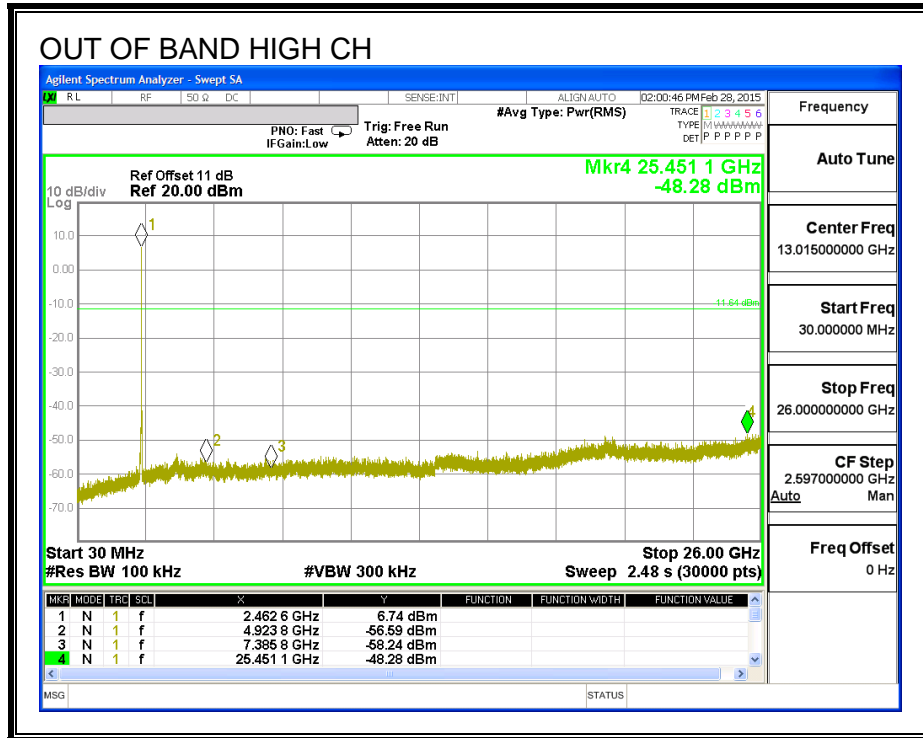

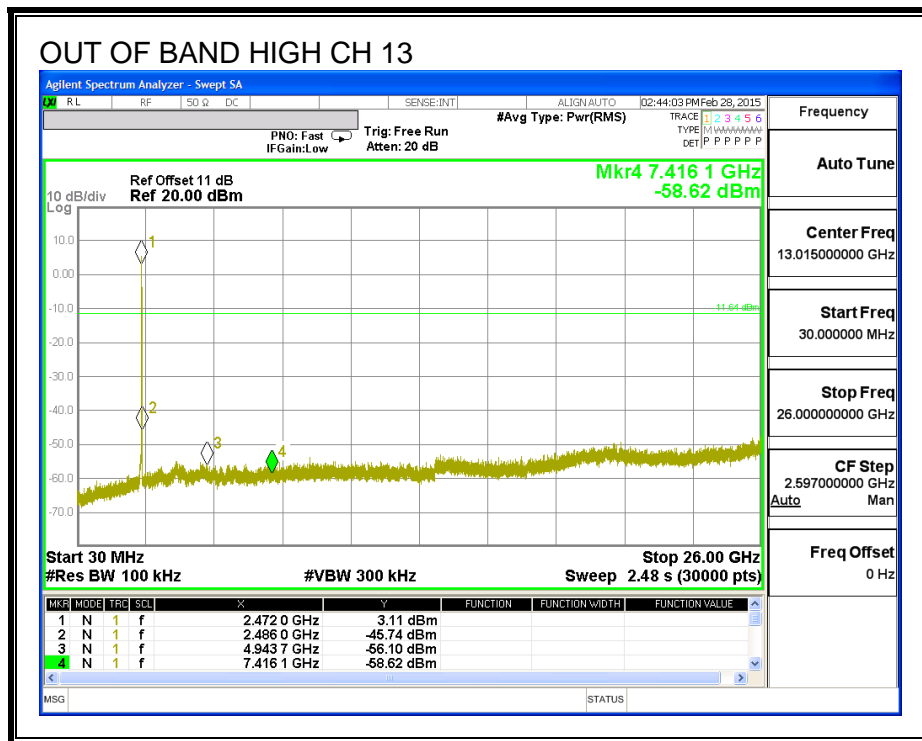

### 8.3. 802.11b SISO MODE IN THE 2.4 GHz BAND (ANTENNA D)

#### 8.3.1. 6 dB BANDWIDTH

##### LIMITS

FCC §15.247 (a) (2)

The minimum 6 dB bandwidth shall be at least 500 kHz.

##### RESULTS

Channel	Frequency (MHz)	6 dB Bandwidth (MHz)	Minimum Limit (MHz)
Low	2412	8.599	0.5
Mid	2437	9.077	0.5
High	2462	9.055	0.5
High	2467	9.058	0.5
High	2472	8.603	0.5



**6 dB BANDWIDTH**

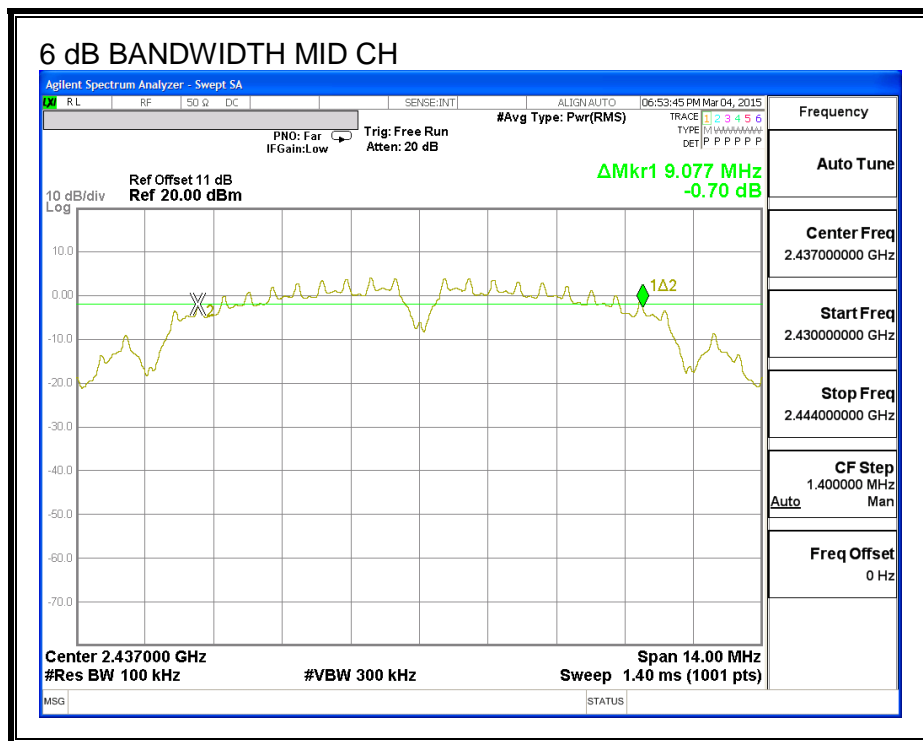
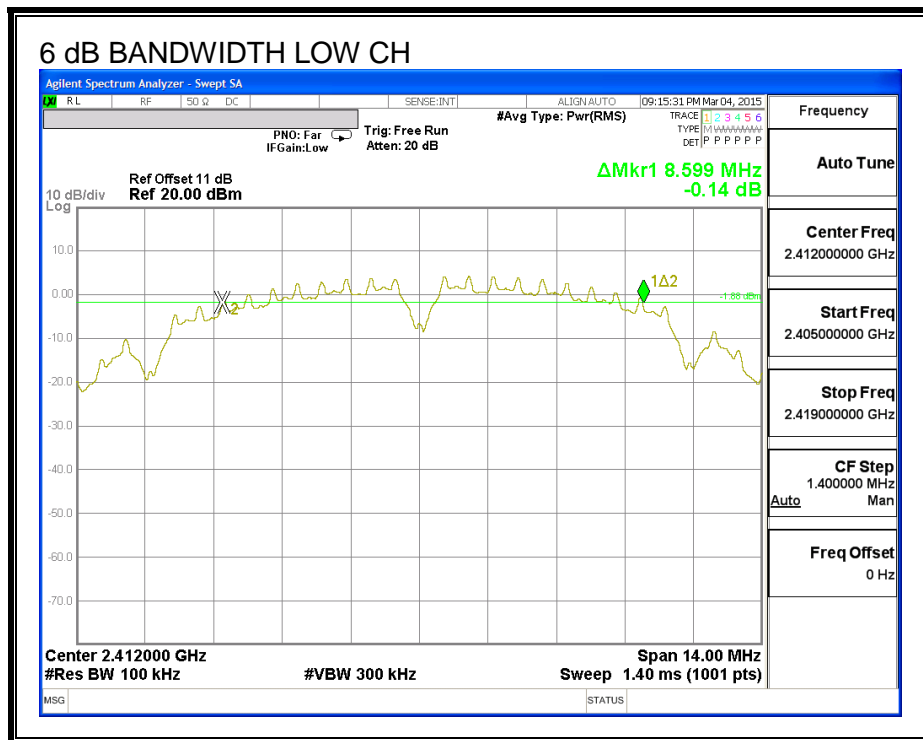

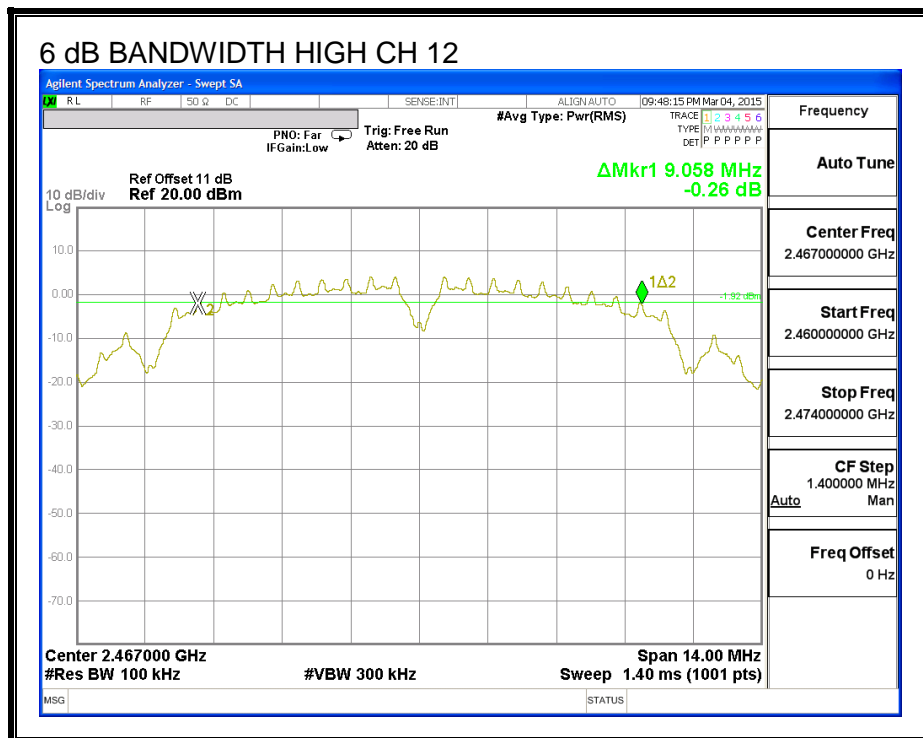
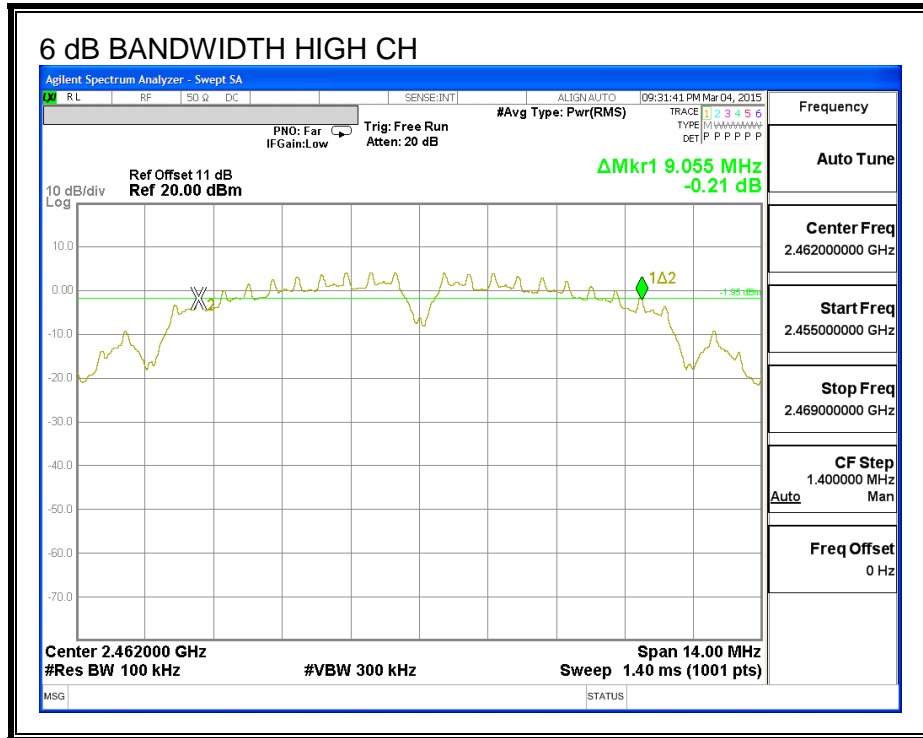

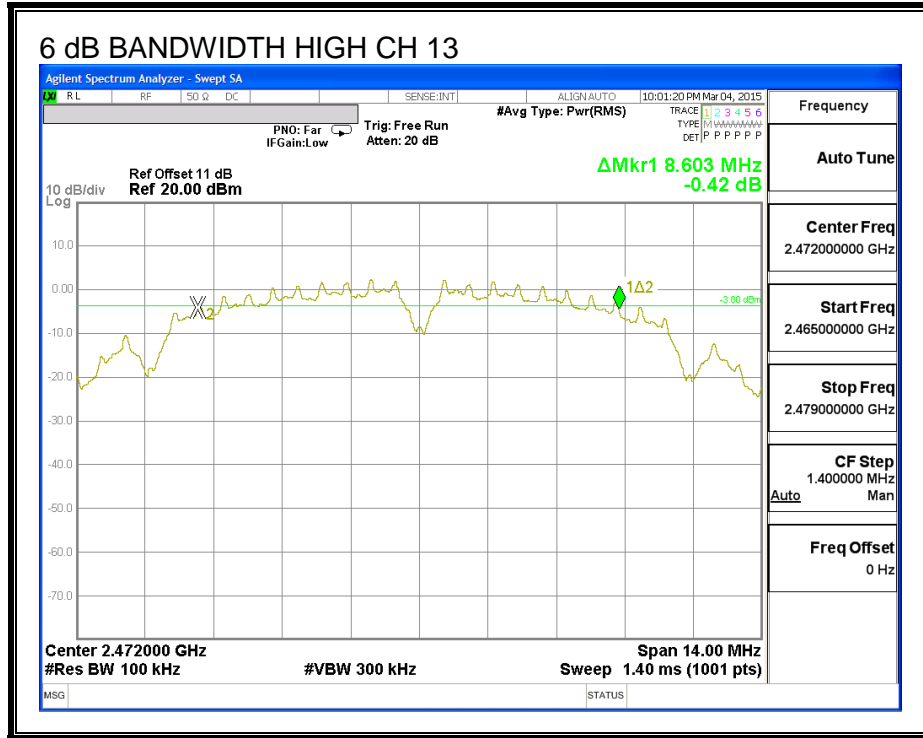

### 8.3.2. 99% BANDWIDTH

#### LIMITS

None; for reporting purposes only.

#### RESULTS

Channel	Frequency (MHz)	99% Bandwidth (MHz)
Low	2412	11.259
Mid	2437	11.150
High	2462	11.534
High	2467	11.714
High	2472	11.219

**99% BANDWIDTH**

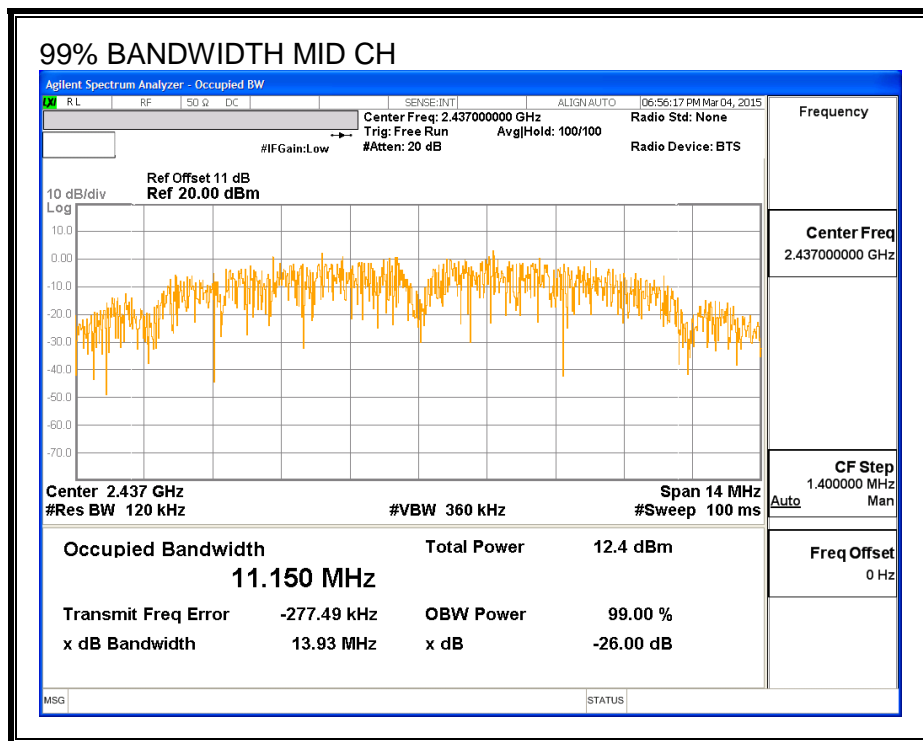
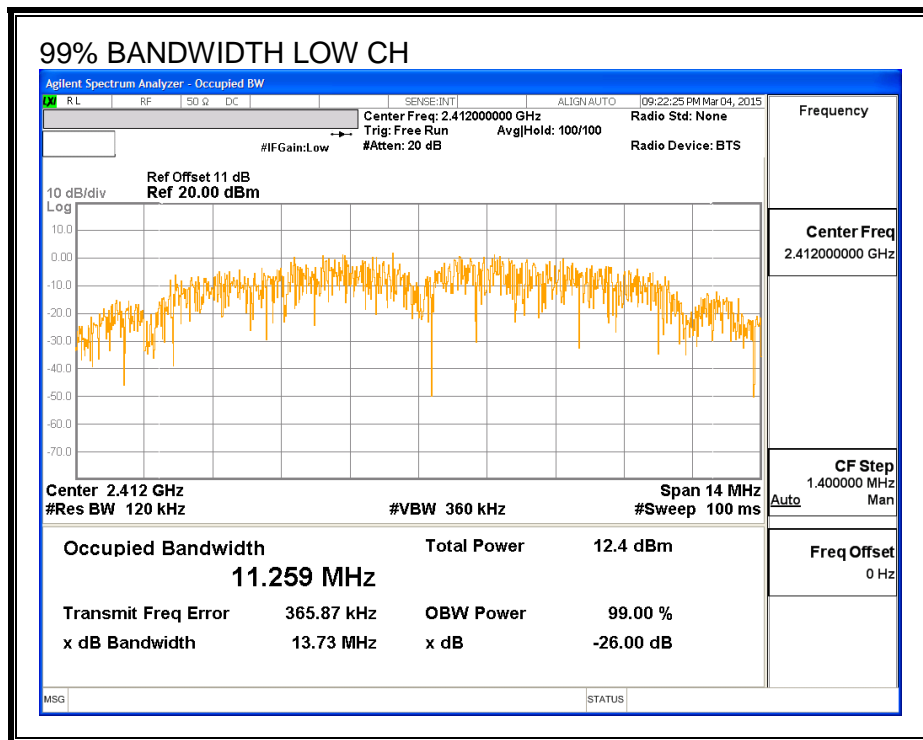

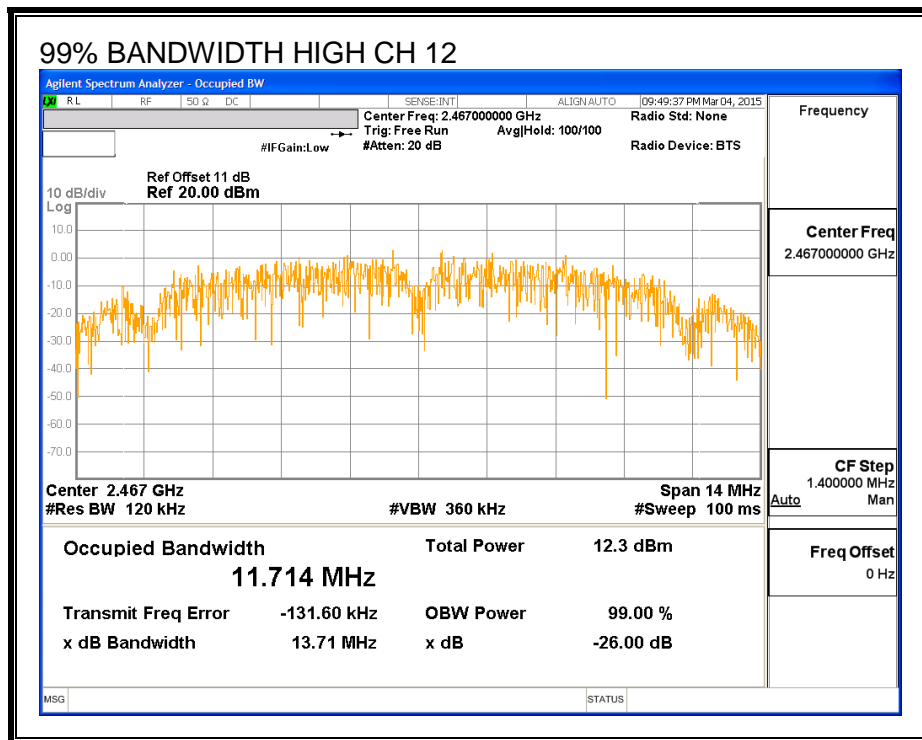
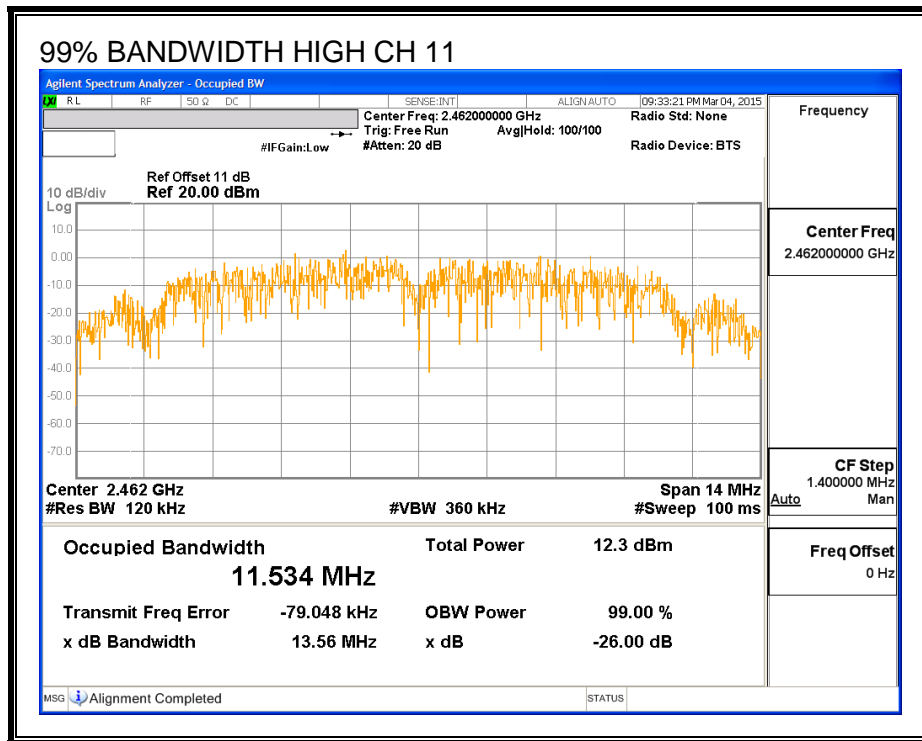

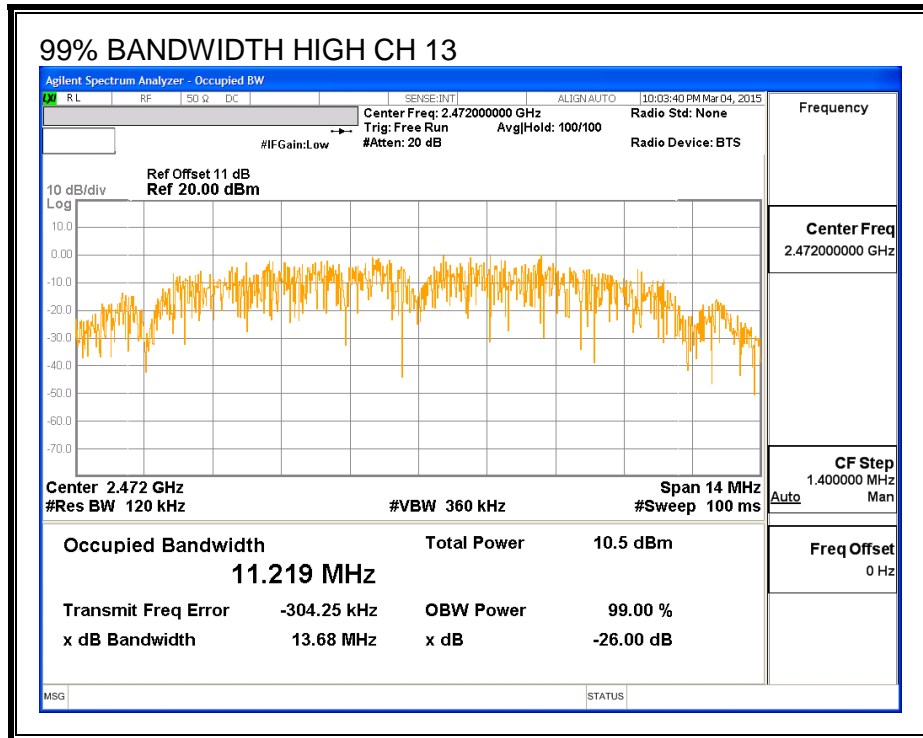

### 8.3.3. AVERAGE POWER

#### LIMITS

None; for reporting purposes only.

#### RESULTS

Channel	Frequency (MHz)	Power (dBm)
Low	2412	12.34
Mid	2437	12.50
High	2462	12.43
High	2467	12.42
High	2472	10.41



---

### **8.3.4. OUTPUT POWER**

#### **LIMITS**

FCC §15.247

For systems using digital modulation in the 902–928 MHz, 2400–2483.5 MHz, and 5725–5850 MHz bands: 1 Watt, based on the use of antennas with directional gains that do not exceed 6 dBi. If transmitting antennas of directional gain greater than 6 dBi are used, the conducted output power from the intentional radiator shall be reduced by the amount in dB that the directional gain of the antenna exceeds 6 dBi.

#### **DIRECTIONAL ANTENNA GAIN**

There is only one transmitter output therefore the directional gain is equal to the antenna gain.

**RESULTS**

**Limits**

Channel	Frequency (MHz)	Directional Gain (dBi)	FCC Power Limit (dBm)	IC Power Limit (dBm)	IC EIRP Limit (dBm)	Max Power (dBm)
Low	2412	2.50	30.00	30	36	30.00
Mid	2437	2.50	30.00	30	36	30.00
High	2462	2.50	30.00	30	36	30.00
High	2467	2.50	30.00	30	36	30.00
High	2472	2.50	30.00	30	36	30.00

**Results**

Channel	Frequency (MHz)	Antenna D Meas Power (dBm)	Total Corr'd Power (dBm)	Power Limit (dBm)	Margin (dB)
Low	2412	14.74	14.74	30.00	-15.26
Mid	2437	14.93	14.93	30.00	-15.07
High	2462	14.92	14.92	30.00	-15.08
High	2467	14.95	14.95	30.00	-15.05
High	2472	13.04	13.04	30.00	-16.96

### 8.3.5. PSD

#### LIMITS

FCC §15.247

#### RESULTS

##### PSD Results

Channel	Frequency (MHz)	Antenna D Meas (dBm)	Limit (dBm)	Margin (dB)
Low	2412	-10.49	8.0	-18.5
Mid	2437	-9.77	8.0	-17.8
High	2462	-9.75	8.0	-17.8
High	2467	-9.71	8.0	-17.7
High	2472	-11.62	8.0	-19.6

PSD

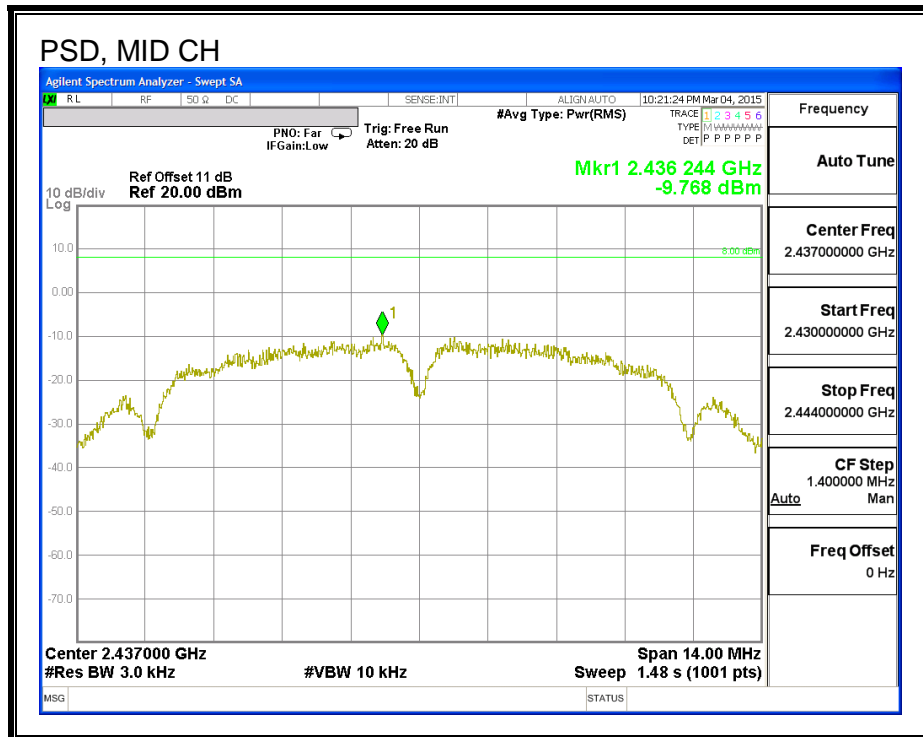
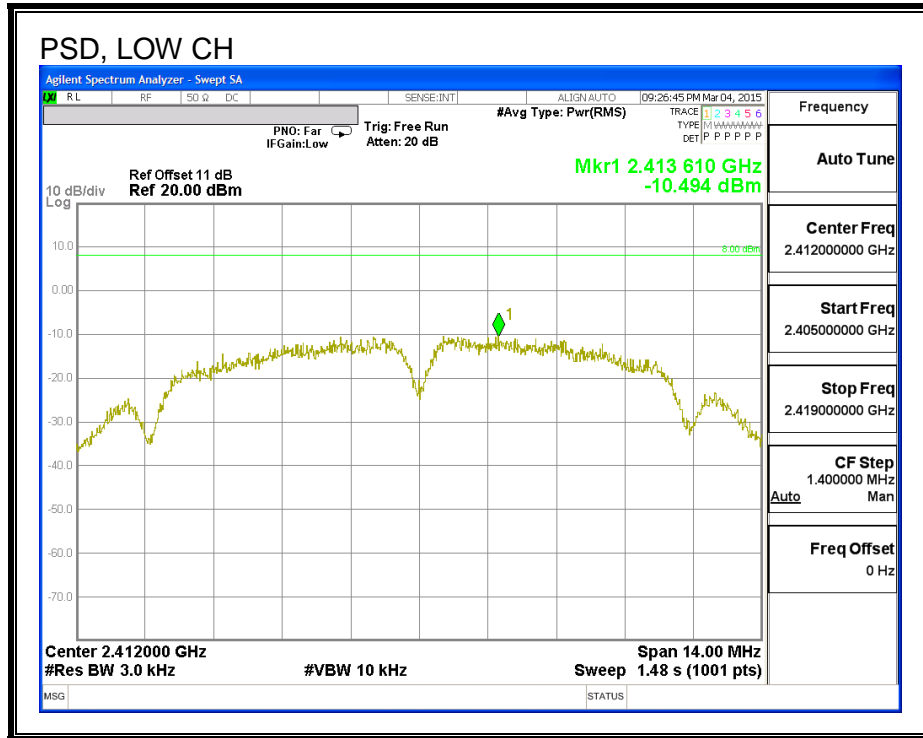

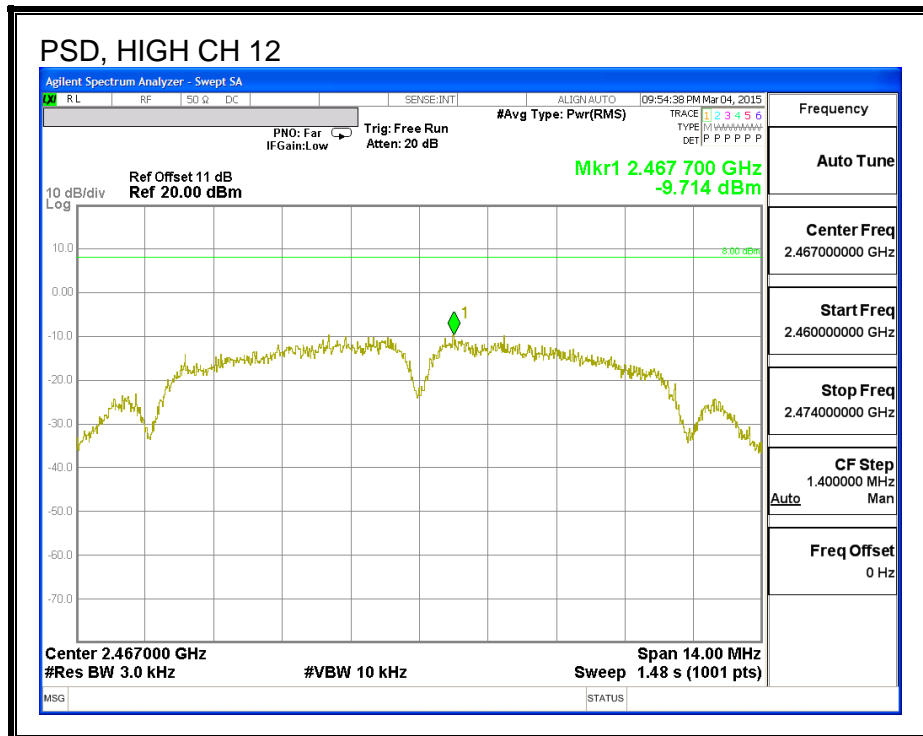
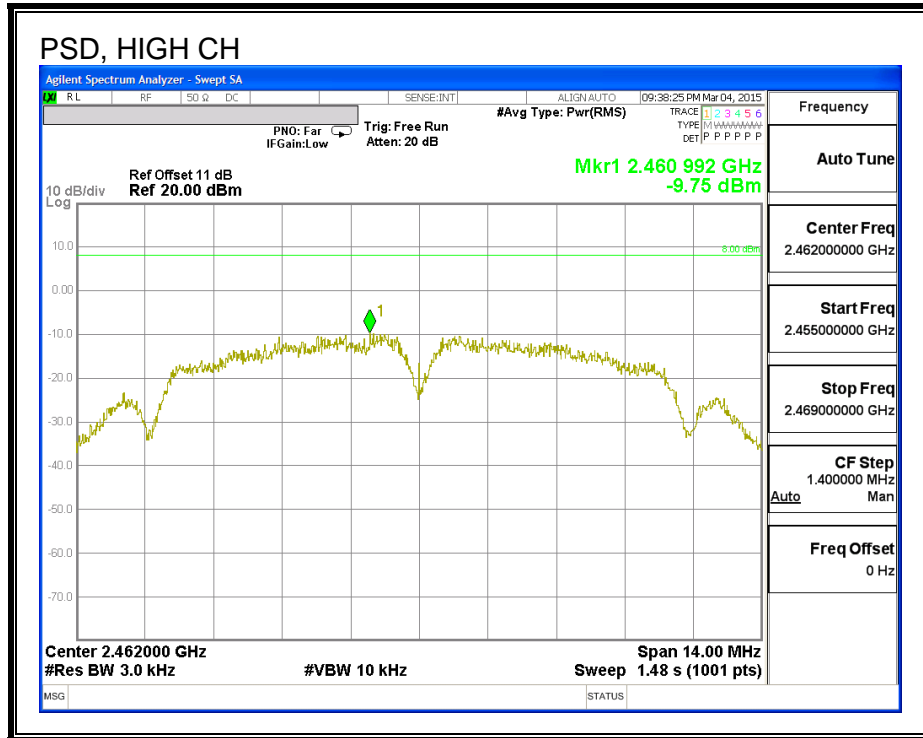

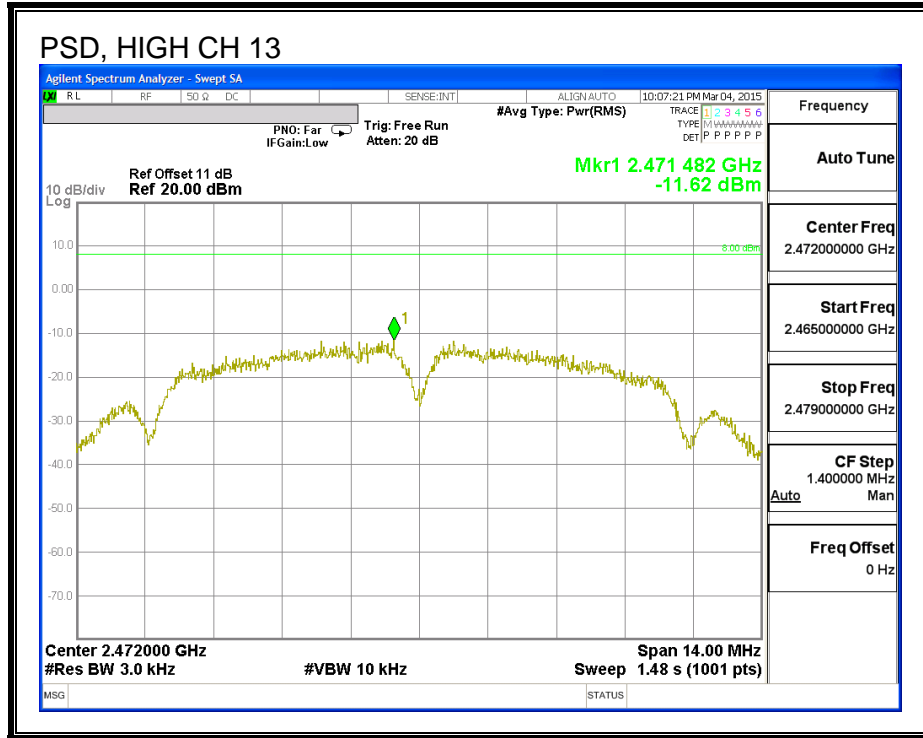

### 8.3.6. OUT-OF-BAND EMISSIONS

#### LIMITS

FCC §15.247 (d)

In any 100 kHz bandwidth outside the frequency band in which the spread spectrum or digitally modulated intentional radiator is operating, the radio frequency power that is produced by the intentional radiator shall be at least 20 dB below that in the 100 kHz bandwidth within the band that contains the highest level of the desired power, based on either an RF conducted or a radiated measurement, provided the transmitter demonstrates compliance with the peak conducted power limits. If the transmitter complies with the conducted power limits based on the use of RMS averaging over a time interval, as permitted under paragraph (b)(3) of this section, the attenuation required under this paragraph shall be 30 dB instead of 20 dB. Attenuation below the general limits specified in §15.209(a) is not required.

**RESULTS**

**IN-BAND REFERENCE LEVEL**

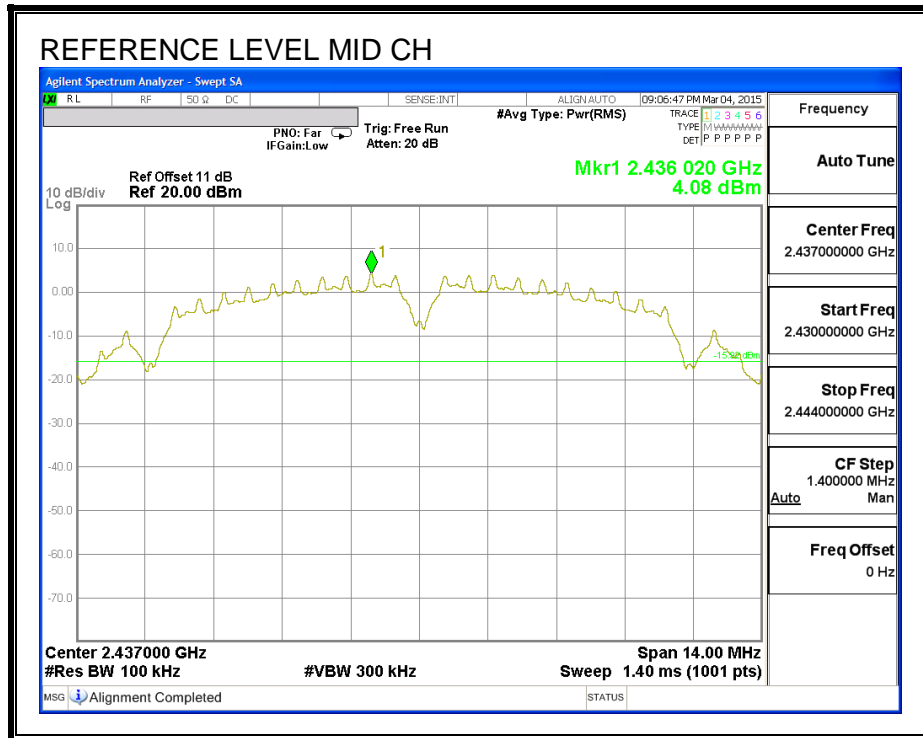



**LOW CHANNEL BANDEDGE**

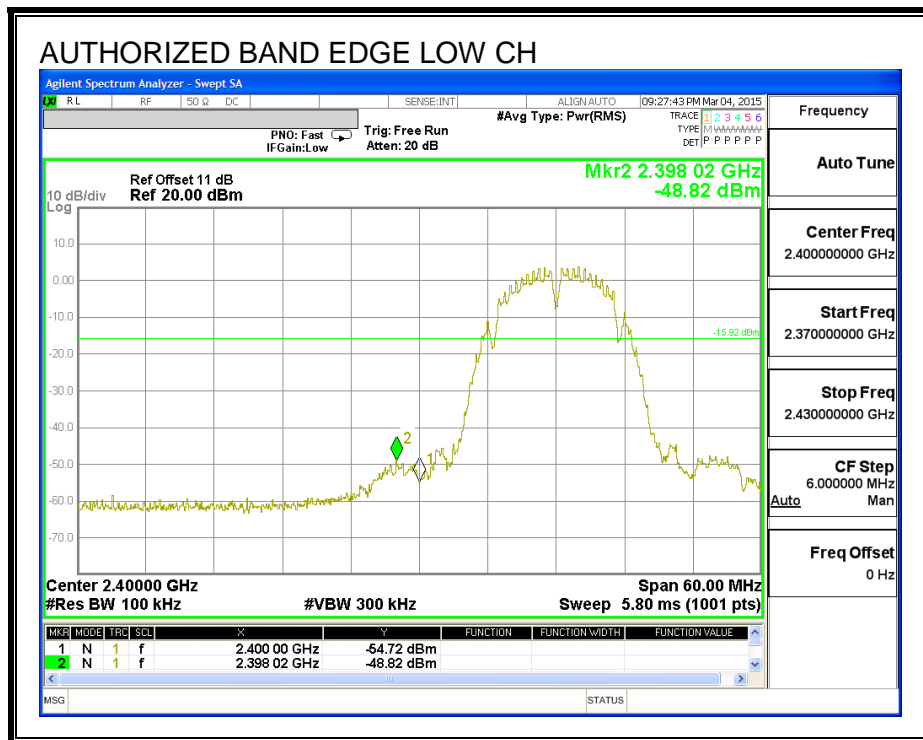

**HIGH CHANNEL BANDEDGE**

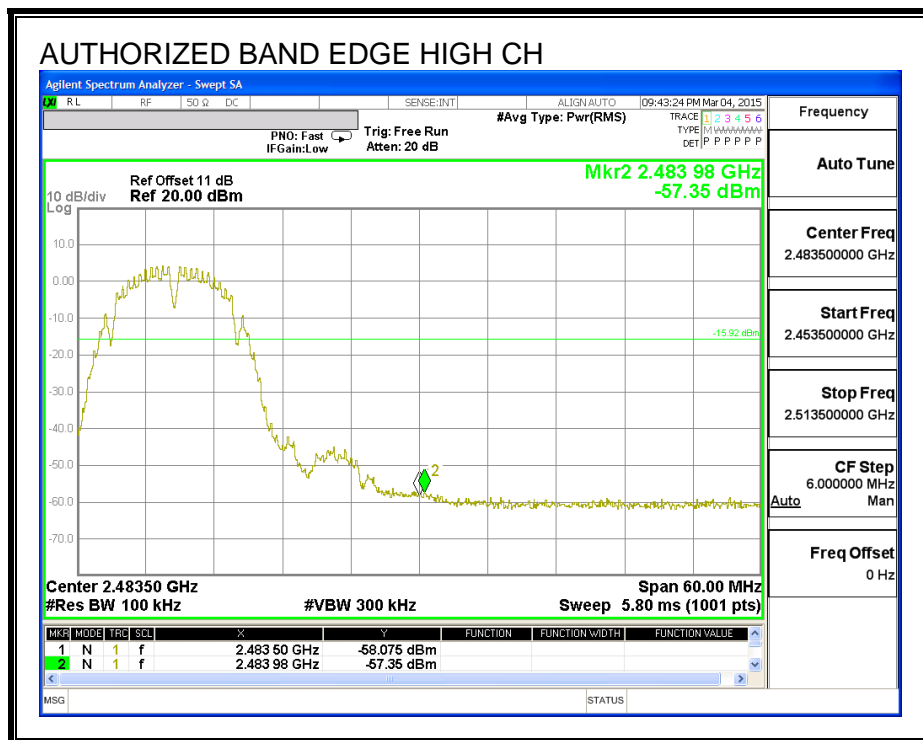

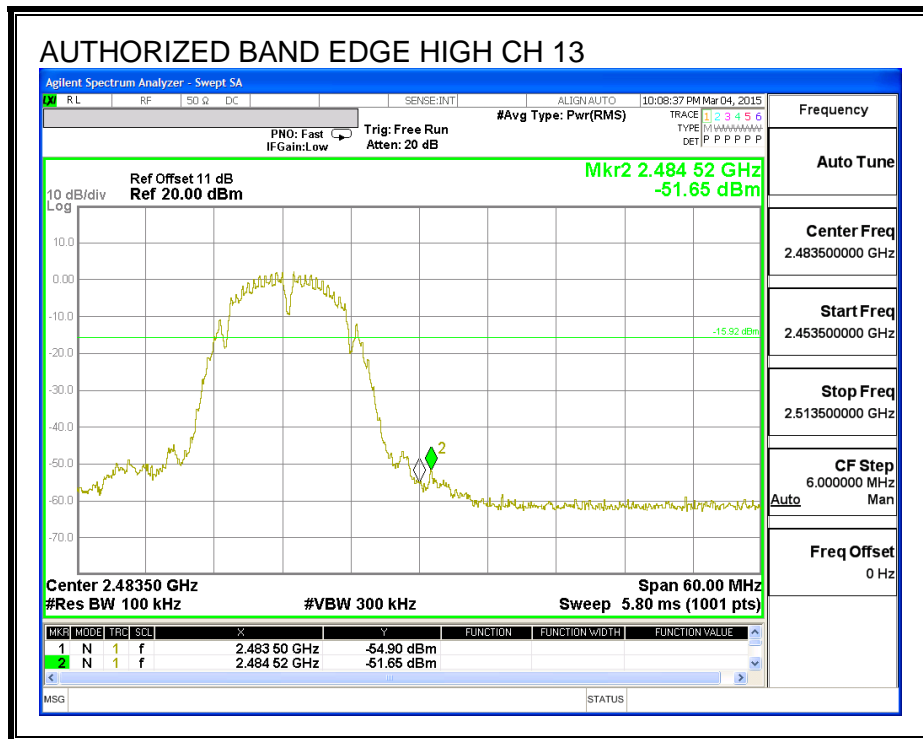
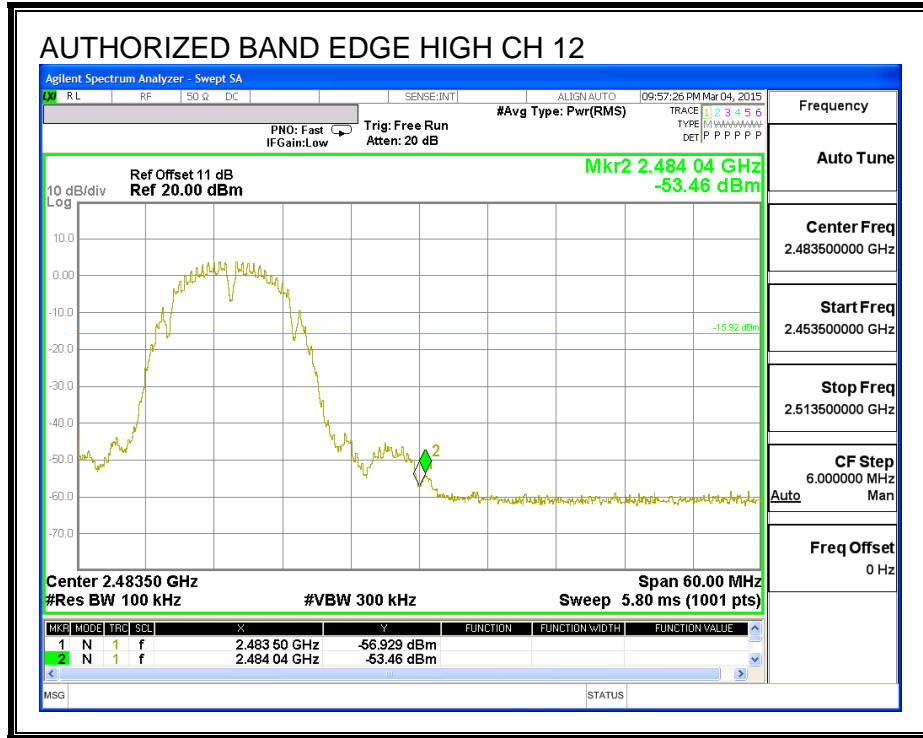

**OUT-OF-BAND EMISSIONS**

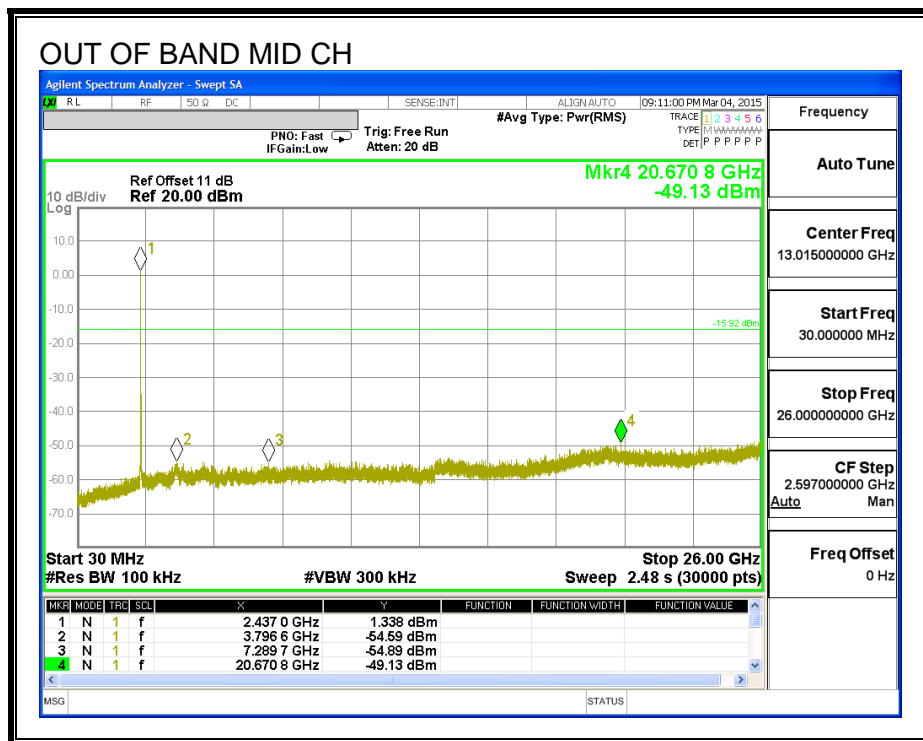
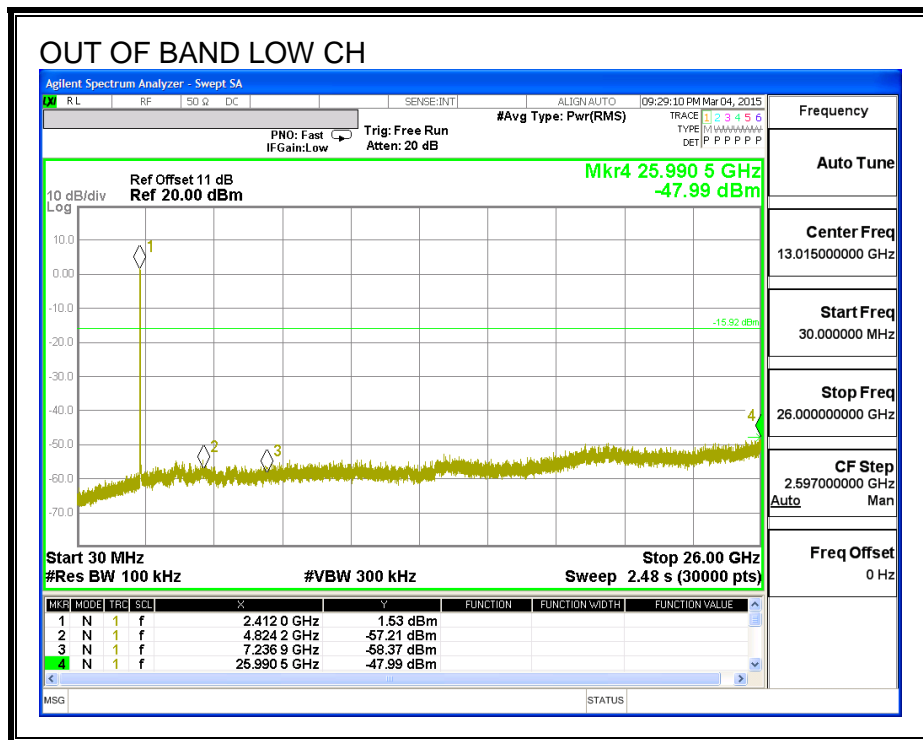

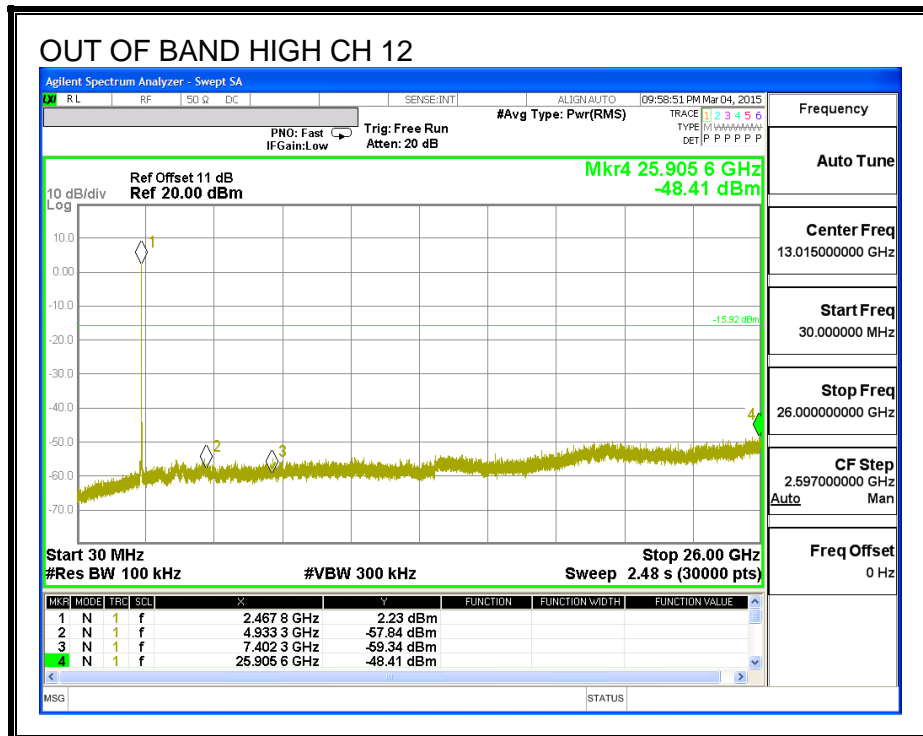
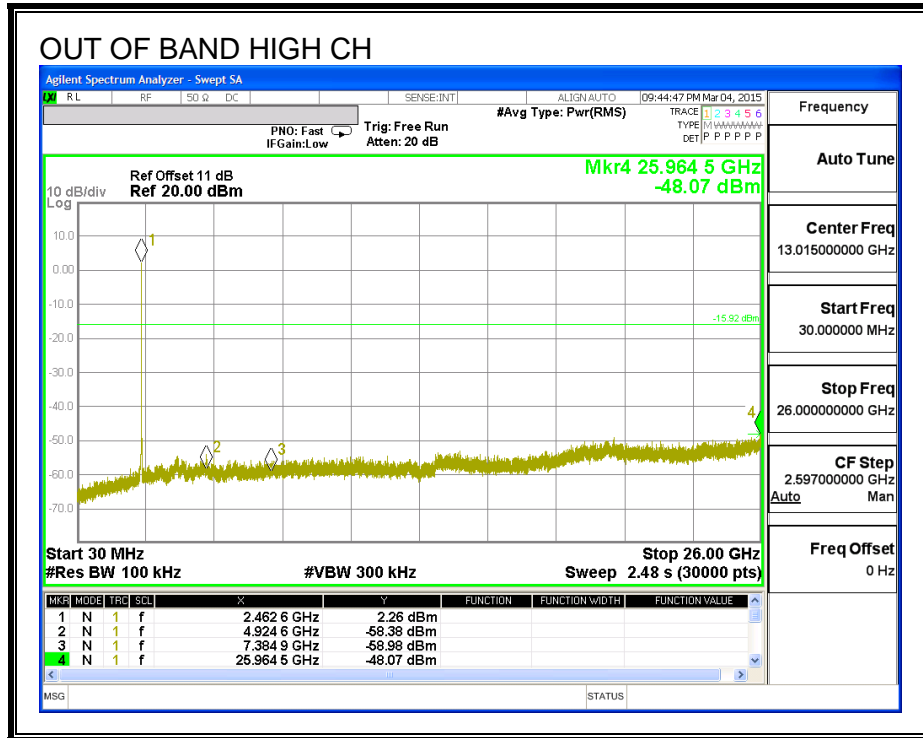

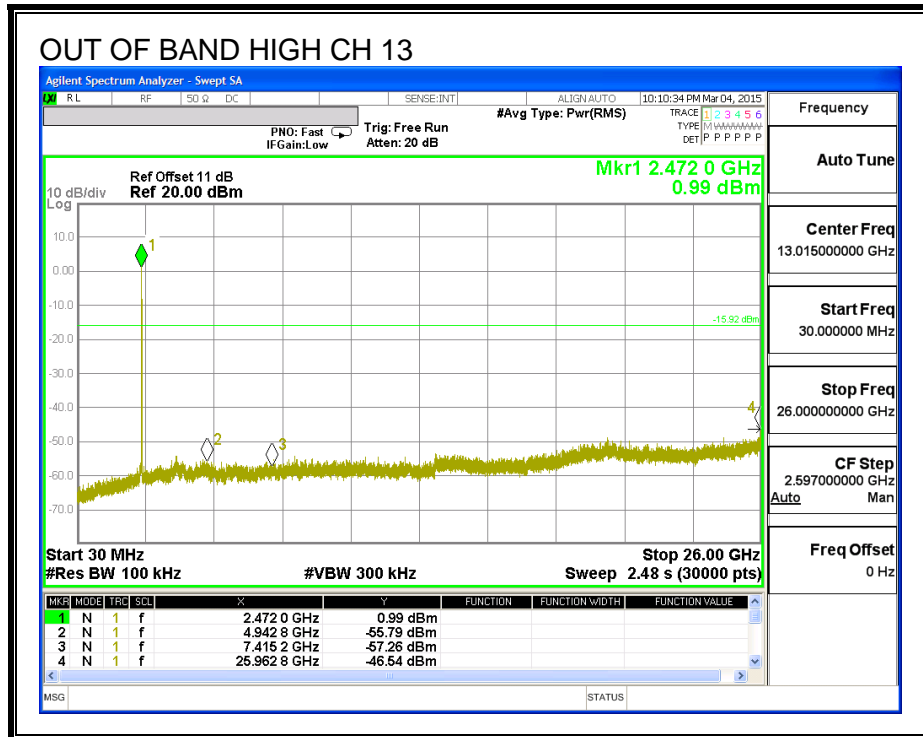

## 8.4. 802.11n HT20 SISO MODE IN THE 2.4 GHz BAND (ANTENNA A)

### 8.4.1. 6 dB BANDWIDTH

#### LIMITS

FCC §15.247 (a) (2)

The minimum 6 dB bandwidth shall be at least 500 kHz.

#### RESULTS

Channel	Frequency (MHz)	6 dB Bandwidth (MHz)	Minimum Limit (MHz)
Low	2412	17.580	0.5
Mid	2437	17.630	0.5
High	2462	17.610	0.5
High	2467	17.610	0.5
High	2472	17.580	0.5

**6 dB BANDWIDTH**

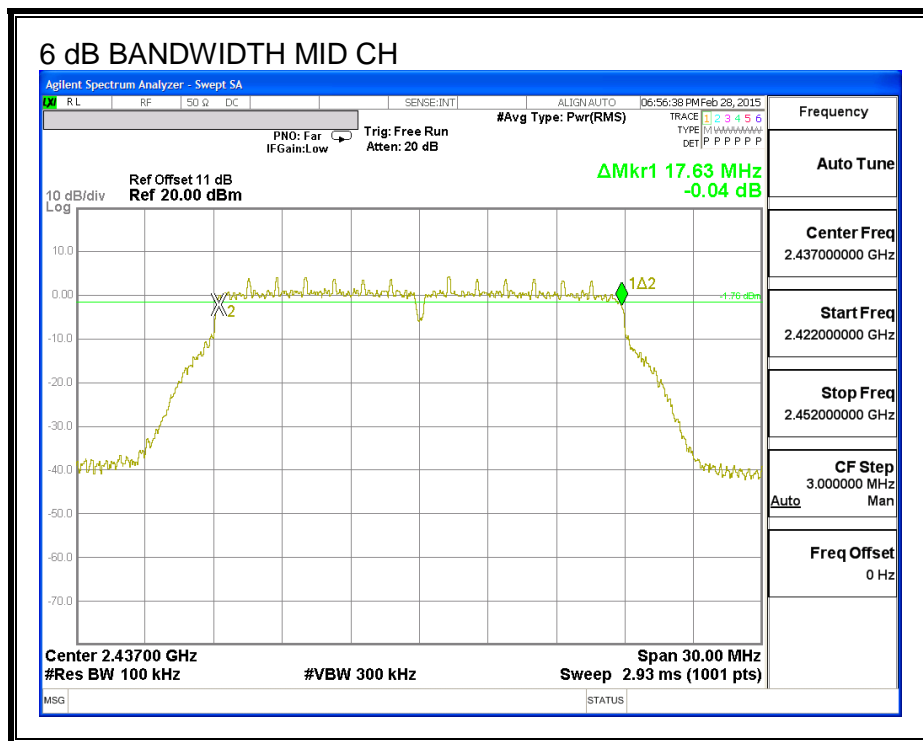
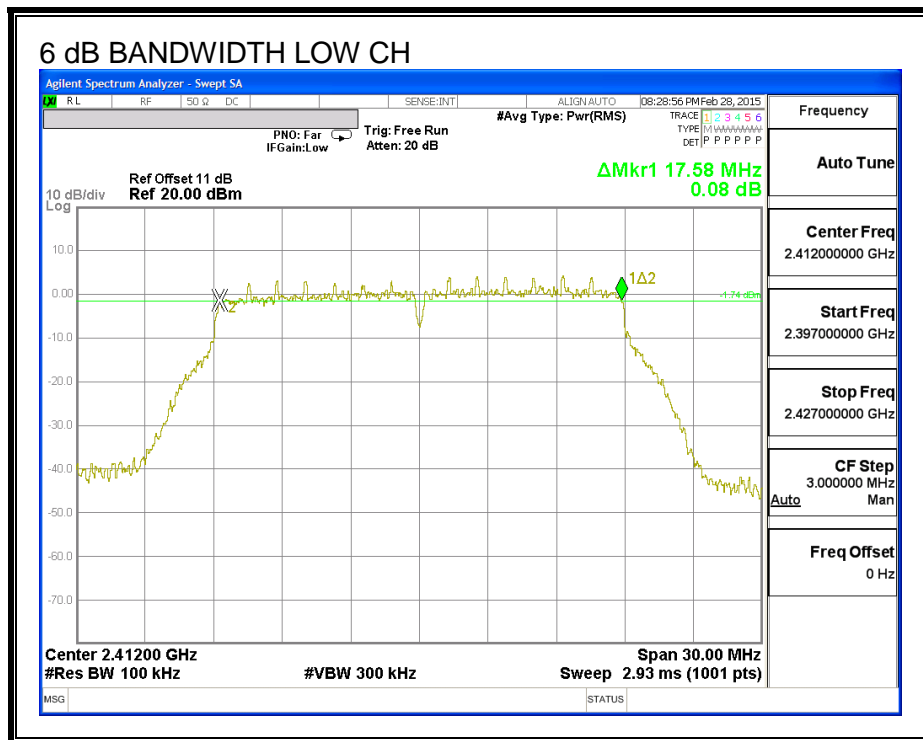

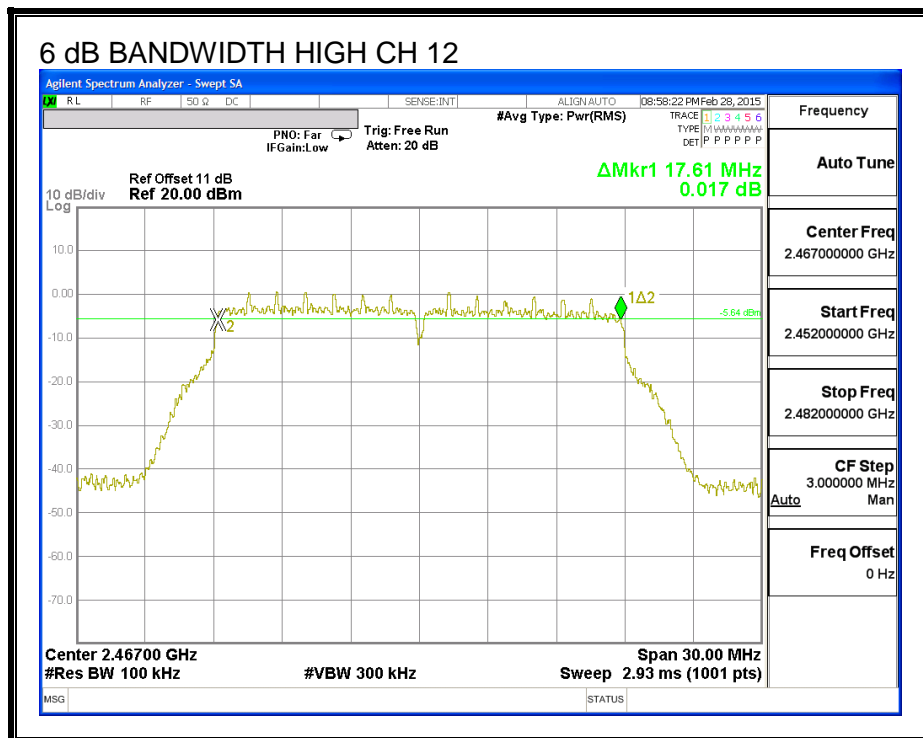
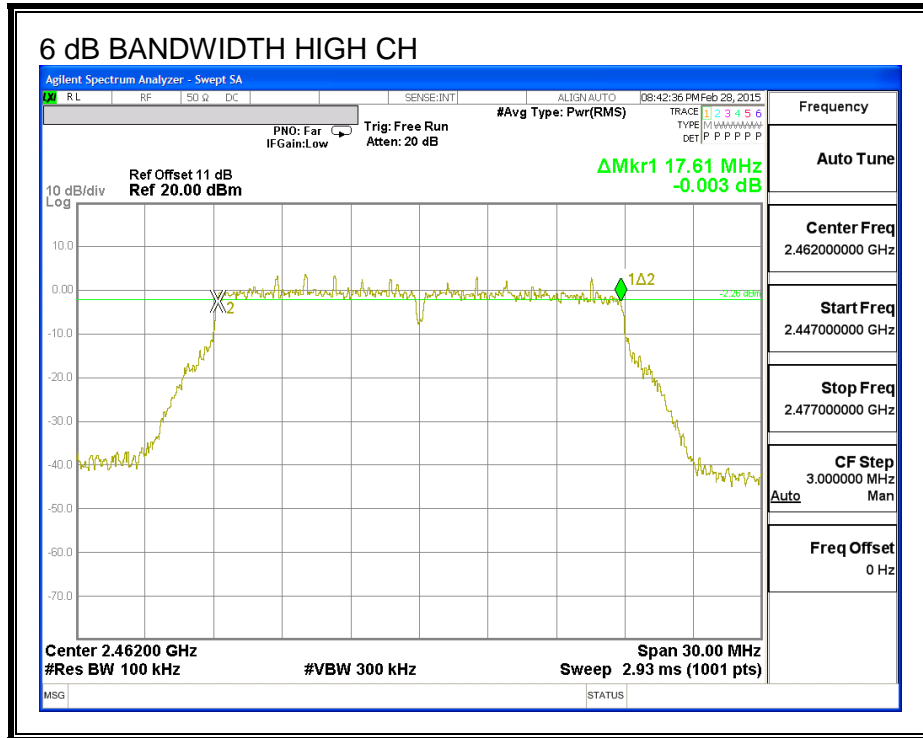





## 8.4.2. 99% BANDWIDTH

### LIMITS

None; for reporting purposes only.

### RESULTS

Channel	Frequency (MHz)	99% Bandwidth (MHz)
Low	2412	17.772
Mid	2437	17.700
High	2462	17.681
High	2467	17.644
High	2472	17.677

**99% BANDWIDTH**

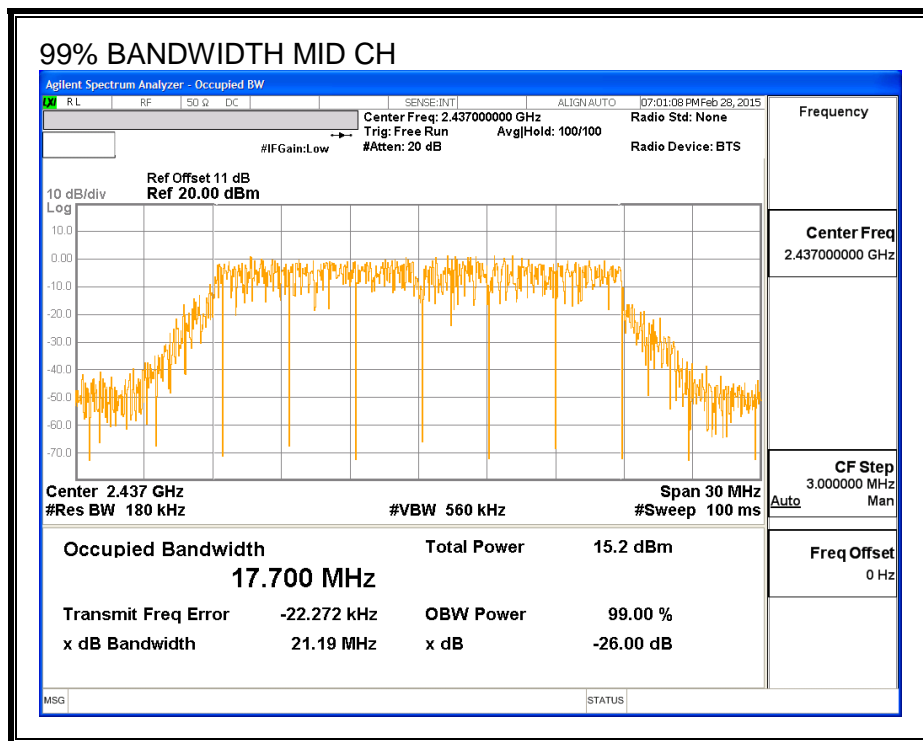
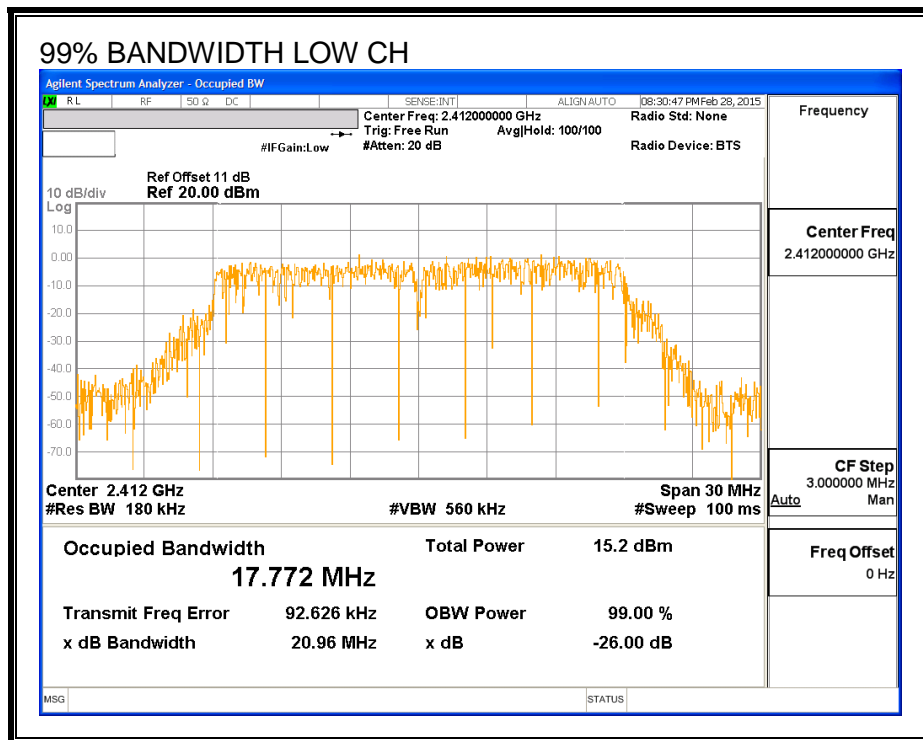

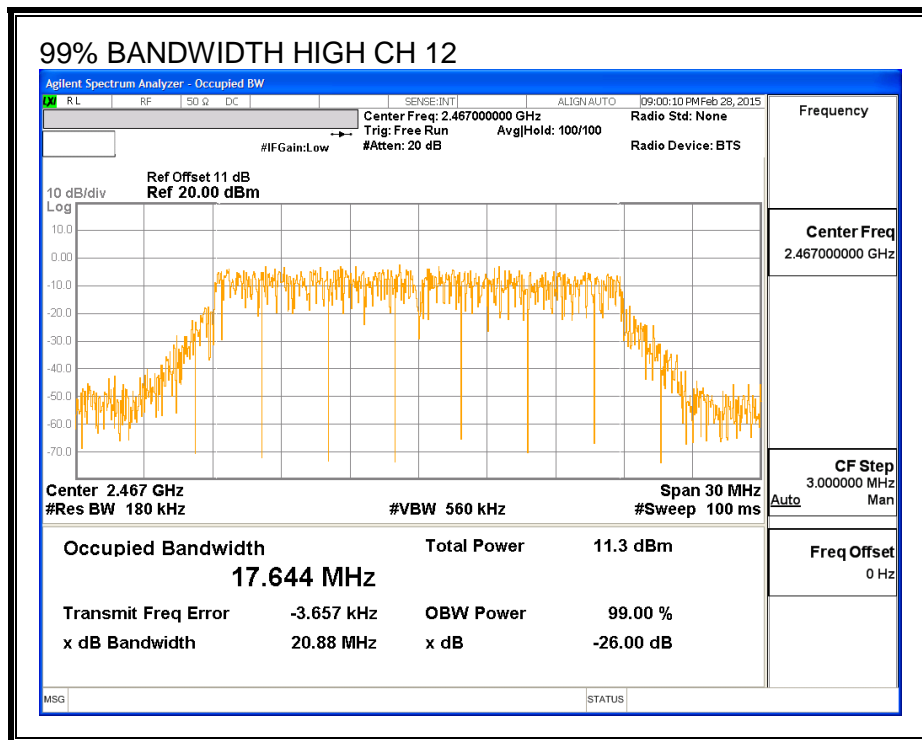
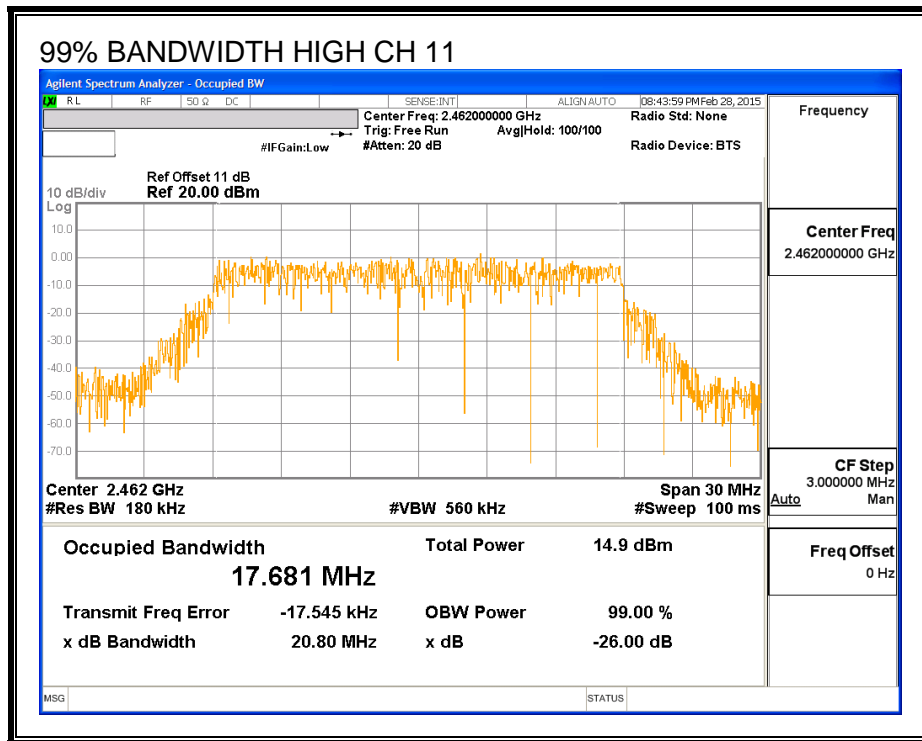

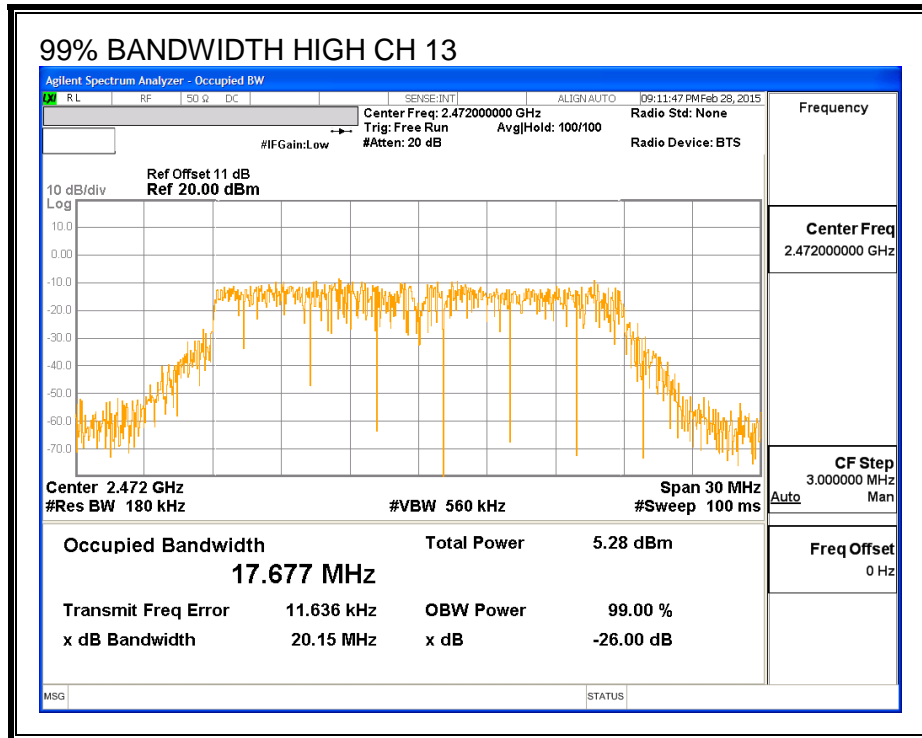

### 8.4.3. AVERAGE POWER

#### LIMITS

None; for reporting purposes only.

#### RESULTS

Channel	Frequency (MHz)	Power (dBm)
Low	2412	14.83
Mid	2437	14.93
High	2462	12.50
High	2467	9.94
High	2472	5.00

---

#### **8.4.4. OUTPUT POWER**

##### **LIMITS**

FCC §15.247

For systems using digital modulation in the 902–928 MHz, 2400–2483.5 MHz, and 5725–5850 MHz bands: 1 Watt, based on the use of antennas with directional gains that do not exceed 6 dBi. If transmitting antennas of directional gain greater than 6 dBi are used, the conducted output power from the intentional radiator shall be reduced by the amount in dB that the directional gain of the antenna exceeds 6 dBi.

##### **DIRECTIONAL ANTENNA GAIN**

There is only one transmitter output therefore the directional gain is equal to the antenna gain.

**RESULTS**

**Limits**

Channel	Frequency (MHz)	Directional Gain (dBi)	FCC Power Limit (dBm)	IC Power Limit (dBm)	IC EIRP Limit (dBm)	Max Power (dBm)
Low	2412	0.20	30.00	30	36	30.00
Mid	2437	0.20	30.00	30	36	30.00
High	2462	0.20	30.00	30	36	30.00
High	2467	0.20	30.00	30	36	30.00
High	2472	0.20	30.00	30	36	30.00

**Results**

Channel	Frequency (MHz)	Antenna A Meas Power (dBm)	Total Corr'd Power (dBm)	Power Limit (dBm)	Margin (dB)
Low	2412	23.20	23.20	30.00	-6.80
Mid	2437	23.29	23.29	30.00	-6.71
High	2462	20.92	20.92	30.00	-9.08
High	2467	17.39	17.39	30.00	-12.61
High	2472	12.64	12.64	30.00	-17.36



### 8.4.5. PSD

#### LIMITS

FCC §15.247

#### RESULTS

##### PSD Results

Channel	Frequency (MHz)	Antenna A Meas (dBm)	Limit (dBm)	Margin (dB)
Low	2412	-10.42	8.0	-18.4
Mid	2437	-10.02	8.0	-18.0
High	2462	-12.65	8.0	-20.7
High	2467	-15.11	8.0	-23.1
High	2472	-19.41	8.0	-27.4

**PSD**

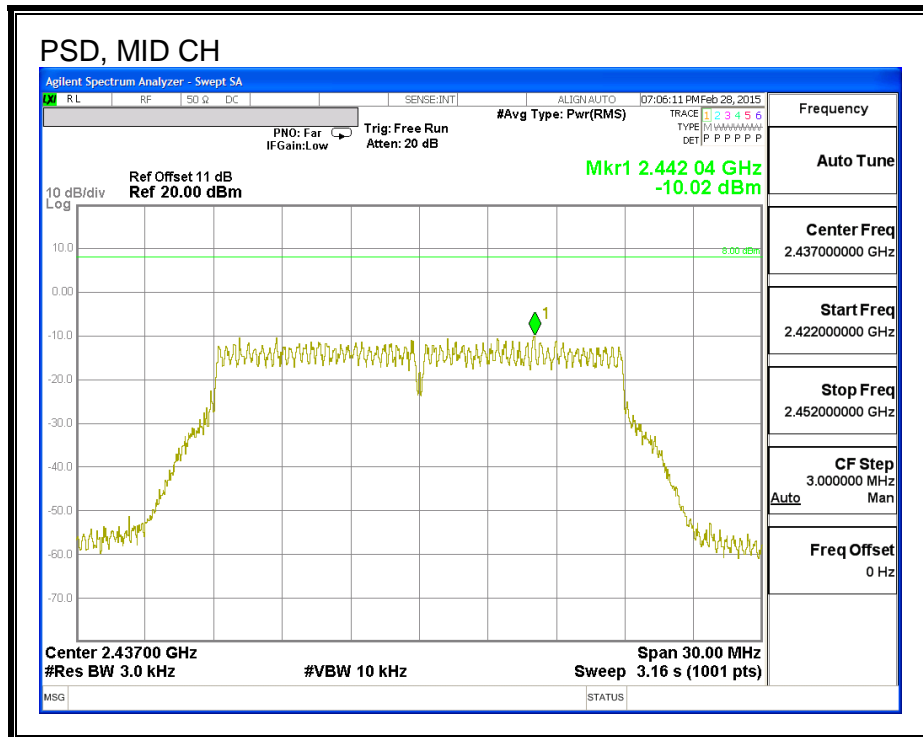
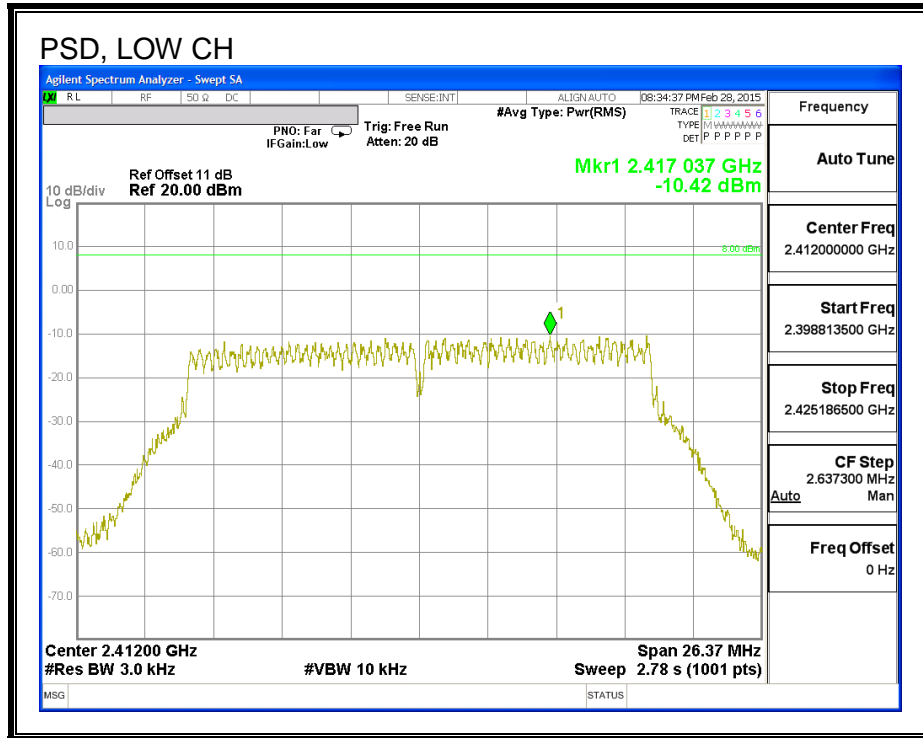

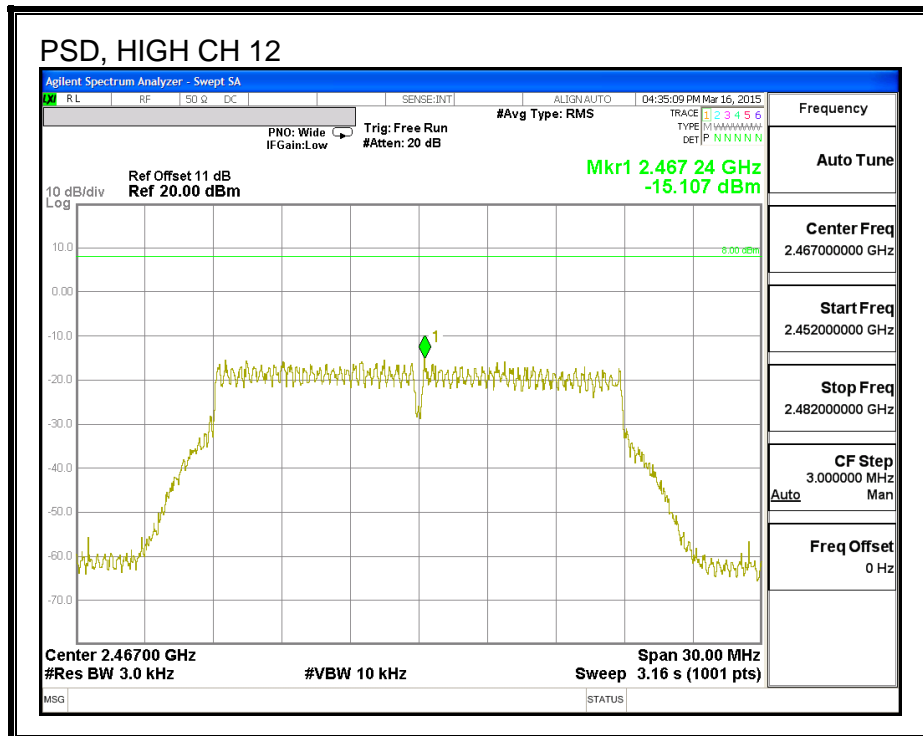
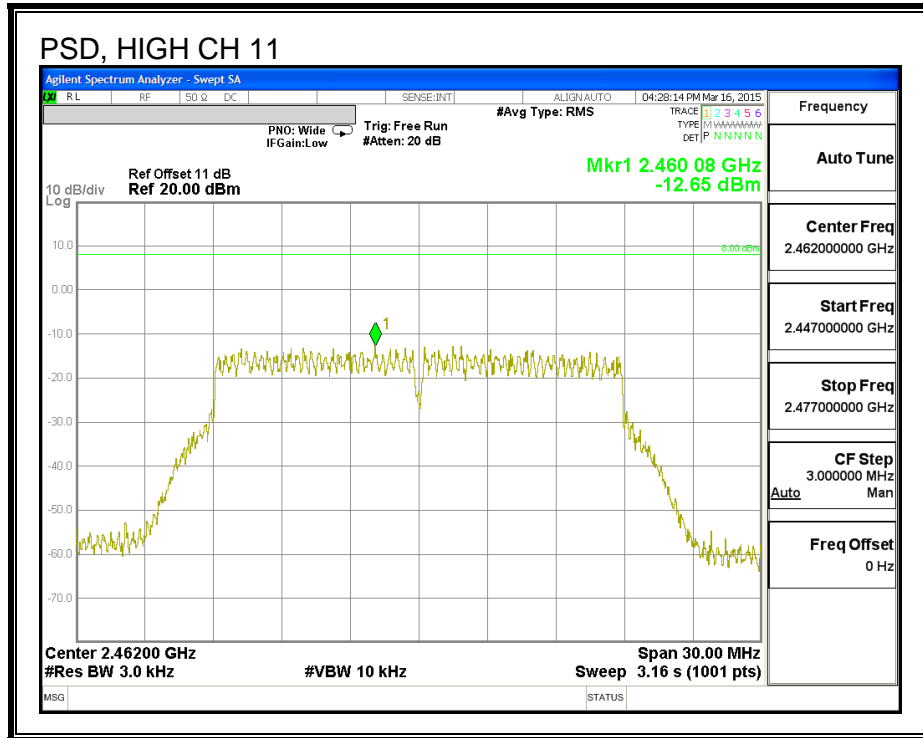

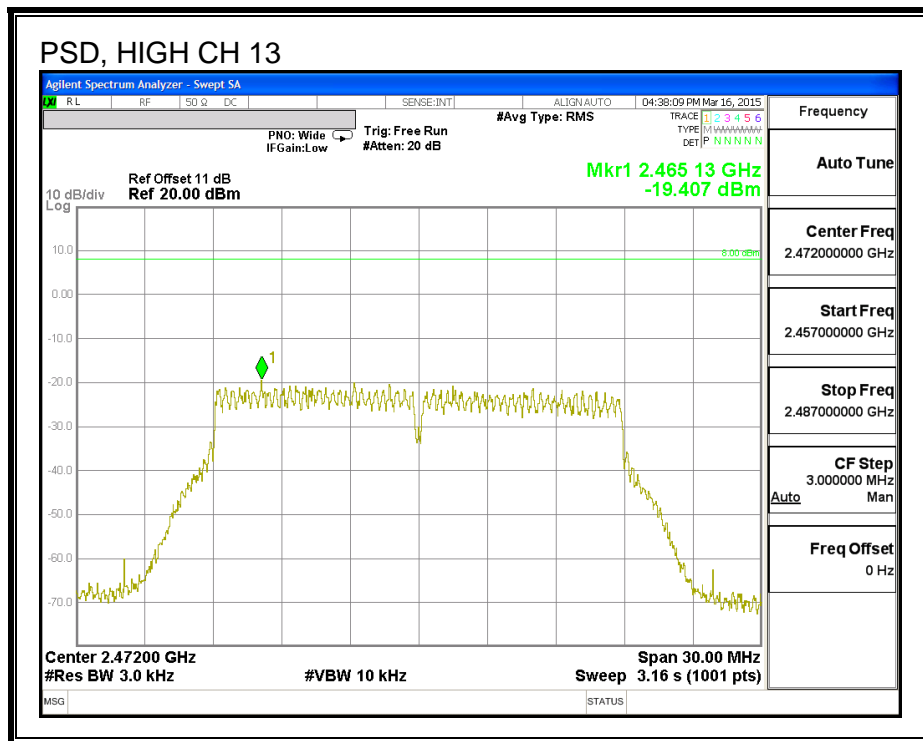

---

## 8.4.6. OUT-OF-BAND EMISSIONS

### LIMITS

FCC §15.247 (d)

In any 100 kHz bandwidth outside the frequency band in which the spread spectrum or digitally modulated intentional radiator is operating, the radio frequency power that is produced by the intentional radiator shall be at least 20 dB below that in the 100 kHz bandwidth within the band that contains the highest level of the desired power, based on either an RF conducted or a radiated measurement, provided the transmitter demonstrates compliance with the peak conducted power limits. If the transmitter complies with the conducted power limits based on the use of RMS averaging over a time interval, as permitted under paragraph (b)(3) of this section, the attenuation required under this paragraph shall be 30 dB instead of 20 dB. Attenuation below the general limits specified in §15.209(a) is not required.

**RESULTS**

**IN-BAND REFERENCE LEVEL**

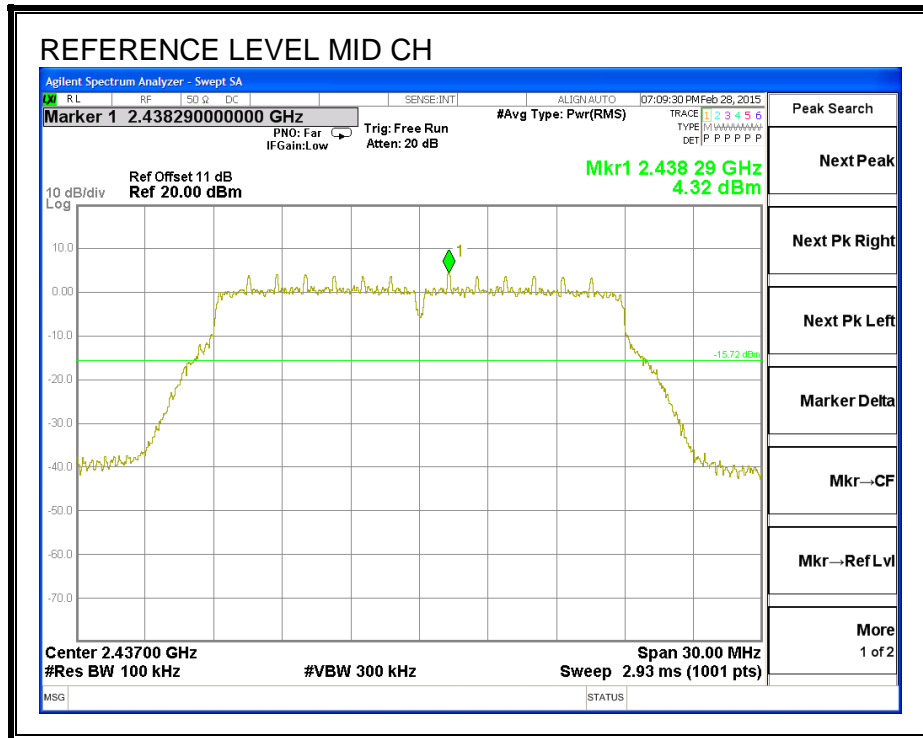

**LOW CHANNEL BANDEGE**

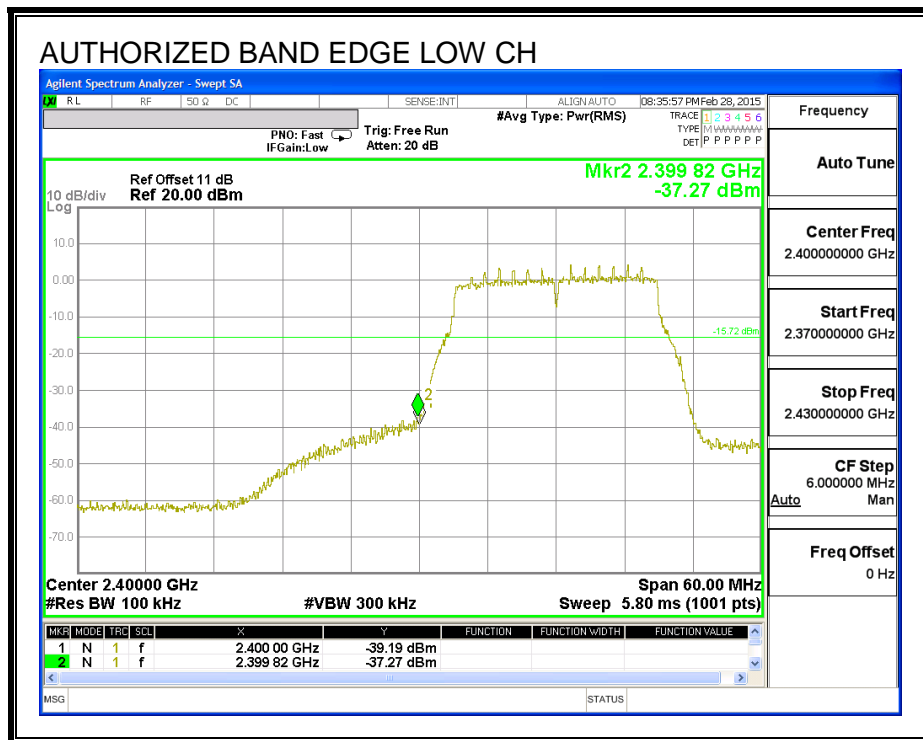

**HIGH CHANNEL BANDEGE**

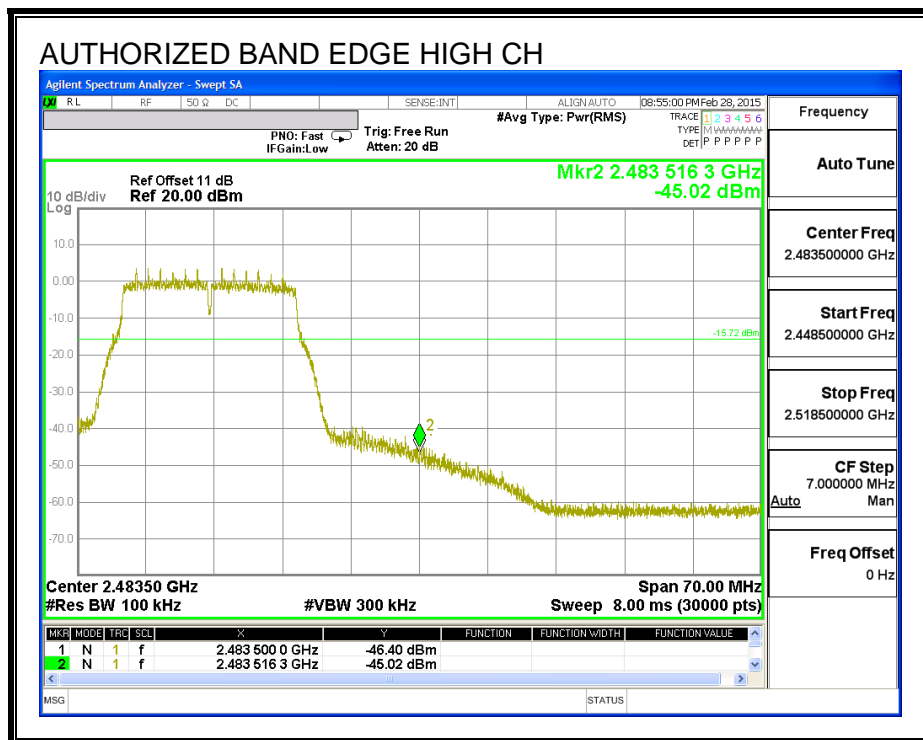

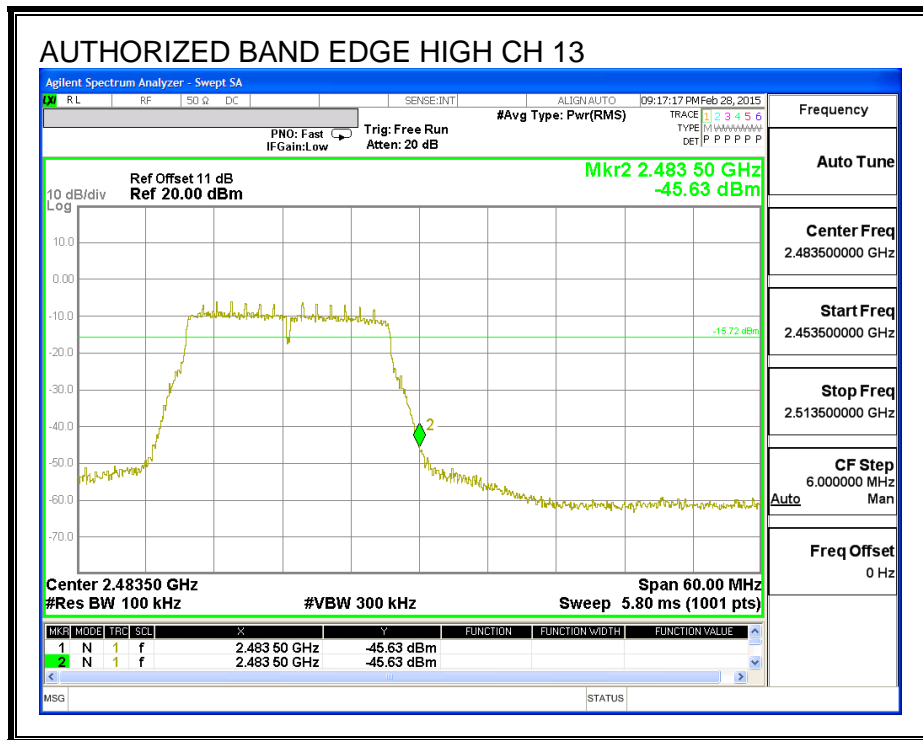
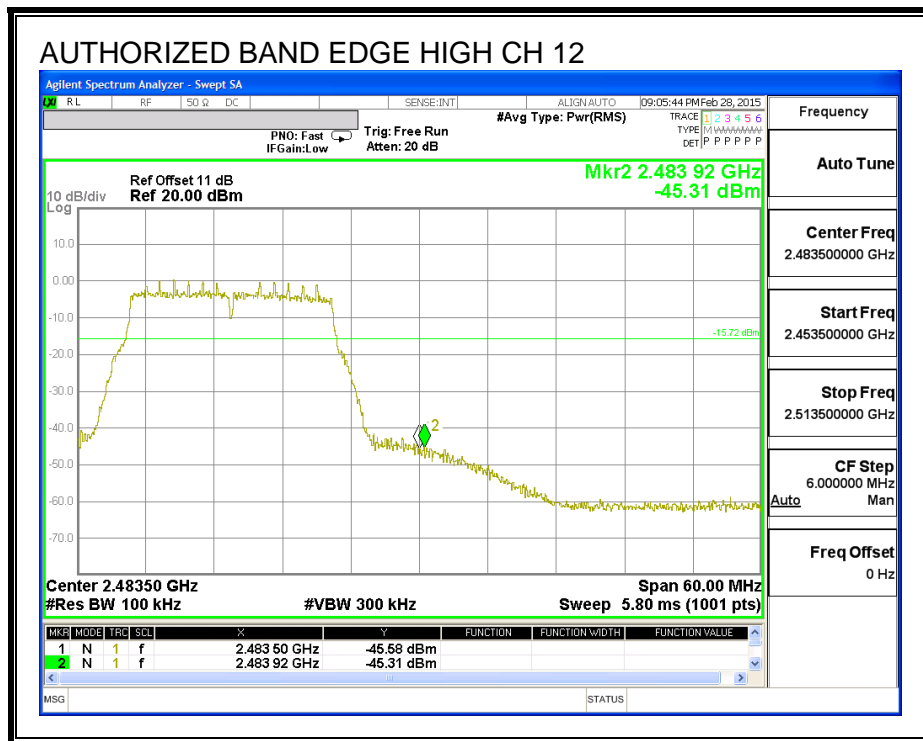



**OUT-OF-BAND EMISSIONS**

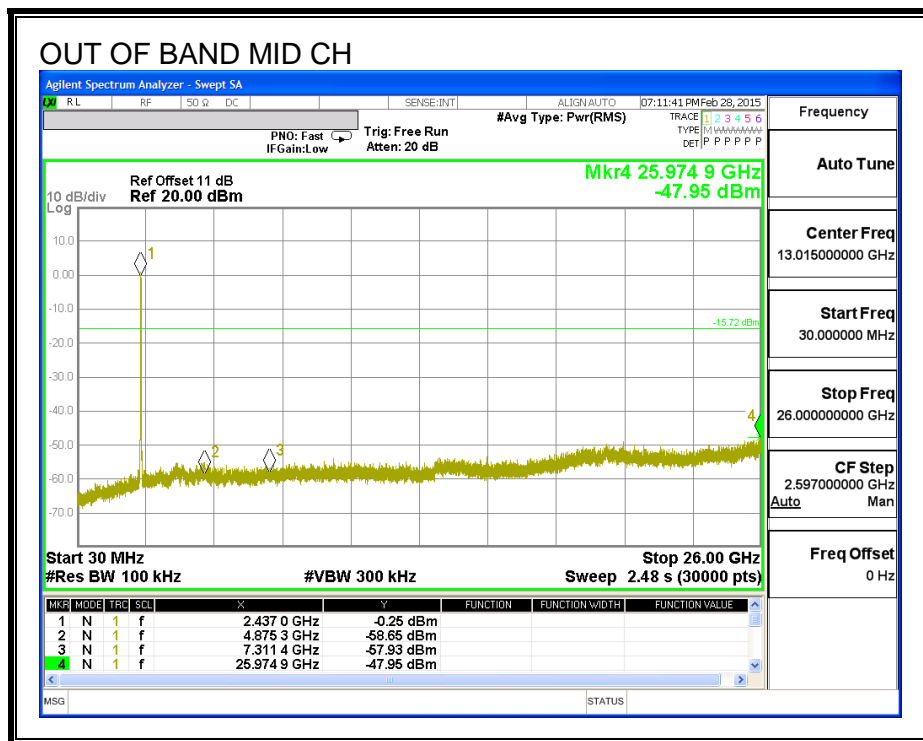
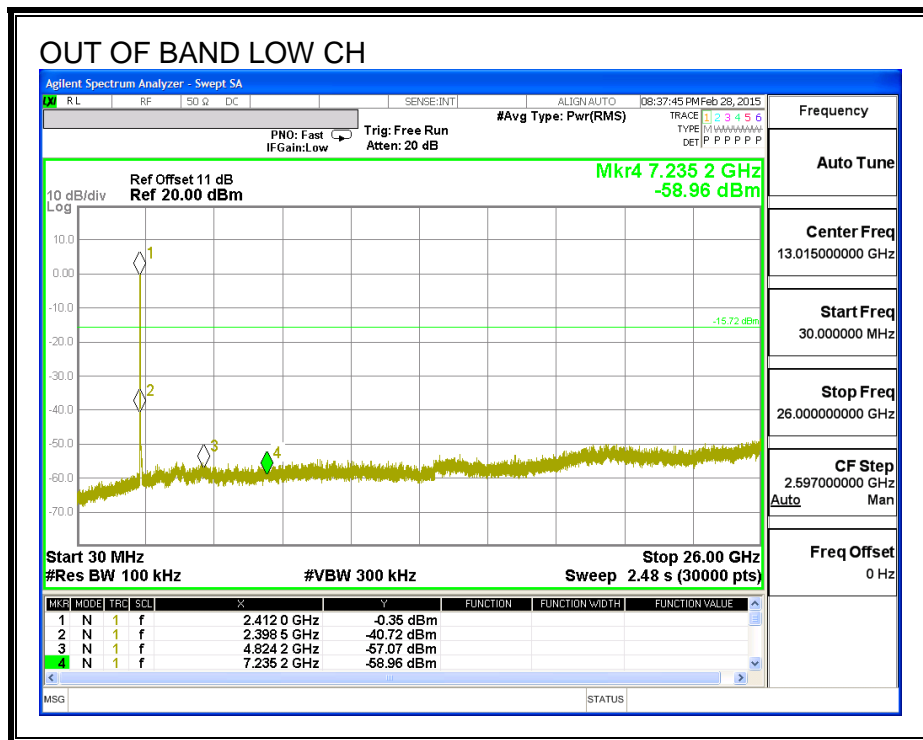

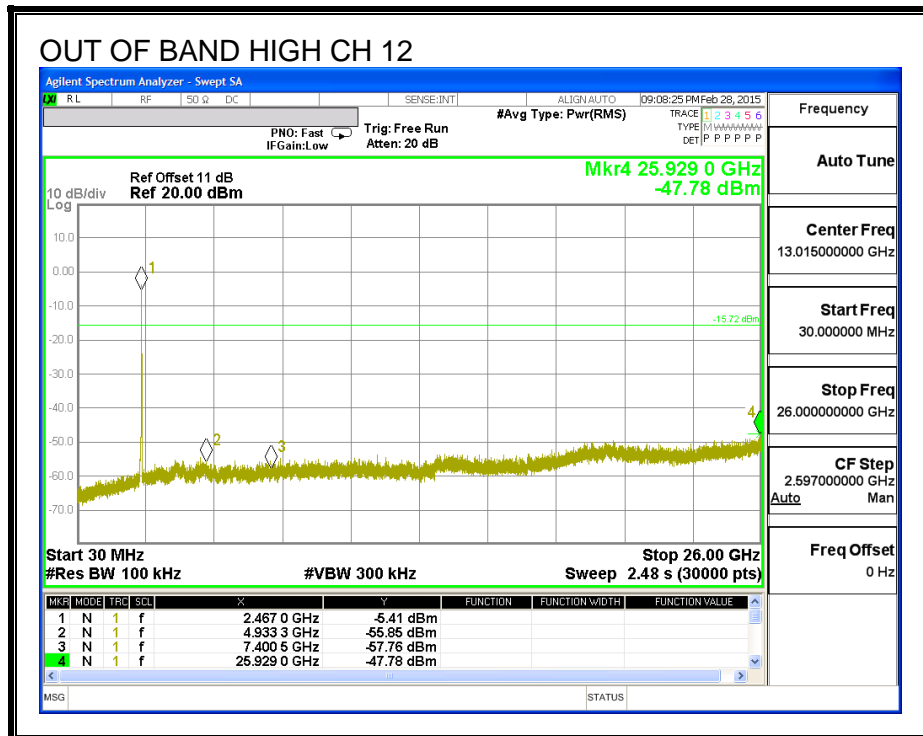
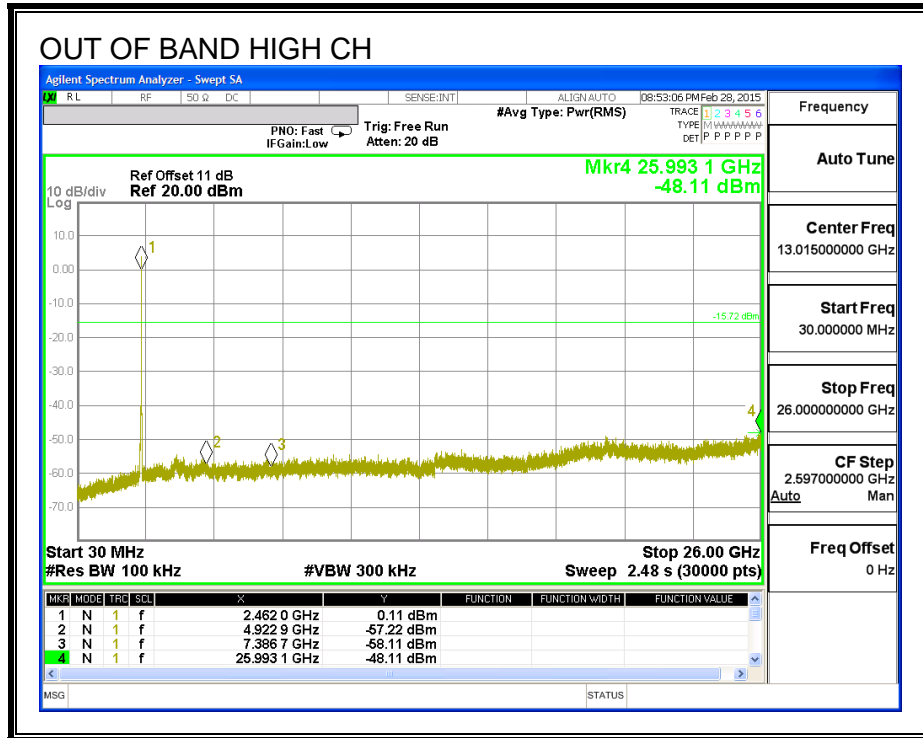

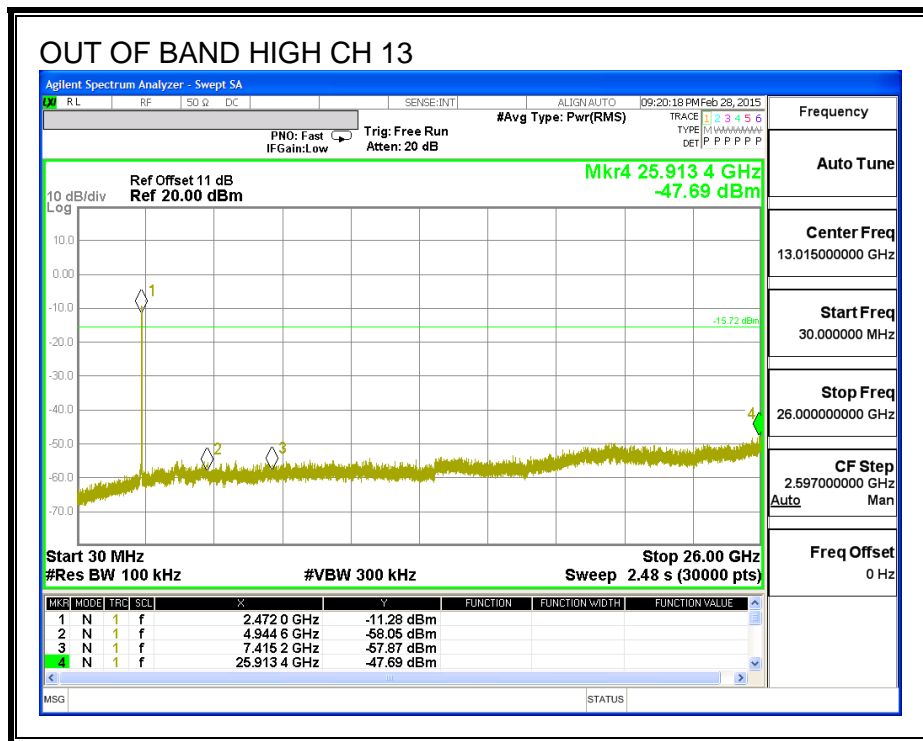

## 8.5. 802.11n HT20 SISO MODE IN THE 2.4 GHz BAND (ANTENNA B)

### 8.5.1. 6 dB BANDWIDTH

#### LIMITS

FCC §15.247 (a) (2)

The minimum 6 dB bandwidth shall be at least 500 kHz.

#### RESULTS

Channel	Frequency (MHz)	6 dB Bandwidth (MHz)	Minimum Limit (MHz)
Low	2412	17.270	0.5
Mid	2437	17.630	0.5
High	2462	17.310	0.5
High	2467	17.390	0.5
High	2472	17.570	0.5

**6 dB BANDWIDTH**

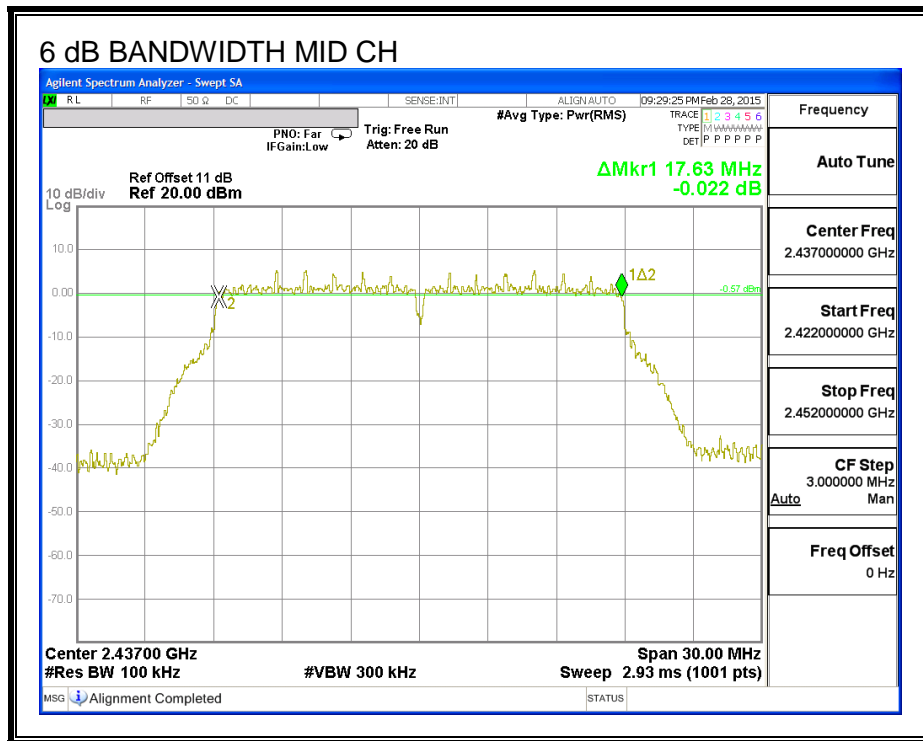
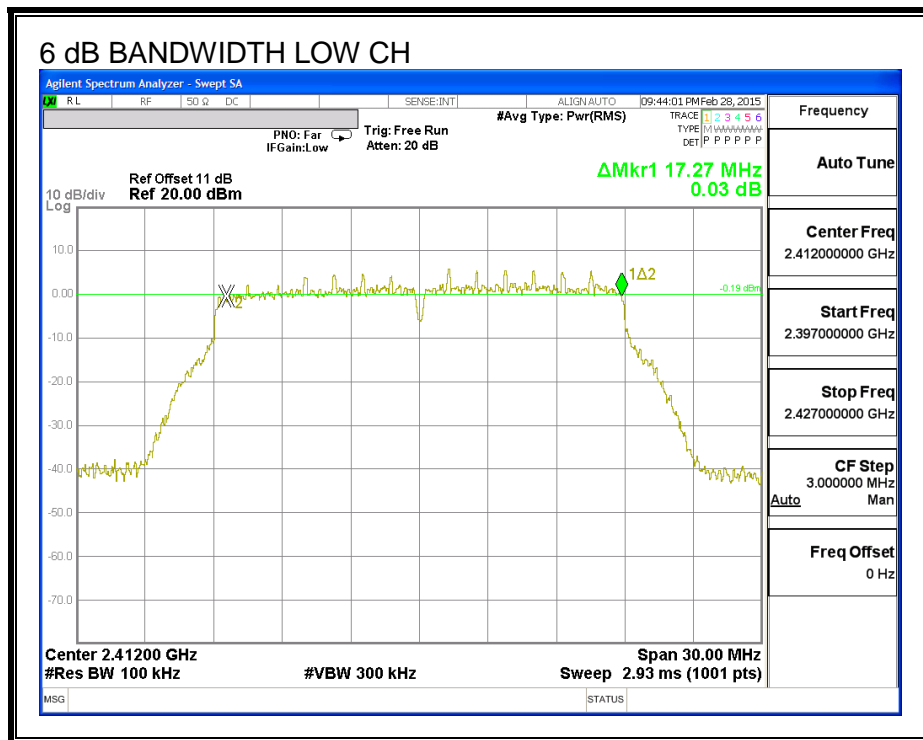

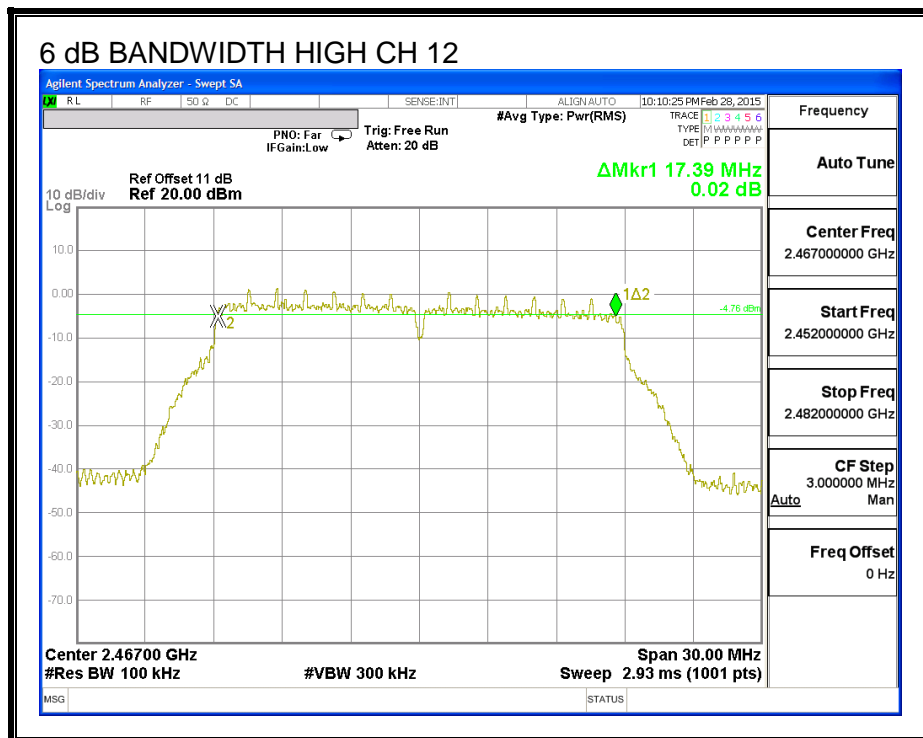
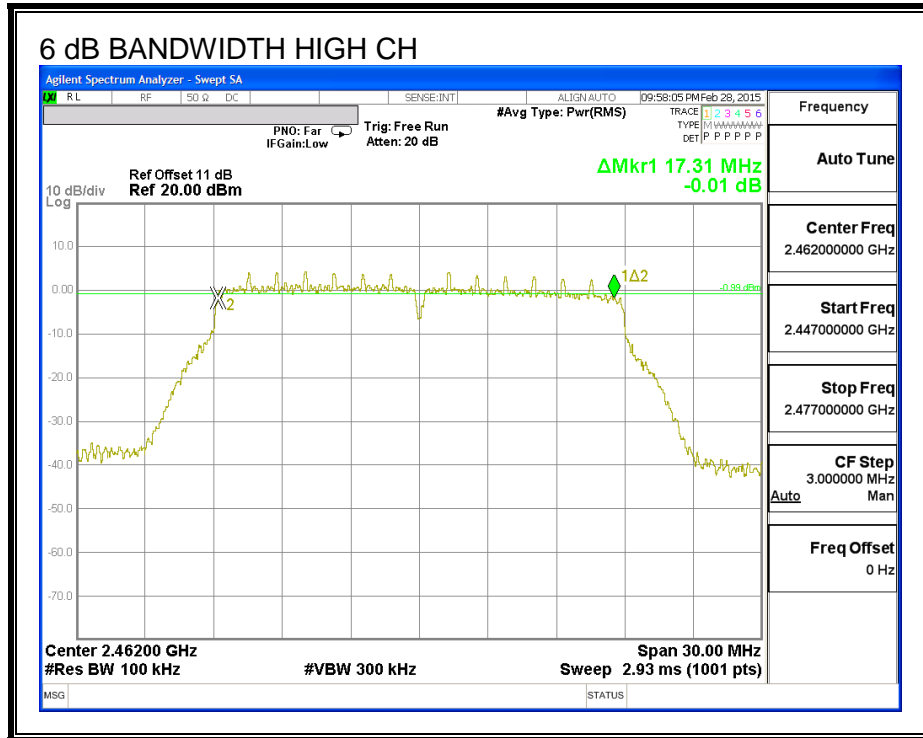

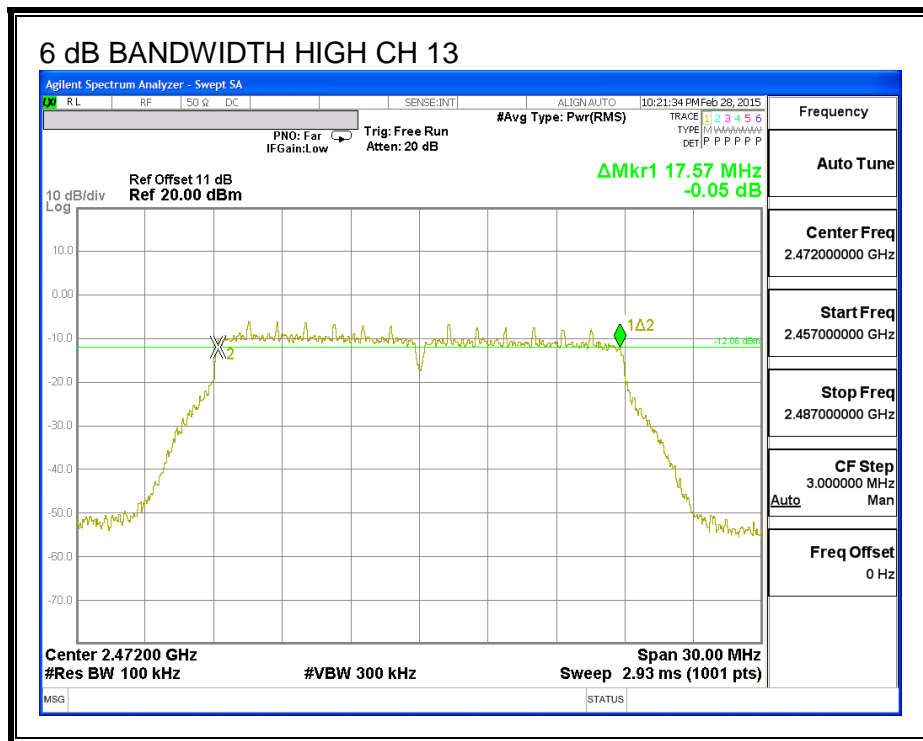

## 8.5.2. 99% BANDWIDTH

### LIMITS

None; for reporting purposes only.

### RESULTS

Channel	Frequency (MHz)	99% Bandwidth (MHz)
Low	2412	17.752
Mid	2437	17.712
High	2462	17.605
High	2467	17.718
High	2472	17.739



**99% BANDWIDTH**

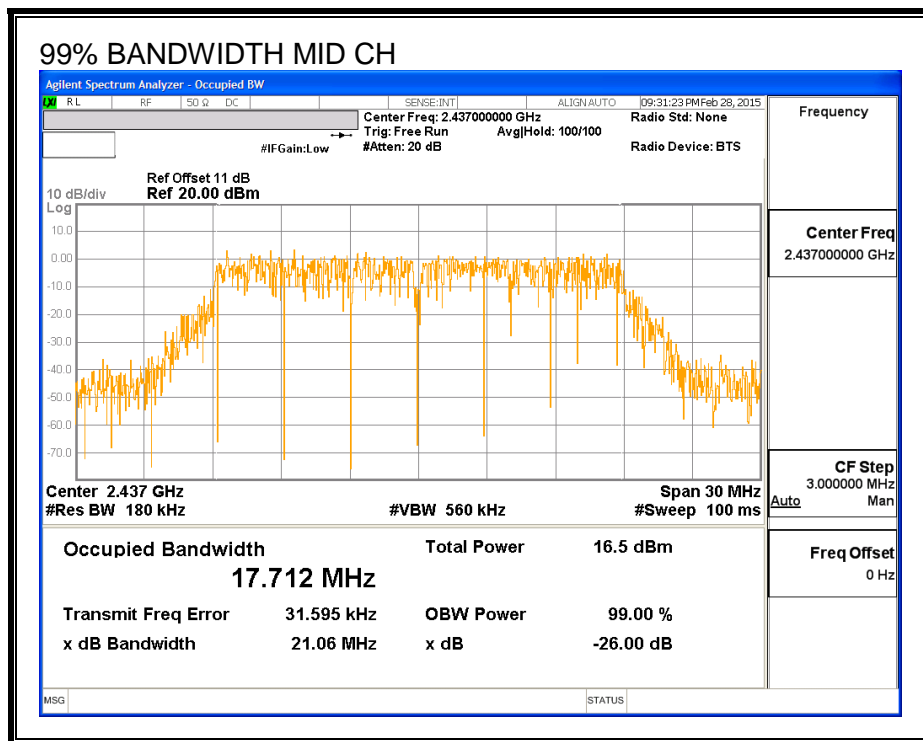
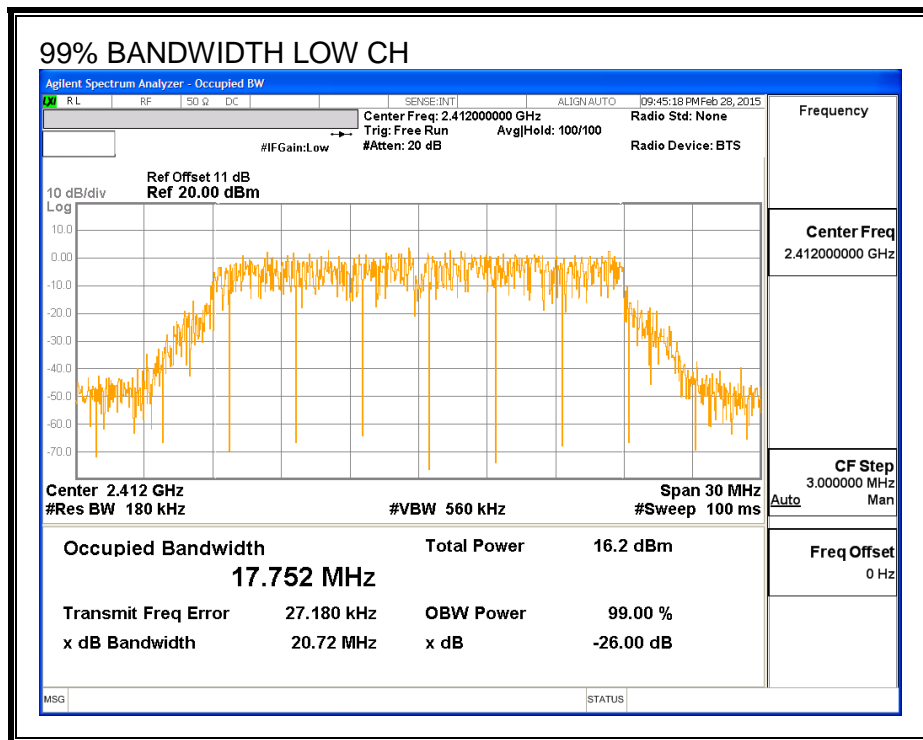

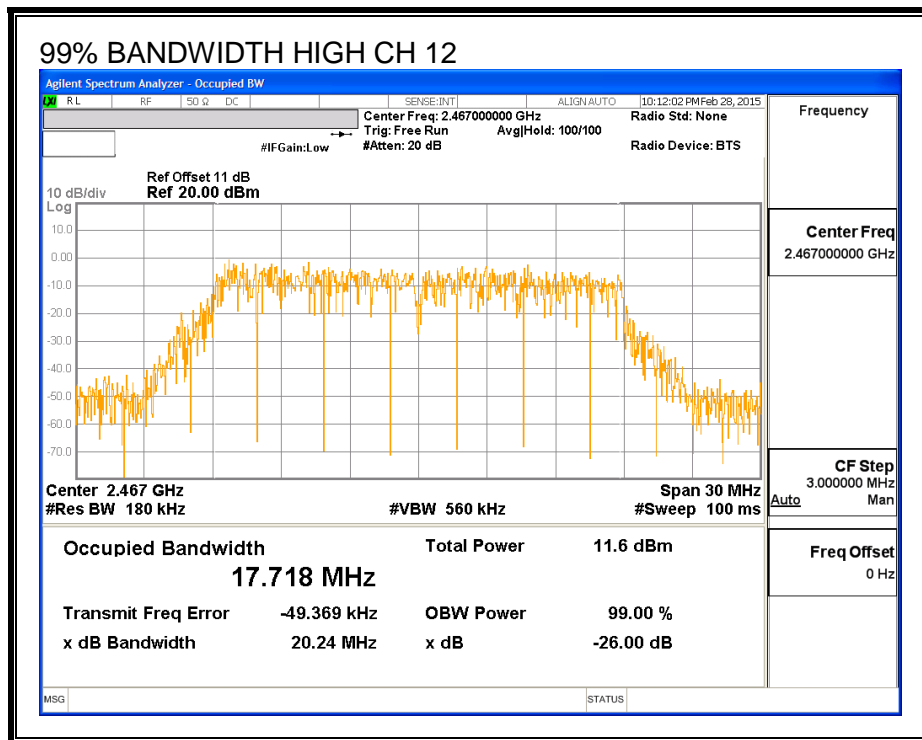
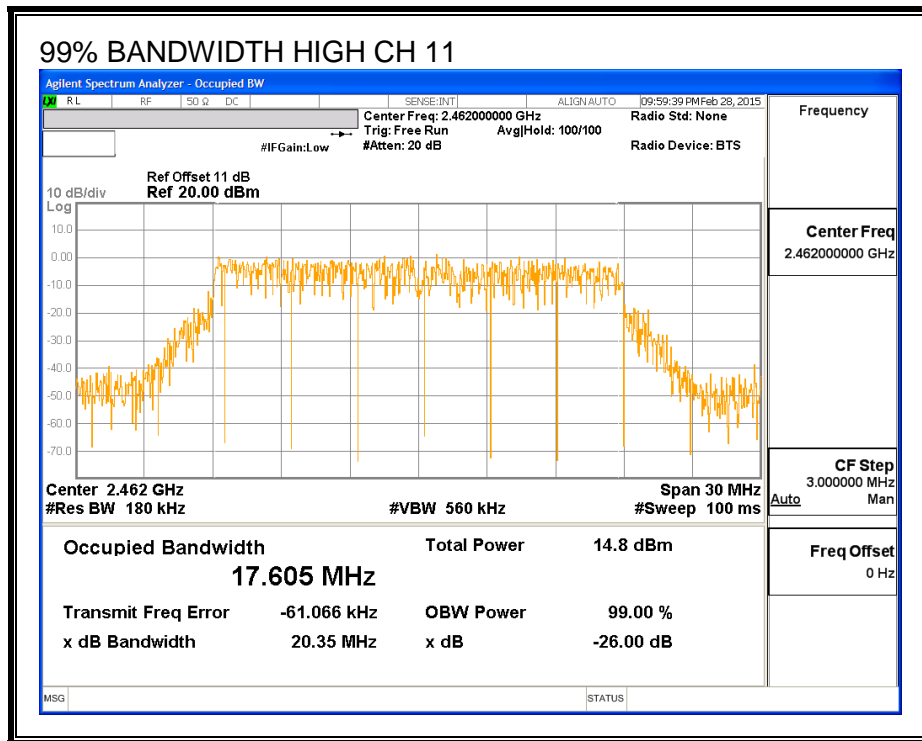

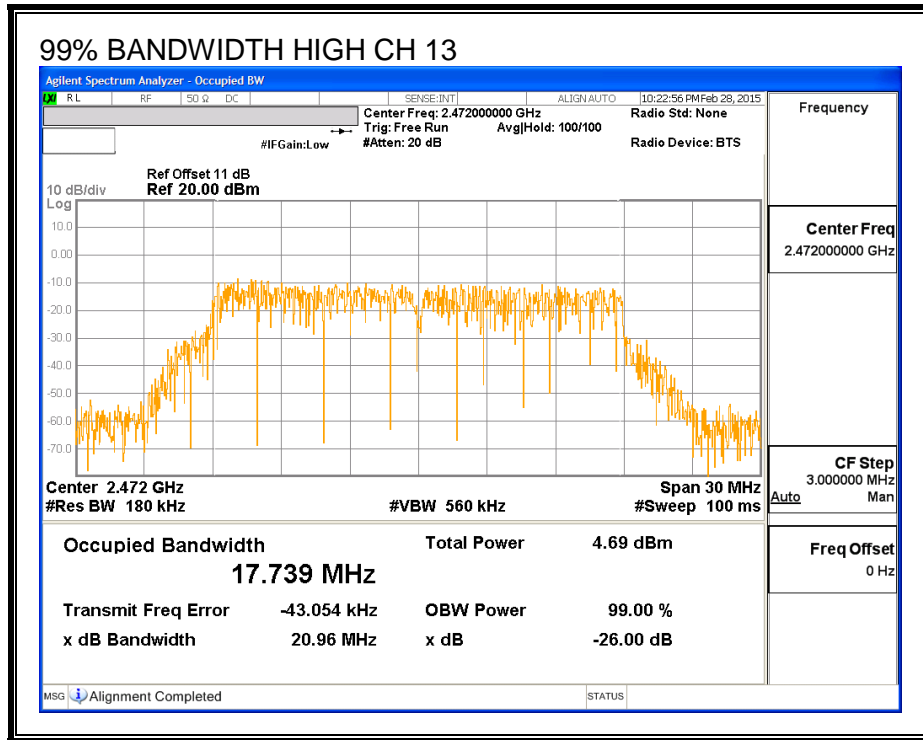

### 8.5.3. AVERAGE POWER

#### LIMITS

None; for reporting purposes only.

#### RESULTS

Channel	Frequency (MHz)	Power (dBm)
Low	2412	16.41
Mid	2437	16.46
High	2462	12.43
High	2467	10.00
High	2472	4.99

---

## 8.5.4. OUTPUT POWER

### LIMITS

FCC §15.247

For systems using digital modulation in the 902–928 MHz, 2400–2483.5 MHz, and 5725–5850 MHz bands: 1 Watt, based on the use of antennas with directional gains that do not exceed 6 dBi. If transmitting antennas of directional gain greater than 6 dBi are used, the conducted output power from the intentional radiator shall be reduced by the amount in dB that the directional gain of the antenna exceeds 6 dBi.

### DIRECTIONAL ANTENNA GAIN

There is only one transmitter output therefore the directional gain is equal to the antenna gain.

**RESULTS**

**Limits**

Channel	Frequency (MHz)	Directional Gain (dBi)	FCC Power Limit (dBm)	IC Power Limit (dBm)	IC EIRP Limit (dBm)	Max Power (dBm)
Low	2412	-1.00	30.00	30	36	30.00
Mid	2437	-1.00	30.00	30	36	30.00
High	2462	-1.00	30.00	30	36	30.00
High	2467	-1.00	30.00	30	36	30.00
High	2472	-1.00	30.00	30	36	30.00

**Results**

Channel	Frequency (MHz)	Antenna B Meas Power (dBm)	Total Corr'd Power (dBm)	Power Limit (dBm)	Margin (dB)
Low	2412	24.44	24.44	30.00	-5.56
Mid	2437	24.72	24.72	30.00	-5.28
High	2462	22.01	22.01	30.00	-7.99
High	2467	16.80	16.80	30.00	-13.20
High	2472	12.88	12.88	30.00	-17.12

### 8.5.5. PSD

#### LIMITS

FCC §15.247

#### RESULTS

##### PSD Results

Channel	Frequency (MHz)	Antenna B Meas (dBm)	Limit (dBm)	Margin (dB)
Low	2412	-9.04	8.0	-17.0
Mid	2437	-9.39	8.0	-17.4
High	2462	-12.55	8.0	-20.5
High	2467	-14.49	8.0	-22.5
High	2472	-19.48	8.0	-27.5

**PSD**

