



FCC 47 CFR PART 15 SUBPART E

**CERTIFICATION TEST REPORT
CLASS II PERMISSIVE CHANGE**

FOR

TABLET DEVICE

MODEL NUMBER: A1490

FCC ID: BCGA1490

REPORT NUMBER: 15U21850-E10V2

ISSUE DATE: DECEMBER 02, 2015

Prepared for

APPLE, INC.

1 INFINITE LOOP

CUPERTINO, CA 95014, U.S.A.

Prepared by

UL VERIFICATION SERVICES INC.

47173 BENICIA STREET

FREMONT, CA 94538, U.S.A.

TEL: (510) 771-1000

FAX: (510) 661-0888



NVLAP LAB CODE 200065-0

Revision History

<u>Rev.</u>	<u>Issue Date</u>	<u>Revisions</u>	<u>Revised By</u>
V1	11/16/2015	Initial Issue	M. Mekuria
V2	12/02/2015	Revised report to address TCB's questions	T. Chu

TABLE OF CONTENTS

1. ATTESTATION OF TEST RESULTS	5
2. TEST METHODOLOGY	6
3. FACILITIES AND ACCREDITATION	6
4. CALIBRATION AND UNCERTAINTY	7
4.1. MEASURING INSTRUMENT CALIBRATION	7
4.2. SAMPLE CALCULATION	7
4.3. MEASUREMENT UNCERTAINTY	7
5. EQUIPMENT UNDER TEST	8
5.1. DESCRIPTION OF EUT	8
5.2. DESCRIPTION OF CLASS II PERMISSIVE CHANGE	8
5.3. MAXIMUM OUTPUT POWER	8
5.4. DESCRIPTION OF AVAILABLE ANTENNAS	8
5.5. SOFTWARE AND FIRMWARE	8
5.6. WORST-CASE CONFIGURATION AND MODE	9
5.7. DESCRIPTION OF TEST SETUP	10
6. TEST AND MEASUREMENT EQUIPMENT	17
7. ON TIME, DUTY CYCLE AND MEASUREMENT METHODS	18
7.1. ON TIME AND DUTY CYCLE	18
7.2. MEASUREMENT METHODS	21
8. ANTENNA PORT TEST RESULTS	22
8.1. 802.11a MODE 1TX MODE IN THE 5.8 GHz BAND	22
8.1.1. 6 dB BANDWIDTH	22
8.1.2. 26 dB BANDWIDTH	25
8.1.3. 99% BANDWIDTH	28
8.1.4. AVERAGE POWER	31
8.1.5. OUTPUT POWER	32
8.1.6. PSD	34
8.2. 802.11n HT20 2Tx CDD MODE IN THE 5.8 GHz BAND	37
8.2.1. 6 dB BANDWIDTH	37
8.2.2. 26 dB BANDWIDTH	41
8.2.3. 99% BANDWIDTH	45
8.2.4. AVERAGE POWER	49
8.2.5. OUTPUT POWER	50
8.2.6. PSD	52
8.3. 802.11n HT20 2Tx STBC MODE IN THE 5.8 GHz BAND	57
8.4. 802.11n HT40 1TX MODE IN THE 5.8 GHz BAND	58
8.4.1. 6 dB BANDWIDTH	58

8.4.2.	26 dB BANDWIDTH	60
8.4.3.	99% BANDWIDTH.....	62
8.4.4.	AVERAGE POWER.....	64
8.4.5.	OUTPUT POWER	65
8.4.6.	PSD.....	67
8.5.	<i>802.11n HT40 2Tx CDD MODE IN THE 5.8 GHz BAND</i>	70
8.5.1.	6 dB BANDWIDTH	70
8.5.2.	26 dB BANDWIDTH	73
8.5.3.	99% BANDWIDTH.....	76
8.5.4.	AVERAGE POWER.....	79
8.5.5.	OUTPUT POWER	80
8.5.6.	PSD.....	82
8.6.	<i>802.11n HT40 2Tx STBC MODE IN THE 5.8 GHz BAND</i>	86
9.	RADIATED TEST RESULTS	87
9.1.	<i>LIMITS AND PROCEDURE</i>	87
9.2.	<i>802.a 1Tx MODE IN THE 5.8 GHz BAND</i>	88
9.2.1.	CHAIN 0, RESTRICTED BANDEDGE, (LOW CHANNEL).....	88
9.2.2.	CHAIN 1, RESTRICTED BANDEDGE.....	98
9.3.	<i>802.11n HT20 2Tx CDD MODE IN THE 5.8 GHz BAND</i>	108
9.4.	<i>802.11n HT40 1Tx MODE IN THE 5.8 GHz BAND</i>	118
9.4.1.	CHAIN 0, RESTRICTED BANDEDGE.....	118
9.4.2.	CHAIN 1, RESTRICTED BANDEDGE.....	126
9.5.	<i>802.11n HT40 2Tx CDD MODE IN THE 5.8 GHz BAND</i>	134
9.6.	<i>WORST-CASE BELOW 1 GHz</i>	142
9.7.	<i>WORST-CASE ABOVE 18 GHz</i>	144
10.	AC POWER LINE CONDUCTED EMISSIONS	148
10.1.	<i>EUT POWERED BY AC ADAPTER</i>	149
10.2.	<i>EUT POWERED BY HOST PC VIA USB CABLE</i>	151
11.	SETUP PHOTOS	153

1. ATTESTATION OF TEST RESULTS

COMPANY NAME: APPLE, INC.
1 INFINITE LOOP
CUPERTINO, CA 95014, U.S.A.

EUT DESCRIPTION: TABLET DEVICE

MODEL: A1490

SERIAL NUMBER: DLXL400DFPLY(Conducted), DLXL400QFPLY (Radiated)

DATE TESTED: OCTOBER 6, 2015 TO NOVEMBER 09, 2015

APPLICABLE STANDARDS	
STANDARD	TEST RESULTS
CFR 47 Part 15 Subpart E	Pass

UL Verification Services Inc. tested the above equipment in accordance with the requirements set forth in the above standards. All indications of Pass/Fail in this report are opinions expressed by UL Verification Services Inc. based on interpretations and/or observations of test results. Measurement Uncertainties were not taken into account and are published for informational purposes only. The test results show that the equipment tested is capable of demonstrating compliance with the requirements as documented in this report.

Note: The results documented in this report apply only to the tested sample, under the conditions and modes of operation as described herein. This document may not be altered or revised in any way unless done so by UL Verification Services Inc. and all revisions are duly noted in the revisions section. Any alteration of this document not carried out by UL Verification Services Inc. will constitute fraud and shall nullify the document. This report must not be used by the client to claim product certification, approval, or endorsement by NVLAP, NIST, any agency of the Federal Government, or any agency of any government.

Approved & Released For
UL Verification Services Inc. By:

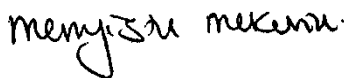

MENGISTU MEKURIA
SENIOR ENGINEER
UL VERIFICATION SERVICES INC.

Tested By:



ERIC YU
EMC LAB ENGINEER
UL VERIFICATION SERVICES INC.

2. TEST METHODOLOGY

The tests documented in this report were performed in accordance with FCC CFR 47 Part 2, FCC CFR 47 Part 15, FCC 14-30, FCC KDB 789033 D02 v01, ANSI C63.10-2013.

3. FACILITIES AND ACCREDITATION

The test sites and measurement facilities used to collect data are located at 47173 and 47266 Benicia Street, Fremont, California, USA. Line conducted emissions are measured only at the 47173 address. The following table identifies which facilities were utilized for radiated emission measurements documented in this report. Specific facilities are also identified in the test results sections.

47173 Benicia Street	47266 Benicia Street
<input type="checkbox"/> Chamber A	<input checked="" type="checkbox"/> Chamber D
<input type="checkbox"/> Chamber B	<input type="checkbox"/> Chamber E
<input type="checkbox"/> Chamber C	<input type="checkbox"/> Chamber F
	<input checked="" type="checkbox"/> Chamber G
	<input type="checkbox"/> Chamber H

The above test sites and facilities are covered under FCC Test Firm Registration # 208313. Chambers A through H are covered under Industry Canada company address code 2324B with site numbers 2324B -1 through 2324B-8, respectively.

UL Verification Services Inc. is accredited by NVLAP, Laboratory Code 200065-0. The full scope of accreditation can be viewed at <http://ts.nist.gov/standards/scopes/2000650.htm>.

4. CALIBRATION AND UNCERTAINTY

4.1. MEASURING INSTRUMENT CALIBRATION

The measuring equipment utilized to perform the tests documented in this report has been calibrated in accordance with the manufacturer's recommendations, and is traceable to recognized national standards.

4.2. SAMPLE CALCULATION

Where relevant, the following sample calculation is provided:

$$\begin{aligned} \text{Field Strength (dBuV/m)} &= \text{Measured Voltage (dBuV)} + \text{Antenna Factor (dB/m)} + \text{Cable} \\ &\text{Loss (dB)} - \text{Preamp Gain (dB)} \\ 36.5 \text{ dBuV} + 18.7 \text{ dB/m} + 0.6 \text{ dB} - 26.9 \text{ dB} &= 28.9 \text{ dBuV/m} \end{aligned}$$

4.3. MEASUREMENT UNCERTAINTY

Where relevant, the following measurement uncertainty levels have been estimated for tests performed on the apparatus:

PARAMETER	UNCERTAINTY
Conducted Disturbance, 0.15 to 30 MHz	± 3.52 dB
Radiated Disturbance, 30 to 1000 MHz	± 4.94 dB
Radiated Disturbance, 1 to 6 GHz	± 3.86 dB
Radiated Disturbance, 6 to 18 GHz	± 4.23 dB
Radiated Disturbance, 18 to 26 GHz	± 5.30 dB
Radiated Disturbance, 26 to 40 GHz	± 5.23 dB

Uncertainty figures are valid to a confidence level of 95%.

5. EQUIPMENT UNDER TEST

5.1. DESCRIPTION OF EUT

The Apple iPad Model A1490 is a Tablet with cellular GSM/GPRS/EGPRS/WCDMA/HSPA+ DC-HSDPA/ CDMA 1xRTT/1x Advanced/EV-DO Rev 0, A, B/LTE/IEEE 802.11a/b/g/n (MIMO 2x2) and Bluetooth radio.

5.2. DESCRIPTION OF CLASS II PERMISSIVE CHANGE

Upgrade 5.8GHz band to new rule per KDB 789033 D02 v01.

5.3. MAXIMUM OUTPUT POWER

The transmitter has a maximum conducted output power as follows:

5.8GHz Band

Frequency Range (MHz)	Mode	Output Power (dBm)	Output Power (mW)
5745 - 5825	802.11a	15.44	34.99
5745 - 5825	802.11n HT20 SISO	Covered by 802.11a SISO	
5745 - 5825	802.11a 2TX CDD	Covered by 802.11n HT20 CDD 2TX	
5745 - 5825	802.11n HT20 CDD 2TX	18.42	69.50
5745 - 5825	802.11n HT20 STBC/SDM 2TX	Covered by 802.11n HT20 CDD 2TX	
5755 - 5795	802.11n HT40 SISO	15.50	35.48
5755 - 5795	802.11n HT40 CDD 2TX	18.34	68.23
5755 - 5795	802.11n HT40 STBC/SDM 2TX	Covered by 802.11n HT40 CDD 2TX	

5.4. DESCRIPTION OF AVAILABLE ANTENNAS

Frequency Band (GHz)	Antenna Gain	
	Chain 0	Chain 1
5.8	2.68	3.76

5.5. SOFTWARE AND FIRMWARE

The test utility software used during testing was Broadcom WL Tool Version 6.25.86.

5.6. WORST-CASE CONFIGURATION AND MODE

There are two vendors of the WiFi/Bluetooth radio modules: BOM #1, vender1 and BOM #2, vender 2, and they have the same mechanical outline, same on board antenna, matching circuit, antenna structure and same specification and baseline was performed on both vendors to determine the worst case on conducted power and radiated emissions.

The fundamental of the EUT was investigated in three orthogonal orientations X,Y,Z, it was determined that Z orientation was worst-case orientation for 5GHz; therefore, all final radiated testing was performed with the EUT in Z orientation for 5GHz.

Worst-case data rates as provided by the client were:

802.11a mode: 6 Mbps
802.11n HT20mode: MCS0
802.11n HT40mode: MCS0

Worst-case mode and channel used for 30-1000 MHz radiated and power line conducted emissions was including headset, AC charger and the mode and channel with the highest output power.

For all modes with single chain, chain 0 was selected per the software provided by the client. Based on the client a preliminary investigation was performed on the two chains and chain 0 was found to be worst-case for the antenna port. The radiated emissions test was tested on both Chain 0 and 1.

5.7. DESCRIPTION OF TEST SETUP

SUPPORT EQUIPMENT

Support Equipment List				
Description	Manufacturer	Model	Serial Number	FCC ID
Laptop	Apple	MacBook Pro	73043BDQAGU	N/A
Laptop AC/DC adapter	Apple	A1172	MV7211FJAX4XA	N/A
Earphone	Apple	NA	NA	N/A
EUT AC/DC adapter	Apple	A1357	W010A051	N/A

I/O CABLES (CONDUCTED TEST)

I/O Cable List						
Cable No	Port	# of identical ports	Connector Type	Cable Type	Cable Length (m)	Remarks
1	Antenna	1	SMA	Un-Shielded	0.2	To spectrum Analyzer
2	USB	1	USB	Shielded	1	N/A
3	AC	1	AC	Un-shielded	3	N/A

I/O CABLES (RADIATED ABOVE 1 GHZ)

I/O Cable List						
Cable No	Port	# of identical ports	Connector Type	Cable Type	Cable Length (m)	Remarks
None Used						

I/O CABLES (RADIATED BELOW 1 GHZ)

I/O Cable List						
Cable No	Port	# of identical	Connector Type	Cable Type	Cable Length (m)	Remarks
1	Headphones Jack	1	3.5mm Audio	Shielded	0.9	N/A
2	AC	1	AC	Un-shielded	3	N/A

I/O CABLES (AC LINE CONDUCTED: AC/DC ADAPTER)

I/O Cable List						
Cable No	Port	# of identical	Connector Type	Cable Type	Cable Length (m)	Remarks
1	Headphones Jack	1	3.5mm Audio	Shielded	0.9	N/A
2	AC	1	AC	Un-shielded	3	N/A

I/O CABLES (AC LINE CONDUCTED: LAPTOP CONFIGUARTION)

I/O Cable List						
Cable No	Port	# of identical	Connector Type	Cable Type	Cable Length (m)	Remarks
1	Headphones Jack	1	3.5mm Audio	Shielded	0.9	N/A
2	USB	1	USB	Shielded	1	N/A
3	AC	1	AC	Un-shielded	3	N/A

TEST SETUP - CONDUCTED TESTS

The EUT was tested connected to a host Laptop via USB cable adapter and spectrum analyzer to antenna port. Test software exercised the EUT.

SETUP DIAGRAM

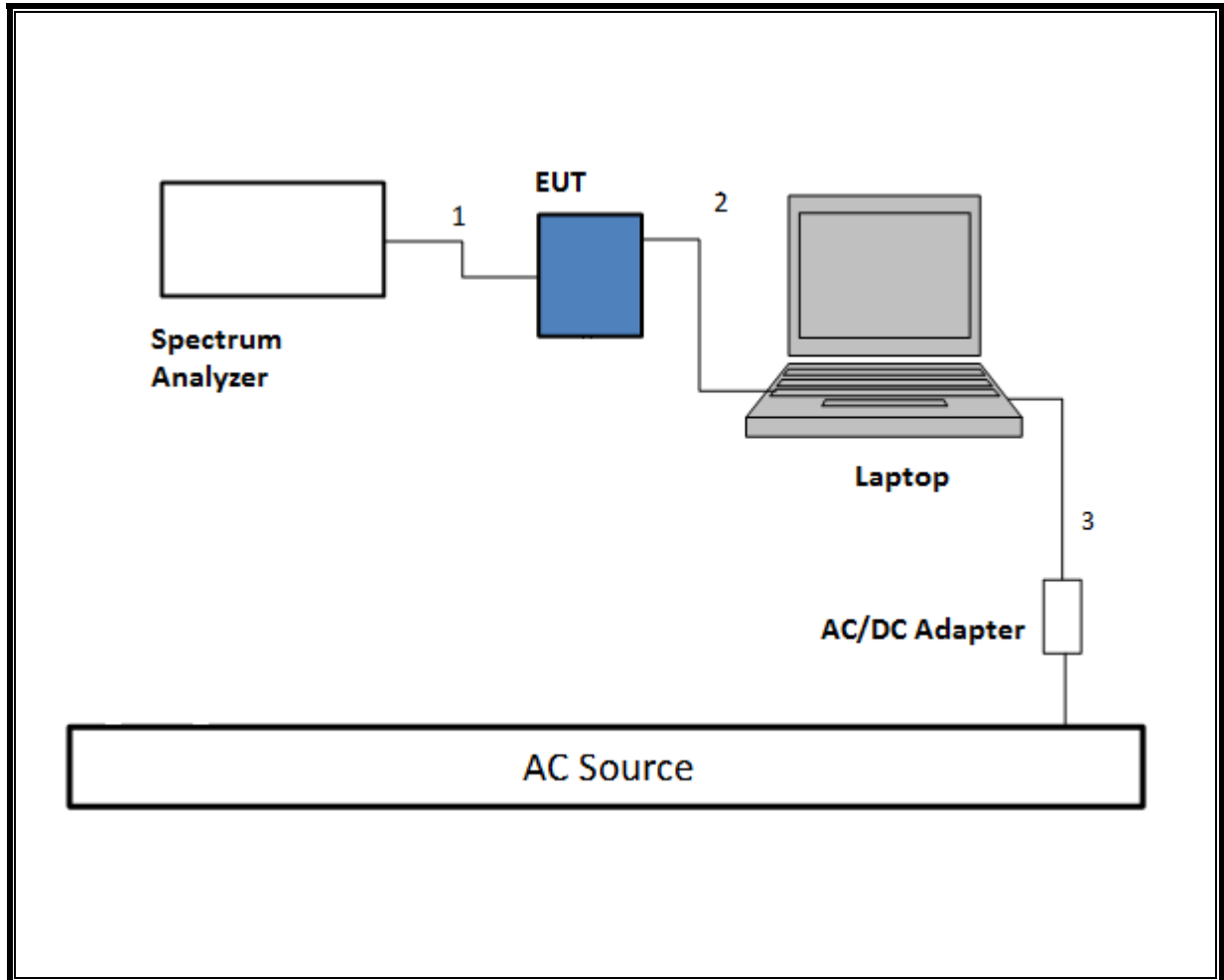

TEST SETUP- RADIATED-ABOVE 1 GHZ

The EUT was tested battery powered. Test software exercised the EUT.

SETUP DIAGRAM

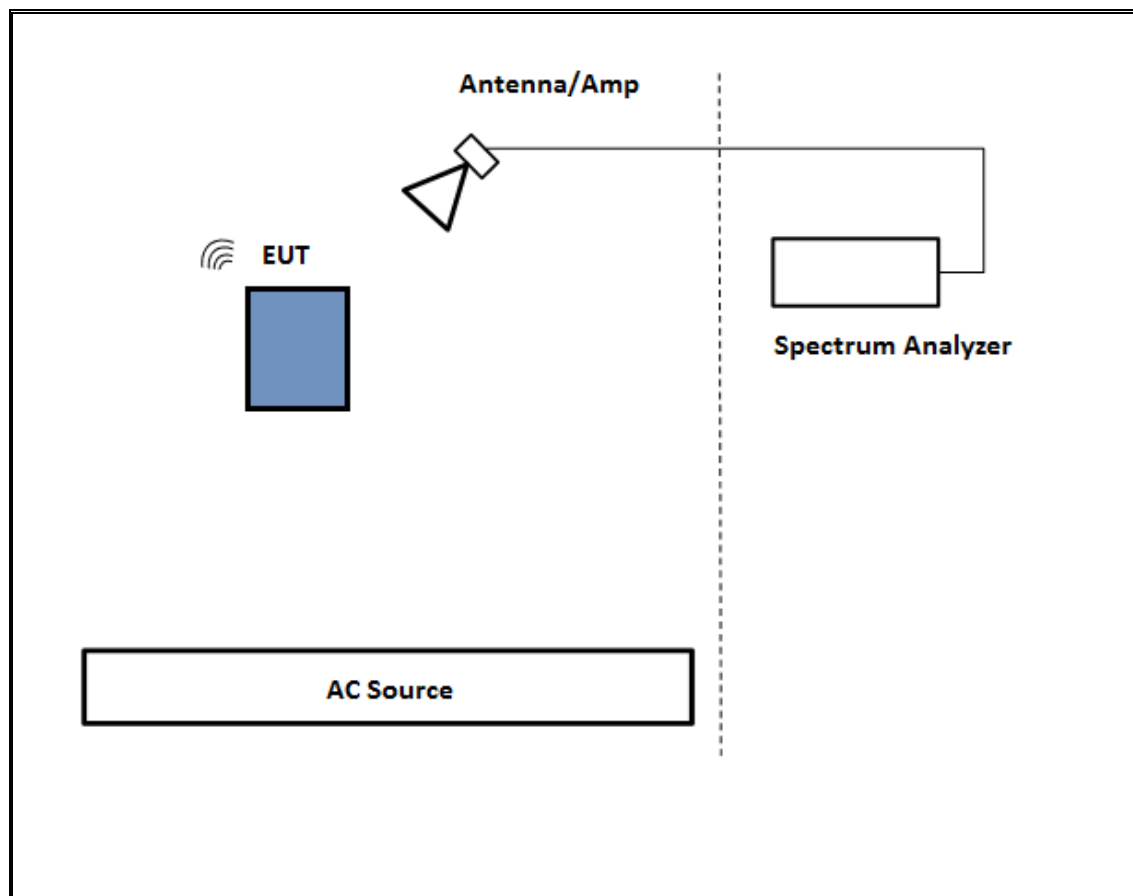

TEST SETUP- BELOW 1GHz

The EUT was tested with earphone connected and powered by AC adapter. Test software exercised the EUT.

SETUP DIAGRAM

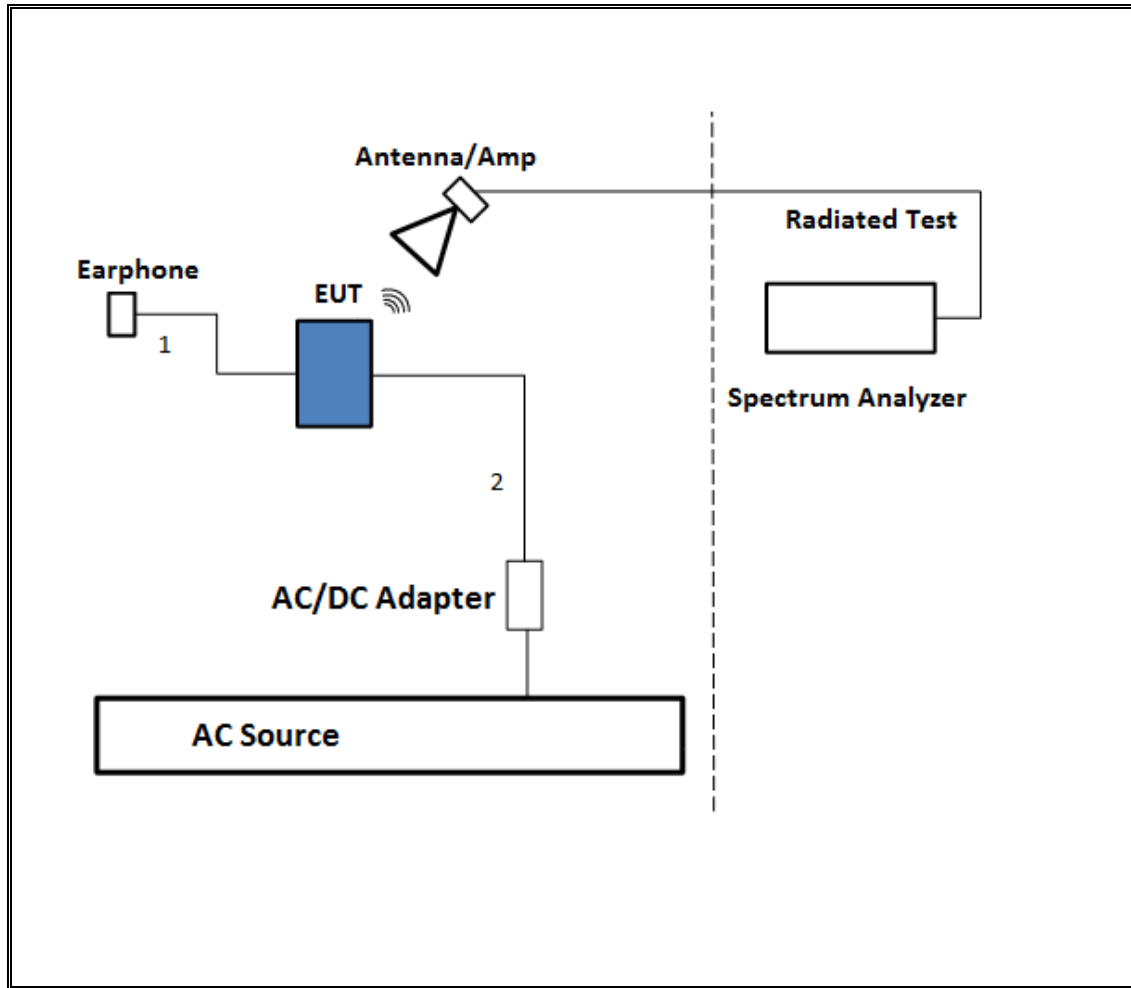

TEST SETUP- AC LINE CONDUCTED: AC/DC ADAPTER

The EUT was tested with earphone connected and powered by AC/DC adapter via USB cable. Test software exercised the EUT.

SETUP DIAGRAM

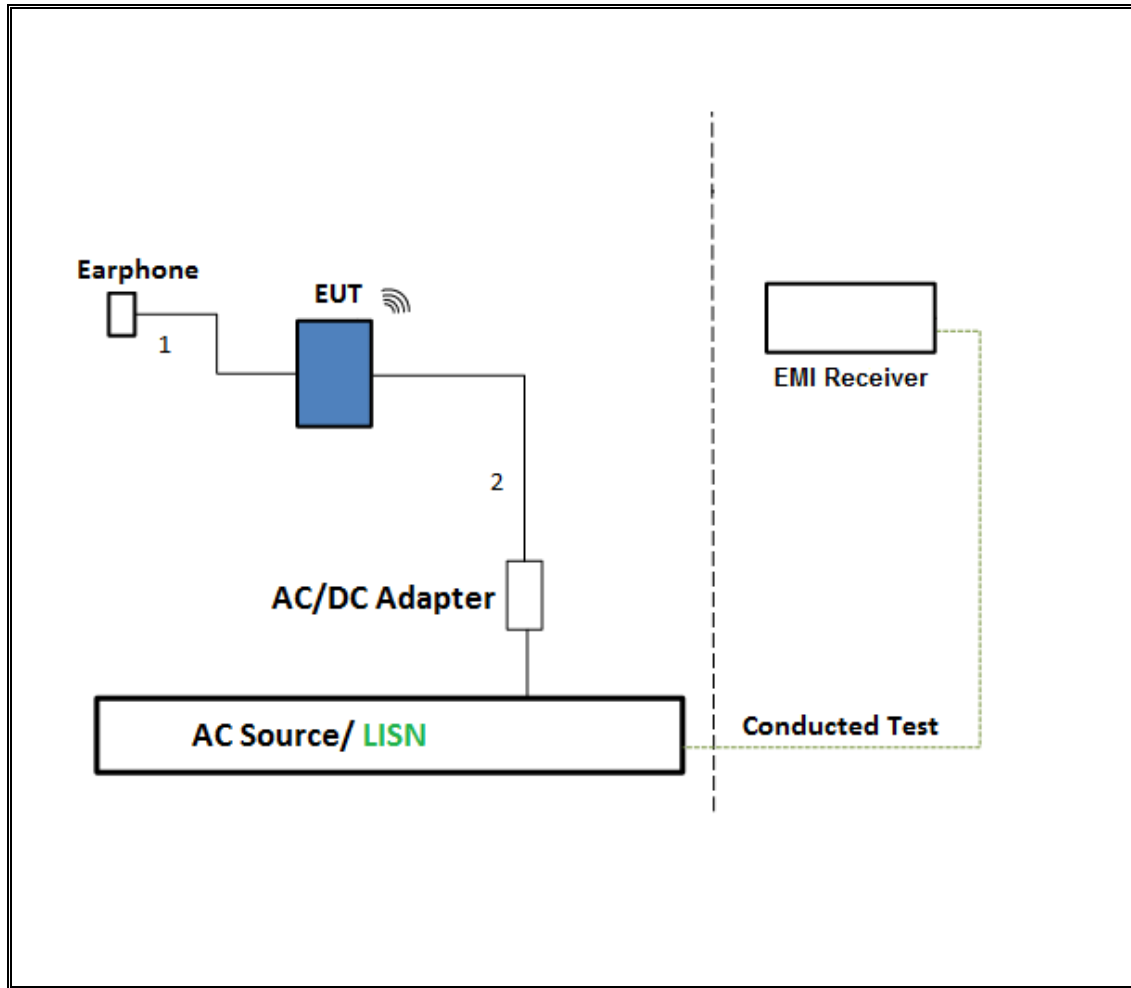

TEST SETUP- AC LINE CONDUCTED: LAPTOP CONFIGURATION

The EUT was tested with earphone connected and powered by host PC via USB cable. Test software exercised the EUT.

SETUP DIAGRAM

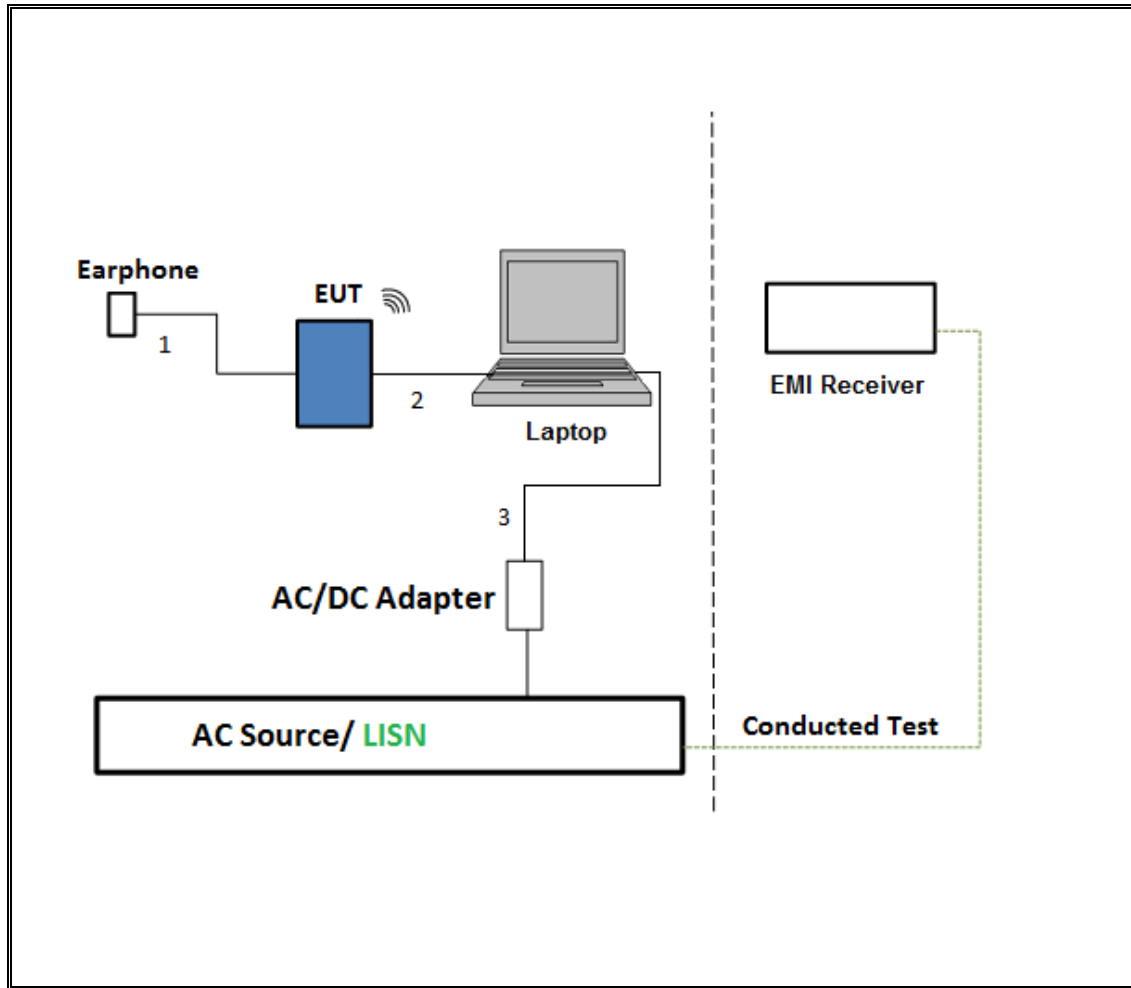

6. TEST AND MEASUREMENT EQUIPMENT

The following test and measurement equipment was utilized for the tests documented in this report:

Test Equipment List				
Description	Manufacturer	Model	Asset	Cal Due
Antenna, Horn 1-18GHz	ETS Lindgren	3117	00143448	2/10/2016
Antenna, Broadband Hybrid, 30MHz to 2000MHz	Sunol Sciences	JB3	A022813-2	3/5/2016
Amplifier, 1 - 18GHz	Miteq	AFS42-00101800-25-S-42	1782158	1/26/2016
Amplifier, 10KHz to 1GHz, 32dB	Sonoma	310N	323562	5/7/2016
Spectrum Analyzer, PXA, 3Hz to 44GHz	Keysight	N9030A	MY52350675	11/12/2015
Spectrum Analyzer, PXA, 3Hz to 44GHz	Keysight	N9030A	MY54490254	12/10/2015
Power Sensor, P - series, 50MHz to 18GHz, Wideband	Keysight	N1921A	MY55200002	3/6/2016
Power Sensor, P - series, 50MHz to 18GHz, Wideband	Keysight	N1921A	MY55200004	5/6/2016
Antenna, Horn 18 to 26.5GHz	ARA	MWH-1826	1049	12/17/2015
Horn Antenna, 40GHz	ARA	MWH-2640/B	1029	7/28/2016
Spectrum Analyzer, 40 GHz	Agilent	8564E	3943A01643	8/6/2016
Amplifier, 1 to 26.5GHz, 23.5dB Gain minimum	Keysight	8449B	3008A04710	6/29/2016
Amplifier, 26 - 40GHz	Miteq	NSP4000-SP2	924343	4/7/2016
AC Line Conducted				
EMI Test Receiver 9Khz-7GHz	Rohde & Schwarz	ESC17	100773	8/7/2016
LISN for Conducted Emissions CISPR-16	FCC	50/250-25-2	114	1/16/2016
Power Cable, Line Conducted Emissions ANSI 63.4	UL	PG1	N/A	7/28/2016
UL SOFTWARE				
*Radiated Software	UL	UL EMC	Ver 9.5, July 22, 2014	
*Conducted Software	UL	UL EMC	Ver 2.2, March 31, 2015	
*AC Line Conducted Software	UL	UL EMC	Ver 9.5, April 3, 2015	

Note: * indicates automation software version used in the compliance certification testing

7. ON TIME, DUTY CYCLE AND MEASUREMENT METHODS

7.1. ON TIME AND DUTY CYCLE

LIMITS

None; for reporting purposes only.

PROCEDURE

KDB 789033 Zero-Span Spectrum Analyzer Method.

RESULTS

Mode	ON Time B (msec)	Period (msec)	Duty Cycle x (linear)	Duty Cycle (%)	Duty Cycle Correction Factor (dB)	1/B Minimum VBW (kHz)
802.11a 1TX	2.064	2.094	0.986	98.57%	0.00	0.010
802.11n HT20 CDD	2.065	2.090	0.988	98.80%	0.00	0.010
802.11n HT40 1TX	0.932	0.960	0.971	97.12%	0.13	1.073
802.11n HT40 CDD	0.932	0.958	0.973	97.29%	0.12	1.073

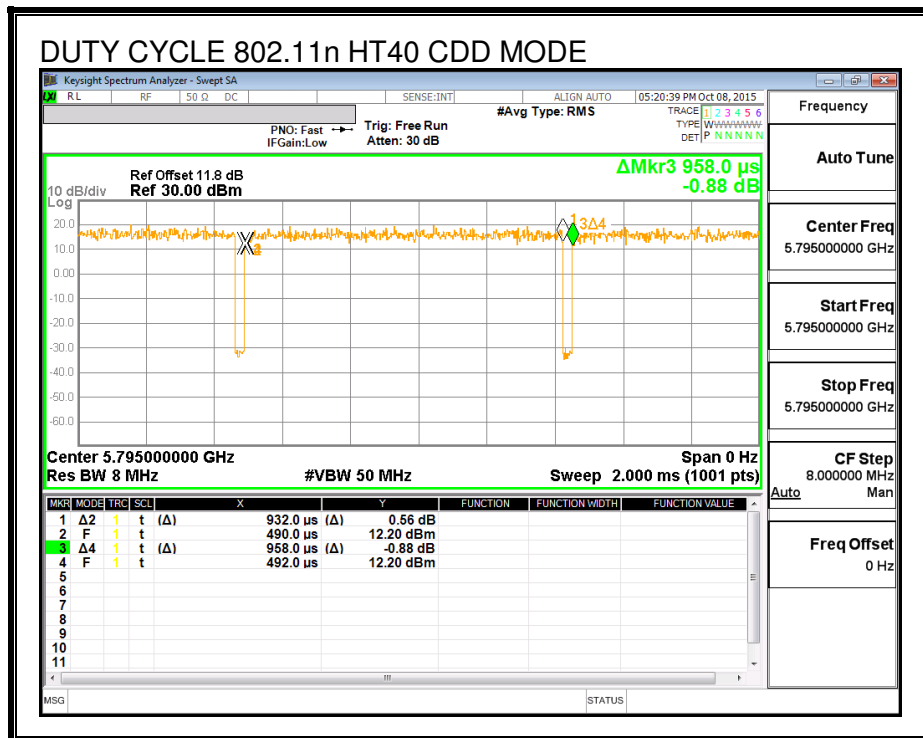
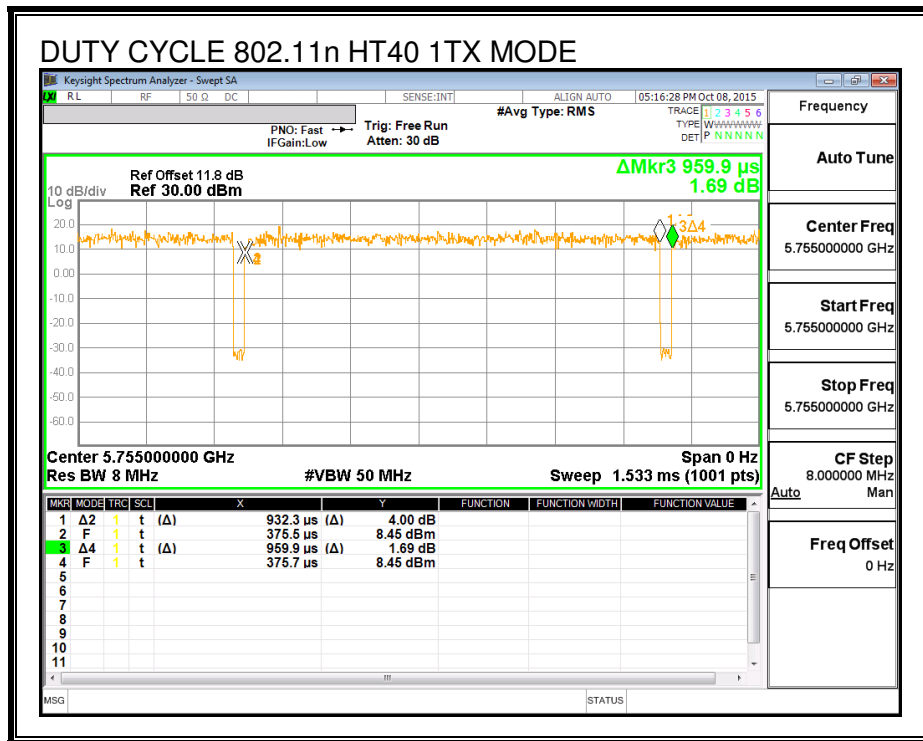

7.2. MEASUREMENT METHODS

26 dB Emission BW & 6 dB Emission BW: KDB 789033 D02 v01, Section C.

99% Occupied BW: KDB 789033 D02 v01, Section D.

Conducted Output Power: KDB 789033 D02 v01, Section E.3.b (Method PM-G).

Power Spectral Density: KDB 789033 D02 v01, Section F.

Unwanted emissions in restricted bands: KDB 789033 D02 v01, Sections G.3, G.4, G.5, and G.6.

Unwanted emissions in non-restricted bands: KDB 789033 D02 v01, Sections G.3, G.4, and G.5.

8. ANTENNA PORT TEST RESULTS

8.1. 802.11a MODE 1TX MODE IN THE 5.8 GHz BAND

8.1.1. 6 dB BANDWIDTH

LIMITS

FCC §15.407 (e)

The minimum 6 dB bandwidth shall be at least 500 kHz.

RESULTS

Channel	Frequency (MHz)	6 dB Bandwidth (MHz)	Minimum Limit (MHz)
Low	5745	16.03	0.5
Mid	5785	16.30	0.5
High	5825	16.15	0.5

8.1.2. 26 dB BANDWIDTH

LIMITS

None, for reporting purposes only

RESULTS

Channel	Frequency (MHz)	26 dB Bandwidth (MHz)
Low	5745	19.43
Mid	5785	19.50
High	5825	19.45

8.1.3. 99% BANDWIDTH

LIMITS

None; for reporting purposes only.

RESULTS

Frequency (MHz)	99% Bandwidth (MHz)
5745	16.323
5785	16.314
5825	16.347

99% BANDWIDTH

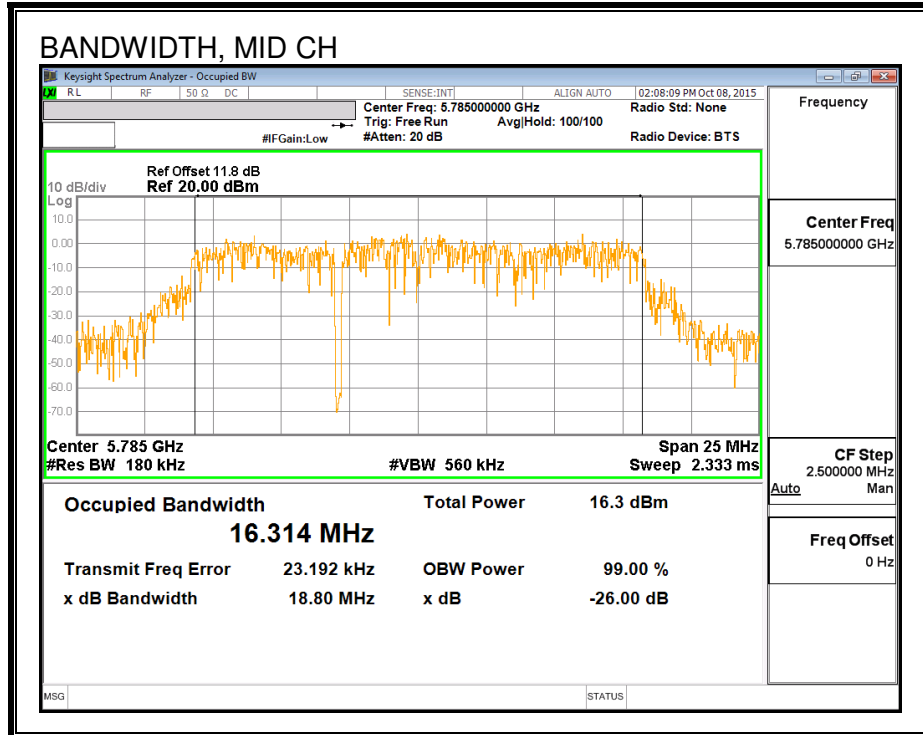
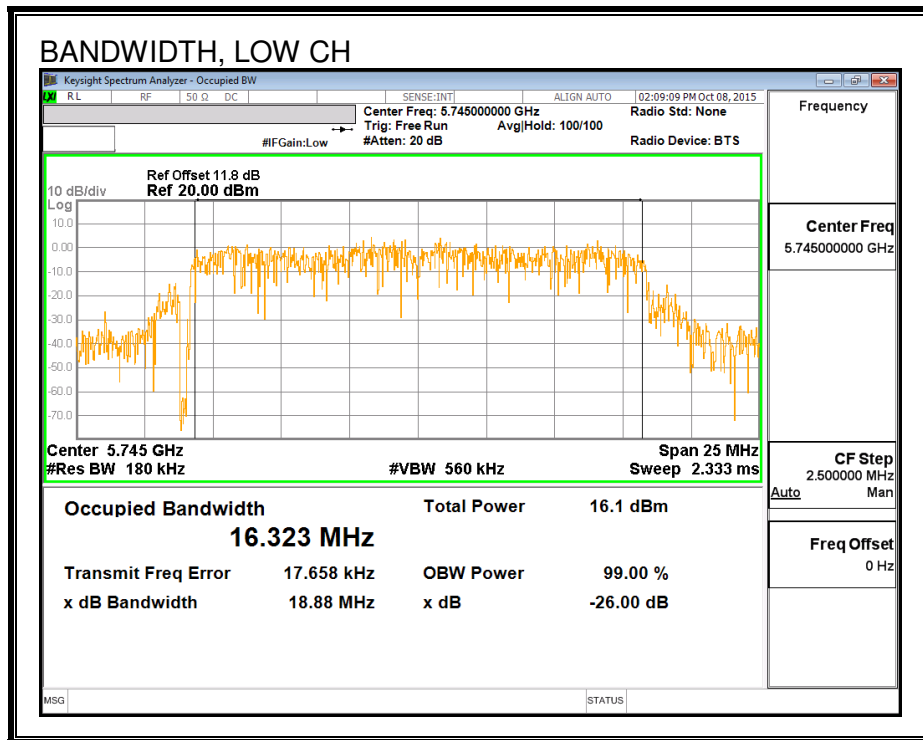

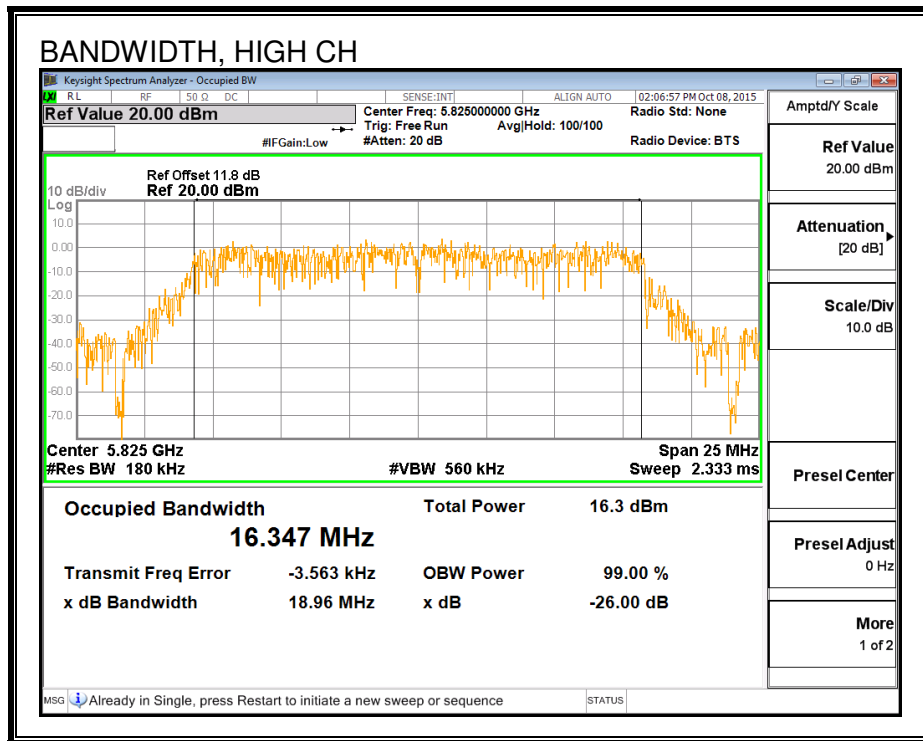

8.1.4. AVERAGE POWER

LIMITS

None; for reporting purposes only.

Test Procedure

Measurements perform using a wideband gated RF power meter.

RESULTS

Channel	Frequency (MHz)	Power (dBm)
Low	5745	15.44
Mid	5785	15.42
High	5825	15.43

8.1.5. OUTPUT POWER

LIMITS

FCC §15.407 (a) (3)

For the band 5.725-5.85 GHz, the maximum conducted output power over the frequency band of operation shall not exceed 1 W. In addition, the maximum power spectral density shall not exceed 30 dBm in any 500-kHz band. If transmitting antennas of directional gain greater than 6 dBi are used, both the maximum conducted output power and the maximum power spectral density shall be reduced by the amount in dB that the directional gain of the antenna exceeds 6 dBi.

Test Procedure

Measurements perform using a wideband gated RF power meter provided that the gate parameters are adjusted such that the power is measured only when the EUT is transmitting at its maximum power control level. Since the measurement is made only during the ON time of the transmitter, no duty cycle correction factor is required.

DIRECTIONAL ANTENNA GAIN

There is only one transmitter output therefore the directional gain is equal to the antenna gain.

RESULTS

Antenna Gain and Limit

Channel	Frequency (MHz)	Directional Gain for Power (dBi)	Power Limit (dBm)
Low	5745	3.76	30.00
Mid	5785	3.76	30.00
High	5825	3.76	30.00

Output Power Results

Channel	Frequency (MHz)	Chain 0 Meas Power (dBm)	Total Corr'd Power (dBm)	Power Limit (dBm)	Power Margin (dB)
Low	5745	15.44	15.44	30.00	-14.56
Mid	5785	15.42	15.42	30.00	-14.58
High	5825	15.43	15.43	30.00	-14.57

8.1.6. PSD

LIMITS

FCC §15.407 (a) (3)

For the band 5.725-5.85 GHz, the maximum conducted output power over the frequency band of operation shall not exceed 1 W. In addition, the maximum power spectral density shall not exceed 30 dBm in any 500-kHz band. If transmitting antennas of directional gain greater than 6 dBi are used, both the maximum conducted output power and the maximum power spectral density shall be reduced by the amount in dB that the directional gain of the antenna exceeds 6 dBi.

DIRECTIONAL ANTENNA GAIN

There is only one transmitter output therefore the directional gain is equal to the antenna gain.

RESULTS

Antenna Gain and Limits

Channel	Frequency (MHz)	Directional Gain (dBi)	PSD Limit (dBm)
Low	5745	3.76	30.00
Mid	5785	3.76	30.00
High	5825	3.76	30.00

Duty Cycle CF (dB)	0.00	Included in Calculations of Corr'd PSD
---------------------------	------	---

PSD Results

Channel	Frequency (MHz)	Chain 0 Meas PSD (dBm)	Total Corr'd PSD (dBm)	PSD Limit (dBm)	PSD Margin (dB)
Low	5745	3.68	3.68	30.00	-26.32
Mid	5785	3.41	3.41	30.00	-26.59
High	5825	3.36	3.36	30.00	-26.64

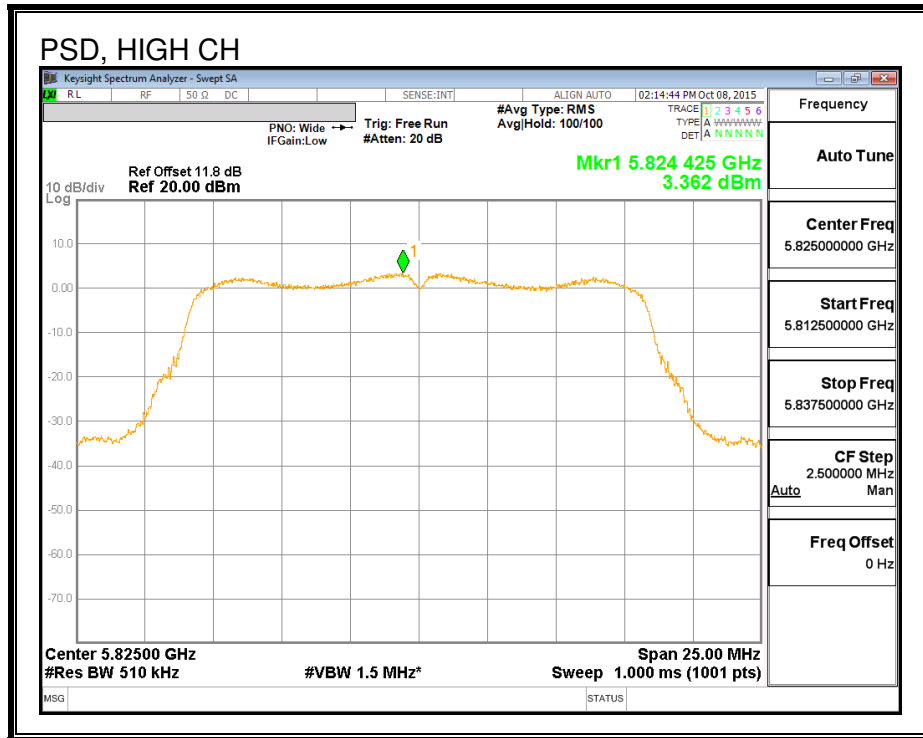

8.2. 802.11n HT20 2Tx CDD MODE IN THE 5.8 GHz BAND

8.2.1. 6 dB BANDWIDTH

LIMITS

FCC §15.407 (e)

The minimum 6 dB bandwidth shall be at least 500 kHz.

RESULTS

Channel	Frequency (MHz)	6 dB BW Chain 0 (MHz)	6 dB BW Chain 1 (MHz)	Minimum Limit (MHz)
Low	5745	17.55	17.60	0.5
Mid	5785	17.60	17.58	0.5
High	5825	17.58	17.63	0.5

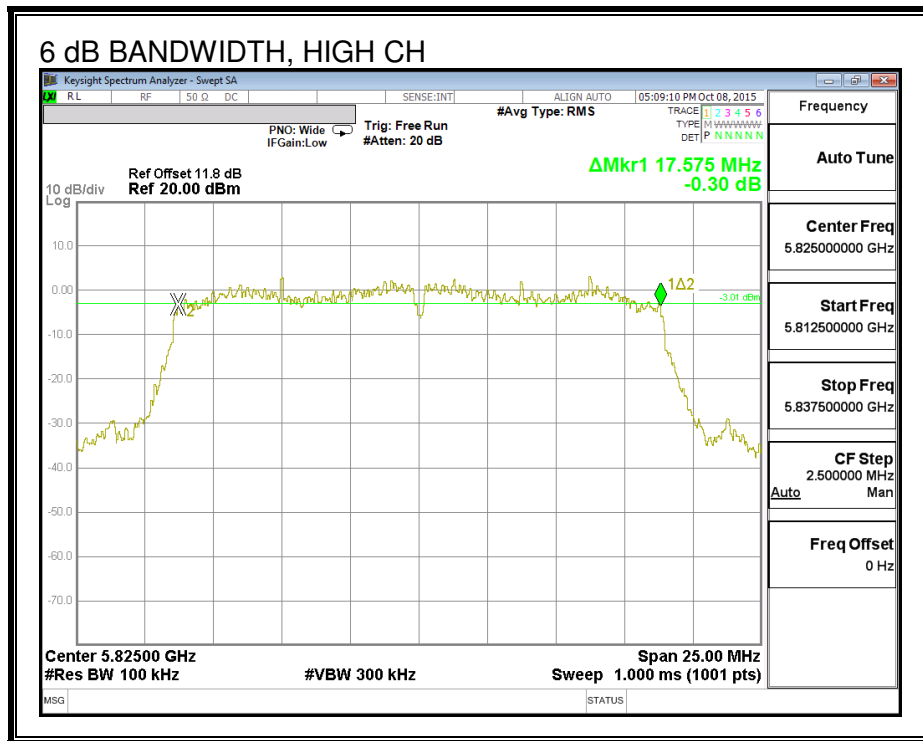

6 dB BANDWIDTH, CHAIN 1

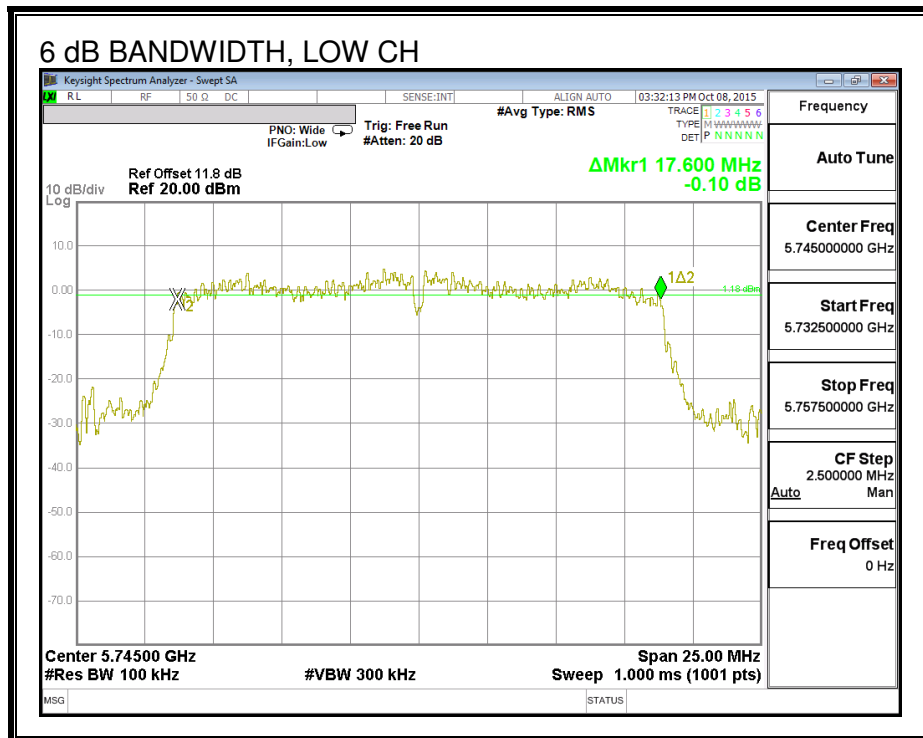

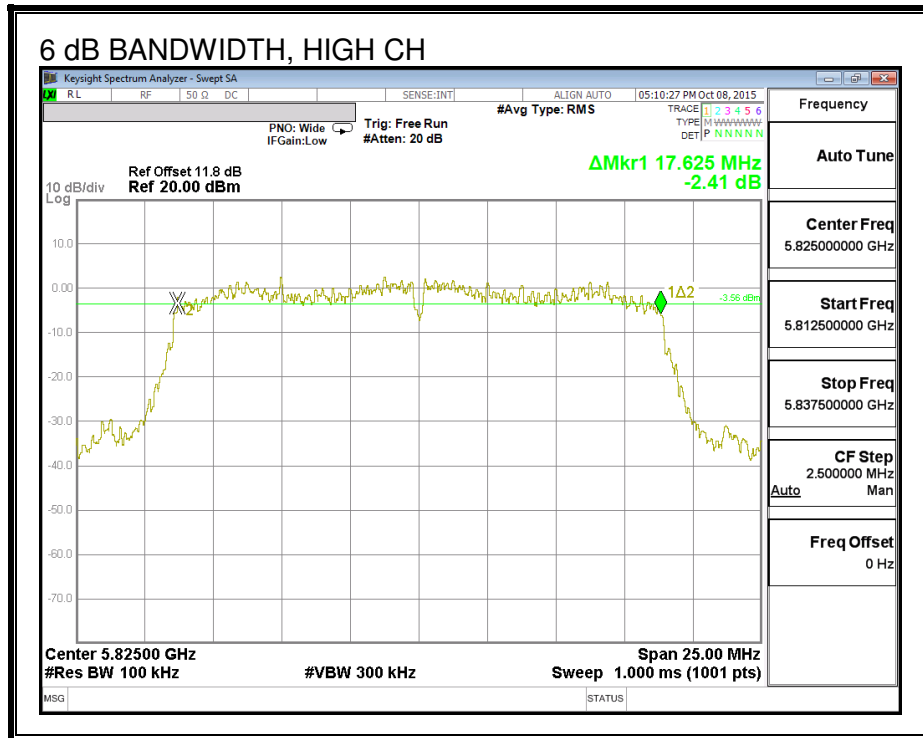
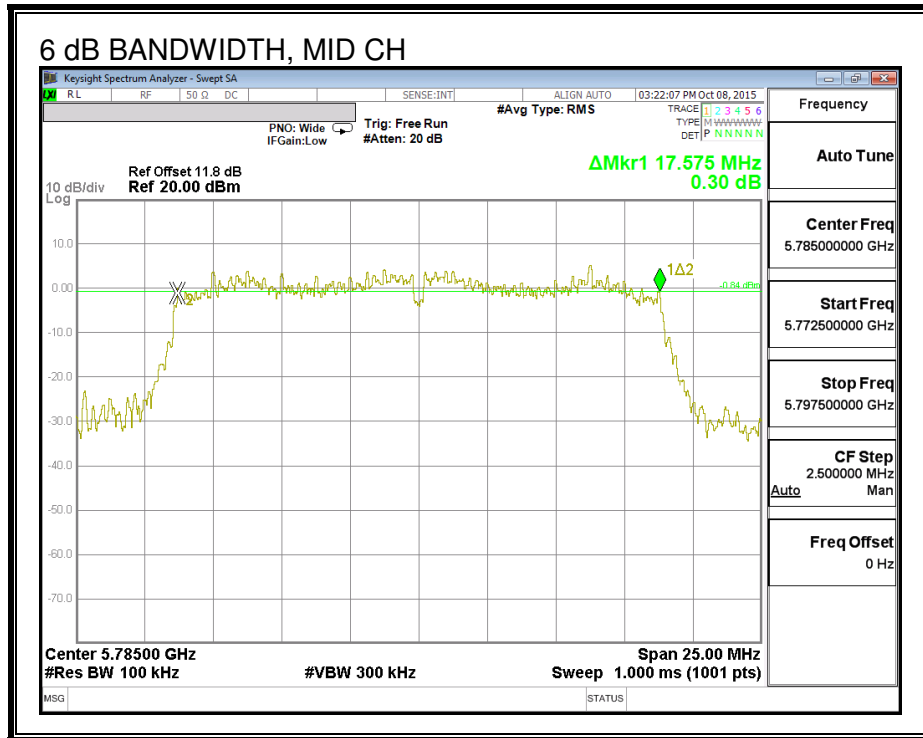

8.2.2. 26 dB BANDWIDTH

LIMITS

None, for reporting purposes only.

RESULTS

Channel	Frequency (MHz)	26 dB BW Chain 0 (MHz)	26 dB BW Chain 1 (MHz)
Low	5745	19.68	19.63
Mid	5785	19.63	19.88
High	5825	19.83	19.68

26 dB BANDWIDTH, CHAIN 0

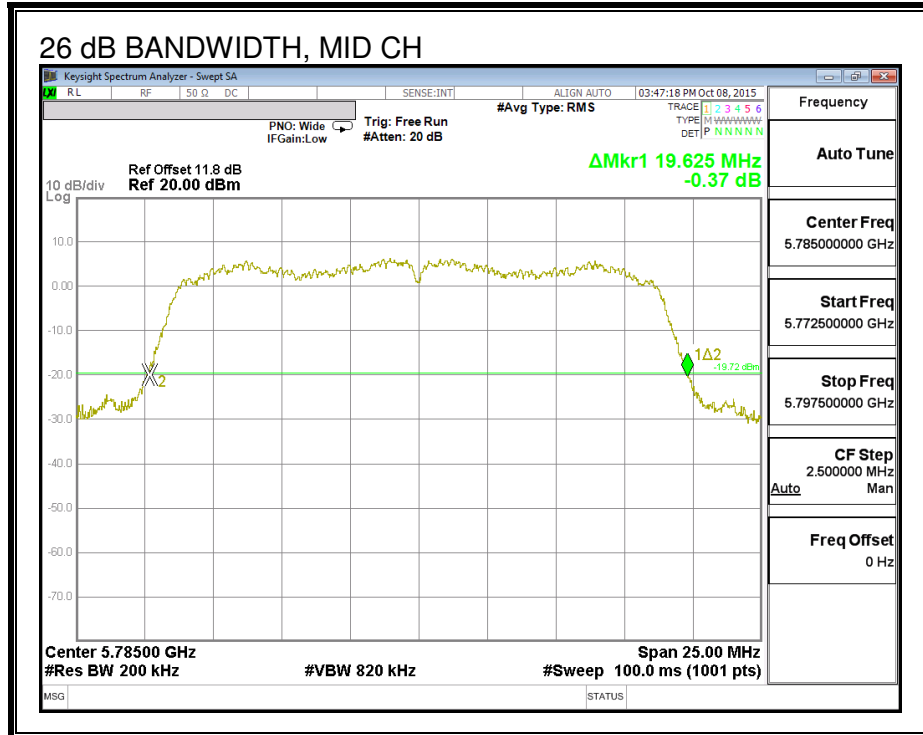
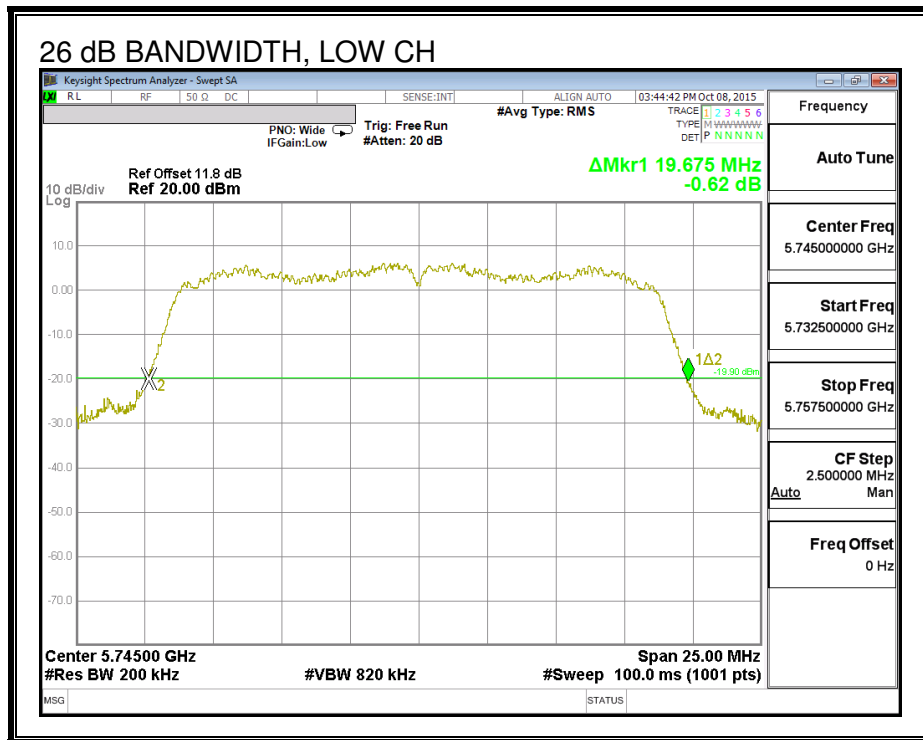

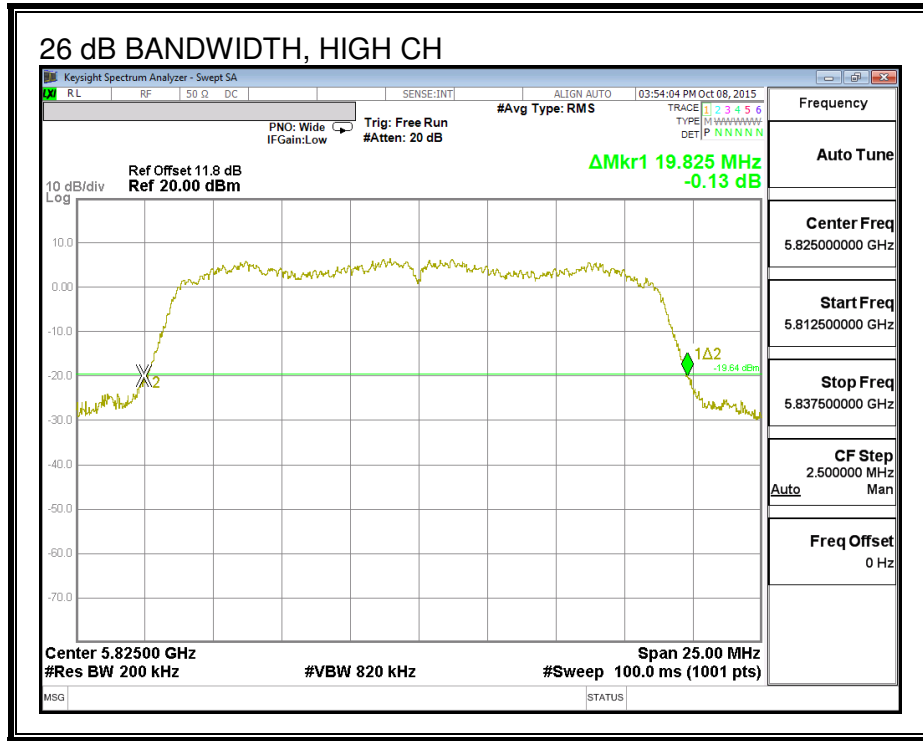

26 dB BANDWIDTH, CHAIN 1

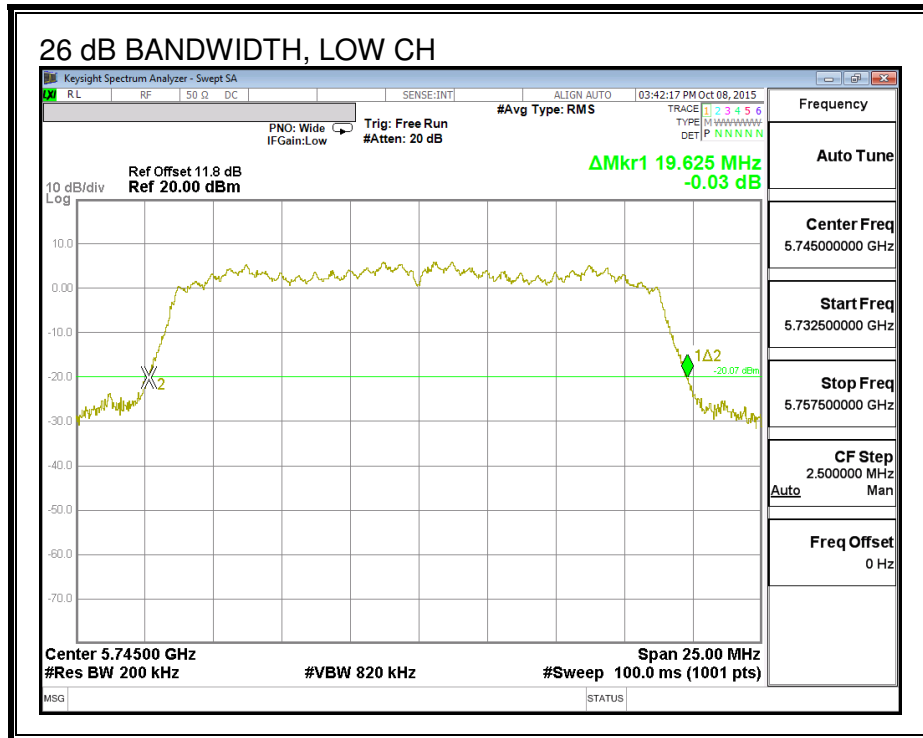

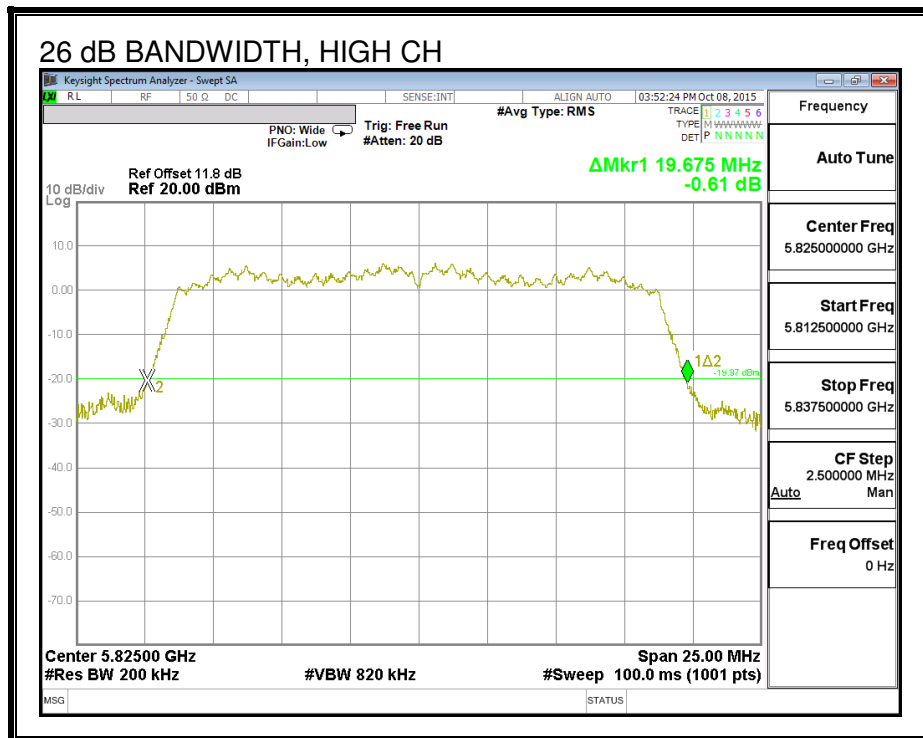
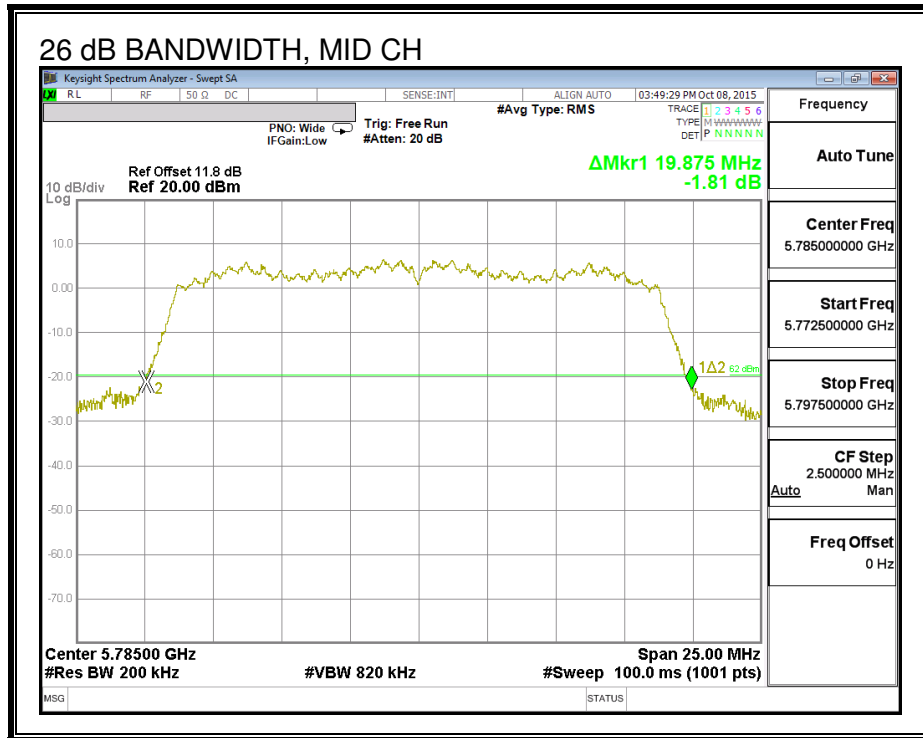

8.2.3. 99% BANDWIDTH

LIMITS

None; for reporting purposes only.

RESULTS

Channel	Frequency (MHz)	99% BW Chain 0 (MHz)	99% BW Chain 1 (MHz)
Low	5745	17.577	17.565
Mid	5785	17.583	17.476
High	5825	17.546	17.516

99% BANDWIDTH, CHAIN 0

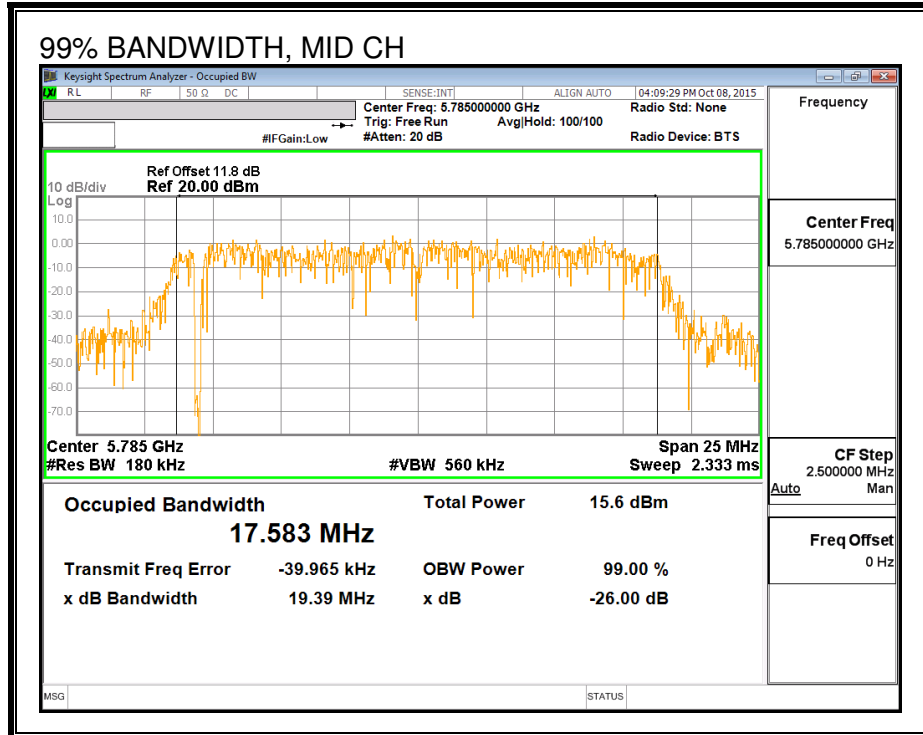
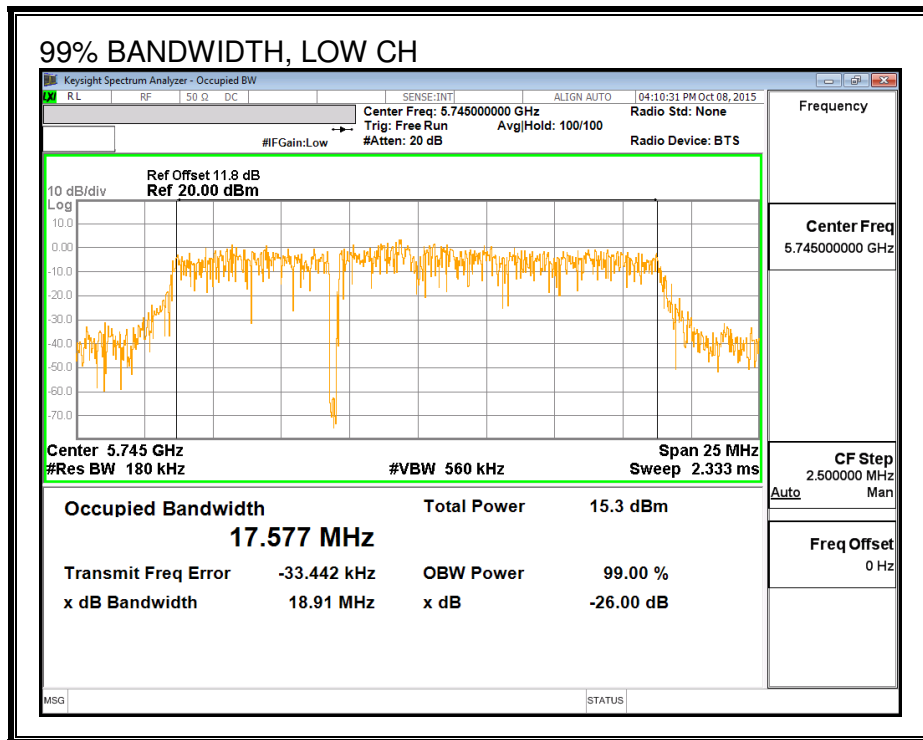

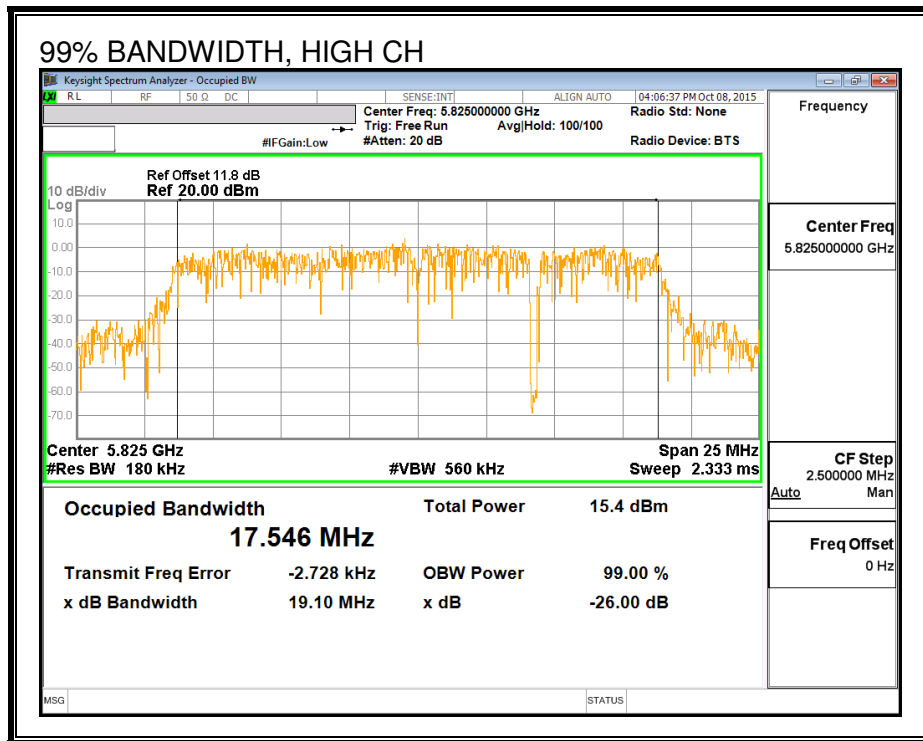

99% BANDWIDTH, CHAIN 1

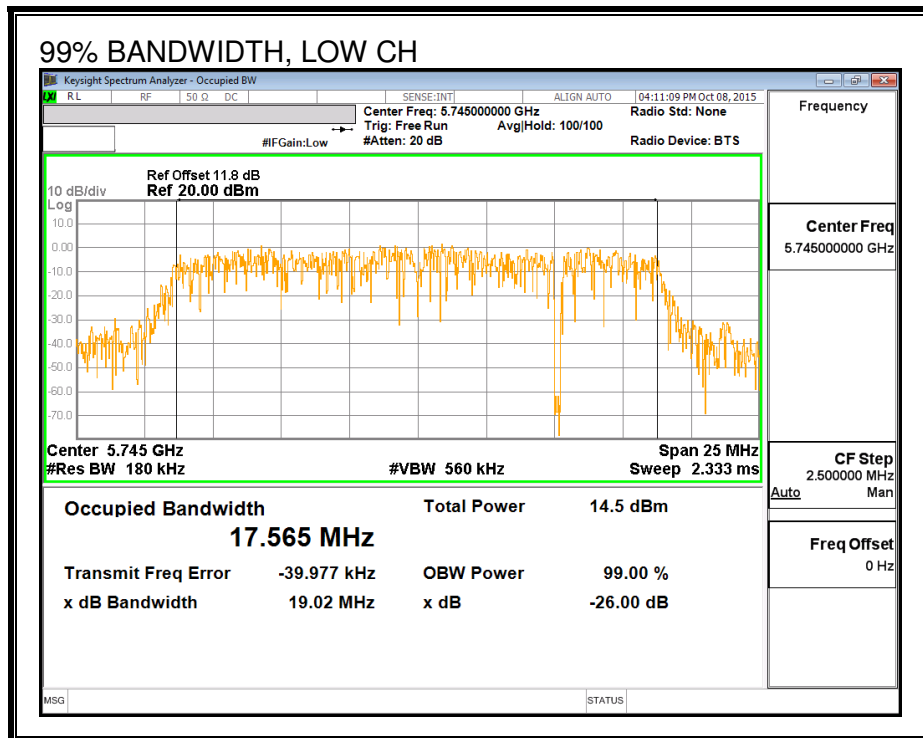

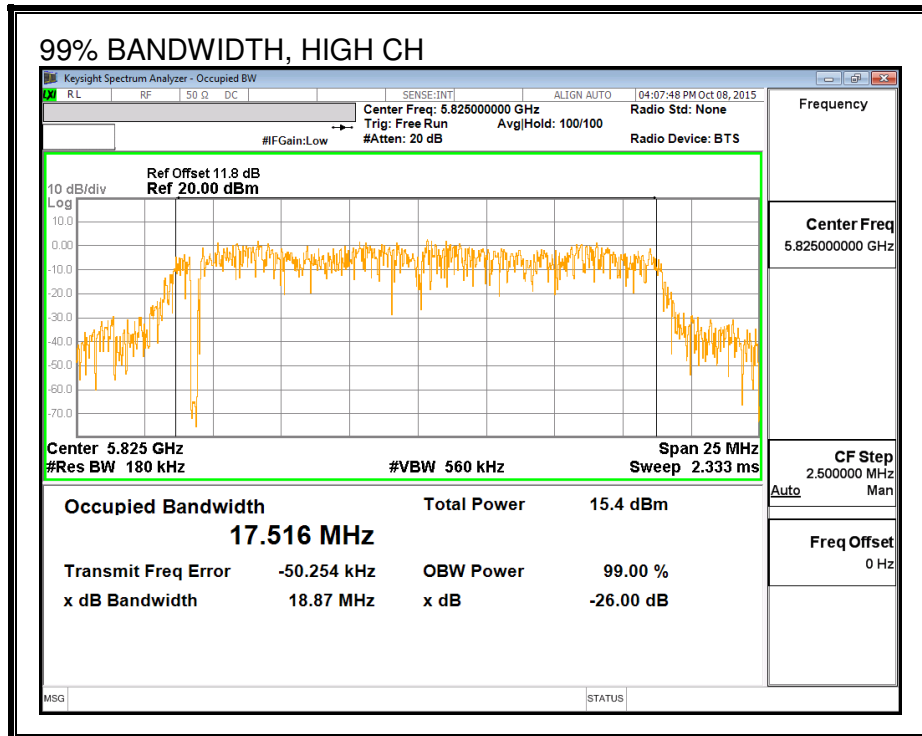
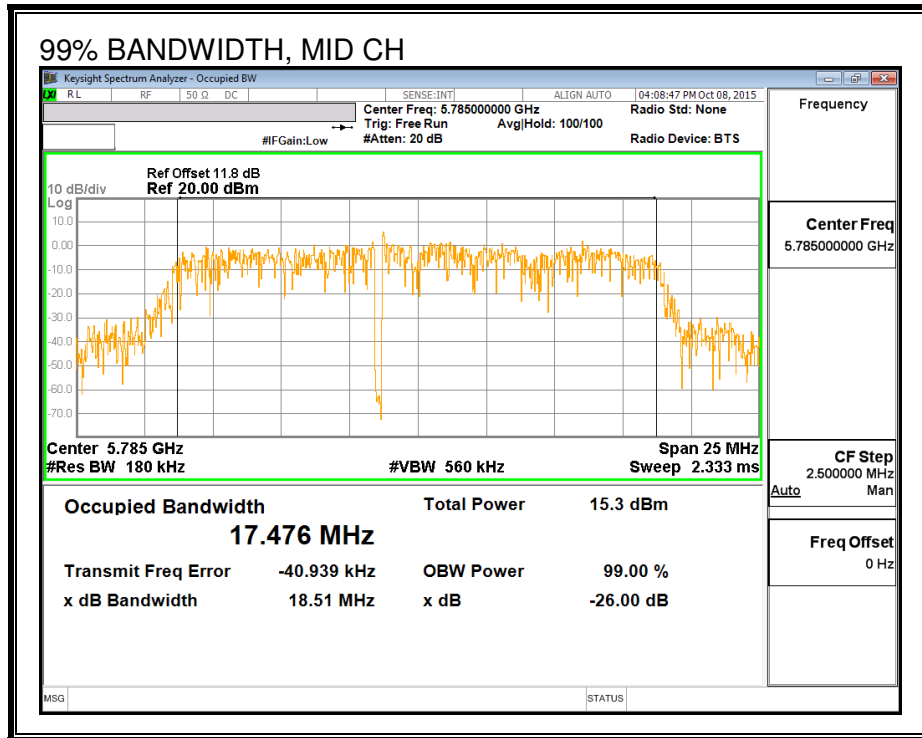

8.2.4. AVERAGE POWER

LIMITS

None; for reporting purposes only.

Test Procedure

Measurements perform using a wideband gated RF power meter.

RESULTS

Channel	Frequency (MHz)	Chain 0 Power (dBm)	Chain 1 Power (dBm)	Total Power (dBm)
Low	5745	14.50	14.09	17.31
Mid	5785	15.50	15.32	18.42
High	5825	15.44	15.35	18.41

8.2.5. OUTPUT POWER

LIMITS

FCC §15.407 (a) (3)

For the band 5.725-5.85 GHz, the maximum conducted output power over the frequency band of operation shall not exceed 1 W. In addition, the maximum power spectral density shall not exceed 30 dBm in any 500-kHz band. If transmitting antennas of directional gain greater than 6 dBi are used, both the maximum conducted output power and the maximum power spectral density shall be reduced by the amount in dB that the directional gain of the antenna exceeds 6 dBi.

Test Procedure

Measurements perform using a wideband gated RF power meter provided that the gate parameters are adjusted such that the power is measured only when the EUT is transmitting at its maximum power control level. Since the measurement is made only during the ON time of the transmitter, no duty cycle correction factor is required.

DIRECTIONAL ANTENNA GAIN

The TX chains are uncorrelated and the antenna gain is unequal among the chains. The directional gain is:

Chain 0 Antenna Gain (dBi)	Chain 1 Antenna Gain (dBi)	Uncorrelated Chains Directional Gain (dBi)
2.68	3.76	3.25

RESULTS

Antenna Gain and Limit

Channel	Frequency (MHz)	Directional Gain for Power (dBi)	Power Limit (dBm)
Low	5745	3.25	30.00
Mid	5785	3.25	30.00
High	5825	3.25	30.00

Output Power Results

Channel	Frequency (MHz)	Chain 0 Meas Power (dBm)	Chain 1 Meas Power (dBm)	Total Corr'd Power (dBm)	Power Limit (dBm)	Power Margin (dB)
Low	5745	14.50	14.09	17.31	30.00	-12.69
Mid	5785	15.50	15.32	18.42	30.00	-11.58
High	5825	15.44	15.35	18.41	30.00	-11.59

8.2.6. PSD

LIMITS

FCC §15.407 (a) (3)

For the band 5.725-5.85 GHz, the maximum conducted output power over the frequency band of operation shall not exceed 1 W. In addition, the maximum power spectral density shall not exceed 30 dBm in any 500-kHz band. If transmitting antennas of directional gain greater than 6 dBi are used, both the maximum conducted output power and the maximum power spectral density shall be reduced by the amount in dB that the directional gain of the antenna exceeds 6 dBi.

DIRECTIONAL ANTENNA GAIN

The TX chains are correlated and the antenna gain is unequal among the chains. The directional gain is:

Chain 0 Antenna Gain (dBi)	Chain 1 Antenna Gain (dBi)	Correlated Chains Directional Gain (dBi)
2.68	3.76	6.25

RESULTS

Antenna Gain and Limits

Channel	Frequency (MHz)	Directional Gain (dBi)	PSD Limit (dBm)
Low	5745	6.25	29.75
Mid	5785	6.25	29.75
High	5825	6.25	29.75

Duty Cycle CF (dB)	0.00	Included in Calculations of Corr'd PSD
---------------------------	------	---

PSD Results

Channel	Frequency (MHz)	Chain 0 Meas PSD (dBm)	Chain 1 Meas PSD (dBm)	Total Corr'd PSD (dBm)	PSD Limit (dBm)	PSD Margin (dB)
Low	5745	1.72	1.48	4.61	29.75	-25.14
Mid	5785	2.90	2.75	5.84	29.75	-23.91
High	5825	2.75	3.00	5.88	29.75	-23.87

PSD, CHAIN 0

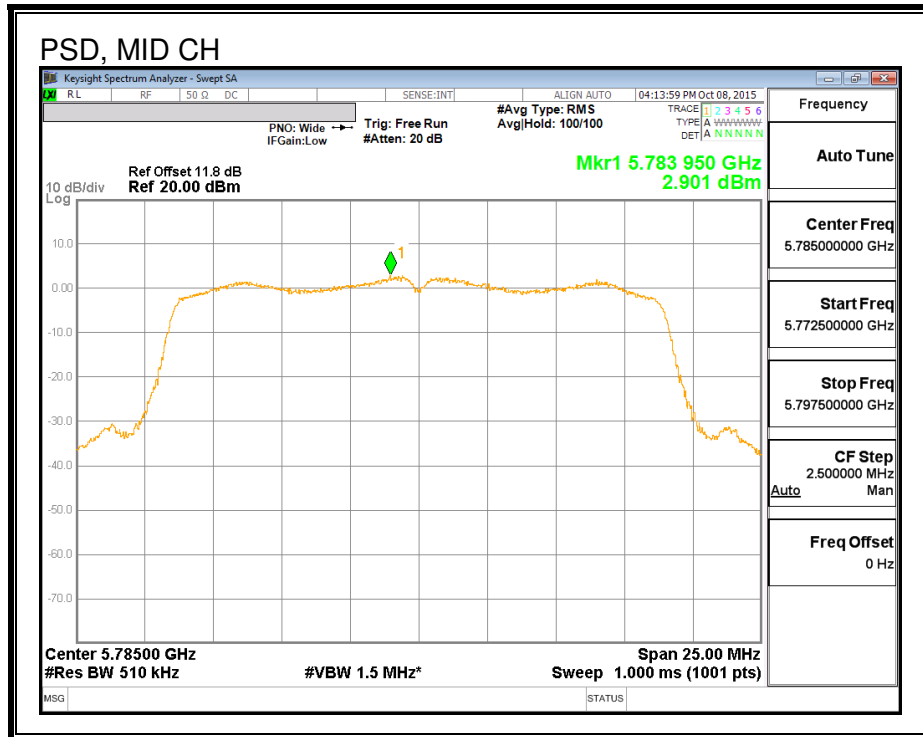
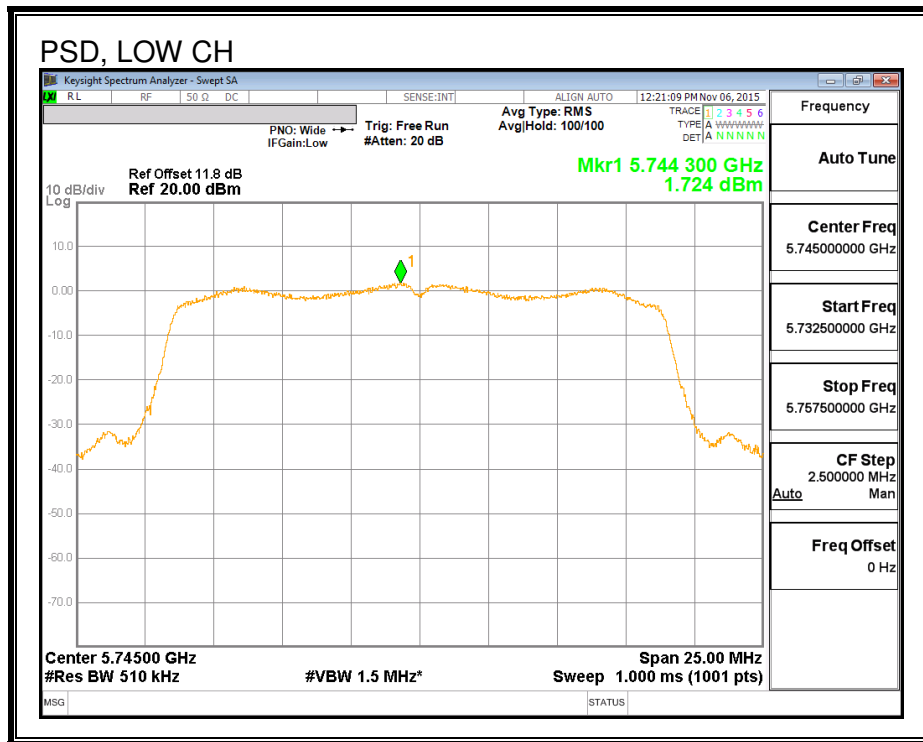

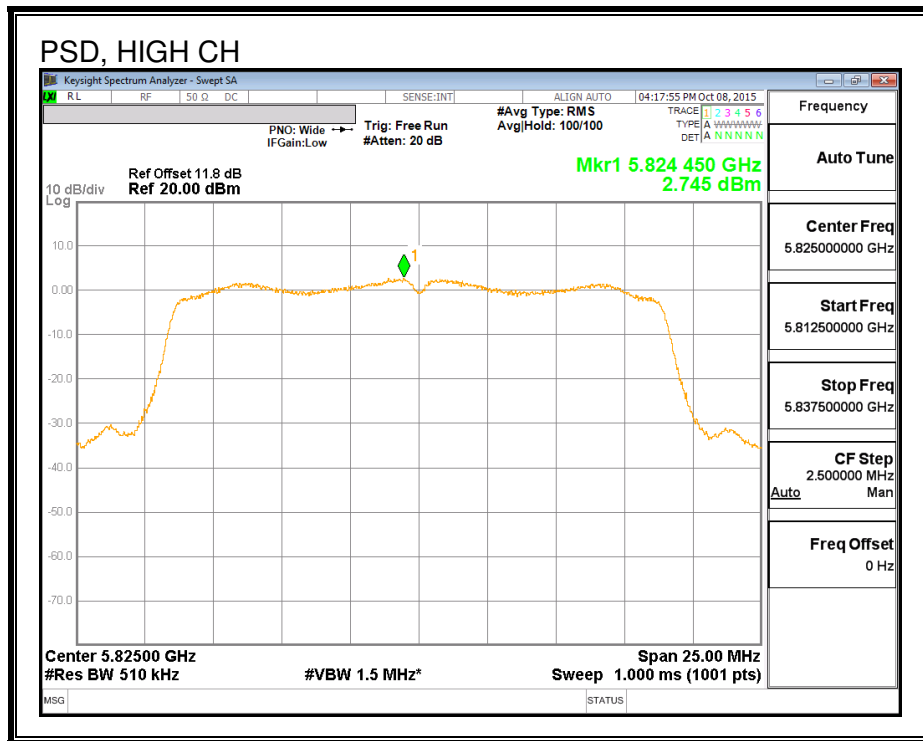

PSD, CHAIN 1

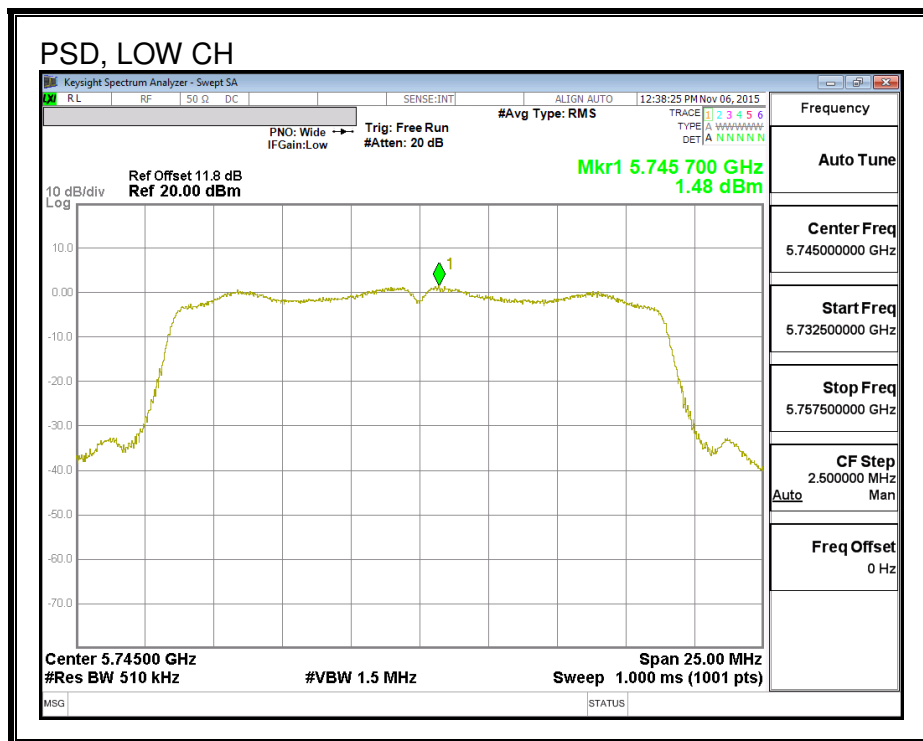

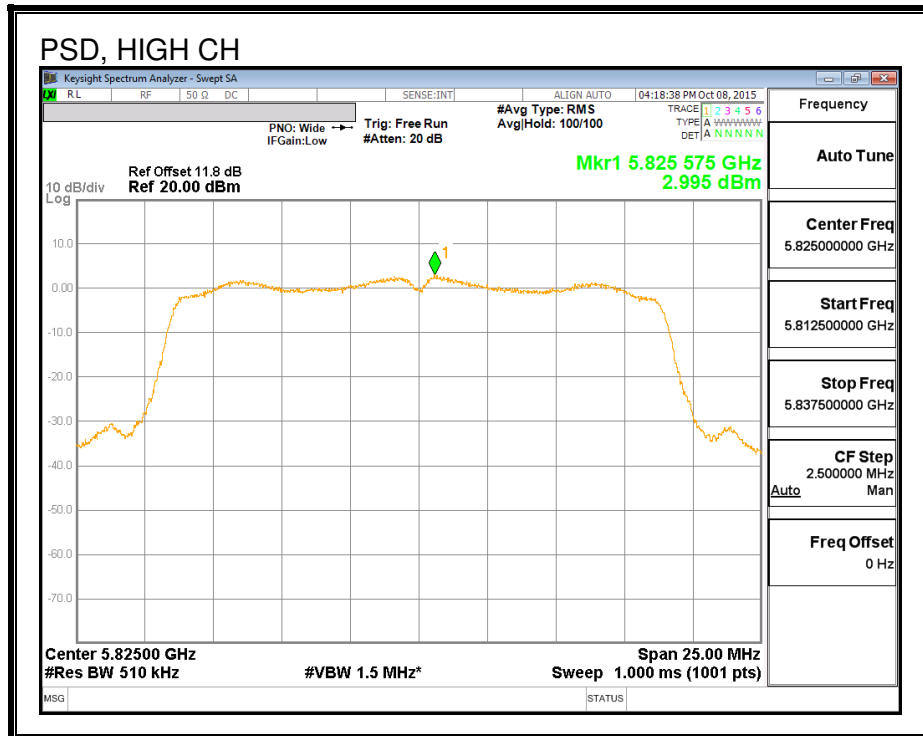
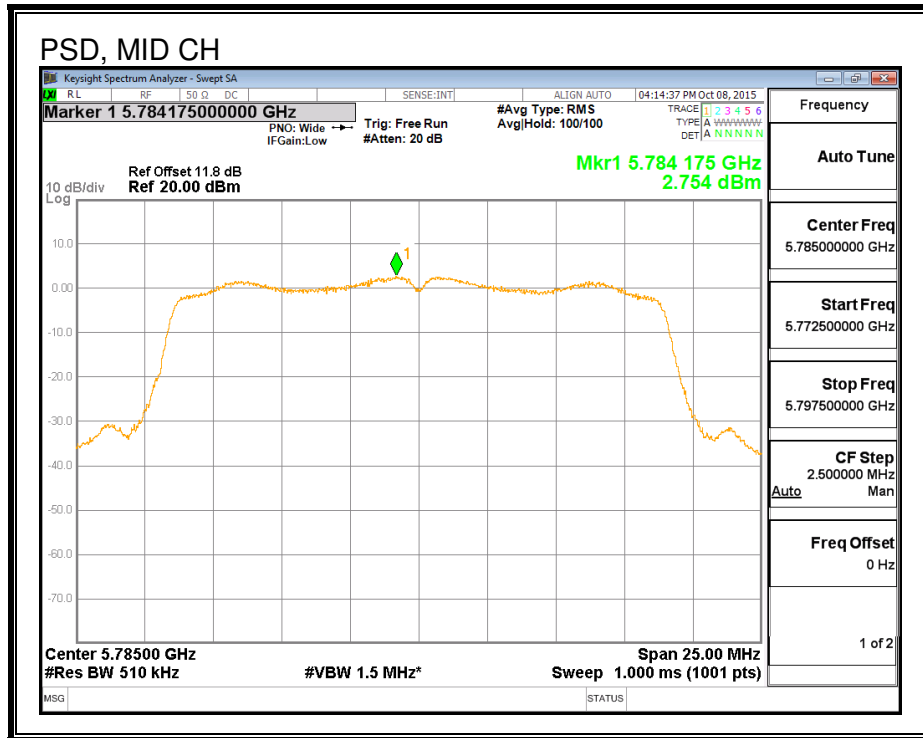

8.3. 802.11n HT20 2Tx STBC MODE IN THE 5.8 GHz BAND

Note: Covered by 802.11n HT20 2Tx CDD MODE

8.4. 802.11n HT40 1TX MODE IN THE 5.8 GHz BAND

8.4.1. 6 dB BANDWIDTH

LIMITS

FCC §15.407 (e)

The minimum 6 dB bandwidth shall be at least 500 kHz.

RESULTS

Channel	Frequency (MHz)	6 dB Bandwidth (MHz)	Minimum Limit (MHz)
Low	5755	35.64	0.5
High	5795	35.42	0.5

8.4.2. 26 dB BANDWIDTH

LIMITS

None, for reporting purposes only.

RESULTS

Channel	Frequency (MHz)	26 dB Bandwidth (MHz)
Low	5755	40.21
High	5795	40.04

8.4.3. 99% BANDWIDTH

LIMITS

None; for reporting purposes only.

RESULTS

Channel	Frequency (MHz)	99% Bandwidth (MHz)
Low	5755	36.314
High	5795	36.291

99% BANDWIDTH

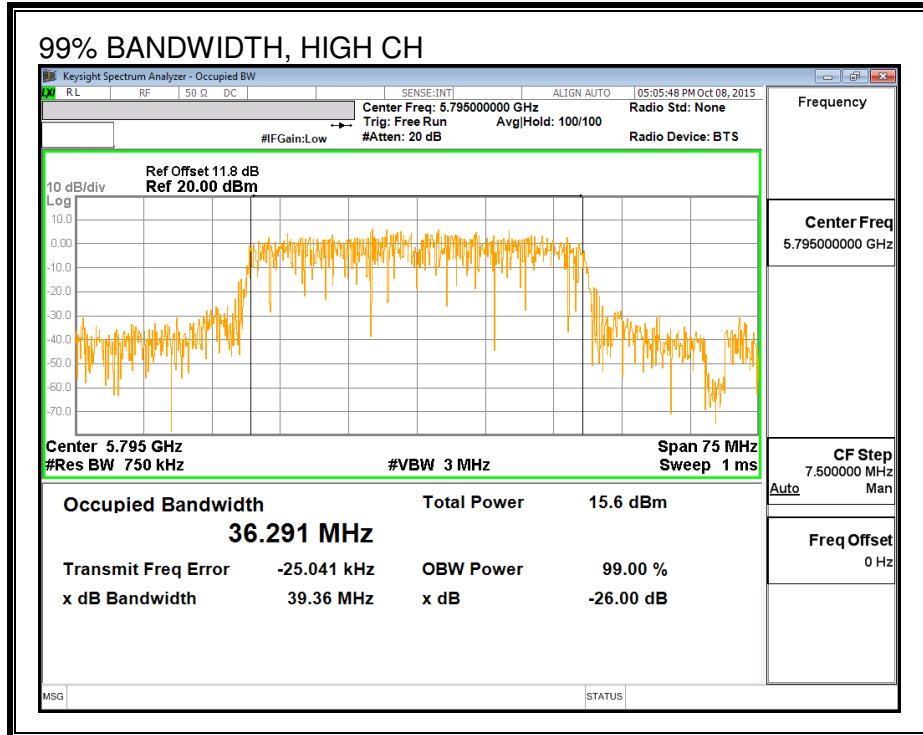
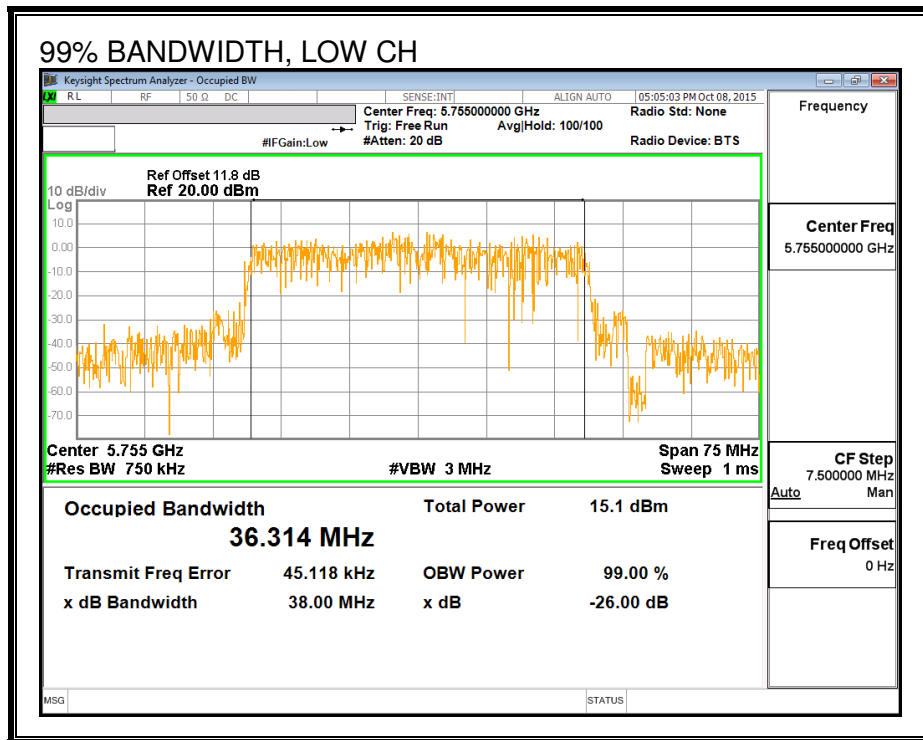

8.4.4. AVERAGE POWER

LIMITS

None; for reporting purposes only.

Test Procedure

Measurements perform using a wideband gated RF power meter.

RESULTS

Channel	Frequency (MHz)	Power (dBm)
Low	5755	14.60
High	5795	15.50

8.4.5. OUTPUT POWER

LIMITS

FCC §15.407 (a) (3)

For the band 5.725-5.85 GHz, the maximum conducted output power over the frequency band of operation shall not exceed 1 W. In addition, the maximum power spectral density shall not exceed 30 dBm in any 500-kHz band. If transmitting antennas of directional gain greater than 6 dBi are used, both the maximum conducted output power and the maximum power spectral density shall be reduced by the amount in dB that the directional gain of the antenna exceeds 6 dBi.

Test Procedure

Measurements perform using a wideband gated RF power meter provided that the gate parameters are adjusted such that the power is measured only when the EUT is transmitting at its maximum power control level. Since the measurement is made only during the ON time of the transmitter, no duty cycle correction factor is required.

DIRECTIONAL ANTENNA GAIN

There is only one transmitter output therefore the directional gain is equal to the antenna gain.

RESULTS

Antenna Gain and Limit

Channel	Frequency (MHz)	Directional Gain (dBi)	Power Limit (dBm)
Low	5755	2.68	30.00
High	5795	2.68	30.00

Output Power Results

Channel	Frequency (MHz)	Chain 0 Meas Power (dBm)	Total Corr'd Power (dBm)	Power Limit (dBm)	Power Margin (dB)
Low	5755	14.60	14.60	30.00	-15.40
High	5795	15.50	15.50	30.00	-14.50

8.4.6. PSD

LIMITS

FCC §15.407 (a) (3)

For the band 5.725-5.85 GHz, the maximum conducted output power over the frequency band of operation shall not exceed 1 W. In addition, the maximum power spectral density shall not exceed 30 dBm in any 500-kHz band. If transmitting antennas of directional gain greater than 6 dBi are used, both the maximum conducted output power and the maximum power spectral density shall be reduced by the amount in dB that the directional gain of the antenna exceeds 6 dBi.

DIRECTIONAL ANTENNA GAIN

There is only one transmitter output therefore the directional gain is equal to the antenna gain.

RESULTS

Antenna Gain and Limits

Channel	Frequency (MHz)	Directional Gain (dBi)	PSD Limit (dBm)
Low	5755	2.68	30.00
High	5795	2.68	30.00

Duty Cycle CF (dB)	0.13	Included in Calculations of Corr'd PSD
---------------------------	------	---

PSD Results

Channel	Frequency (MHz)	Chain 0 Meas PSD (dBm)	Total Corr'd PSD (dBm)	PSD Limit (dBm)	PSD Margin (dB)
Low	5755	-0.57	-0.44	30.00	-30.44
High	5795	0.18	0.31	30.00	-29.69

PSD,

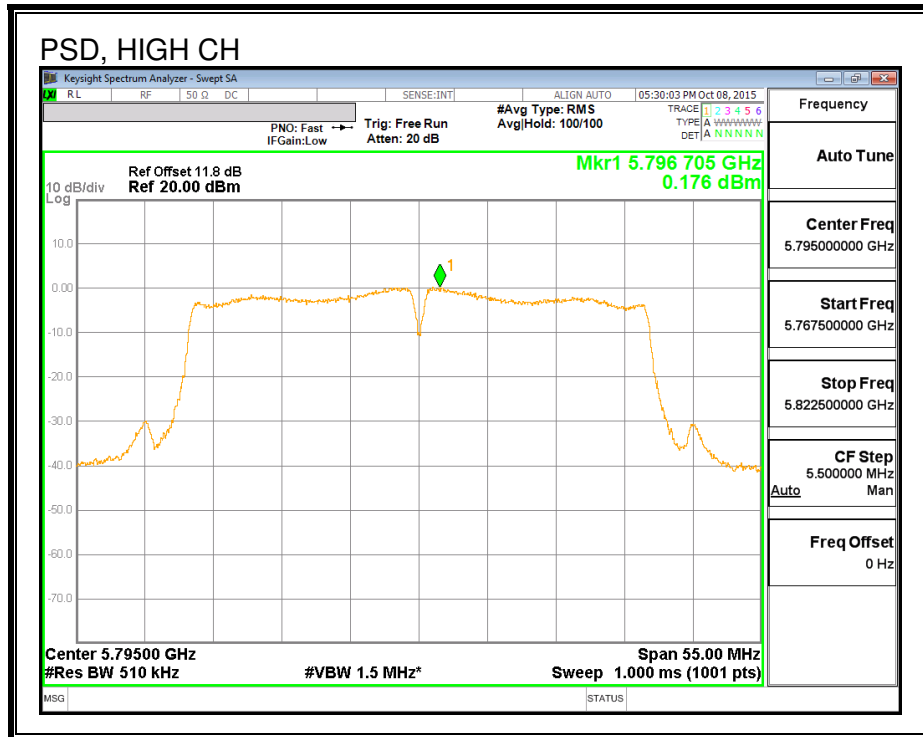
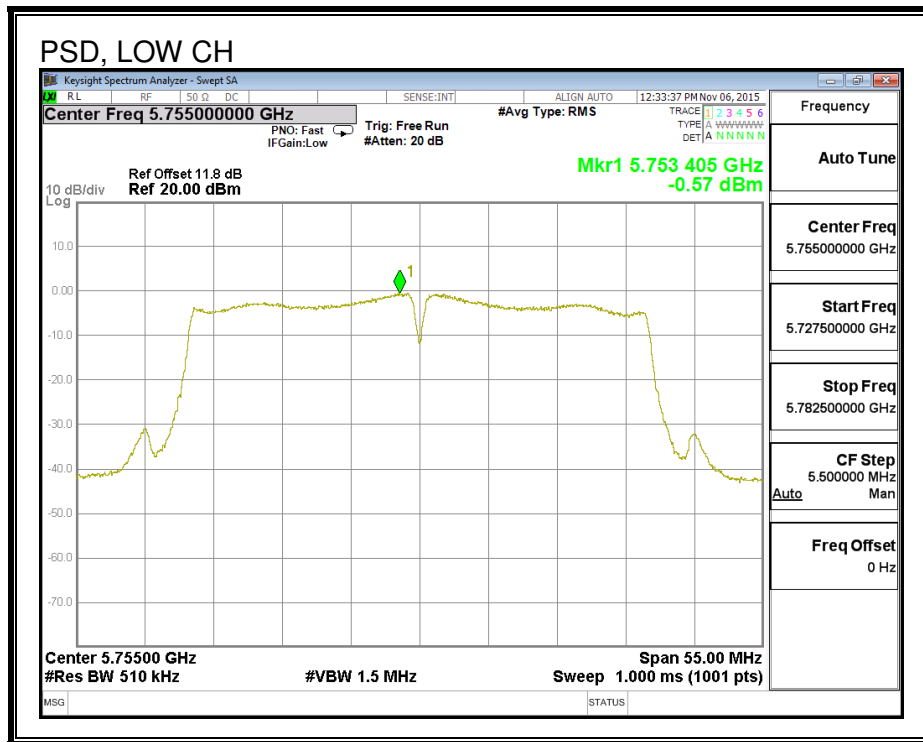

8.5. 802.11n HT40 2Tx CDD MODE IN THE 5.8 GHz BAND

8.5.1. 6 dB BANDWIDTH

LIMITS

FCC §15.407 (e)

The minimum 6 dB bandwidth shall be at least 500 kHz.

RESULTS

Channel	Frequency (MHz)	6 dB BW Chain 0 (MHz)	6 dB BW Chain 1 (MHz)	Minimum Limit (MHz)
Low	5755	36.25	36.30	0.5
High	5795	35.20	36.30	0.5

8.5.2. 26 dB BANDWIDTH

LIMITS

None, for reporting purposes only.

RESULTS

Channel	Frequency (MHz)	26 dB BW Chain 0 (MHz)	26 dB BW Chain 1 (MHz)
Low	5755	40.48	39.82
High	5795	40.70	39.60

26 dB BANDWIDTH, CHAIN 1

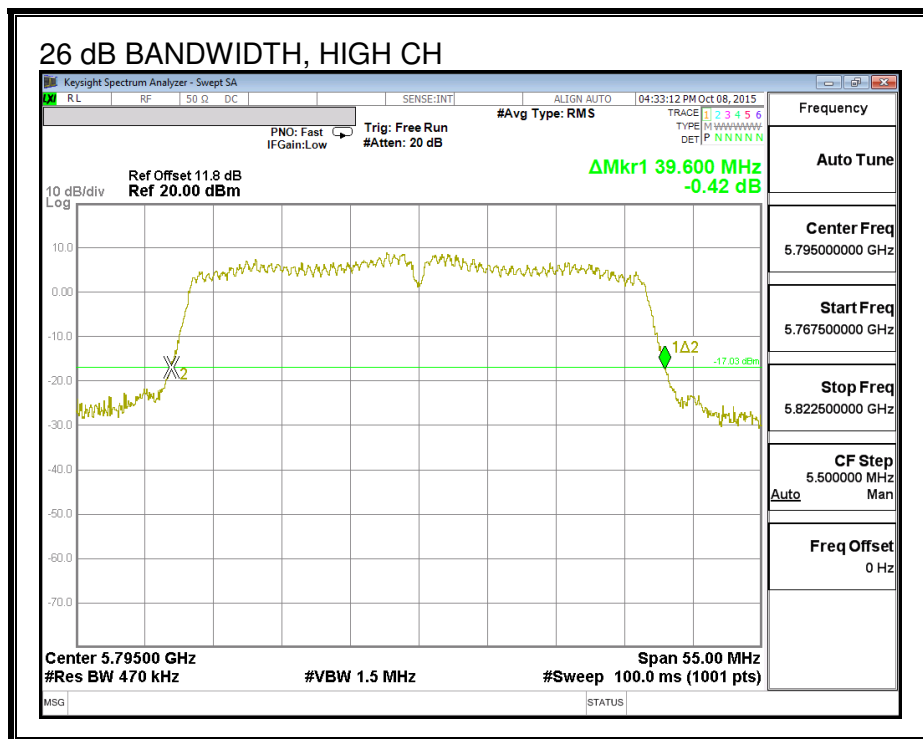
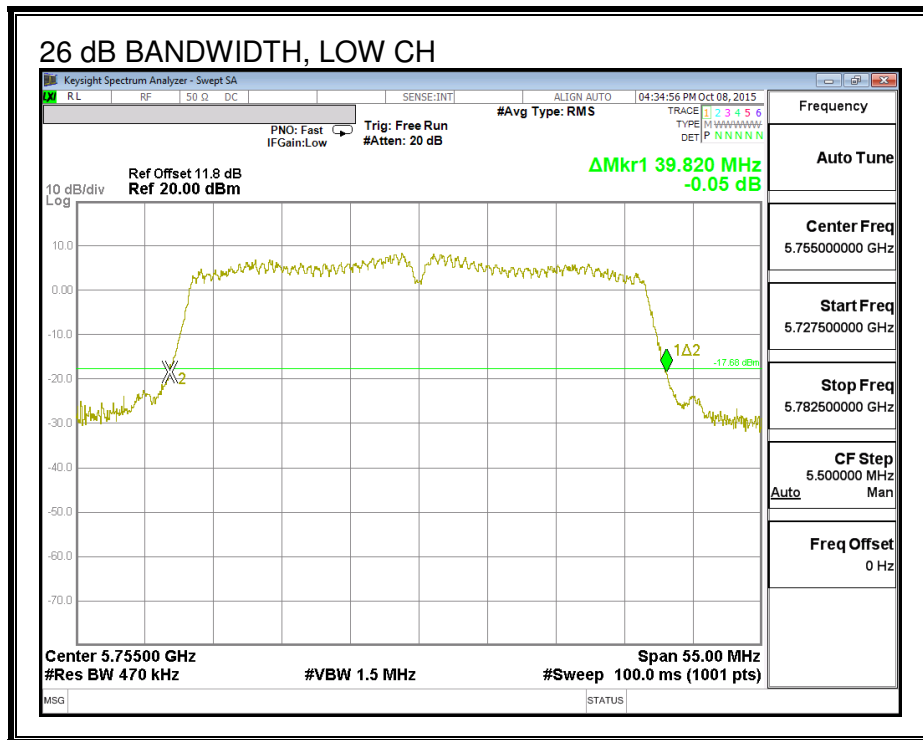

8.5.3. 99% BANDWIDTH

LIMITS

None; for reporting purposes only.

RESULTS

Channel	Frequency (MHz)	99% BW Chain 0 (MHz)	99% BW Chain 1 (MHz)
Low	5755	36.177	36.332
High	5795	36.423	36.332

99% BANDWIDTH, CHAIN 0

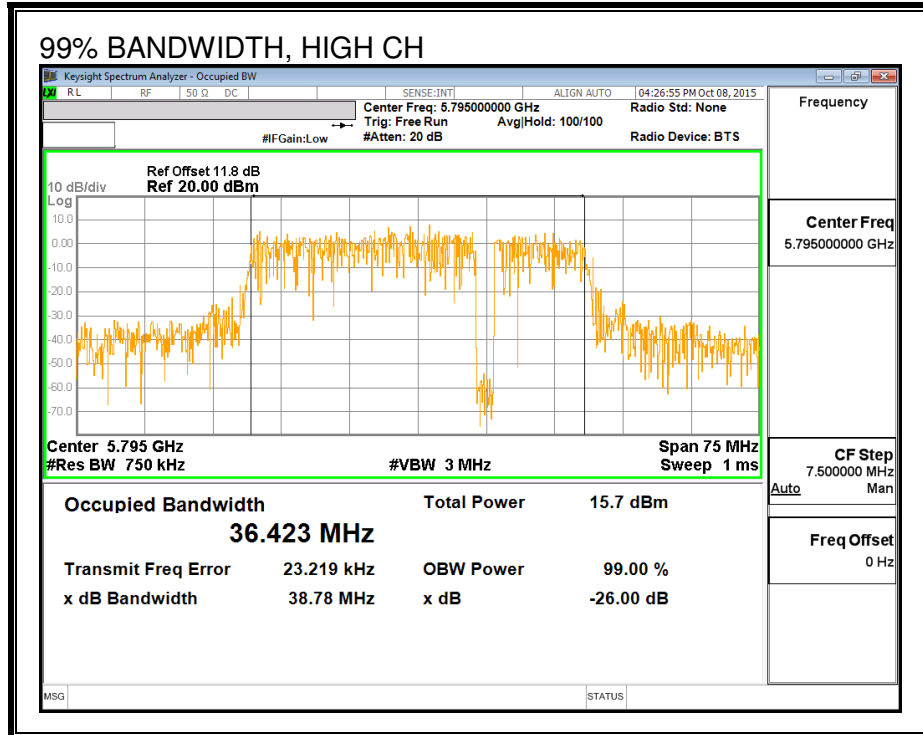
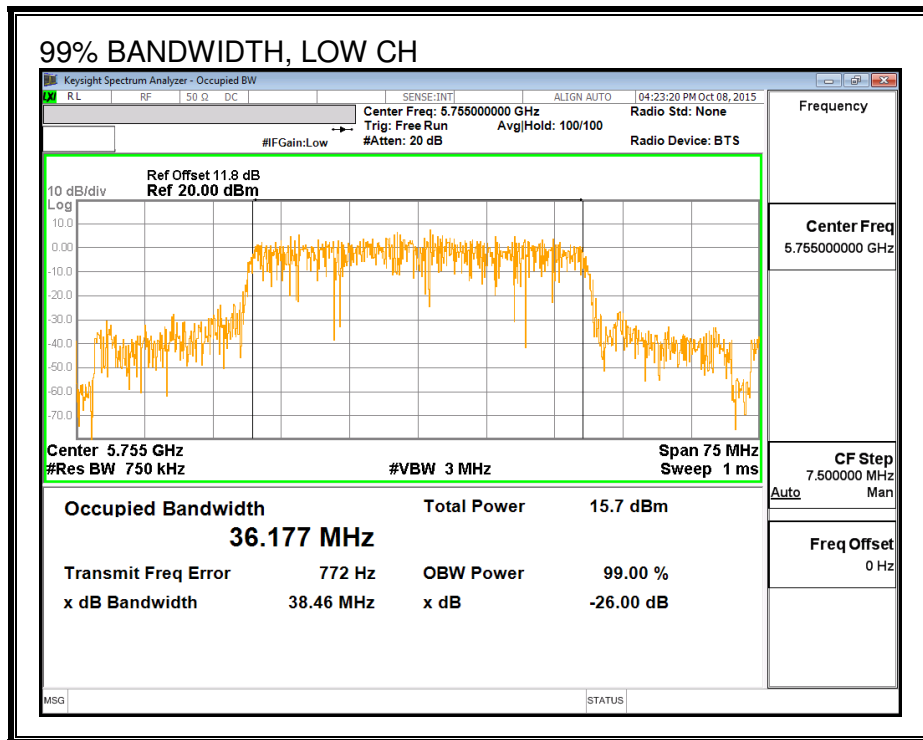

99% BANDWIDTH, CHAIN 1

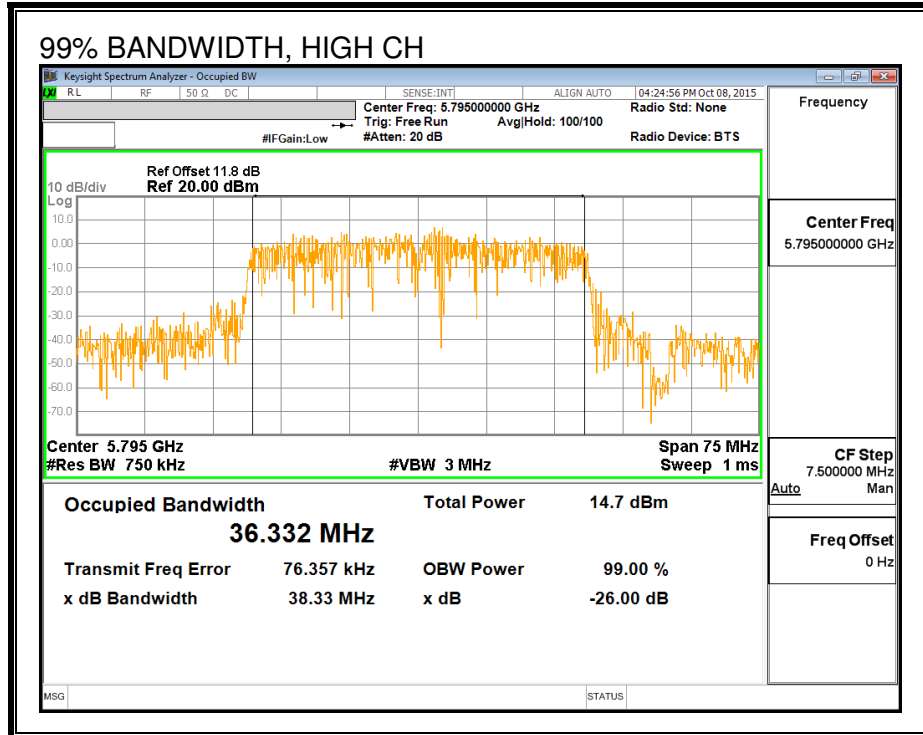
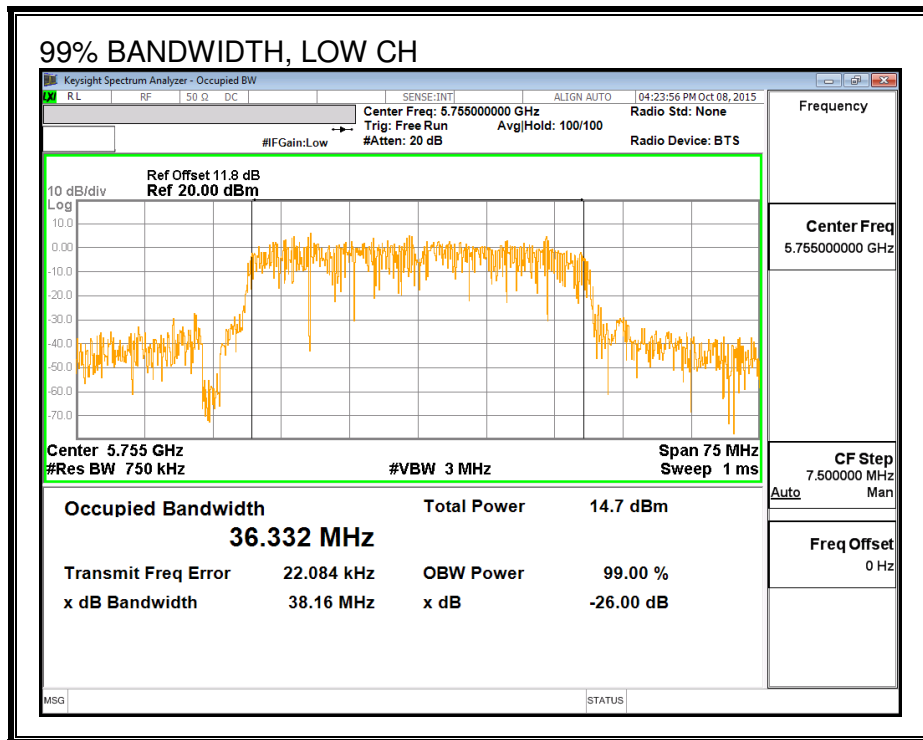

8.5.4. AVERAGE POWER

LIMITS

None; for reporting purposes only.

Test Procedure

Measurements perform using a wideband gated RF power meter.

RESULTS

Channel	Frequency (MHz)	Chain 0 Power (dBm)	Chain 1 Power (dBm)	Total Power (dBm)
Low	5755	12.45	12.40	15.44
High	5795	15.50	15.15	18.34

8.5.5. OUTPUT POWER

LIMITS

FCC §15.407 (a) (3)

For the band 5.725-5.85 GHz, the maximum conducted output power over the frequency band of operation shall not exceed 1 W. In addition, the maximum power spectral density shall not exceed 30 dBm in any 500-kHz band. If transmitting antennas of directional gain greater than 6 dBi are used, both the maximum conducted output power and the maximum power spectral density shall be reduced by the amount in dB that the directional gain of the antenna exceeds 6 dBi.

Test Procedure

Measurements perform using a wideband gated RF power meter provided that the gate parameters are adjusted such that the power is measured only when the EUT is transmitting at its maximum power control level. Since the measurement is made only during the ON time of the transmitter, no duty cycle correction factor is required.

DIRECTIONAL ANTENNA GAIN

The TX chains are uncorrelated and the antenna gain is unequal among the chains. The directional gain is:

Chain 0 Antenna Gain (dBi)	Chain 1 Antenna Gain (dBi)	Uncorrelated Chains Directional Gain (dBi)
2.68	3.76	3.25

RESULTS

Antenna Gain and Limit

Channel	Frequency (MHz)	Directional Gain (dBi)	Power Limit (dBm)
Low	5755	3.25	30.00
High	5795	3.25	30.00

Output Power Results

Channel	Frequency (MHz)	Chain 0 Meas Power (dBm)	Chain 1 Meas Power (dBm)	Total Corr'd Power (dBm)	Power Limit (dBm)	Power Margin (dB)
Low	5755	12.45	12.40	15.44	30.00	-14.56
High	5795	15.50	15.15	18.34	30.00	-11.66

8.5.6. PSD

LIMITS

FCC §15.407 (a) (3)

For the band 5.725-5.85 GHz, the maximum conducted output power over the frequency band of operation shall not exceed 1 W. In addition, the maximum power spectral density shall not exceed 30 dBm in any 500-kHz band. If transmitting antennas of directional gain greater than 6 dBi are used, both the maximum conducted output power and the maximum power spectral density shall be reduced by the amount in dB that the directional gain of the antenna exceeds 6 dBi.

DIRECTIONAL ANTENNA GAIN

The TX chains are correlated and the antenna gain is unequal among the chains. The directional gain is:

Chain 0 Antenna Gain (dBi)	Chain 1 Antenna Gain (dBi)	Correlated Chains Directional Gain (dBi)
2.68	3.76	6.25

RESULTS

Antenna Gain and Limit

Channel	Frequency (MHz)	Directional Gain (dBi)	PSD Limit (dBm)
Low	5755	6.25	29.75
High	5795	6.25	29.75

Duty Cycle CF (dB)	0.12	Included in Calculations of Corr'd PSD
---------------------------	------	---

PSD Results

Channel	Frequency (MHz)	Chain 0 Meas PSD (dBm)	Chain 1 Meas PSD (dBm)	Total Corr'd PSD (dBm)	PSD Limit (dBm)	PSD Margin (dB)
Low	5755	-0.98	-1.37	1.96	29.75	-27.79
High	5795	0.52	-0.70	3.09	29.75	-26.66

PSD, CHAIN 0

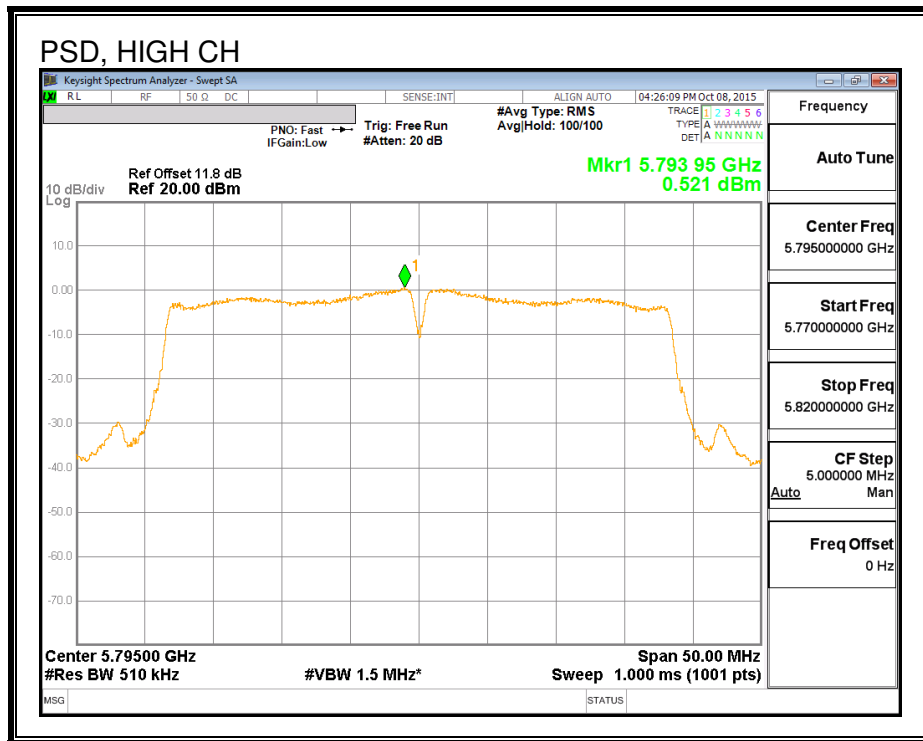
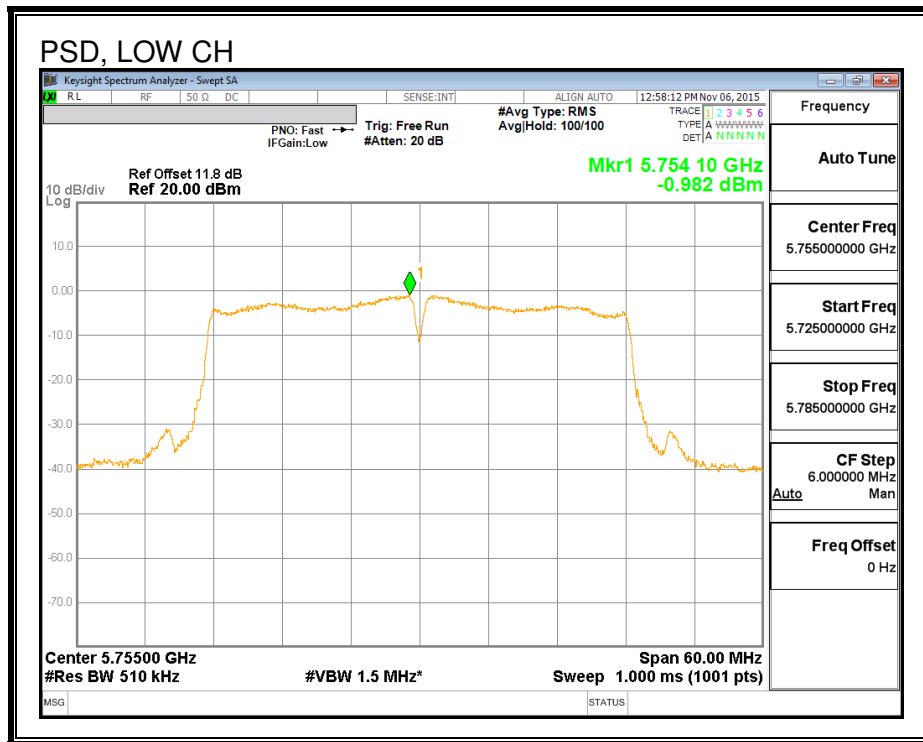

PSD, CHAIN 1

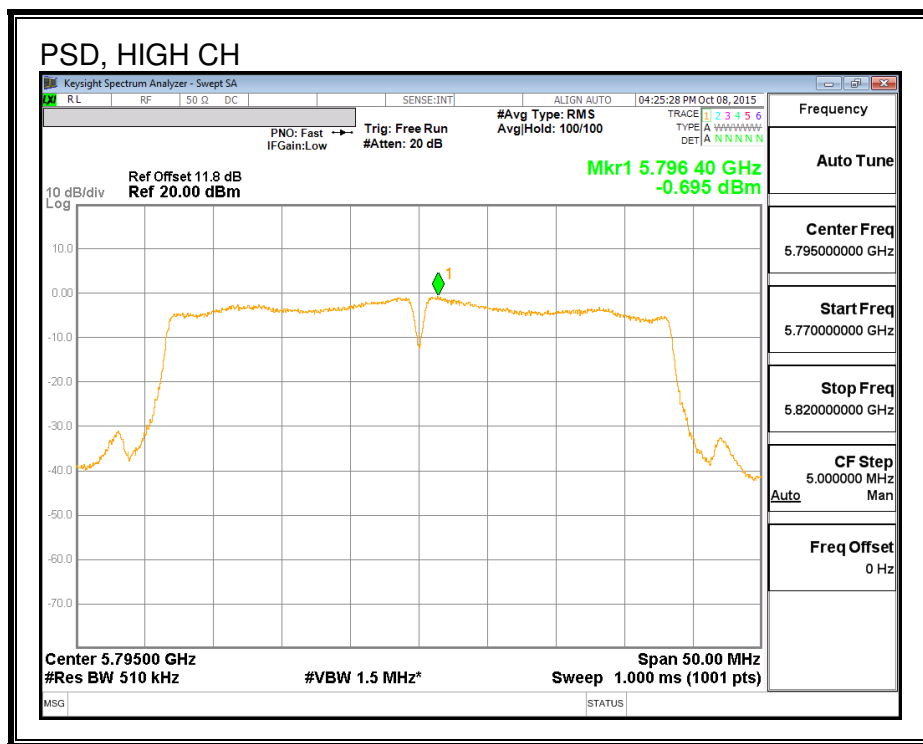
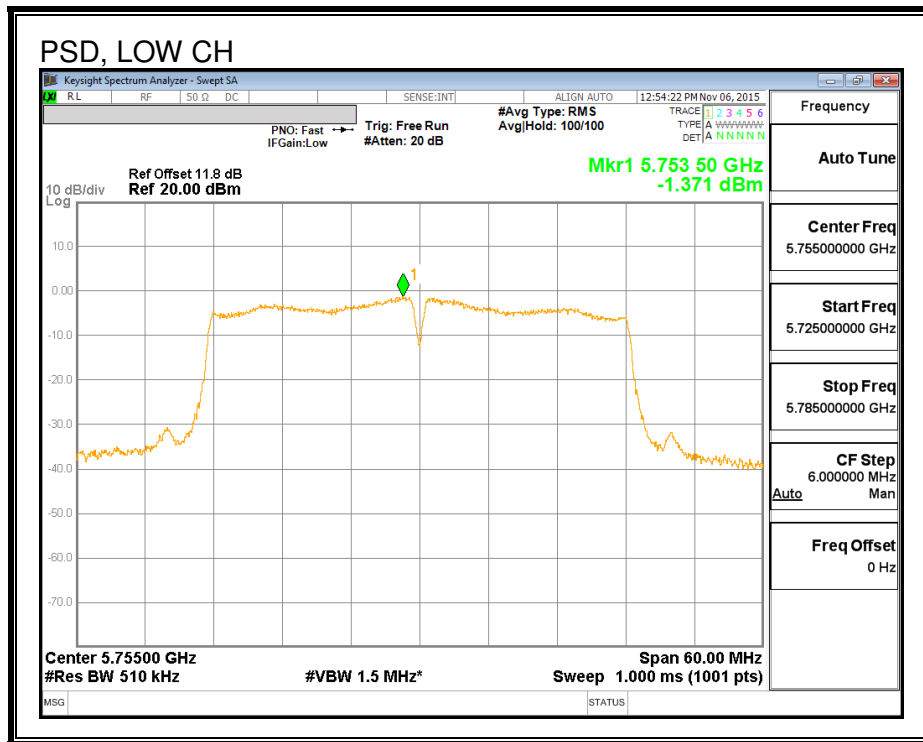

8.6. 802.11n HT40 2Tx STBC MODE IN THE 5.8 GHz BAND

Note: Covered by 802.11n HT40 2Tx CDD MODE

9. RADIATED TEST RESULTS

9.1. LIMITS AND PROCEDURE

LIMITS

FCC §15.205 and §15.209

Frequency Range (MHz)	Field Strength Limit (uV/m) at 3 m	Field Strength Limit (dBuV/m) at 3 m
30 - 88	100	40
88 - 216	150	43.5
216 - 960	200	46
Above 960	500	54

TEST PROCEDURE

The EUT is placed on a non-conducting table 80 cm above the ground plane for measurement below 1GHz; 1.5 m above the ground plane for measurement above 1GHz. The antenna to EUT distance is 3 meters. The EUT is configured in accordance with ANSI C63.10. The EUT is set to transmit in a continuous mode.

For measurements below 1 GHz the resolution bandwidth is set to 100 kHz for peak detection measurements or 120 kHz for quasi-peak detection measurements. Peak detection is used unless otherwise noted as quasi-peak.

For measurements above 1 GHz the resolution bandwidth is set to 1 MHz; the video bandwidth is set to 3 MHz for peak measurements and as applicable for average measurements.

The spectrum from 30 MHz to 40 GHz is investigated with the transmitter set to the lowest, middle, and highest channels in each applicable band.

The frequency range of interest is monitored at a fixed antenna height and EUT azimuth. The EUT is rotated through 360 degrees to maximize emissions received. The antenna is scanned from 1 to 4 meters above the ground plane to further maximize the emission. Measurements are made with the antenna polarized in both the vertical and the horizontal positions.

Radiated emission were performed with the EUT set to transmit at the channel with highest output power as worst-case scenario.

9.2. 802.a 1Tx MODE IN THE 5.8 GHz BAND

9.2.1. CHAIN 0, RESTRICTED BANDEDGE, (LOW CHANNEL)

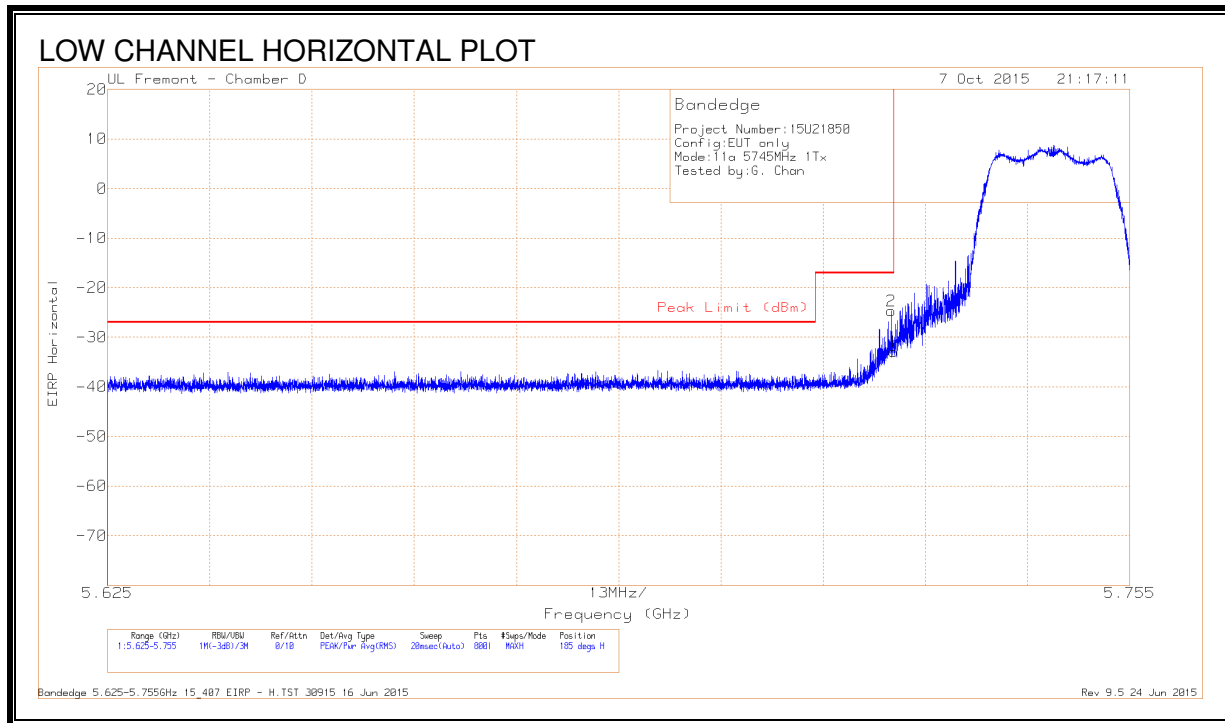

DATA

Marker	Frequency (GHz)	Meter Reading (dBm)	Det	AF T344 (dB/m)	Amp/Cbl/F Itr/Pad (dB)	Conversion Factor (dB)	Corrected Reading EIRP	Peak Limit (dBm)	PK Margin (dB)	Azimuth (Degs)	Height (cm)	Polarity
1	5.725	-61.75	Pk	34.6	-17.6	11.8	-32.95	-17	-15.95	185	396	H
2	5.725	-53.47	Pk	34.6	-17.6	11.8	-24.67	-17	-7.67	185	396	H

Pk - Peak detector

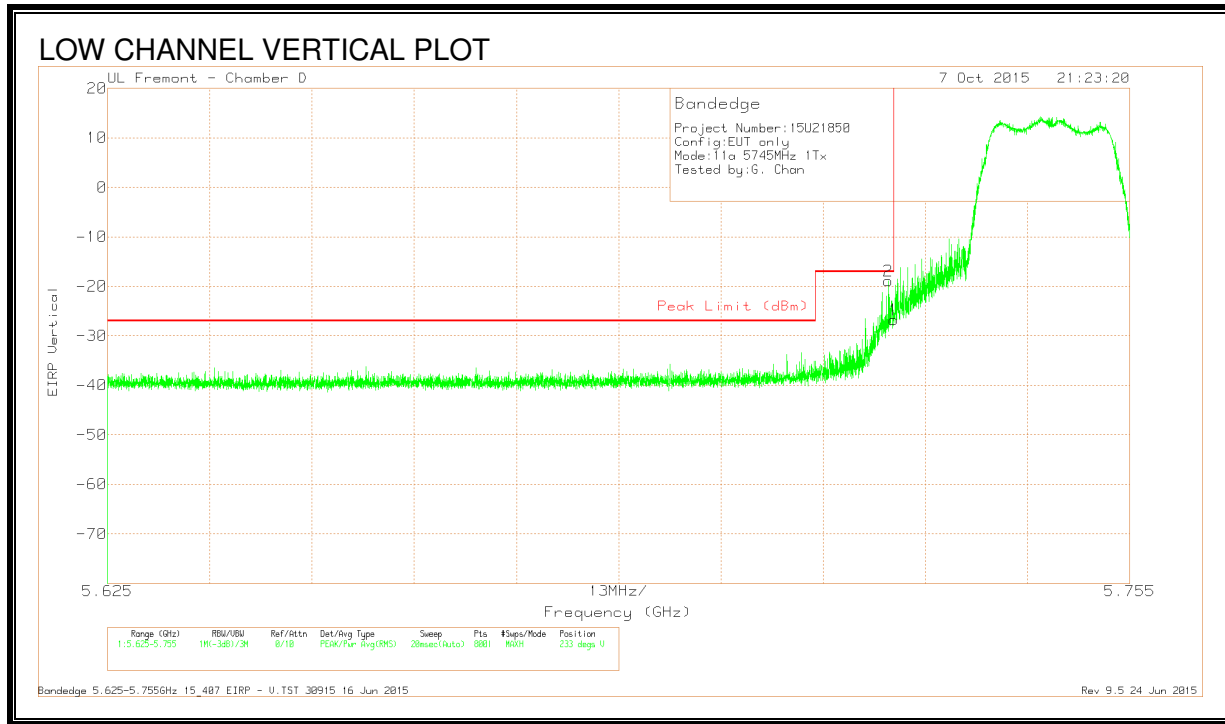

DATA

Marker	Frequency (GHz)	Meter Reading (dBm)	Det	AFT344 (dB/m)	Amp/Cbl/F ltr/Pad (dB)	Conversion Factor (dB)	Corrected Reading EIRP	Peak Limit (dBm)	PK Margin (dB)	Azimuth (Degs)	Height (cm)	Polarity
2	5.724	-47.66	Pk	34.6	-17.6	11.8	-18.86	-17	-1.86	233	370	V
1	5.725	-55.61	Pk	34.6	-17.6	11.8	-26.81	-17	-9.81	233	370	V

Pk - Peak detector

RESTRICTED BANDEDGE, (HIGH CHANNEL)

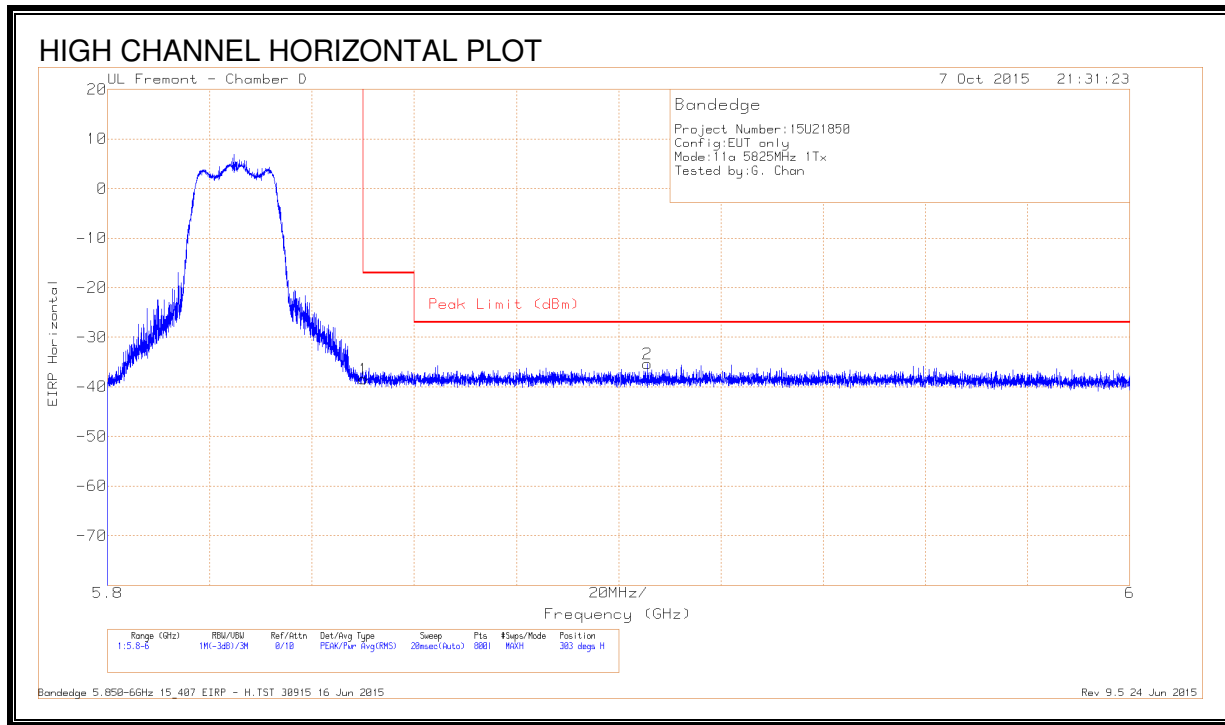

DATA

Marker	Frequency (GHz)	Meter Reading (dBm)	Det	AF T344 (dB/m)	Amp/Cbl/F ltr/Pad (dB)	Conversion Factor (dB)	Corrected Reading EIRP	Peak Limit (dBm)	PK Margin (dB)	Azimuth (Degs)	Height (cm)	Polarity
1	5.85	-67.42	Pk	34.9	-17.7	11.8	-38.42	-17	-21.42	303	388	H
2	5.906	-64.73	Pk	35.1	-17.5	11.8	-35.33	-27	-8.33	303	388	H

Pk - Peak detector

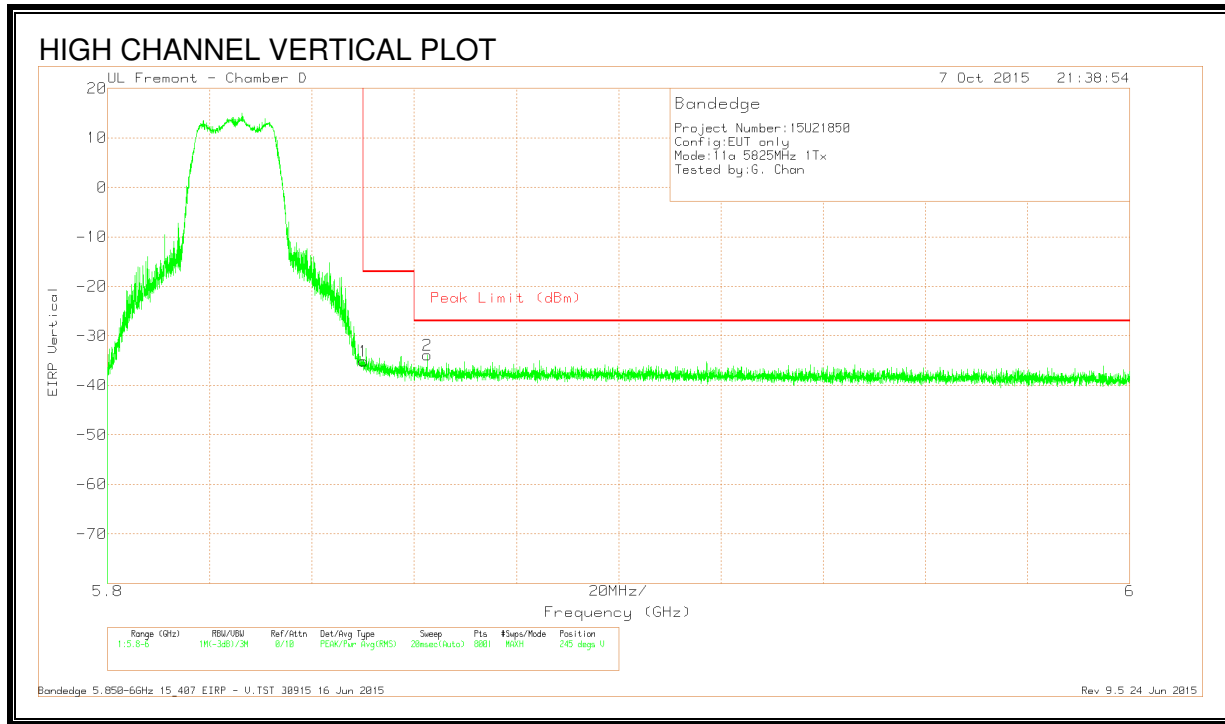

DATA

Marker	Frequency (GHz)	Meter Reading (dBm)	Det	AFT344 (dB/m)	Amp/Cbl/F ltr/Pad (dB)	Conversion Factor (dB)	Corrected Reading EIRP	Peak Limit (dBm)	PK Margin (dB)	Azimuth (Degs)	Height (cm)	Polarity
1	5.85	-64.1	Pk	34.9	-17.7	11.8	-35.1	-17	-18.1	245	126	V
2	5.863	-63.11	Pk	35	-17.6	11.8	-33.91	-27	-6.91	245	126	V

Pk - Peak detector

LOW CHANNEL HARMONICS AND SPURIOUS EMISSIONS

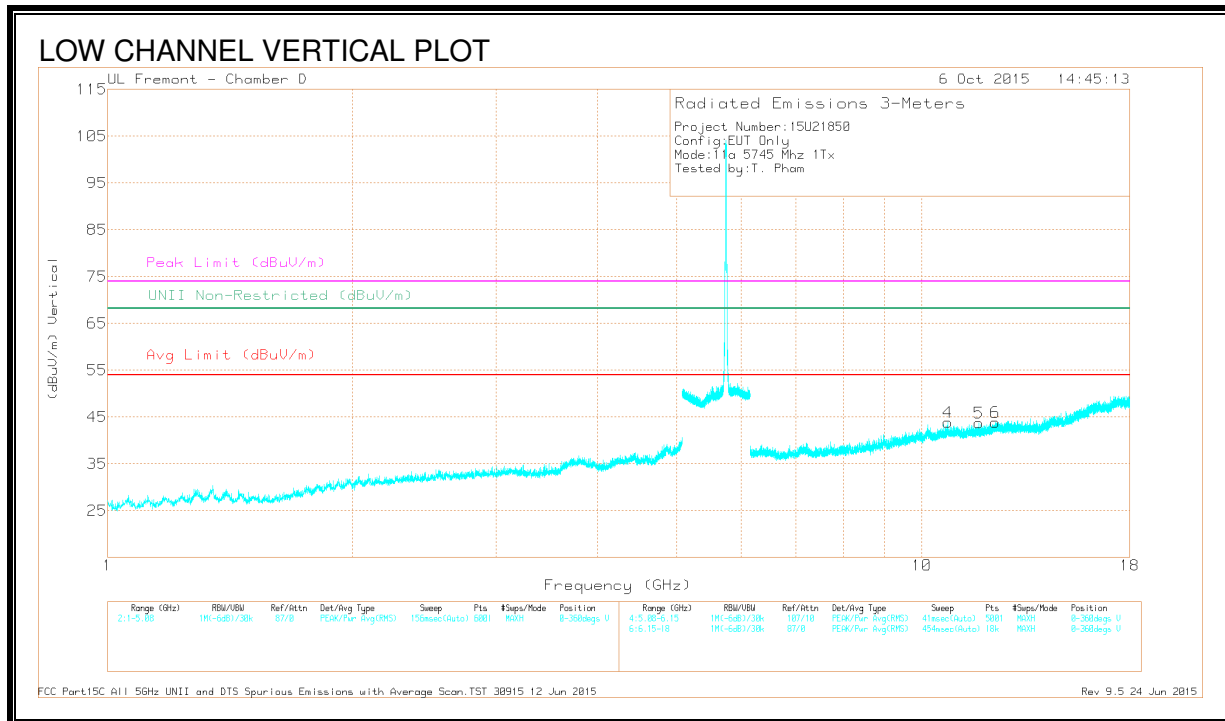
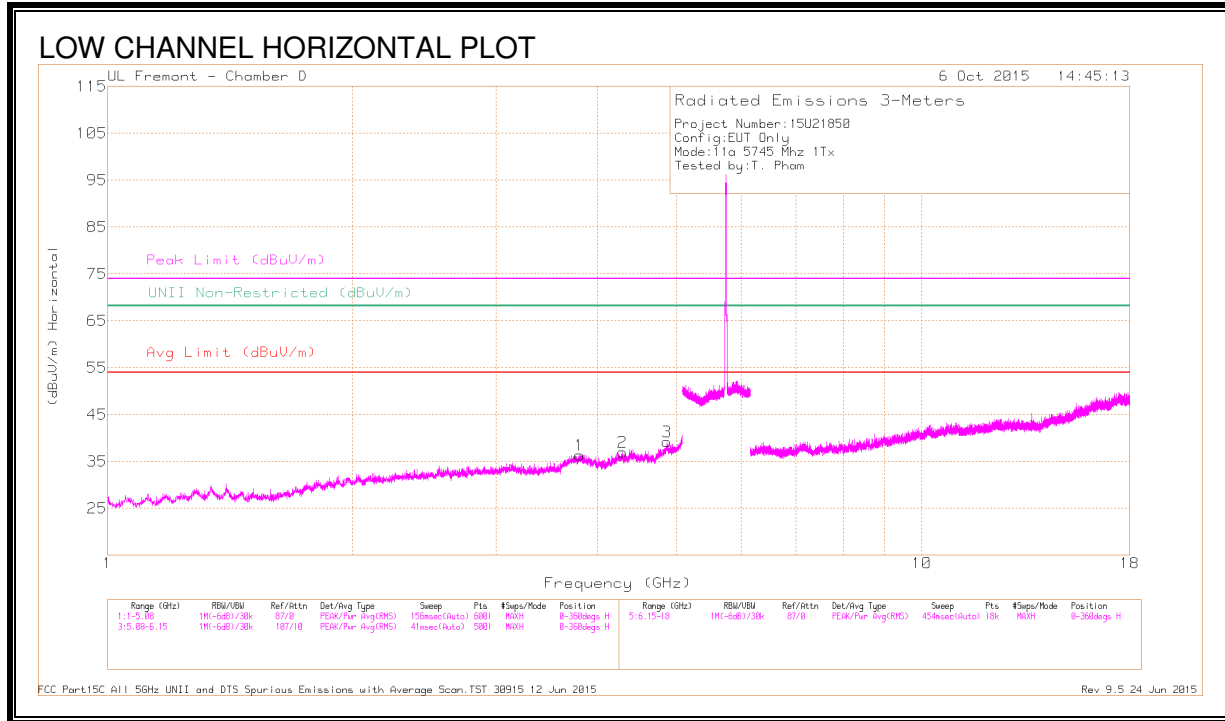

DATA

Frequency (GHz)	Meter Reading (dBuV)	Det	AFT344 (dB/m)	Amp/Cbl/FI tr/Pad (dB)	Corrected Reading (dBuV/m)	Avg Limit (dBuV/m)	Margin (dB)	Peak Limit (dBuV/m)	PK Margin (dB)	UNII Non-Restricted (dBuV/m)	PK Margin (dB)	Azimuth (Degs)	Height (cm)	Polarity
* 3.799	39.19	PK-U	33.3	-28.7	43.79	-	-	74	-30.21	-	-	276	161	H
* 3.8	27.39	ADR	33.3	-28.7	31.99	54	-22.01	-	-	-	-	276	161	H
* 4.287	38.58	PK-U	33.6	-28	44.18	-	-	74	-29.82	-	-	259	150	H
* 4.285	26.81	ADR	33.6	-28	32.41	54	-21.59	-	-	-	-	259	150	H
* 4.861	37.82	PK-U	34.1	-25.4	46.52	-	-	74	-27.48	-	-	274	132	H
* 4.862	25.83	ADR	34.1	-25.4	34.53	54	-19.47	-	-	-	-	274	132	H
* 10.764	34.75	PK-U	37.9	-20.9	51.75	-	-	74	-22.25	-	-	285	157	V
* 10.764	22.76	ADR	37.9	-20.9	39.76	54	-14.24	-	-	-	-	285	157	V
* 11.747	34.44	PK-U	38.2	-21.5	51.14	-	-	74	-22.86	-	-	276	145	V
* 11.748	23.13	ADR	38.2	-21.5	39.83	54	-14.17	-	-	-	-	276	145	V
* 12.302	35.37	PK-U	39	-22.1	52.27	-	-	74	-21.73	-	-	256	166	V
* 12.302	23.53	ADR	39	-22.1	40.43	54	-13.57	-	-	-	-	256	166	V

* - indicates frequency in CFR15.205/IC8.10 Restricted Band

PK-U - U-NII: Maximum Peak

ADR - U-NII AD primary method, RMS average

MID CHANNEL HARMONICS AND SPURIOUS EMISSIONS

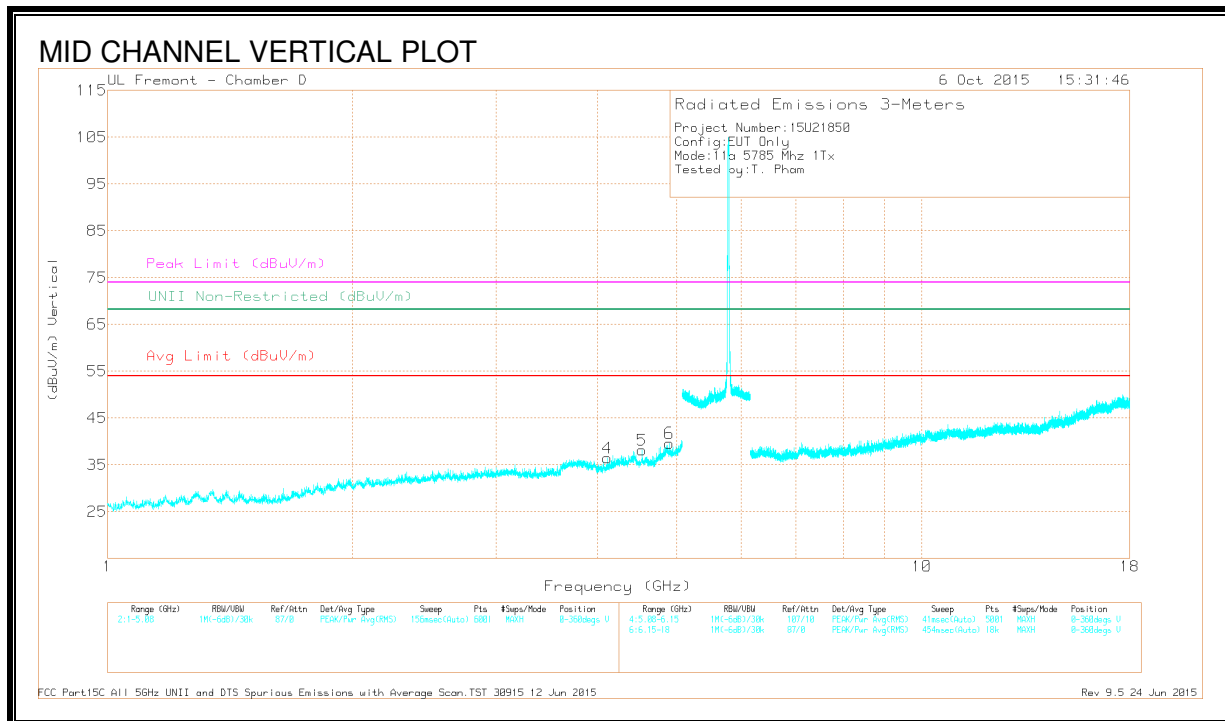
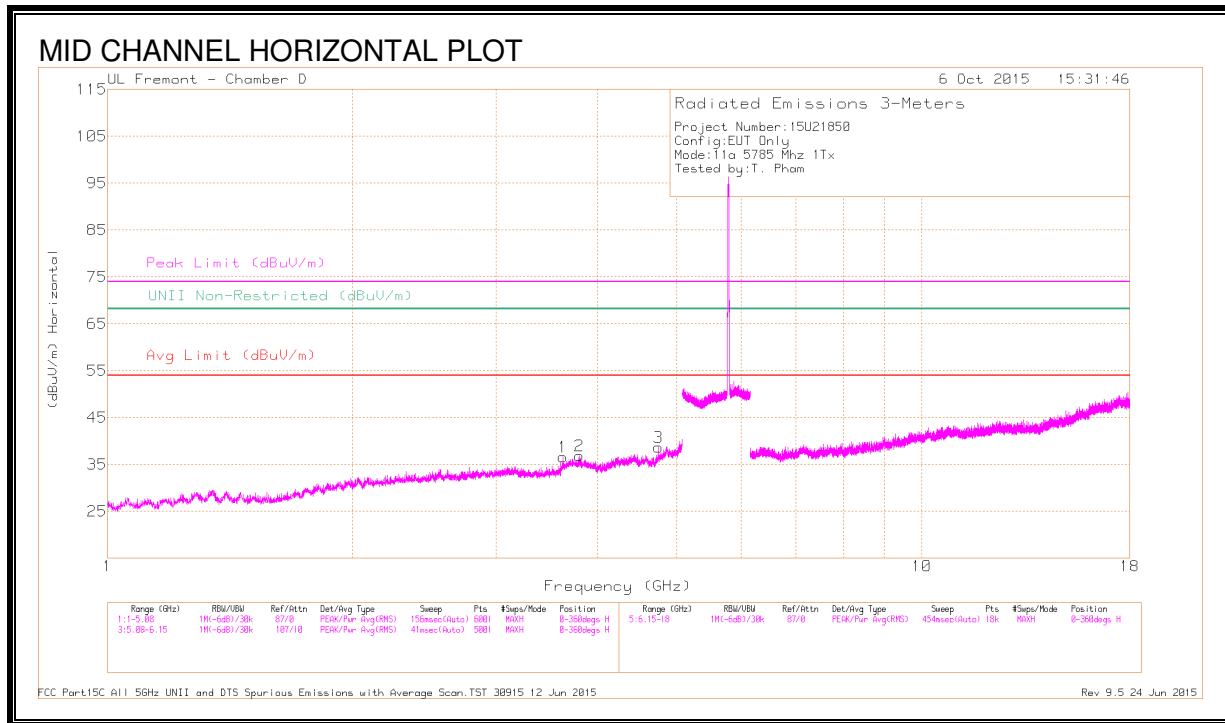

DATA

Frequency (GHz)	Meter Reading (dBuV)	Det	AF T344 (dB/m)	Amp/Cb/FI tr/Pad (dB)	Corrected Reading (dBuV/m)	Avg Limit (dBuV/m)	Margin (dB)	Peak Limit (dBuV/m)	PK Margin (dB)	UNII Non-Restricted (dBuV/m)	PK Margin (dB)	Azimuth (Degs)	Height (cm)	Polarity
* 3.621	39	PK-U	33.1	-29.2	42.9	-	-	74	-31.1	-	-	208	178	H
* 3.622	27.25	ADR	33.1	-29.2	31.15	54	-22.85	-	-	-	-	208	178	H
* 3.795	39.39	PK-U	33.3	-28.7	43.99	-	-	74	-30.01	-	-	196	150	H
* 3.795	27.34	ADR	33.3	-28.7	31.94	54	-22.06	-	-	-	-	196	150	H
* 3.795	39.34	PK-U	33.3	-28.7	43.94	-	-	74	-30.06	-	-	204	159	H
* 3.795	27.39	ADR	33.3	-28.7	31.99	54	-22.01	-	-	-	-	204	159	H
* 4.743	39.01	PK-U	34.1	-27.6	45.51	-	-	74	-28.49	-	-	228	179	H
* 4.744	27.45	ADR	34.1	-27.6	33.95	54	-20.05	-	-	-	-	228	179	H
* 4.111	38.67	PK-U	33.4	-28.7	43.37	-	-	74	-30.63	-	-	187	197	V
* 4.11	26.84	ADR	33.4	-28.7	31.54	54	-22.46	-	-	-	-	187	197	V
* 4.532	38.67	PK-U	34	-28.1	44.57	-	-	74	-29.43	-	-	218	186	V
* 4.533	26.99	ADR	34	-28.1	32.89	54	-21.11	-	-	-	-	218	186	V
* 4.9	37.2	PK-U	34.1	-26	45.3	-	-	74	-28.7	-	-	228	204	V
* 4.901	25.65	ADR	34.1	-26	33.75	54	-20.25	-	-	-	-	228	204	V

* - indicates frequency in CFR15.205/IC8.10 Restricted Band

PK-U - U-NII: Maximum Peak

ADR - U-NII AD primary method, RMS average

HIGH CHANNEL HARMONICS AND SPURIOUS EMISSIONS

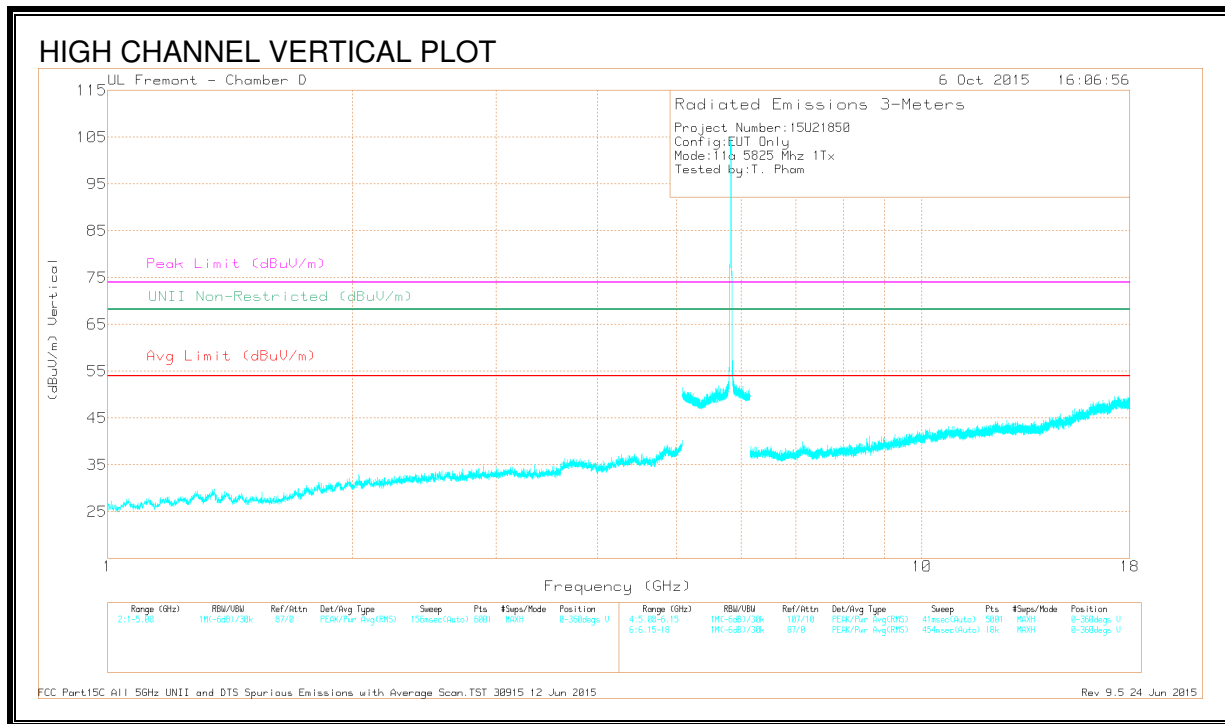
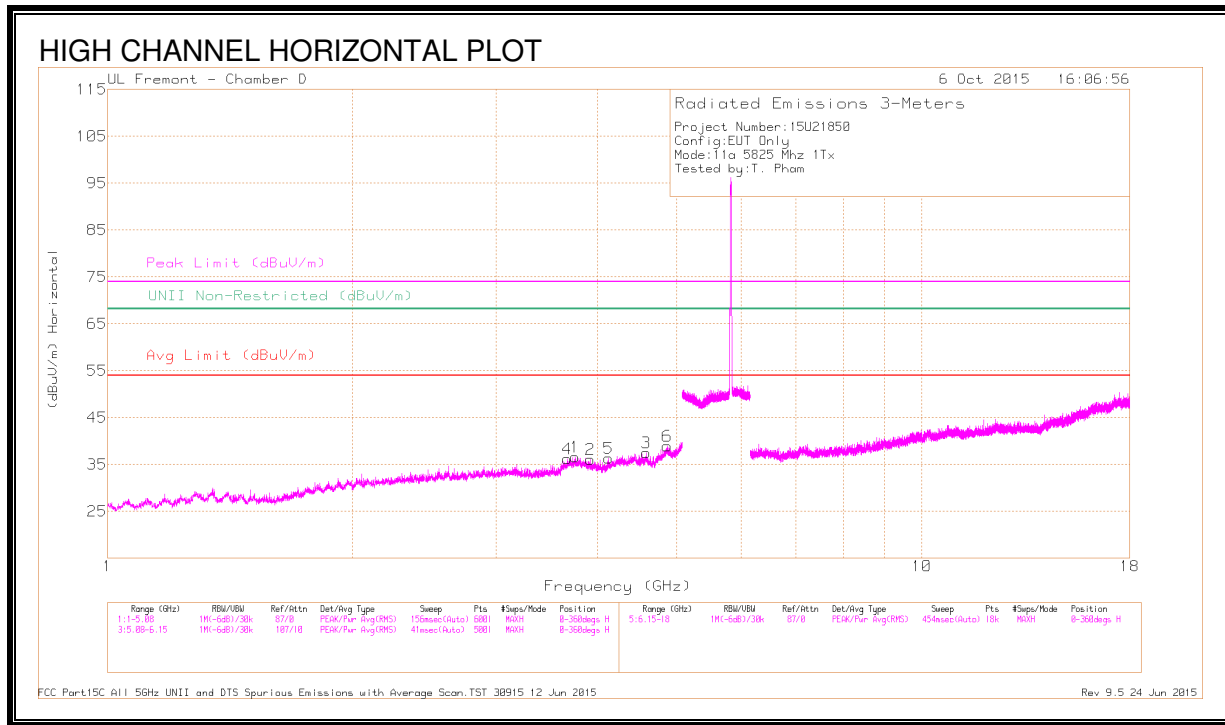

DATA

Frequency (GHz)	Meter Reading (dBuV)	Det	AF T344 (dB/m)	Amp/Cb/FI tr/Pad (dB)	Corrected Reading (dBuV/m)	Avg Limit (dBuV/m)	Margin (dB)	Peak Limit (dBuV/m)	PK Margin (dB)	UNII Non-Restricted (dBuV/m)	PK Margin (dB)	Azimuth (Degs)	Height (cm)	Polarity
* 3.75	38.97	PK-U	33.3	-29	43.27	-	-	74	-30.73	-	-	315	117	H
* 3.75	27.2	ADR	33.3	-29	31.5	54	-22.5	-	-	-	-	315	117	H
* 3.919	39.07	PK-U	33.4	-28.7	43.77	-	-	74	-30.23	-	-	306	147	H
* 3.919	27.19	ADR	33.4	-28.7	31.89	54	-22.11	-	-	-	-	306	147	H
* 4.586	38.26	PK-U	34.1	-27.1	45.26	-	-	74	-28.74	-	-	282	167	H
* 4.587	26.73	ADR	34.1	-27.1	33.73	54	-20.27	-	-	-	-	282	167	H
* 3.672	38.91	PK-U	33.1	-29.2	42.81	-	-	74	-31.19	-	-	293	177	H
* 3.672	27.18	ADR	33.1	-29.2	31.08	54	-22.92	-	-	-	-	293	177	H
* 4.122	38.86	PK-U	33.4	-28.5	43.76	-	-	74	-30.24	-	-	301	194	H
* 4.122	26.91	ADR	33.4	-28.5	31.81	54	-22.19	-	-	-	-	301	194	H
* 4.868	36.95	PK-U	34.1	-25.2	45.85	-	-	74	-28.15	-	-	305	218	H
* 4.866	25.52	ADR	34.1	-25.3	34.32	54	-19.68	-	-	-	-	305	218	H

* - indicates frequency in CFR15.205/IC8.10 Restricted Band

PK-U - U-NII: Maximum Peak

ADR - U-NII AD primary method, RMS average

9.2.2. CHAIN 1, RESTRICTED BANDEDGE

LOW CHANNEL

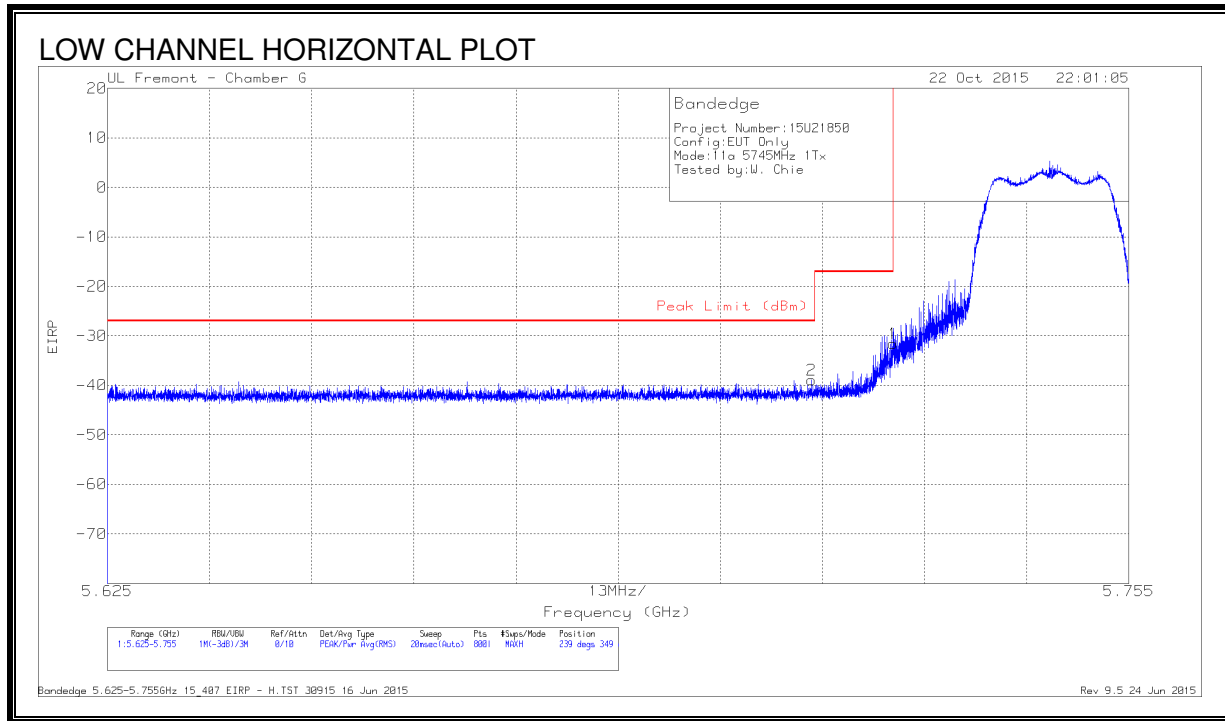

DATA

Marker	Frequency (GHz)	Meter Reading (dBm)	Det	AF T862 (dB/m)	Amp/Cbl/F ltr/Pad (dB)	Conversion Factor (dB)	Corrected Reading EIRP	Peak Limit (dBm)	PK Margin (dB)	Azimuth (Degs)	Height (cm)	Polarity
2	5.715	-62.68	Pk	34.9	-22.9	11.8	-38.88	-27	-11.88	239	349	H
1	5.725	-55.47	Pk	35	-22.9	11.8	-31.57	-17	-14.57	239	349	H

Pk - Peak detector

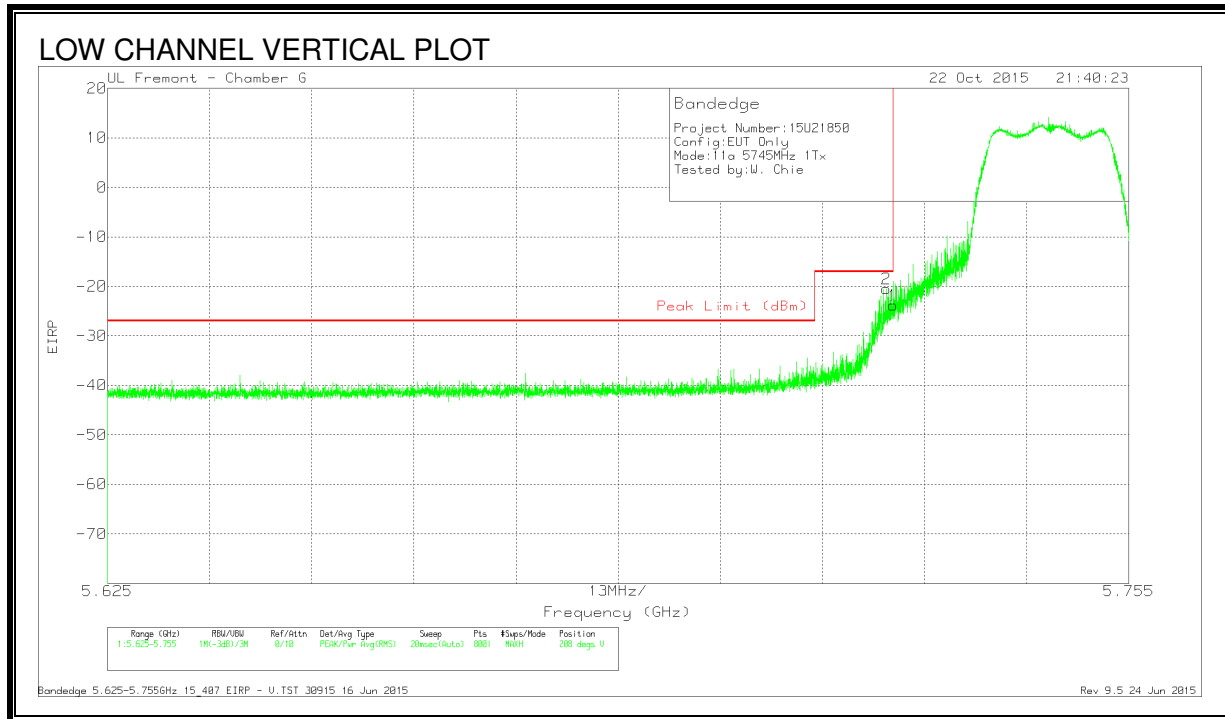

DATA

Marker	Frequency (GHz)	Meter Reading (dBm)	Det	AF T862 (dB/m)	Amp/Cbl/F ltr/Pad (dB)	Conversion Factor (dB)	Corrected Reading EIRP	Peak Limit (dBm)	PK Margin (dB)	Azimuth (Degs)	Height (cm)	Polarity
2	5.724	-44.36	Pk	35	-22.9	11.8	-20.46	-17	-3.46	208	303	V
1	5.725	-47.67	Pk	35	-22.9	11.8	-23.77	-17	-6.77	208	303	V

Pk - Peak detector

RESTRICTED BANDEDGE, (HIGH CHANNEL)

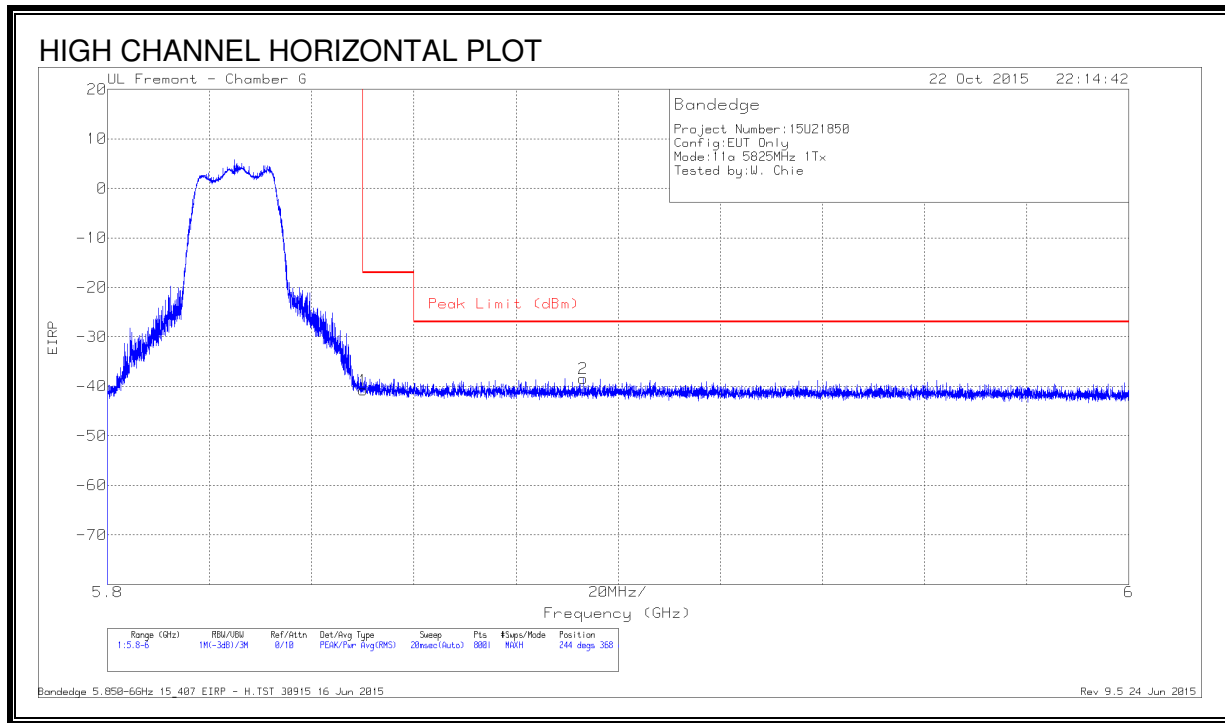

DATA

Marker	Frequency (GHz)	Meter Reading (dBm)	Det	AF T862 (dB/m)	Amp/Cbl/F Itr/Pad (dB)	Conversion Factor (dB)	Corrected Reading EIRP	Peak Limit (dBm)	PK Margin (dB)	Azimuth (Degs)	Height (cm)	Polarity
1	5.85	-64.69	Pk	35.1	-23	11.8	-40.79	-17	-23.79	244	368	H
2	5.893	-62.21	Pk	35.1	-23.1	11.8	-38.41	-27	-11.41	244	368	H

Pk - Peak detector

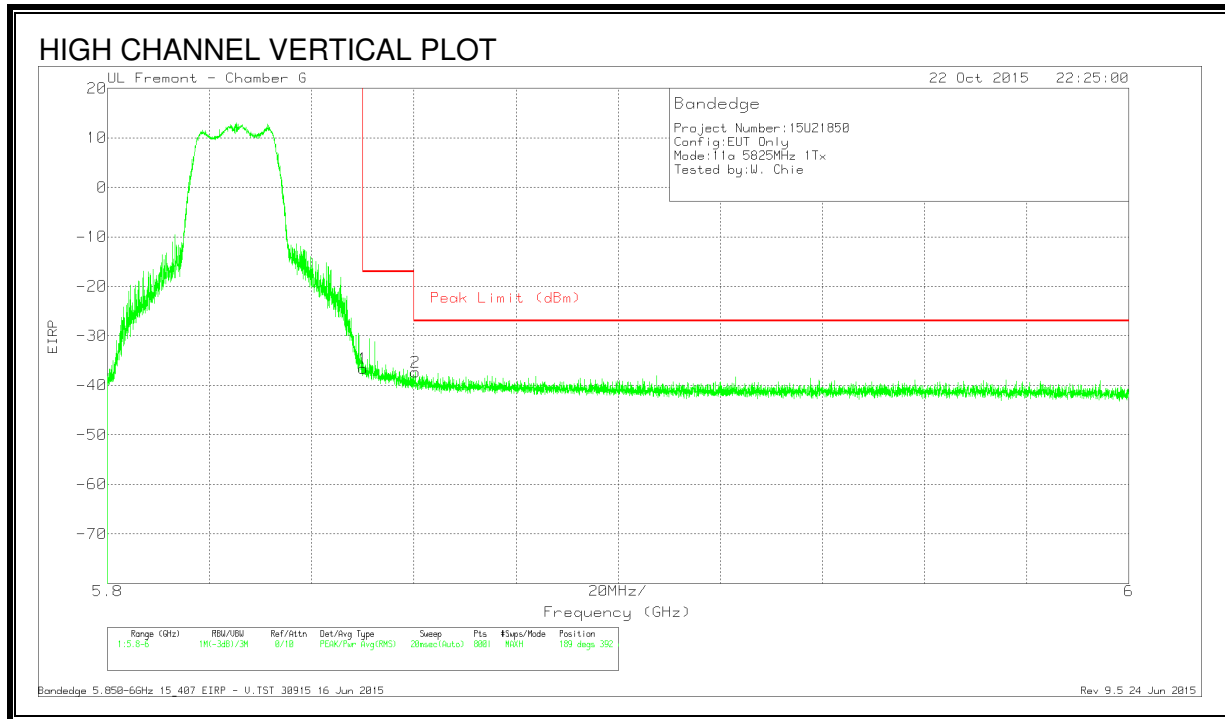

DATA

Marker	Frequency (GHz)	Meter Reading (dBm)	Det	AF T862 (dB/m)	Amp/Cbl/F ltr/Pad (dB)	Conversion Factor (dB)	Corrected Reading EIRP	Peak Limit (dBm)	PK Margin (dB)	Azimuth (Degs)	Height (cm)	Polarity
1	5.85	-60.46	Pk	35.1	-23	11.8	-36.56	-17	-19.56	189	392	V
2	5.86	-61.1	Pk	35.1	-23.1	11.8	-37.3	-27	-10.3	189	392	V

Pk - Peak detector

LOW CHANNEL HARMONICS AND SPURIOUS EMISSIONS

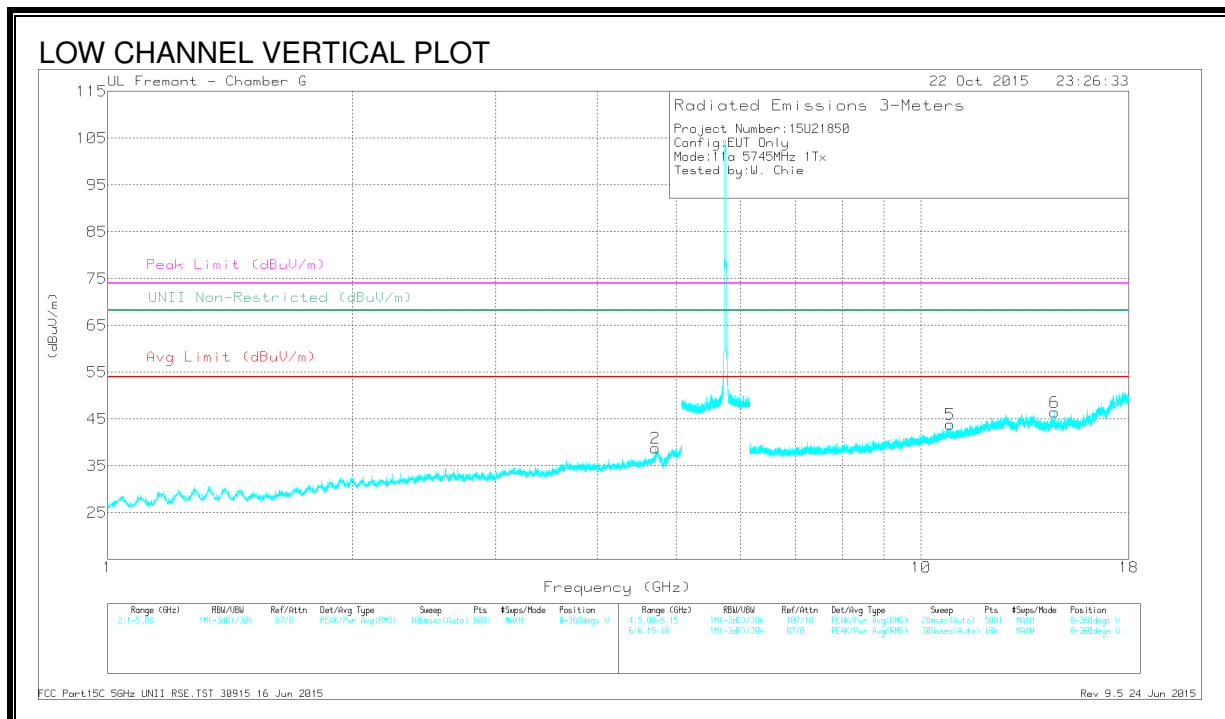
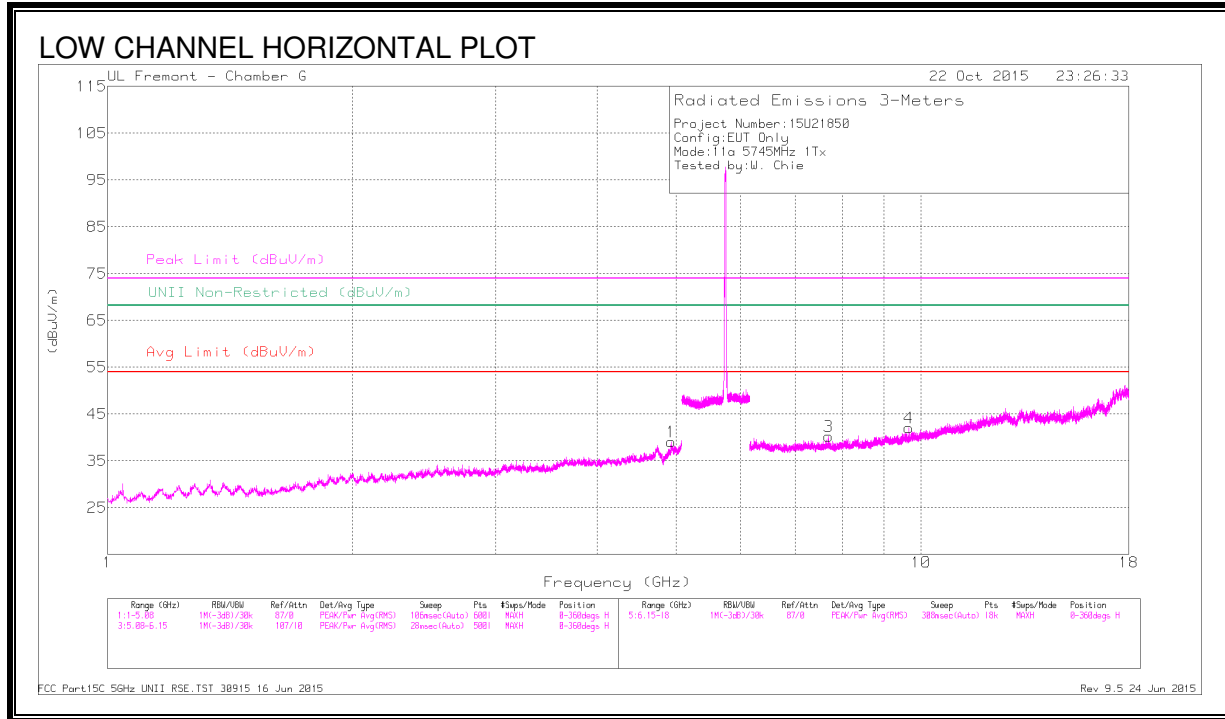

DATA

Marker	Frequency (GHz)	Meter Reading (dBuV)	Det	AF T862 (dB/m)	Amp/Cbl/FI tr/Pad (dB)	Corrected Reading (dBuV/m)	Avg Limit (dBuV/m)	Margin (dB)	Peak Limit (dBuV/m)	PK Margin (dB)	UNII Non-Restricted (dBuV/m)	PK Margin (dB)	Azimuth (Degs)	Height (cm)	Polarity
1	* 4.934	41.77	PK-U	34.1	-31.2	44.67	-	-	74	-29.33	-	-	13	340	H
	* 4.934	30.23	ADR	34.1	-31.2	33.13	54	-20.87	-	-	-	-	13	340	H
2	* 4.719	43.64	PK-U	33.9	-31.9	45.64	-	-	74	-28.36	-	-	219	384	V
	* 4.72	32.22	ADR	33.9	-31.9	34.22	54	-19.78	-	-	-	-	219	384	V
3	* 7.701	40.83	PK-U	35.6	-30	46.43	-	-	74	-27.57	-	-	100	125	H
	* 7.702	28.82	ADR	35.6	-30	34.42	54	-19.58	-	-	-	-	100	125	H
5	* 10.849	38.17	PK-U	38	-26.3	49.87	-	-	74	-24.13	-	-	195	250	V
	* 10.845	26.23	ADR	38	-26.3	37.93	54	-16.07	-	-	-	-	195	250	V
4	9.662	39.5	PK-U	36.8	-28.6	47.7	-	-	-	-	68.2	-20.5	42	123	H
6	14.588	39.11	PK-U	39.9	-26.5	52.51	-	-	-	-	68.2	-15.69	158	233	V

* - indicates frequency in CFR15.205/IC8.10 Restricted Band

PK-U - U-NII: Maximum Peak

ADR - U-NII AD primary method, RMS average

MID CHANNEL HARMONICS AND SPURIOUS EMISSIONS

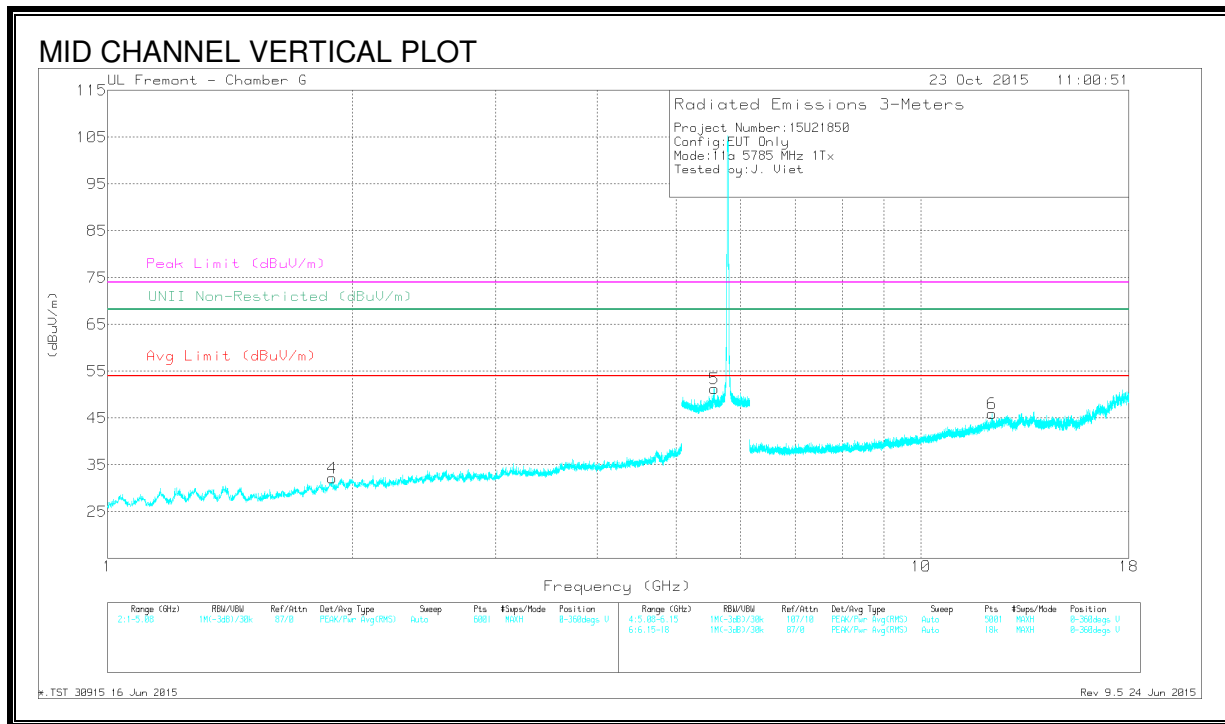
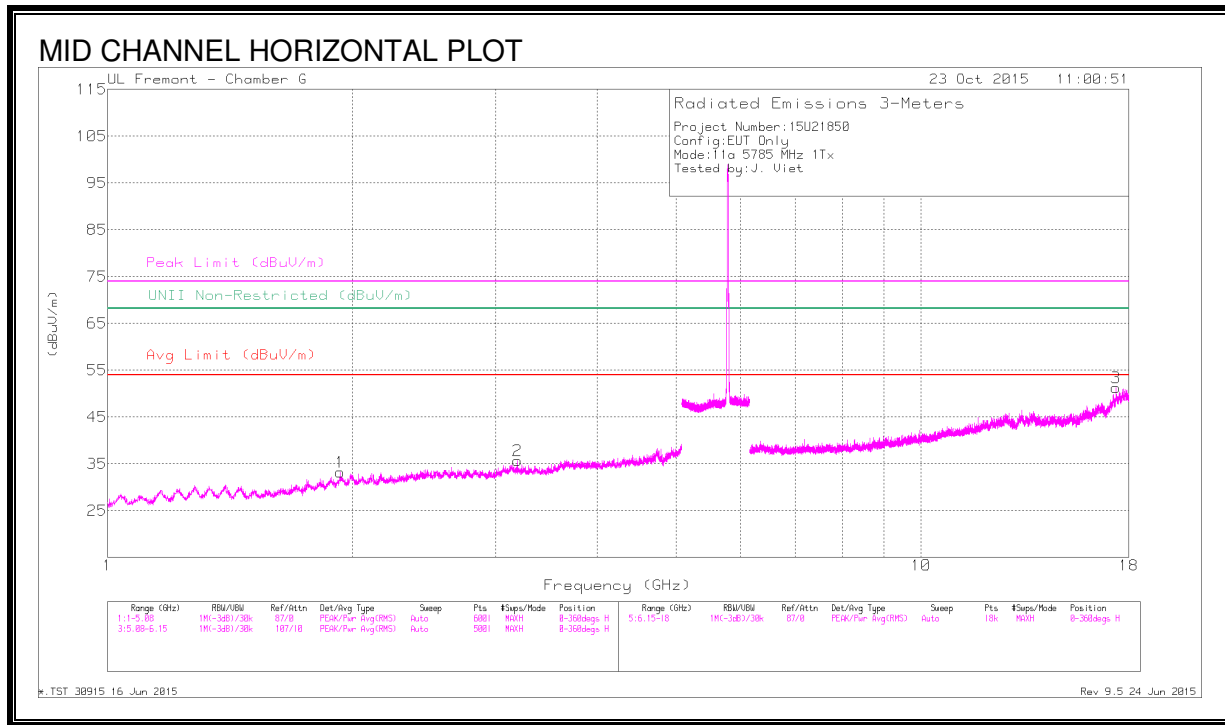

DATA

Marker	Frequency (GHz)	Meter Reading (dBuV)	Det	AFT862 (dB/m)	Amp/Cbl/Fitr/Pad (dB)	Corrected Reading (dBuV/m)	Avg Limit (dBuV/m)	Margin (dB)	Peak Limit (dBuV/m)	PK Margin (dB)	UNII Non-Restricted (dBuV/m)	PK Margin (dB)	Azimuth (Degs)	Height (cm)	Polarity
6	* 12.215	37.86	PK-U	39	-24.8	52.06	-	-	74	-21.94	-	-	185	202	V
	* 12.212	26.75	ADR	39	-24.7	41.05	54	-12.95	-	-	-	-	185	202	V
4	1.886	42.56	PK-U	30.8	-34.6	38.76	-	-	-	-	68.2	-29.44	360	301	V
1	1.932	42.78	PK-U	31	-34.1	39.68	-	-	-	-	68.2	-28.52	25	171	H
2	3.194	41.88	PK-U	33.1	-33.6	41.38	-	-	-	-	68.2	-26.82	276	281	H
5	5.571	46.8	PK-U	34.8	-23	58.6	-	-	-	-	68.2	-9.6	196	394	V
3	17.355	36.58	PK-U	41.4	-21.1	56.88	-	-	-	-	68.2	-11.32	221	208	H

* - indicates frequency in CFR15.205/IC8.10 Restricted Band

PK-U - U-NII: Maximum Peak

ADR - U-NII AD primary method, RMS average

HIGH CHANNEL HARMONICS AND SPURIOUS EMISSIONS

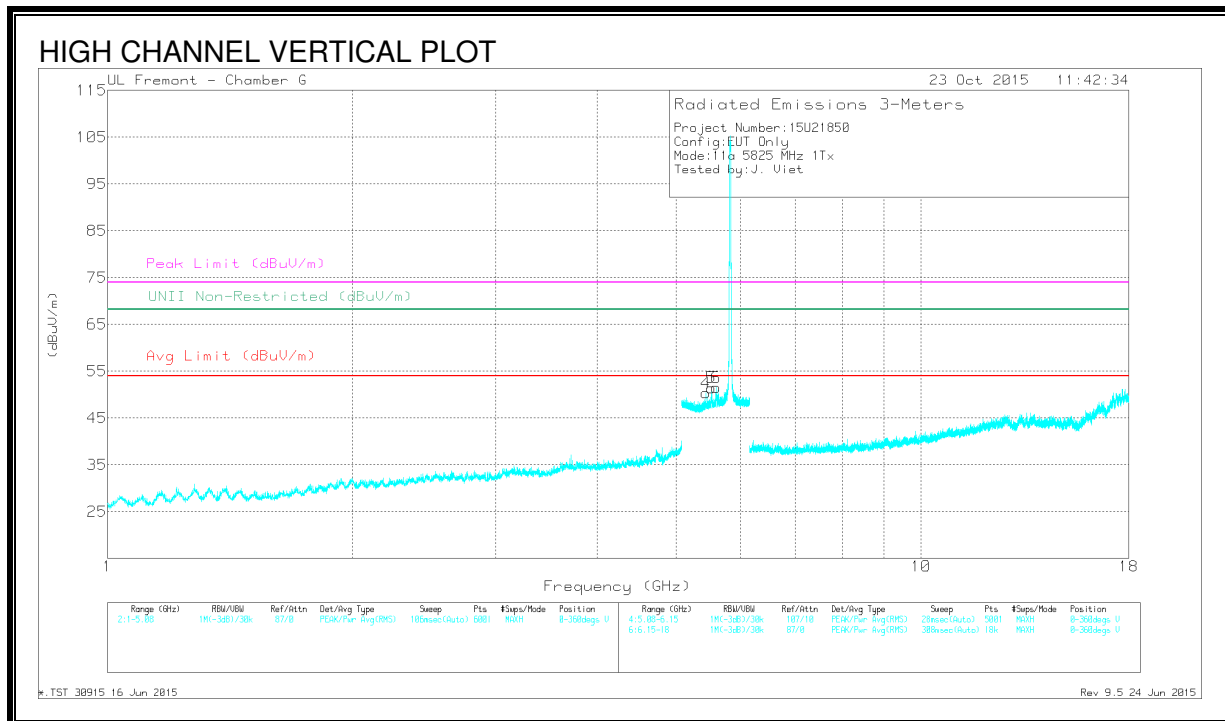
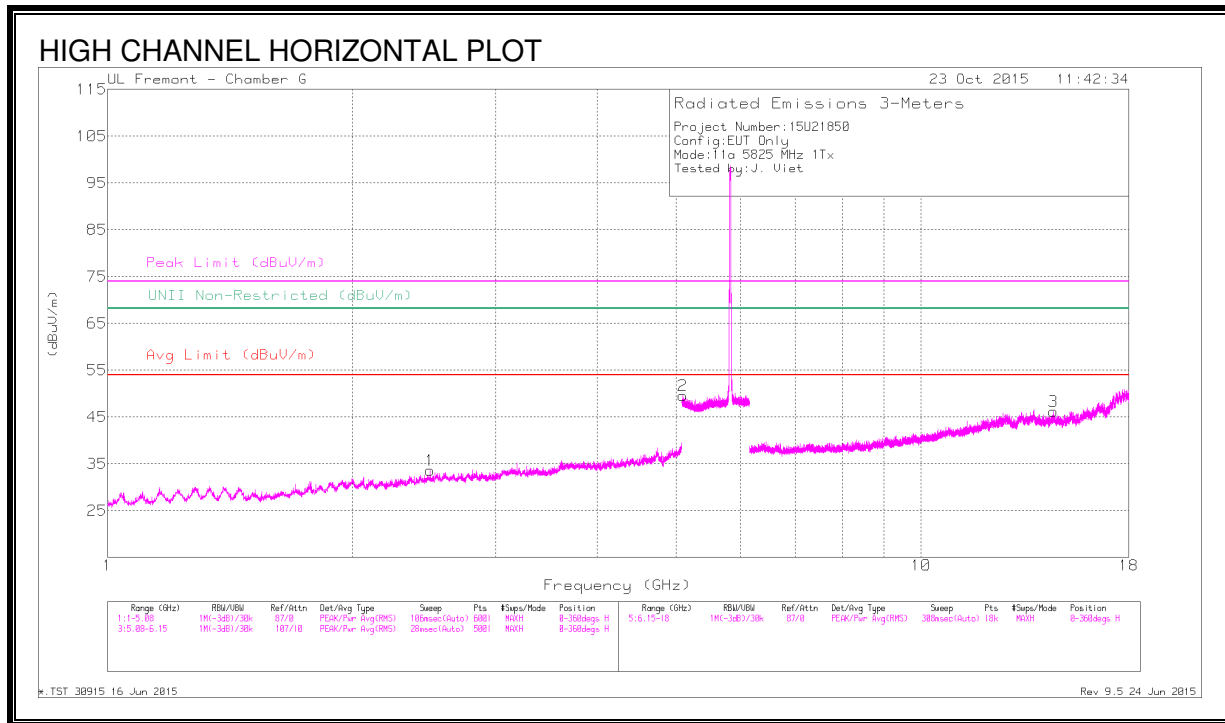

DATA

Marker	Frequency (GHz)	Meter Reading (dBuV)	Det	AFT862 (dB/m)	Amp/Cbl/Filtr/Pad (dB)	Corrected Reading (dBuV/m)	Avg Limit (dBuV/m)	Margin (dB)	Peak Limit (dBuV/m)	PK Margin (dB)	UNII Non-Restricted (dBuV/m)	PK Margin (dB)	Azimuth (Degs)	Height (cm)	Polarity
1	* 2.49	42.1	PK-U	32.3	-34	40.4	-	-	74	-33.6	-	-	360	202	H
	* 2.489	30.58	ADR	32.3	-34	28.88	54	-25.12	-	-	-	-	360	202	H
2	* 5.094	44.24	PK-U	34.2	-23.2	55.24	-	-	74	-18.76	-	-	63	181	H
	* 5.094	32.68	ADR	34.2	-23.2	43.68	54	-10.32	-	-	-	-	63	181	H
4	* 5.434	44.03	PK-U	34.5	-22.9	55.63	-	-	74	-18.37	-	-	223	301	V
	* 5.437	32.45	ADR	34.5	-22.9	44.05	54	-9.95	-	-	-	-	223	301	V
5	5.526	47	PK-U	34.7	-23	58.7	-	-	-	-	68.2	-9.5	193	108	V
6	5.599	46.98	PK-U	34.9	-23.1	58.78	-	-	-	-	68.2	-9.42	196	270	V
3	14.549	39.59	PK-U	39.9	-26.6	52.89	-	-	-	-	68.2	-15.31	13	192	H

* - indicates frequency in CFR15.205/IC8.10 Restricted Band

PK-U - U-NII: Maximum Peak

ADR - U-NII AD primary method, RMS average

9.3. 802.11n HT20 2Tx CDD MODE IN THE 5.8 GHz BAND

RESTRICTED BANDEDGE (LOW CHANNEL)

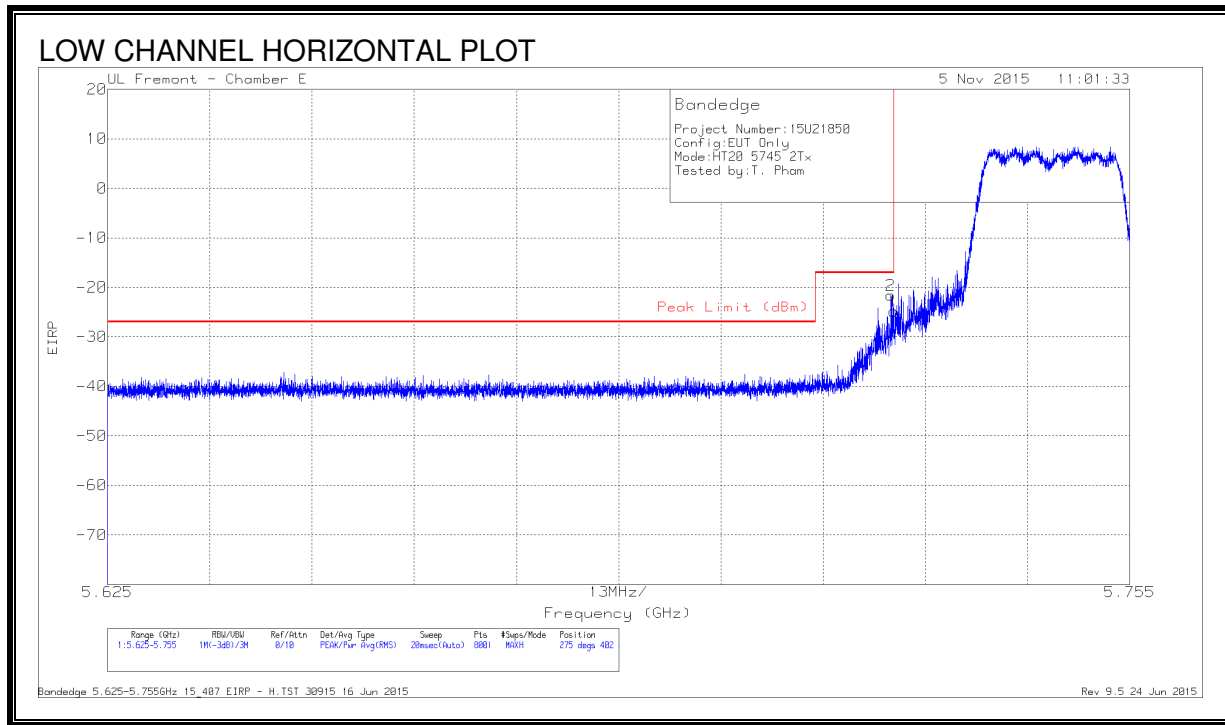

DATA

Marker	Frequency (GHz)	Meter Reading (dBm)	Det	AF T346 (dB/m)	Amp/Cbl/F ltr/Pad (dB)	Conversion Factor (dB)	Corrected Reading EIRP	Peak Limit (dBm)	PK Margin (dB)	Azimuth (Degs)	Height (cm)	Polarity
1	5.725	-51.25	Pk	34.7	-20.1	11.8	-24.85	-17	-7.85	275	402	H
2	5.725	-47.98	Pk	34.7	-20.1	11.8	-21.58	-17	-4.58	275	402	H

Pk - Peak detector

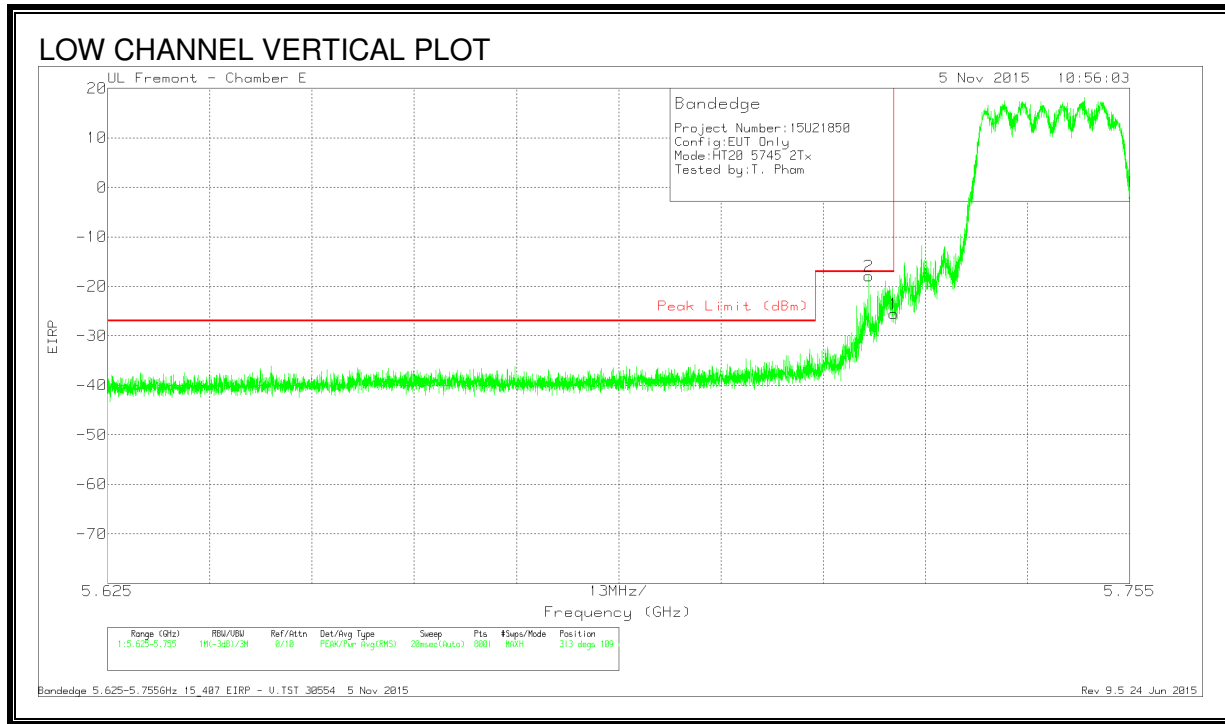

DATA

Marker	Frequency (GHz)	Meter Reading (dBm)	Det	AF T346 (dB/m)	Amp/Cbl/F ltr/Pad (dB)	Conversion Factor (dB)	Corrected Reading EIRP	Peak Limit (dBm)	PK Margin (dB)	Azimuth (Degs)	Height (cm)	Polarity
2	5.722	-44.35	Pk	34.7	-20.1	11.8	-17.95	-17	-.95	313	109	V
1	5.725	-51.95	Pk	34.7	-20.1	11.8	-25.55	-17	-8.55	313	109	V

Pk - Peak detector

RESTRICTED BANDEDGE (HIGH CHANNEL)

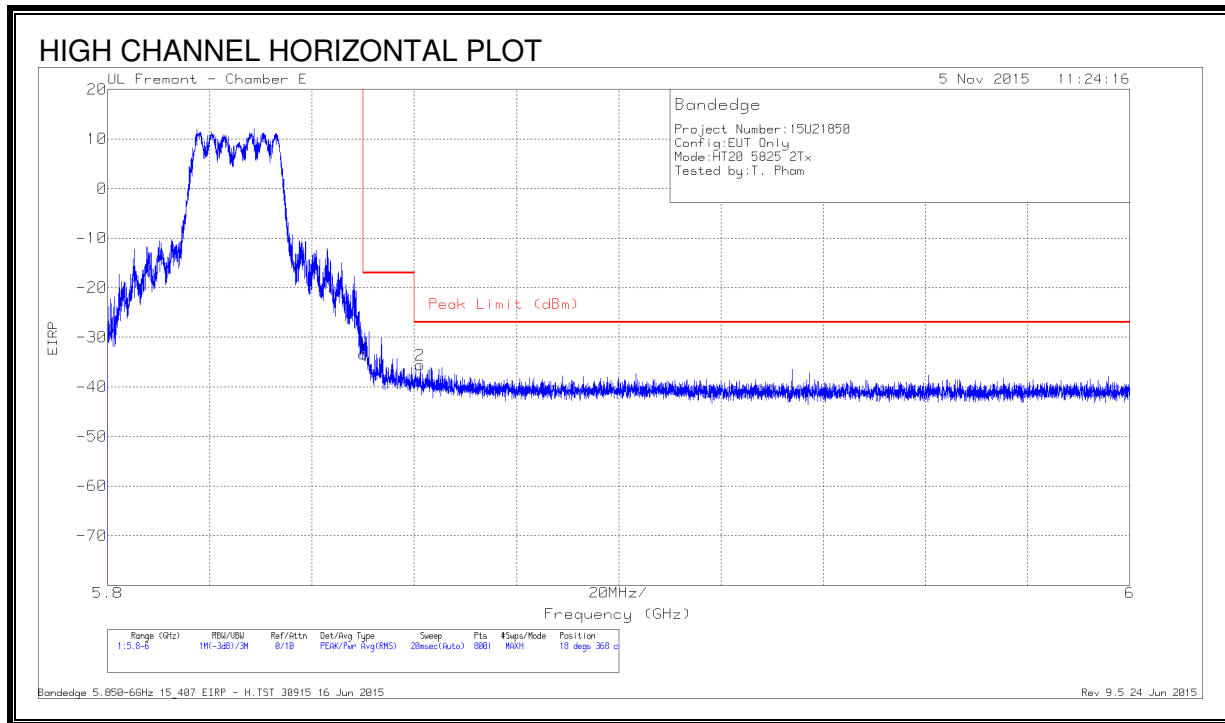

DATA

Marker	Frequency (GHz)	Meter Reading (dBm)	Det	AF T346 (dB/m)	Amp/Cbl/F Itr/Pad (dB)	Conversion Factor (dB)	Corrected Reading EIRP	Peak Limit (dBm)	PK Margin (dB)	Azimuth (Degs)	Height (cm)	Polarity
1	5.85	-59.82	Pk	34.9	-20.3	11.8	-33.42	-17	-16.42	18	368	H
2	5.861	-61.86	Pk	34.9	-20.4	11.8	-35.56	-27	-8.56	18	368	H

Pk - Peak detector

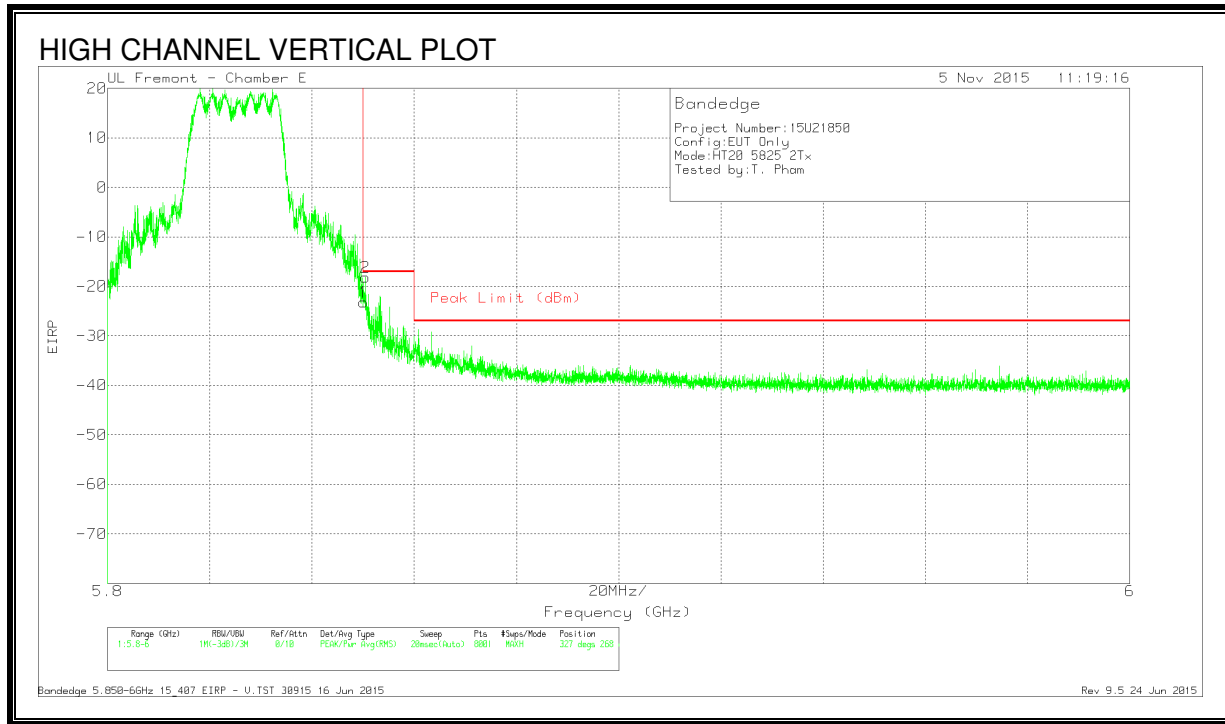

DATA

Marker	Frequency (GHz)	Meter Reading (dBm)	Det	AF T346 (dB/m)	Amp/Cbl/F ltr/Pad (dB)	Conversion Factor (dB)	Corrected Reading EIRP	Peak Limit (dBm)	PK Margin (dB)	Azimuth (Degs)	Height (cm)	Polarity
1	5.85	-49.58	Pk	34.9	-20.3	11.8	-23.18	-17	-6.18	327	268	V
2	5.85	-44.56	Pk	34.9	-20.3	11.8	-18.16	-17	-1.16	327	268	V

Pk - Peak detector

LOW CHANNEL HARMONICS AND SPURIOUS EMISSIONS

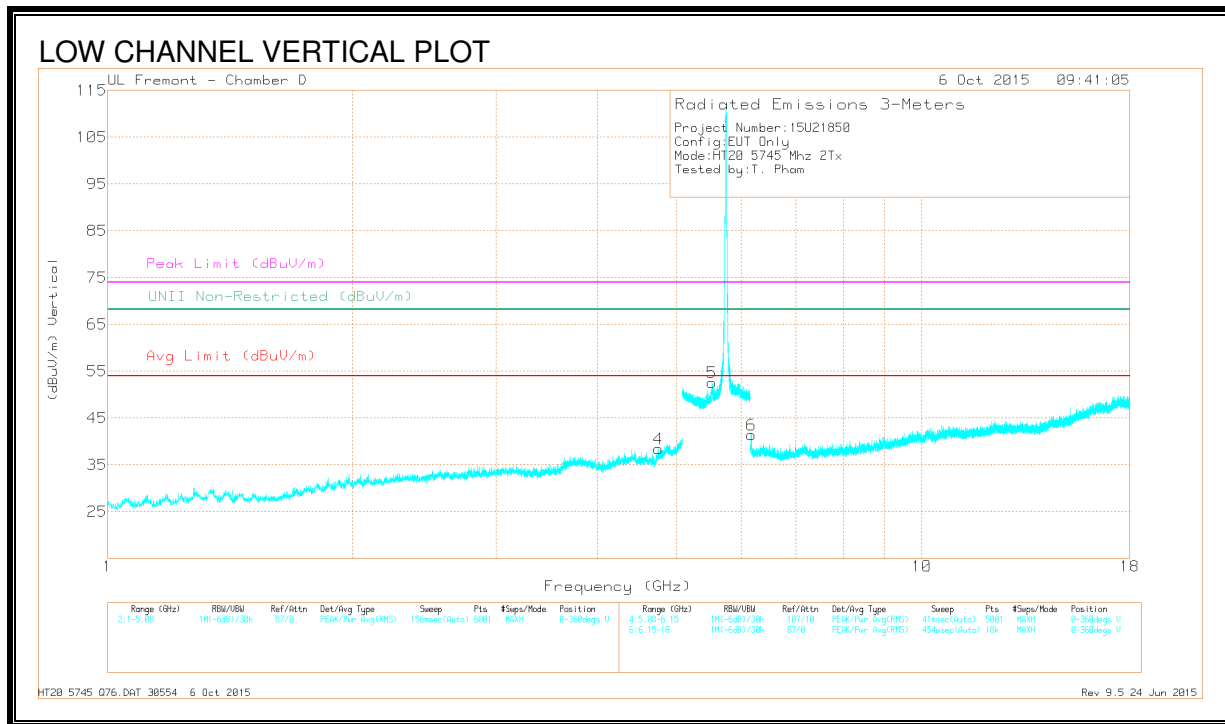
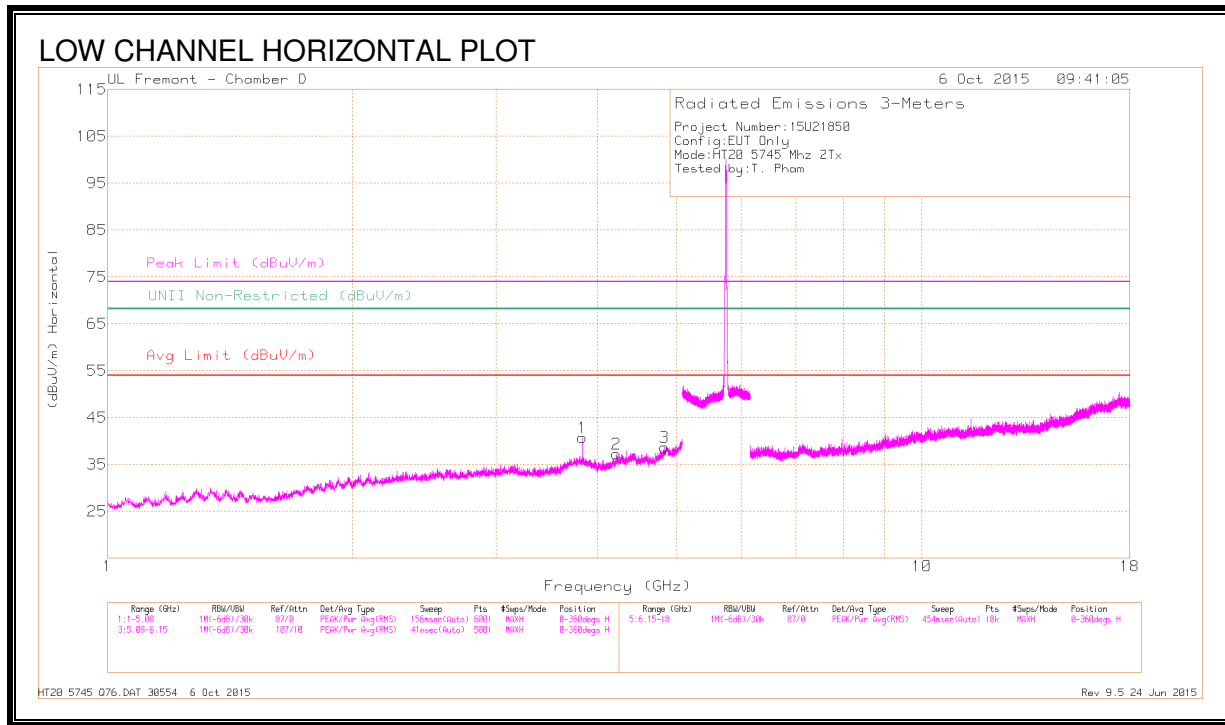

DATA

Frequency (GHz)	Meter Reading (dBuV)	Det	AF T344 (dB/m)	Amp/Cbl/FI tr/Pad (dB)	Corrected Reading (dBuV/m)	Avg Limit (dBuV/m)	Margin (dB)	Peak Limit (dBuV/m)	PK Margin (dB)	UNII Non-Restricted (dBuV/m)	PK Margin (dB)	Azimuth (Degs)	Height (cm)	Polarity
* 3.83	42.39	PK-U	33.4	-28.8	46.99	-	-	74	-27.01	-	-	11	114	H
* 3.83	33.55	ADR	33.4	-28.8	38.15	54	-15.85	-	-	-	-	11	114	H
* 4.218	38.02	PK-U	33.5	-27.9	43.62	-	-	74	-30.38	-	-	41	136	H
* 4.217	26.66	ADR	33.5	-27.9	32.26	54	-21.74	-	-	-	-	41	136	H
* 4.831	38.63	PK-U	34.1	-26.8	45.93	-	-	74	-28.07	-	-	68	158	H
* 4.831	26.65	ADR	34.1	-26.8	33.95	54	-20.05	-	-	-	-	68	158	H
* 4.746	39.33	PK-U	34.1	-27.6	45.83	-	-	74	-28.17	-	-	111	170	V
* 4.746	27.64	ADR	34.1	-27.6	34.14	54	-19.86	-	-	-	-	111	170	V
5.521	42.11	PK-U	34.4	-17.9	58.61	-	-	-	-	68.2	-9.59	96	161	V
6.179	36.98	PK-U	35.5	-26.4	46.08	-	-	-	-	68.2	-22.12	103	184	V

* - indicates frequency in CFR15.205/IC8.10 Restricted Band

PK-U - U-NII: Maximum Peak

ADR - U-NII AD primary method, RMS average

MID CHANNEL HARMONICS AND SPURIOUS EMISSIONS

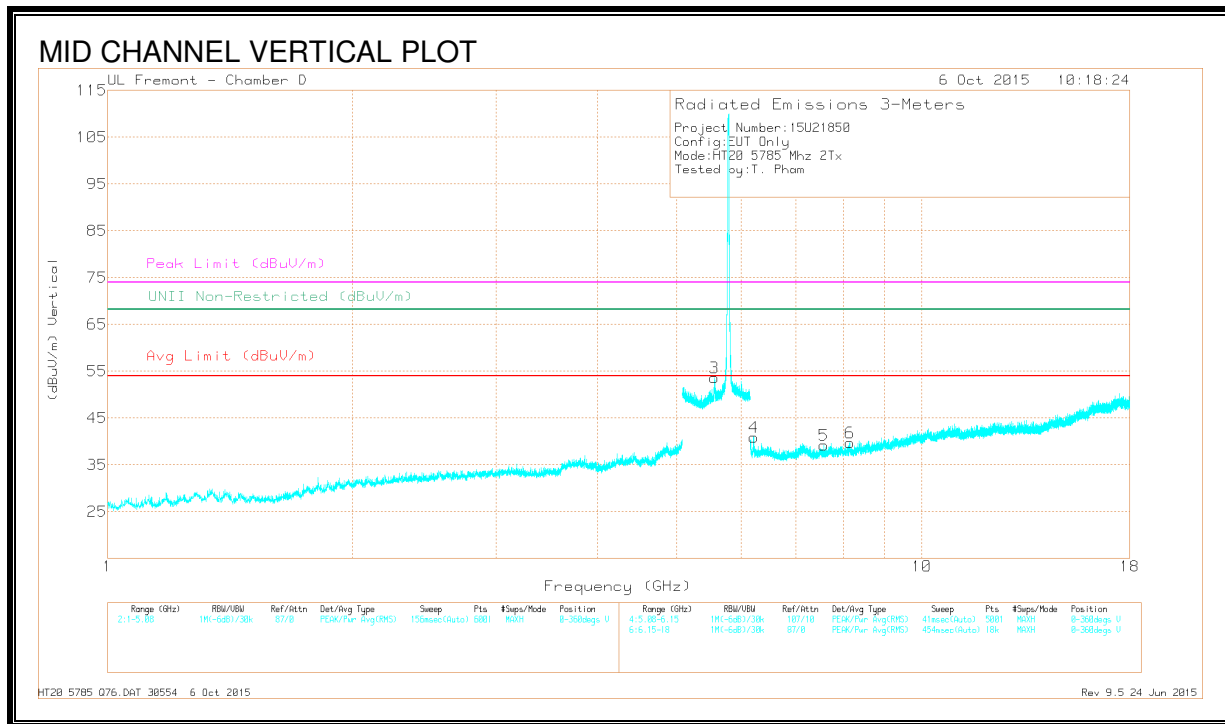
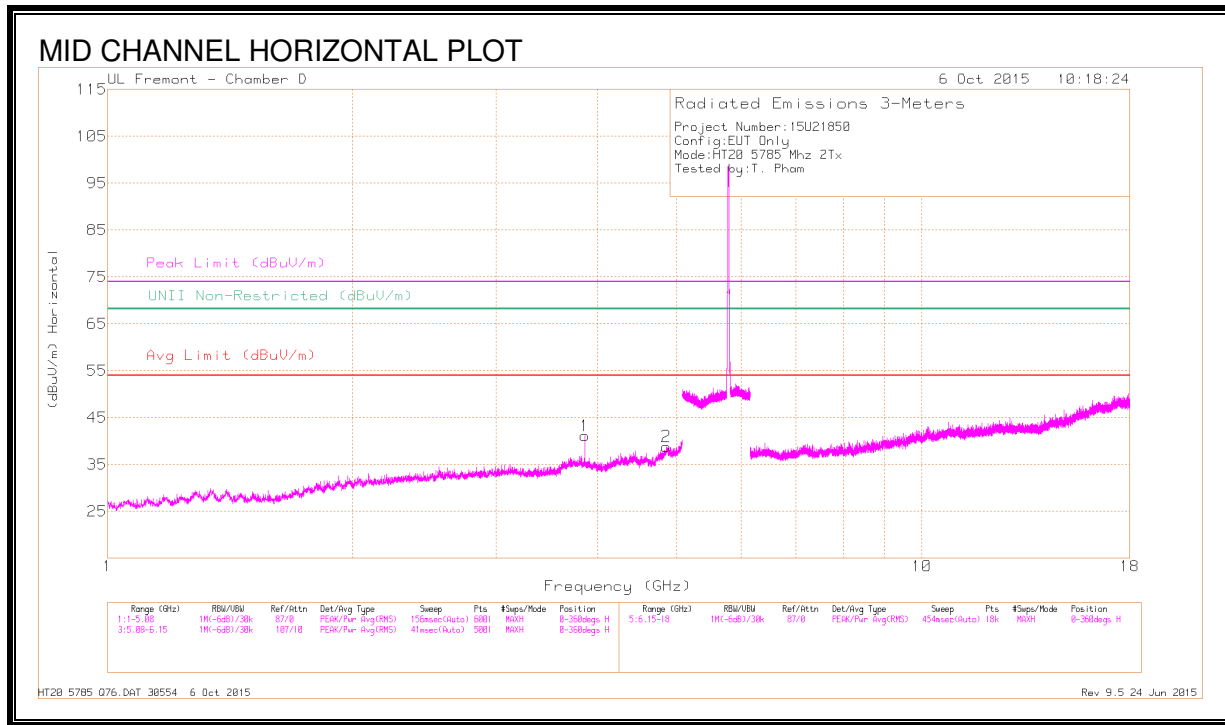

DATA

Frequency (GHz)	Meter Reading (dBuV)	Det	AF T344 (dB/m)	Amp/Cbl/FI tr/Pad (dB)	Corrected Reading (dBuV/m)	Avg Limit (dBuV/m)	Margin (dB)	Peak Limit (dBuV/m)	PK Margin (dB)	UNII Non-Restricted (dBuV/m)	PK Margin (dB)	Azimuth (Degs)	Height (cm)	Polarity
* 3.857	42.56	PK-U	33.4	-29	46.96	-	-	74	-27.04	-	-	7	134	H
* 3.857	35.06	ADR	33.4	-29	39.46	54	-14.54	-	-	-	-	7	134	H
* 4.854	26.4	ADR	34.1	-25.7	34.8	54	-19.2	-	-	-	-	21	158	H
* 4.855	37.94	PK-U	34.1	-25.7	46.34	-	-	74	-27.66	-	-	21	158	H
* 7.574	36.44	PK-U	35.6	-25.2	46.84	-	-	74	-27.16	-	-	120	210	V
* 7.574	24.71	ADR	35.6	-25.2	35.11	54	-18.89	-	-	-	-	120	210	V
* 8.158	36.2	PK-U	35.6	-24.1	47.7	-	-	74	-26.3	-	-	107	201	V
* 8.158	24.41	ADR	35.6	-24.1	35.91	54	-18.09	-	-	-	-	107	201	V
5.564	43.26	PK-U	34.4	-18	59.66	-	-	-	-	68.2	-8.54	45	138	V
6.214	38.06	PK-U	35.4	-26.7	46.76	-	-	-	-	68.2	-21.44	79	191	V

* - indicates frequency in CFR15.205/IC8.10 Restricted Band

PK-U - U-NII: Maximum Peak

ADR - U-NII AD primary method, RMS average

HIGH CHANNEL HARMONICS AND SPURIOUS EMISSIONS

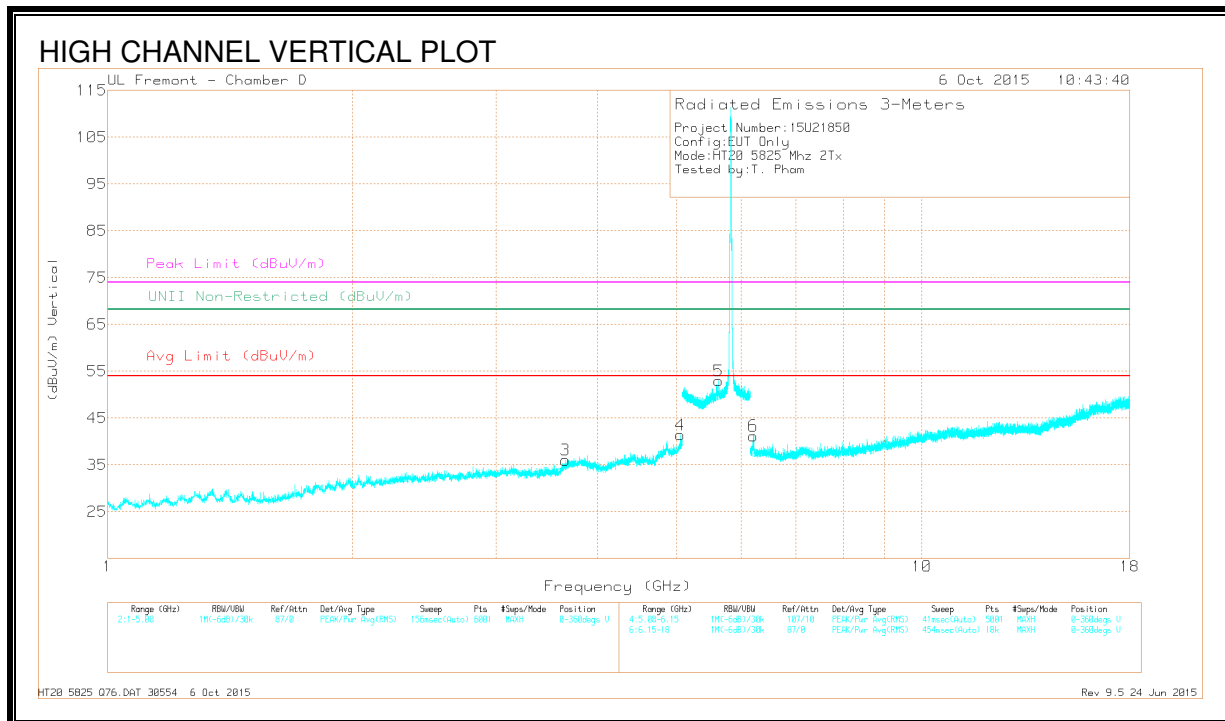
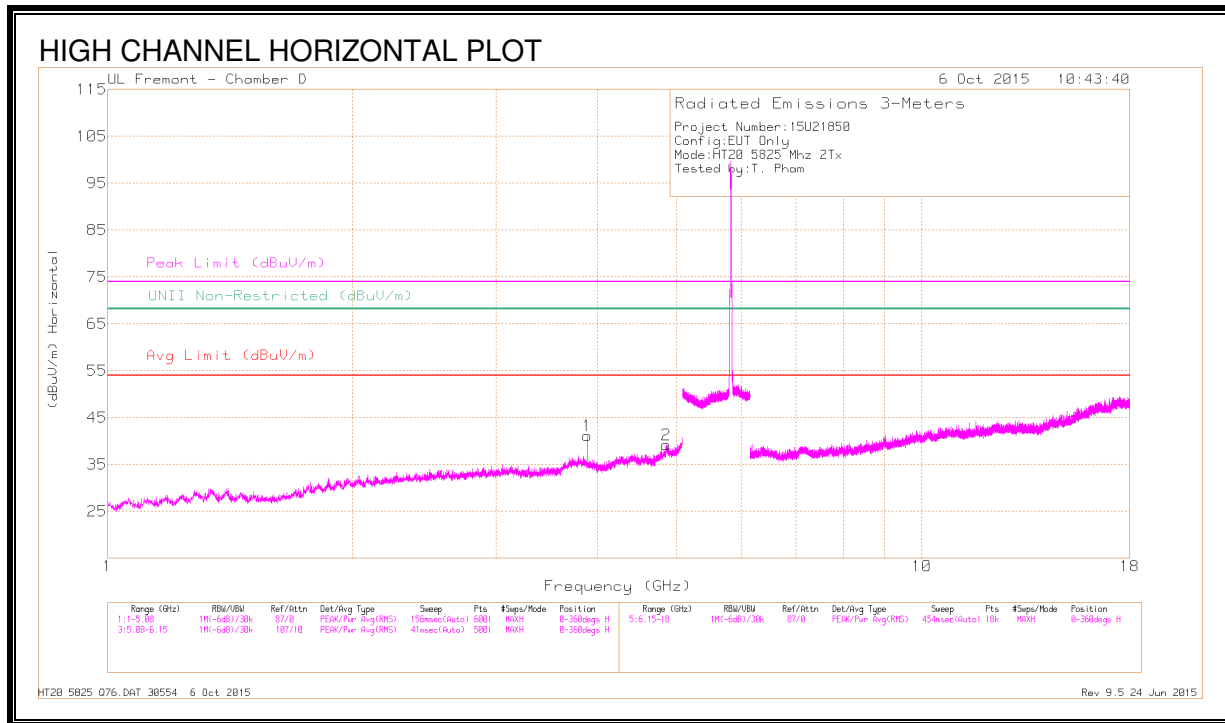

DATA

Frequency (GHz)	Meter Reading (dBuV)	Det	AF T344 (dB/m)	Amp/Cbl/FI tr/Pad (dB)	Corrected Reading (dBuV/m)	Avg Limit (dBuV/m)	Margin (dB)	Peak Limit (dBuV/m)	PK Margin (dB)	UNII Non-Restricted (dBuV/m)	PK Margin (dB)	Azimuth (Degs)	Height (cm)	Polarity
* 3.883	42.77	PK-U	33.4	-29.1	47.07	-	-	74	-26.93	-	-	345	102	H
* 3.883	35.58	ADR	33.4	-29.1	39.88	54	-14.12	-	-	-	-	345	102	H
* 4.853	38.48	PK-U	34.1	-25.7	46.88	-	-	74	-27.12	-	-	338	117	H
* 4.854	26.81	ADR	34.1	-25.7	35.21	54	-18.79	-	-	-	-	338	117	H
* 3.652	38.56	PK-U	33.1	-29.2	42.46	-	-	74	-31.54	-	-	312	109	V
* 3.651	27.09	ADR	33.1	-29.2	30.99	54	-23.01	-	-	-	-	312	109	V
* 5.048	40.91	PK-U	34.3	-25.7	49.51	-	-	74	-24.49	-	-	330	124	V
* 5.048	30.15	ADR	34.3	-25.7	38.75	54	-15.25	-	-	-	-	330	124	V
6.206	40.66	PK-U	35.4	-26.7	49.36	-	-	-	-	68.2	-18.84	342	150	V
6.207	29.63	ADR	35.4	-26.7	38.33	-	-	-	-	-	-	342	150	V

* - indicates frequency in CFR15.205/IC8.10 Restricted Band

PK-U - U-NII: Maximum Peak

ADR - U-NII AD primary method, RMS average

9.4. 802.11n HT40 1Tx MODE IN THE 5.8 GHz BAND

9.4.1. CHAIN 0, RESTRICTED BANDEDGE

LOW CHANNEL

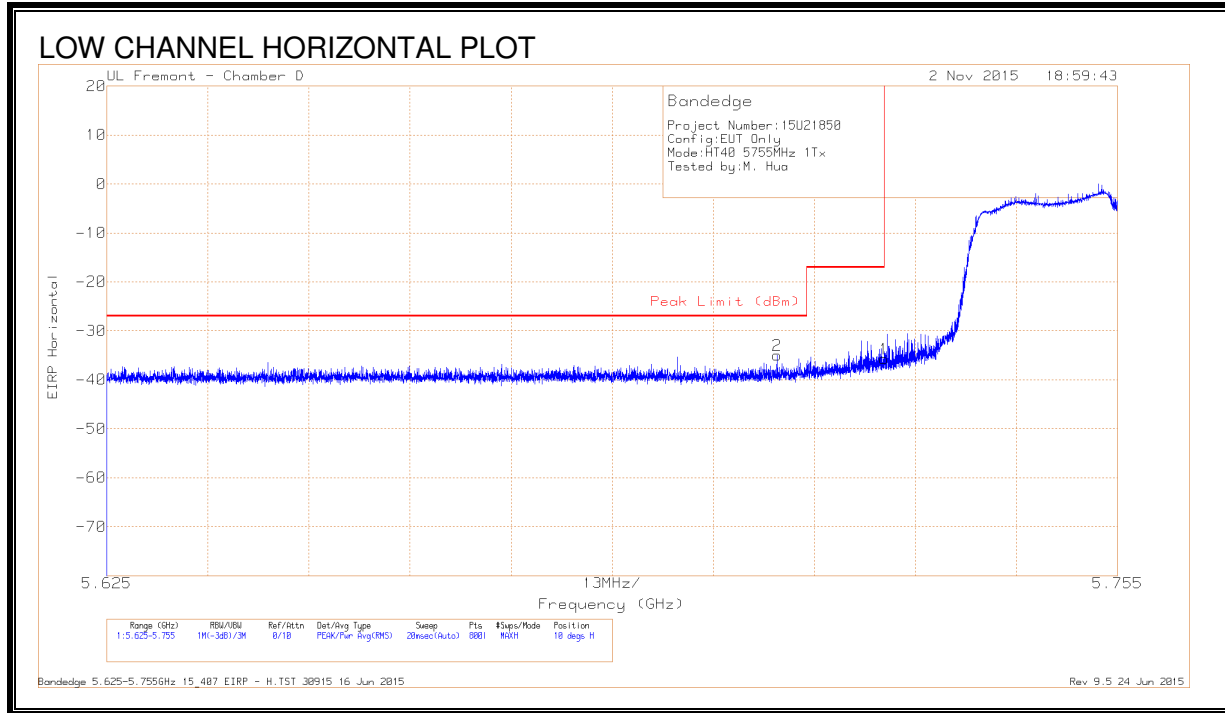

DATA

Marker	Frequency (GHz)	Meter Reading (dBm)	Det	AF T344 (dB/m)	Amp/Cbl/F Itr/Pad (dB)	Conversion Factor (dB)	Corrected Reading EIRP	Peak Limit (dBm)	PK Margin (dB)	Azimuth (Degs)	Height (cm)	Polarity
2	5.711	-63.75	Pk	34.5	-17.5	11.8	-34.95	-27	-7.95	10	360	H
1	5.725	-64.53	Pk	34.6	-17.6	11.8	-35.73	-17	-18.73	10	360	H

Pk - Peak detector

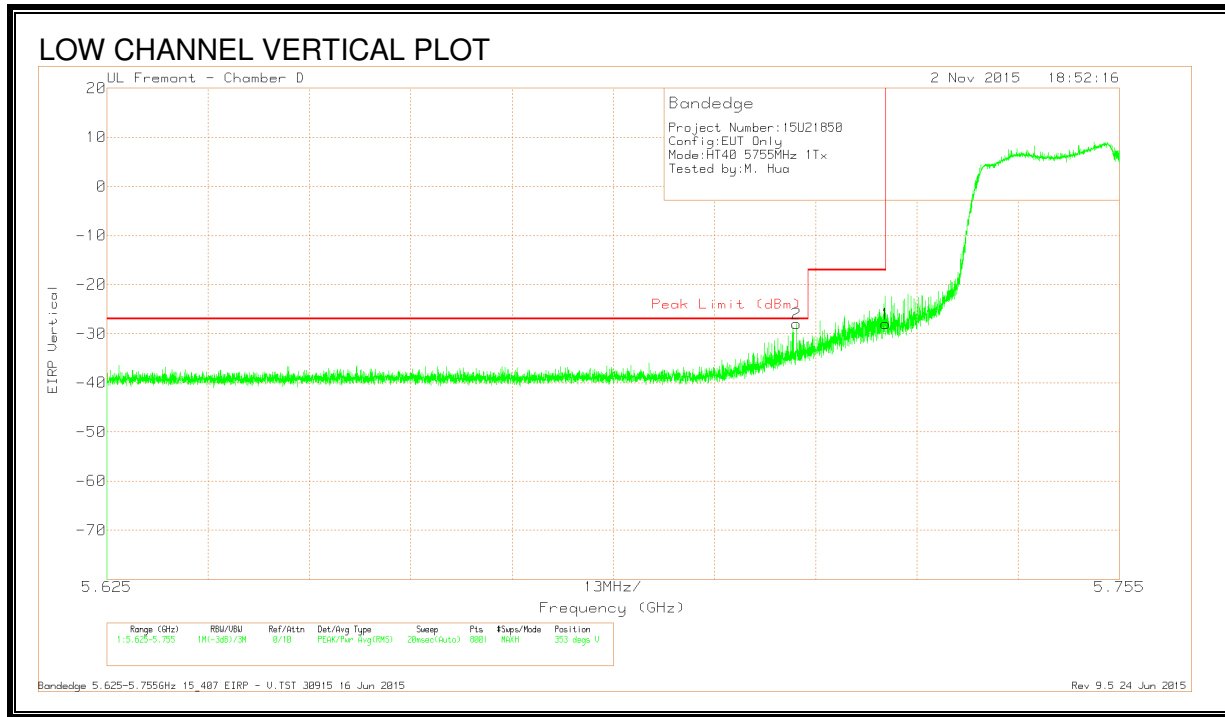

DATA

Marker	Frequency (GHz)	Meter Reading (dBm)	Det	AF T344 (dB/m)	Amp/Cbl/F ltr/Pad (dB)	Conversion Factor (dB)	Corrected Reading EIRP	Peak Limit (dBm)	PK Margin (dB)	Azimuth (Degs)	Height (cm)	Polarity
2	5.714	-56.83	Pk	34.6	-17.5	11.8	-27.93	-27	-.93	353	286	V
1	5.725	-56.73	Pk	34.6	-17.6	11.8	-27.93	-17	-10.93	353	286	V

Pk - Peak detector

RESTRICTED BANDEDGE, CHAIN 0 (HIGH CHANNEL)

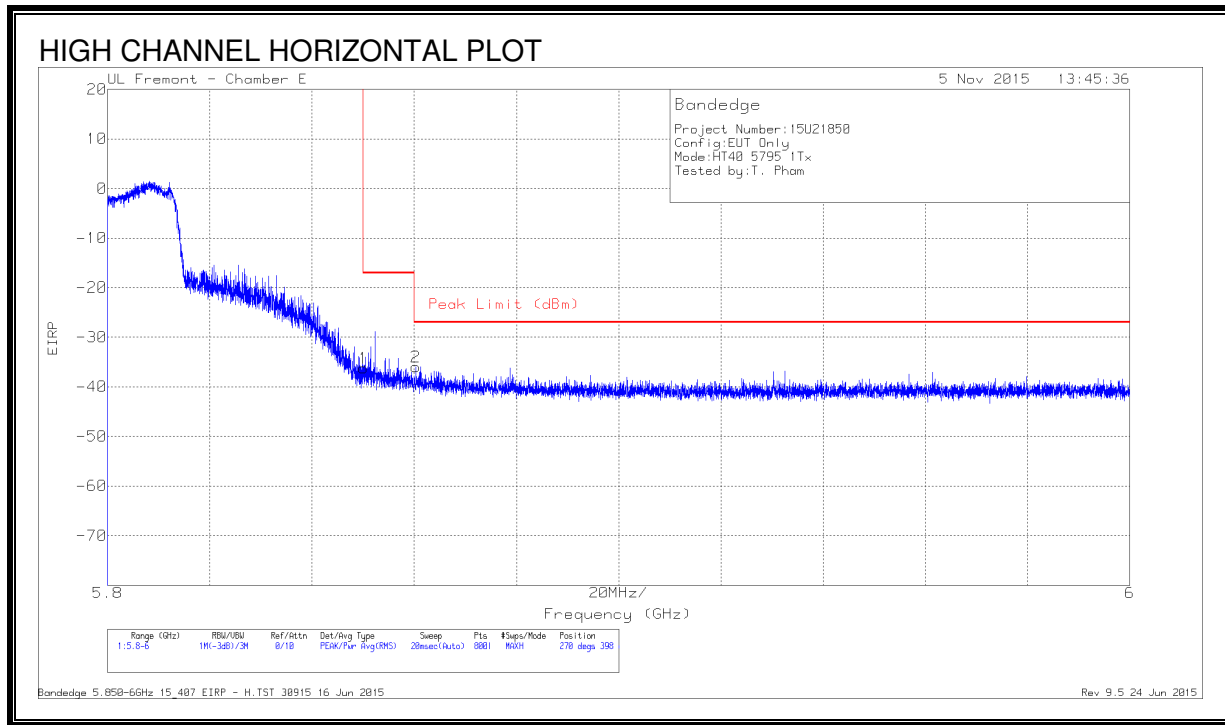

DATA

Marker	Frequency (GHz)	Meter Reading (dBm)	Det	AF T346 (dB/m)	Amp/Cbl/F Itr/Pad (dB)	Conversion Factor (dB)	Corrected Reading EIRP	Peak Limit (dBm)	PK Margin (dB)	Azimuth (Degs)	Height (cm)	Polarity
1	5.85	-62.6	Pk	34.9	-20.3	11.8	-36.2	-17	-19.2	270	398	H
2	5.86	-62.24	Pk	34.9	-20.4	11.8	-35.94	-27	-8.94	270	398	H

Pk - Peak detector

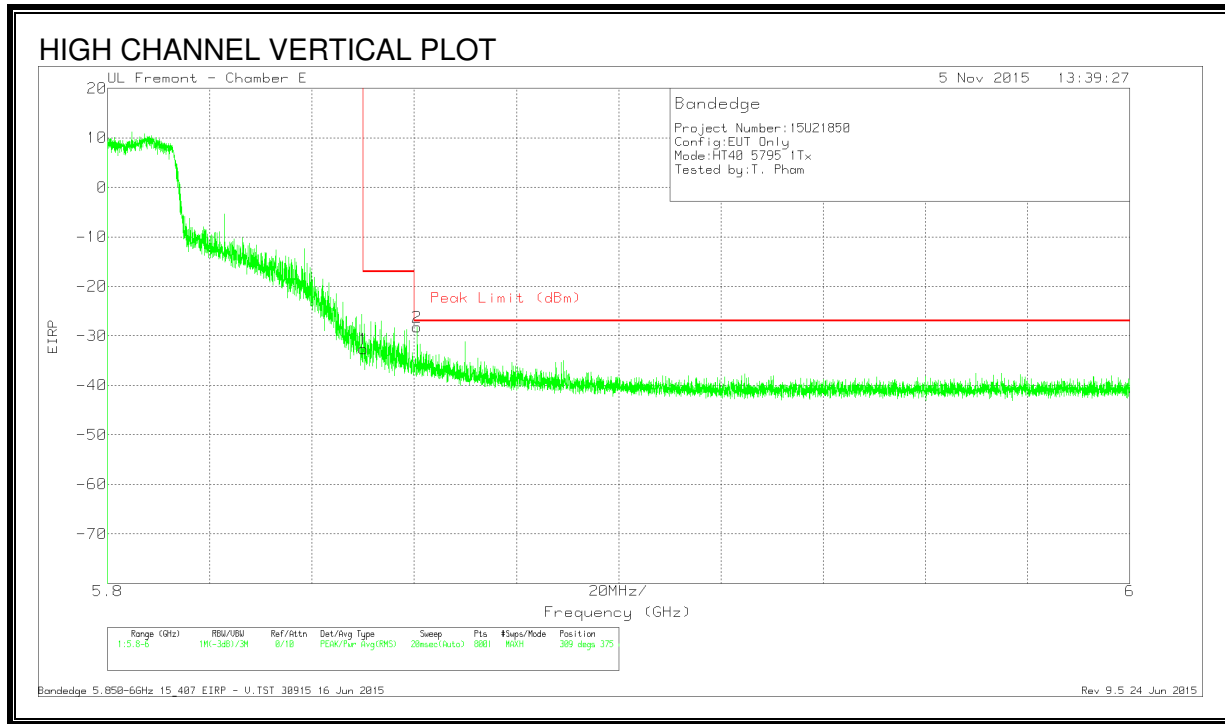

DATA

Marker	Frequency (GHz)	Meter Reading (dBm)	Det	AF T346 (dB/m)	Amp/Cbl/F ltr/Pad (dB)	Conversion Factor (dB)	Corrected Reading EIRP	Peak Limit (dBm)	PK Margin (dB)	Azimuth (Degs)	Height (cm)	Polarity
1	5.85	-59.1	Pk	34.9	-20.3	11.8	-32.7	-17	-15.7	309	375	V
2	5.861	-54.53	Pk	34.9	-20.4	11.8	-28.23	-27	-1.23	309	375	V

Pk - Peak detector

LOW CHANNEL HARMONICS AND SPURIOUS EMISSIONS

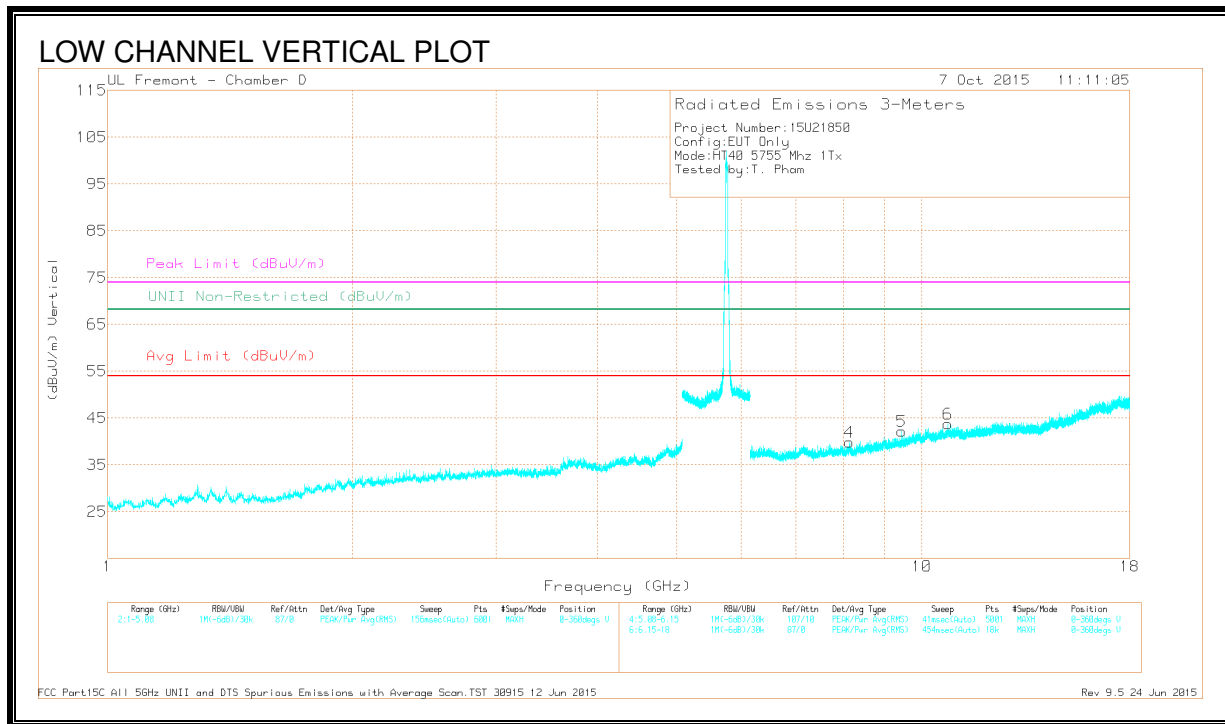
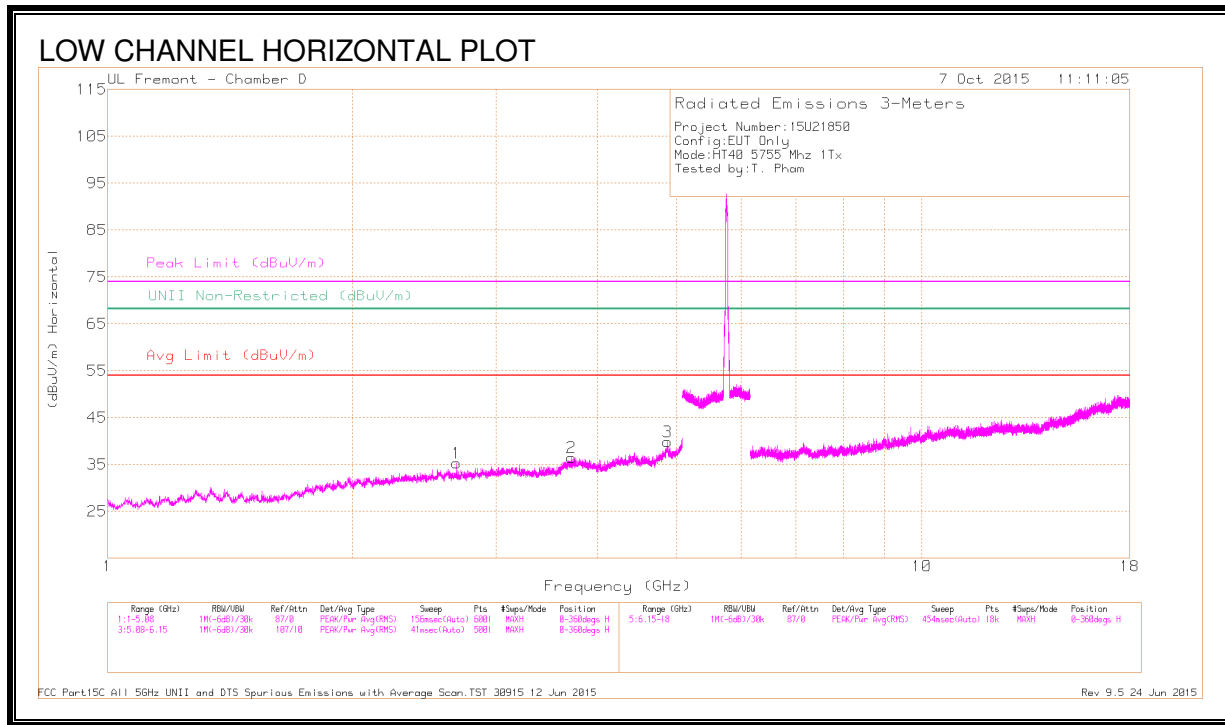

DATA

Frequency (GHz)	Meter Reading (dBuV)	Det	AF T344 (dB/m)	Amp/Cb/FI tr/Pad (dB)	DC Corr (dB)	Corrected Reading (dBuV/m)	Avg Limit (dBuV/m)	Margin (dB)	Peak Limit (dBuV/m)	PK Margin (dB)	UNII Non-Restricted (dBuV/m)	PK Margin (dB)	Azimuth (Degs)	Height (cm)	Polarity
* 2.684	40	PK-U	32.4	-30.6	0	41.8	-	-	74	-32.2	-	-	36	158	H
* 2.686	28.23	ADR	32.4	-30.6	.13	30.16	54	-23.84	-	-	-	-	36	158	H
* 3.713	38.76	PK-U	33.2	-29.3	0	42.66	-	-	74	-31.34	-	-	158	147	H
* 3.713	27.38	ADR	33.2	-29.3	.13	31.41	54	-22.59	-	-	-	-	158	147	H
* 4.868	37.15	PK-U	34.1	-25.2	0	46.05	-	-	74	-27.95	-	-	46	199	H
* 4.868	25.67	ADR	34.1	-25.2	.13	34.70	54	-19.30	-	-	-	-	46	199	H
* 8.147	35.9	PK-U	35.6	-23.8	0	47.7	-	-	74	-26.3	-	-	82	236	V
* 8.147	24.49	ADR	35.6	-23.8	.13	36.42	54	-17.58	-	-	-	-	82	236	V
* 9.442	34.43	PK-U	36.5	-21.9	0	49.03	-	-	74	-24.97	-	-	211	228	V
* 9.444	23.19	ADR	36.5	-21.8	.13	38.02	54	-15.98	-	-	-	-	211	228	V
* 10.764	34.62	PK-U	37.9	-20.9	0	51.62	-	-	74	-22.38	-	-	65	174	V
* 10.764	22.84	ADR	37.9	-20.9	.13	39.97	54	-14.03	-	-	-	-	65	174	V

* - indicates frequency in CFR15.205/IC8.10 Restricted Band

PK-U - U-NII: Maximum Peak

ADR - U-NII AD primary method, RMS average

HIGH CHANNEL HARMONICS AND SPURIOUS EMISSIONS

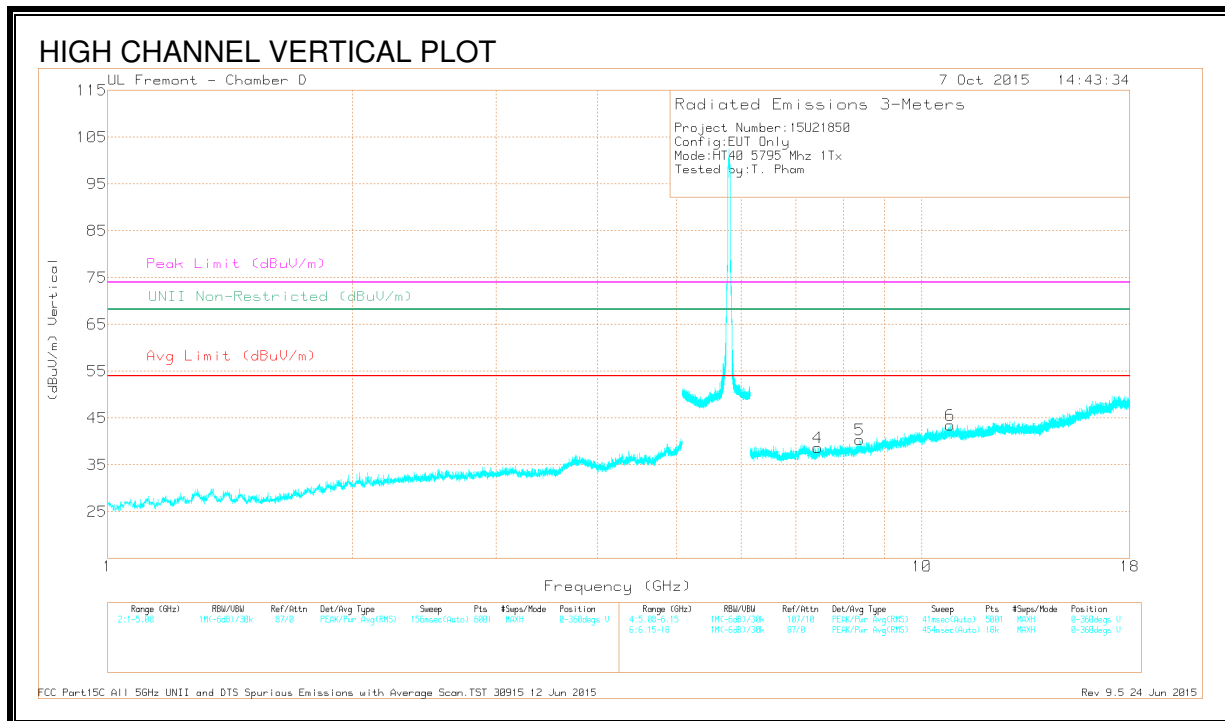
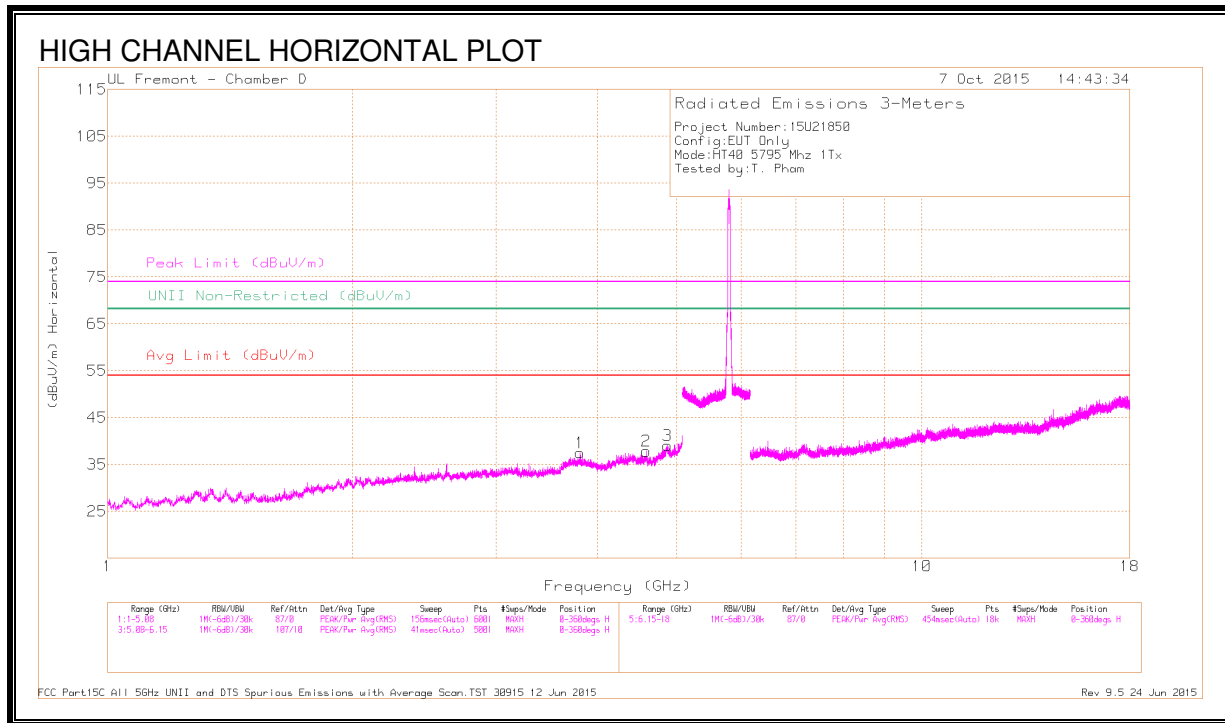

DATA

Frequency (GHz)	Meter Reading (dBuV)	Det	AF T344 (dB/m)	Amp/Cb/Fi tr/Pad (dB)	DC Corr (dB)	Corrected Reading (dBuV/m)	Avg Limit (dBuV/m)	Margin (dB)	Peak Limit (dBuV/m)	PK Margin (dB)	UNII Non-Restricted (dBuV/m)	PK Margin (dB)	Azimuth (Degs)	Height (cm)	Polarity
* 3.805	38.62	PK-U	33.4	-28.6	0	43.42	-	-	74	-30.58	-	-	26	125	H
* 3.804	27.45	ADR	33.4	-28.6	.13	32.38	54	-21.62	-	-	-	-	26	125	H
* 4.587	38.14	PK-U	34.1	-27.1	0	45.14	-	-	74	-28.86	-	-	65	144	H
* 4.588	26.62	ADR	34.1	-27.1	.13	33.75	54	-20.25	-	-	-	-	65	144	H
* 4.871	37.48	PK-U	34.1	-25.2	0	46.38	-	-	74	-27.62	-	-	158	269	H
* 4.871	25.31	ADR	34.1	-25.2	.13	34.34	54	-19.66	-	-	-	-	158	269	H
* 7.454	36.42	PK-U	35.5	-24.9	0	47.02	-	-	74	-26.98	-	-	78	228	V
* 7.454	24.56	ADR	35.5	-24.9	.13	35.29	54	-18.71	-	-	-	-	78	228	V
* 8.393	36.36	PK-U	35.7	-23.7	0	48.36	-	-	74	-25.64	-	-	225	148	V
* 8.394	24.42	ADR	35.7	-23.8	.13	36.45	54	-17.55	-	-	-	-	225	148	V
* 10.83	34.05	PK-U	38	-21.2	0	50.85	-	-	74	-23.15	-	-	36	159	V
* 10.83	22.66	ADR	38	-21.2	.13	39.59	54	-14.41	-	-	-	-	36	159	V

* - indicates frequency in CFR15.205/IC8.10 Restricted Band

PK-U - U-NII: Maximum Peak

ADR - U-NII AD primary method, RMS average

9.4.2. CHAIN 1, RESTRICTED BANDEDGE

LOW CHANNEL

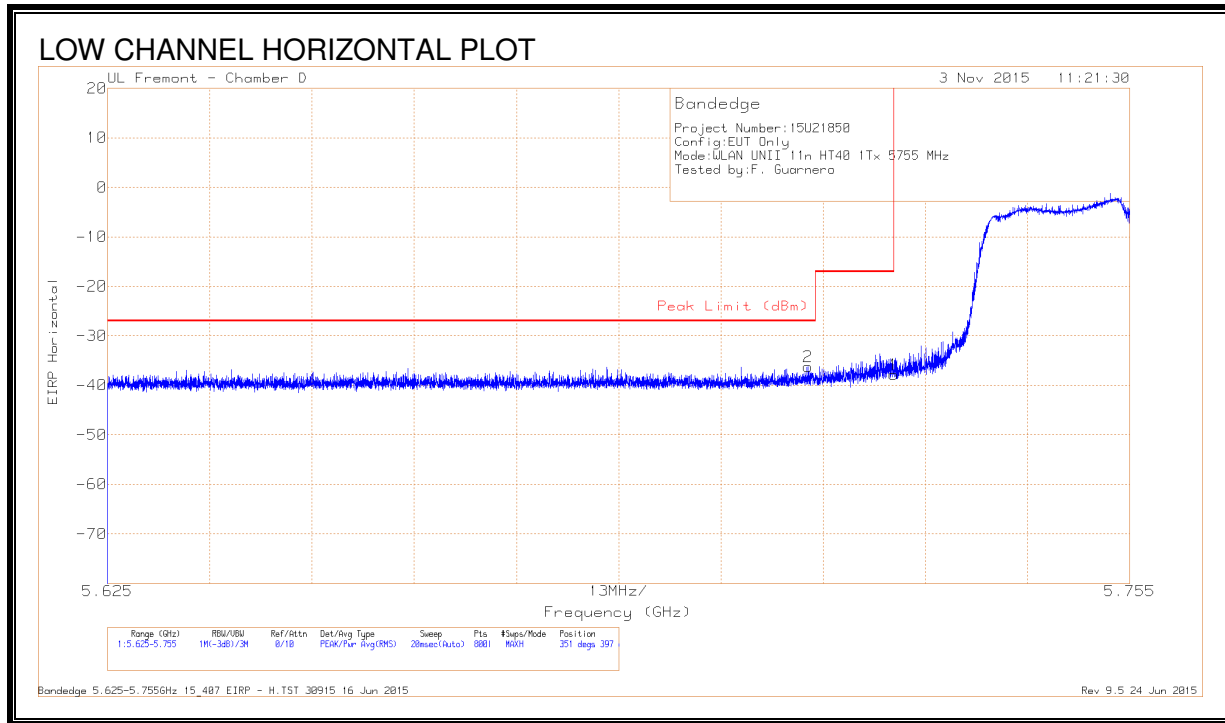

DATA

Marker	Frequency (GHz)	Meter Reading (dBm)	Det	AF T344 (dB/m)	Amp/Cbl/F ltr/Pad (dB)	Conversion Factor (dB)	Corrected Reading EIRP	Peak Limit (dBm)	PK Margin (dB)	Azimuth (Degs)	Height (cm)	Polarity
2	5.714	-65.14	Pk	34.6	-17.5	11.8	-36.24	-27	-9.24	351	397	H
1	5.725	-66.65	Pk	34.6	-17.6	11.8	-37.85	-17	-20.85	351	397	H

Pk - Peak detector

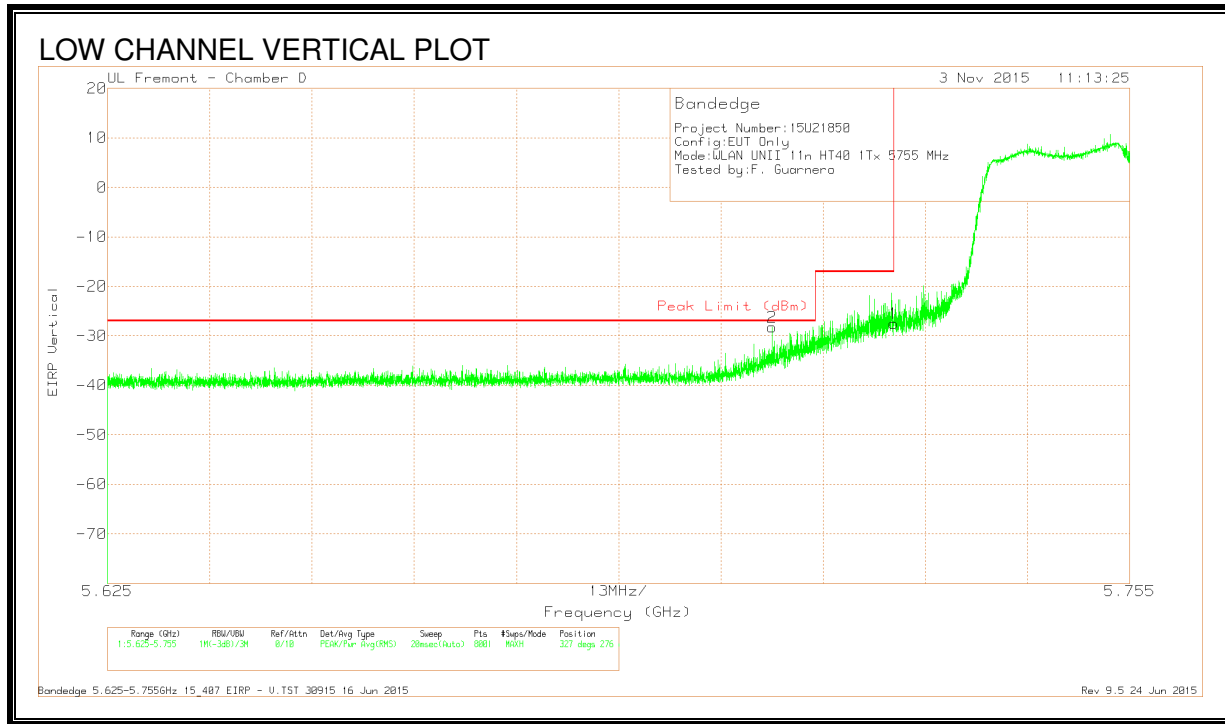

DATA

Marker	Frequency (GHz)	Meter Reading (dBm)	Det	AF T344 (dB/m)	Amp/Cbl/F ltr/Pad (dB)	Conversion Factor (dB)	Corrected Reading EIRP	Peak Limit (dBm)	PK Margin (dB)	Azimuth (Degs)	Height (cm)	Polarity
2	5.71	-57	Pk	34.5	-17.5	11.8	-28.2	-27	-1.2	327	276	V
1	5.725	-56.3	Pk	34.6	-17.6	11.8	-27.5	-17	-10.5	327	276	V

Pk - Peak detector

RESTRICTED BANDEDGE, CHAIN 1 (HIGH CHANNEL)

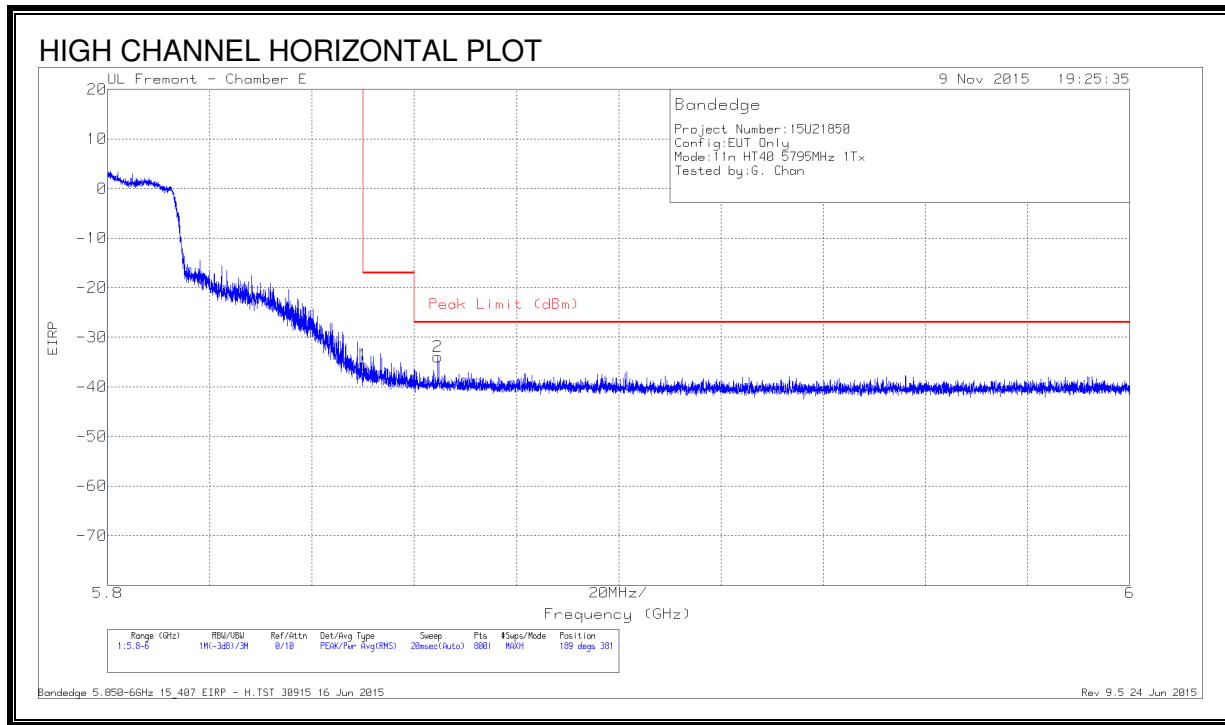

DATA

Marker	Frequency (GHz)	Meter Reading (dBm)	Det	AF T346 (dB/m)	Amp/Cbl/F Itr/Pad (dB)	Conversion Factor (dB)	Corrected Reading EIRP	Peak Limit (dBm)	PK Margin (dB)	Azimuth (Degs)	Height (cm)	Polarity
1	5.85	-61.89	Pk	34.9	-20.3	11.8	-35.49	-17	-18.49	189	381	H
2	5.865	-60.24	Pk	34.9	-20.4	11.8	-33.94	-27	-6.94	189	381	H

Pk - Peak detector

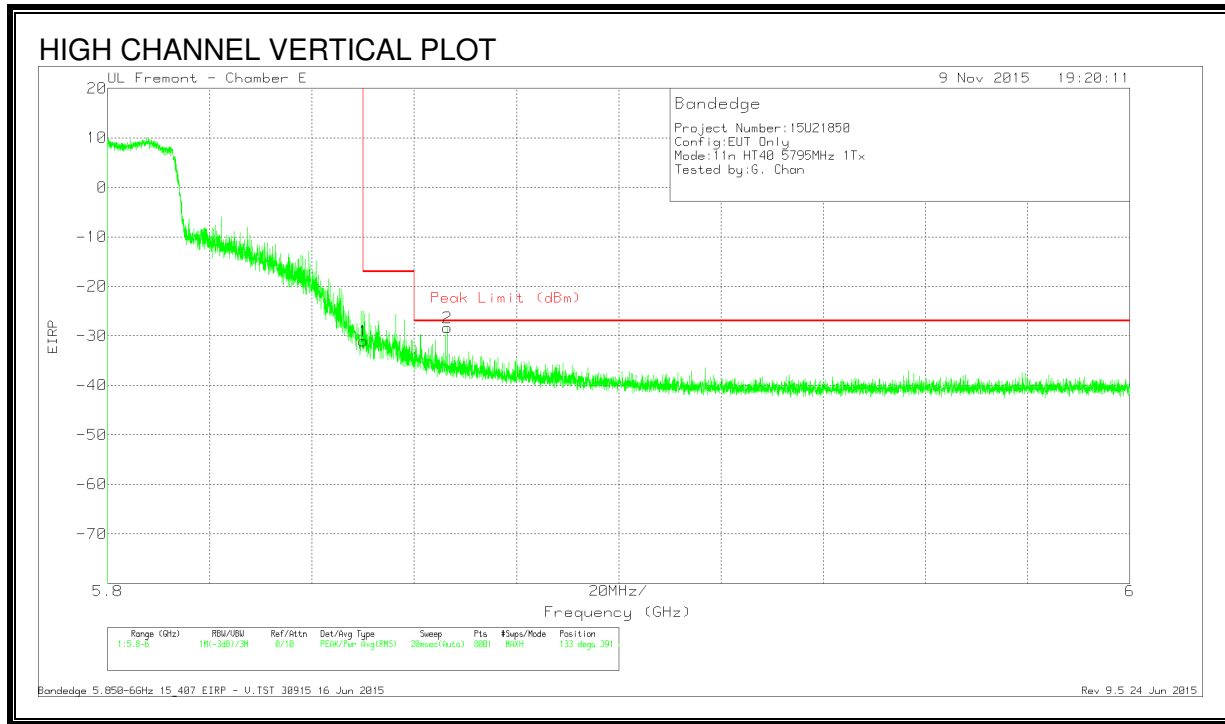

DATA

Marker	Frequency (GHz)	Meter Reading (dBm)	Det	AF T346 (dB/m)	Amp/Cbl/F ltr/Pad (dB)	Conversion Factor (dB)	Corrected Reading EIRP	Peak Limit (dBm)	PK Margin (dB)	Azimuth (Degs)	Height (cm)	Polarity
1	5.85	-57.43	Pk	34.9	-20.3	11.8	-31.03	-17	-14.03	133	391	V
2	5.867	-54.69	Pk	34.9	-20.4	11.8	-28.39	-27	-1.39	133	391	V

Pk - Peak detector

LOW CHANNEL HARMONICS AND SPURIOUS EMISSIONS

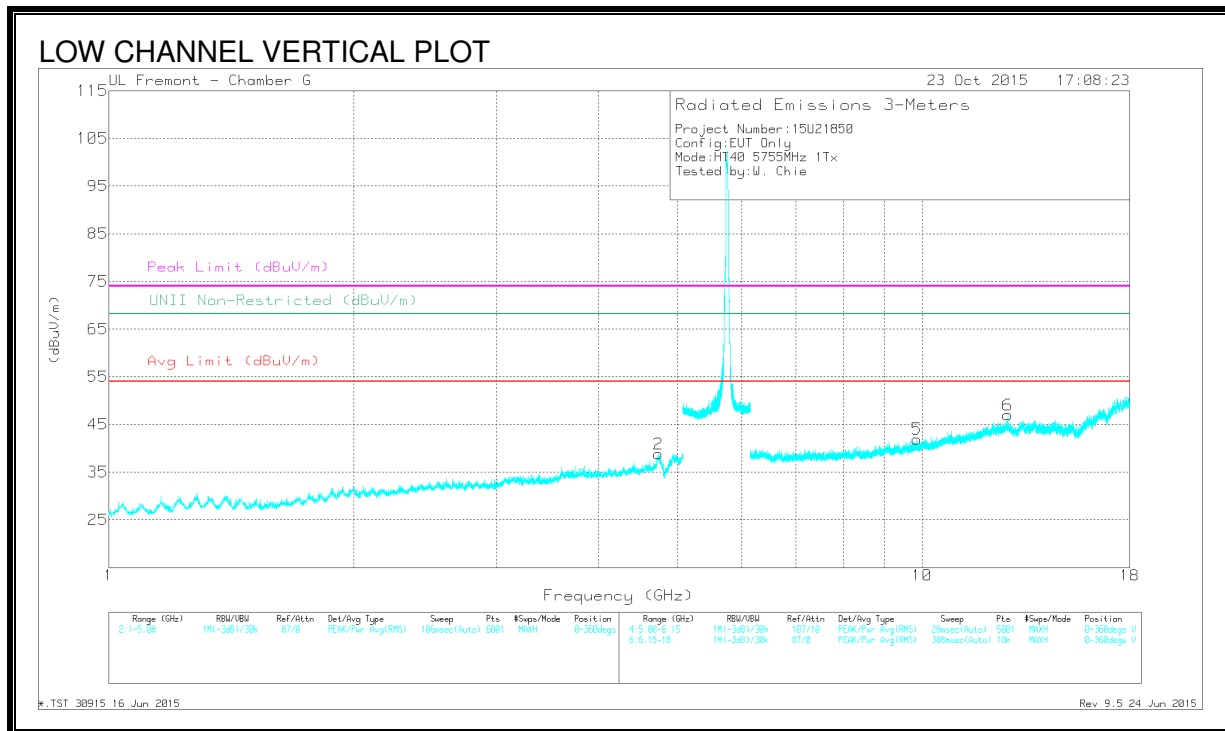
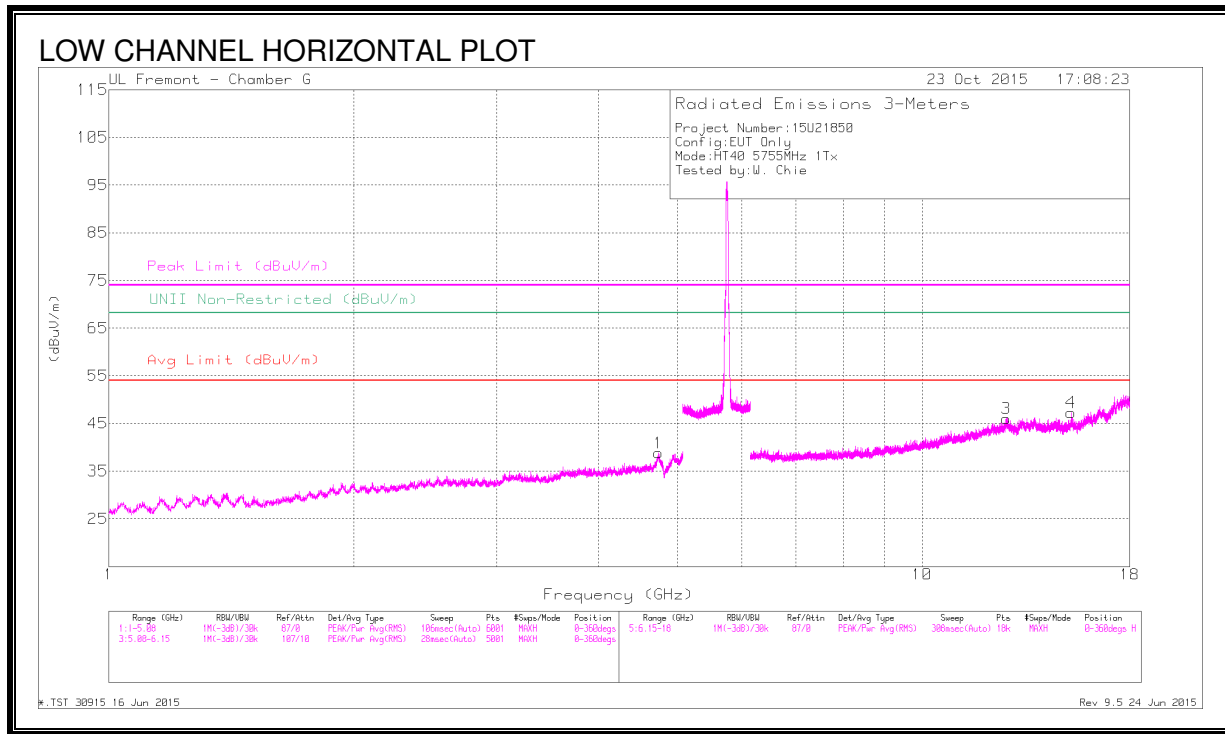

DATA

Marker	Frequency (GHz)	Meter Reading (dBuV)	Det	AF T862 (dB/m)	Amp/Cbl/FI tr/Pad (dB)	DC Corr (dB)	Corrected Reading (dBuV/m)	Avg Limit (dBuV/m)	Margin (dB)	Peak Limit (dBuV/m)	PK Margin (dB)	UNII Non-Restricted (dBuV/m)	PK Margin (dB)	Azimuth (Degs)	Height (cm)	Polarity
1	* 4.739	44.15	PK-U	33.9	-31.9	0	46.15	-	-	74	-27.85	-	-	160	132	H
	* 4.739	32.69	ADR	33.9	-31.9	.13	34.72	54	-19.28	-	-	-	-	160	132	H
2	* 4.739	45.54	PK-U	33.9	-31.9	0	47.54	-	-	74	-26.46	-	-	211	173	V
	* 4.74	33.45	ADR	33.9	-31.8	.13	35.68	54	-18.32	-	-	-	-	211	173	V
3	* 12.69	37.33	PK-U	39.3	-24.3	0	52.33	-	-	74	-21.67	-	-	237	136	H
	* 12.687	25.91	ADR	39.3	-24.3	.13	41.04	54	-12.96	-	-	-	-	237	136	H
5	9.852	39.02	PK-U	36.9	-27.9	0	48.02	-	-	-	-	68.2	-20.18	229	169	V
6	12.747	37.4	PK-U	39.2	-24.1	0	52.5	-	-	-	-	68.2	-15.7	169	234	V
4	15.243	38.91	PK-U	39.8	-25.7	0	53.01	-	-	-	-	68.2	-15.19	176	145	H

* - indicates frequency in CFR15.205/IC8.10 Restricted Band

PK-U - U-NII: Maximum Peak

ADR - U-NII AD primary method, RMS average

HIGH CHANNEL HARMONICS AND SPURIOUS EMISSIONS

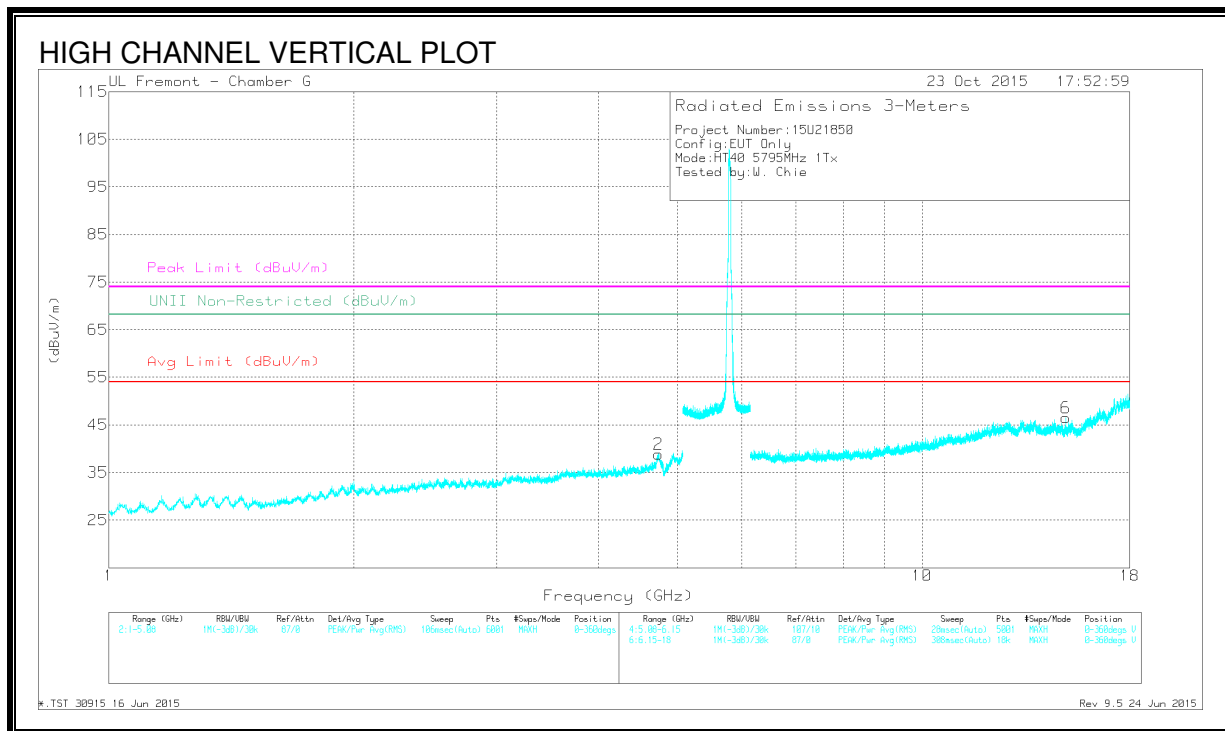
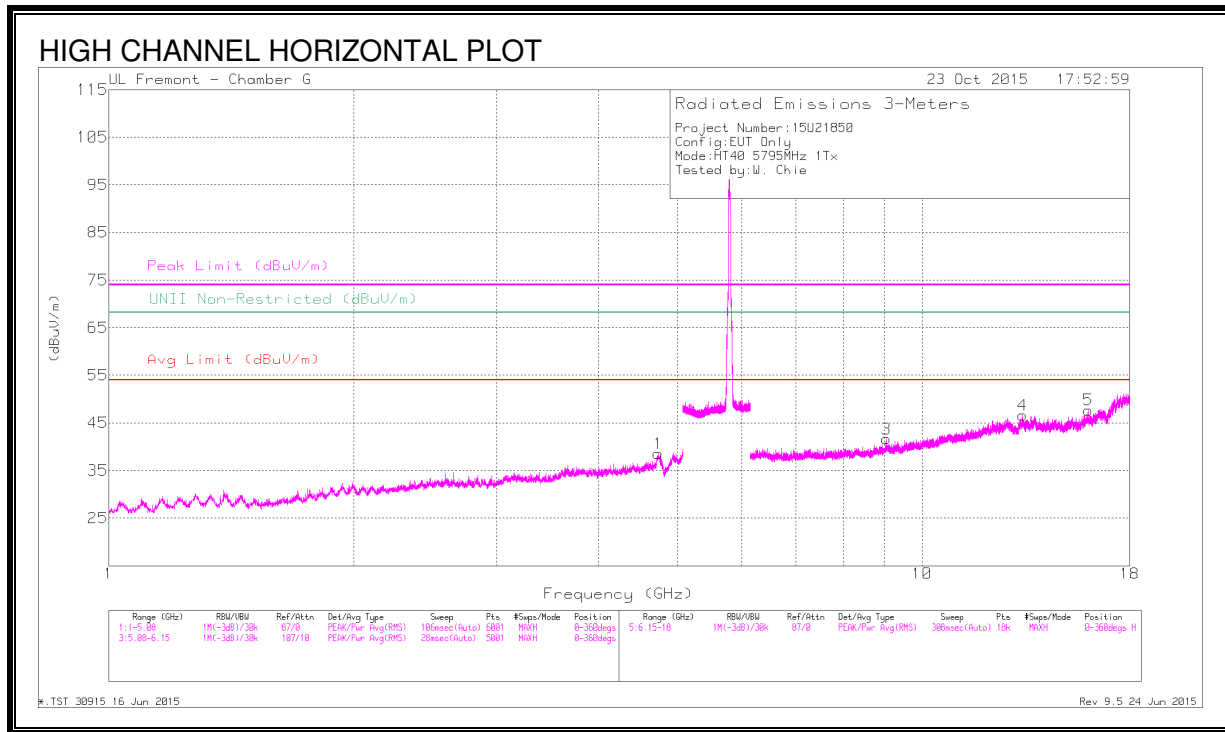

DATA

Marker	Frequency (GHz)	Meter Reading (dBuV)	Det	AF T862 (dB/m)	Amp/Cbl/FI tr/Pad (dB)	DC Corr (dB)	Corrected Reading (dBuV/m)	Avg Limit (dBuV/m)	Margin (dB)	Peak Limit (dBuV/m)	PK Margin (dB)	UNI Non-Restricted (dBuV/m)	PK Margin (dB)	Azimuth (Degs)	Height (cm)	Polarity
1	* 4.736	44.17	PK-U	33.9	-31.9	0	46.17	-	-	74	-27.83	-	-	192	137	H
	* 4.739	32.58	ADR	33.9	-31.9	.13	34.71	54	-19.29	-	-	-	-	192	137	H
2	* 4.741	45.47	PK-U	33.9	-31.9	0	47.47	-	-	74	-26.53	-	-	217	119	V
	* 4.741	33.36	ADR	33.9	-31.9	.13	35.49	54	-18.51	-	-	-	-	217	119	V
3	* 9.046	40.02	PK-U	36.2	-28.2	0	48.02	-	-	74	-25.98	-	-	147	233	H
	* 9.045	27.62	ADR	36.2	-28.2	.13	35.75	54	-18.25	-	-	-	-	147	233	H
4	* 13.291	37.76	PK-U	39.6	-24.6	0	52.76	-	-	74	-21.24	-	-	119	245	H
	* 13.291	26.4	ADR	39.6	-24.6	.13	41.53	54	-12.47	-	-	-	-	119	245	H
5	* 16.001	38.57	PK-U	40.4	-24.7	0	54.27	-	-	74	-19.73	-	-	172	112	H
	* 16	26.88	ADR	40.4	-24.8	.13	42.61	54	-11.39	-	-	-	-	172	112	H
6	15.014	37.92	PK-U	39.7	-26.2	0	51.42	-	-	-	-	68.2	-16.78	125	237	V

* - indicates frequency in CFR15.205/IC8.10 Restricted Band

PK-U - U-NII: Maximum Peak

ADR - U-NII AD primary method, RMS average

9.5. 802.11n HT40 2Tx CDD MODE IN THE 5.8 GHz BAND

RESTRICTED BANDEDGE (LOW CHANNEL)

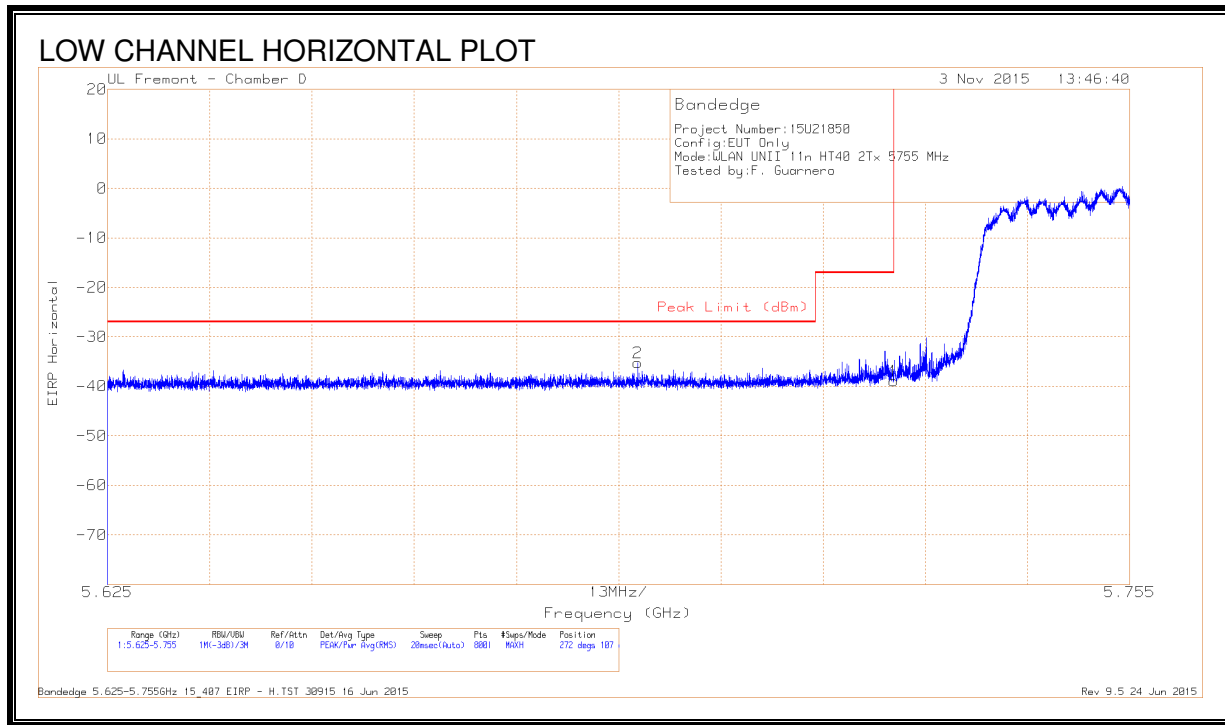

DATA

Marker	Frequency (GHz)	Meter Reading (dBm)	Det	AFT344 (dB/m)	Amp/Cbl/F ltr/Pad (dB)	Conversion Factor (dB)	Corrected Reading EIRP	Peak Limit (dBm)	PK Margin (dB)	Azimuth (Degs)	Height (cm)	Polarity
2	5.692	-64.19	Pk	34.5	-17.3	11.8	-35.19	-27	-8.19	272	107	H
1	5.725	-67.74	Pk	34.6	-17.6	11.8	-38.94	-17	-21.94	272	107	H

Pk - Peak detector

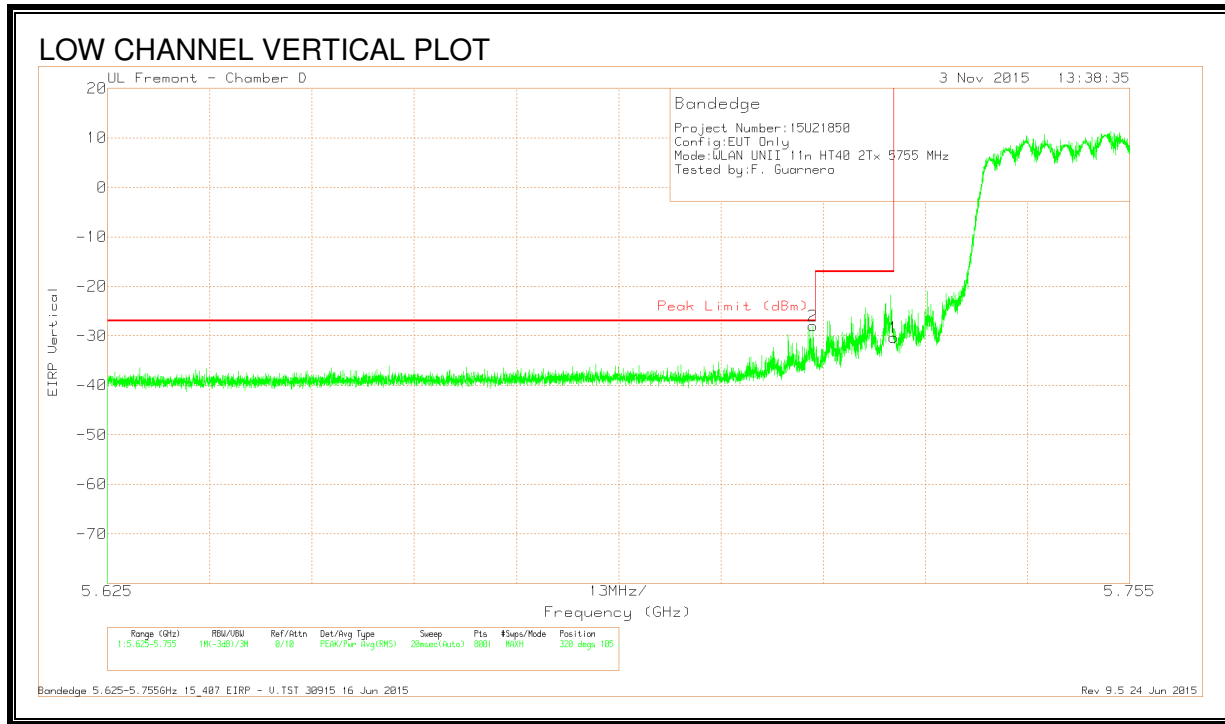

DATA

Marker	Frequency (GHz)	Meter Reading (dBm)	Det	AF T344 (dB/m)	Amp/Cbl/F ltr/Pad (dB)	Conversion Factor (dB)	Corrected Reading EIRP	Peak Limit (dBm)	PK Margin (dB)	Azimuth (Degs)	Height (cm)	Polarity
2	5.715	-56.87	Pk	34.6	-17.5	11.8	-27.97	-27	-.97	320	105	V
1	5.725	-59.15	Pk	34.6	-17.6	11.8	-30.35	-17	-13.35	320	105	V

Pk - Peak detector

RESTRICTED BANDEDGE (HIGH CHANNEL)

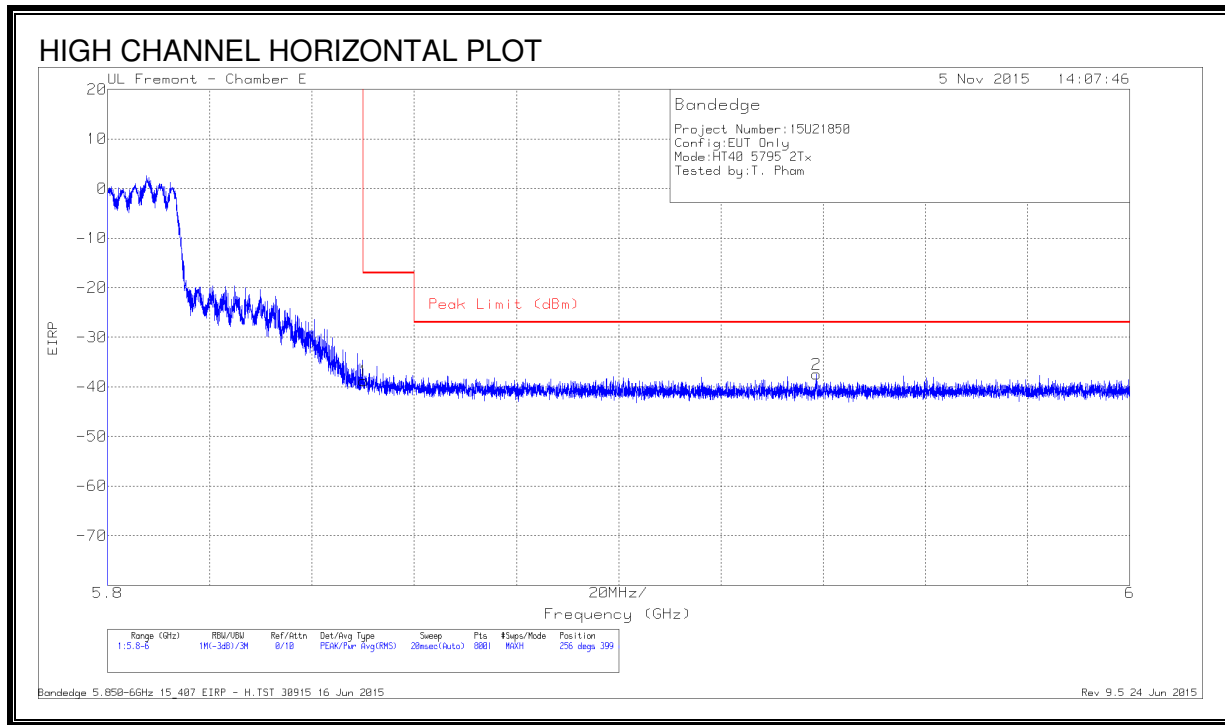

DATA

Marker	Frequency (GHz)	Meter Reading (dBm)	Det	AF T346 (dB/m)	Amp/Cbl/F Itr/Pad (dB)	Conversion Factor (dB)	Corrected Reading EIRP	Peak Limit (dBm)	PK Margin (dB)	Azimuth (Degs)	Height (cm)	Polarity
1	5.85	-65.14	Pk	34.9	-20.3	11.8	-38.74	-17	-21.74	256	399	H
2	5.939	-63.97	Pk	35	-20.3	11.8	-37.47	-27	-10.47	256	399	H

Pk - Peak detector

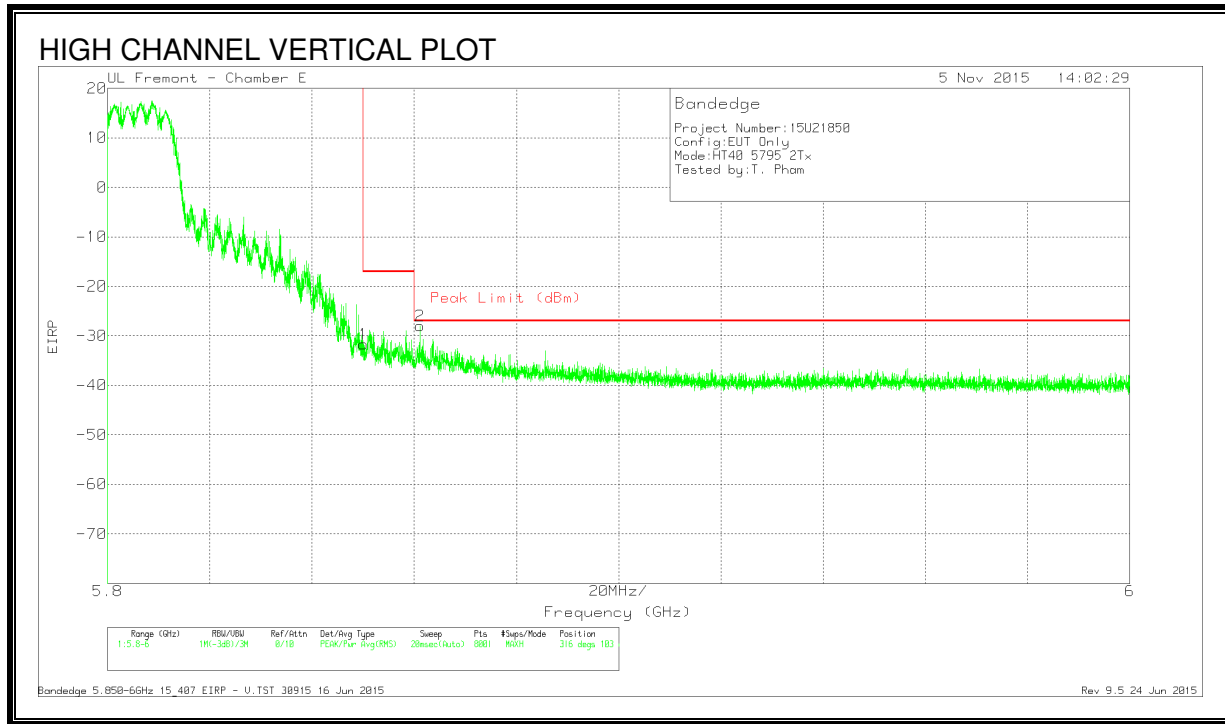

DATA

Marker	Frequency (GHz)	Meter Reading (dBm)	Det	AF T346 (dB/m)	Amp/Cbl/F ltr/Pad (dB)	Conversion Factor (dB)	Corrected Reading EIRP	Peak Limit (dBm)	PK Margin (dB)	Azimuth (Degs)	Height (cm)	Polarity
1	5.85	-58.04	Pk	34.9	-20.3	11.8	-31.64	-17	-14.64	316	103	V
2	5.861	-54.25	Pk	34.9	-20.4	11.8	-27.95	-27	-9.5	316	103	V

Pk - Peak detector

LOW CHANNEL HARMONICS AND SPURIOUS EMISSIONS

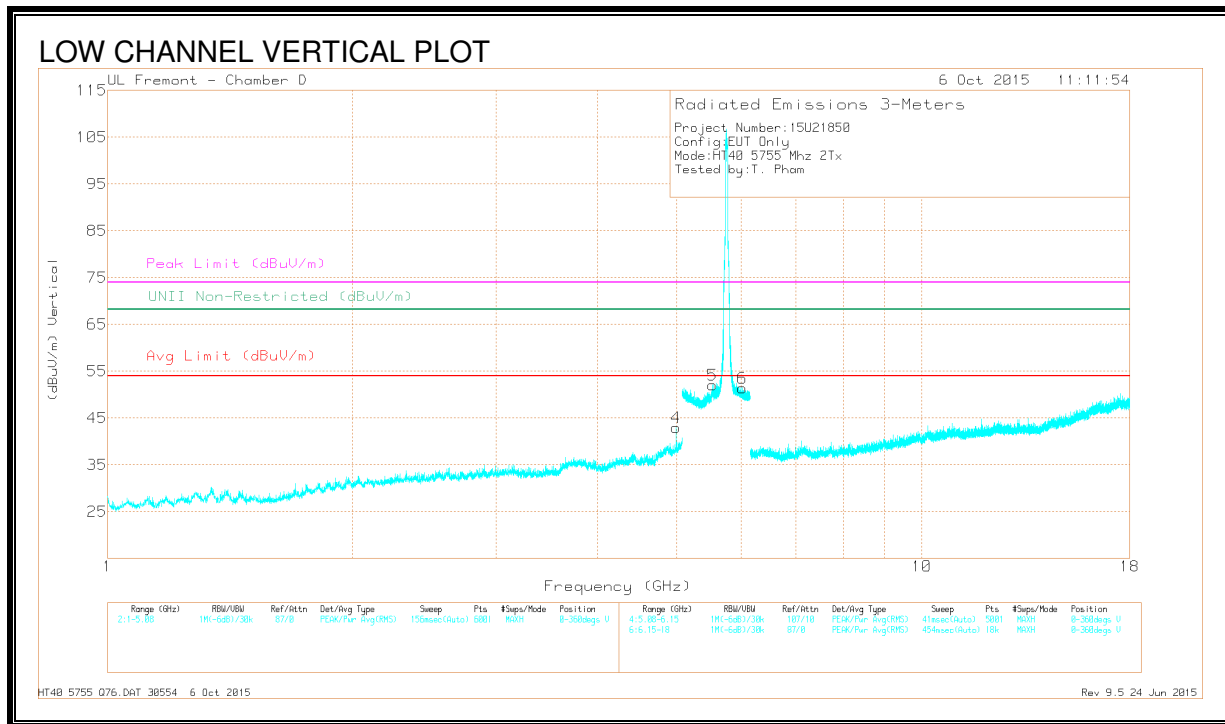
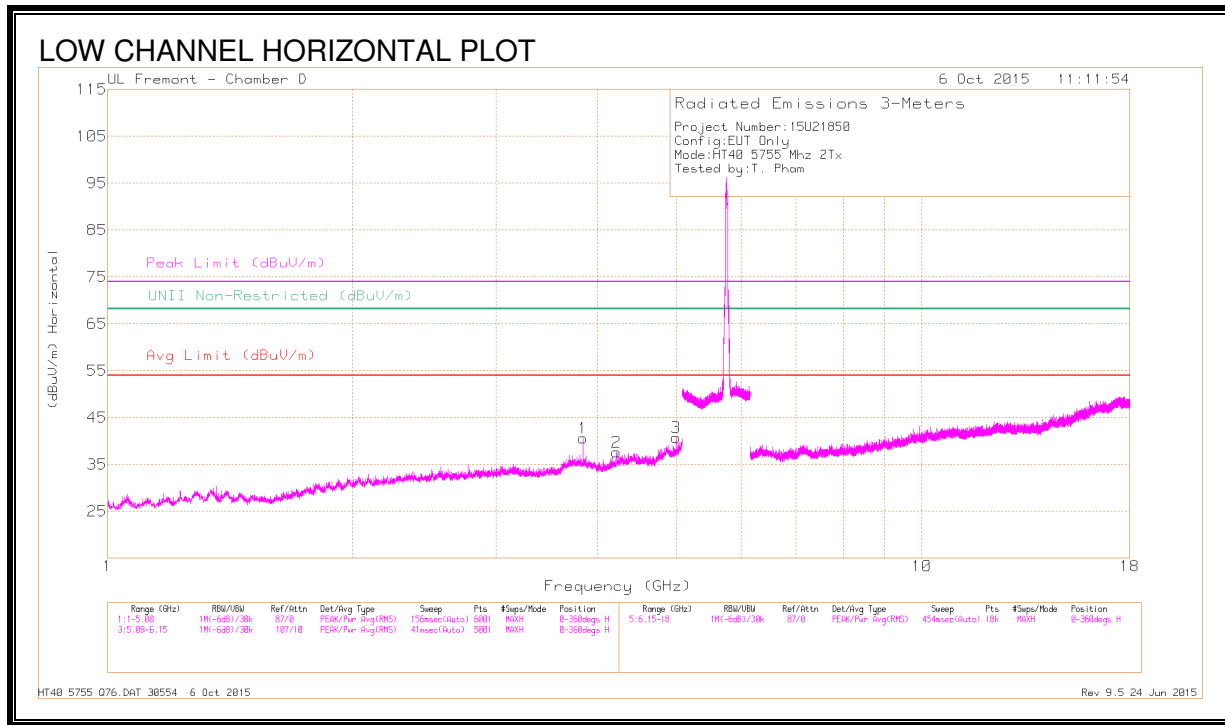

DATA

Frequency (GHz)	Meter Reading (dBuV)	Det	AF T344 (dB/m)	Amp/Cbl/FI tr/Pad (dB)	DC Corr (dB)	Corrected Reading (dBuV/m)	Avg Limit (dBuV/m)	Margin (dB)	Peak Limit (dBuV/m)	PK Margin (dB)	UNII Non-Restricted (dBuV/m)	PK Margin (dB)	Azimuth (Degs)	Height (cm)	Polarity
* 3.837	41.88	PK-U	33.4	-28.8	0	46.48	-	-	74	-27.52	-	-	349	124	H
* 3.837	33.73	ADR	33.4	-28.8	.12	38.45	54	-15.55	-	-	-	-	349	124	H
* 4.219	38.97	PK-U	33.5	-27.8	0	44.67	-	-	74	-29.33	-	-	305	114	H
* 4.218	26.41	ADR	33.5	-27.9	.12	32.13	54	-21.87	-	-	-	-	305	114	H
* 4.988	39.82	PK-U	34.2	-26.9	0	47.12	-	-	74	-26.88	-	-	321	129	H
* 4.988	28.95	ADR	34.2	-26.9	.12	36.37	54	-17.63	-	-	-	-	321	129	H
* 4.987	43.07	PK-U	34.2	-26.9	0	50.37	-	-	74	-23.63	-	-	319	135	V
* 4.988	33.56	ADR	34.2	-26.9	.12	40.98	54	-13.02	-	-	-	-	319	135	V
5.533	42.63	PK-U	34.4	-18	0	59.03	-	-	-	-	68.2	-9.17	289	153	V
5.534	30.93	ADR	34.4	-18	.12	47.45	-	-	-	-	-	-	289	153	V
6.017	30.04	ADR	35.5	-17.8	.12	47.86	-	-	-	-	-	-	295	171	V
6.018	42.15	PK-U	35.5	-17.8	0	59.85	-	-	-	-	68.2	-8.35	295	171	V

* - indicates frequency in CFR15.205/IC8.10 Restricted Band

PK-U - U-NII: Maximum Peak

ADR - U-NII AD primary method, RMS average

HIGH CHANNEL HARMONICS AND SPURIOUS EMISSIONS

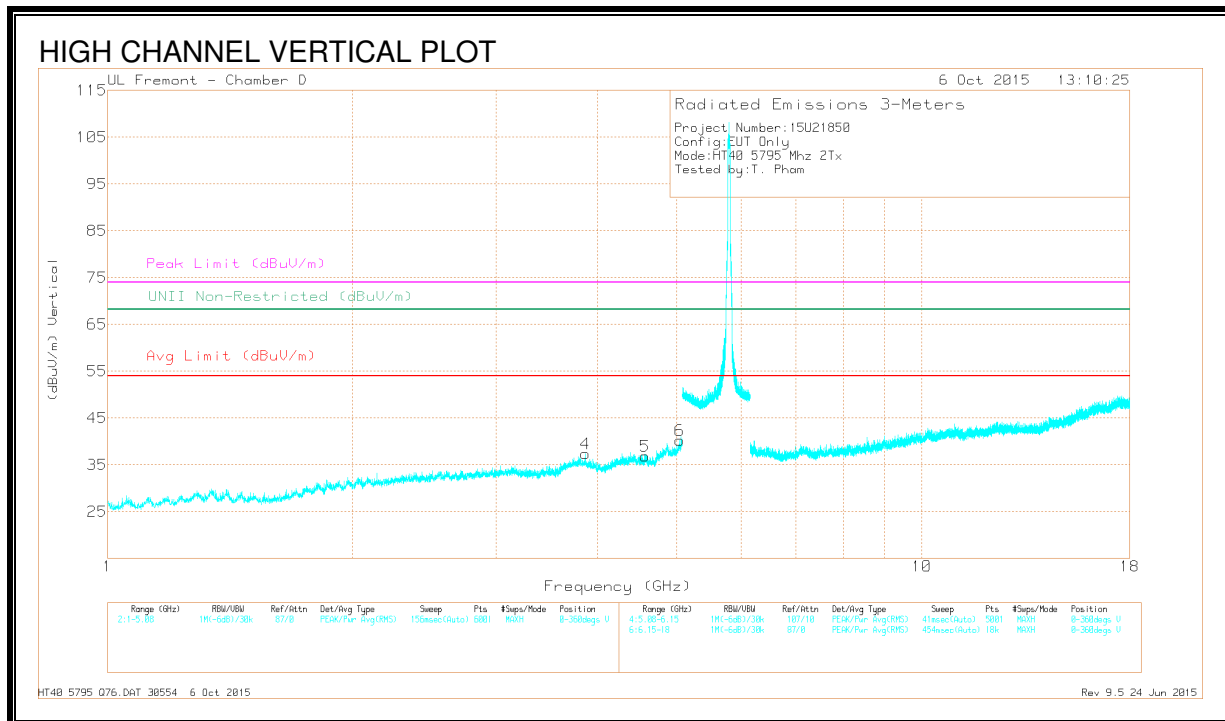
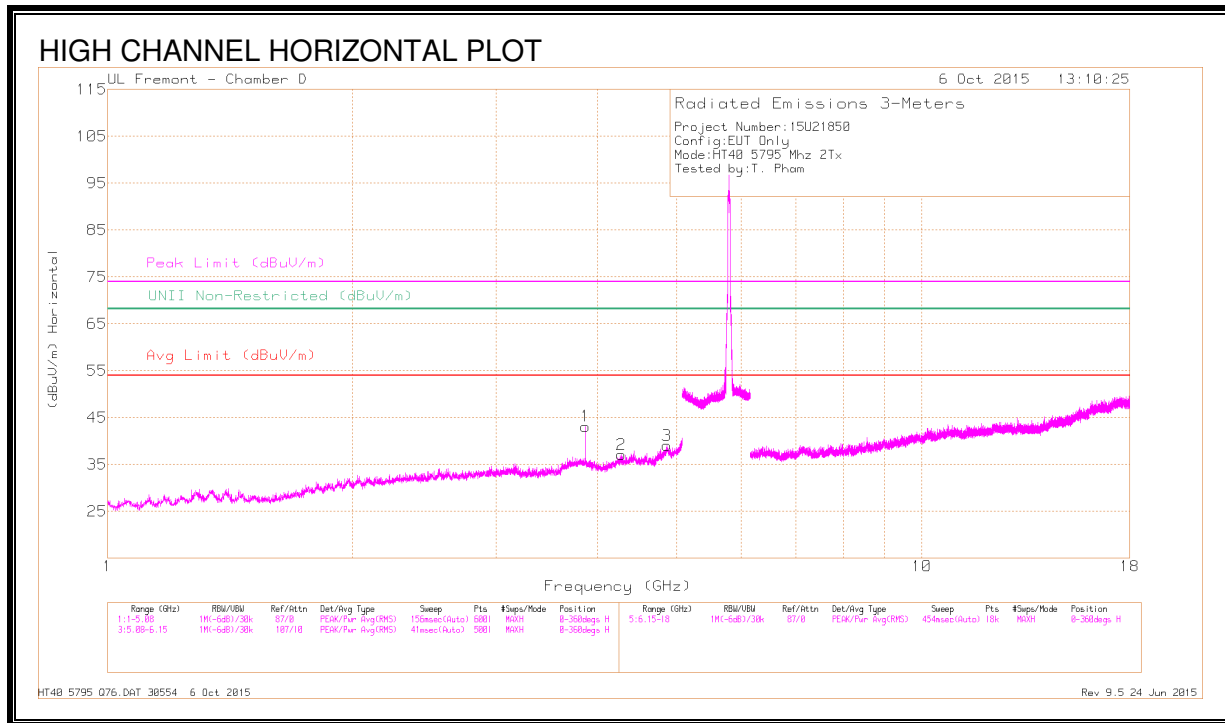

DATA

Frequency (GHz)	Meter Reading (dBuV)	Det	AF T344 (dB/m)	Amp/Cbl/FI tr/Pad (dB)	DC Corr (dB)	Corrected Reading (dBuV/m)	Avg Limit (dBuV/m)	Margin (dB)	Peak Limit (dBuV/m)	PK Margin (dB)	UNII Non-Restricted (dBuV/m)	PK Margin (dB)	Azimuth (Degs)	Height (cm)	Polarity
* 3.863	43.22	PK-U	33.4	-29	0	47.62	-	-	74	-26.38	-	-	345	105	H
* 3.863	35.84	ADR	33.4	-29	.12	40.36	54	-13.64	-	-	-	-	345	105	H
* 4.271	38.81	PK-U	33.5	-27.8	0	44.51	-	-	74	-29.49	-	-	0	131	H
* 4.272	26.51	ADR	33.5	-27.9	.12	32.23	54	-21.77	-	-	-	-	0	131	H
* 4.862	37.71	PK-U	34.1	-25.4	0	46.41	-	-	74	-27.59	-	-	34	143	H
* 4.861	25.83	ADR	34.1	-25.4	.12	34.65	54	-19.35	-	-	-	-	34	143	H
* 3.864	40.52	PK-U	33.4	-29	0	44.92	-	-	74	-29.08	-	-	86	158	V
* 3.863	29.28	ADR	33.4	-29	.12	33.80	54	-20.20	-	-	-	-	86	158	V
* 4.575	38.52	PK-U	34.1	-27.3	0	45.32	-	-	74	-28.68	-	-	119	194	V
* 4.575	26.92	ADR	34.1	-27.3	.12	33.84	54	-20.16	-	-	-	-	119	194	V
* 5.043	38.49	PK-U	34.3	-25.6	0	47.19	-	-	74	-26.81	-	-	109	173	V
* 5.043	26.46	ADR	34.3	-25.6	.12	35.28	54	-18.72	-	-	-	-	109	173	V

* - indicates frequency in CFR15.205/IC8.10 Restricted Band

PK-U - U-NII: Maximum Peak

ADR - U-NII AD primary method, RMS average

9.6. WORST-CASE BELOW 1 GHz

SPURIOUS EMISSIONS 30 TO 1000 MHz (WORST-CASE CONFIGURATION, HORIZONTAL & VERTICAL)

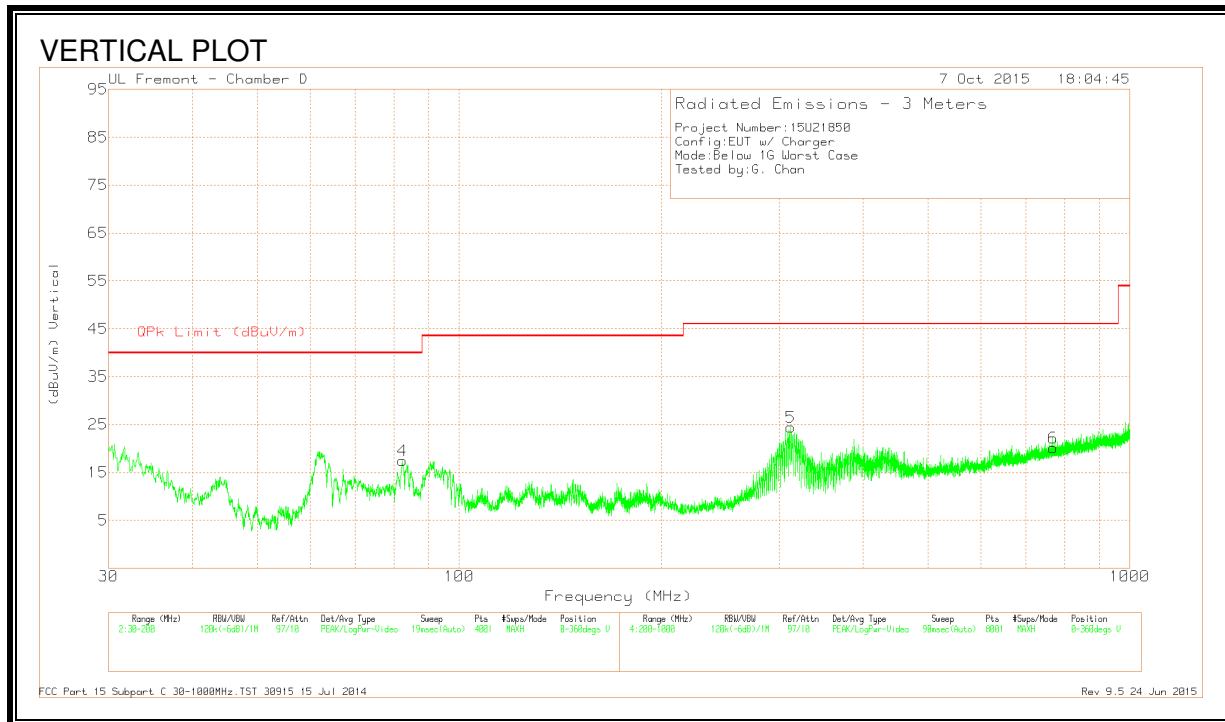
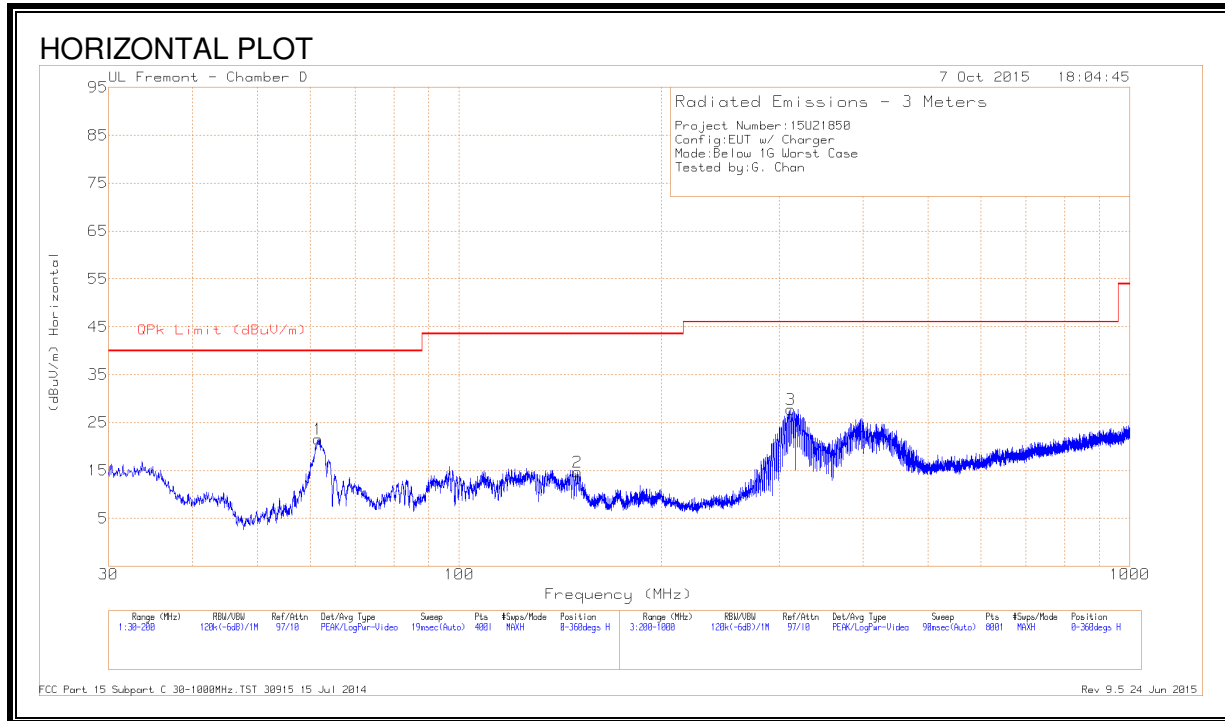

HORIZONTAL AND VERTICAL DATA

Marker	Frequency (MHz)	Meter Reading (dBuV)	Det	AFT407 (dB/m)	Amp/Cbl (dB)	Corrected Reading (dBuV/m)	QPk Limit (dBuV/m)	Margin (dB)	Azimuth (Degs)	Height (cm)	Polarity
1	61.535	45.63	Pk	7.6	-31.7	21.53	40	-18.47	0-360	401	H
4	82.3175	41.45	Pk	7.5	-31.5	17.45	40	-22.55	0-360	100	V
2	150.19	33.64	Pk	12.2	-31.1	14.74	43.52	-28.78	0-360	301	H
3	312.1	44.64	Pk	13.5	-30.4	27.74	46.02	-18.28	0-360	100	H
5	312.3	41.38	Pk	13.5	-30.4	24.48	46.02	-21.54	0-360	100	V
6	768.4	28.56	Pk	20.7	-29.1	20.16	46.02	-25.86	0-360	201	V

Pk - Peak detector

9.7. WORST-CASE ABOVE 18 GHz

SPURIOUS EMISSIONS 18000 TO 26000 MHz (WORST-CASE CONFIGURATION)

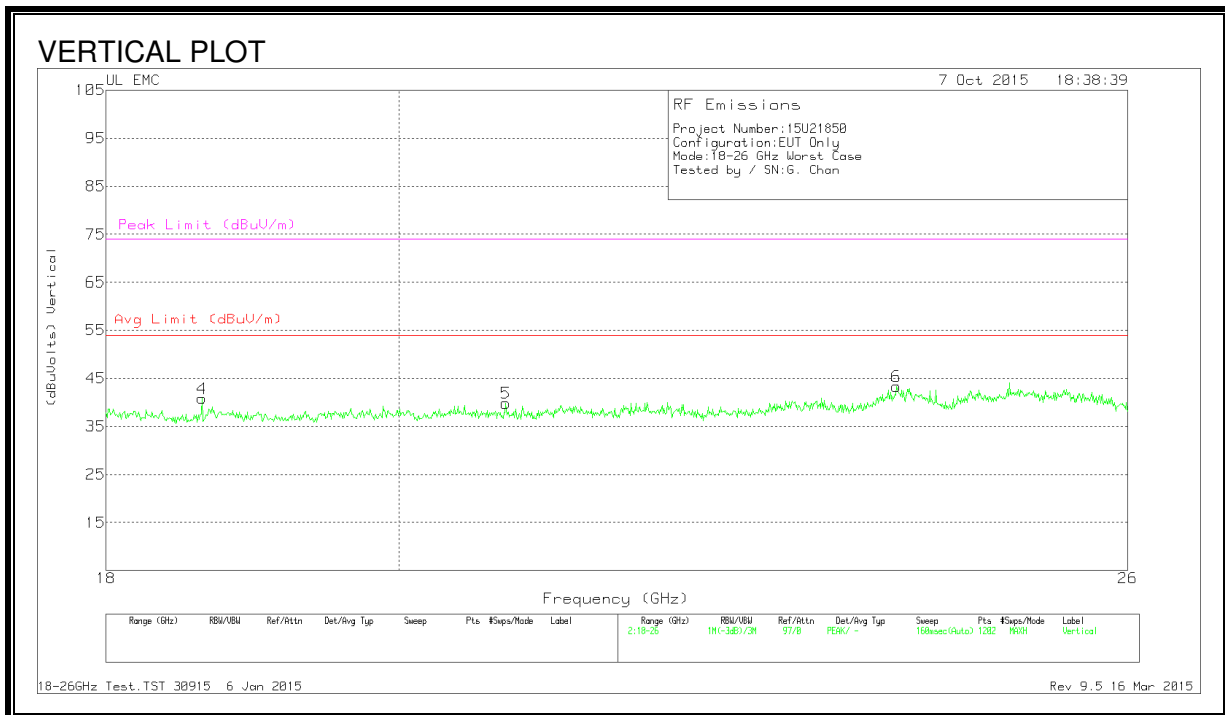
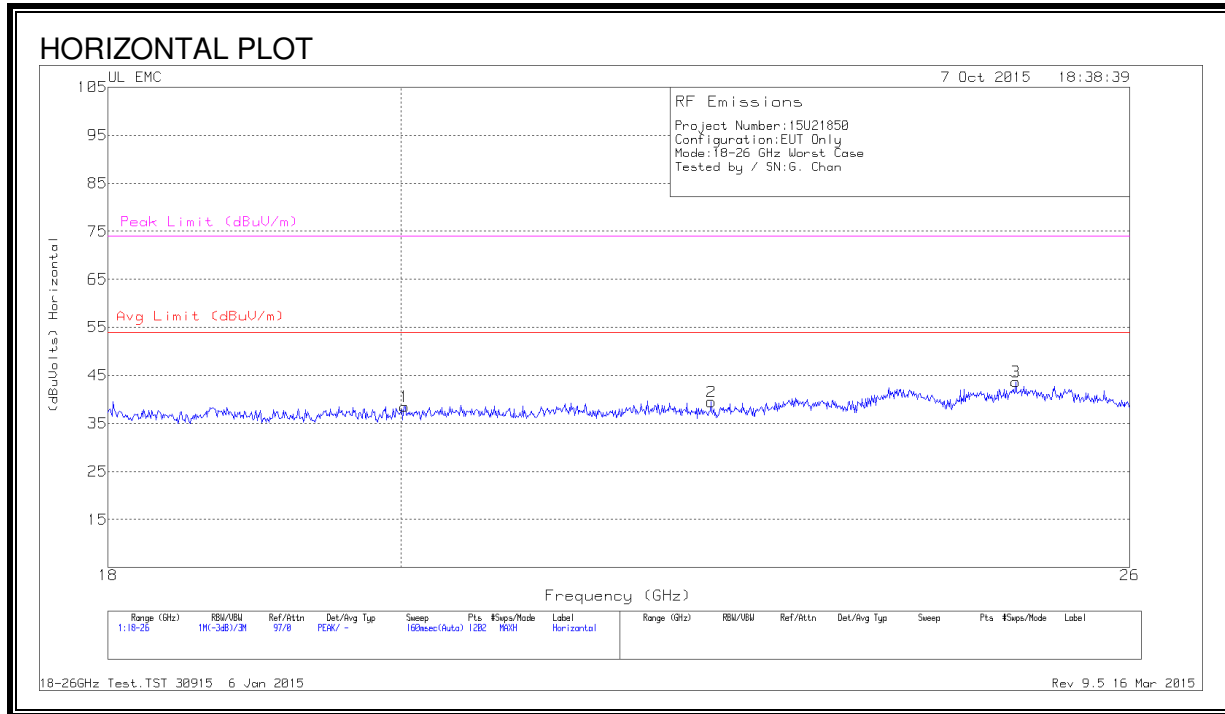

HORIZONTAL AND VERTICAL DATA

Marker	Frequency (GHz)	Meter Reading (dBuV)	Det	T89 AF (dB/m)	Amp/Cbl (dB)	Dist Corr (dB)	Corrected Reading (dBuVolts)	Avg Limit (dBuV/m)	Margin (dB)	Peak Limit (dBuV/m)	PK Margin (dB)
1	20.028	40.2	Pk	33	-25.2	-9.5	38.5	54	-15.5	74	-35.5
2	22.363	40.7	Pk	33	-24.7	-9.5	39.5	54	-14.5	74	-34.5
3	24.954	43.47	Pk	34.1	-24.4	-9.5	43.67	54	-10.33	74	-30.33
4	18.633	42.63	Pk	32.5	-24.8	-9.5	40.83	54	-13.17	74	-33.17
5	20.784	41.43	Pk	32.7	-24.8	-9.5	39.83	54	-14.17	74	-34.17
6	23.922	43.33	Pk	33.4	-23.9	-9.5	43.33	54	-10.67	74	-30.67

Pk - Peak detector

SPURIOUS EMISSIONS 26000 TO 40000 MHz (WORST-CASE CONFIGURATION)

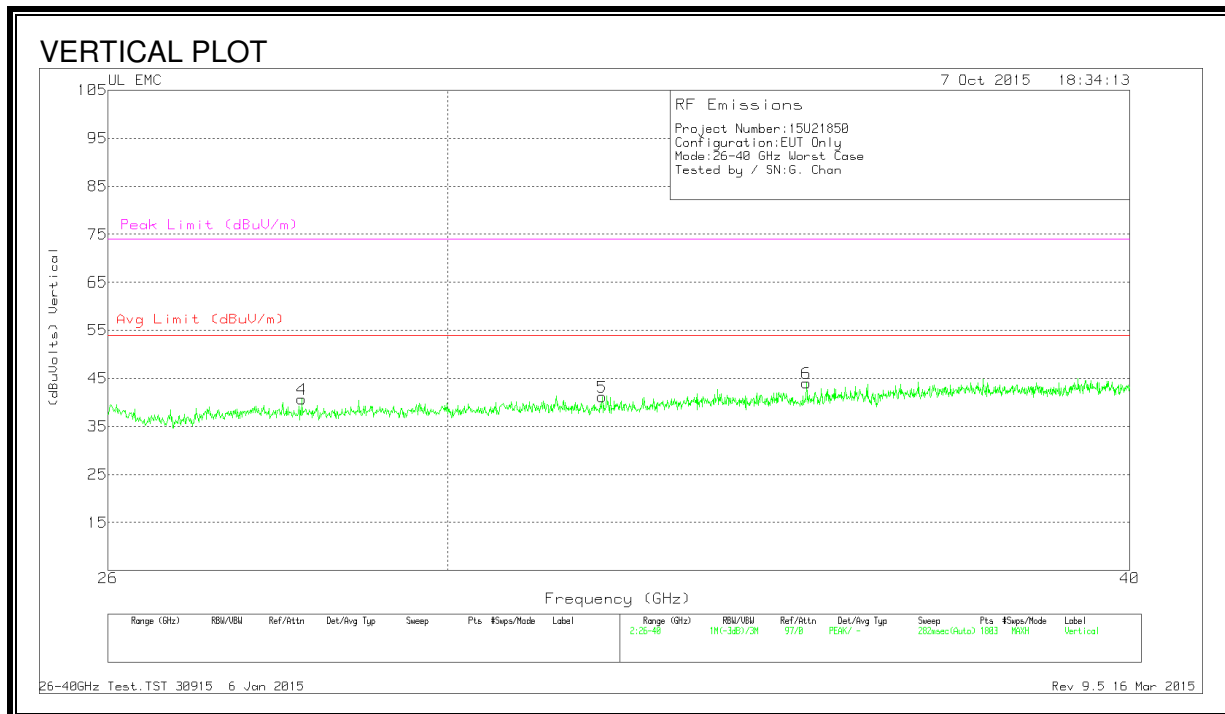
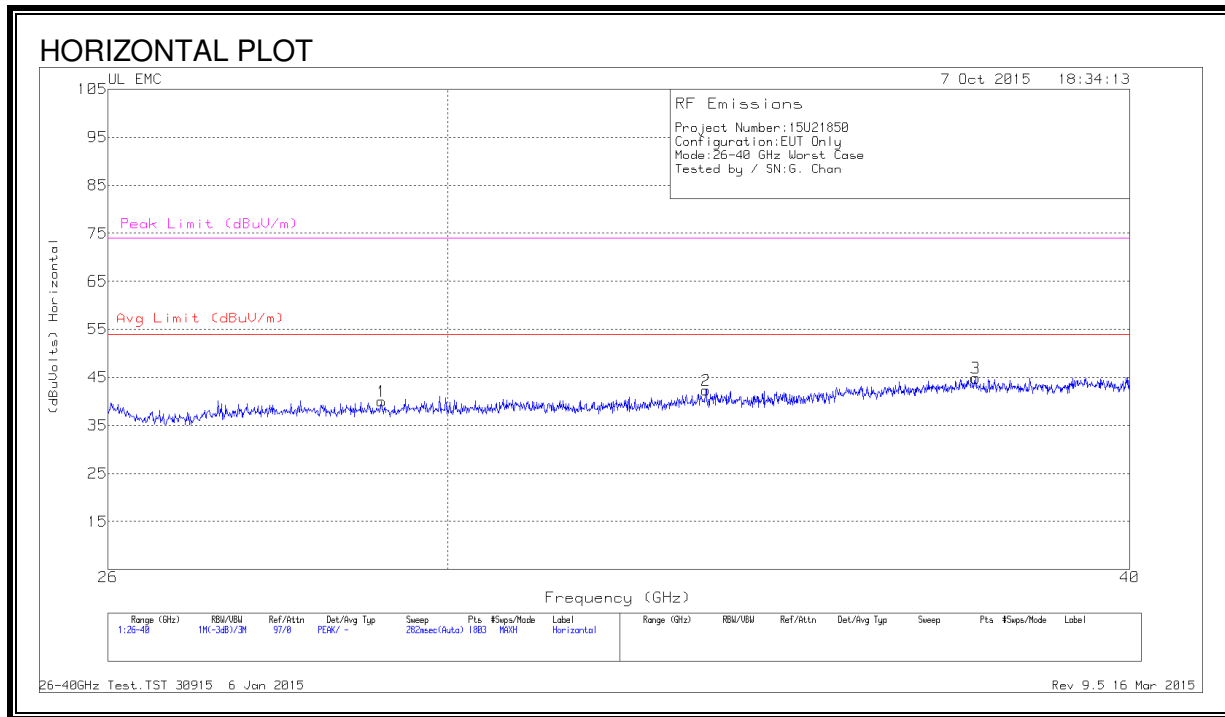

HORIZONTAL AND VERTICAL DATA

Marker	Frequency (GHz)	Meter Reading (dBuV)	Det	T90 AF (dB/m)	Amp/Cbl (dB)	Dist Corr (dB)	Corrected Reading (dBuVolts)	Avg Limit (dBuV/m)	Margin (dB)	Peak Limit (dBuV/m)	PK Margin (dB)
1	29.178	45.8	Pk	35.9	-32.2	-9.5	40	54	-14	74	-34
2	33.454	47.53	Pk	37.1	-32.8	-9.5	42.33	54	-11.67	74	-31.67
3	37.483	50.03	Pk	37.3	-33	-9.5	44.83	54	-9.17	74	-29.17
4	28.214	46.07	Pk	35.9	-31.8	-9.5	40.67	54	-13.33	74	-33.33
5	32.021	47.27	Pk	36.2	-32.8	-9.5	41.17	54	-12.83	74	-32.83
6	34.903	49.5	Pk	37.2	-33.2	-9.5	44	54	-10	74	-30

Pk - Peak detector

10. AC POWER LINE CONDUCTED EMISSIONS

LIMITS

FCC §15.207 (a)

Frequency of Emission (MHz)	Conducted Limit (dB μ V)	
	Quasi-peak	Average
0.15-0.5	66 to 56 *	56 to 46 *
0.5-5	56	46
5-30	60	50

*Decreases with the logarithm of the frequency.

TEST PROCEDURE

The EUT is placed on a non-conducting table 40 cm from the vertical ground plane and 80 cm above the horizontal ground plane. The EUT is configured in accordance with ANSI C63.10.

The receiver is set to a resolution bandwidth of 9 kHz. Peak detection is used unless otherwise noted as quasi-peak or average.

Line conducted data is recorded for both NEUTRAL and HOT lines.

RESULTS

10.1. EUT POWERED BY AC ADAPTER

LINE 1 RESULTS

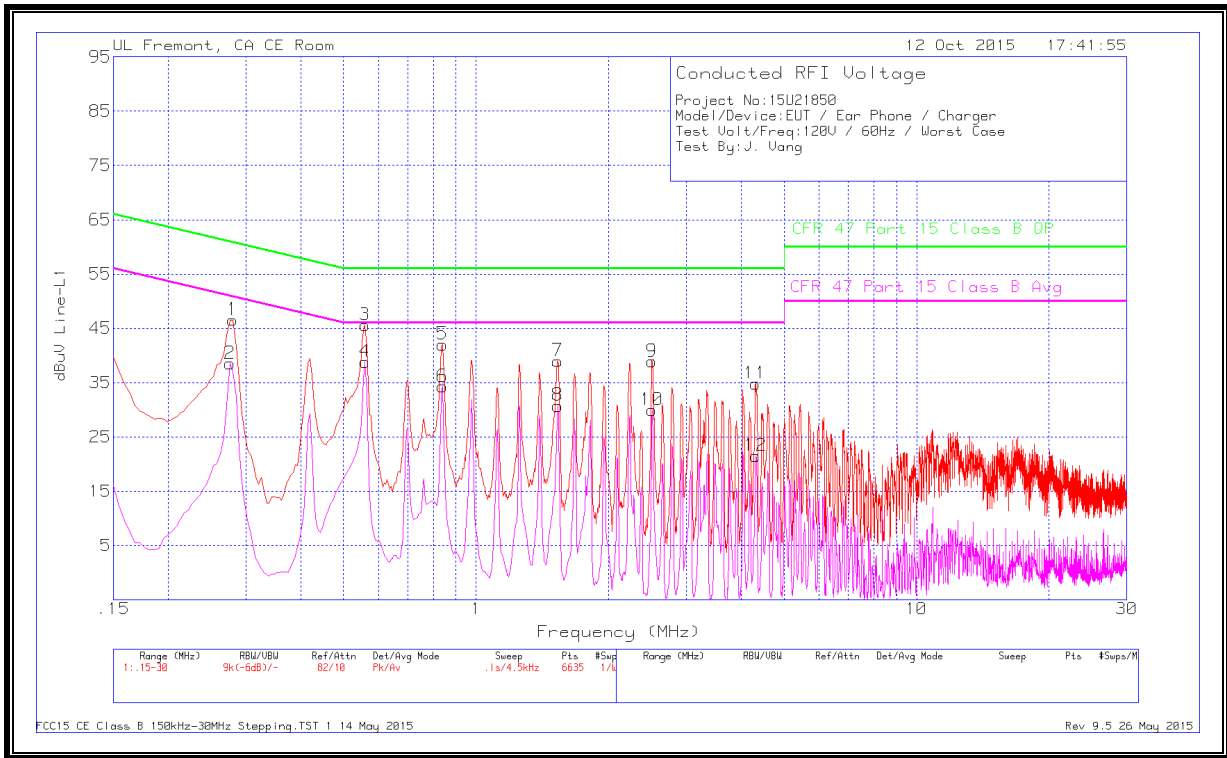

WORST EMISSIONS

Marker	Frequency (MHz)	Meter Reading (dBuV)	Det	T24 IL L1	LC Cables 1&3	Corrected Reading dBuV	CFR 47 Part 15 Class B QP	Margin (dB)	CFR 47 Part 15 Class B Avg	Margin (dB)
1	.2805	45.95	Pk	.6	0	46.55	60.8	-14.25	-	-
2	.276	37.92	Av	.6	0	38.52	-	-	50.94	-12.42
3	.5595	45.31	Pk	.3	0	45.61	56	-10.39	-	-
4	.5595	38.52	Av	.3	0	38.82	-	-	46	-7.18
5	.8385	41.74	Pk	.3	0	42.04	56	-13.96	-	-
6	.8385	33.98	Av	.3	0	34.28	-	-	46	-11.72
7	1.5315	38.68	Pk	.2	.1	38.98	56	-17.02	-	-
8	1.5315	30.48	Av	.2	.1	30.78	-	-	46	-15.22
9	2.508	38.6	Pk	.2	.1	38.9	56	-17.1	-	-
10	2.508	29.68	Av	.2	.1	29.98	-	-	46	-16.02
11	4.308	34.54	Pk	.2	.1	34.84	56	-21.16	-	-
12	4.308	21.24	Av	.2	.1	21.54	-	-	46	-24.46

Pk - Peak detector

Av - Average detection

LINE 2 RESULTS

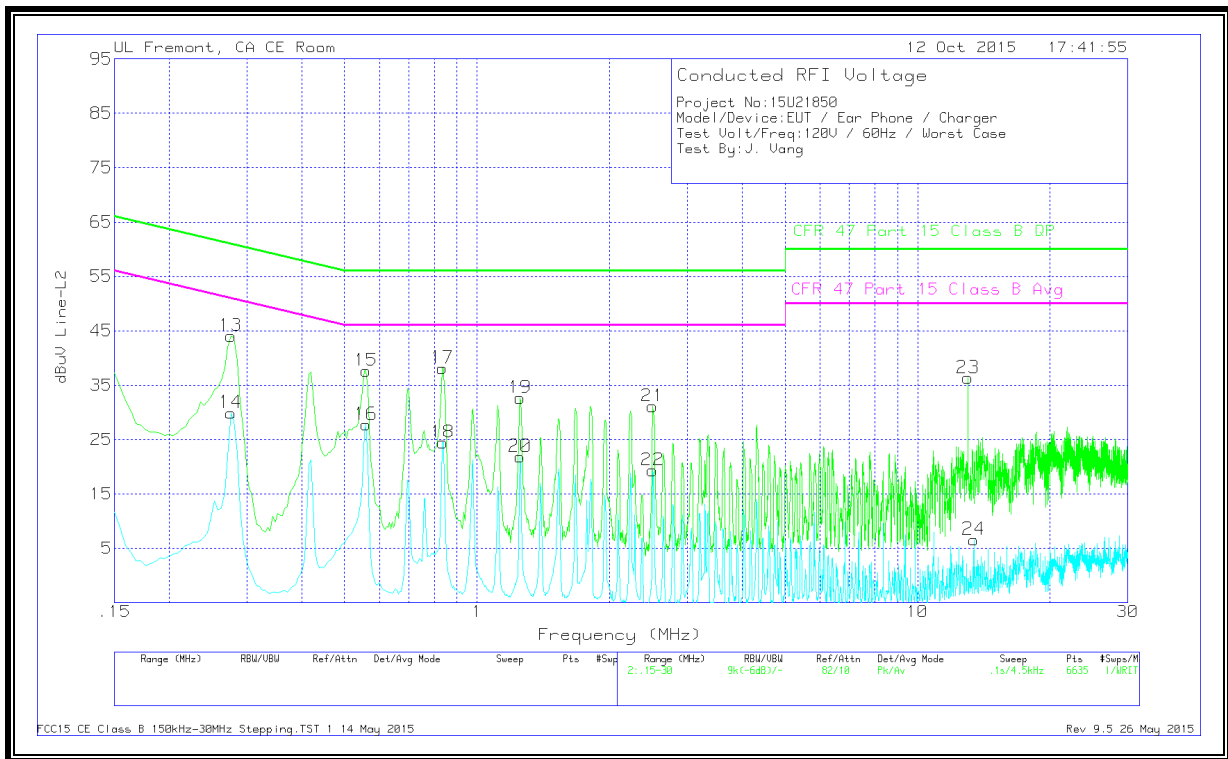

WORST EMISSIONS

Marker	Frequency (MHz)	Meter Reading (dBuV)	Det	T24 IL L2	LC Cables 2&3	Corrected Reading dBuV	CFR 47 Part 15 Class B QP	Margin (dB)	CFR 47 Part 15 Class B Avg	Margin (dB)
13	.276	43.38	Pk	.7	0	44.08	60.94	-16.86	-	-
14	.276	29.19	Av	.7	0	29.89	-	-	50.94	-21.05
15	.5595	37.36	Pk	.3	0	37.66	56	-18.34	-	-
16	.5595	27.44	Av	.3	0	27.74	-	-	46	-18.26
17	.834	37.81	Pk	.3	0	38.11	56	-17.89	-	-
18	.83625	24.15	Av	.3	0	24.45	-	-	46	-21.55
19	1.2525	32.47	Pk	.2	0	32.67	56	-23.33	-	-
20	1.2525	21.64	Av	.2	0	21.84	-	-	46	-24.16
21	2.5035	30.81	Pk	.2	.1	31.11	56	-24.89	-	-
22	2.5035	19.06	Av	.2	.1	19.36	-	-	46	-26.64
23	13.0155	35.94	Pk	.2	.2	36.34	60	-23.66	-	-
24	13.4205	6.18	Av	.2	.2	6.58	-	-	50	-43.42

Pk - Peak detector

Av - Average detection

10.2. EUT POWERED BY HOST PC VIA USB CABLE

LINE 1 RESULTS

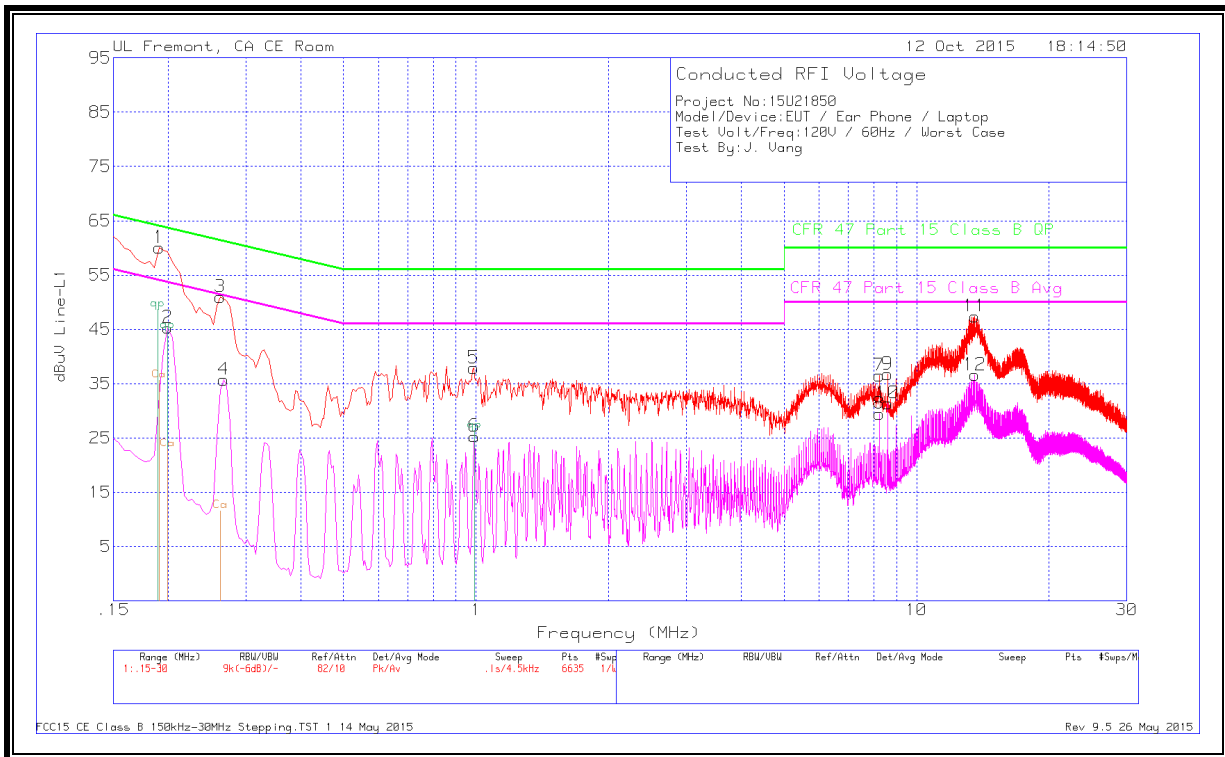

WORST EMISSIONS

Marker	Frequency (MHz)	Meter Reading (dBuV)	Det	T24 IL L1	LC Cables 1&3	Corrected Reading dBuV	CFR 47 Part 15 Class B QP	Margin (dB)	CFR 47 Part 15 Class B Avg	Margin (dB)
1	.1905	59.02	Pk	1	0	60.02	64.01	-3.99	-	-
2	.18938	47.7	Qp	1	0	48.7	64.06	-15.36	53.63	-8.36
3	.1995	44.37	Av	.9	0	45.27	-	-	-	-
4	.2625	50.26	Pk	.7	0	50.96	61.35	-10.39	-	-
5	.267	35.13	Av	.6	0	35.73	-	-	51.21	-15.48
6	.987	37.57	Pk	.3	0	37.87	56	-18.13	-	-
7	.9915	24.98	Av	.3	0	25.28	-	-	46	-20.72
8	8.2275	36.18	Pk	.2	.1	36.48	60	-23.52	-	-
9	8.2275	29.14	Av	.2	.1	29.44	-	-	50	-20.56
10	8.601	36.41	Pk	.2	.1	36.71	60	-23.29	-	-
11	8.601	31.09	Av	.2	.1	31.39	-	-	50	-18.61
12	13.56	46.96	Pk	.2	.2	47.36	60	-12.64	-	-
	13.56	36.18	Av	.2	.2	36.58	-	-	50	-13.42

Pk - Peak detector
 Av - Average detection
 Qp - Quasi-Peak detector

LINE 2 RESULTS

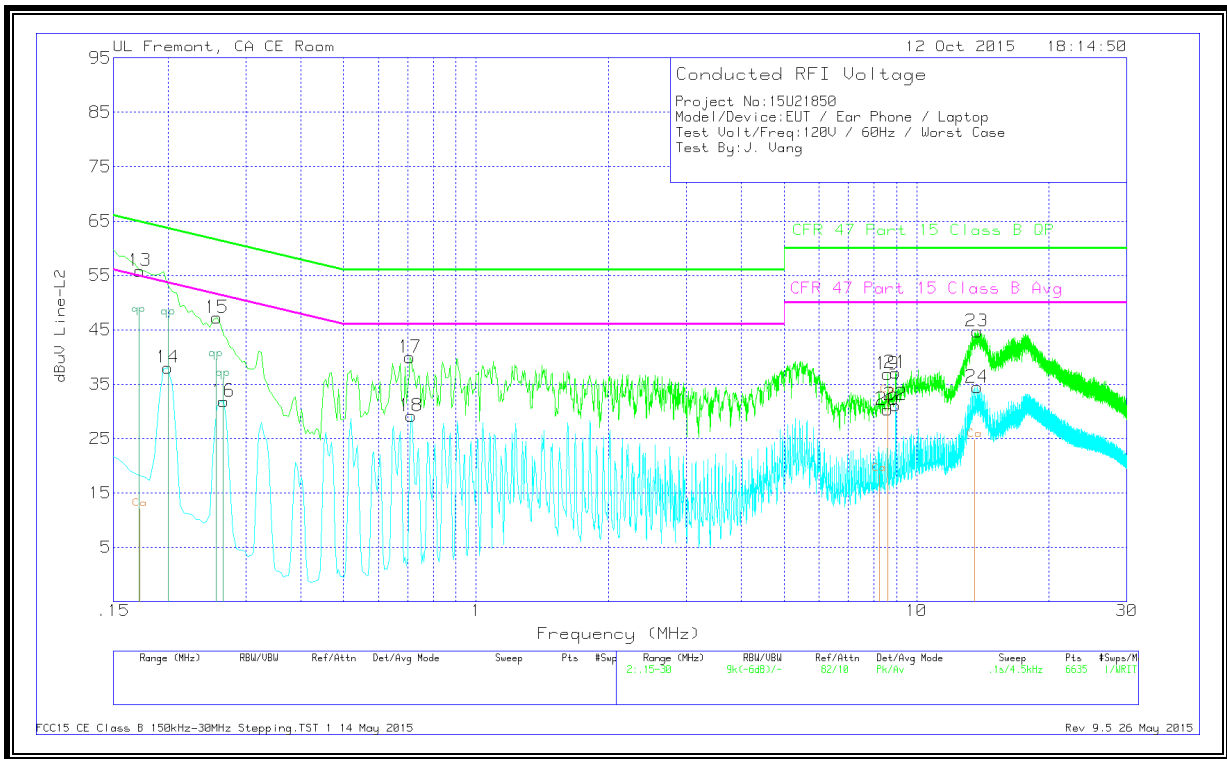

WORST EMISSIONS

Marker	Frequenc y (MHz)	Meter Reading (dBuV)	Det	T24 IL L2	LC Cables 2&3	Corrected Reading dBuV	CFR 47 Part 15 Class B QP	Margin (dB)	CFR 47 Part 15 Class B Avg	Margin (dB)
13	.1725	54.65	Pk	1.2	0	55.85	64.84	-8.99	-	-
14	.1995	37.01	Av	1	0	38.01	-	-	53.63	-15.62
15	.258	46.51	Pk	.7	0	47.21	61.5	-14.29	-	-
16	.267	31.14	Av	.7	0	31.84	-	-	51.21	-19.37
17	.708	39.62	Pk	.3	0	39.92	56	-16.08	-	-
18	.7125	28.87	Av	.3	0	29.17	-	-	46	-16.83
19	8.5965	36.55	Pk	.2	.1	36.85	60	-23.15	-	-
20	8.592	30	Av	.2	.1	30.3	-	-	50	-19.7
21	8.97	36.79	Pk	.2	.1	37.09	60	-22.91	-	-
22	8.9655	30.86	Av	.2	.1	31.16	-	-	50	-18.84
23	13.7265	44.3	Pk	.2	.2	44.7	60	-15.3	-	-
24	13.7265	34.02	Av	.2	.2	34.42	-	-	50	-15.58

Pk - Peak detector
 Av - Average detection