



**FCC CFR47 PART 15 SUBPART C
CERTIFICATION TEST REPORT**

FOR

**TABLET WITH CELLULAR GSM/GPRS/EGPRS/WCDMA/HSPA+/DC- HSDPA/LTE
IEEE 802.11A/B/G/N (MIMO 2X2) AND BLUETOOTH RADIO**

Model: A1491

FCC ID: BCGA1491

REPORT NUMBER: 13U16583-5, Revision A

ISSUE DATE: FEBRUARY 21, 2014

Prepared for
APPLE, INC.
1 INFINITE LOOP
CUPERTINO, CA 95014, U.S.A.

Prepared by
UL VERIFICATION SERVICES INC.
47173 BENICIA STREET
FREMONT, CA 94538, U.S.A.
TEL: (510) 771-1000
FAX: (510) 661-0888



NVLAP LAB CODE 200065-0

Revision History

<u>Rev.</u>	<u>Issue Date</u>	<u>Revisions</u>	<u>Revised By</u>
---	02/15/2014	Initial	T. Chan
A	02/21/2014	Adreesed TCB's Questions	T. Chan

TABLE OF CONTENTS

1. ATTESTATION OF TEST RESULTS.....	4
2. TEST METHODOLOGY	5
3. FACILITIES AND ACCREDITATION.....	5
4. CALIBRATION AND UNCERTAINTY	5
5. EQUIPMENT UNDER TEST	7
5.1. <i>DESCRIPTION OF EUT.....</i>	7
5.2. <i>MAXIMUM OUTPUT POWER.....</i>	7
5.3. <i>DESCRIPTION OF AVAILABLE ANTENNAS.....</i>	7
5.4. <i>SOFTWARE AND FIRMWARE.....</i>	7
5.5. <i>WORST-CASE CONFIGURATION AND MODE.....</i>	8
5.6. <i>DESCRIPTION OF TEST SETUP.....</i>	9
6. TEST AND MEASUREMENT EQUIPMENT	12
7. ON TIME AND DUTY CYCLE RESULTS	13
7.1. <i>MEASUREMENT METHODS</i>	13
8. ANTENNA PORT TEST RESULTS	14
9. RADIATED TEST RESULTS	15
9.1. <i>LIMITS AND PROCEDURE</i>	15
9.2. <i>TRANSMITTER ABOVE 1 GHz</i>	16
9.3. <i>WORST-CASE ABOVE 18 GHz</i>	26
9.4. <i>WORST-CASE BELOW 1 GHz.....</i>	27
10. SETUP PHOTOS.....	29

1. ATTESTATION OF TEST RESULTS

COMPANY NAME: APPLE, INC.
1 INFINITE LOOP
CUPERTINO, CA 95014, U.S.A.

EUT DESCRIPTION: Tablet with cellular GSM/GPRS/EGPRS/WCDMA/HSPA+/DC-HSDPA/LTE/IEEE 802.11a/b/g/n (MIMO 2x2) and Bluetooth Radio

MODEL: A1491

SERIAL NUMBER: DLXL2008FW7N

DATE TESTED: AUGUST 21-29 -FEBRUARY 15, 2014

APPLICABLE STANDARDS	
STANDARD	TEST RESULTS
CFR 47 Part 15 Subpart C	Pass

UL Verification Services Inc. tested the above equipment in accordance with the requirements set forth in the above standards. All indications of Pass/Fail in this report are opinions expressed by UL Verification Services based on interpretations and/or observations of test results. Measurement Uncertainties were not taken into account and are published for informational purposes only. The test results show that the equipment tested is capable of demonstrating compliance with the requirements as documented in this report.

Note: The results documented in this report apply only to the tested sample, under the conditions and modes of operation as described herein. This document may not be altered or revised in any way unless done so by UL Verification Services and all revisions are duly noted in the revisions section. Any alteration of this document not carried out by UL Verification Services will constitute fraud and shall nullify the document. This report must not be used by the client to claim product certification, approval, or endorsement by NVLAP, NIST, any agency of the Federal Government, or any agency of any government.

Approved & Released For
UL Verification Services Inc. By:

Tested By:



Thu Chan
WiSE Operations Manager
UL Verification Services Inc.

Oliver Su
WiSE Senior Engineer
UL Verification Services Inc

2. TEST METHODOLOGY

The tests documented in this report were performed in accordance with ANSI C63.10-2009, FCC CFR 47 Part 2, FCC CFR 47 Part 15, RSS-GEN Issue 3, and RSS-210 Issue 8.

3. FACILITIES AND ACCREDITATION

The test sites and measurement facilities used to collect data are located at 47173 Benicia Street, Fremont, California, USA.

The test sites and measurement facilities used to collect data are located at 47173 and 47266 Benicia Street, Fremont, California, USA. Line conducted emissions are measured only at the 47173 address. The following table identifies which facilities were utilized for radiated emission measurements documented in this report. Specific facilities are also identified in the test results sections.

47173 Benicia Street	47266 Benicia Street
<input type="checkbox"/> Chamber A	<input type="checkbox"/> Chamber D
<input type="checkbox"/> Chamber B	<input checked="" type="checkbox"/> Chamber E
<input type="checkbox"/> Chamber C	<input checked="" type="checkbox"/> Chamber F

UL Verification Services Inc. is accredited by NVLAP, Laboratory Code 200065-0. The full scope of accreditation can be viewed at <http://www.ccsemc.com>.

4. CALIBRATION AND UNCERTAINTY

4.1. MEASURING INSTRUMENT CALIBRATION

The measuring equipment utilized to perform the tests documented in this report has been calibrated in accordance with the manufacturer's recommendations, and is traceable to recognized national standards.

4.2. SAMPLE CALCULATION

Where relevant, the following sample calculation is provided:

$$\begin{aligned} \text{Field Strength (dBuV/m)} &= \text{Measured Voltage (dBuV)} + \text{Antenna Factor (dB/m)} + \\ &\text{Cable Loss (dB)} - \text{Preamp Gain (dB)} \\ 36.5 \text{ dBuV} + 18.7 \text{ dB/m} + 0.6 \text{ dB} - 26.9 \text{ dB} &= 28.9 \text{ dBuV/m} \end{aligned}$$

4.3. MEASUREMENT UNCERTAINTY

Where relevant, the following measurement uncertainty levels have been estimated for tests performed on the apparatus:

PARAMETER	UNCERTAINTY
Conducted Disturbance, 0.15 to 30 MHz	3.52 dB
Radiated Disturbance, 30 to 1000 MHz	4.94 dB

Uncertainty figures are valid to a confidence level of 95%.

5. EQUIPMENT UNDER TEST

5.1. DESCRIPTION OF EUT

The device is a Tablet with cellular GSM/GPRS/EGPRS/WCDMA/HSPA+/DC-HSDPA/LTE/IEEE 802.11a/b/g/n (MIMO 2x2) and Bluetooth Radio.

5.2. MAXIMUM OUTPUT POWER

Please refer to project number 13U15668-12, Section 5.2

5.3. DESCRIPTION OF AVAILABLE ANTENNAS

The radio utilizes a PiFA antenna, with a maximum gain of 0.81dBi.

5.4. SOFTWARE AND FIRMWARE

The firmware installed in the EUT during testing was Broadcom Bluetooth Version 1.5.6.2.

5.5. WORST-CASE CONFIGURATION AND MODE

There are two vendors of the WiFi/Bluetooth radio modules: BOM #1, vender1 and BOM #2, vender 2, and they have the same mechanical outline, same on board antenna, matching circuit, antenna structure and same specification and baseline was performed on both vendors to determine the worst case on conducted power and radiated emissions.

For the RF conducted test: Refer to FCC DTS report with the FCC ID BCGA1490 and project number 13U15668-12.

For the RF radiated test: The fundamental of the EUT was investigated in three orthogonal orientations X, Y, Z, with AC Adapter and Headset, it was determined that X orientation without AC Adapter and Headset was the worst-case orientation for 2.4GHz band, and Z orientation was the worst-case orientation for 5.8 GHz band; therefore, all final radiated testing was performed with the EUT in X orientation for 2.4GHz band, and Z orientation for 5.8 GHz band.

Worst-case data rates as provided by the client were:

802.11b mode: 1 Mbps
802.11g mode: 6 Mbps
802.11a mode: 6 Mbps
802.11n HT20mode: MCS0
802.11n HT40mode: MCS0

For below 1GHz test, the EUT that is connected to the headset and AC charger is activated on the worst-case mode and channel with the highest output power.

For all modes with single chain, the radiated emissions test was based on the port with the higher antenna gain.

5.6. DESCRIPTION OF TEST SETUP

SUPPORT EQUIPMENT

Support Equipment List				
Description	Manufacturer	Model	Serial Number	FCC ID
AC/DC Adapter	Apple	A1357	A/12981EA	DoC
Earphone	Apple	NA	NA	NA

I/O CABLES (RADIATED TEST)

I/O Cable List						
Cable No	Port	# of identical ports	Connector Type	Cable Type	Cable Length (m)	Remarks
1	Audio	1	Jack	Un-Shielded	0.5m	NA

SETUP DIAGRAM FOR RADIATED TESTS

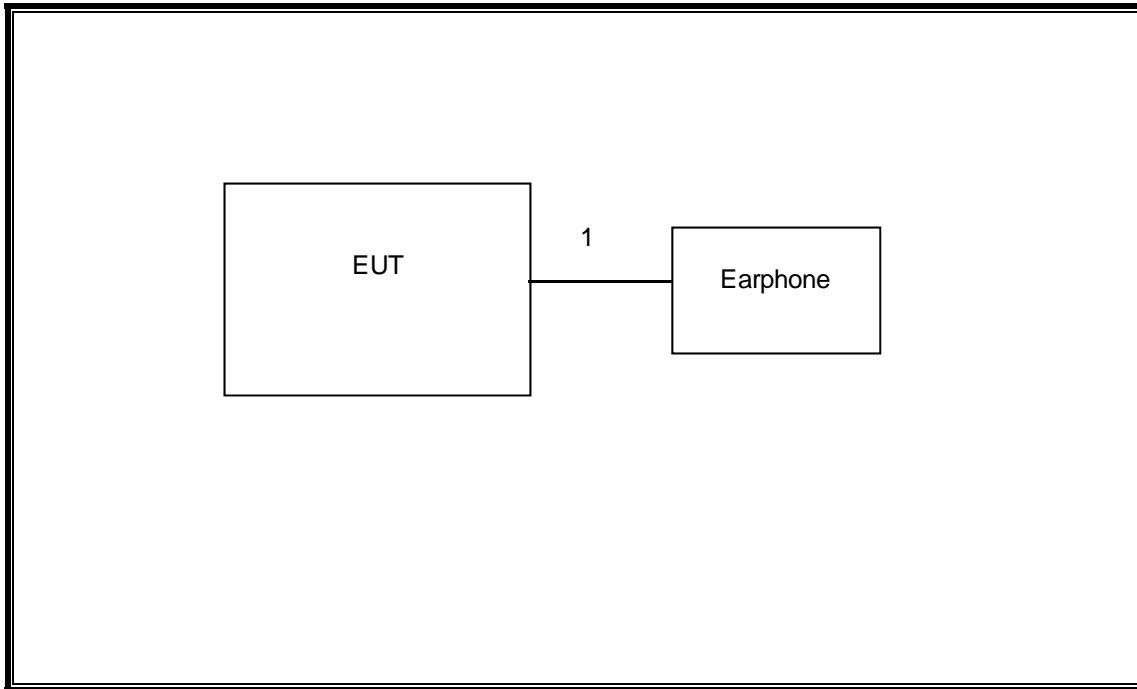

SETUP DIAGRAM FOR BELOW 1GHz TEST

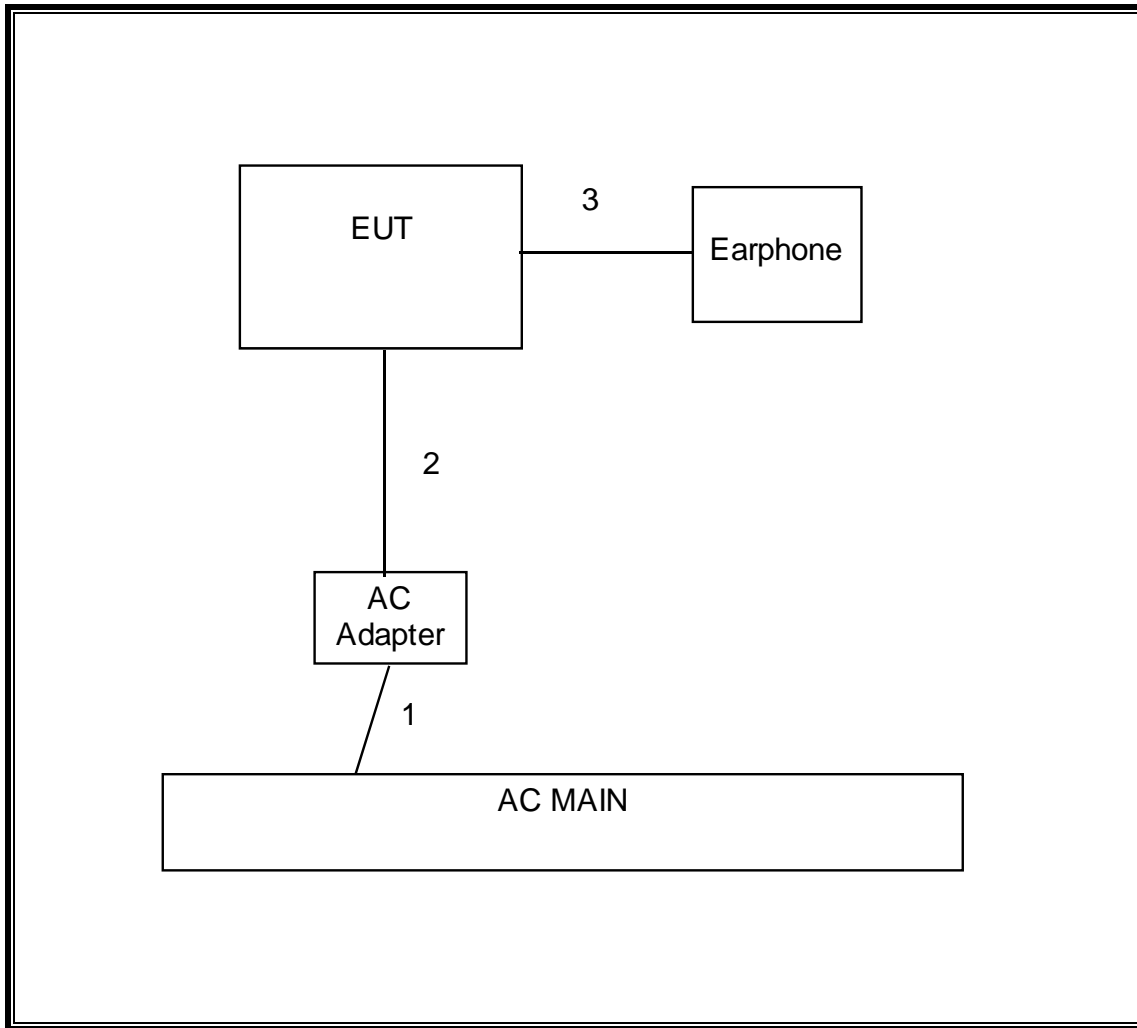

6. TEST AND MEASUREMENT EQUIPMENT

The following test and measurement equipment was utilized for the tests documented in this report:

TEST EQUIPMENT LIST				
Description	Manufacturer	Model	Asset	Cal Due
Antenna, Horn, 18 GHz	ETS Lindgren	3117	F00131	02/18/15
Antenna, Horn, 26.5 GHz	ARA	MVH-1826/B	C00589	04/28/14
Peak / Average Power Sensor	Agilent / HP	N1911A	F00153	04/05/14
Peak Power Meter	Agilent / HP	E9323A	F00025	04/03/14
Spectrum Analyzer, 44 GHz	Agilent / HP	N9030A	F00126	02/22/14
Antenna, Bilog, 2 GHz	Sunol Sciences	JB1	F00168	03/07/14
Preamplifier, 1300 MHz	Sonoma	310	F00008	11/06/13
Preamplifier, 26.5 GHz	Agilent / HP	8449B	F00165	03/18/14

7. ON TIME AND DUTY CYCLE RESULTS

Refer the on time and duty cycle data in FCC DTS report with the FCC ID BCGA1490 and project number 13U15668-12 at Section 7.1.

7.1. MEASUREMENT METHODS

6 dB BW: KDB 558074 D01.

Output Power: KDB 558074 D01.

Power Spectral Density: KDB 558074 D01.

Out-of-band emissions in non-restricted bands: KDB 558074 D01.

Out-of-band emissions in restricted bands: KDB 558074 D01.

8. ANTENNA PORT TEST RESULTS

Note that for all antenna port data refer to the FCC BLE DTS report with the FCC ID BCGA1490 and project number 13U15668-12 from Section 8.1. to 8.6.

9. RADIATED TEST RESULTS

9.1. LIMITS AND PROCEDURE

LIMITS

FCC §15.205 and §15.209

IC RSS-210 Clause 2.6 (Transmitter)

IC RSS-GEN Clause 6 (Receiver)

Frequency Range (MHz)	Field Strength Limit (uV/m) at 3 m	Field Strength Limit (dBuV/m) at 3 m
30 - 88	100	40
88 - 216	150	43.5
216 - 960	200	46
Above 960	500	54

TEST PROCEDURE

The EUT is placed on a non-conducting table 80 cm above the ground plane. The antenna to EUT distance is 3 meters. The EUT is configured in accordance with ANSI C63.4. The EUT is set to transmit in a continuous mode.

For measurements below 1 GHz the resolution bandwidth is set to 100 kHz for peak detection measurements or 120 kHz for quasi-peak detection measurements. Peak detection is used unless otherwise noted as quasi-peak.

For measurements above 1 GHz the resolution bandwidth is set to 1 MHz, then the video bandwidth is set to 1 MHz for peak measurements and 10 Hz for average measurements.

For 2.4 GHz band, the spectrum from 30 MHz to 26 GHz is investigated with the transmitter set to the lowest, middle, and highest channels in the 2.4 GHz band.

The frequency range of interest is monitored at a fixed antenna height and EUT azimuth. The EUT is rotated through 360 degrees to maximize emissions received. The antenna is scanned from 1 to 4 meters above the ground plane to further maximize the emission. Measurements are made with the antenna polarized in both the vertical and the horizontal positions.

9.2. TRANSMITTER ABOVE 1 GHz

RESTRICTED BANDEDGE (LOW CHANNEL, HORIZONTAL)

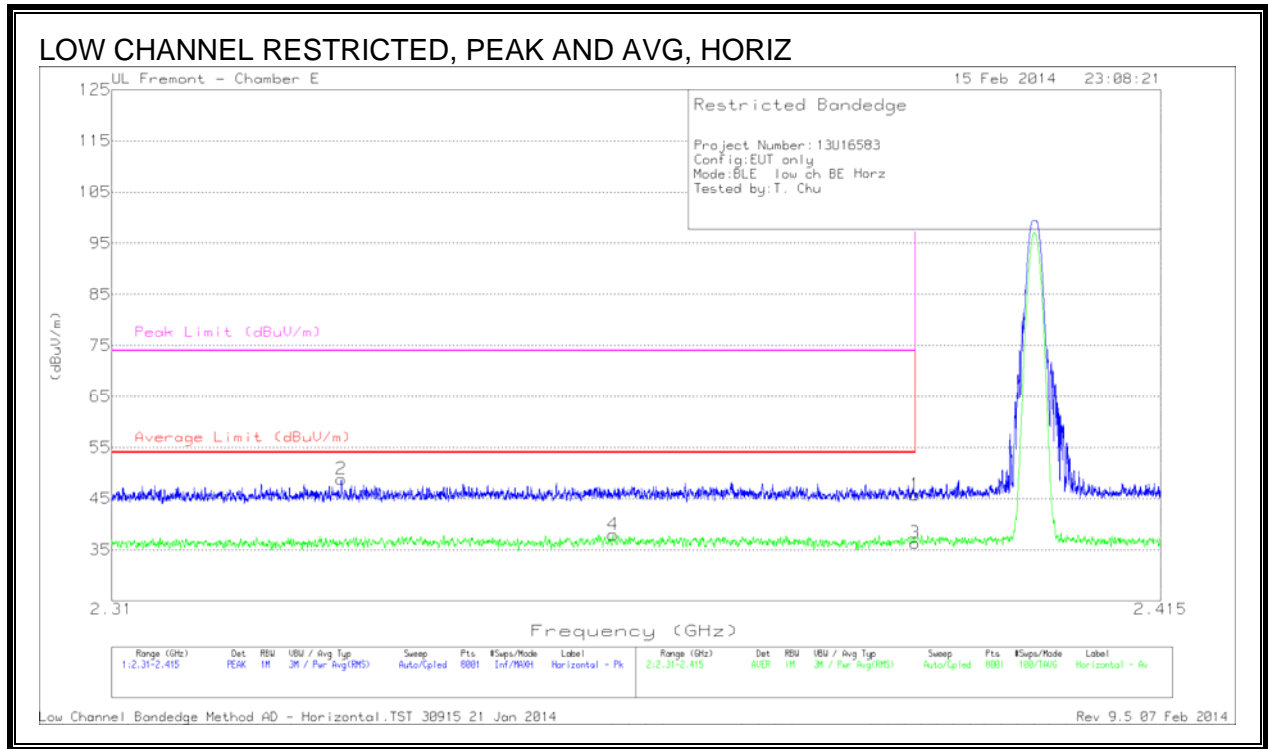

DATA

Marker	Frequency (GHz)	Meter Reading (dBuV)	Det	AF T711 (dB/m)	Amp/Cbl /Filtr/Pa d (dB)	Corrected Reading (dBuV/m)	Average Limit (dBuV/m)	Margin (dB)	Peak Limit (dBuV/m)	PK Margin (dB)	Azimuth (Degs)	Height (cm)	Polarity
1	2.390	38.16	PK	32.6	-25.0	45.76	-	-	74	-28.24	325	252	H
2	2.333	41.40	PK	32.6	-25.2	48.80	-	-	74	-25.20	325	252	H
3	2.390	28.71	RMS	32.6	-25.0	36.31	54	-17.69	-	-	325	252	H
4	2.360	30.03	RMS	32.6	-24.7	37.93	54	-16.07	-	-	325	252	H

PK - Peak detector
 RMS - RMS detection

RESTRICTED BANDEDGE (LOW CHANNEL, VERTICAL)

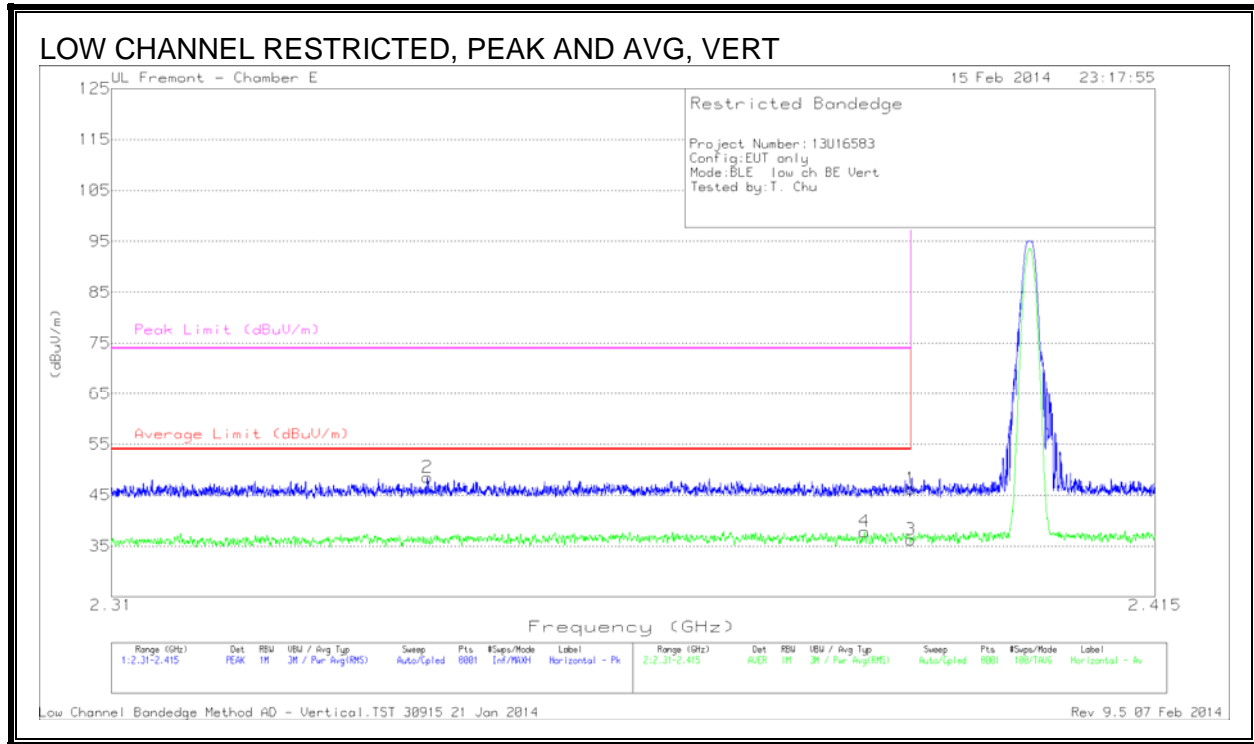

DATA

Marker	Frequency (GHz)	Meter Reading (dBuV)	Det	AF T711 (dB/m)	Amp/Cbl /Fitr/Pa d (dB)	Corrected Reading (dBuV/m)	Average Limit (dBuV/m)	Margin (dB)	Peak Limit (dBuV/m)	PK Margin (dB)	Azimuth (Degs)	Height (cm)	Polarity
1	2.390	38.65	PK	32.6	-25	46.25	-	-	74	-27.75	147	244	V
2	2.341	40.90	PK	32.6	-25	48.50	-	-	74	-25.50	147	244	V
3	2.390	28.67	RMS	32.6	-25	36.27	54	-17.73	-	-	147	244	V
4	2.385	30.25	RMS	32.6	-25	37.85	54	-16.15	-	-	147	244	V

PK - Peak detector
 RMS - RMS detection

RESTRICTED BANDEDGE (HIGH CHANNEL, HORIZONTAL)

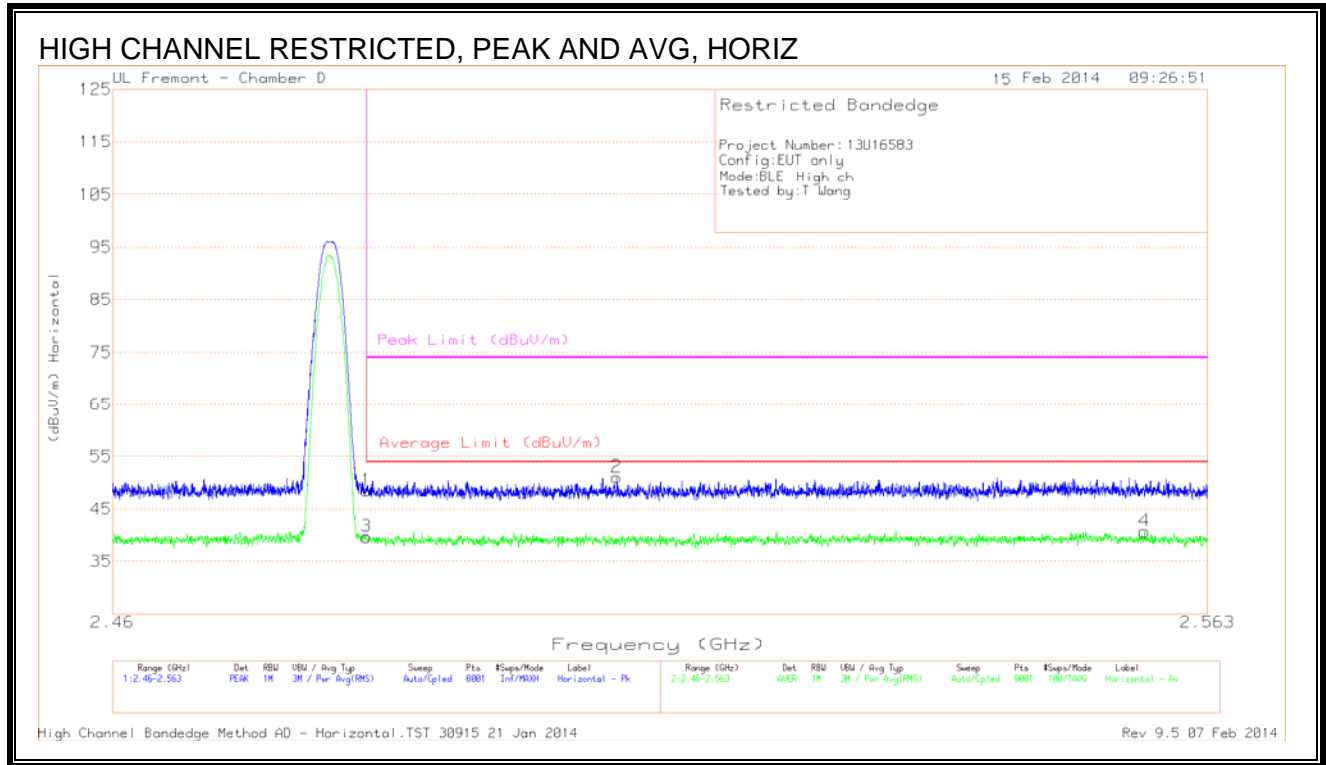

DATA

Marker	Frequency (GHz)	Meter Reading (dBuV)	Det	AF T712 (dB/m)	Amp/Cbl/Filtr/Pad (dB)	Corrected Reading (dBuV/m)	Average Limit (dBuV/m)	Margin (dB)	Peak Limit (dBuV/m)	PK Margin (dB)	Azimuth (Degs)	Height (cm)	Polarity
1	2.484	36.92	PK	32.1	-20.6	48.42	-	-	74	-25.58	360	110	H
2	2.507	39.46	PK	32.2	-20.6	51.06	-	-	74	-22.94	360	110	H
3	2.484	28.17	RMS	32.1	-20.6	39.67	54	-14.33	-	-	360	110	H
4	2.557	29.09	RMS	32.0	-20.4	40.69	54	-13.31	-	-	360	110	H

PK - Peak detector
 RMS - RMS detection

RESTRICTED BANDEDGE (HIGH CHANNEL, VERTICAL)

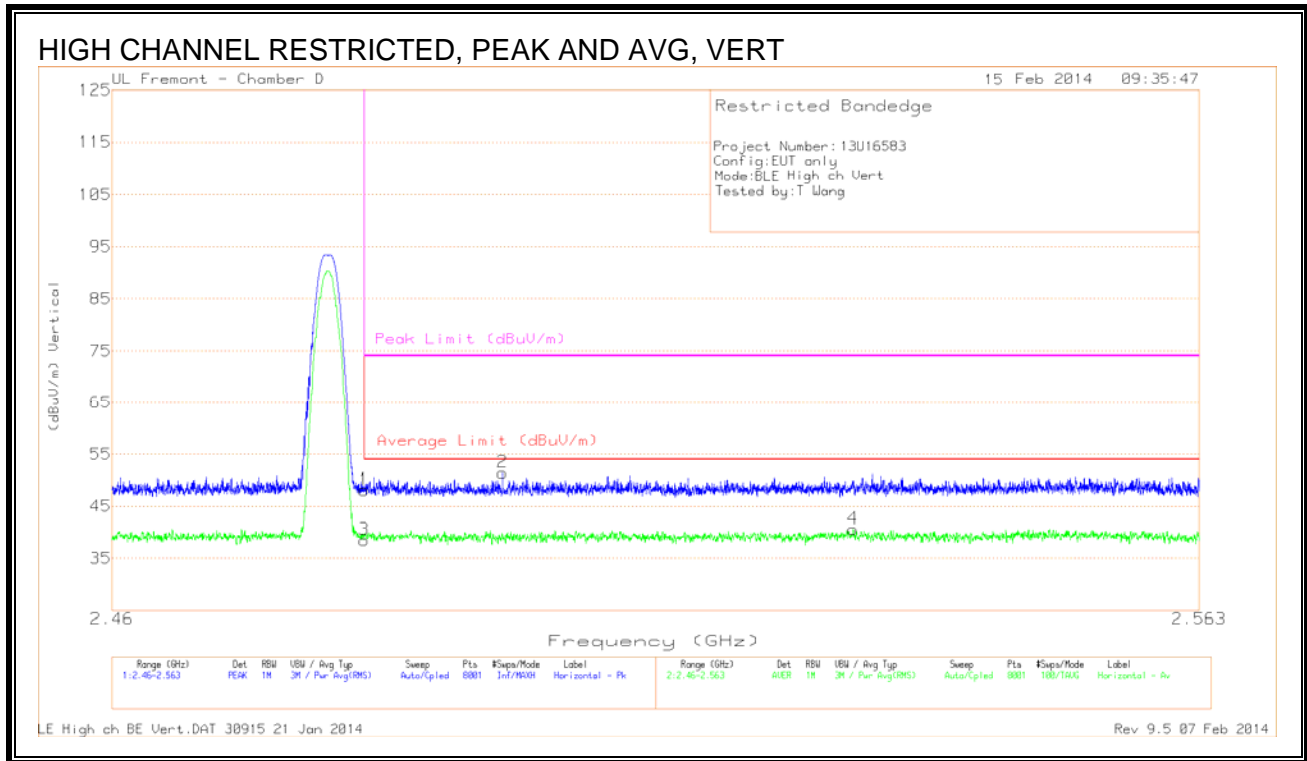

DATA

Marker	Frequency (GHz)	Meter Reading (dBuV)	Det	AF T712 (dB/m)	Amp/Cbl /Fitr/Pad (dB)	Corrected Reading (dBuV/m)	Average Limit (dBuV/m)	Margin (dB)	Peak Limit (dBuV/m)	PK Margin (dB)	Azimuth (Degs)	Height (cm)	Polarity
1	2.484	36.63	PK	32.1	-20.6	48.13	-	-	74	-25.87	241	372	V
2	2.497	40.06	PK	32.2	-20.8	51.46	-	-	74	-22.54	241	372	V
3	2.484	27.03	RMS	32.1	-20.6	38.53	54	-15.65	-	-	241	372	V
4	2.530	29.02	RMS	32.1	-20.5	40.62	54	-13.38	-	-	241	372	V

PK - Peak detector
 RMS - RMS detection

HARMONICS AND SPURIOUS EMISSION

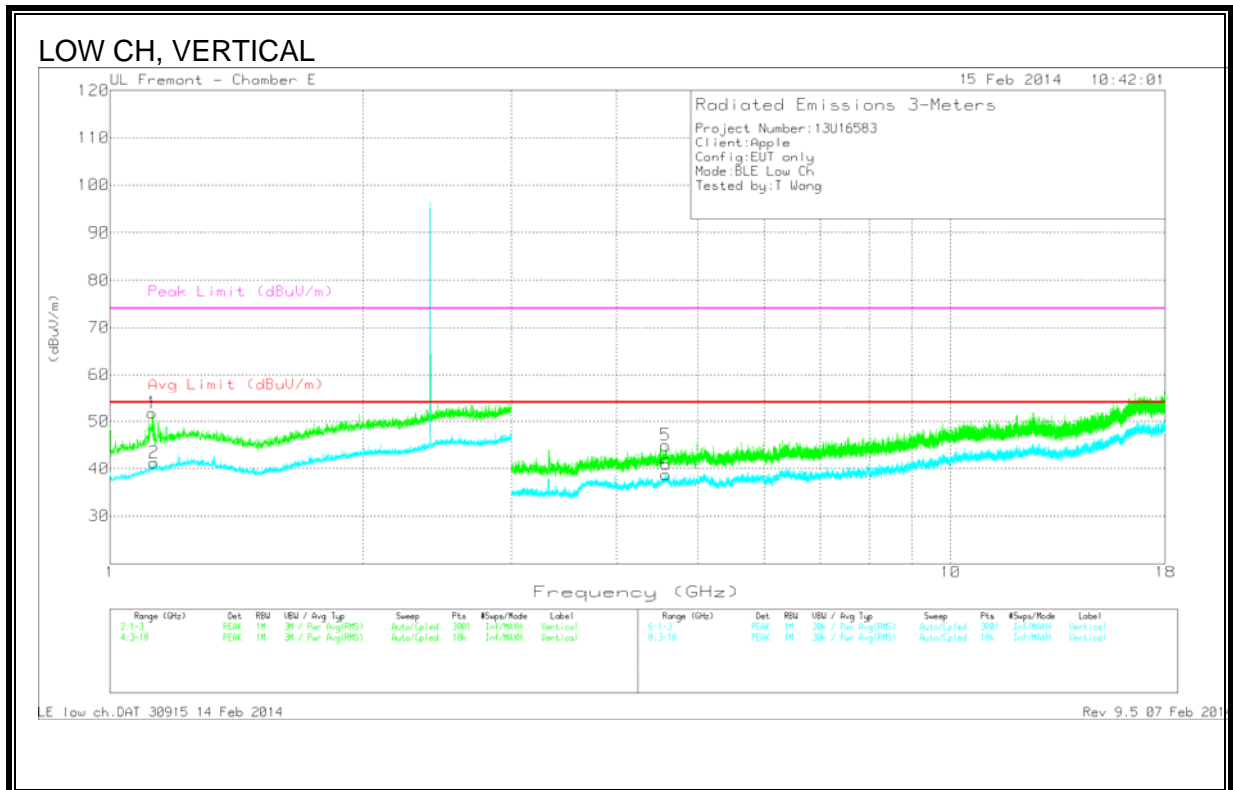
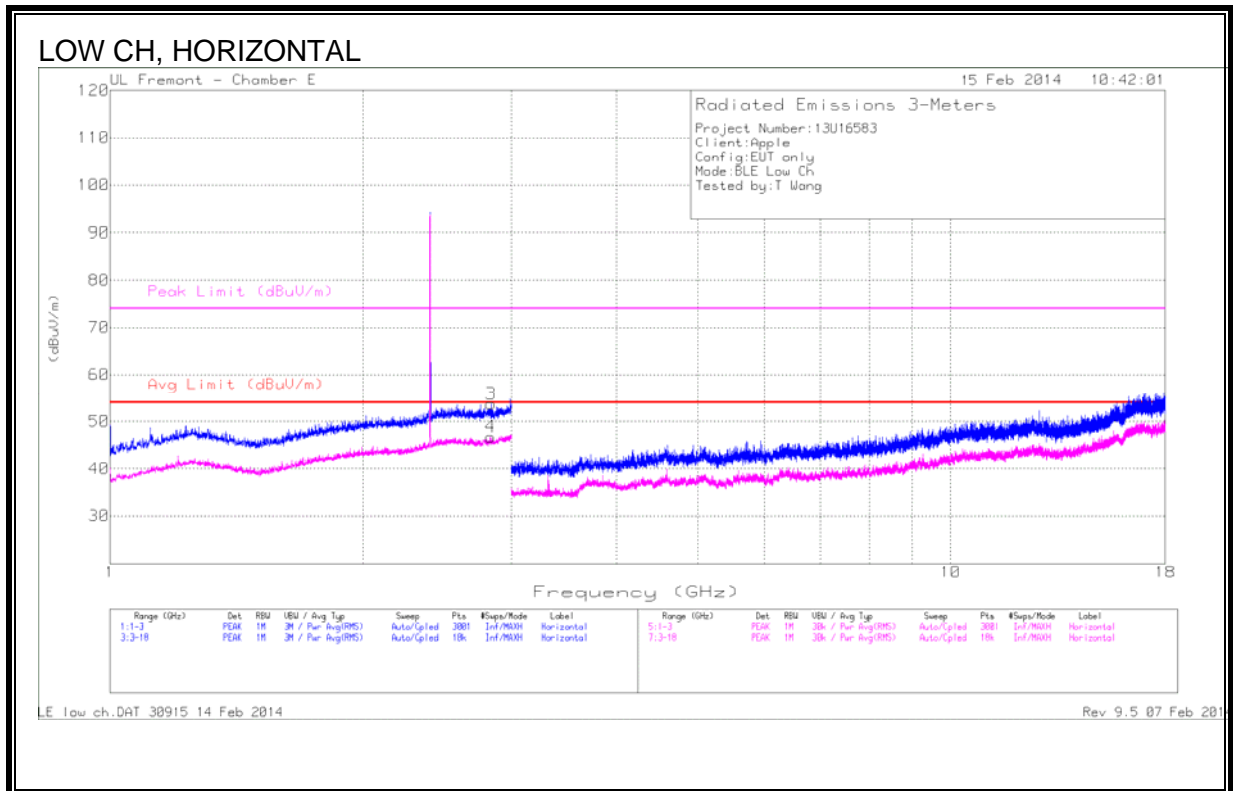

DATA

Marker	Frequency (GHz)	Meter Reading (dBuV)	Det	AF T711 (dB/m)	Amp/Cbl/ Fitr/Pad (dB)	Corrected Reading (dBuV/m)	Avg Limit (dBuV/m)	Margin (dB)	Peak Limit (dBuV/m)	PK Margin (dB)	Azimuth (Degs)	Height (cm)	Polarity
1	* 1.123	46.15	PK	27.8	-22.2	51.75	-	-	74	-22.25	0-360	100	V
2	* 1.123	35.65	Avg	27.9	-22.3	41.25	54	-12.75	-	-	0-360	100	V
3	* 2.839	41.94	PK	31.9	-20.1	53.74	-	-	74	-20.26	0-360	100	H
4	* 2.839	35.01	Avg	31.8	-20.1	46.71	54	-7.29	-	-	0-360	201	H
5	* 4.581	38.02	PK	33.5	-26.6	44.92	-	-	74	-29.08	0-360	100	V
6	* 4.581	31.86	Avg	33.5	-26.6	38.76	54	-15.24	-	-	0-360	201	V

* - indicates frequency in CFR15.205/IC7.2.2 Restricted Band

PK - Peak detector

Avg - Video bandwidth < Resolution bandwidth

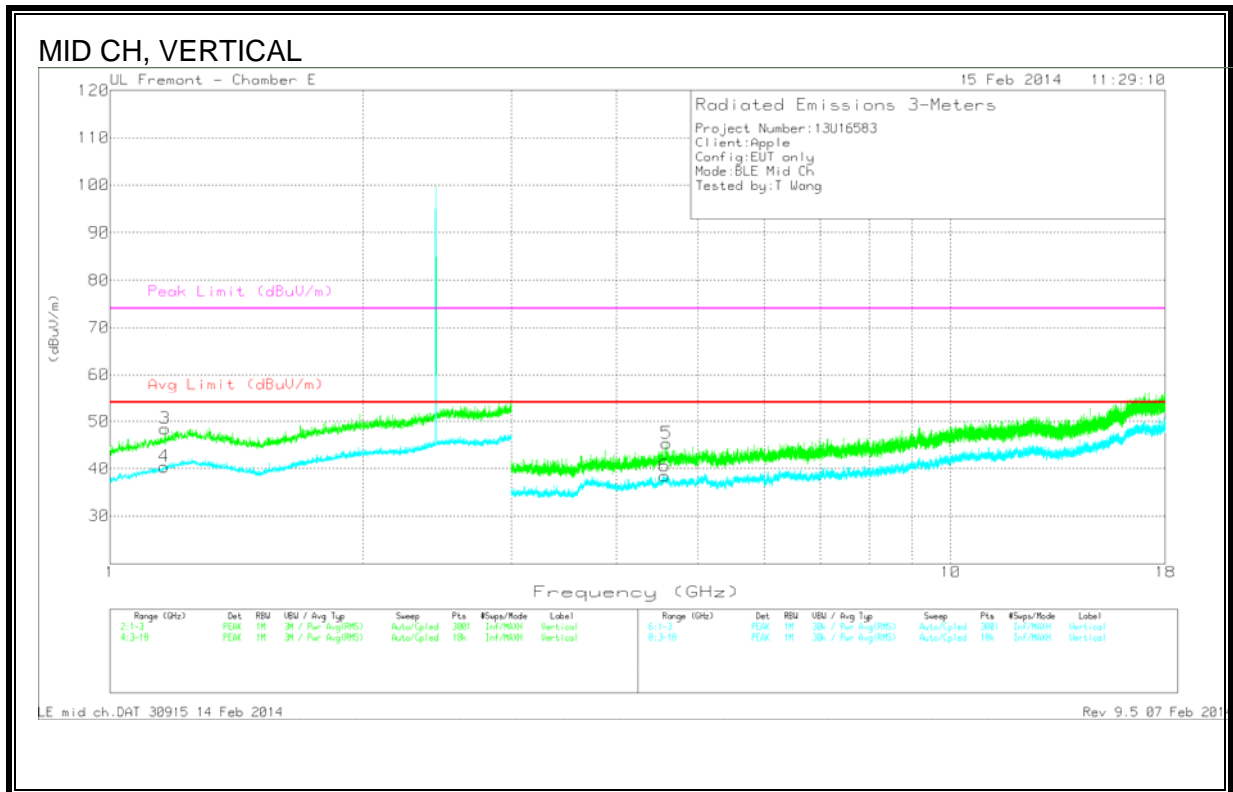
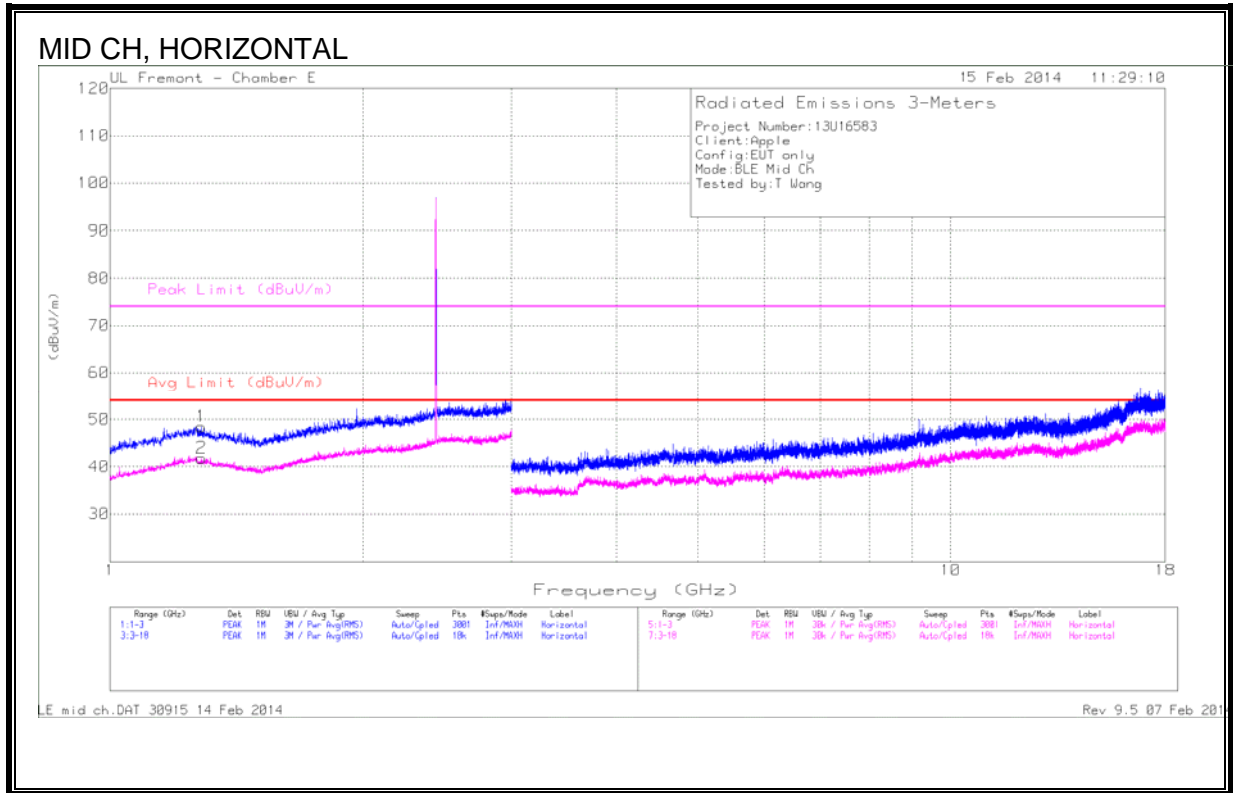

DATA

Marker	Frequency (GHz)	Meter Reading (dBuV)	Det	AF T712 (dB/m)	Amp/Cbl /Filtr/Pad (dB)	Corrected Reading (dBuV/m)	Avg Limit (dBuV/m)	Margin (dB)	Peak Limit (dBuV/m)	PK Margin (dB)	Azimuth (Degs)	Height (cm)	Polarity
1	* 1.284	41.37	PK	29.2	-22.1	48.47	-	-	74	-25.53	0-360	201	H
2	* 1.284	34.55	Avg	29.2	-22	41.75	54	-12.25	-	-	0-360	201	H
3	* 1.163	42.16	PK	28.4	-22.1	48.46	-	-	74	-25.54	0-360	100	V
4	* 1.163	34.21	Avg	28.3	-22.1	40.41	54	-13.59	-	-	0-360	201	V
5	* 4.592	38.56	PK	33.5	-26.7	45.36	-	-	74	-28.64	0-360	201	V
6	* 4.592	31.37	Avg	33.5	-26.4	38.47	54	-15.53	-	-	0-360	201	V

* - indicates frequency in CFR15.205/IC7.2.2 Restricted Band

PK - Peak detector

Avg - Video bandwidth < Resolution bandwidth

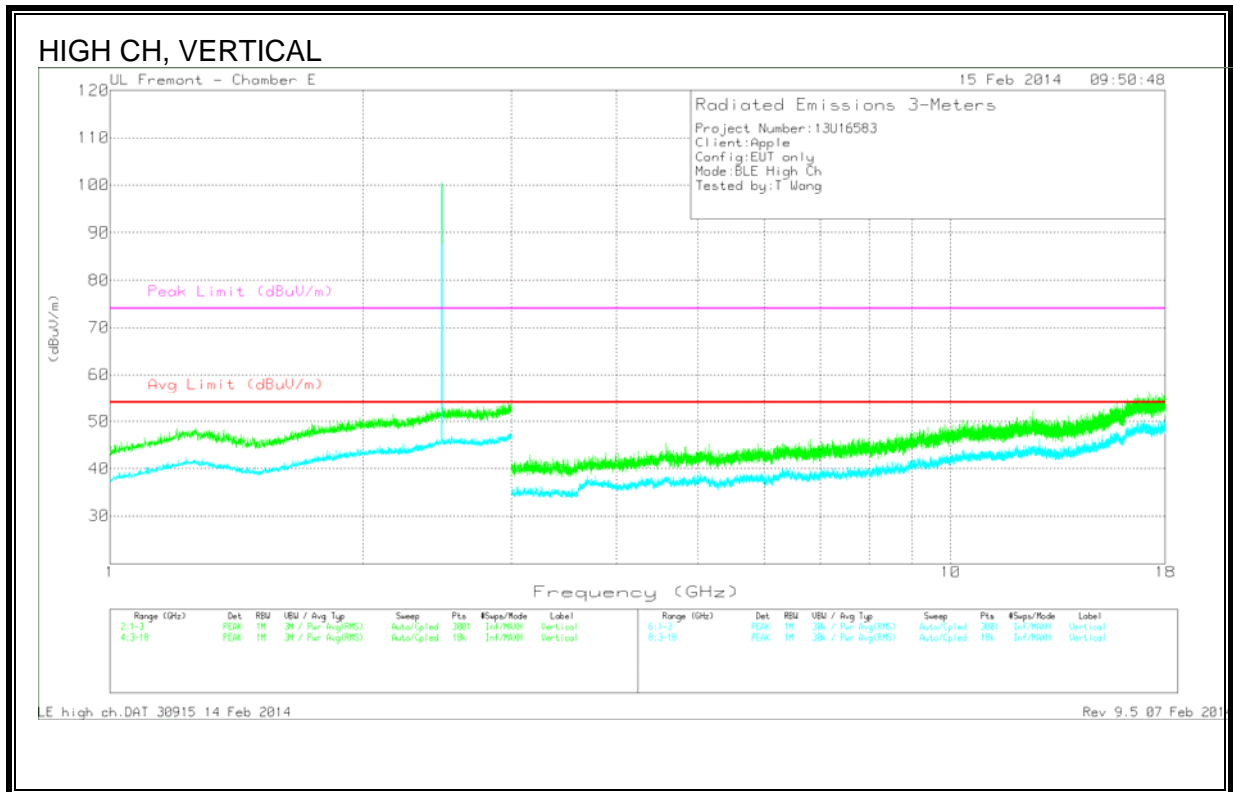
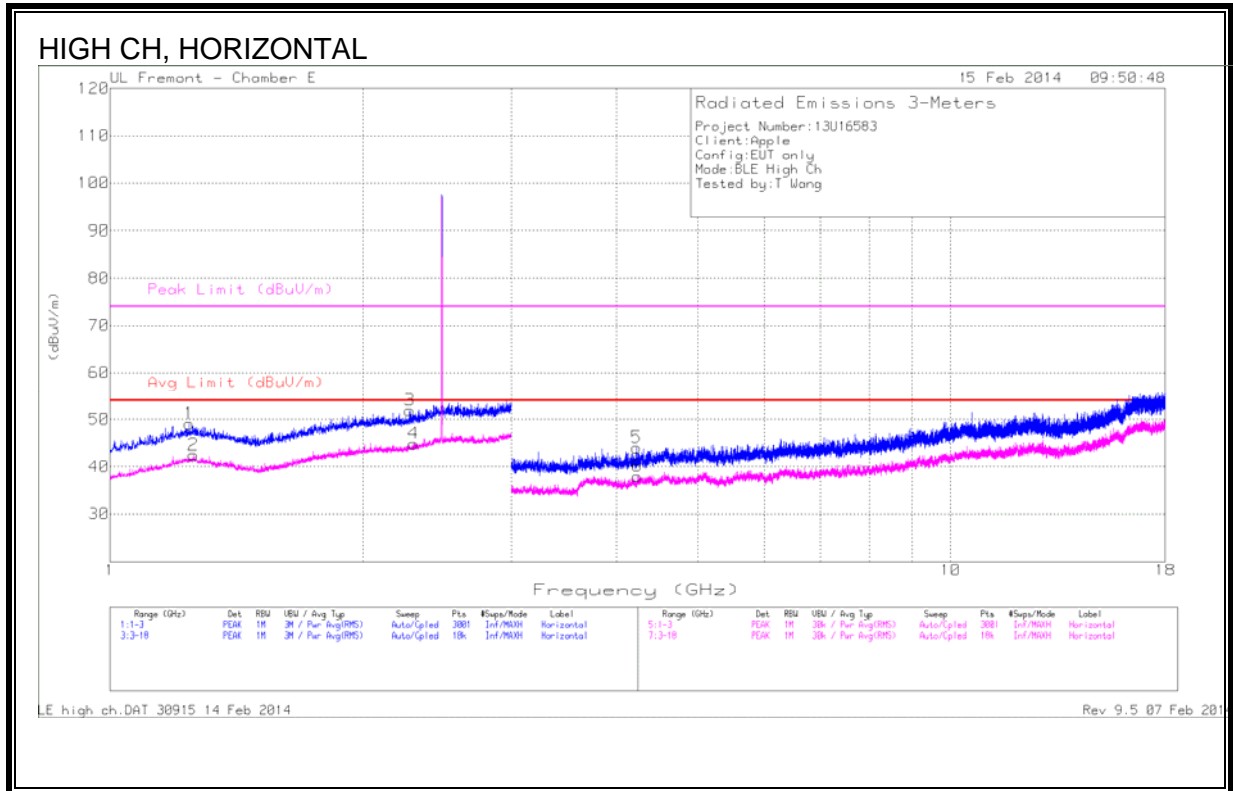

DATA

Marker	Frequency (GHz)	Meter Reading (dBuV)	Det	AF T712 (dB/m)	Amp/Cbl/Fltr/Pad (dB)	Corrected Reading (dBuV/m)	Avg Limit (dBuV/m)	Margin (dB)	Peak Limit (dBuV/m)	PK Margin (dB)	Azimuth (Degs)	Height (cm)	Polarity
1	* 1.242	41.65	PK	29.5	-22.1	49.05	-	-	74	-24.95	0-360	100	H
2	* 1.242	35.02	Avg	29.5	-22.1	42.42	54	-11.58	-	-	0-360	100	H
3	* 2.273	41.91	PK	30.7	-20.7	51.91	-	-	74	-22.09	0-360	100	H
4	* 2.273	34.78	Avg	30.9	-20.8	44.88	54	-9.12	-	-	0-360	100	H
5	* 4.229	39.3	PK	32.9	-28.2	44.00	-	-	74	-30.00	0-360	100	H
6	* 4.229	33.16	Avg	32.9	-28.1	37.96	54	-16.04	-	-	0-360	201	H

* - indicates frequency in CFR15.205/IC7.2.2 Restricted Band

PK - Peak detector

Avg - Video bandwidth < Resolution bandwidth

9.3. WORST-CASE ABOVE 18 GHz

SPURIOUS EMISSIONS 18 TO 26 GHz (WORST-CASE CONFIGURATION, HORIZONTAL & VERTICAL)

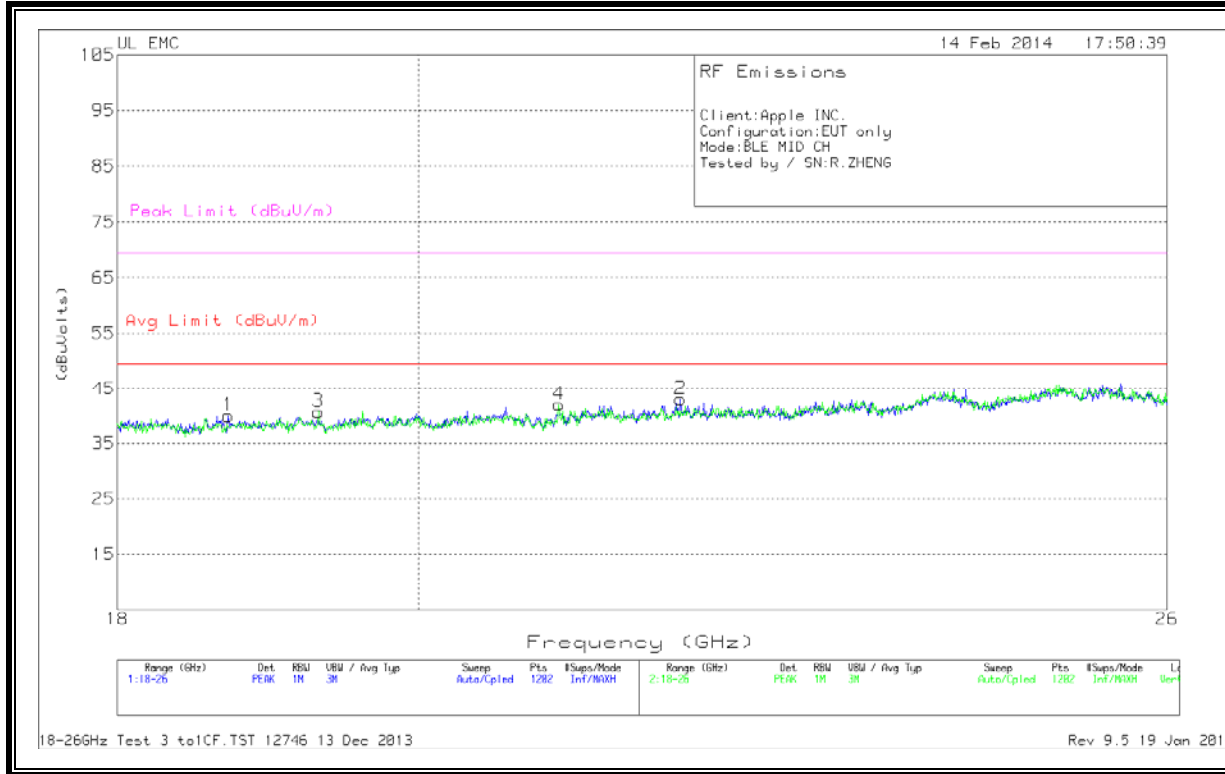

Marker	Frequency (GHz)	Meter Reading (dBuV)	Det	AF T89 (dB/m)	Amp/Cbl (dB)	Dist Corr (dB)	Corrected Reading (dBuVolts)	Avg Limit (dBuV/m)	Margin (dB)	Peak Limit (dBuV/m)	PK Margin (dB)
1	18.713	41.2	PK	32.5	-24.2	-9.5	40	49.5	-9.5	69.5	-29.5
2	21.923	43.2	PK	33.3	-24	-9.5	43	49.5	-6.5	69.5	-26.5
3	19.312	41.47	PK	32.5	-23.8	-9.5	40.67	49.5	-8.83	69.5	-28.83
4	21.011	42.3	PK	32.9	-23.7	-9.5	42	49.5	-7.5	69.5	-27.5

PK - Peak detector

9.4. WORST-CASE BELOW 1 GHz

SPURIOUS EMISSIONS 30 TO 1000 MHz (WORST-CASE CONFIGURATION, HORIZONTAL)

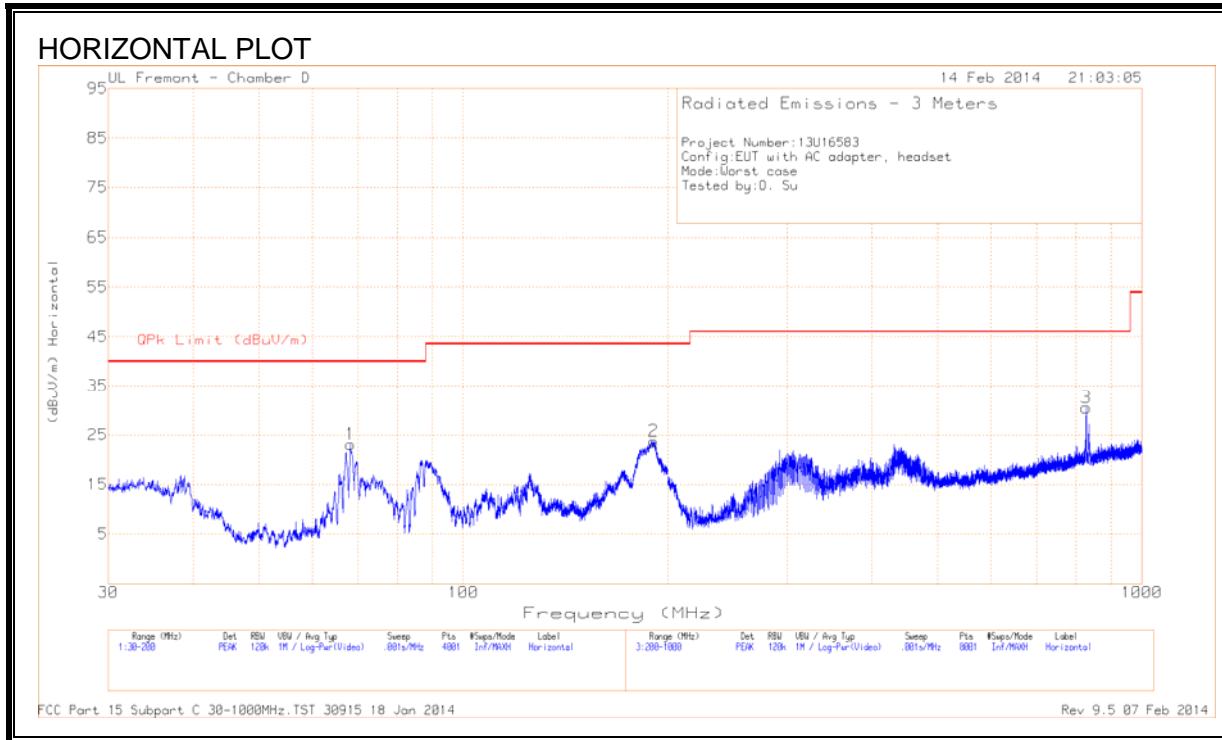

SPURIOUS EMISSIONS 30 TO 1000 MHz (WORST-CASE CONFIGURATION, VERTICAL)

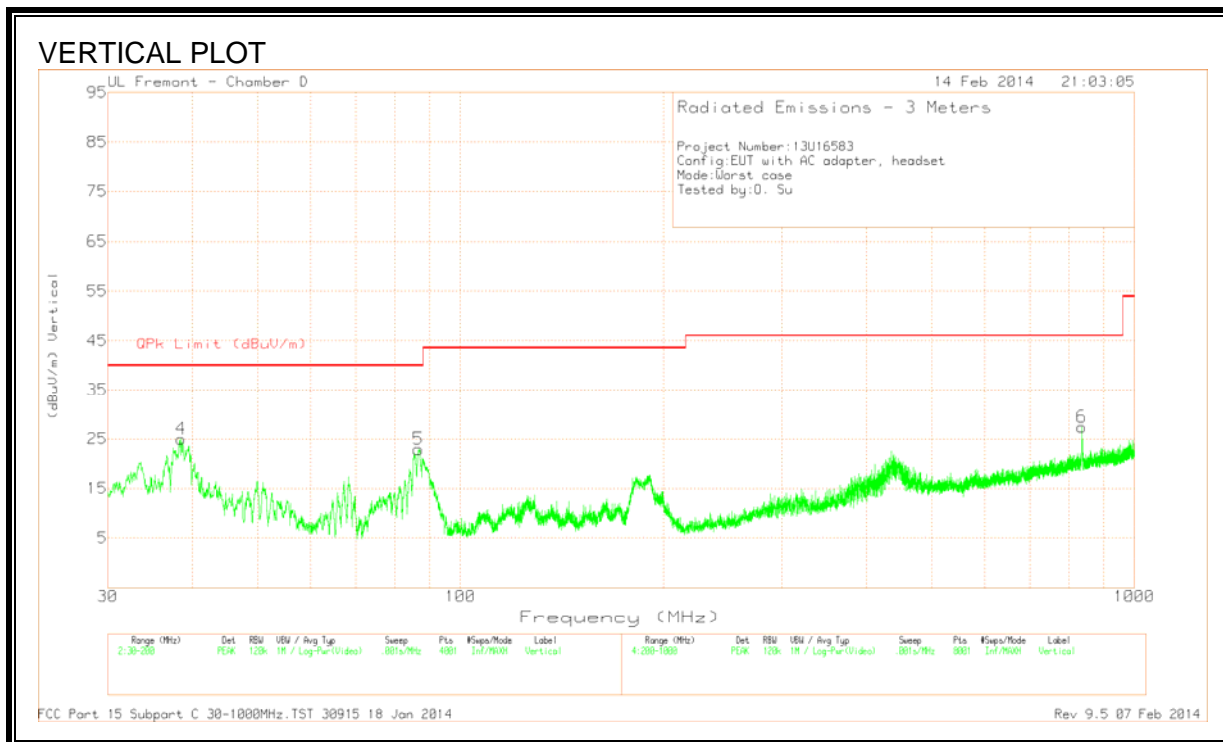

DATA

Marker	Frequency (MHz)	Meter Reading (dBuV)	Det	AF T407 dB/m	Amp/Cbl (dB)	Corrected Reading (dBuV/m)	QPk Limit (dBuV/m)	Margin (dB)	Azimuth (Degs)	Height (cm)	Polarity
1	68.2075	45.76	PK	8.2	-30.9	23.06	40	-16.94	0-360	200	H
2	190.735	43.09	PK	11.4	-30.8	23.69	43.52	-19.83	0-360	98	H
3	827.8	37.7	PK	21.6	-28.8	30.5	46.02	-15.52	0-360	300	H
4	38.5425	41.58	PK	15.1	-31.7	24.98	40	-15.02	0-360	100	V
5	86.6525	46.18	PK	7.7	-31	22.88	40	-17.12	0-360	100	V
6	835.6	34.79	PK	21.5	-28.9	27.39	46.02	-18.63	0-360	100	V

PK - Peak detector