



FCC 47 CFR PART 15 SUBPART E

**CERTIFICATION TEST REPORT
CLASS II PERMISSIVE CHANGE**

FOR

**Tablet with cellular GSM/GPRS/EGPRS/WCDMA/HSPA+/DC-HSDPA /CDMA 1xRTT
/1x Advanced/EV-DO Rev 0, A, B/LTE/IEEE 802.11a/b/g/n (MIMO 2x2) and
Bluetooth Radio**

MODEL NUMBER: A1490

FCC ID: BCGA1490

REPORT NUMBER: 15U21850-E30V2

ISSUE DATE: DECEMBER 02, 2015

Prepared for

**APPLE, INC.
1 INFINITE LOOP
CUPERTINO, CA 95014, U.S.A.**

Prepared by

**UL VERIFICATION SERVICES INC.
47173 BENICIA STREET
FREMONT, CA 94538, U.S.A.
TEL: (510) 771-1000
FAX: (510) 661-0888**



NVLAP LAB CODE 200065-0

Revision History

<u>Rev.</u>	<u>Issue Date</u>	<u>Revisions</u>	<u>Revised By</u>
V1	11/16/15	Initial issue. Upgrade 13U15668-6 report to 5.2/5.3/5.6GHz band to new rule per KDB 789033 D02 v01.	J. Vang
V2	12/02/15	Revised report to address TCB's questions	T. Chu

TABLE OF CONTENTS

1. ATTESTATION OF TEST RESULTS	7
2. TEST METHODOLOGY	8
3. FACILITIES AND ACCREDITATION	8
4. CALIBRATION AND UNCERTAINTY	8
4.1. <i>MEASURING INSTRUMENT CALIBRATION</i>	<i>8</i>
4.2. <i>SAMPLE CALCULATION</i>	<i>8</i>
4.3. <i>MEASUREMENT UNCERTAINTY.....</i>	<i>9</i>
5. EQUIPMENT UNDER TEST	9
5.1. <i>DESCRIPTION OF EUT</i>	<i>9</i>
5.2. <i>DESCRIPTION OF CLASS II PERMISSIVE CHANGE</i>	<i>9</i>
5.3. <i>MAXIMUM OUTPUT POWER.....</i>	<i>10</i>
5.4. <i>DESCRIPTION OF AVAILABLE ANTENNAS</i>	<i>11</i>
5.5. <i>SOFTWARE AND FIRMWARE.....</i>	<i>11</i>
5.6. <i>WORST-CASE CONFIGURATION AND MODE.....</i>	<i>11</i>
5.7. <i>DESCRIPTION OF TEST SETUP.....</i>	<i>12</i>
6. TEST AND MEASUREMENT EQUIPMENT	15
7. ON TIME, DUTY CYCLE AND MEASUREMENT METHODS	16
7.1. <i>ON TIME AND DUTY CYCLE RESULTS.....</i>	<i>16</i>
7.2. <i>MEASUREMENT METHOD FOR POWER AND PPSD.....</i>	<i>16</i>
7.3. <i>MEASUREMENT METHOD FOR AVERAGE SPURIOUS EMISSIONS ABOVE 1 GHz</i> 16	
7.4. <i>DUTY CYCLE PLOTS</i>	<i>17</i>
8. ANTENNA PORT TEST RESULTS	19
8.1. <i>802.11a SISO MODE IN THE 5.2 GHz BAND</i>	<i>19</i>
8.1.1. <i>26 dB BANDWIDTH.....</i>	<i>19</i>
8.1.2. <i>99% BANDWIDTH.....</i>	<i>22</i>
8.1.3. <i>AVERAGE POWER.....</i>	<i>25</i>
8.1.4. <i>OUTPUT POWER AND PSD</i>	<i>26</i>
8.2. <i>802.11n HT20 2TX CDD MODE IN THE 5.2 GHz BAND</i>	<i>30</i>
8.2.1. <i>26 dB BANDWIDTH.....</i>	<i>30</i>
8.2.2. <i>99% BANDWIDTH.....</i>	<i>34</i>
8.2.3. <i>AVERAGE POWER.....</i>	<i>38</i>
8.2.4. <i>OUTPUT POWER AND PPSD</i>	<i>39</i>
8.3. <i>802.11n SISO HT40 MODE IN THE 5.2 GHz BAND.....</i>	<i>45</i>
8.3.1. <i>26 dB BANDWIDTH.....</i>	<i>45</i>

8.3.2.	99% BANDWIDTH.....	47
8.3.3.	AVERAGE POWER.....	49
8.3.4.	OUTPUT POWER AND PPSD	50
8.4.	<i>802.11n HT40 2TX CDD MODE IN THE 5.2 GHz BAND</i>	53
8.4.1.	26 dB BANDWIDTH.....	53
8.4.2.	99% BANDWIDTH.....	56
8.4.3.	AVERAGE POWER.....	59
8.4.4.	OUTPUT POWER AND PPSD	60
8.5.	<i>802.11a SISO MODE IN THE 5.3 GHz BAND</i>	65
8.5.1.	26 dB BANDWIDTH.....	65
8.5.2.	99% BANDWIDTH.....	68
8.5.3.	AVERAGE POWER.....	71
8.5.4.	OUTPUT POWER AND PPSD	72
8.6.	<i>802.11n HT20 2TX CDD MODE IN THE 5.3 GHz BAND</i>	76
8.6.1.	26 dB BANDWIDTH.....	76
8.6.2.	99% BANDWIDTH.....	80
8.6.3.	AVERAGE POWER.....	84
8.6.4.	OUTPUT POWER AND PPSD	85
8.7.	<i>802.11n HT40 SISO MODE IN THE 5.3 GHz BAND</i>	90
8.7.1.	26 dB BANDWIDTH.....	90
8.7.2.	99% BANDWIDTH.....	92
8.7.3.	AVERAGE POWER.....	94
8.7.4.	OUTPUT POWER AND PPSD	95
8.8.	<i>802.11n 2TX HT40 CDD MODE IN THE 5.3 GHz BAND</i>	98
8.8.1.	26 dB BANDWIDTH.....	98
8.8.2.	99% BANDWIDTH.....	101
8.8.3.	AVERAGE POWER.....	104
8.8.4.	OUTPUT POWER AND PPSD	105
8.9.	<i>802.11a SISO MODE IN THE 5.6 GHz BAND</i>	109
8.9.1.	26 dB BANDWIDTH.....	109
8.9.2.	99% BANDWIDTH.....	112
8.9.3.	AVERAGE POWER.....	115
8.9.4.	OUTPUT POWER AND PPSD	116
8.10.	<i>802.11n HT20 2TX CDD MODE IN THE 5.6 GHz BAND</i>	120
8.10.1.	26 dB BANDWIDTH	120
8.10.2.	99% BANDWIDTH	124
8.10.3.	AVERAGE POWER	128
8.10.4.	OUTPUT POWER AND PPSD	129
8.11.	<i>802.11n HT40 SISO MODE IN THE 5.6 GHz BAND</i>	134
8.11.1.	26 dB BANDWIDTH	134
8.11.2.	99% BANDWIDTH	137
8.11.3.	AVERAGE POWER	140
8.11.4.	OUTPUT POWER AND PPSD	141
8.12.	<i>802.11n 2TX HT40 CDD MODE IN THE 5.6 GHz BAND</i>	145
8.12.1.	26 dB BANDWIDTH	145
8.12.2.	99% BANDWIDTH	149
8.12.3.	AVERAGE POWER	153
8.12.4.	OUTPUT POWER AND PPSD	154

9. RADIATED TEST RESULTS.....159

9.1. *LIMITS AND PROCEDURE..... 159*

9.2. *TRANSMITTER ABOVE 1 GHz..... 160*

9.2.1. TX ABOVE 1 GHz 802.11a MODE IN THE 5.2 GHz BAND160

9.2.2. TX ABOVE 1 GHz 802.11n HT20 2TX CDD MODE IN THE 5.2 GHz BAND168

9.2.3. TX ABOVE 1 GHz 802.11n HT40 MODE IN THE 5.2 GHz BAND.....176

9.2.4. TX ABOVE 1 GHz 802.11n HT40 2TX CDD MODE IN THE 5.2 GHz BAND182

9.2.5. TX ABOVE 1 GHz 802.11a MODE IN THE 5.3 GHz BAND188

9.2.6. TX ABOVE 1 GHz 802.11n HT20 2TX CDD MODE IN THE 5.3 GHz BAND196

9.2.7. TX ABOVE 1 GHz 802.11n HT40 MODE IN THE 5.3 GHz BAND.....204

9.2.8. TX ABOVE 1 GHz 802.11n HT40 2TX CDD MODE IN THE 5.3 GHz BAND210

9.2.9. TX ABOVE 1 GHz 802.11a MODE IN THE 5.6 GHz BAND216

9.2.10. TX ABOVE 1 GHz 802.11n HT20 2TX CDD MODE IN THE 5.6 GHz BAND ..225

9.2.11. TX ABOVE 1 GHz 802.11n HT40 MODE IN THE 5.6 GHz BAND234

9.2.12. TX ABOVE 1 GHz 802.11n HT40 2TX CDD MODE IN THE 5.6 GHz BAND ..243

9.2.13. WORST-CASE 2.4GHZ & 5GHZ BAND CO-LOCATION.....252

9.3. *WORST-CASE ABOVE 18 GHz.....255*

9.4. *WORST-CASE BELOW 1 GHz.....261*

10. AC POWER LINE CONDUCTED EMISSIONS263

11. DYNAMIC FREQUENCY SELECTION268

11.1. *OVERVIEW.....268*

11.1.1. LIMITS268

11.1.2. TEST AND MEASUREMENT SYSTEM271

11.1.3. SETUP OF EUT (CLIENT MODE).....274

11.1.4. SETUP OF EUT (CLIENT-TO-CLIENT COMMUNICATIONS MODE)275

11.1.5. DESCRIPTION OF EUT.....276

11.2. *CLIENT MODE RESULTS FOR 20 MHz BANDWIDTH.....278*

11.2.1. TEST CHANNEL.....278

11.2.2. RADAR WAVEFORM AND TRAFFIC278

11.2.3. OVERLAPPING CHANNEL TESTS280

11.2.4. MOVE AND CLOSING TIME.....280

11.3. *CLIENT MODE RESULTS FOR 40 MHz BANDWIDTH.....285*

11.3.1. TEST CHANNEL.....285

11.3.2. RADAR WAVEFORM AND TRAFFIC285

11.3.3. OVERLAPPING CHANNEL TESTS287

11.3.4. MOVE AND CLOSING TIME.....287

11.3.5. NON-OCCUPANCY PERIOD.....292

11.4. *CLIENT-TO-CLIENT COMMUNICATIONS MODE RESULTS FOR 20 MHz BANDWIDTH.....293*

11.4.1. TEST CHANNEL.....293

11.4.2. RADAR WAVEFORM AND TRAFFIC293

11.4.3. OVERLAPPING CHANNEL TESTS295

11.4.4. MOVE AND CLOSING TIME.....295

11.5. *CLIENT-TO-CLIENT COMMUNICATIONS MODE RESULTS FOR 40 MHz BANDWIDTH.....300*

11.5.1. TEST CHANNEL.....300

11.5.2.	RADAR WAVEFORM AND TRAFFIC	300
11.5.3.	OVERLAPPING CHANNEL TESTS	302
11.5.4.	MOVE AND CLOSING TIME.....	302
12.	SETUP PHOTOS	307
12.1.	ANTENNA PORT CONDUCTED RF MEASUREMENT SETUP	307
12.2.	RADIATED RF MEASUREMENT SETUP (BELOW 1 GHz)	308
12.3.	RADIATED RF MEASUREMENT SETUP FOR PORTABLE CONFIGURATION ..	309
12.4.	POWERLINE CONDUCTED EMISSIONS MEASUREMENT SETUP	311
12.5.	DYNAMIC FREQUENCY SELECTION MEASUREMENT SETUP	312

1. ATTESTATION OF TEST RESULTS

COMPANY NAME: APPLE, INC.
1 INFINITE LOOP
CUPERTINO, CA 95014, U.S.A.

EUT DESCRIPTION: Tablet with cellular GSM/GPRS/EGPRS/WCDMA/HSPA+/DC-HSDPA/CDMA1xRTT/1x Advanced/EV-DO Rev 0, A, B/LTE/IEEE 802.11a/b/g/n (MIMO 2x2) and Bluetooth radio

MODEL: A1490

SERIAL NUMBER: DLXL1035FN7N (DFS), DLXL106FFMNK

DATE TESTED: JULY 09 to SEPTEMBER 17, 2013

APPLICABLE STANDARDS	
STANDARD	TEST RESULTS
CFR 47 Part 15 Subpart E	Pass

UL Verification Services Inc. tested the above equipment in accordance with the requirements set forth in the above standards. All indications of Pass/Fail in this report are opinions expressed by UL Verification Services Inc. based on interpretations and/or observations of test results. Measurement Uncertainties were not taken into account and are published for informational purposes only. The test results show that the equipment tested is capable of demonstrating compliance with the requirements as documented in this report.

Note: The results documented in this report apply only to the tested sample, under the conditions and modes of operation as described herein. This document may not be altered or revised in any way unless done so by UL Verification Services Inc. and all revisions are duly noted in the revisions section. Any alteration of this document not carried out by UL Verification Services Inc. will constitute fraud and shall nullify the document. This report must not be used by the client to claim product certification, approval, or endorsement by NVLAP, NIST, any agency of the Federal Government, or any agency of any government.

Approved & Released For
UL Verification Services Inc. By:



Thu Chan
WiSE Operations Manager
UL Verification Services Inc.

Tested By:



Tom Chen
WiSE Engineer
UL Verification Services Inc.

2. TEST METHODOLOGY

The tests documented in this report were performed in accordance with FCC CFR 47 Part 2, FCC CFR 47 Part 15, FCC 14-30, FCC KDB 662911 D01 v02r01, FCC KDB 905462 D02 v01r02/D03 v01r01/D06 v01, FCC KDB 789033 D02 v01, ANSI C63.10-2009.

3. FACILITIES AND ACCREDITATION

The test sites and measurement facilities used to collect data are located at 47173 and 47266 Benicia Street, Fremont, California, USA. Line conducted emissions are measured only at the 47173 address. The following table identifies which facilities were utilized for radiated emission measurements documented in this report. Specific facilities are also identified in the test results sections.

47173 Benicia Street	47266 Benicia Street
<input type="checkbox"/> Chamber A	<input checked="" type="checkbox"/> Chamber D
<input type="checkbox"/> Chamber B	<input checked="" type="checkbox"/> Chamber E
<input type="checkbox"/> Chamber C	<input checked="" type="checkbox"/> Chamber F

UL Verification Services Inc. is accredited by NVLAP, Laboratory Code 200065-0. The full scope of accreditation can be viewed at <http://ts.nist.gov/standards/scopes/2000650.htm>.

4. CALIBRATION AND UNCERTAINTY

4.1. MEASURING INSTRUMENT CALIBRATION

The measuring equipment utilized to perform the tests documented in this report has been calibrated in accordance with the manufacturer's recommendations, and is traceable to recognized national standards.

4.2. SAMPLE CALCULATION

Where relevant, the following sample calculation is provided:

$$\begin{aligned} \text{Field Strength (dBuV/m)} &= \text{Measured Voltage (dBuV)} + \text{Antenna Factor (dB/m)} + \\ &\text{Cable Loss (dB)} - \text{Preamp Gain (dB)} \\ 36.5 \text{ dBuV} + 18.7 \text{ dB/m} + 0.6 \text{ dB} - 26.9 \text{ dB} &= 28.9 \text{ dBuV/m} \end{aligned}$$

4.3. MEASUREMENT UNCERTAINTY

Where relevant, the following measurement uncertainty levels have been estimated for tests performed on the apparatus:

PARAMETER	UNCERTAINTY
Conducted Disturbance, 0.15 to 30 MHz	3.52 dB
Radiated Disturbance, 30 to 1000 MHz	4.94 dB

Uncertainty figures are valid to a confidence level of 95%.

5. EQUIPMENT UNDER TEST

5.1. DESCRIPTION OF EUT

The Apple iPad Model A1490 is a Tablet with cellular GSM/GPRS/EGPRS/WCDMA/HSPA+ DC-HSDPA/ CDMA 1xRTT/1x Advanced/EV-DO Rev 0, A, B/LTE/IEEE 802.11a/b/g/n (MIMO 2x2) and Bluetooth radio.

5.2. DESCRIPTION OF CLASS II PERMISSIVE CHANGE

Upgrade 5.2/5.3/5.6GHz band to new rule per KDB 789033 D02 v01.

We have reviewed the original test report for UNII-1, UNII-2A and UNII-2C bands and are hereby attesting that all current technical requirements are still met and all applicable test procedures remain the same. Therefore, the original report is still applicable and no additional testing is done.

We updated the following on this report:

- Updated report to latest KDB 789033 D02 v01.
- 5.2G output power table limit/PPSD limit.
- Removed IC related information.
- Removed Peak Excursion.

5.3. MAXIMUM OUTPUT POWER

The transmitter has a maximum conducted peak output power as follows:

Frequency Range (MHz)	Mode	Output Power (dBm)	Output Power (mW)
5180 - 5240	802.11a SISO	14.17	26.12
5180 - 5240	802.11n HT20 2Tx CDD	14.33	27.10
5190 - 5230	802.11n HT40 SISO	16.36	43.25
5190 - 5230	802.11n HT40 2Tx CDD	16.64	46.13
5260 - 5320	802.11a SISO	16.15	41.21
5260 - 5320	802.11n HT20 2Tx CDD	19.14	82.04
5270 - 5310	802.11n HT40 SISO	16.12	40.93
5270 - 5310	802.11n HT40 2Tx CDD	19.22	83.56
5500 - 5700	802.11a SISO	15.11	32.43
5500 - 5700	802.11n HT20 2Tx CDD	18.11	64.71
5510 - 5670	802.11n HT40 SISO	15.20	33.11
5510 - 5670	802.11n HT40 2Tx CDD	18.17	65.61

List of test reduction and modes covering other modes:

RF Conducted and Radiated Testing		
Frequency Range (MHz)	Mode	Covered by
5.2 GHz band, 1TX		
5180 - 5240	802.11n SISO	802.11a SISO
5.2 GHz band, 2TX		
5180 - 5240	802.11a 2TX CDD	802.11n HT20 CDD 2TX
5180 - 5240	802.11n HT20 2TX STBC/SDM	802.11n HT20 CDD 2TX
5190 - 5230	802.11n HT40 2TX STBC/SDM	802.11n HT40 CDD 2TX
5.3 GHz band, SISO		
5260 - 5320	802.11n SISO	802.11a SISO
5.3 GHz band, 2TX		
5260 - 5320	802.11a 2TX CDD	802.11n HT20 CDD 2TX
5260 - 5320	802.11n HT20 2TX STBC/SDM	802.11n HT20 CDD 2TX
5270 - 5310	802.11n HT40 2TX STBC/SDM	802.11n HT40 CDD 2TX
5.6GHz Band 2TX		
5500 - 5700	802.11a 2TX CDD	802.11n HT20 CDD 2TX
5500 - 5700	802.11n SISO	802.11a SISO
5500 - 5700	802.11n HT20 2TX STBC/SDM	802.11n HT20 CDD 2TX
5510 - 5670	802.11n HT40 2TX STBC/SDM	802.11n HT40 CDD 2TX

5.4. DESCRIPTION OF AVAILABLE ANTENNAS

Frequency Band (GHz)	Antenna Gain		Uncorrelated Gain	Correlated Gain
	Tx1	Tx2		
2.4	0.81	-1.86	-0.32	2.59
5.2	-0.02	3.06	1.79	4.67
5.3	0.75	3.25	2.18	5.10
5.5	2.43	4.29	3.46	6.42
5.8	2.68	3.76	3.25	6.25

5.5. SOFTWARE AND FIRMWARE

The test utility software used during testing was Broadcom WL Tool Version 6.25.86.

5.6. WORST-CASE CONFIGURATION AND MODE

There are two vendors of the WiFi/Bluetooth radio modules: BOM #1, vender1 and BOM #2, vender 2, and they have the same mechanical outline, same on board antenna, matching circuit, antenna structure and same specification and baseline was performed on both vendors to determine the worst case on conducted power and radiated emissions.

The fundamental of the EUT was investigated in three orthogonal orientations X, Y, Z, it was determined that Z orientation was worst-case orientation for 5GHz; therefore, all final radiated testing was performed with the EUT in Z orientation for 5GHz.

Worst-case data rates as provided by the client were:

802.11a mode: 6 Mbps
 802.11n HT20mode: MCS0
 802.11n HT40mode: MCS0

Worst-case mode and channel used for 30-1000 MHz radiated and power line conducted emissions was including headset, AC charger and the mode and channel with the highest output power.

For all modes with single chain, chain 0 was selected per the software provided by the client. Based on the client a preliminary investigation was performed on the two chains and chain 0 was found to be worst-case for the antenna port. The radiated emissions test was based on the port with the higher antenna gain.

5.7. DESCRIPTION OF TEST SETUP

SUPPORT EQUIPMENT

Support Equipment List				
Description	Manufacturer	Model	Serial Number	FCC ID
AC/DC Adapter	Apple	A1357	A/12981EA	DoC
Earphone	Apple	NA	NA	NA

I/O CABLES (CONDUCTED TEST)

I/O Cable List						
Cable No	Port	# of identical ports	Connector Type	Cable Type	Cable Length (m)	Remarks
1	Antenna	1	SMA	Un-Shielded	0.1m	To Spectrum Analyzer

I/O CABLES (RADIATED TEST)

I/O Cable List						
Cable No	Port	# of identical ports	Connector Type	Cable Type	Cable Length (m)	Remarks
1	Audio	1	Jack	Un-Shielded	0.5m	NA

I/O CABLES (AC POWER CONDUCTED TEST)

I/O Cable List						
Cable No	Port	# of identical ports	Connector Type	Cable Type	Cable Length (m)	Remarks
1	AC	1	US115	Un-Shielded	2m	NA
2	DC	1	USB	Un-Shielded	2m	NA
3	Audio	1	Jack	Un-Shielded	0.5m	NA

SETUP DIAGRAM FOR CONDUCTED TESTS

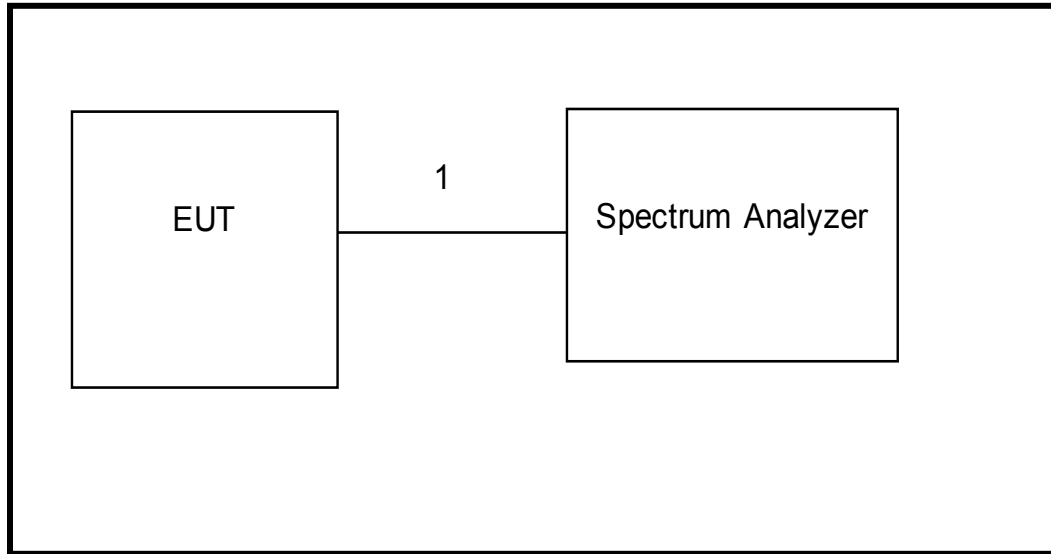

SETUP DIAGRAM FOR RADIATED TESTS

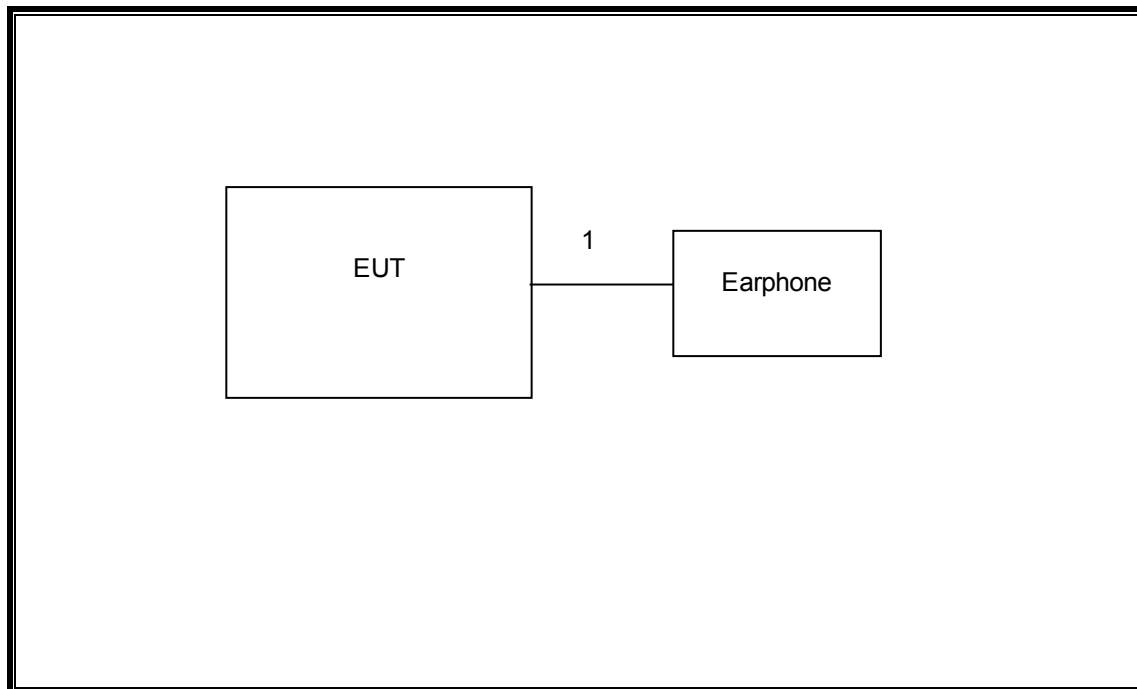

SETUP DIAGRAM FOR BELOW 1GHZ & AC POWER CONDUCTED TESTS

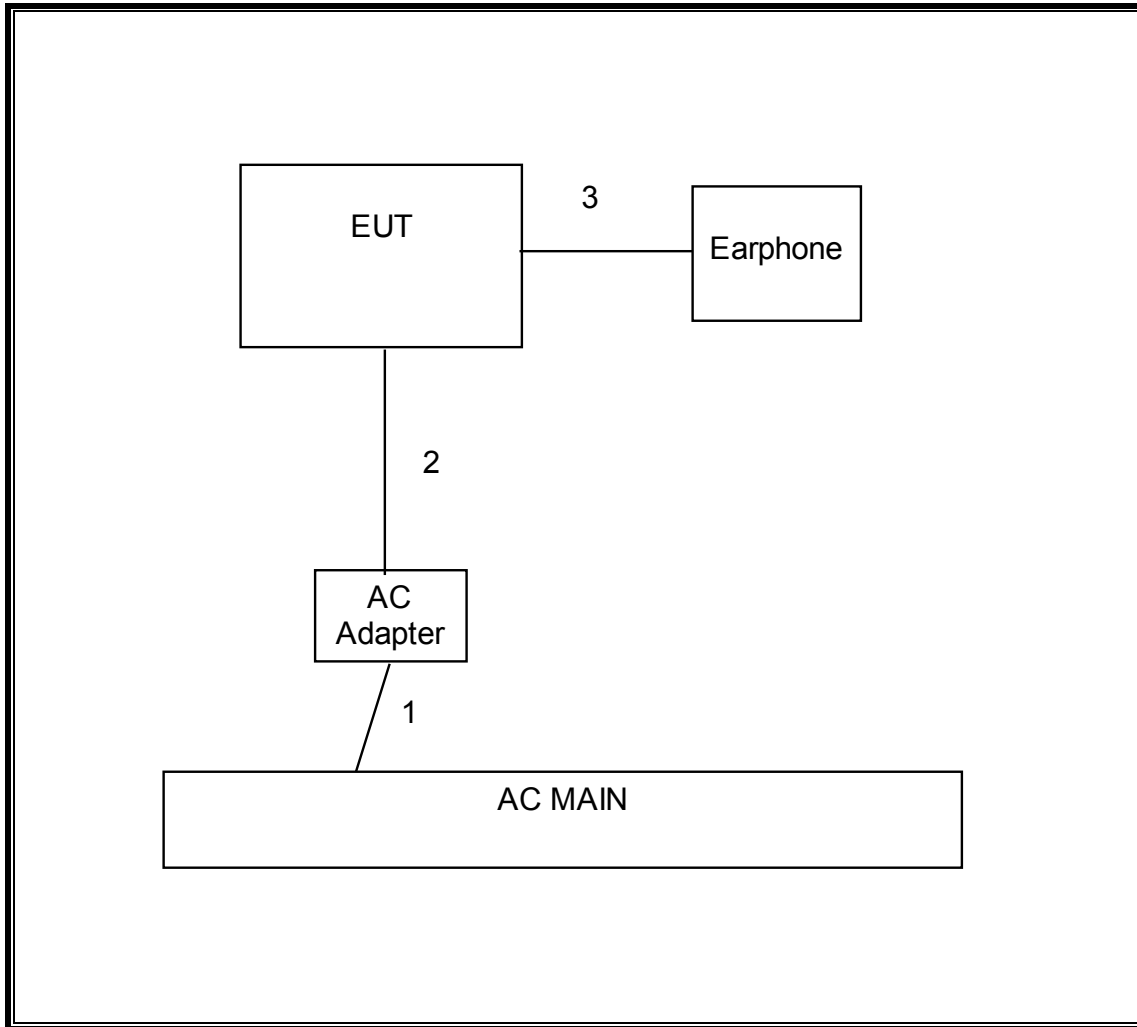

6. TEST AND MEASUREMENT EQUIPMENT

The following test and measurement equipment was utilized for the tests documented in this report:

Test Equipment List				
Description	Manufacturer	Model	Asset	Cal Due
Horn Antenna 1-18GHz	ETS Lindgren	3117	F00131	02/19/14
Preamplifier, 1300 MHz	Agilent / HP	8447D	C00580	01/28/14
Antenna, Horn, 26.5 GHz	ARA	SWH-28	C01015	05/06/14
Antenna, Biconolog, 30MHz-1 GHz	Sunol Sciences	JB3	F00027	03/07/14
Peak / Average Power Sensor	Agilent / HP	E9323A	F00163	04/03/14
P-Series single channel Power Meter	Agilent / HP	N1911A	F00164	04/03/14
Spectrum Analyzer, 3Hz-44GHz	Agilent	N9030A	F00127	02/22/14
Spectrum Analyzer, 3Hz-44GHz	Agilent	E4446A	C01012	10/21/13
PreApmplifier, 1-26.5GHz	Agilent	8449B	C01052	10/22/13
Antenna, Horn, 40 GHz	ARA	MWH-2640/B	F00194	05/14/14
EMI Test Receiver, 30 MHz	R & S	ESHS 20	N02396	08/15/14
Preamplifier, 40 GHz	Miteq	NSP4000-SP2	C00990	08/20/14

7. ON TIME, DUTY CYCLE AND MEASUREMENT METHODS

LIMITS

None; for reporting purposes only.

PROCEDURE

KDB 789033 Zero-Span Spectrum Analyzer Method.

7.1. ON TIME AND DUTY CYCLE RESULTS

Mode	ON Time B (msec)	Period (msec)	Duty Cycle x (linear)	Duty Cycle (%)	Duty Cycle Correction Factor (dB)	1/T Minimum VBW (kHz)
802.11a 20 MHz	2.06	2.09	0.986	98.6%	0.00	0.010
802.11n HT20	1.91	1.94	0.986	98.6%	0.00	0.010
802.11n HT40	0.93	0.95	0.983	98.3%	0.00	0.010

7.2. MEASUREMENT METHOD FOR POWER AND PPSD

The Duty Cycle is greater than or equal to 98% therefore KDB 789033 Method SA-1 is used.

The Duty Cycle is greater than or equal to 98% therefore KDB 789033 Method SA-1 Alternative is used.

7.3. MEASUREMENT METHOD FOR AVERAGE SPURIOUS EMISSIONS ABOVE 1 GHz

The Duty Cycle is greater than or equal to 98%, KDB 789033 Method AD with Power RMS Averaging is used.

7.4. DUTY CYCLE PLOTS

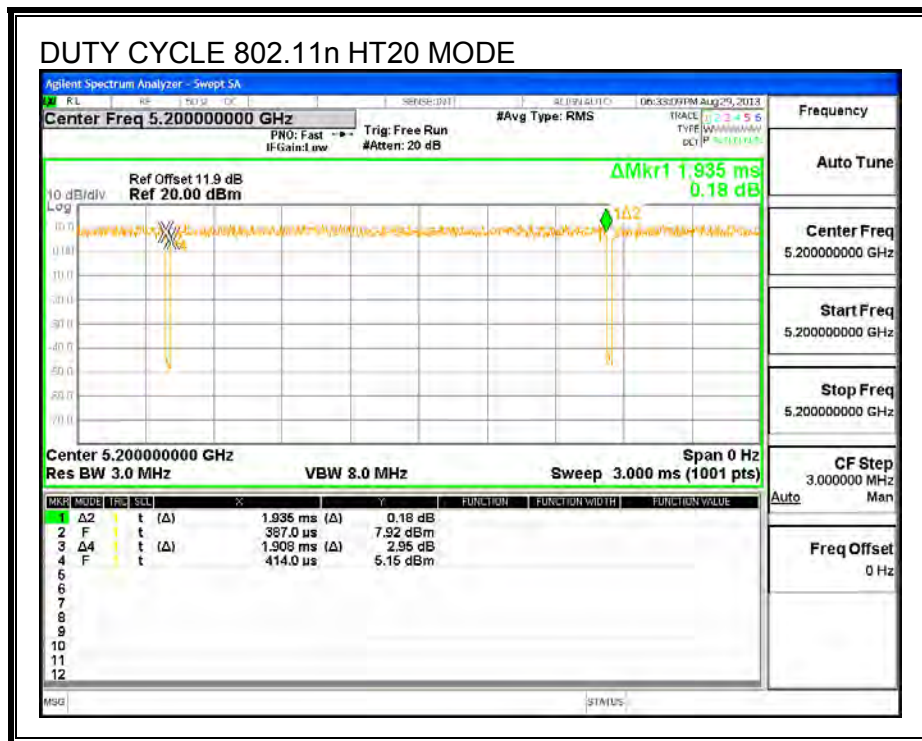
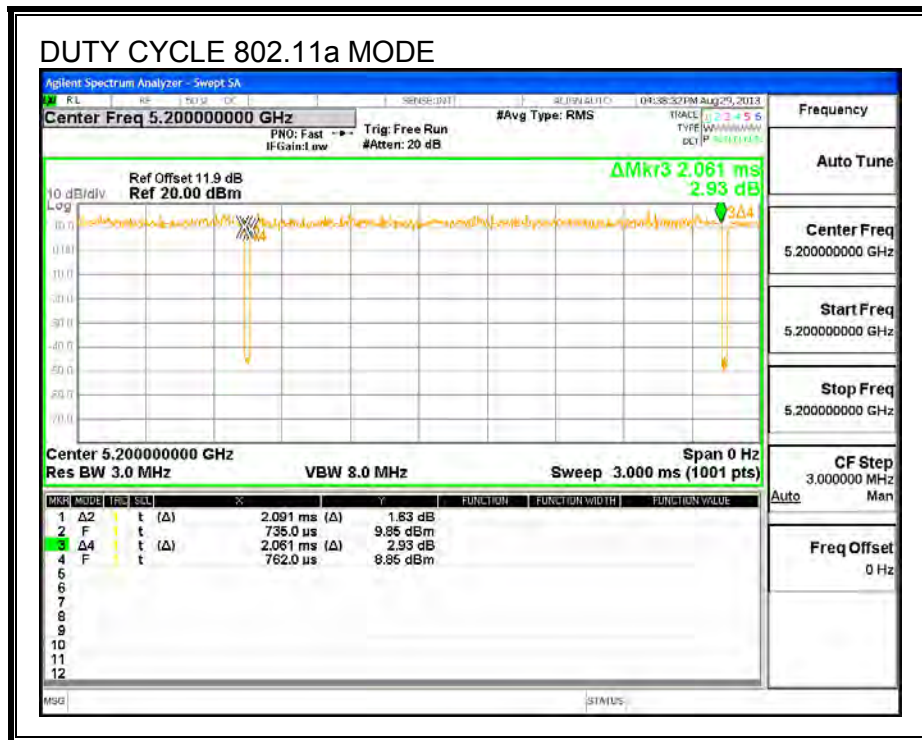

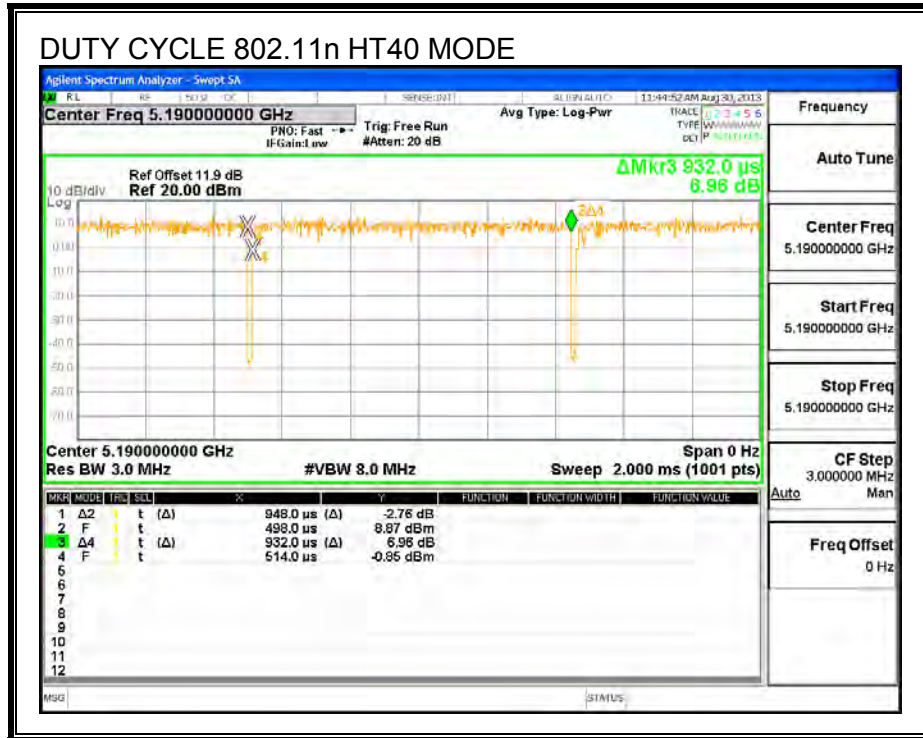

8. ANTENNA PORT TEST RESULTS

8.1. 802.11a SISO MODE IN THE 5.2 GHz BAND

8.1.1. 26 dB BANDWIDTH

LIMITS

None; for reporting purposes only.

RESULTS

Channel	Frequency (MHz)	26 dB Bandwidth (MHz)
Low	5180	20.12
Mid	5200	20.16
High	5240	20.02

26 dB BANDWIDTH

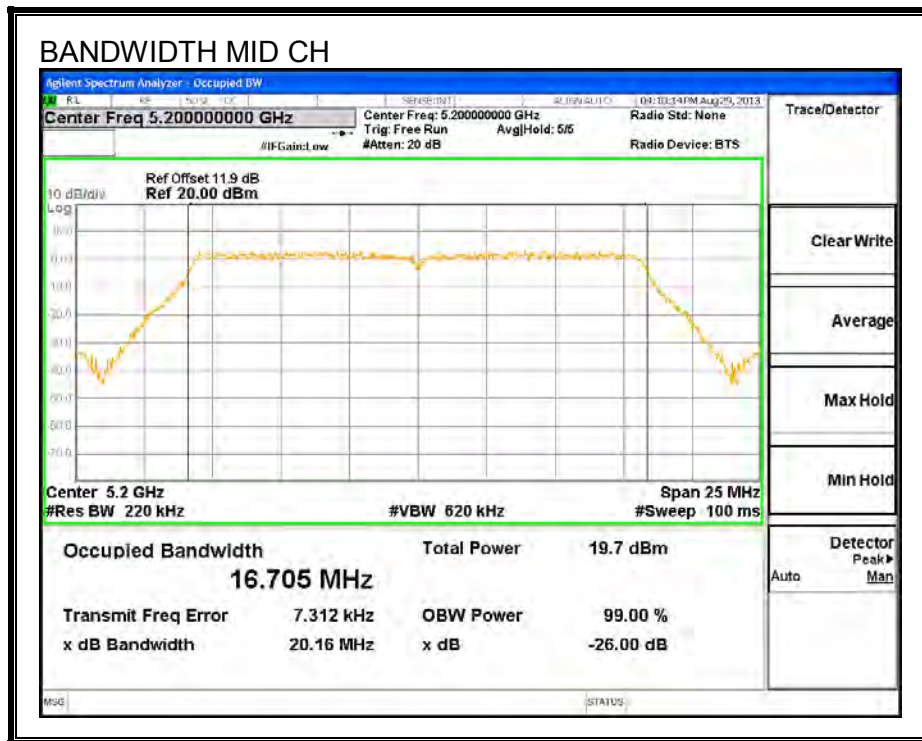
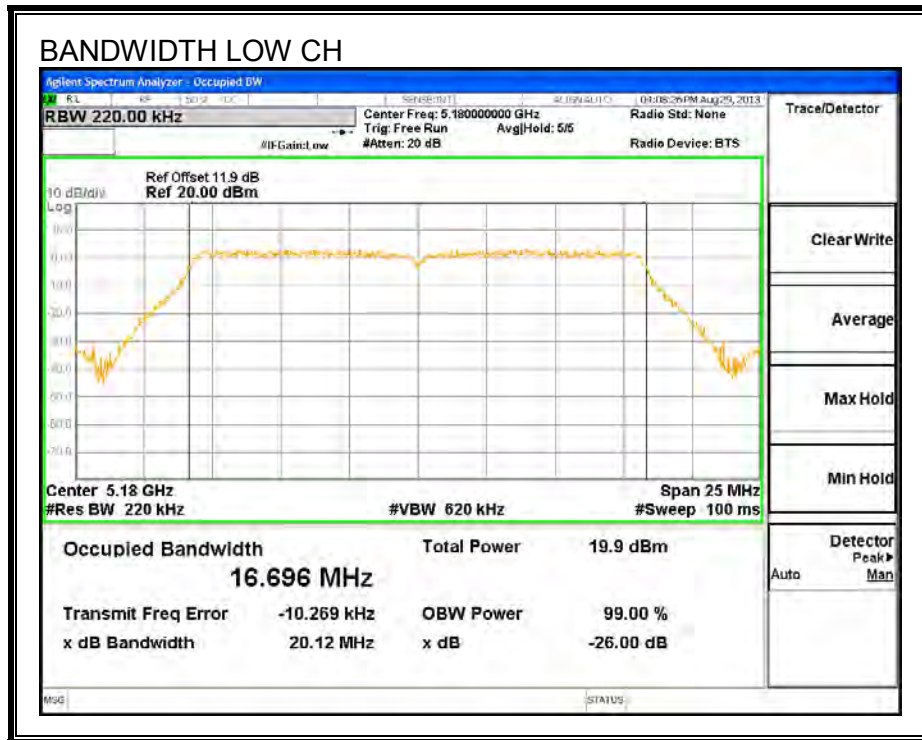

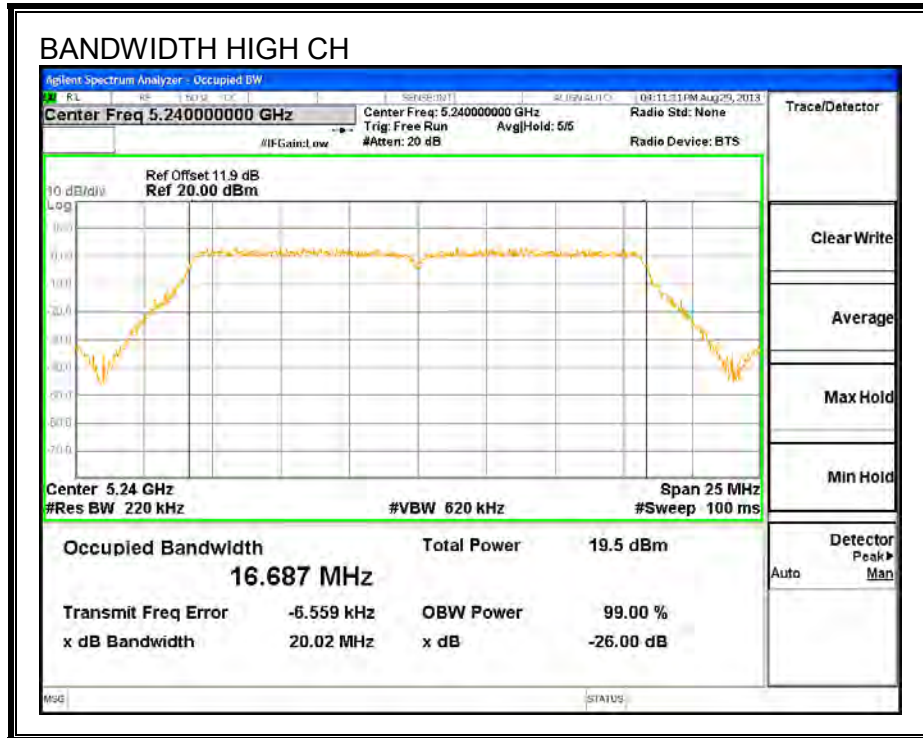

8.1.2. 99% BANDWIDTH

LIMITS

None; for reporting purposes only.

RESULTS

Channel	Frequency (MHz)	99% Bandwidth (MHz)
Low	5180	16.469
Mid	5200	16.460
High	5240	16.557

99% BANDWIDTH

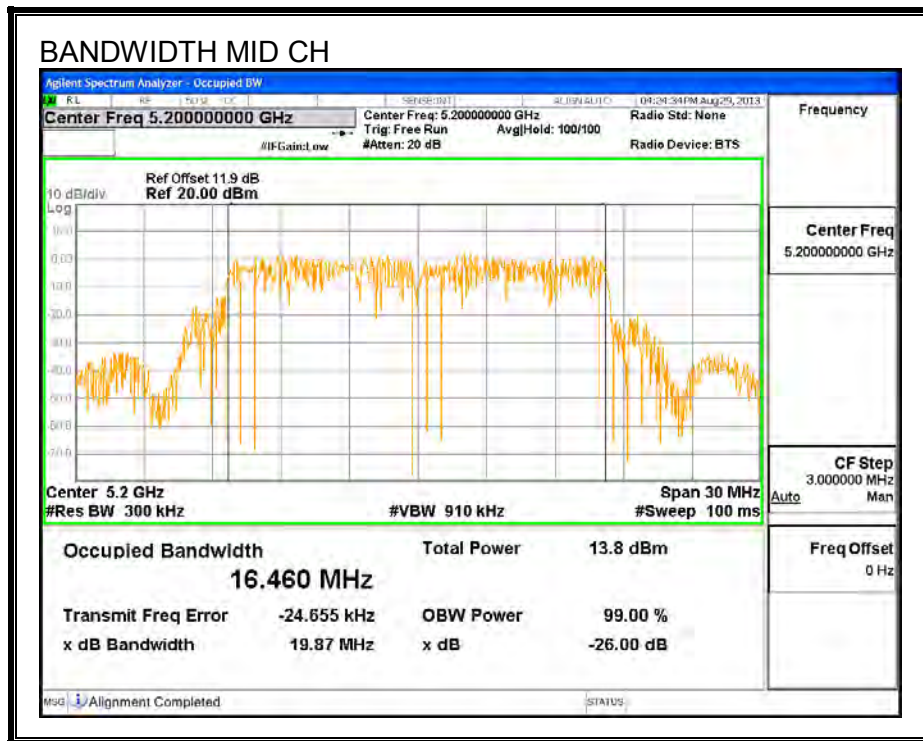
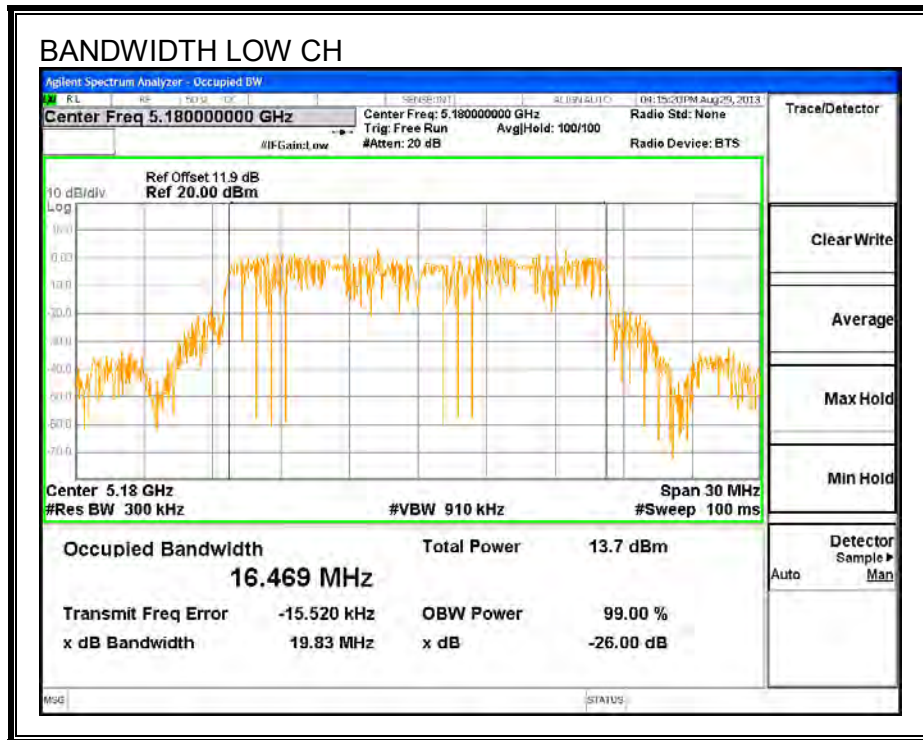

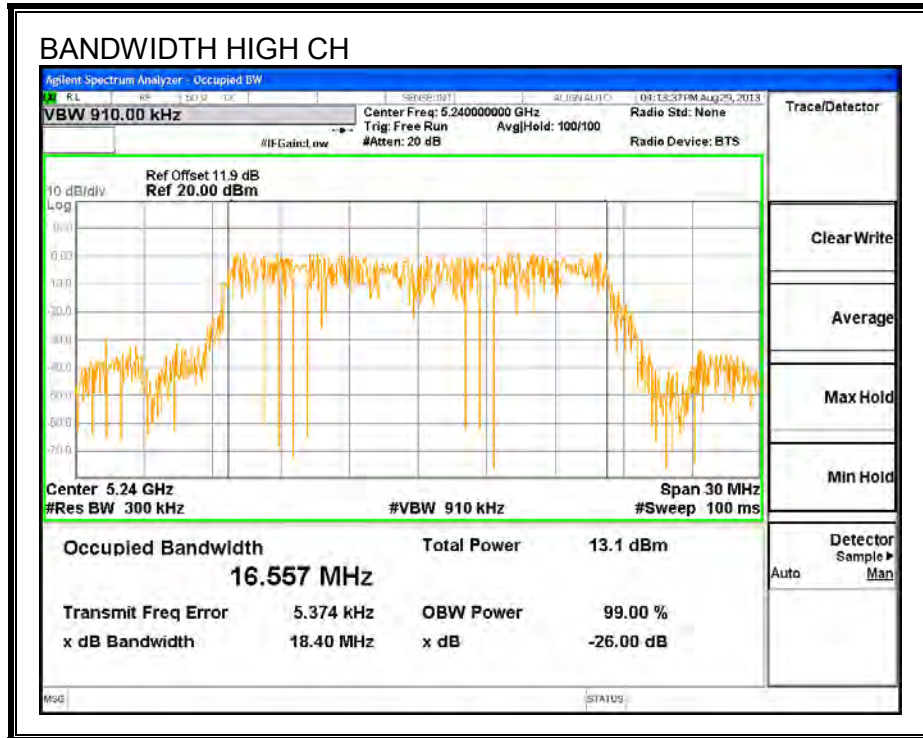

8.1.3. AVERAGE POWER

LIMITS

None; for reporting purposes only.

TEST PROCEDURE

The transmitter output is connected to a power meter.

The cable assembly insertion loss of 11.9 dB (including 10 dB pad and 1.9 dB cable) was entered as an offset in the power meter to allow for direct reading of power.

RESULTS

Channel	Frequency (MHz)	Power (dBm)
Low	5180	14.0
Mid	5200	14.0
High	5240	14.0

8.1.4. OUTPUT POWER AND PSD

LIMITS

FCC §15.407 (a) (1)

(i) For an outdoor access point operating in the band 5.15-5.25 GHz, the maximum conducted output power over the frequency band of operation shall not exceed 1 W provided the maximum antenna gain does not exceed 6 dBi. In addition, the maximum power spectral density shall not exceed 17 dBm in any 1 megahertz band. If transmitting antennas of directional gain greater than 6 dBi are used, both the maximum conducted output power and the maximum power spectral density shall be reduced by the amount in dB that the directional gain of the antenna exceeds 6 dBi. The maximum e.i.r.p. at any elevation angle above 30 degrees as measured from the horizon must not exceed 125 mW (21 dBm).

(ii) For an indoor access point operating in the band 5.15-5.25 GHz, the maximum conducted output power over the frequency band of operation shall not exceed 1 W provided the maximum antenna gain does not exceed 6 dBi. In addition, the maximum power spectral density shall not exceed 17 dBm in any 1 megahertz band. If transmitting antennas of directional gain greater than 6 dBi are used, both the maximum conducted output power and the maximum power spectral density shall be reduced by the amount in dB that the directional gain of the antenna exceeds 6 dBi.

(iii) For fixed point-to-point access points operating in the band 5.15-5.25 GHz, the maximum conducted output power over the frequency band of operation shall not exceed 1 W. Fixed point-to-point U-NII devices may employ antennas with directional gain up to 23 dBi without any corresponding reduction in the maximum conducted output power or maximum power spectral density. For fixed point-to-point transmitters that employ a directional antenna gain greater than 23 dBi, a 1 dB reduction in maximum conducted output power and maximum power spectral density is required for each 1 dB of antenna gain in excess of 23 dBi. Fixed, point-to-point operations exclude the use of point-to-multipoint systems, omnidirectional applications, and multiple collocated transmitters transmitting the same information. The operator of the U-NII device, or if the equipment is professionally installed, the installer, is responsible for ensuring that systems employing high gain directional antennas are used exclusively for fixed, point-to-point operations.

(iv) For mobile and portable client devices in the 5.15-5.25 GHz band, the maximum conducted output power over the frequency band of operation shall not exceed 250 mW provided the maximum antenna gain does not exceed 6 dBi. In addition, the maximum power spectral density shall not exceed 11 dBm in any 1 megahertz band. If transmitting antennas of directional gain greater than 6 dBi are used, both the maximum conducted output power and the maximum power spectral density shall be reduced by the amount in dB that the directional gain of the antenna exceeds 6 dBi.

DIRECTIONAL ANTENNA GAIN

There is only one transmitter output therefore the directional gain is equal to the antenna gain.

RESULTS

Antenna Gain

Channel	Frequency (MHz)	Directio Gain (dBi)
Low	5180	3.06
Mid	5200	3.06
High	5240	3.06

Limits

Channel	Frequency (MHz)	FCC Power Limit (dBm)	FCC PSD Limit (dBm)
Low	5180	24.00	11.00
Mid	5200	24.00	11.00
High	5240	24.00	11.00

Duty Cycle CF (dB)	0.00	Included in Calculations of Corr'd Power & PSD
---------------------------	------	---

Output Power Results

Channel	Frequency (MHz)	Chain 0 Meas Power (dBm)	Total Corr'd Power (dBm)	Power Limit (dBm)	Power Margin (dB)
Low	5180	14.06	14.06	24.00	-9.94
Mid	5200	14.17	14.17	24.00	-9.83
High	5240	14.11	14.11	24.00	-9.89

PSD Results

Channel	Frequency (MHz)	Chain 0 Meas PSD (dBm)	Total Corr'd PSD (dBm)	PSD Limit (dBm)	PSD Margin (dB)
Low	5180	2.78	2.78	11.00	-8.22
Mid	5200	2.64	2.64	11.00	-8.36
High	5240	3.03	3.03	11.00	-7.97

OUTPUT POWER AND PSD, Chain 0

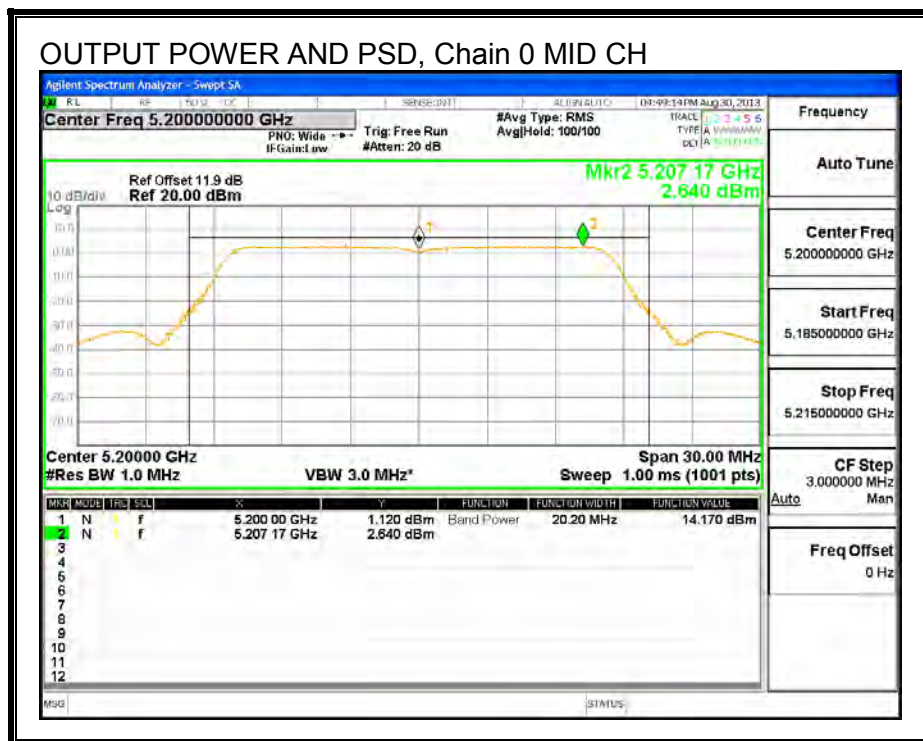
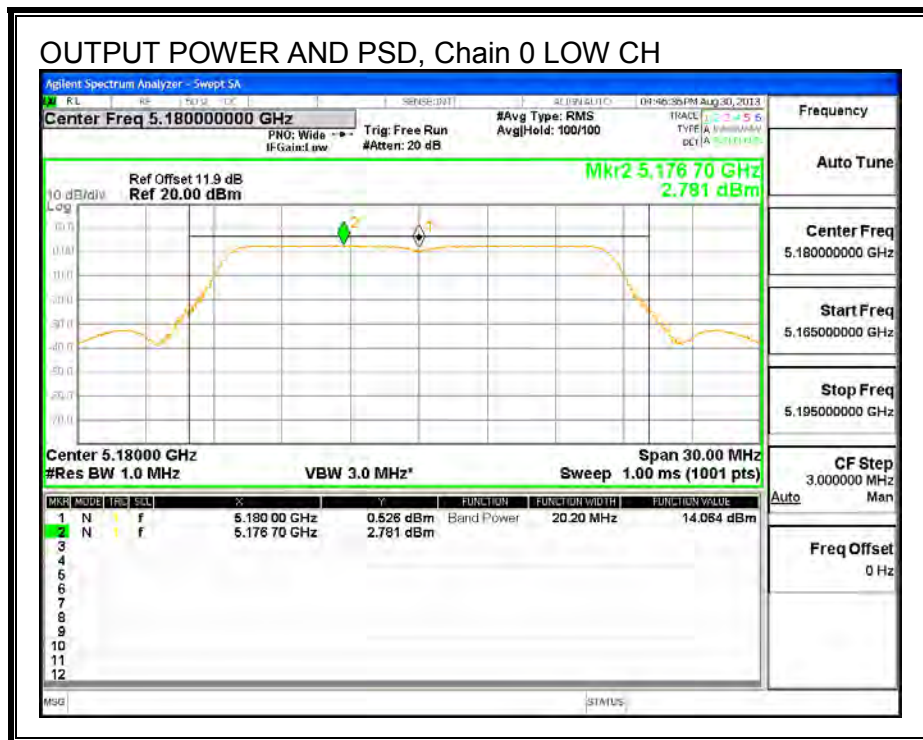

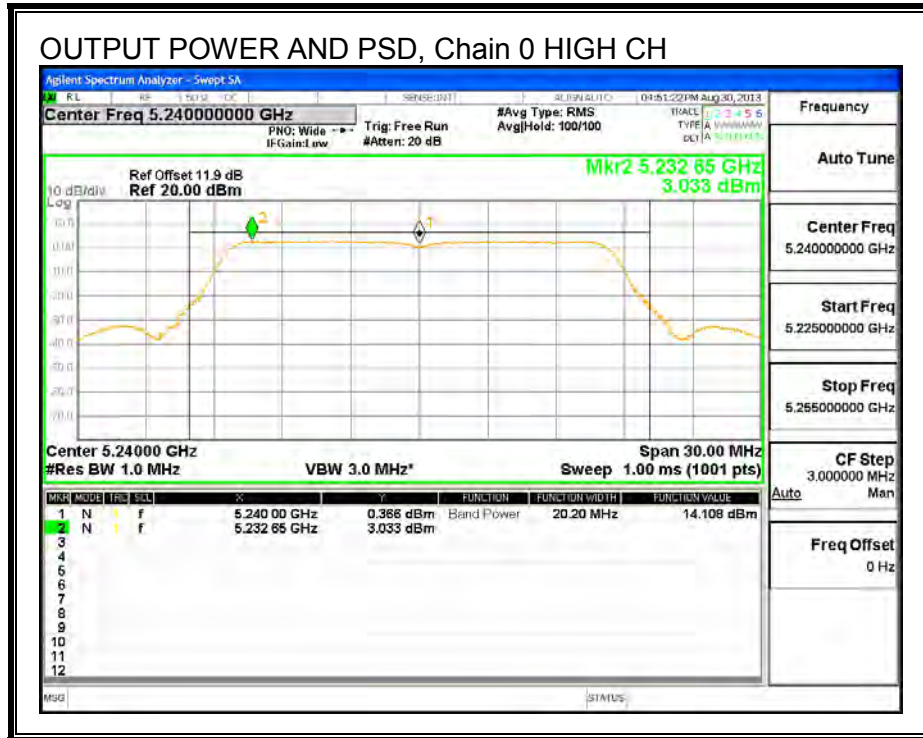

8.2. 802.11n HT20 2TX CDD MODE IN THE 5.2 GHZ BAND

8.2.1. 26 dB BANDWIDTH

LIMITS

None; for reporting purposes only.

RESULTS

Channel	Frequency (MHz)	26 dB BW Chain 0 (MHz)	26 dB BW Chain 1 (MHz)
Low	5180	20.79	20.59
Mid	5200	20.79	20.57
High	5240	20.79	20.54

26 dB BANDWIDTH, Chain 0

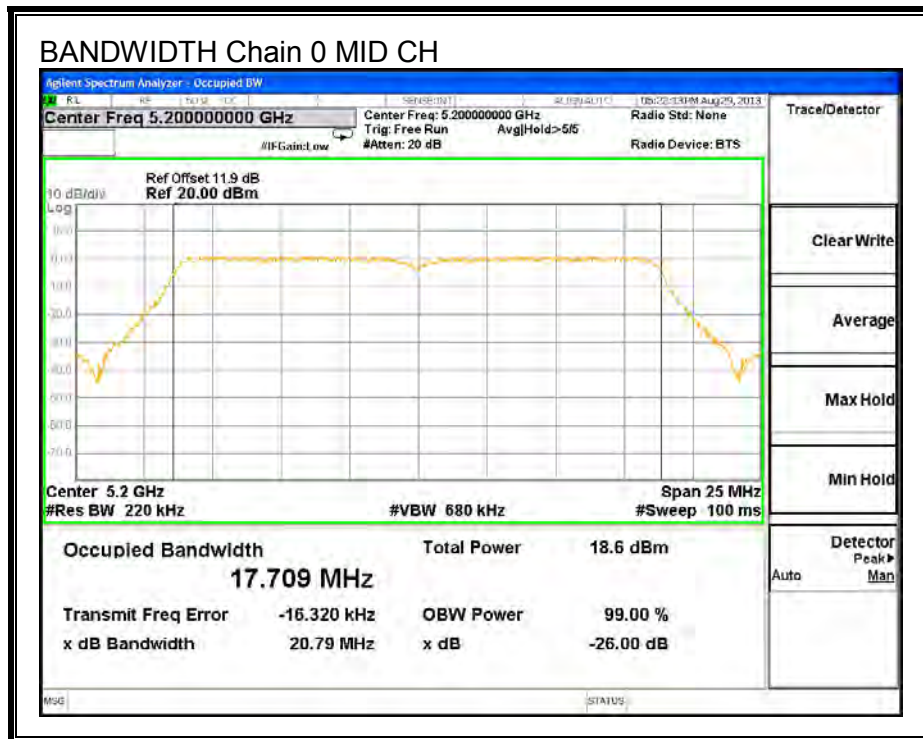
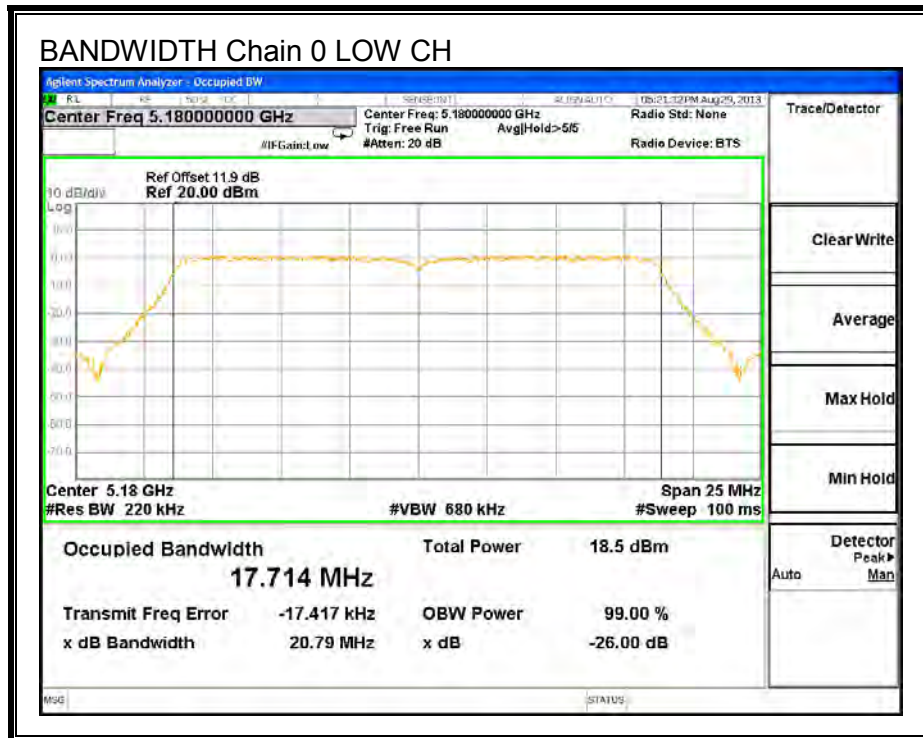

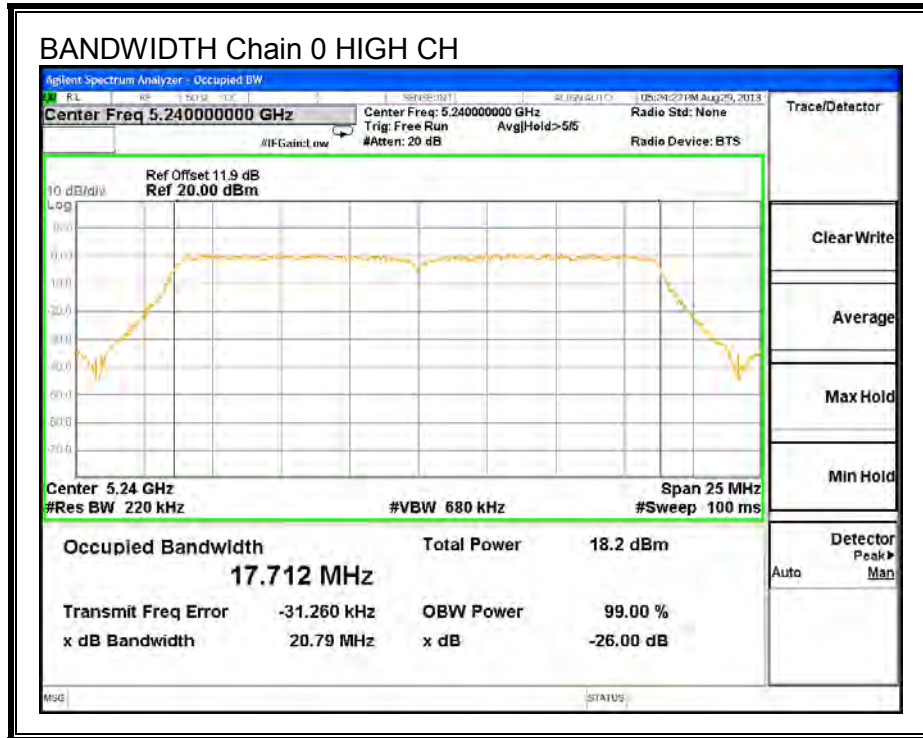

26 dB BANDWIDTH, Chain 1

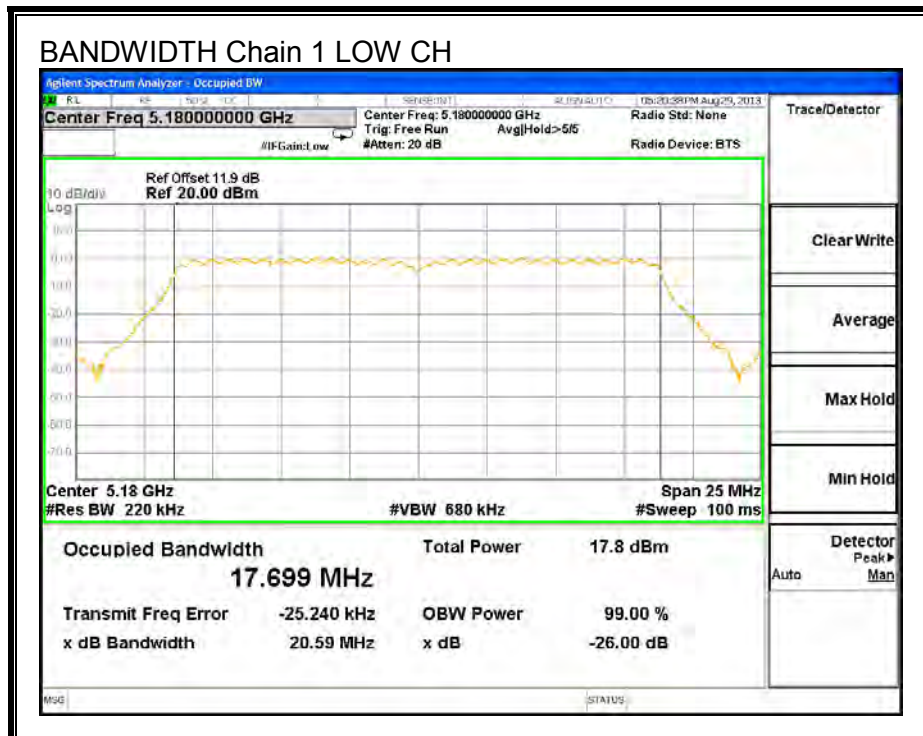

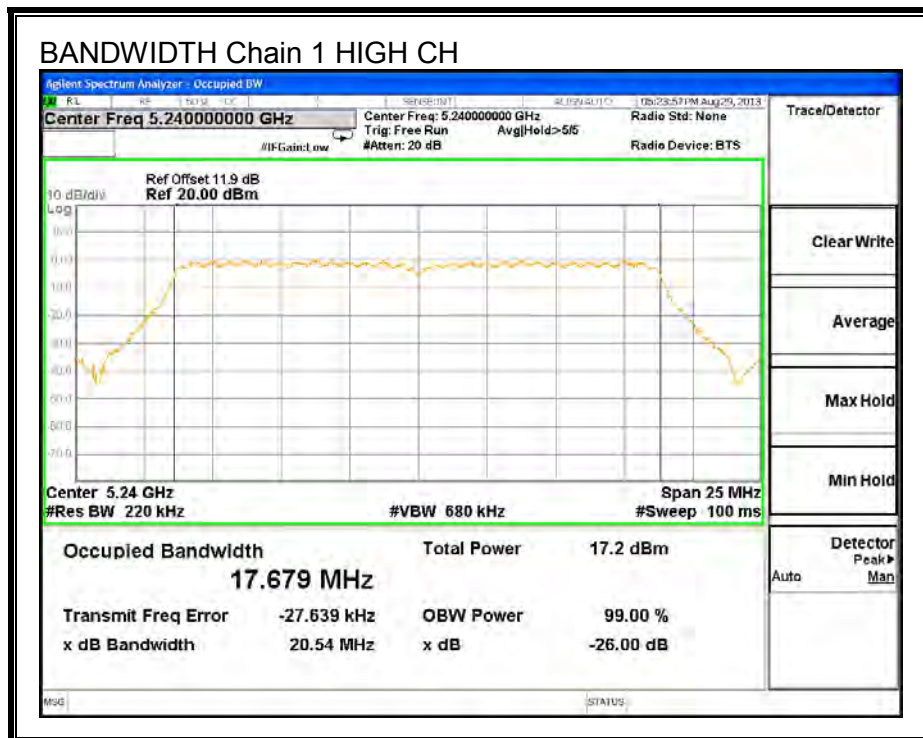
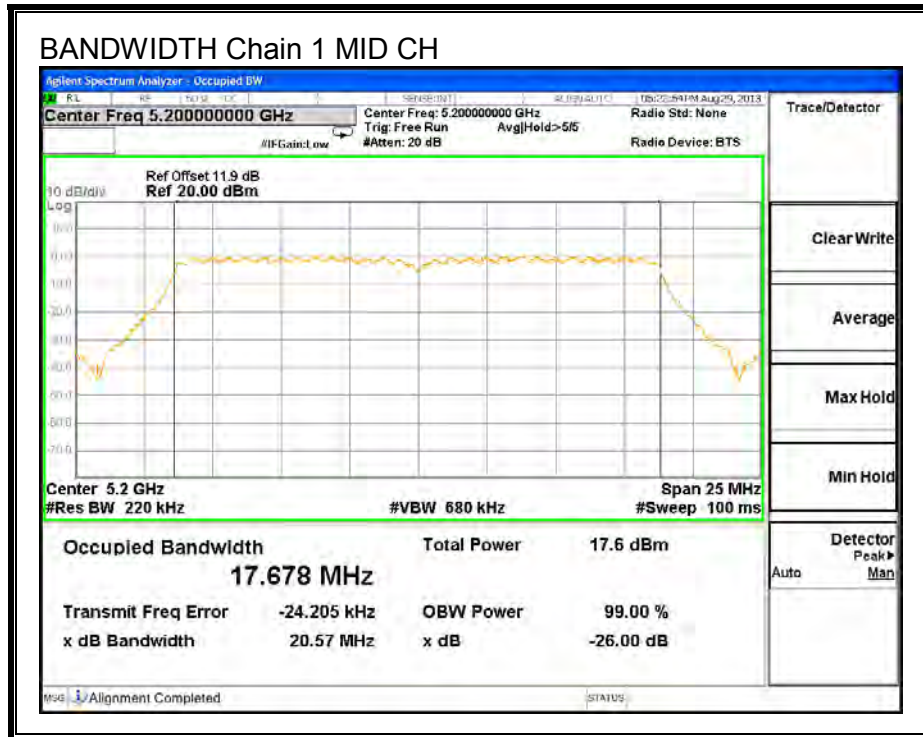

8.2.2. 99% BANDWIDTH

LIMITS

None; for reporting purposes only.

RESULTS

Channel	Frequency (MHz)	99% BW Chain 0 (MHz)	99% BW Chain 1 (MHz)
Low	5180	17.575	17.644
Mid	5200	17.616	17.750
High	5240	17.675	17.668

99% BANDWIDTH, Chain 0

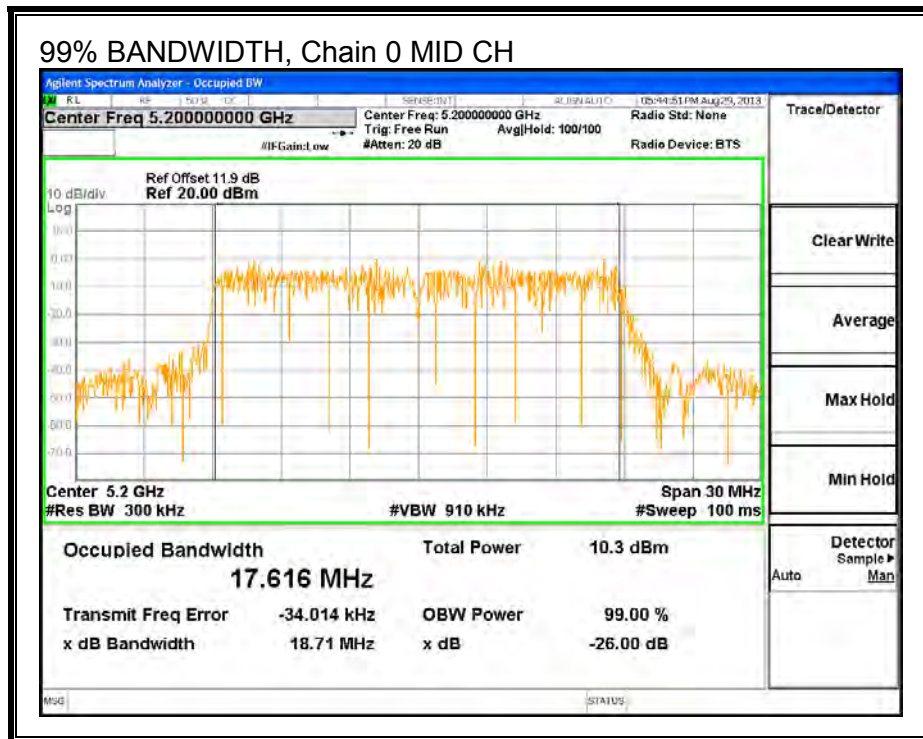
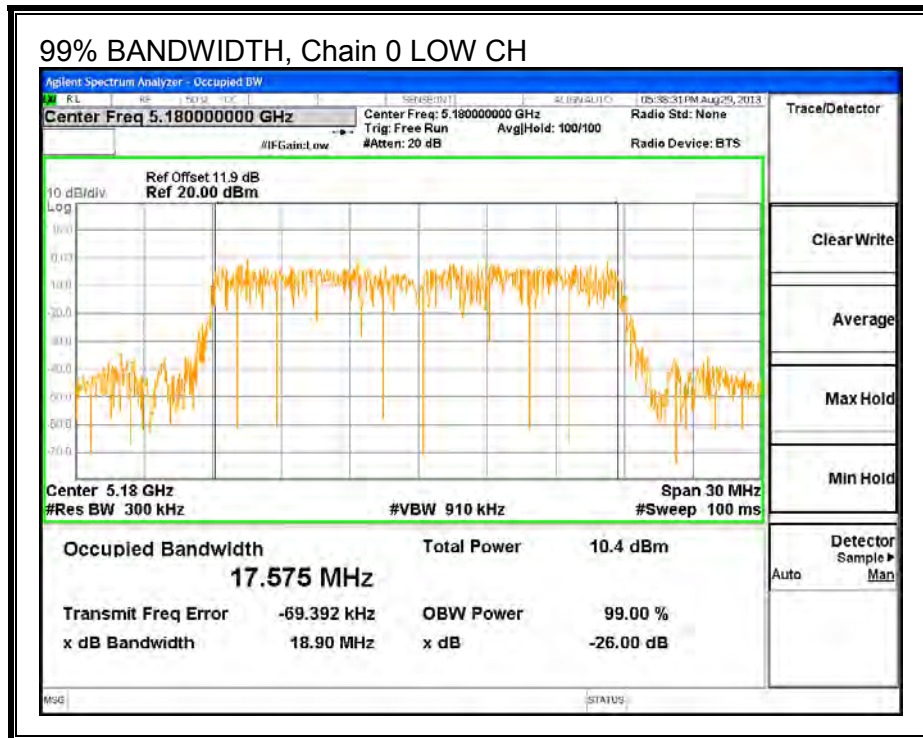

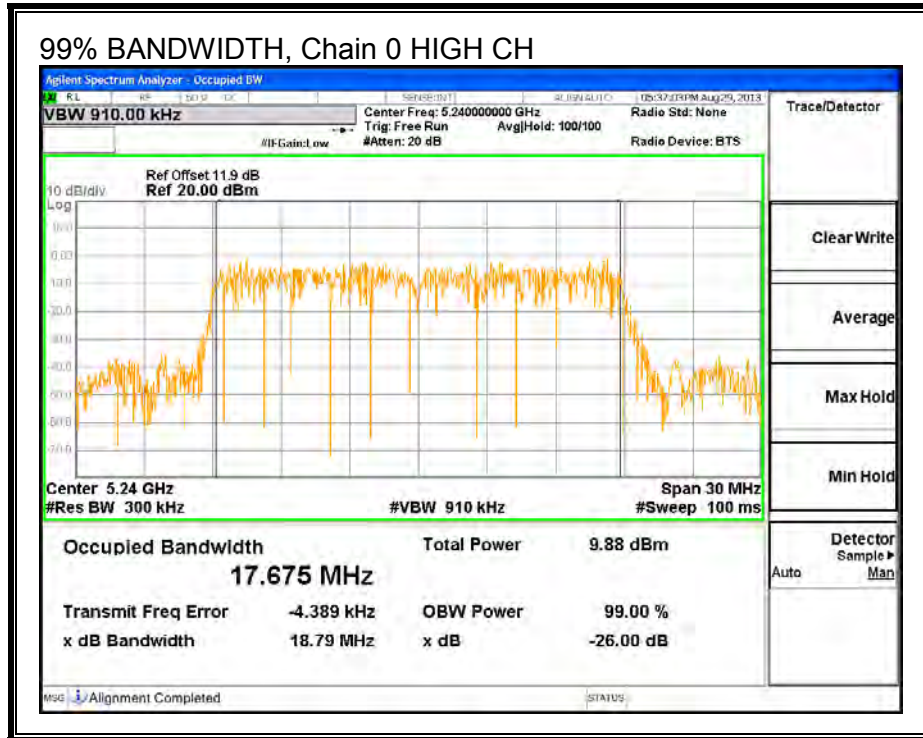

99% BANDWIDTH, Chain 1

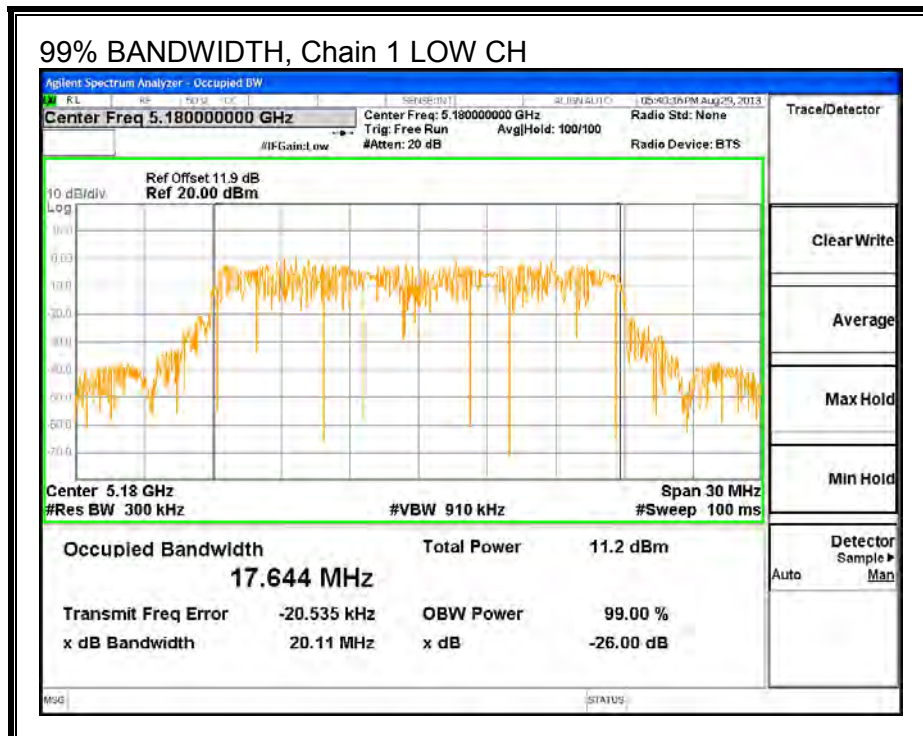

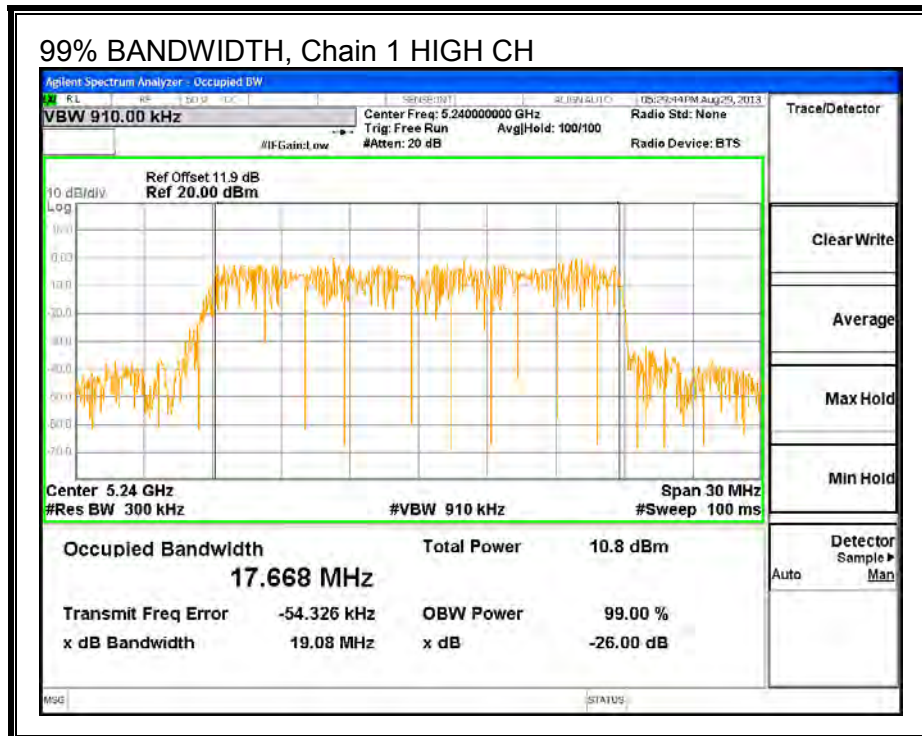
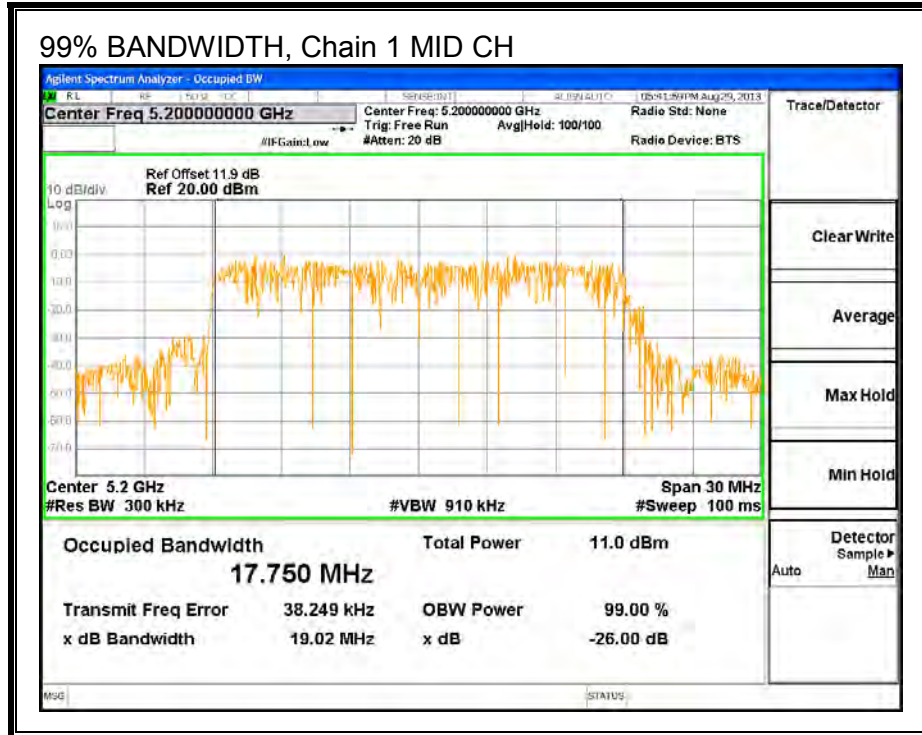

8.2.3. AVERAGE POWER

LIMITS

None; for reporting purposes only.

TEST PROCEDURE

The transmitter output is connected to a power meter.

The cable assembly insertion loss of 11.9 dB (including 10 dB pad and 1.9 dB cable) was entered as an offset in the power meter to allow for direct reading of power.

RESULTS

Average Power Results

Channel	Frequency (MHz)	Chain 0 Power (dBm)	Chain 1 Power (dBm)	Total Power (dBm)
Low	5180	10.95	11.00	13.99
Mid	5200	10.90	11.00	13.96
High	5240	10.95	10.90	13.94

8.2.4. OUTPUT POWER AND PPSD

LIMITS

FCC §15.407 (a) (1)

(i) For an outdoor access point operating in the band 5.15-5.25 GHz, the maximum conducted output power over the frequency band of operation shall not exceed 1 W provided the maximum antenna gain does not exceed 6 dBi. In addition, the maximum power spectral density shall not exceed 17 dBm in any 1 megahertz band. If transmitting antennas of directional gain greater than 6 dBi are used, both the maximum conducted output power and the maximum power spectral density shall be reduced by the amount in dB that the directional gain of the antenna exceeds 6 dBi. The maximum e.i.r.p. at any elevation angle above 30 degrees as measured from the horizon must not exceed 125 mW (21 dBm).

(ii) For an indoor access point operating in the band 5.15-5.25 GHz, the maximum conducted output power over the frequency band of operation shall not exceed 1 W provided the maximum antenna gain does not exceed 6 dBi. In addition, the maximum power spectral density shall not exceed 17 dBm in any 1 megahertz band. If transmitting antennas of directional gain greater than 6 dBi are used, both the maximum conducted output power and the maximum power spectral density shall be reduced by the amount in dB that the directional gain of the antenna exceeds 6 dBi.

(iii) For fixed point-to-point access points operating in the band 5.15-5.25 GHz, the maximum conducted output power over the frequency band of operation shall not exceed 1 W. Fixed point-to-point U-NII devices may employ antennas with directional gain up to 23 dBi without any corresponding reduction in the maximum conducted output power or maximum power spectral density. For fixed point-to-point transmitters that employ a directional antenna gain greater than 23 dBi, a 1 dB reduction in maximum conducted output power and maximum power spectral density is required for each 1 dB of antenna gain in excess of 23 dBi. Fixed, point-to-point operations exclude the use of point-to-multipoint systems, omnidirectional applications, and multiple collocated transmitters transmitting the same information. The operator of the U-NII device, or if the equipment is professionally installed, the installer, is responsible for ensuring that systems employing high gain directional antennas are used exclusively for fixed, point-to-point operations.

(iv) For mobile and portable client devices in the 5.15-5.25 GHz band, the maximum conducted output power over the frequency band of operation shall not exceed 250 mW provided the maximum antenna gain does not exceed 6 dBi. In addition, the maximum power spectral density shall not exceed 11 dBm in any 1 megahertz band. If transmitting antennas of directional gain greater than 6 dBi are used, both the maximum conducted output power and the maximum power spectral density shall be reduced by the amount in dB that the directional gain of the antenna exceeds 6 dBi.

DIRECTIONAL ANTENNA GAIN

The TX chains are uncorrelated and the antenna gain is unequal among the chains. The directional gain is:

Chain 0 Antenna Gain (dBi)	Chain 1 Antenna Gain (dBi)	Uncorrelated Chains Directional Gain (dBi)
-0.02	3.06	1.79

The TX chains are correlated and the antenna gain is unequal among the chains. The directional gain is:

Chain 0 Antenna Gain (dBi)	Chain 1 Antenna Gain (dBi)	Correlated Chains Directional Gain (dBi)
-0.02	3.06	4.67

RESULTS

Antenna Gain

Channel	Frequency (MHz)	Uncorre Directio nal Gain (dBi)	Correlat Directio nal Gain (dBi)
Low	5180	1.79	4.67
Mid	5200	1.79	4.67
High	5240	1.79	4.67

Limits

Channel	Frequency (MHz)	FCC Power Limit (dBm)	FCC PPSD Limit (dBm)
Low	5180	24.00	11.00
Mid	5200	24.00	11.00
High	5240	24.00	11.00

Duty Cycle CF (dB)	0.00	Included in Calculations of Corr'd Power & PPSD
---------------------------	------	--

Output Power Results

Channel	Frequency (MHz)	Chain 0 Meas Power (dBm)	Chain 1 Meas Power (dBm)	Total Corr'd Power (dBm)	Power Limit (dBm)	Power Margin (dB)
Low	5180	11.16	11.13	14.15	24.00	-9.85
Mid	5200	11.27	11.36	14.33	24.00	-9.67
High	5240	11.28	11.26	14.28	24.00	-9.72

PPSD Results

Channel	Frequency (MHz)	Chain 0 Meas PPSD (dBm)	Chain 1 Meas PPSD (dBm)	Total Corr'd PPSD (dBm)	PPSD Limit (dBm)	PPSD Margin (dB)
Low	5180	-0.33	-0.21	2.74	11.00	-8.26
Mid	5200	-0.05	-1.08	2.48	11.00	-8.52
High	5240	-0.31	-0.58	2.57	11.00	-8.43

OUTPUT POWER AND PPSD, Chain 0

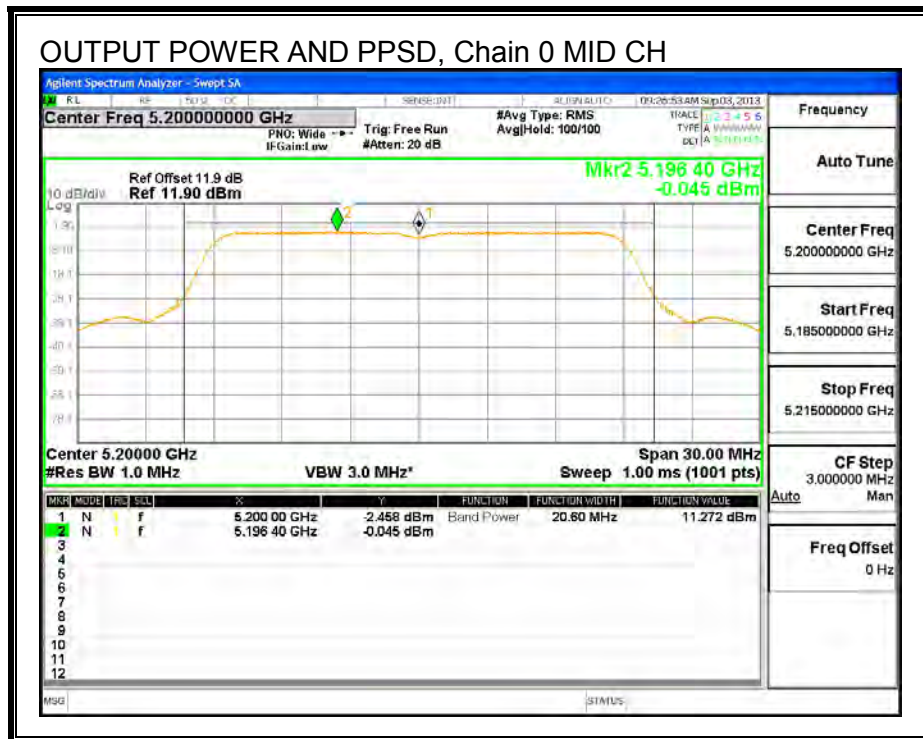
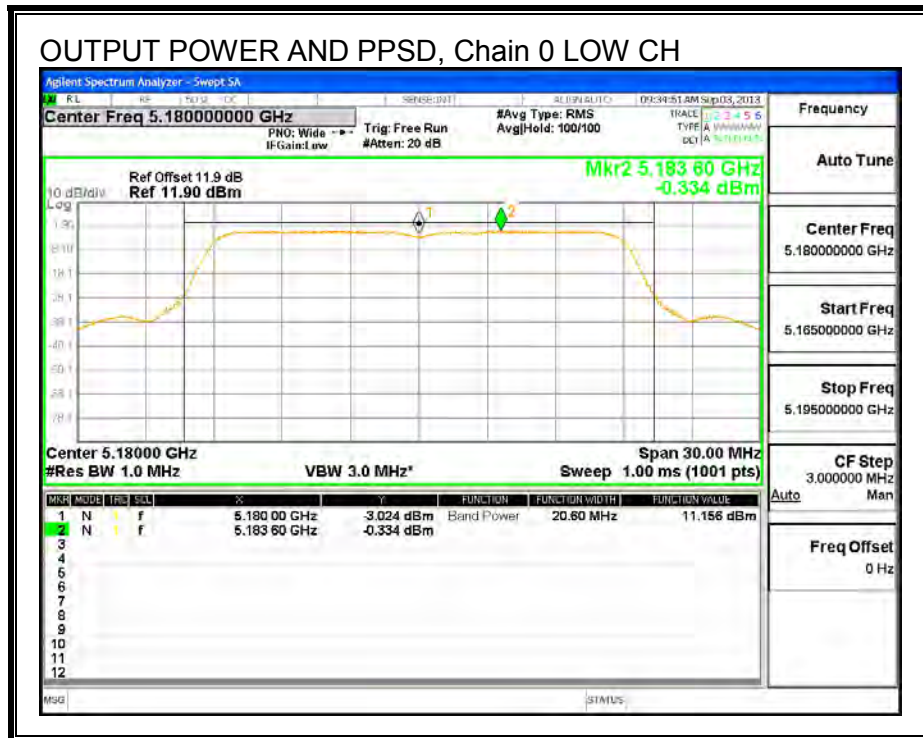

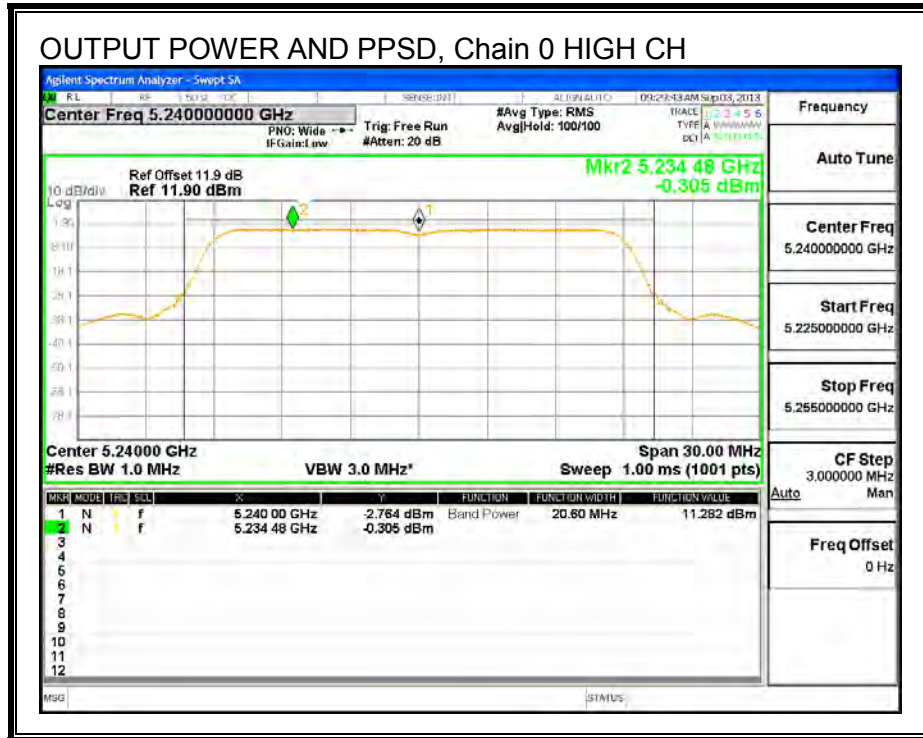

OUTPUT POWER AND PPSD, Chain 1

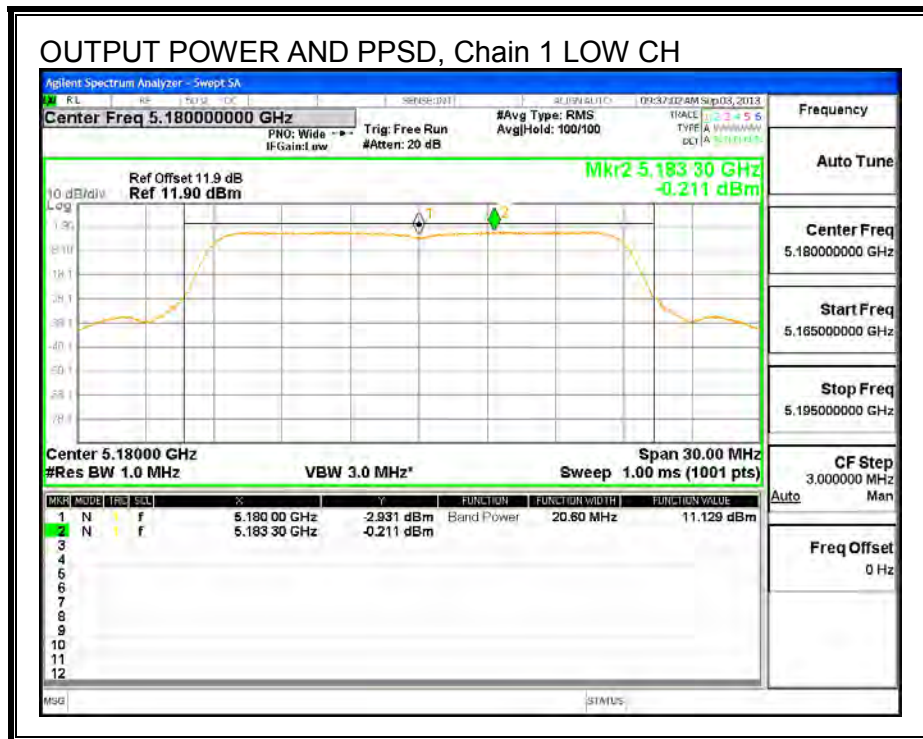

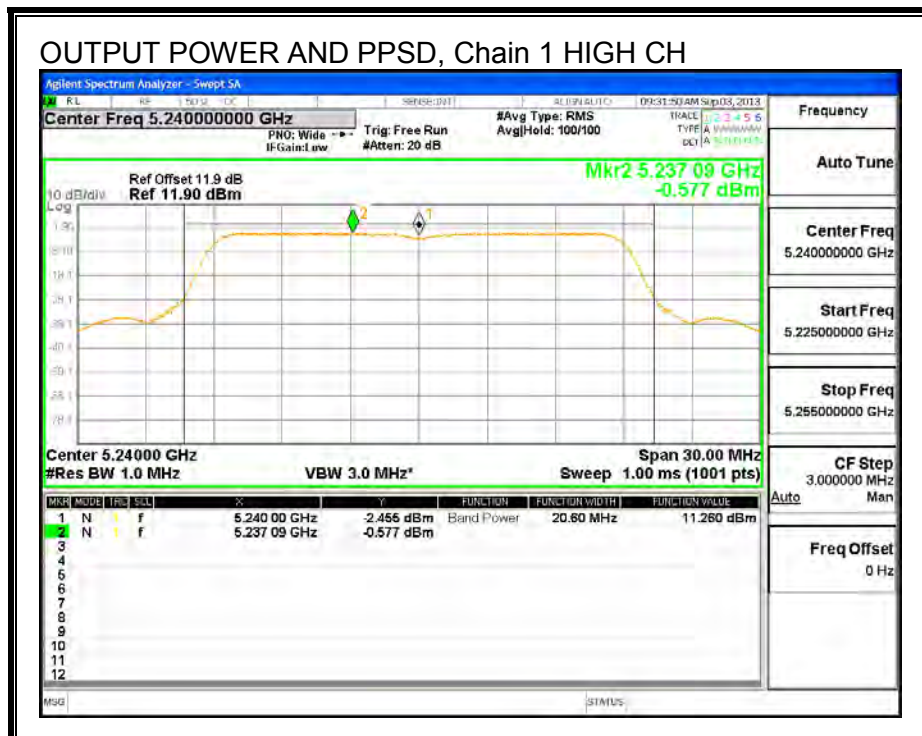
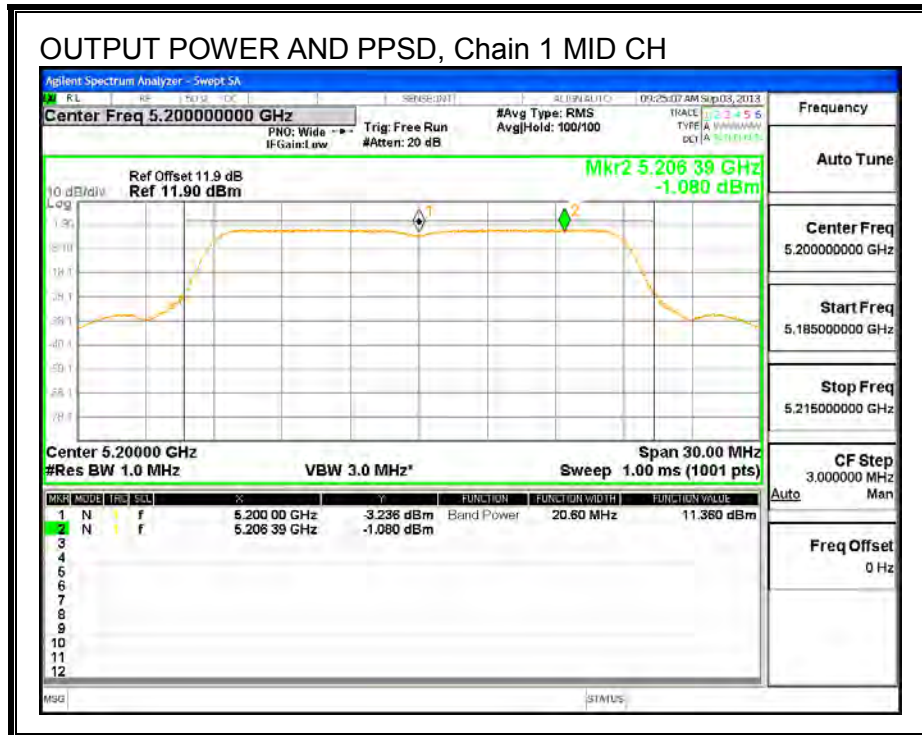

8.3. 802.11n SISO HT40 MODE IN THE 5.2 GHz BAND

8.3.1. 26 dB BANDWIDTH

LIMITS

None; for reporting purposes only.

RESULTS

Channel	Frequency (MHz)	26 dB Bandwidth (MHz)
Low	5190	39.64
High	5230	39.86

26 dB BANDWIDTH

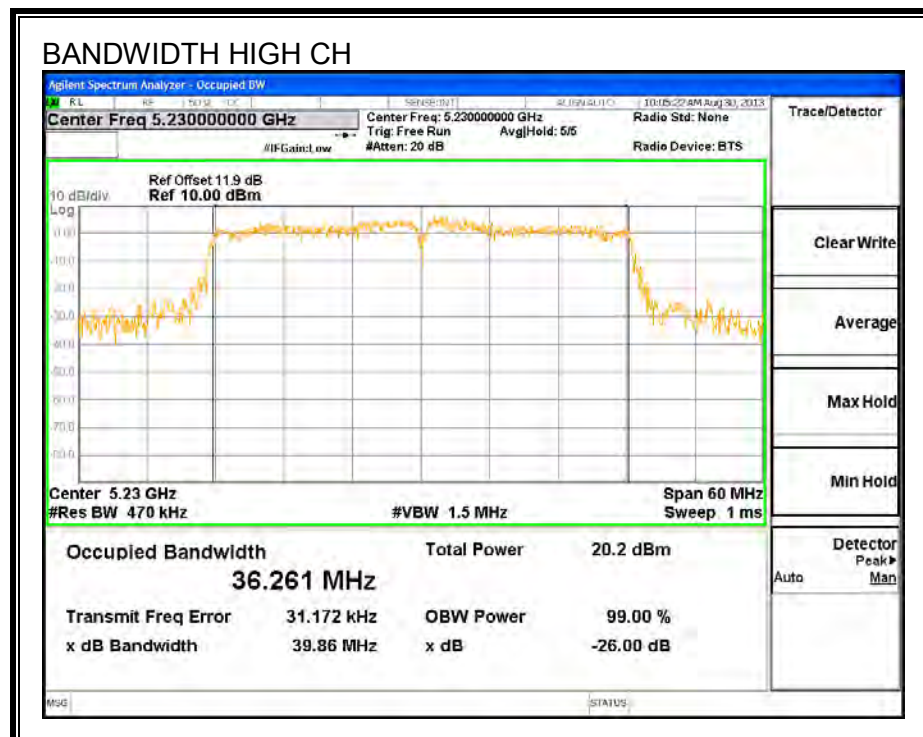
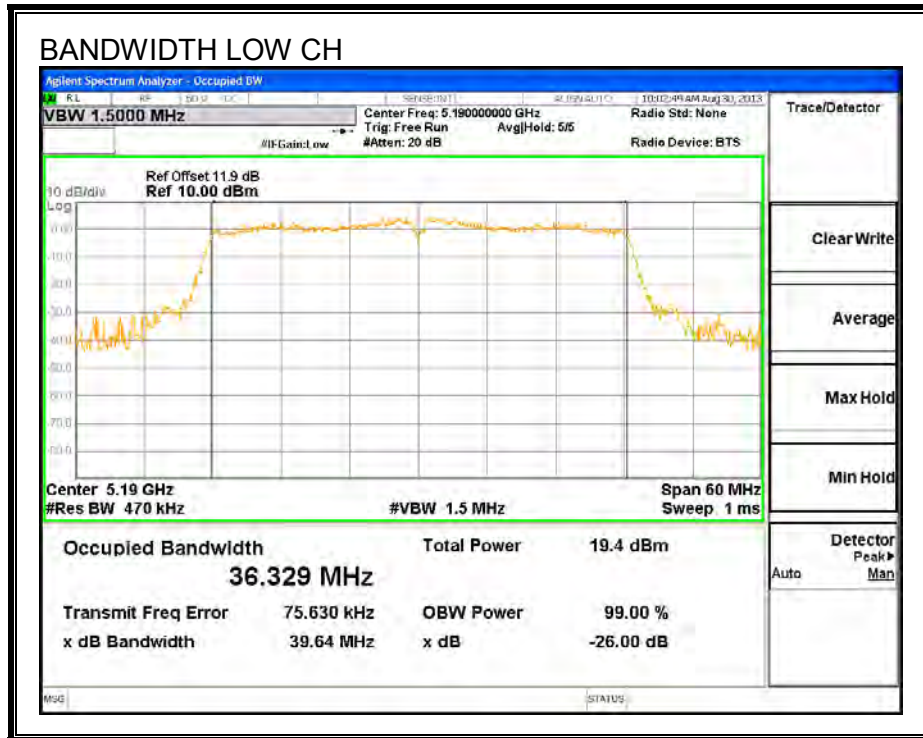

8.3.2. 99% BANDWIDTH

LIMITS

None; for reporting purposes only.

RESULTS

Channel	Frequency (MHz)	99% Bandwidth (MHz)
Low	5190	36.372
High	5230	36.440

99% BANDWIDTH

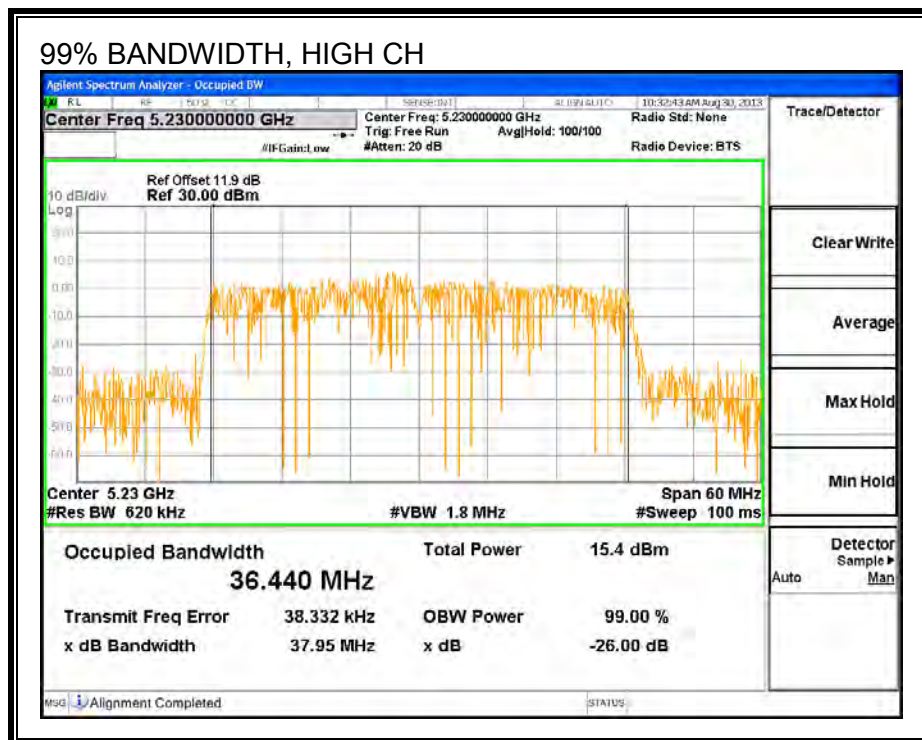
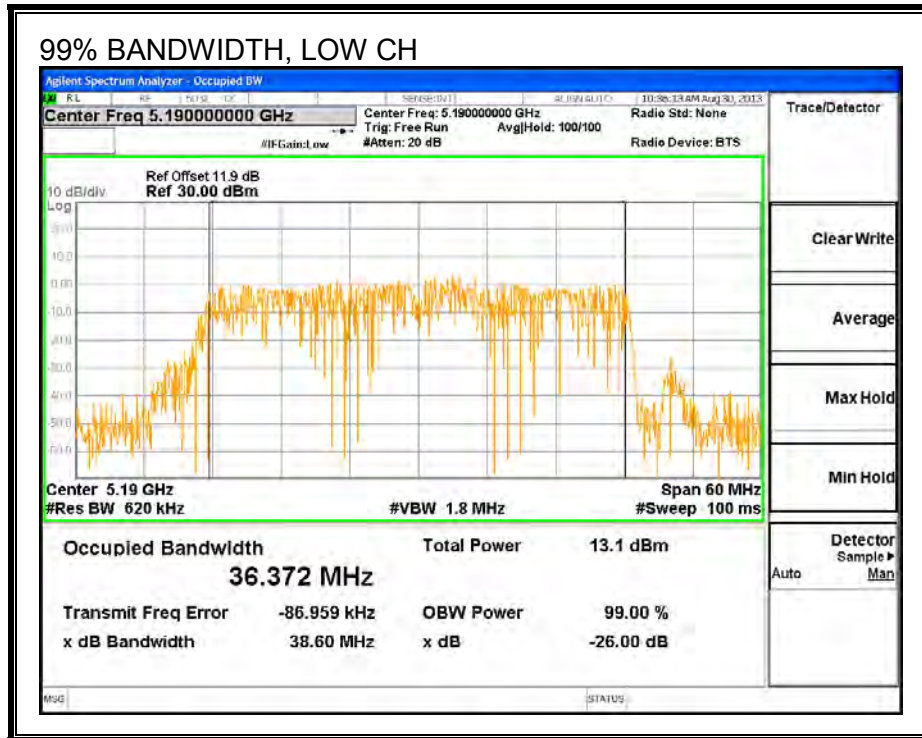

8.3.3. AVERAGE POWER

LIMITS

None; for reporting purposes only.

TEST PROCEDURE

The transmitter output is connected to a power meter.

The cable assembly insertion loss of 11.9 dB (including 10 dB pad and 1.9 dB cable) was entered as an offset in the power meter to allow for direct reading of power.

RESULTS

Channel	Frequency (MHz)	Power (dBm)
Low	5190	13.50
High	5230	16.00

8.3.4. OUTPUT POWER AND PPSD

LIMITS

FCC §15.407 (a) (1)

(i) For an outdoor access point operating in the band 5.15-5.25 GHz, the maximum conducted output power over the frequency band of operation shall not exceed 1 W provided the maximum antenna gain does not exceed 6 dBi. In addition, the maximum power spectral density shall not exceed 17 dBm in any 1 megahertz band. If transmitting antennas of directional gain greater than 6 dBi are used, both the maximum conducted output power and the maximum power spectral density shall be reduced by the amount in dB that the directional gain of the antenna exceeds 6 dBi. The maximum e.i.r.p. at any elevation angle above 30 degrees as measured from the horizon must not exceed 125 mW (21 dBm).

(ii) For an indoor access point operating in the band 5.15-5.25 GHz, the maximum conducted output power over the frequency band of operation shall not exceed 1 W provided the maximum antenna gain does not exceed 6 dBi. In addition, the maximum power spectral density shall not exceed 17 dBm in any 1 megahertz band. If transmitting antennas of directional gain greater than 6 dBi are used, both the maximum conducted output power and the maximum power spectral density shall be reduced by the amount in dB that the directional gain of the antenna exceeds 6 dBi.

(iii) For fixed point-to-point access points operating in the band 5.15-5.25 GHz, the maximum conducted output power over the frequency band of operation shall not exceed 1 W. Fixed point-to-point U-NII devices may employ antennas with directional gain up to 23 dBi without any corresponding reduction in the maximum conducted output power or maximum power spectral density. For fixed point-to-point transmitters that employ a directional antenna gain greater than 23 dBi, a 1 dB reduction in maximum conducted output power and maximum power spectral density is required for each 1 dB of antenna gain in excess of 23 dBi. Fixed, point-to-point operations exclude the use of point-to-multipoint systems, omnidirectional applications, and multiple collocated transmitters transmitting the same information. The operator of the U-NII device, or if the equipment is professionally installed, the installer, is responsible for ensuring that systems employing high gain directional antennas are used exclusively for fixed, point-to-point operations.

(iv) For mobile and portable client devices in the 5.15-5.25 GHz band, the maximum conducted output power over the frequency band of operation shall not exceed 250 mW provided the maximum antenna gain does not exceed 6 dBi. In addition, the maximum power spectral density shall not exceed 11 dBm in any 1 megahertz band. If transmitting antennas of directional gain greater than 6 dBi are used, both the maximum conducted output power and the maximum power spectral density shall be reduced by the amount in dB that the directional gain of the antenna exceeds 6 dBi.

DIRECTIONAL ANTENNA GAIN

There is only one transmitter output therefore the directional gain is equal to the antenna gain.

RESULTS

Antenna Gain

Channel	Frequency (MHz)	Directio Gain (dBi)
Low	5190	3.06
High	5230	3.06

Limits

Channel	Frequency (MHz)	FCC Power Limit (dBm)	FCC PPSD Limit (dBm)
Low	5190	24.00	11.00
High	5230	24.00	11.00

Duty Cycle CF (dB)	0.00	Included in Calculations of Corr'd Power & PPSD
---------------------------	------	--

Output Power Results

Channel	Frequency (MHz)	Chain 0 Meas Power (dBm)	Total Corr'd Power (dBm)	Power Limit (dBm)	Power Margin (dB)
Low	5190	13.62	13.62	24.00	-10.38
High	5230	16.36	16.36	24.00	-7.64

PPSD Results

Channel	Frequency (MHz)	Chain 0 Meas PPSD (dBm)	Total Corr'd PPSD (dBm)	PPSD Limit (dBm)	PPSD Margin (dB)
Low	5190	0.75	0.75	11.00	-10.25
High	5230	3.68	3.68	11.00	-7.32

OUTPUT POWER AND PPSD, Chain 0

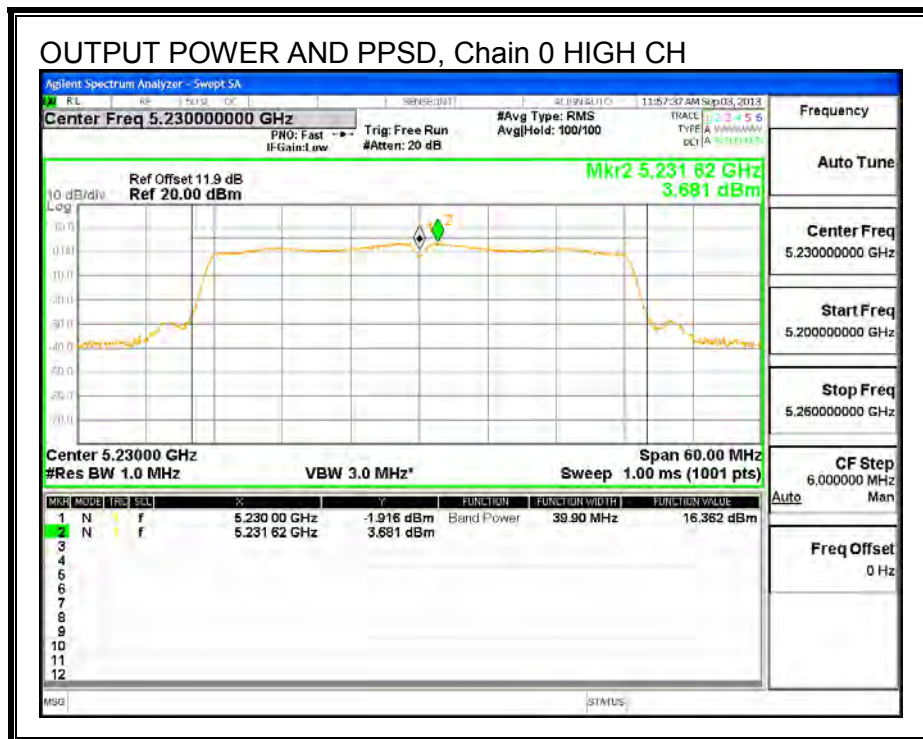
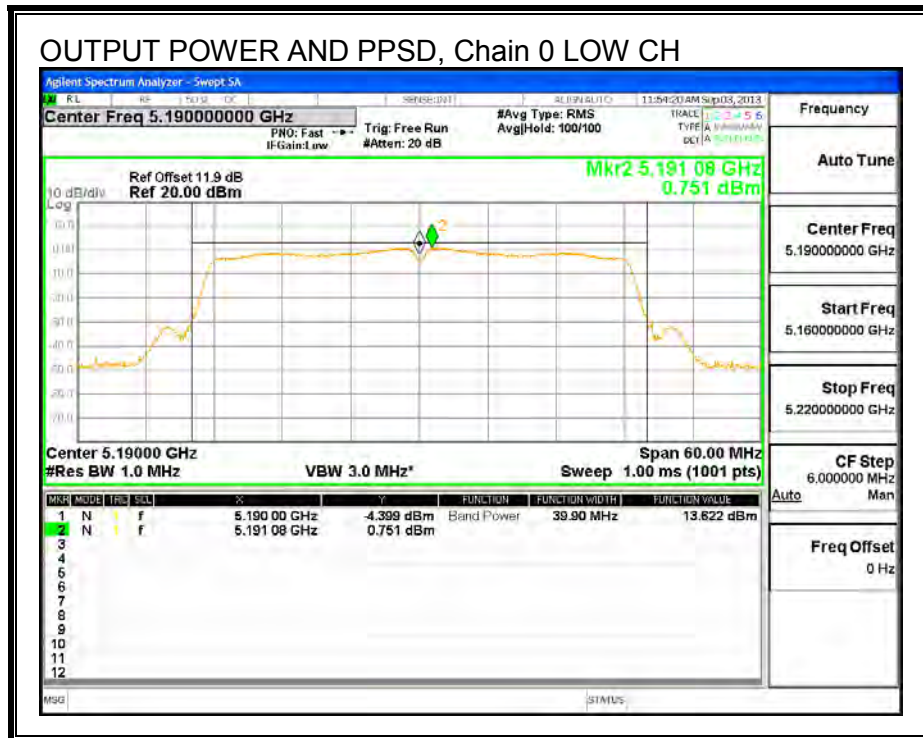

8.4. 802.11n HT40 2TX CDD MODE IN THE 5.2 GHz BAND

8.4.1. 26 dB BANDWIDTH

LIMITS

None; for reporting purposes only.

RESULTS

Channel	Frequency (MHz)	26 dB BW Chain 0 (MHz)	26 dB BW Chain 1 (MHz)
Low	5190	39.67	39.43
High	5230	39.99	39.56

26 dB BANDWIDTH, Chain 0

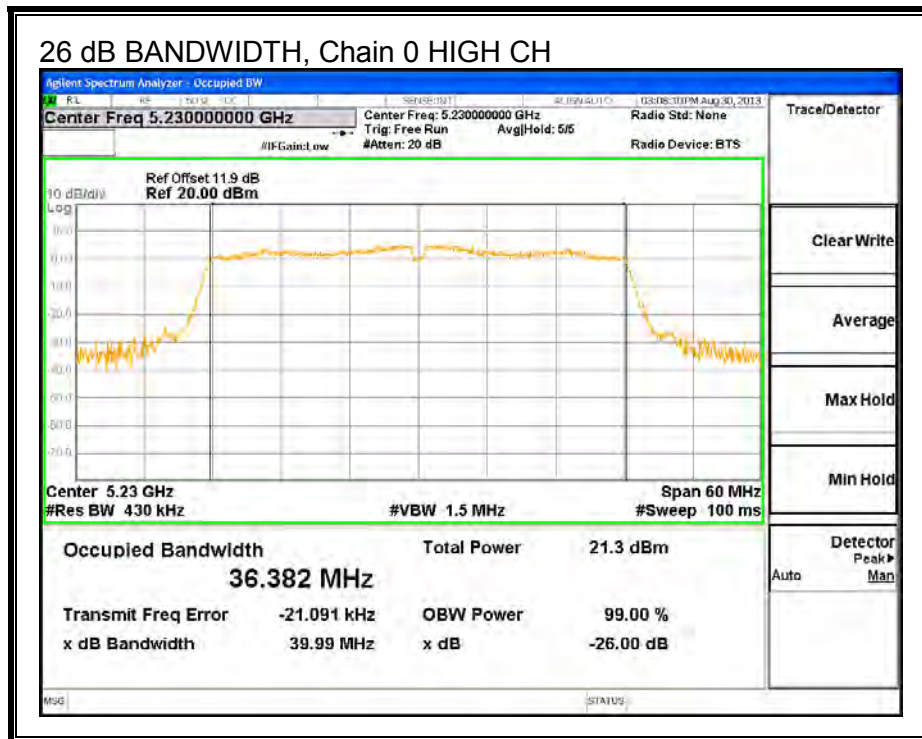
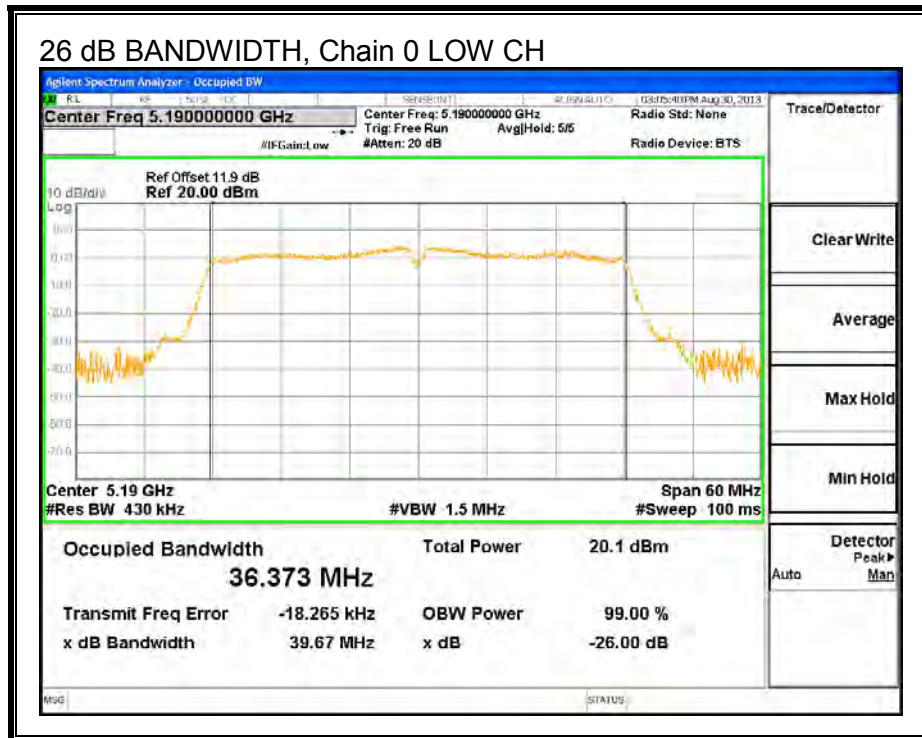

26 dB BANDWIDTH, Chain 1

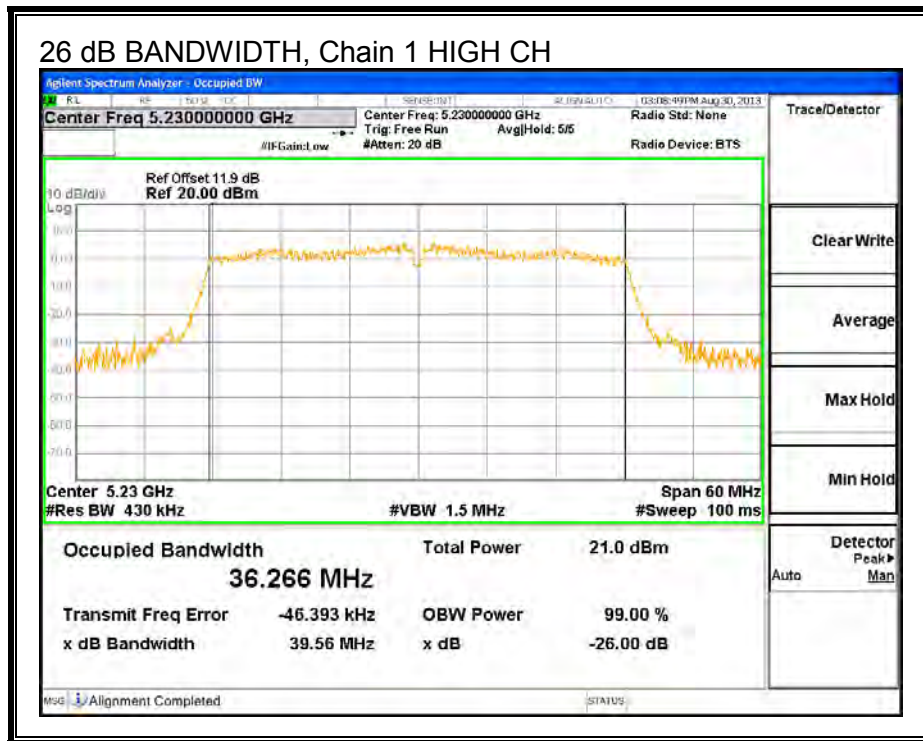
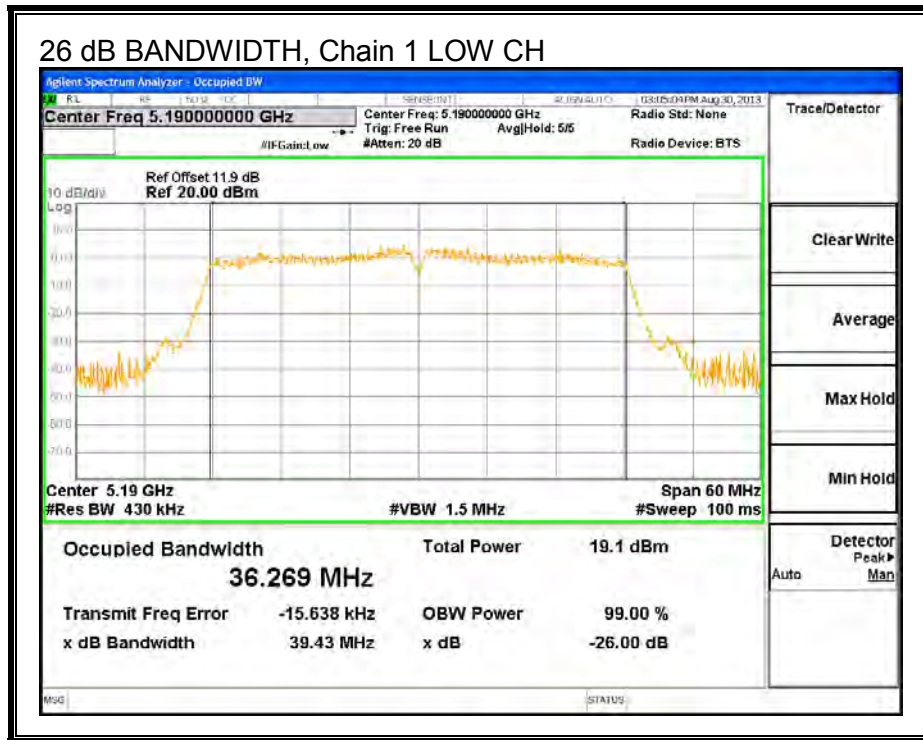

8.4.2. 99% BANDWIDTH

LIMITS

None; for reporting purposes only.

RESULTS

Channel	Frequency (MHz)	99% BW Chain 0 (MHz)	99% BW Chain 1 (MHz)
Low	5190	36.056	36.156
High	5230	36.046	36.297

99% BANDWIDTH, Chain 0

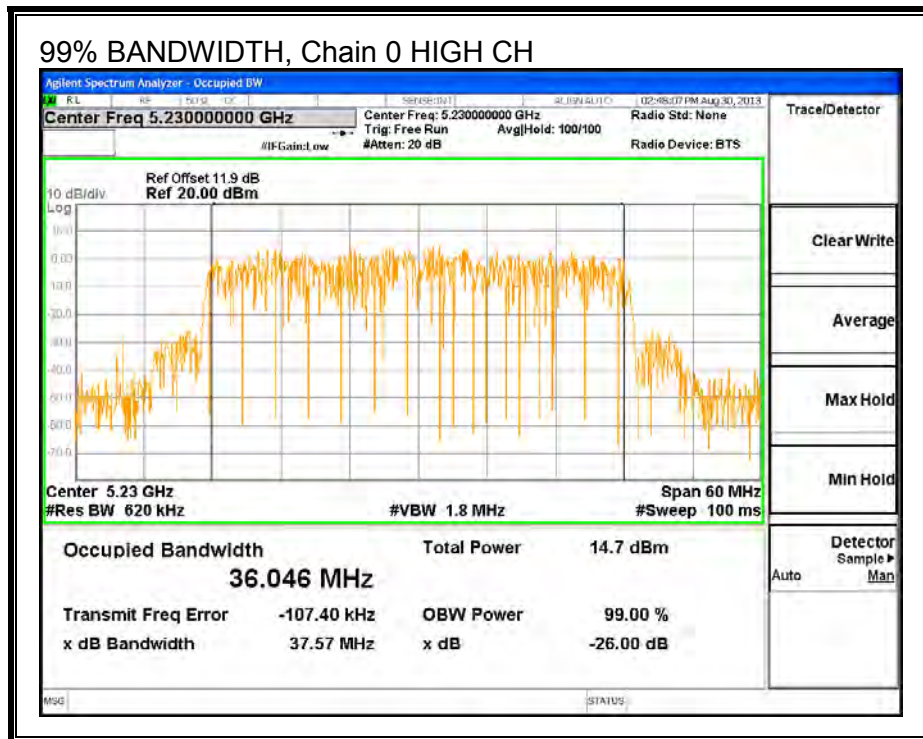
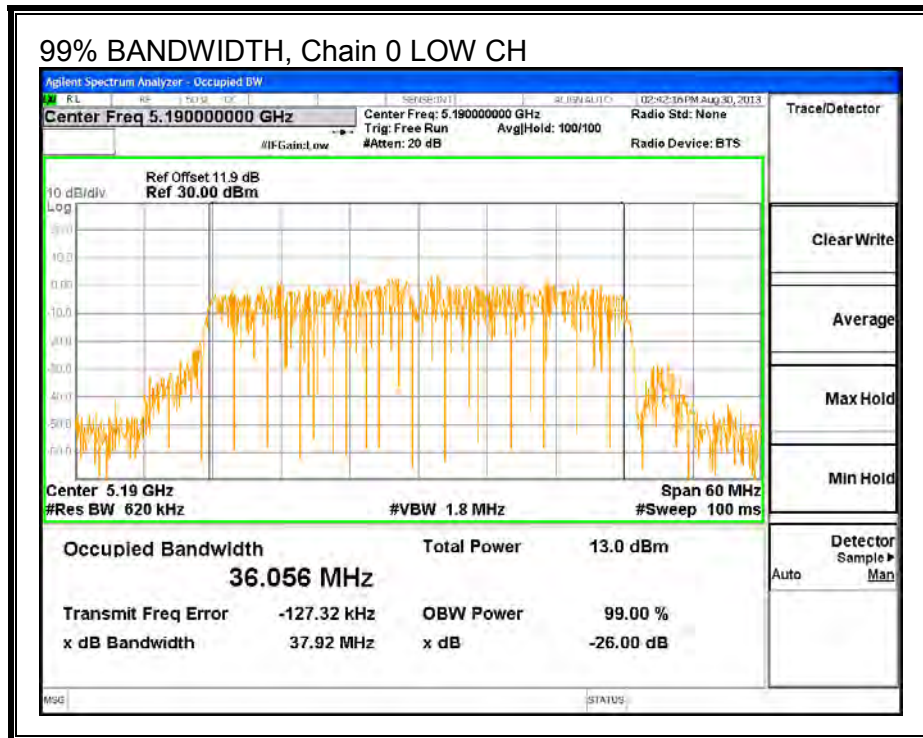

99% BANDWIDTH, Chain 1

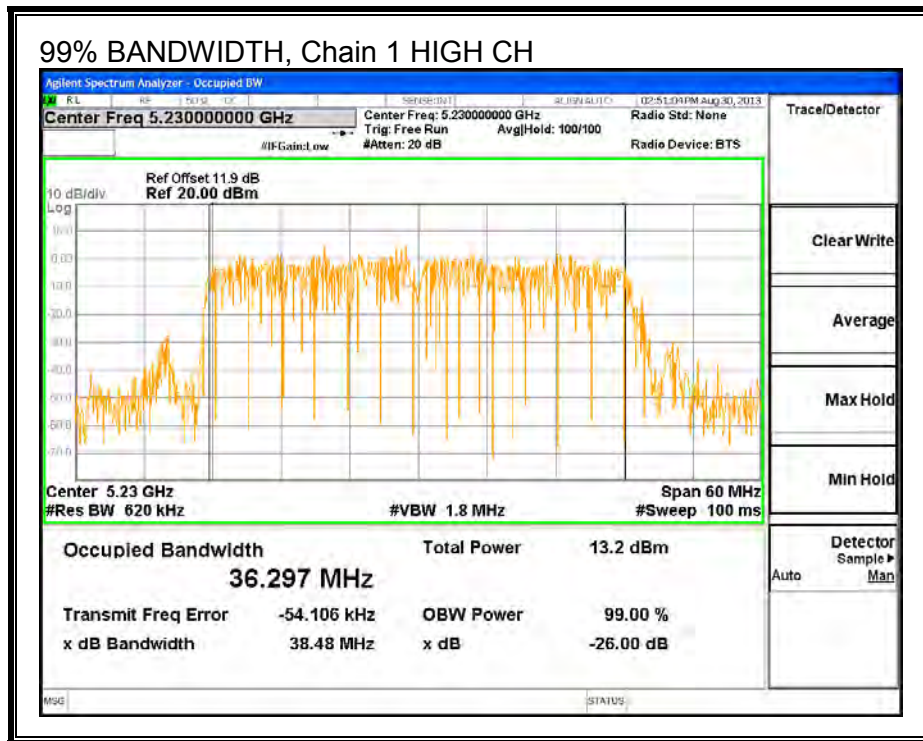
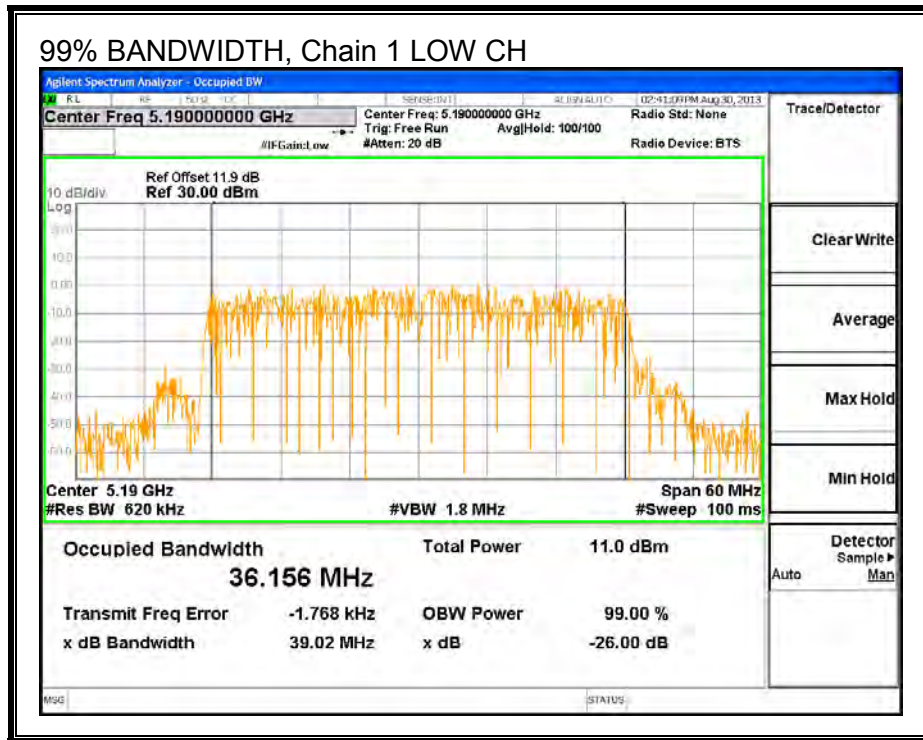

8.4.3. AVERAGE POWER

LIMITS

None; for reporting purposes only.

TEST PROCEDURE

The transmitter output is connected to a power meter.

The cable assembly insertion loss of 11.9 dB (including 10 dB pad and 1.9 dB cable) was entered as an offset in the power meter to allow for direct reading of power.

RESULTS

Average Power Results

Channel	Frequency (MHz)	Chain 0 Power (dBm)	Chain 1 Power (dBm)	Total Power (dBm)
Low	5190	11.45	11.40	14.44
High	5230	13.50	13.40	16.46

8.4.4. OUTPUT POWER AND PPSD

LIMITS

FCC §15.407 (a) (1)

(i) For an outdoor access point operating in the band 5.15-5.25 GHz, the maximum conducted output power over the frequency band of operation shall not exceed 1 W provided the maximum antenna gain does not exceed 6 dBi. In addition, the maximum power spectral density shall not exceed 17 dBm in any 1 megahertz band. If transmitting antennas of directional gain greater than 6 dBi are used, both the maximum conducted output power and the maximum power spectral density shall be reduced by the amount in dB that the directional gain of the antenna exceeds 6 dBi. The maximum e.i.r.p. at any elevation angle above 30 degrees as measured from the horizon must not exceed 125 mW (21 dBm).

(ii) For an indoor access point operating in the band 5.15-5.25 GHz, the maximum conducted output power over the frequency band of operation shall not exceed 1 W provided the maximum antenna gain does not exceed 6 dBi. In addition, the maximum power spectral density shall not exceed 17 dBm in any 1 megahertz band. If transmitting antennas of directional gain greater than 6 dBi are used, both the maximum conducted output power and the maximum power spectral density shall be reduced by the amount in dB that the directional gain of the antenna exceeds 6 dBi.

(iii) For fixed point-to-point access points operating in the band 5.15-5.25 GHz, the maximum conducted output power over the frequency band of operation shall not exceed 1 W. Fixed point-to-point U-NII devices may employ antennas with directional gain up to 23 dBi without any corresponding reduction in the maximum conducted output power or maximum power spectral density. For fixed point-to-point transmitters that employ a directional antenna gain greater than 23 dBi, a 1 dB reduction in maximum conducted output power and maximum power spectral density is required for each 1 dB of antenna gain in excess of 23 dBi. Fixed, point-to-point operations exclude the use of point-to-multipoint systems, omnidirectional applications, and multiple collocated transmitters transmitting the same information. The operator of the U-NII device, or if the equipment is professionally installed, the installer, is responsible for ensuring that systems employing high gain directional antennas are used exclusively for fixed, point-to-point operations.

(iv) For mobile and portable client devices in the 5.15-5.25 GHz band, the maximum conducted output power over the frequency band of operation shall not exceed 250 mW provided the maximum antenna gain does not exceed 6 dBi. In addition, the maximum power spectral density shall not exceed 11 dBm in any 1 megahertz band. If transmitting antennas of directional gain greater than 6 dBi are used, both the maximum conducted output power and the maximum power spectral density shall be reduced by the amount in dB that the directional gain of the antenna exceeds 6 dBi.

DIRECTIONAL ANTENNA GAIN

The TX chains are uncorrelated and the antenna gain is unequal among the chains. The directional gain is:

Chain 0 Antenna Gain (dBi)	Chain 1 Antenna Gain (dBi)	Uncorrelated Chains Directional Gain (dBi)
-0.02	3.06	1.79

The TX chains are correlated and the antenna gain is unequal among the chains. The directional gain is:

Chain 0 Antenna Gain (dBi)	Chain 1 Antenna Gain (dBi)	Correlated Chains Directional Gain (dBi)
-0.02	3.06	4.67

RESULTS

Antenna Gain

Channel	Frequency (MHz)	Uncorrelated Directional Gain (dBi)	Correlated Directional Gain (dBi)
Low	5190	1.79	4.67
High	5230	1.79	4.67

Limits

Channel	Frequency (MHz)	FCC Power Limit (dBm)	FCC PPSD Limit (dBm)
Low	5190	24.00	11.00
High	5230	24.00	11.00

Duty Cycle CF (dB)	0.00	Included in Calculations of Corr'd Power & PPSD
---------------------------	------	--

Output Power Results

Channel	Frequency (MHz)	Chain 0 Meas Power (dBm)	Chain 1 Meas Power (dBm)	Total Corr'd Power (dBm)	Power Limit (dBm)	Power Margin (dB)
Low	5190	11.60	11.65	14.63	24.00	-9.37
High	5230	13.72	13.53	16.64	24.00	-7.36

PPSD Results

Channel	Frequency (MHz)	Chain 0 Meas PPSD (dBm)	Chain 1 Meas PPSD (dBm)	Total Corr'd PPSD (dBm)	PPSD Limit (dBm)	PPSD Margin (dB)
Low	5190	-2.26	-0.88	1.50	11.00	-9.50
High	5230	0.77	1.09	3.94	11.00	-7.06

OUTPUT POWER AND PPSD, Chain 0

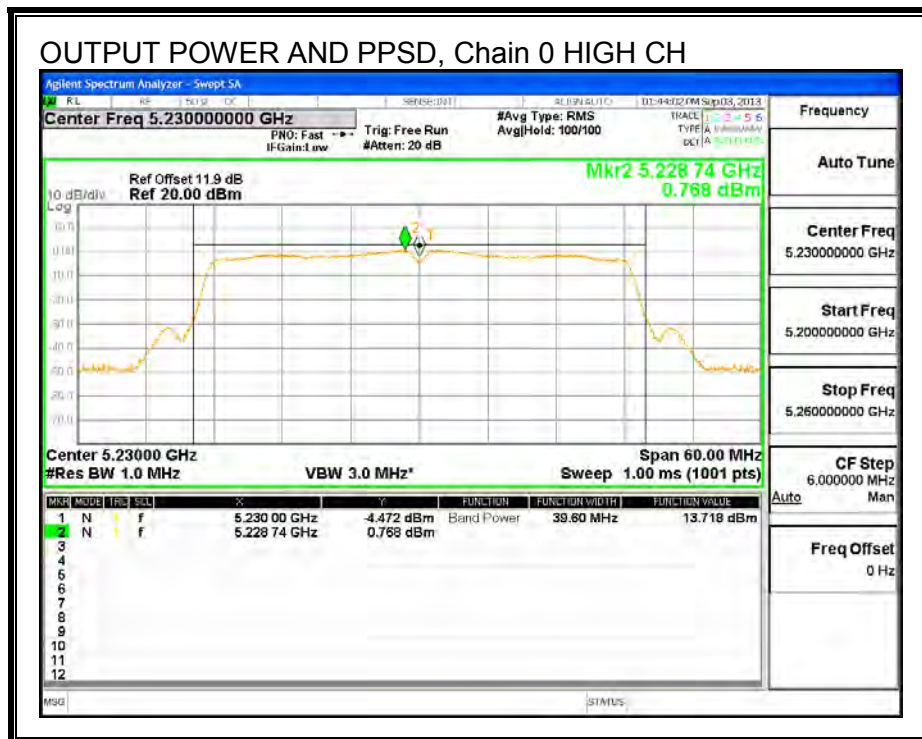
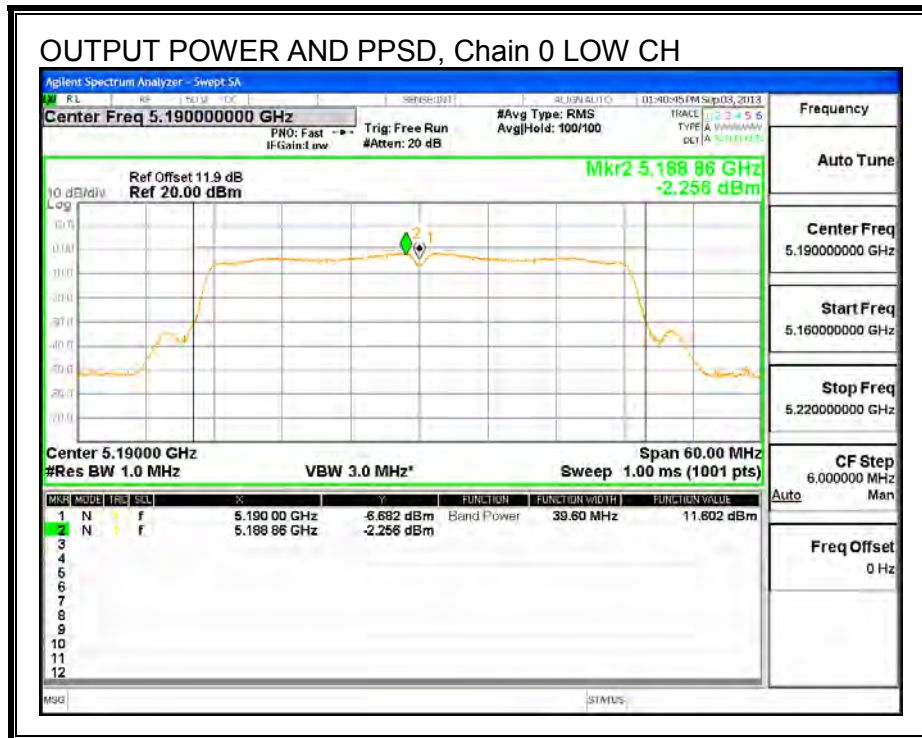

OUTPUT POWER AND PPSD, Chain 1

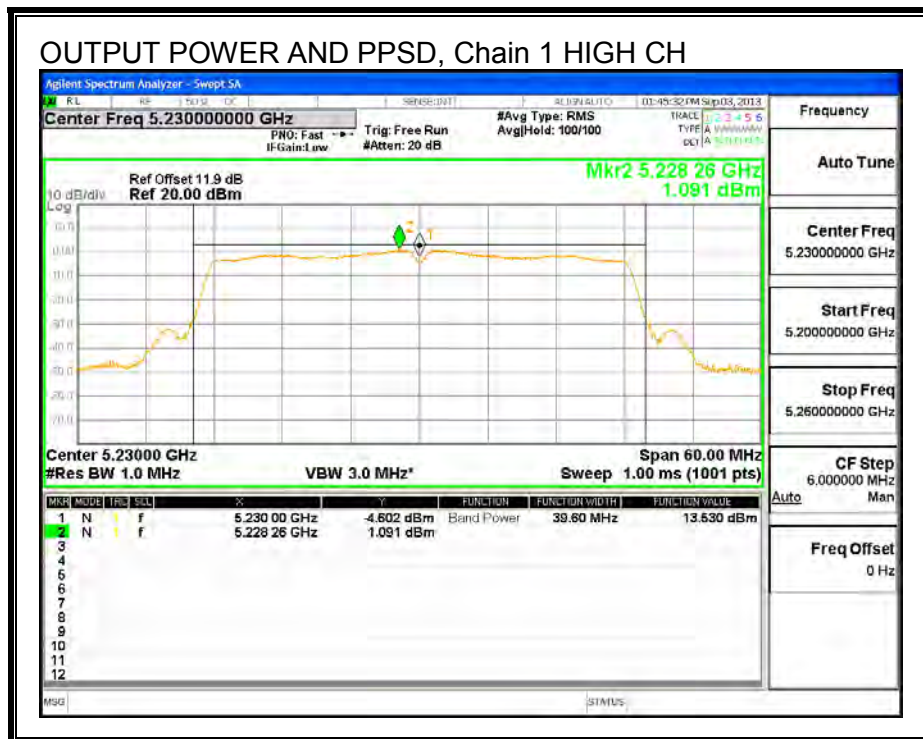
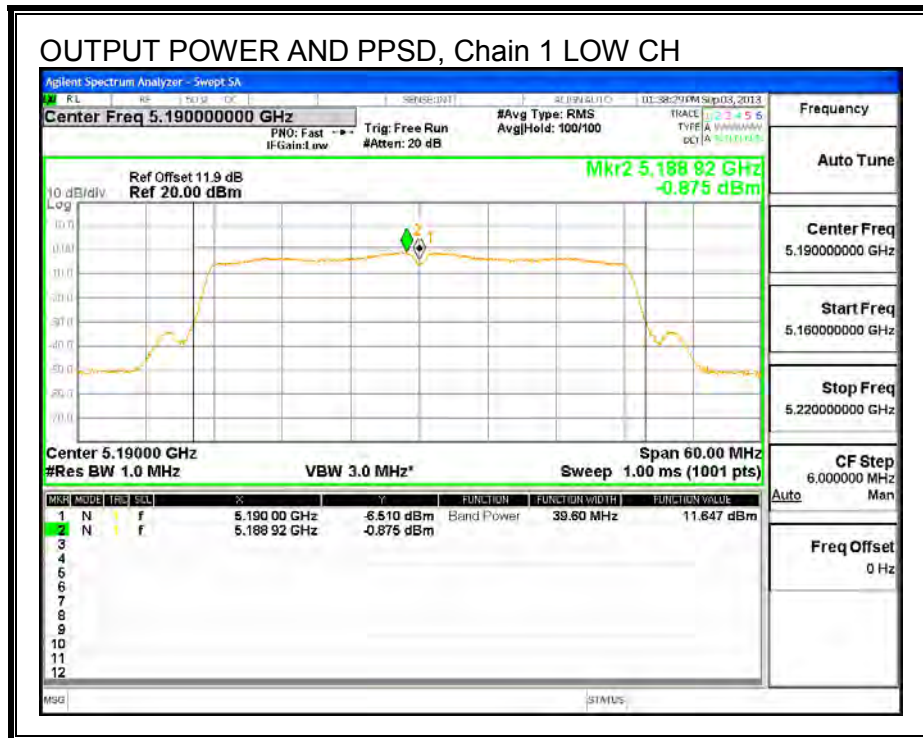

8.5. 802.11a SISO MODE IN THE 5.3 GHz BAND

8.5.1. 26 dB BANDWIDTH

LIMITS

None; for reporting purposes only.

RESULTS

Channel	Frequency (MHz)	26 dB Bandwidth (MHz)
Low	5260	20.36
Mid	5300	20.27
High	5320	20.26

26 dB BANDWIDTH

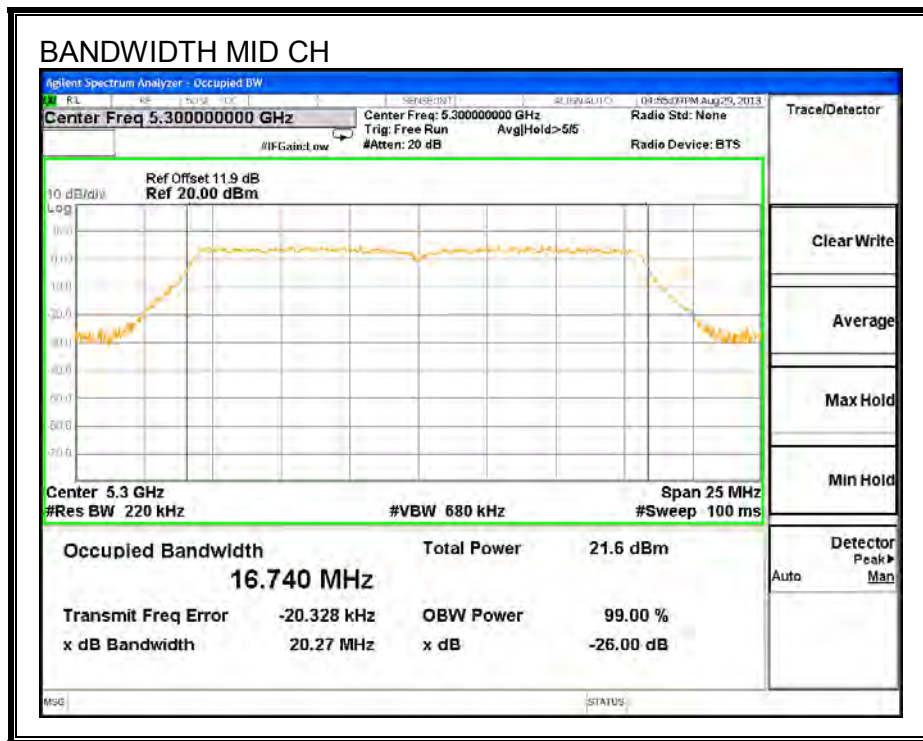
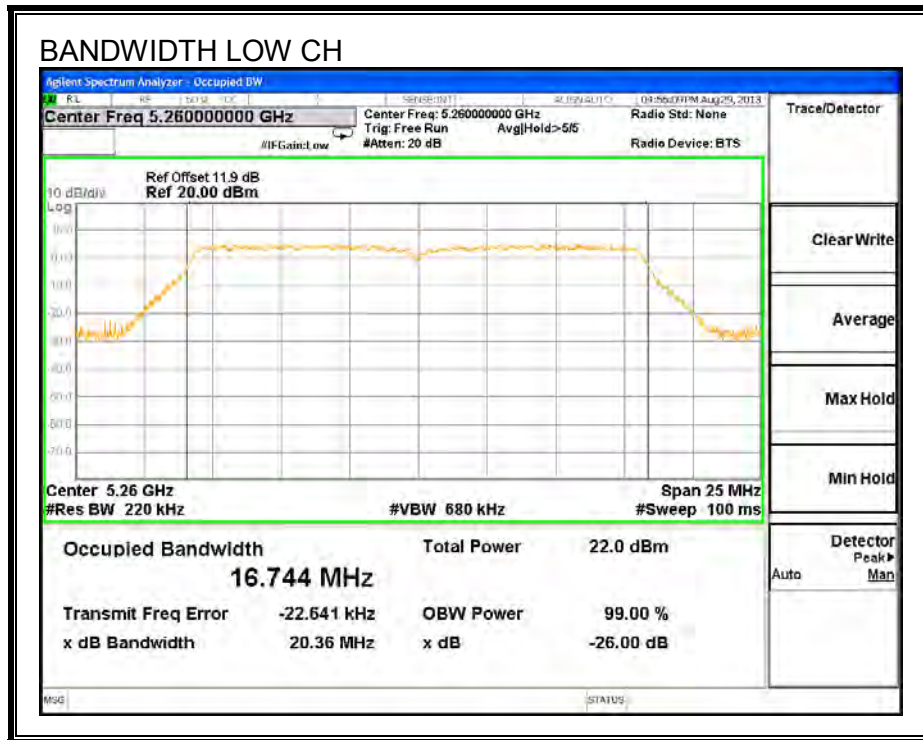

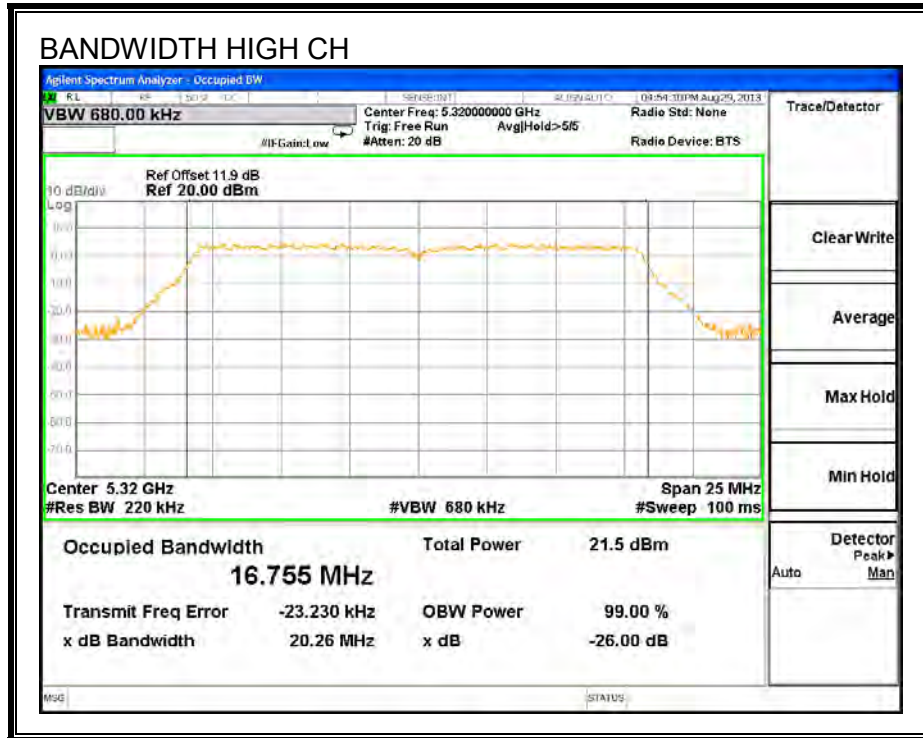

8.5.2. 99% BANDWIDTH

LIMITS

None; for reporting purposes only.

RESULTS

Channel	Frequency (MHz)	99% Bandwidth (MHz)
Low	5260	16.673
Mid	5300	16.589
High	5320	16.599

99% BANDWIDTH

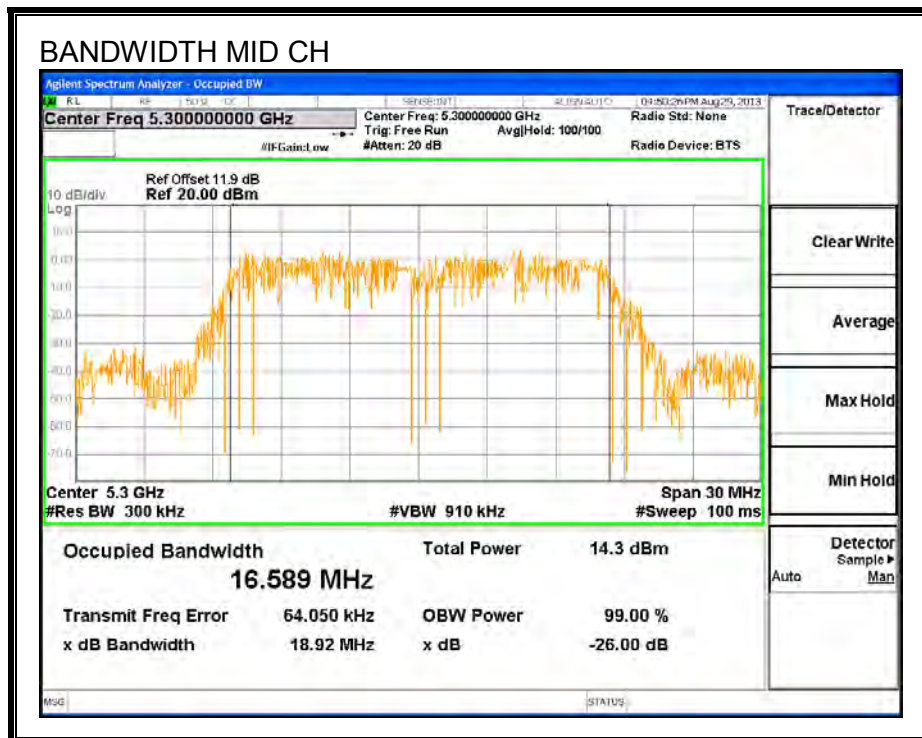
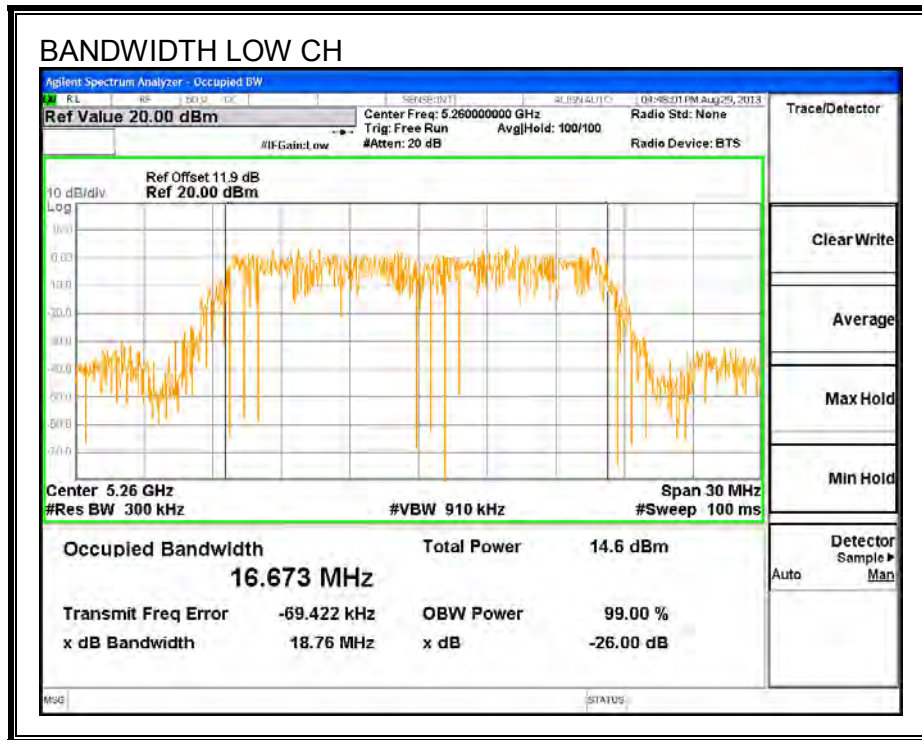

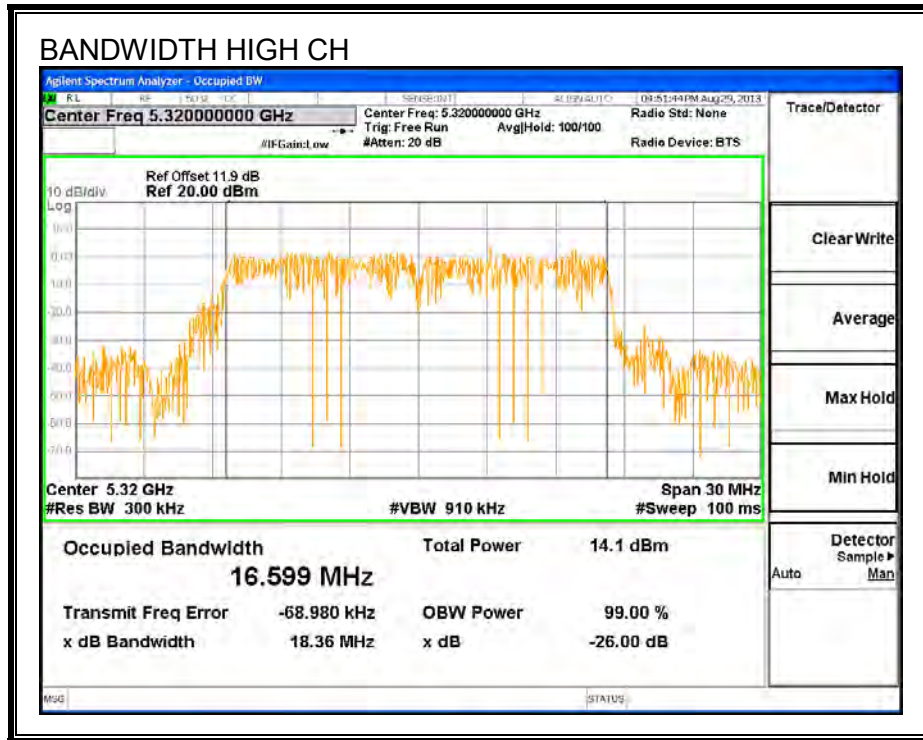

8.5.3. AVERAGE POWER

LIMITS

None; for reporting purposes only.

TEST PROCEDURE

The transmitter output is connected to a power meter.

The cable assembly insertion loss of 11.9 dB (including 10 dB pad and 1.9 dB cable) was entered as an offset in the power meter to allow for direct reading of power.

RESULTS

Channel	Frequency (MHz)	Power (dBm)
Low	5260	16.00
Mid	5300	16.00
High	5320	14.95

8.5.4. OUTPUT POWER AND PPSD

LIMITS

FCC §15.407 (a) (2)

For the band 5.25–5.35 GHz, the maximum conducted output power over the frequency band of operation shall not exceed the lesser of 250 mW or $11 \text{ dBm} + 10 \log B$, where B is the 26–dB emission bandwidth in MHz. In addition, the maximum power spectral density shall not exceed 11 dBm in any 1–MHz band. If transmitting antennas of directional gain greater than 6 dBi are used, both the maximum conducted output power and the peak power spectral density shall be reduced by the amount in dB that the directional gain of the antenna exceeds 6 dBi.

DIRECTIONAL ANTENNA GAIN

There is only one transmitter output therefore the directional gain is equal to the antenna gain.

RESULTS

Bandwidth and Antenna Gain

Channel	Frequency (MHz)	Min 26 dB BW (MHz)	Directio Gain (dBi)
Low	5260	20.4	3.25
Mid	5300	20.3	3.25
High	5320	20.3	3.25

Limits

Channel	Frequency (MHz)	FCC Power Limit (dBm)	FCC PPSD Limit (dBm)
Low	5260	24.00	11.00
Mid	5300	24.00	11.00
High	5320	24.00	11.00

Duty Cycle CF (dB)	0.00	Included in Calculations of Corr'd Power & PPSD
---------------------------	------	--

Output Power Results

Channel	Frequency (MHz)	Chain 0 Meas Power (dBm)	Total Corr'd Power (dBm)	Power Limit (dBm)	Power Margin (dB)
Low	5260	16.15	16.15	24.00	-7.85
Mid	5300	16.11	16.11	24.00	-7.89
High	5320	15.15	15.15	24.00	-8.85

PPSD Results

Channel	Frequency (MHz)	Chain 0 Meas PPSD (dBm)	Total Corr'd PPSD (dBm)	PPSD Limit (dBm)	PPSD Margin (dB)
Low	5260	5.17	5.17	11.00	-5.83
Mid	5300	4.79	4.79	11.00	-6.21
High	5320	3.93	3.93	11.00	-7.07

OUTPUT POWER AND PPSD, Chain 0

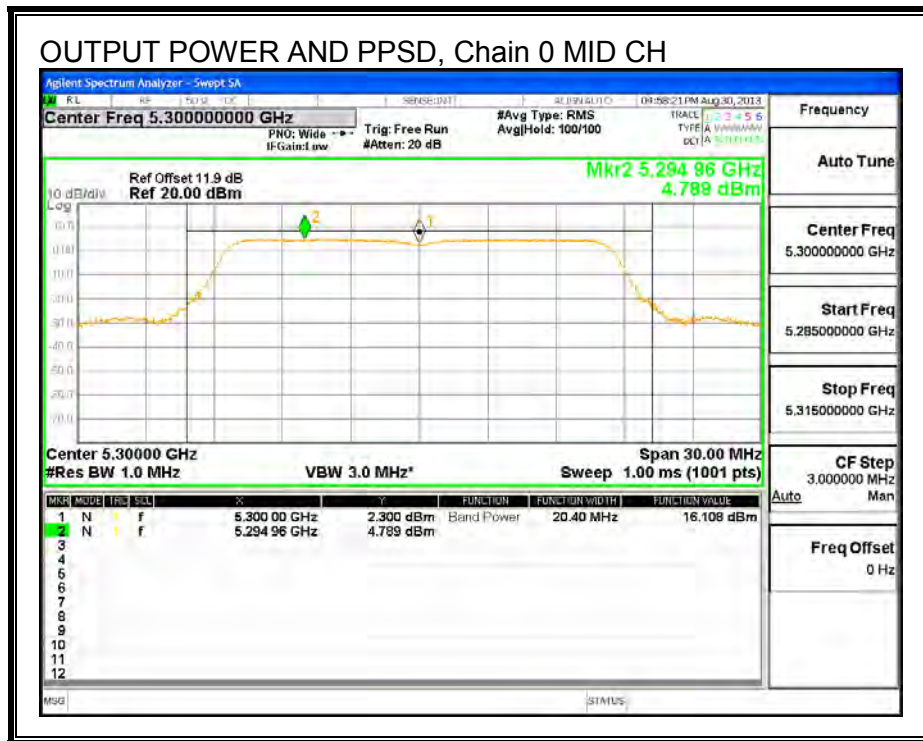
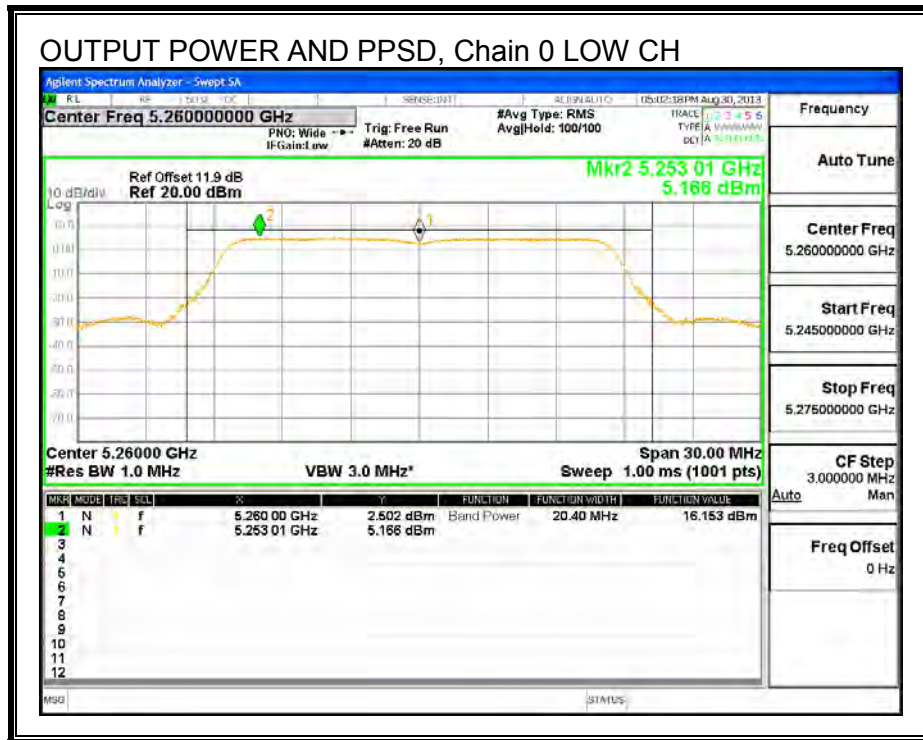

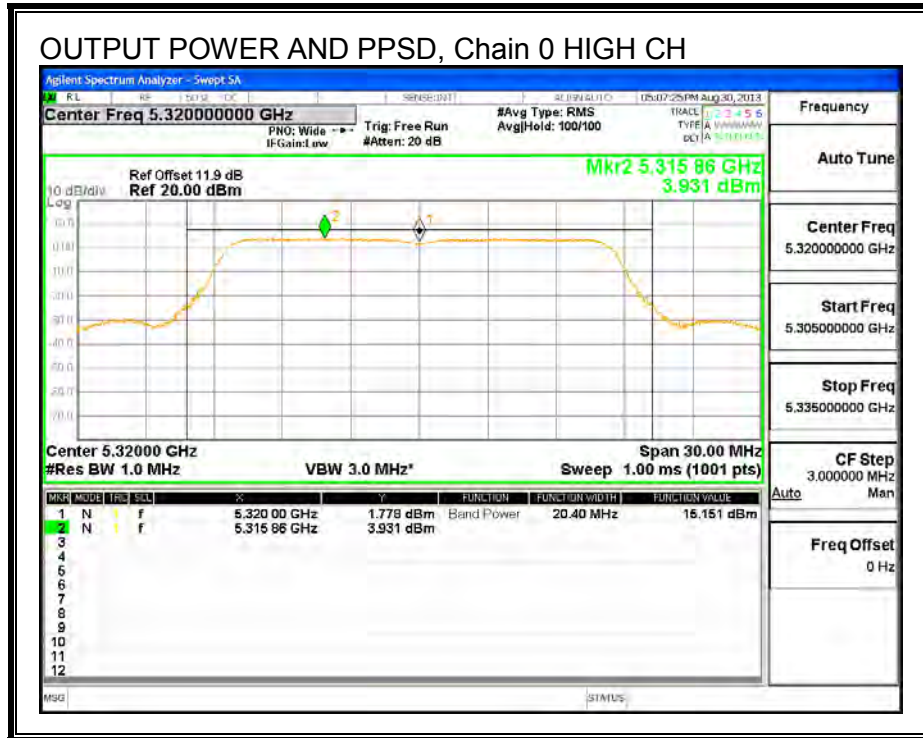

8.6. 802.11n HT20 2TX CDD MODE IN THE 5.3 GHZ BAND

8.6.1. 26 dB BANDWIDTH

LIMITS

None; for reporting purposes only.

RESULTS

Channel	Frequency (MHz)	26 dB BW Chain 0 (MHz)	26 dB BW Chain 1 (MHz)
Low	5260	20.49	20.65
Mid	5300	20.58	21.09
High	5320	20.46	20.54

26 dB BANDWIDTH, Chain 0

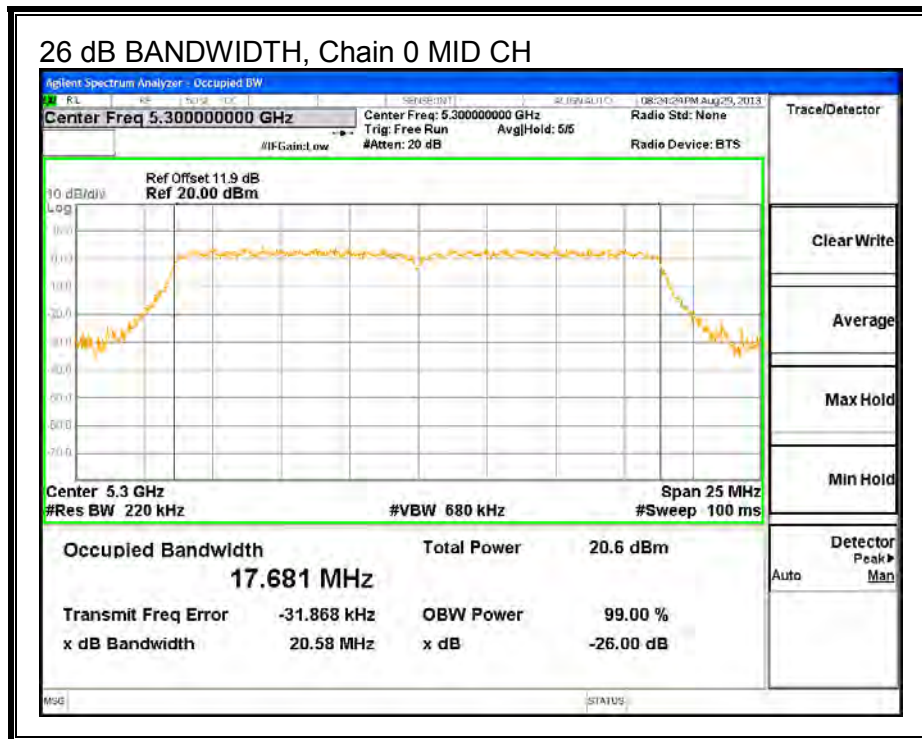
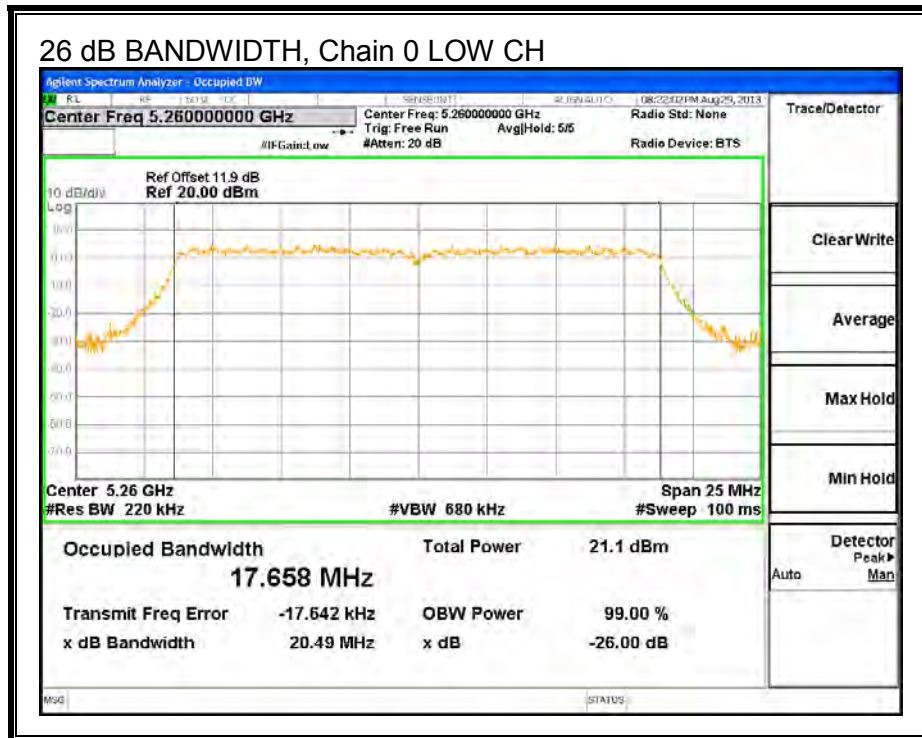

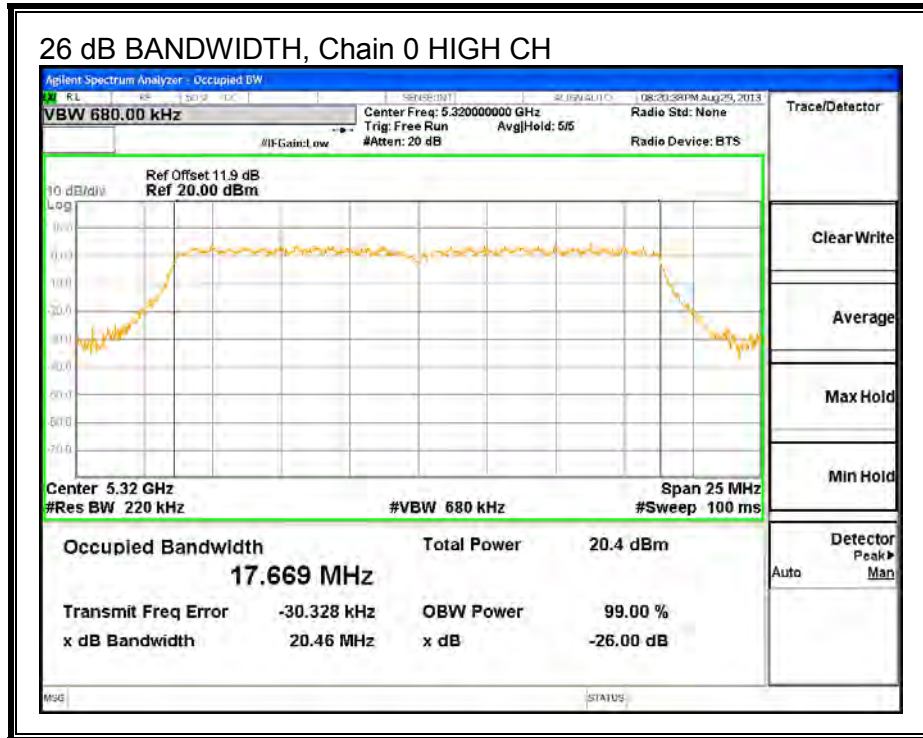

26 dB BANDWIDTH, Chain 1

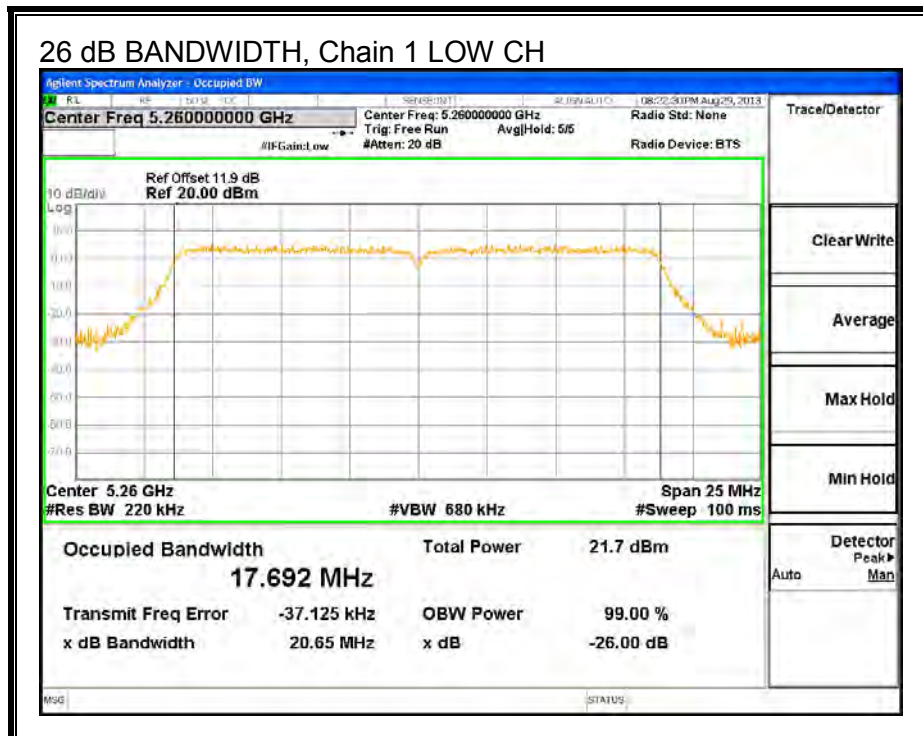

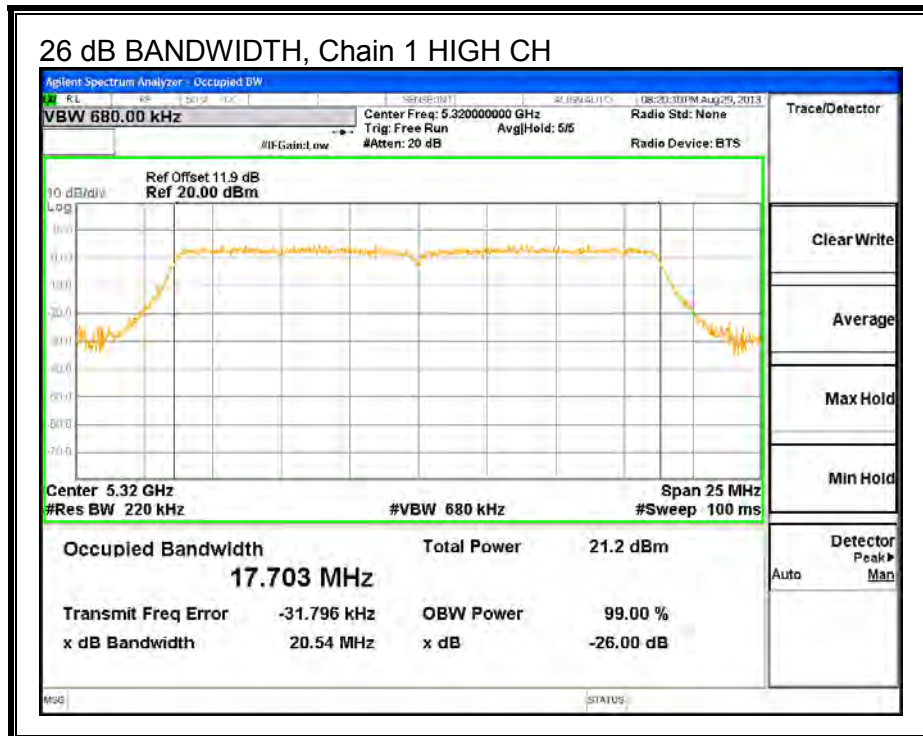
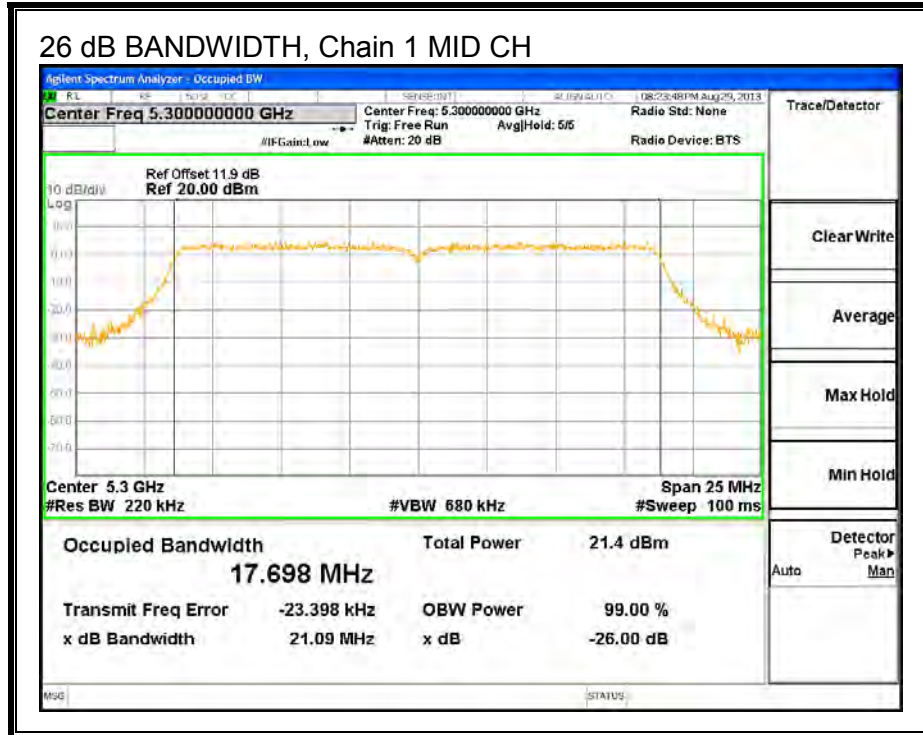

8.6.2. 99% BANDWIDTH

LIMITS

None; for reporting purposes only.

RESULTS

Channel	Frequency (MHz)	99% BW Chain 0 (MHz)	99% BW Chain 1 (MHz)
Low	5260	17.714	17.678
Mid	5300	17.509	17.674
High	5320	17.754	17.720

99% BANDWIDTH, Chain 0

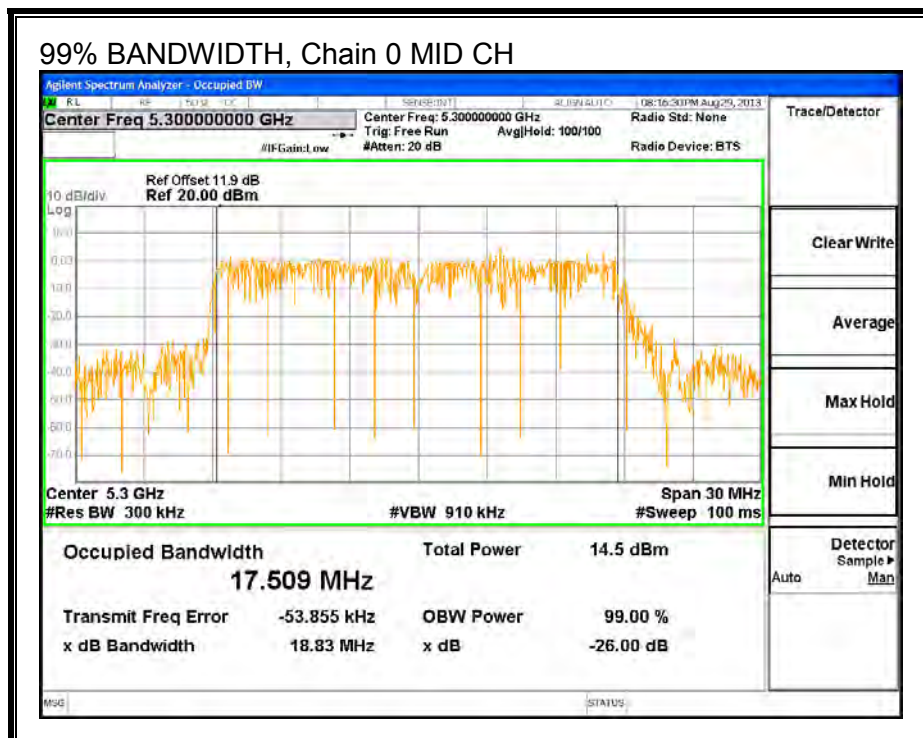
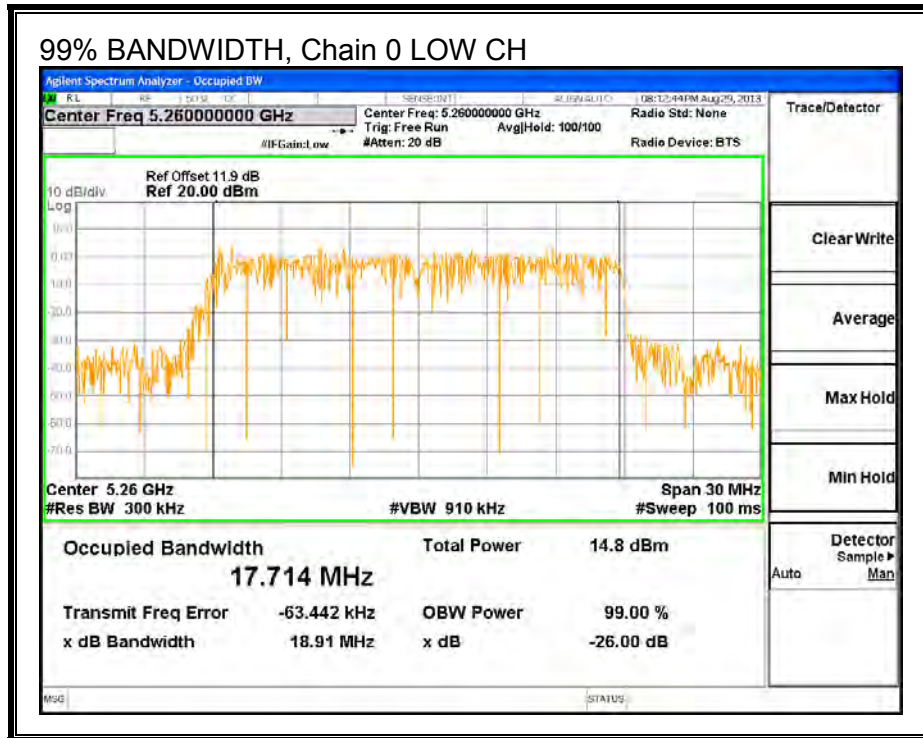

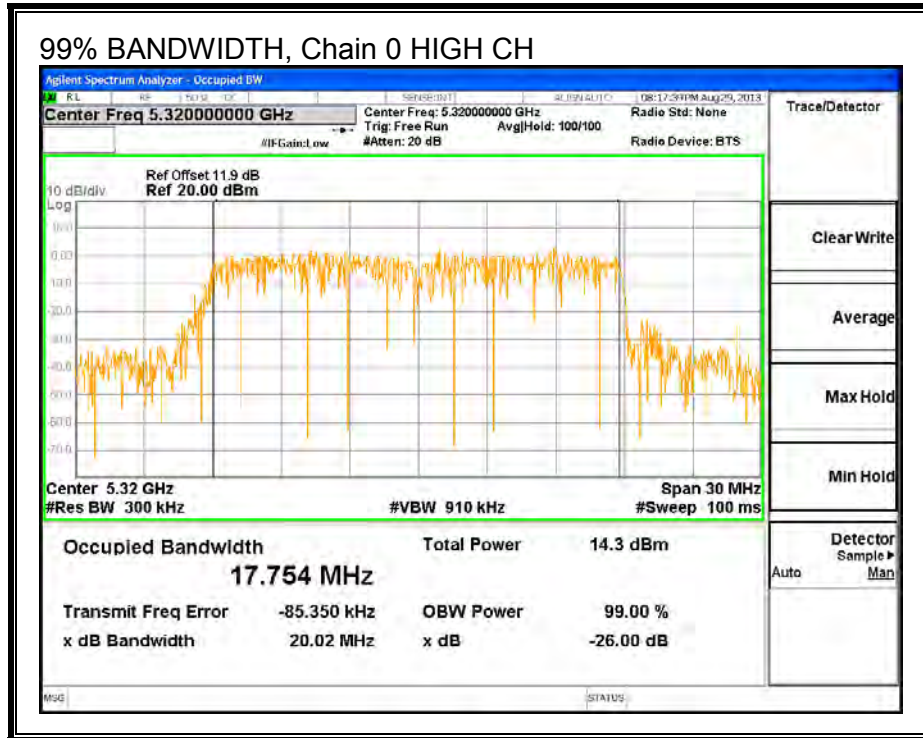

99% BANDWIDTH, Chain 1

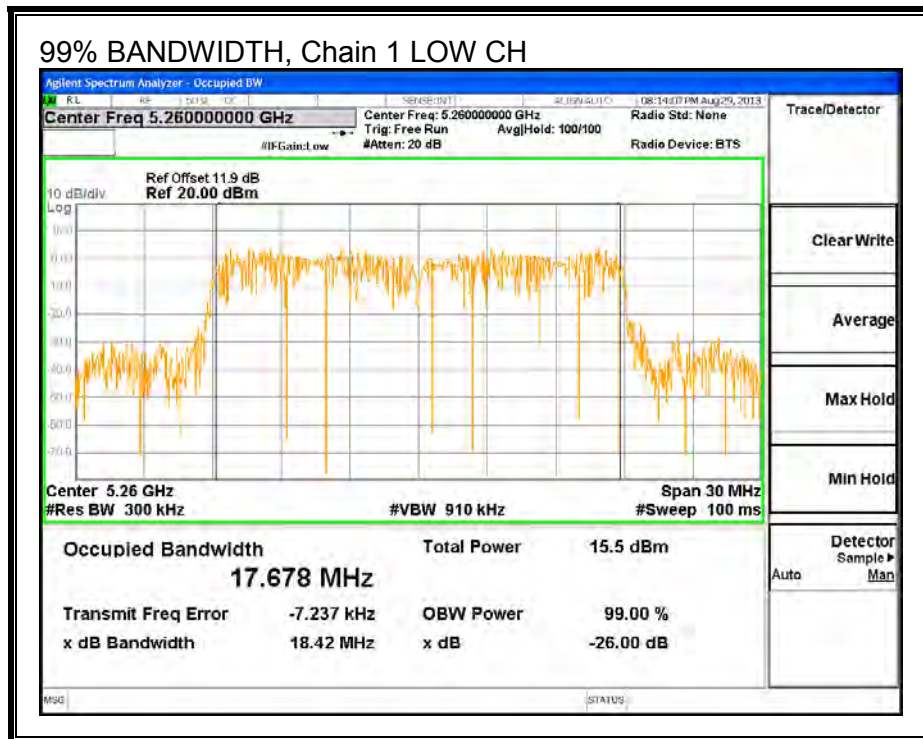

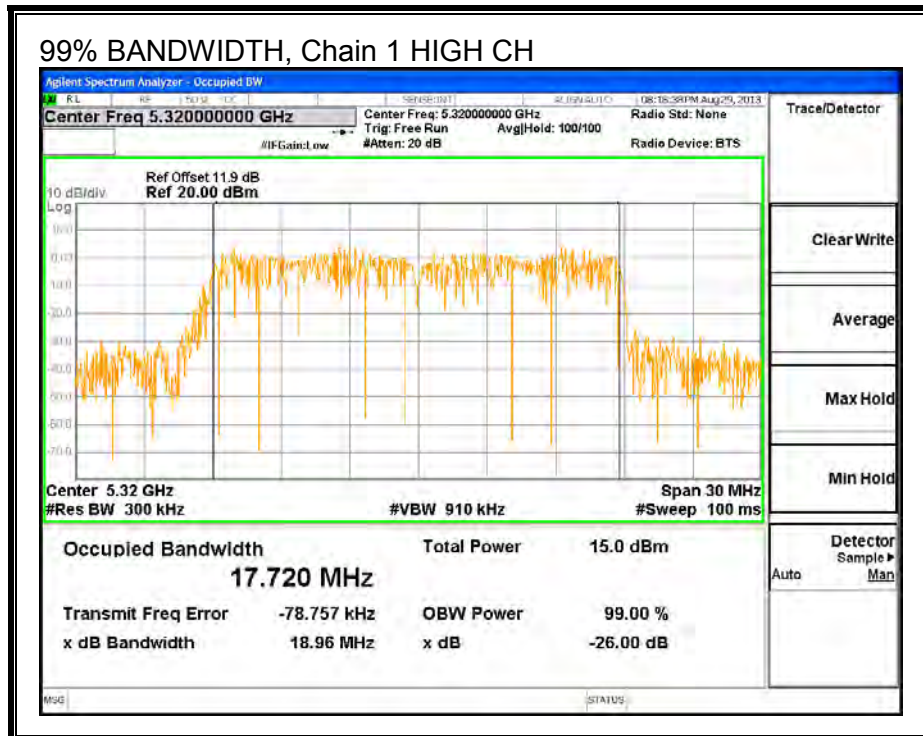
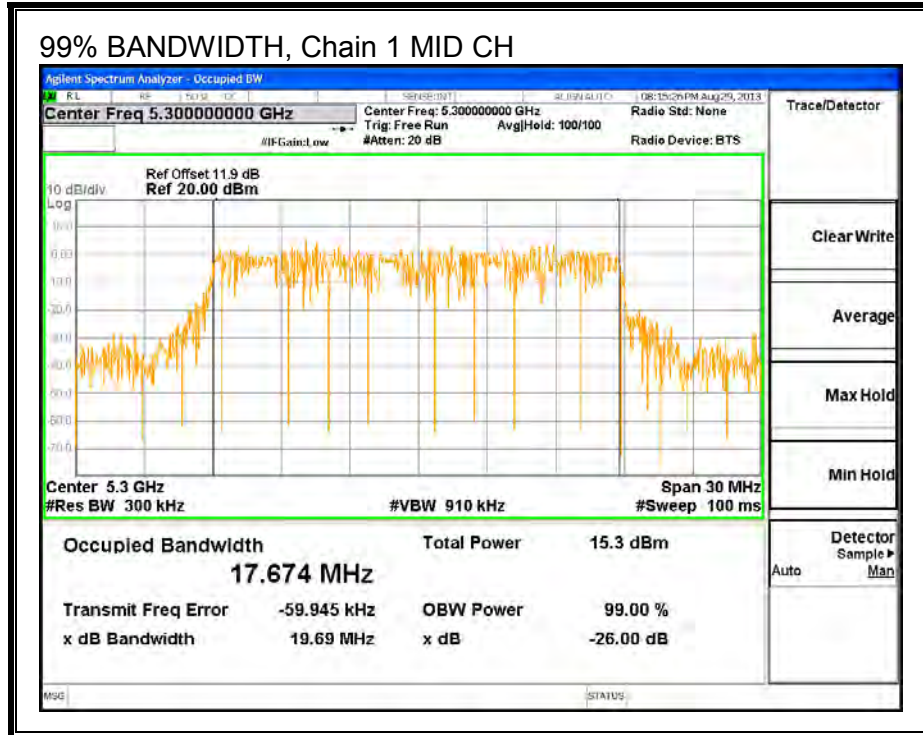

8.6.3. AVERAGE POWER

LIMITS

None; for reporting purposes only.

TEST PROCEDURE

The transmitter output is connected to a power meter.

The cable assembly insertion loss of 11.9 dB (including 10 dB pad and 1.9 dB cable) was entered as an offset in the power meter to allow for direct reading of power.

RESULTS

Average Power Results

Channel	Frequency (MHz)	Chain 0 Power (dBm)	Chain 1 Power (dBm)	Total Power (dBm)
Low	5260	15.90	16.00	18.96
Mid	5300	15.98	16.00	19.00
High	5320	13.99	13.97	16.99

8.6.4. OUTPUT POWER AND PPSD

LIMITS

FCC §15.407 (a) (2)

For the band 5.25–5.35 GHz, the maximum conducted output power over the frequency band of operation shall not exceed the lesser of 250 mW or 11 dBm + 10 log B, where B is the 26–dB emission bandwidth in MHz. In addition, the maximum power spectral density shall not exceed 11 dBm in any 1–MHz band. If transmitting antennas of directional gain greater than 6 dBi are used, both the maximum conducted output power and the peak power spectral density shall be reduced by the amount in dB that the directional gain of the antenna exceeds 6 dBi.

DIRECTIONAL ANTENNA GAIN

The TX chains are uncorrelated and the antenna gain is unequal among the chains. The directional gain is:

Chain 0 Antenna Gain (dBi)	Chain 1 Antenna Gain (dBi)	Uncorrelated Chains Directional Gain (dBi)
0.75	3.25	2.18

The TX chains are correlated and the antenna gain is unequal among the chains. The directional gain is:

Chain 0 Antenna Gain (dBi)	Chain 1 Antenna Gain (dBi)	Correlated Chains Directional Gain (dBi)
0.75	3.25	5.10

RESULTS

Bandwidth and Antenna Gain

Channel	Frequency (MHz)	Min 26 dB BW (MHz)	Uncorrelated Directional Gain (dBi)	Correlated Directional Gain (dBi)
Low	5260	20.5	2.18	5.10
Mid	5300	20.6	2.18	5.10
High	5320	20.5	2.18	5.10

Limits

Channel	Frequency (MHz)	FCC Power Limit (dBm)	FCC PPSD Limit (dBm)
Low	5260	24.00	11.00
Mid	5300	24.00	11.00
High	5320	24.00	11.00

Duty Cycle CF (dB)	0.00	Included in Calculations of Corr'd Power & PPSD
---------------------------	------	--

Output Power Results

Channel	Frequency (MHz)	Chain 0 Meas Power (dBm)	Chain 1 Meas Power (dBm)	Total Corr'd Power (dBm)	Power Limit (dBm)	Power Margin (dB)
Low	5260	16.08	16.15	19.12	24.00	-4.88
Mid	5300	16.19	16.07	19.14	24.00	-4.86
High	5320	14.34	14.12	17.24	24.00	-6.76

PPSD Results

Channel	Frequency (MHz)	Chain 0 Meas PPSD (dBm)	Chain 1 Meas PPSD (dBm)	Total Corr'd PPSD (dBm)	PPSD Limit (dBm)	PPSD Margin (dB)
Low	5260	4.36	4.46	7.42	11.00	-3.58
Mid	5300	4.52	4.26	7.40	11.00	-3.60
High	5320	3.14	2.75	5.96	11.00	-5.04

OUTPUT POWER AND PPSD, Chain 0

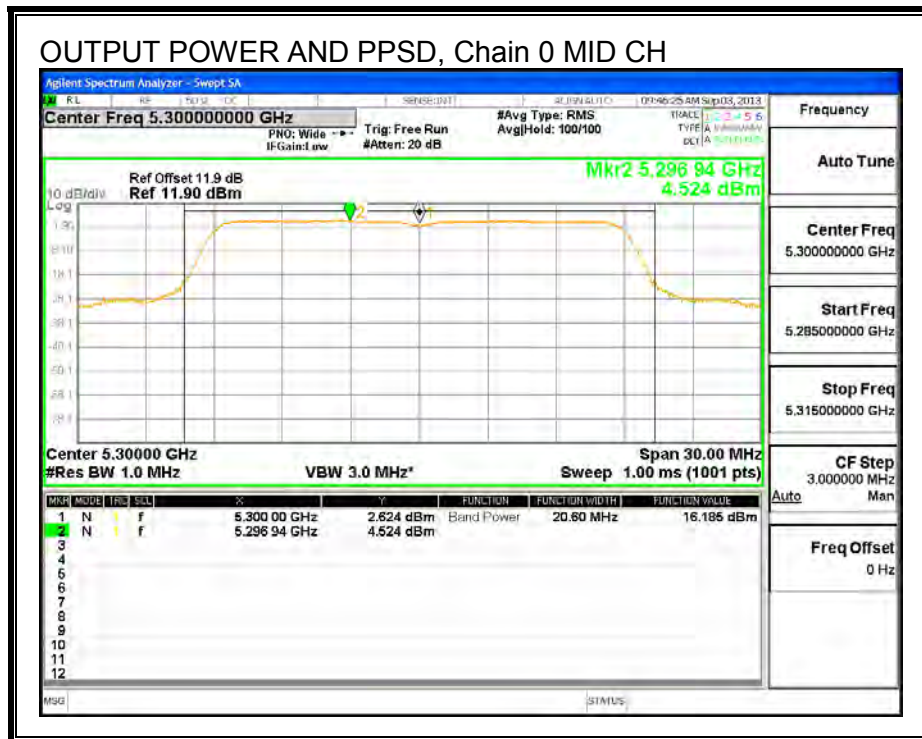
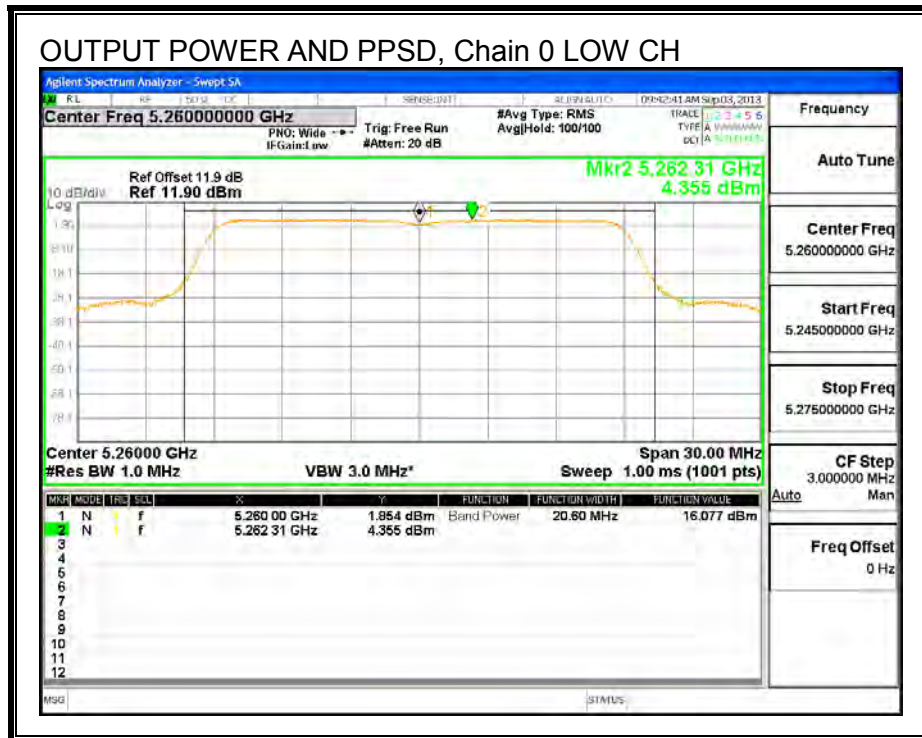

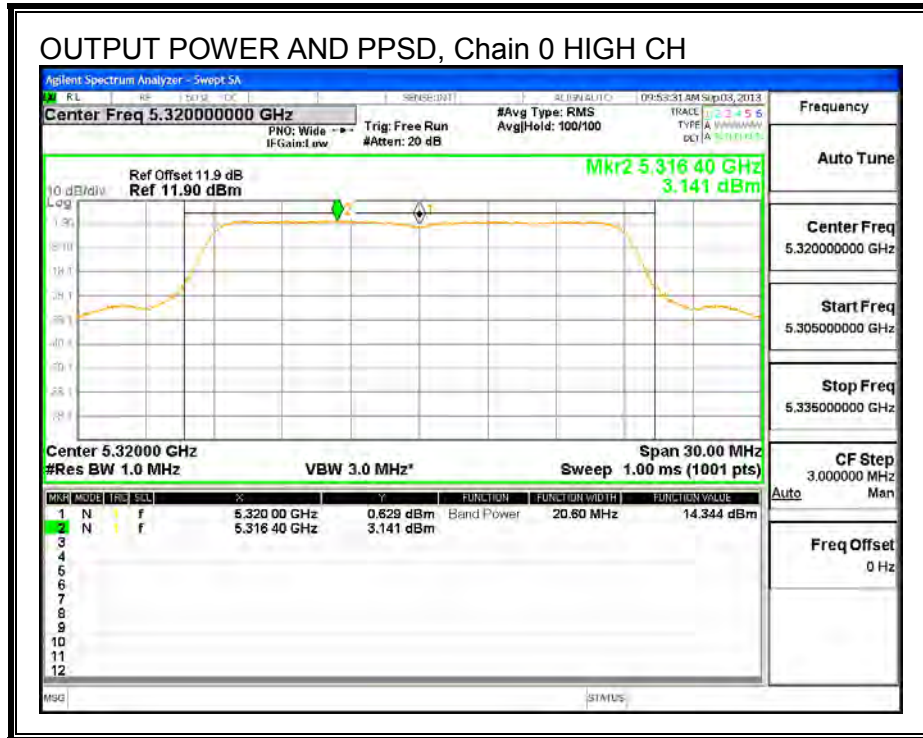

OUTPUT POWER AND PPSD, Chain 1

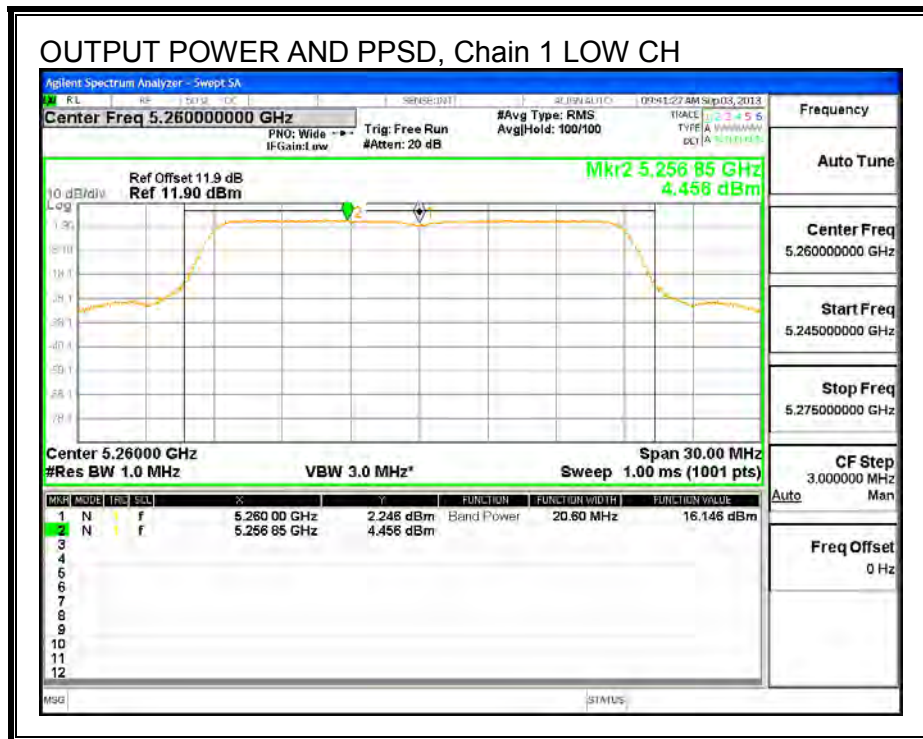

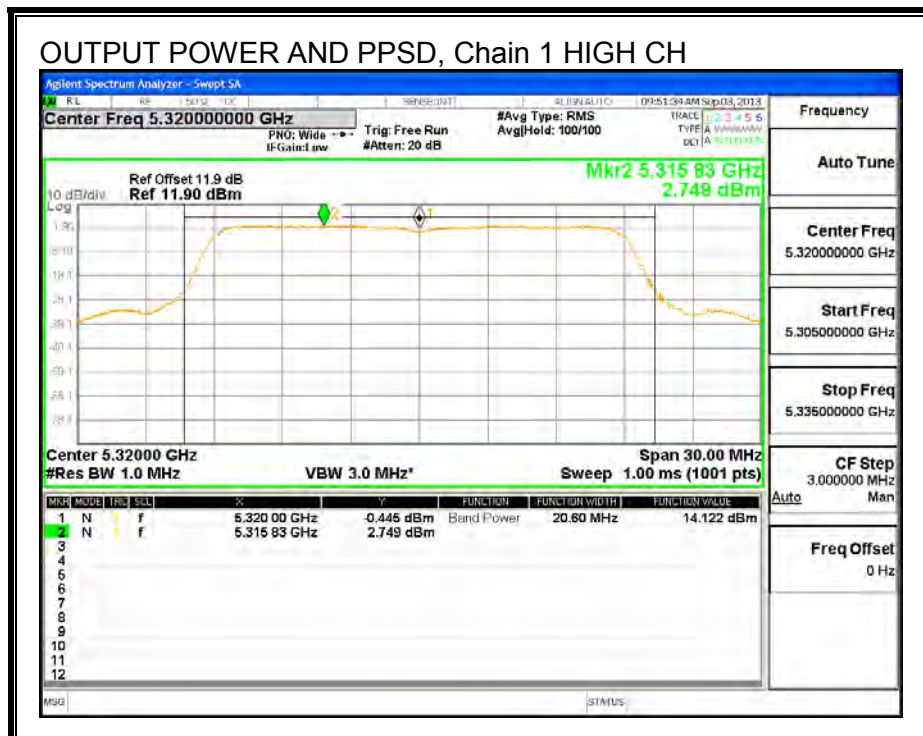
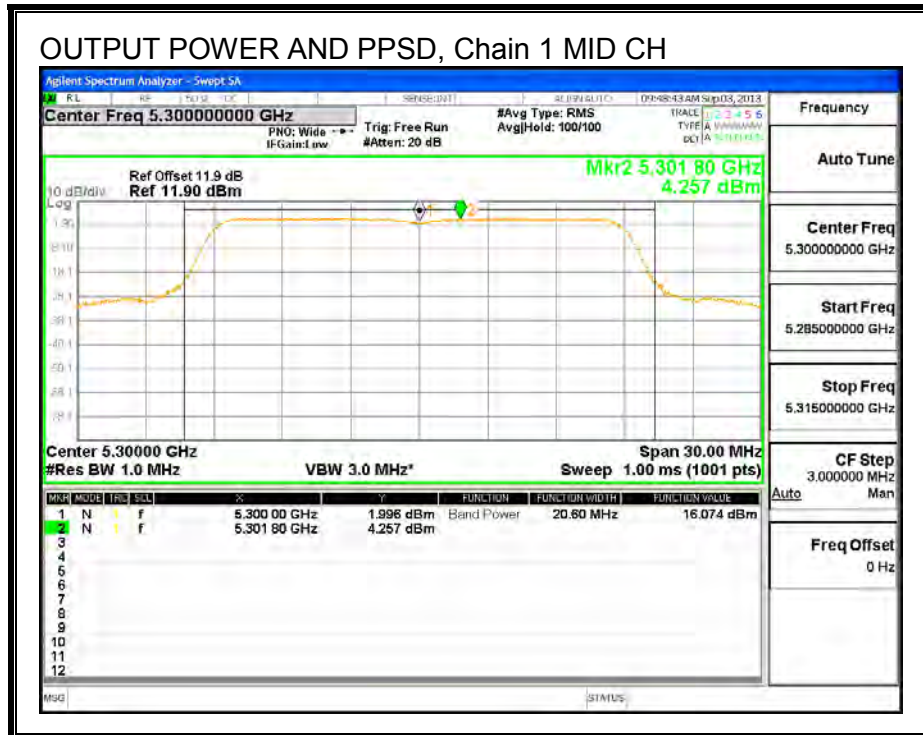

8.7. 802.11n HT40 SISO MODE IN THE 5.3 GHz BAND

8.7.1. 26 dB BANDWIDTH

LIMITS

None; for reporting purposes only.

RESULTS

Channel	Frequency (MHz)	26 dB Bandwidth (MHz)
Low	5270	39.39
High	5310	38.91

26 dB BANDWIDTH

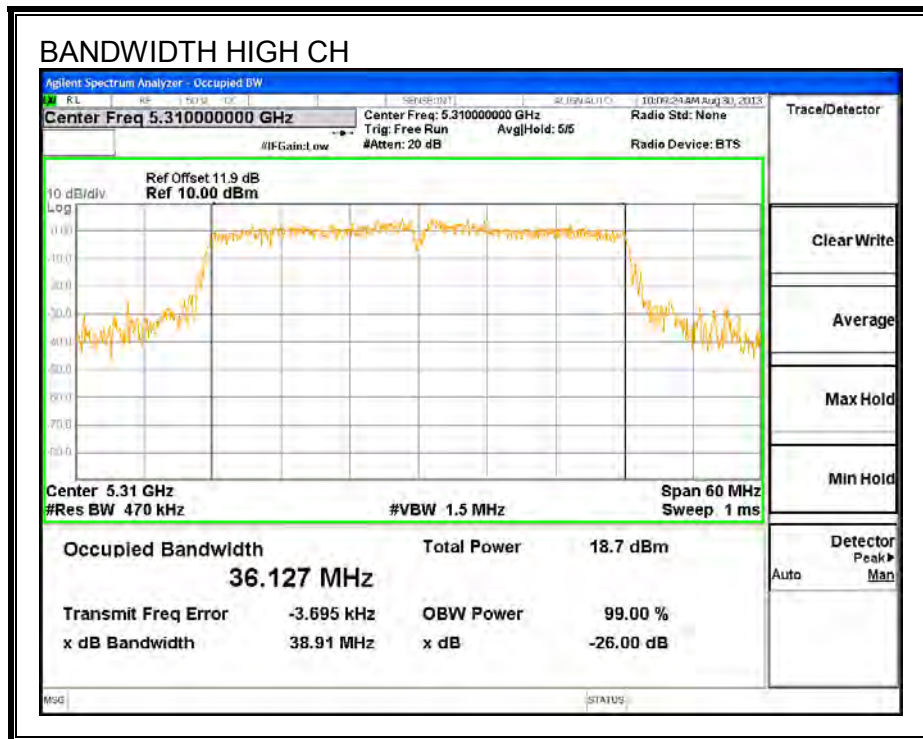
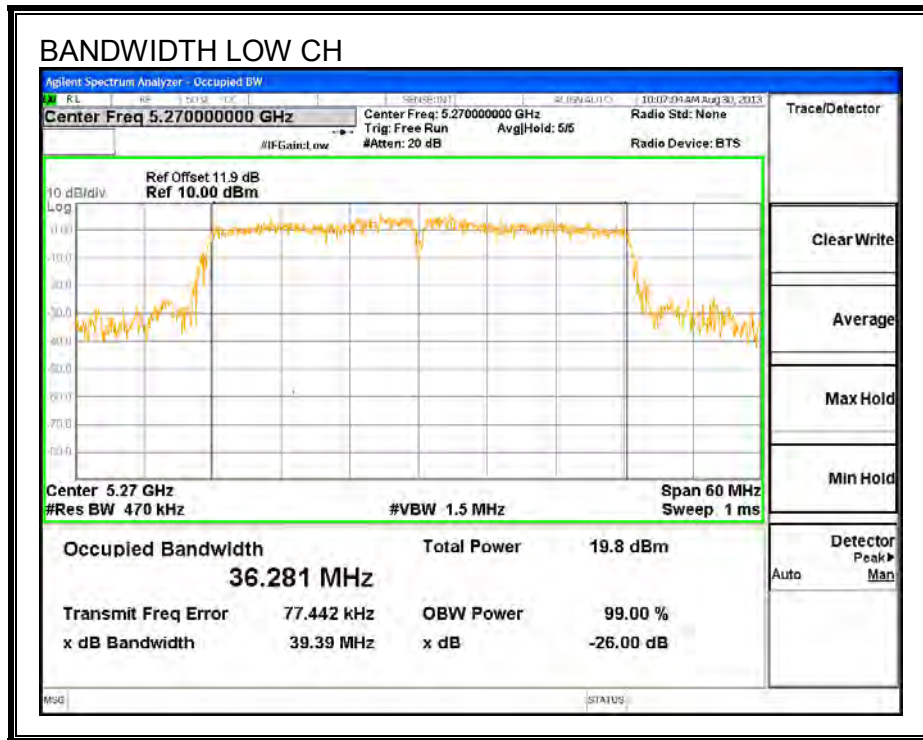

8.7.2. 99% BANDWIDTH

LIMITS

None; for reporting purposes only.

RESULTS

Channel	Frequency (MHz)	99% Bandwidth (MHz)
Low	5270	36.120
High	5310	36.200

99% BANDWIDTH

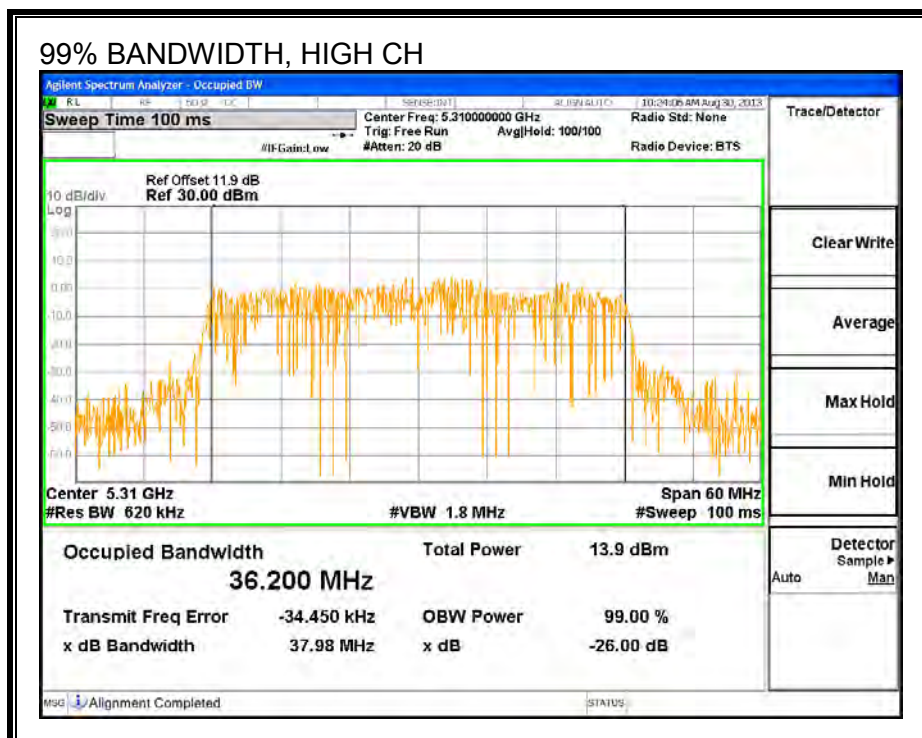
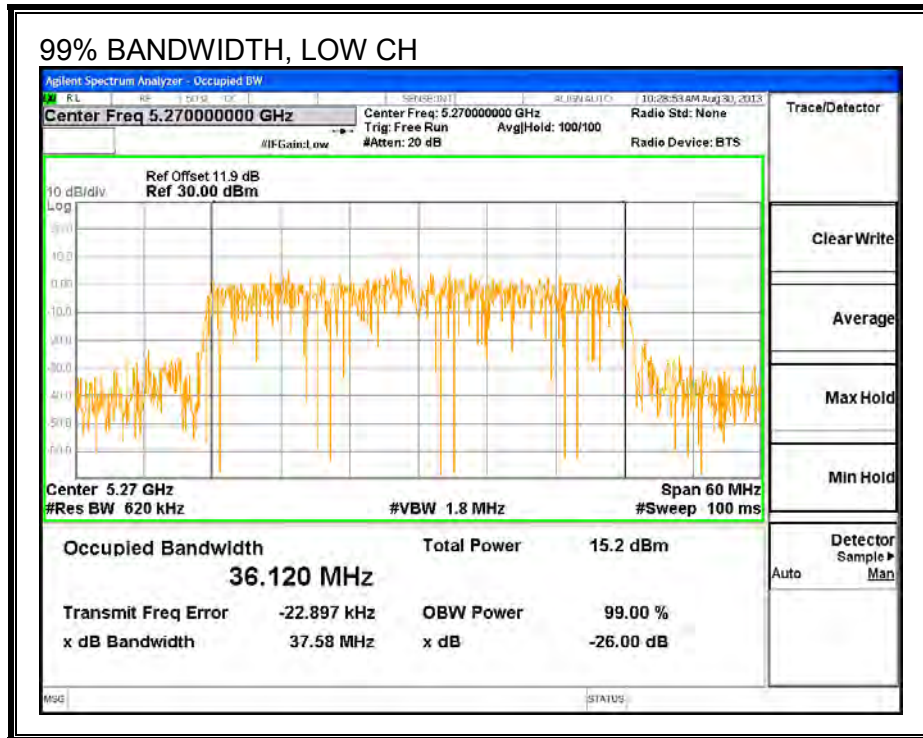

8.7.3. AVERAGE POWER

LIMITS

None; for reporting purposes only.

TEST PROCEDURE

The transmitter output is connected to a power meter.

The cable assembly insertion loss of 11.9 dB (including 10 dB pad and 1.9 dB cable) was entered as an offset in the power meter to allow for direct reading of power.

RESULTS

Channel	Frequency (MHz)	Power (dBm)
Low	5270	15.90
High	5310	14.49

8.7.4. OUTPUT POWER AND PPSD

LIMITS

FCC §15.407 (a) (2)

For the band 5.25–5.35 GHz, the maximum conducted output power over the frequency band of operation shall not exceed the lesser of 250 mW or $11 \text{ dBm} + 10 \log B$, where B is the 26–dB emission bandwidth in MHz. In addition, the maximum power spectral density shall not exceed 11 dBm in any 1–MHz band. If transmitting antennas of directional gain greater than 6 dBi are used, both the maximum conducted output power and the peak power spectral density shall be reduced by the amount in dB that the directional gain of the antenna exceeds 6 dBi.

DIRECTIONAL ANTENNA GAIN

There is only one transmitter output therefore the directional gain is equal to the antenna gain.

RESULTS

Bandwidth and Antenna Gain

Channel	Frequency (MHz)	Min 26 dB BW (MHz)	Directional Gain (dBi)
Low	5270	39.4	3.25
High	5310	38.9	3.25

Limits

Channel	Frequency (MHz)	FCC Power Limit (dBm)	FCC PPSD Limit (dBm)
Low	5270	24.00	11.00
High	5310	24.00	11.00

Duty Cycle CF (dB)	0.00	Included in Calculations of Corr'd Power & PPSD
---------------------------	------	--

Output Power Results

Channel	Frequency (MHz)	Chain 0 Meas Power (dBm)	Total Corr'd Power (dBm)	Power Limit (dBm)	Power Margin (dB)
Low	5270	16.12	16.12	24.00	-7.88
High	5310	14.82	14.82	24.00	-9.18

PPSD Results

Channel	Frequency (MHz)	Chain 0 Meas PPSD (dBm)	Total Corr'd PPSD (dBm)	PPSD Limit (dBm)	PPSD Margin (dB)
Low	5270	3.58	3.58	11.00	-7.42
High	5310	2.00	2.00	11.00	-9.01

OUTPUT POWER AND PPSD, Chain 0

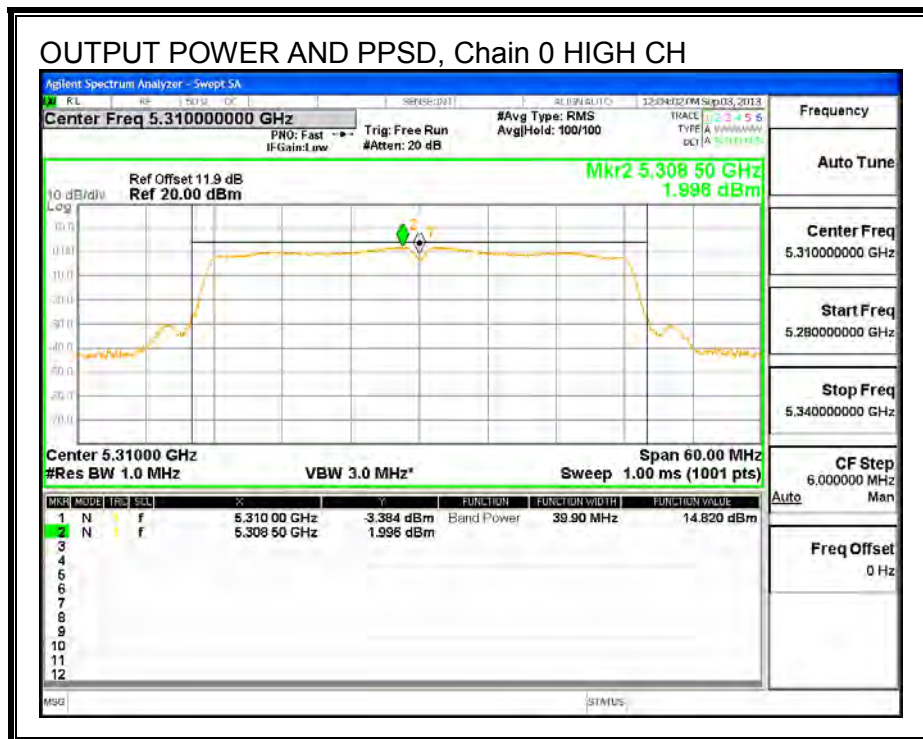
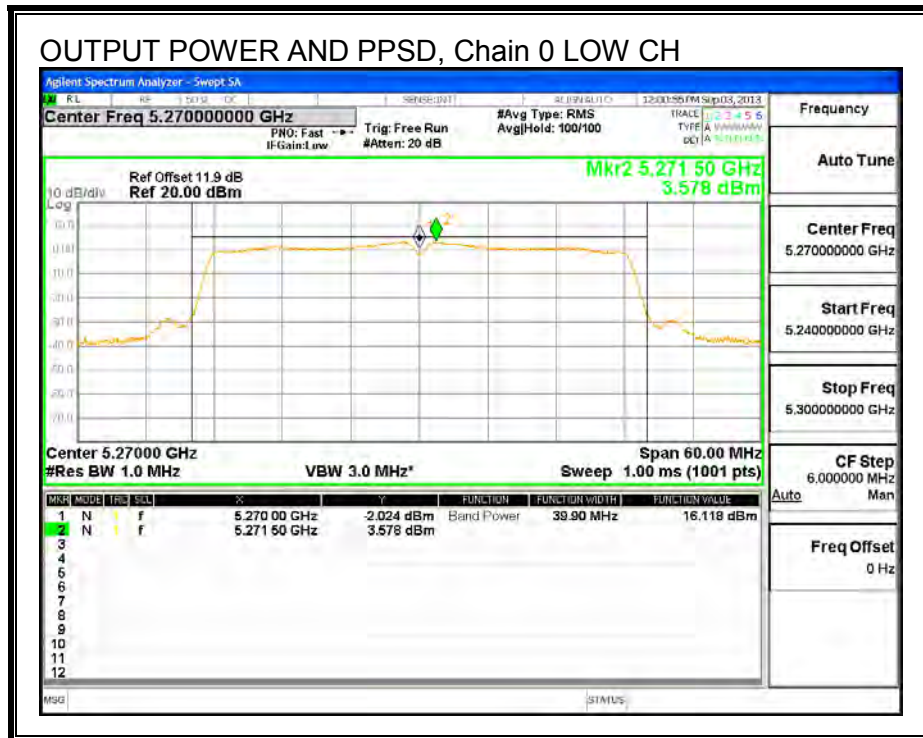

8.8. 802.11n 2TX HT40 CDD MODE IN THE 5.3 GHz BAND

8.8.1. 26 dB BANDWIDTH

LIMITS

None; for reporting purposes only.

RESULTS

Channel	Frequency (MHz)	26 dB BW Chain 0 (MHz)	26 dB BW Chain 1 (MHz)
Low	5270	39.94	39.57
High	5310	39.69	39.38

26 dB BANDWIDTH, Chain 0

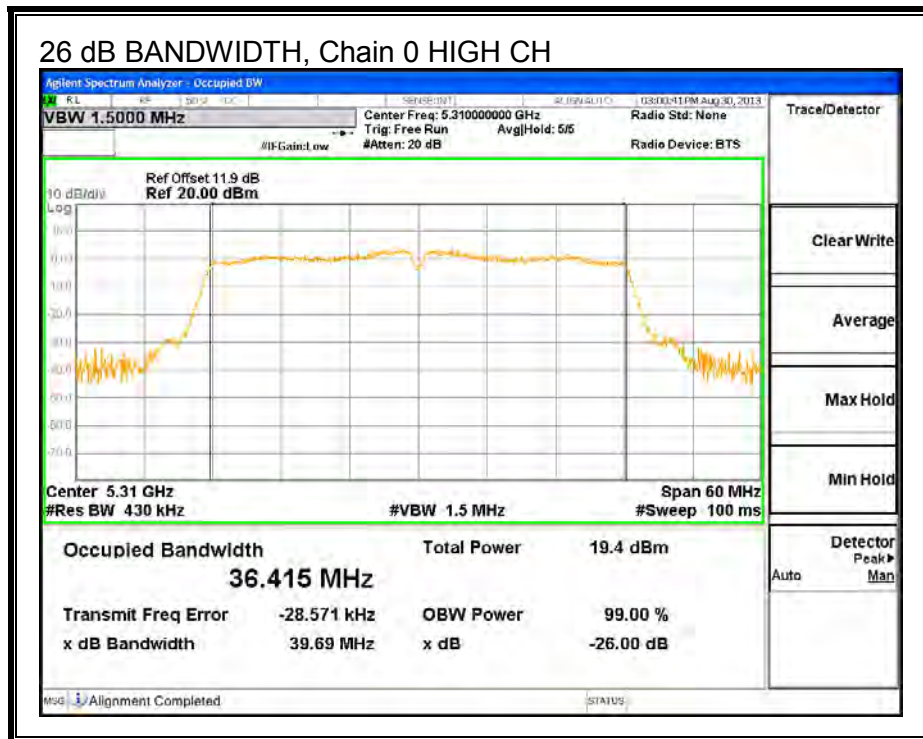
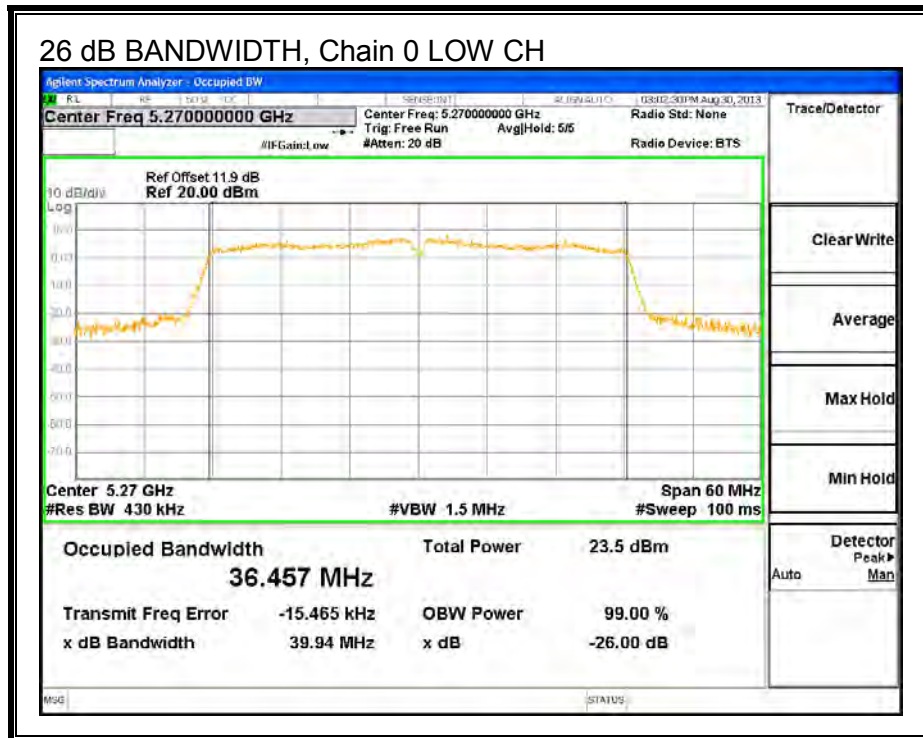

26 dB BANDWIDTH, Chain 1

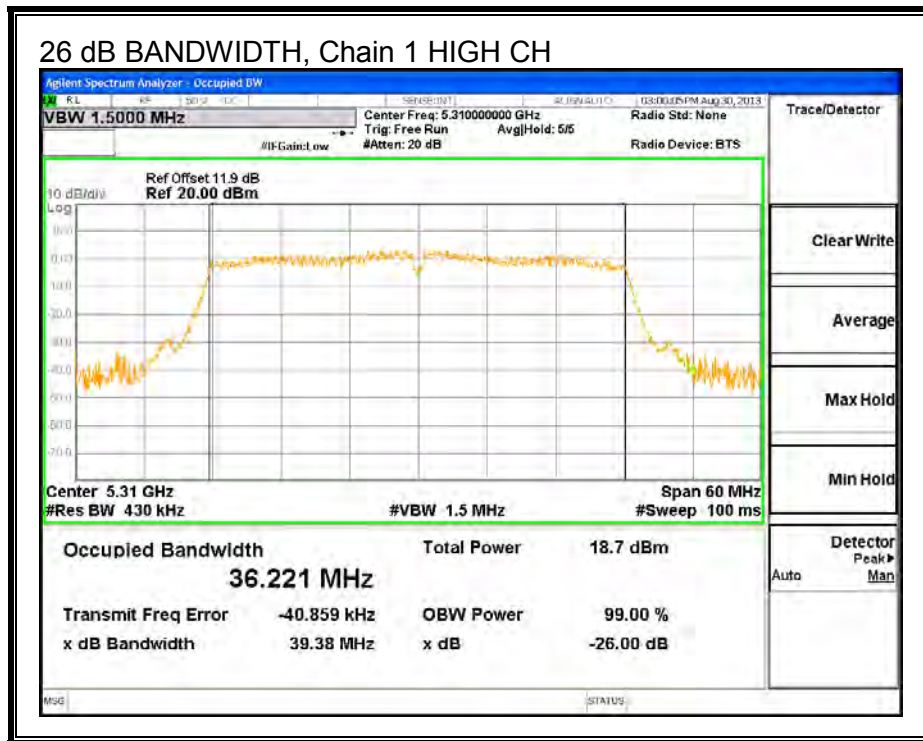
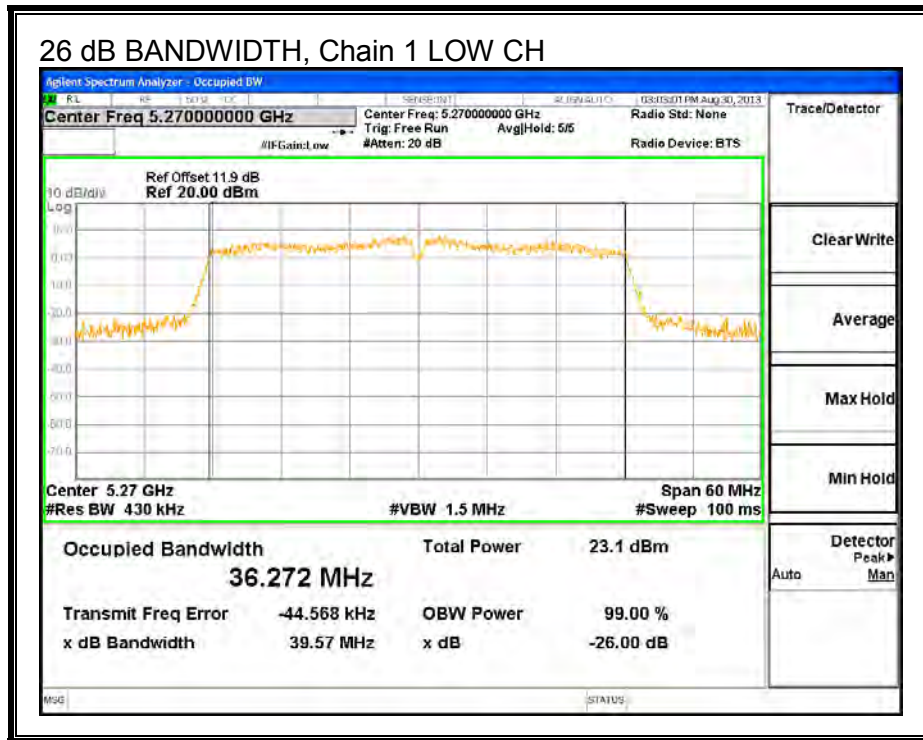

8.8.2. 99% BANDWIDTH

LIMITS

None; for reporting purposes only.

RESULTS

Channel	Frequency (MHz)	99% BW	
		Chain 0 (MHz)	Chain 1 (MHz)
Low	5270	36.219	36.219
High	5310	36.156	36.373

99% BANDWIDTH, Chain 0

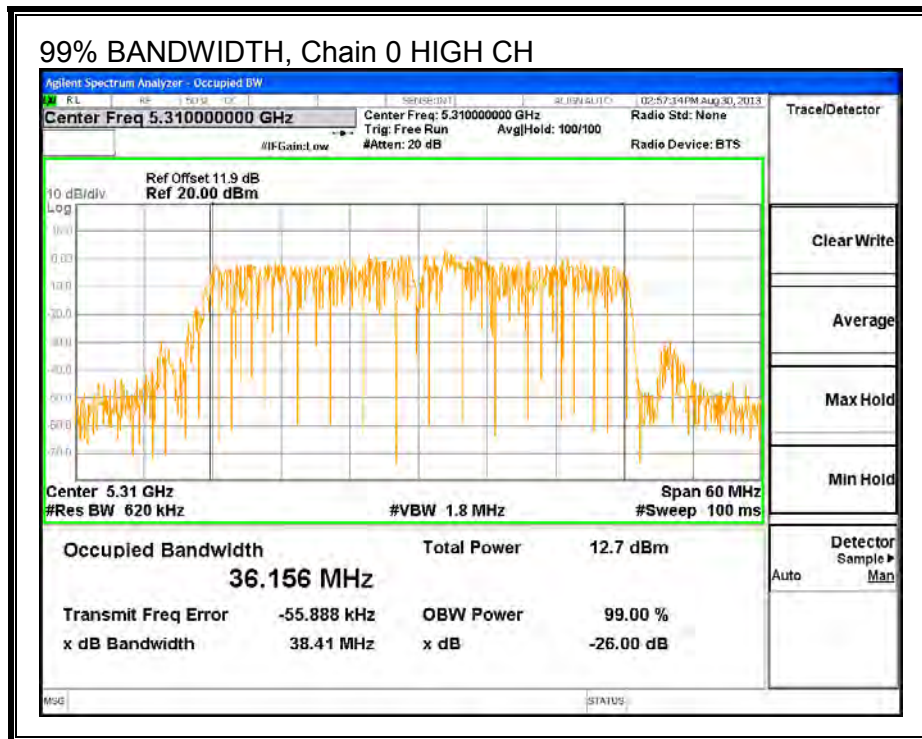
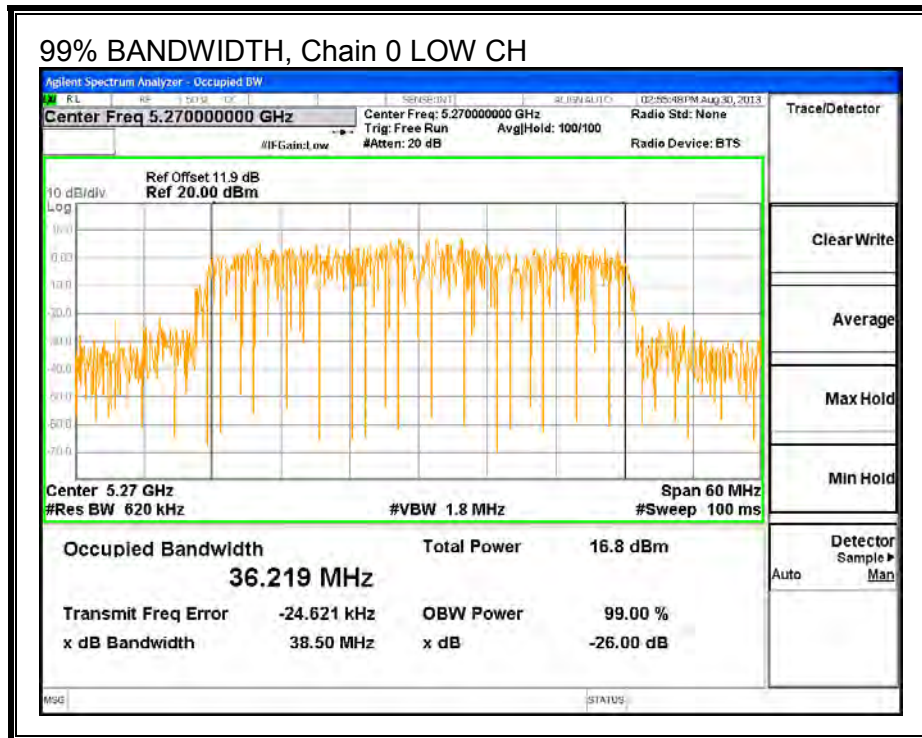

99% BANDWIDTH, Chain 1

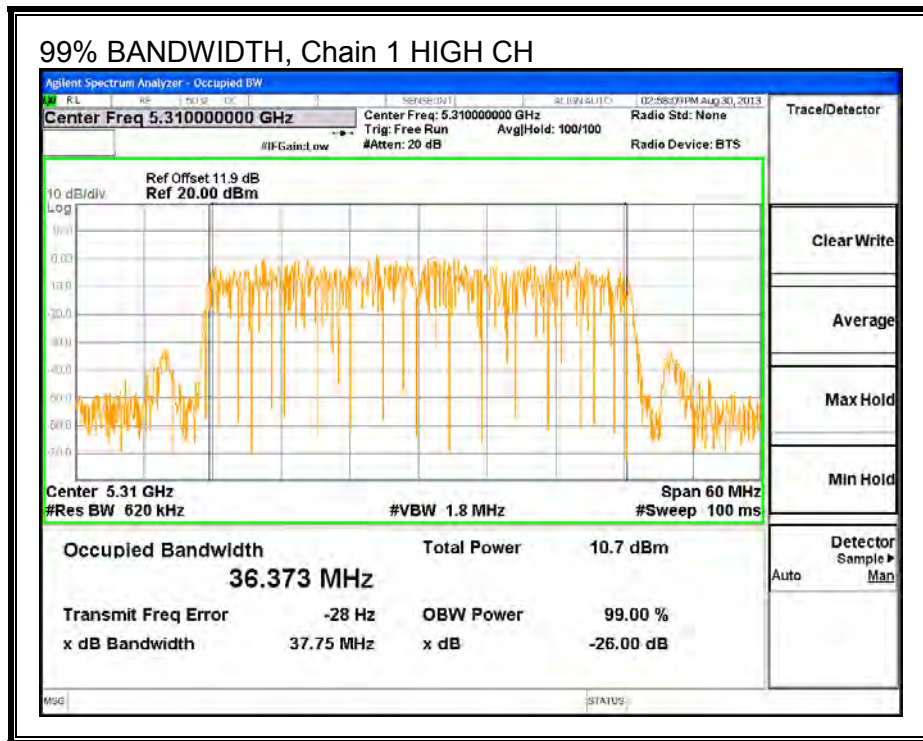
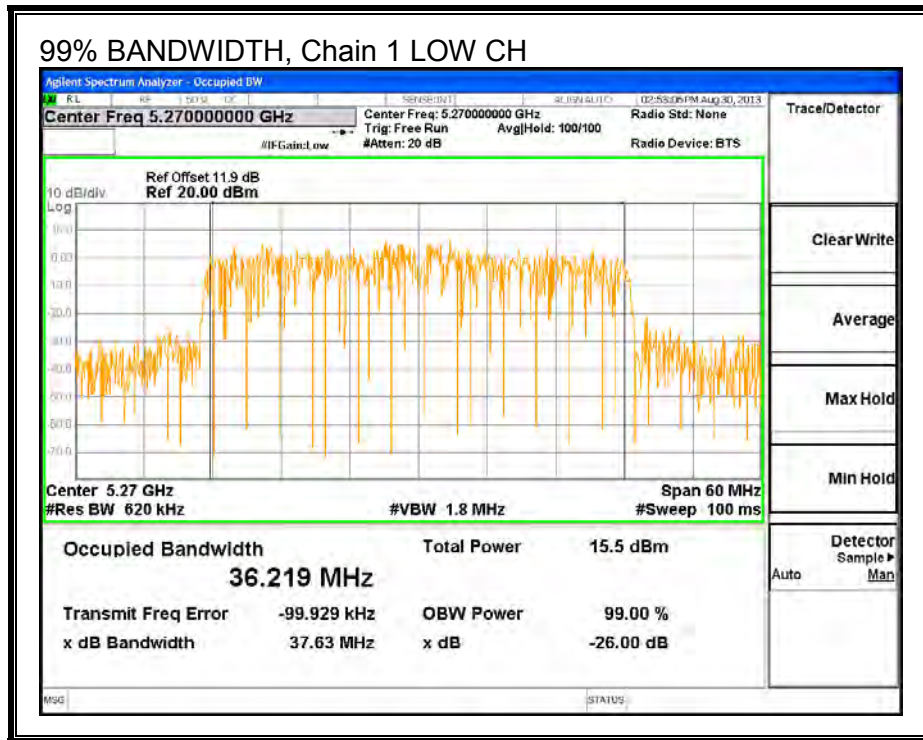

8.8.3. AVERAGE POWER

LIMITS

None; for reporting purposes only.

TEST PROCEDURE

The transmitter output is connected to a power meter.

The cable assembly insertion loss of 11.9 dB (including 10 dB pad and 1.9 dB cable) was entered as an offset in the power meter to allow for direct reading of power.

RESULTS

Average Power Results

Channel	Frequency (MHz)	Chain 0 Power (dBm)	Chain 1 Power (dBm)	Total Power (dBm)
Low	5270	15.97	15.99	18.99
High	5310	12.45	12.50	15.49

8.8.4. OUTPUT POWER AND PPSD

LIMITS

FCC §15.407 (a) (2)

For the band 5.25–5.35 GHz, the maximum conducted output power over the frequency band of operation shall not exceed the lesser of 250 mW or 11 dBm + 10 log B, where B is the 26–dB emission bandwidth in MHz. In addition, the maximum power spectral density shall not exceed 11 dBm in any 1–MHz band. If transmitting antennas of directional gain greater than 6 dBi are used, both the maximum conducted output power and the peak power spectral density shall be reduced by the amount in dB that the directional gain of the antenna exceeds 6 dBi.

DIRECTIONAL ANTENNA GAIN

The TX chains are uncorrelated and the antenna gain is unequal among the chains. The directional gain is:

Chain 0 Antenna Gain (dBi)	Chain 1 Antenna Gain (dBi)	Uncorrelated Chains Directional Gain (dBi)
0.75	3.25	2.18

The TX chains are correlated and the antenna gain is unequal among the chains. The directional gain is:

Chain 0 Antenna Gain (dBi)	Chain 1 Antenna Gain (dBi)	Correlated Chains Directional Gain (dBi)
0.75	3.25	5.10

RESULTS

Bandwidth and Antenna Gain

Channel	Frequency (MHz)	Min 26 dB BW (MHz)	Uncorrelated Directional Gain (dBi)	Correlated Directional Gain (dBi)
Low	5270	39.6	2.18	5.10
High	5310	39.4	2.18	5.10

Limits

Channel	Frequency (MHz)	FCC Power Limit (dBm)	FCC PPSD Limit (dBm)
Low	5270	24.00	11.00
High	5310	24.00	11.00

Duty Cycle CF (dB)	0.00	Included in Calculations of Corr'd Power & PPSD
---------------------------	------	--

Output Power Results

Channel	Frequency (MHz)	Chain 0 Meas Power (dBm)	Chain 1 Meas Power (dBm)	Total Corr'd Power (dBm)	Power Limit (dBm)	Power Margin (dB)
Low	5270	16.24	16.19	19.22	24.00	-4.78
High	5310	12.65	12.58	15.63	24.00	-8.37

PPSD Results

Channel	Frequency (MHz)	Chain 0 Meas PPSD (dBm)	Chain 1 Meas PPSD (dBm)	Total Corr'd PPSD (dBm)	PPSD Limit (dBm)	PPSD Margin (dB)
Low	5270	3.18	3.40	6.30	11.00	-4.70
High	5310	0.04	-0.27	2.90	11.00	-8.10

OUTPUT POWER AND PPSD, Chain 0

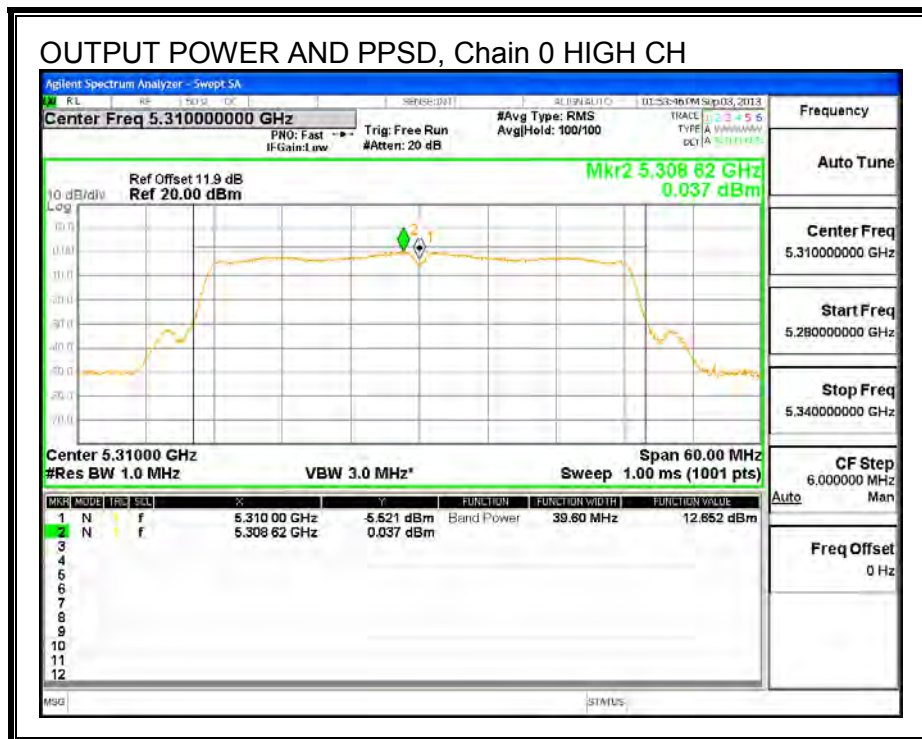
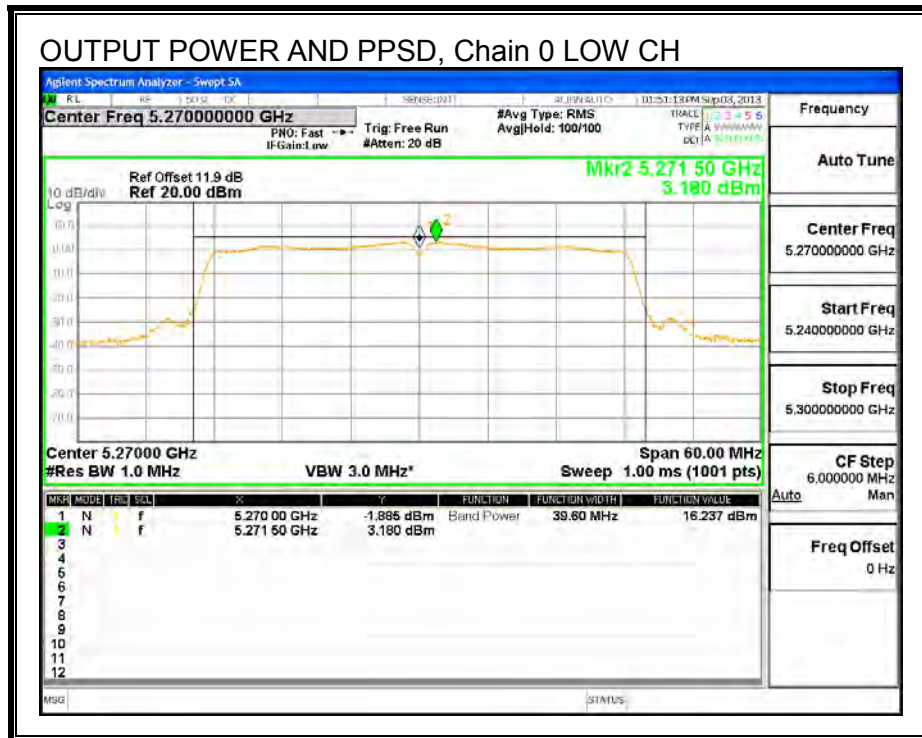

OUTPUT POWER AND PPSD, Chain 1

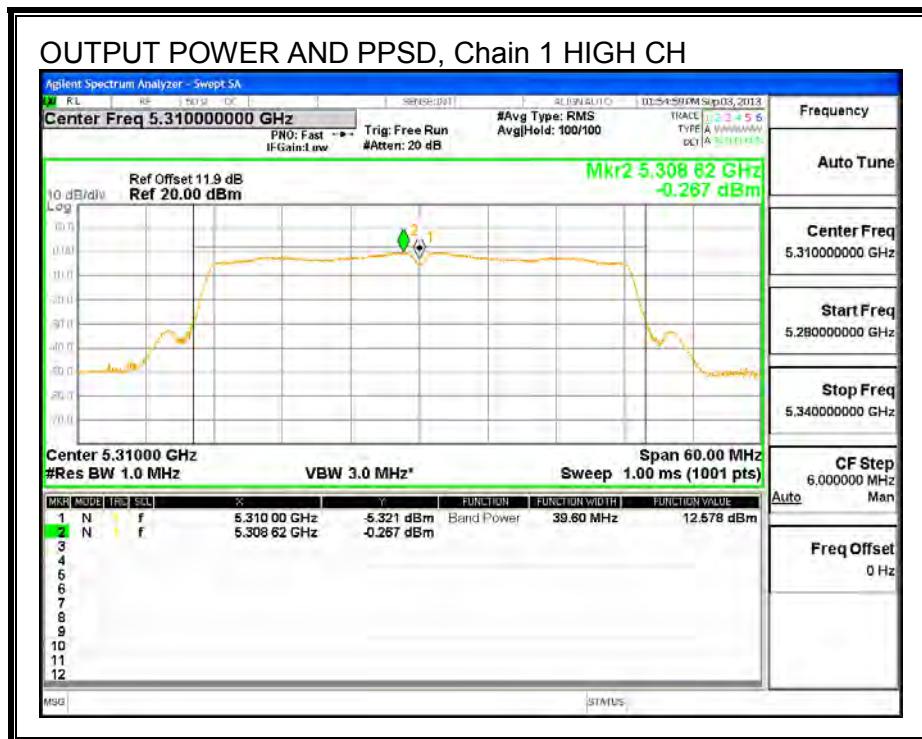
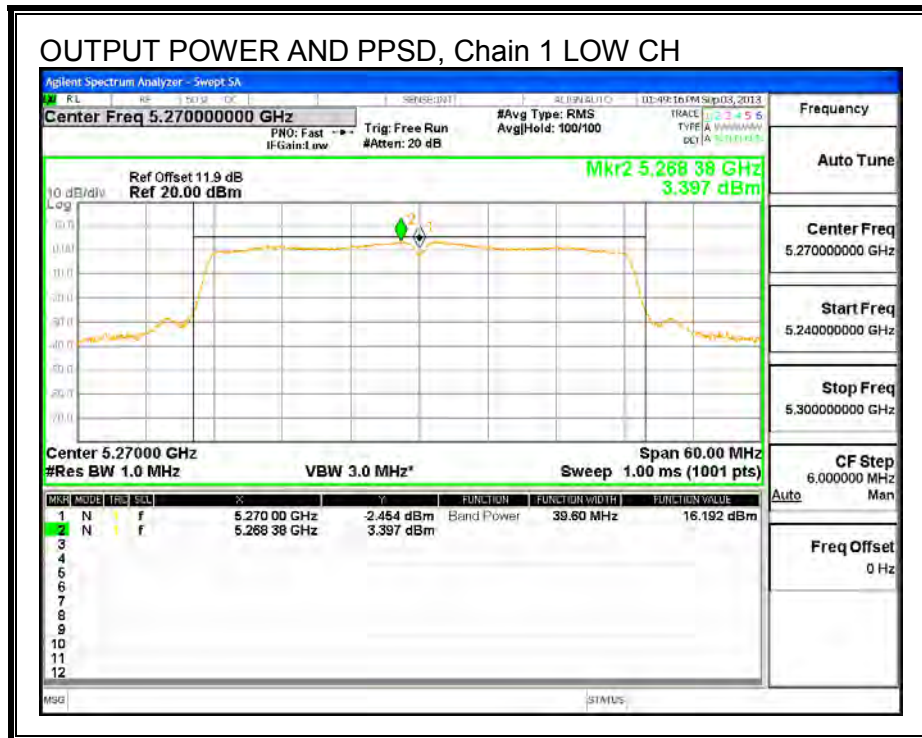

8.9. 802.11a SISO MODE IN THE 5.6 GHz BAND

8.9.1. 26 dB BANDWIDTH

LIMITS

None; for reporting purposes only.

RESULTS

Channel	Frequency (MHz)	26 dB Bandwidth (MHz)
Low	5500	20.43
Mid	5580	20.69
High	5700	20.14

26 dB BANDWIDTH

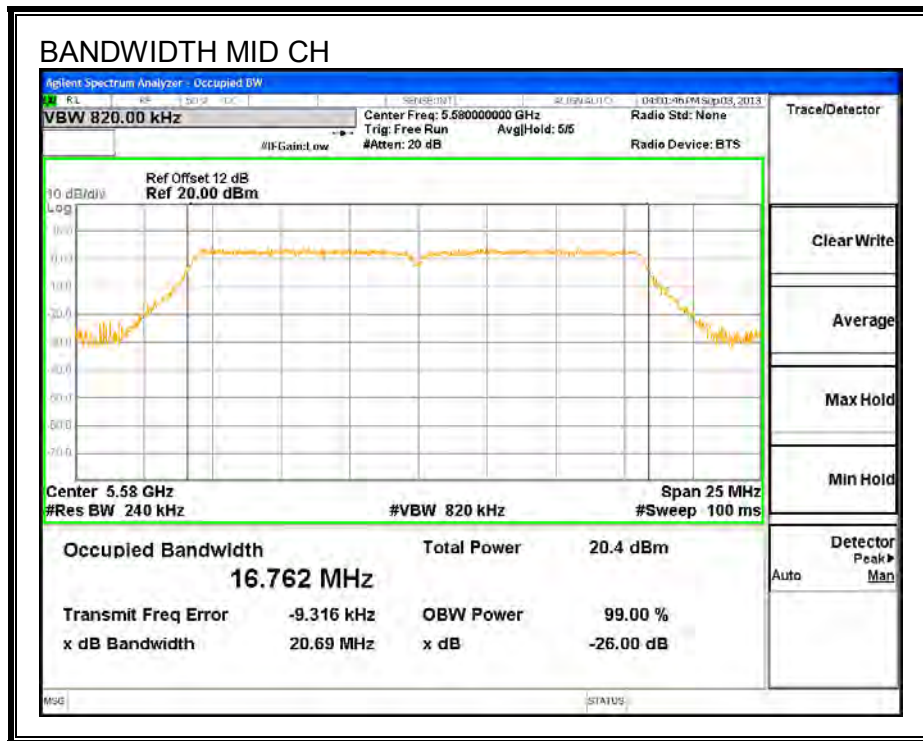
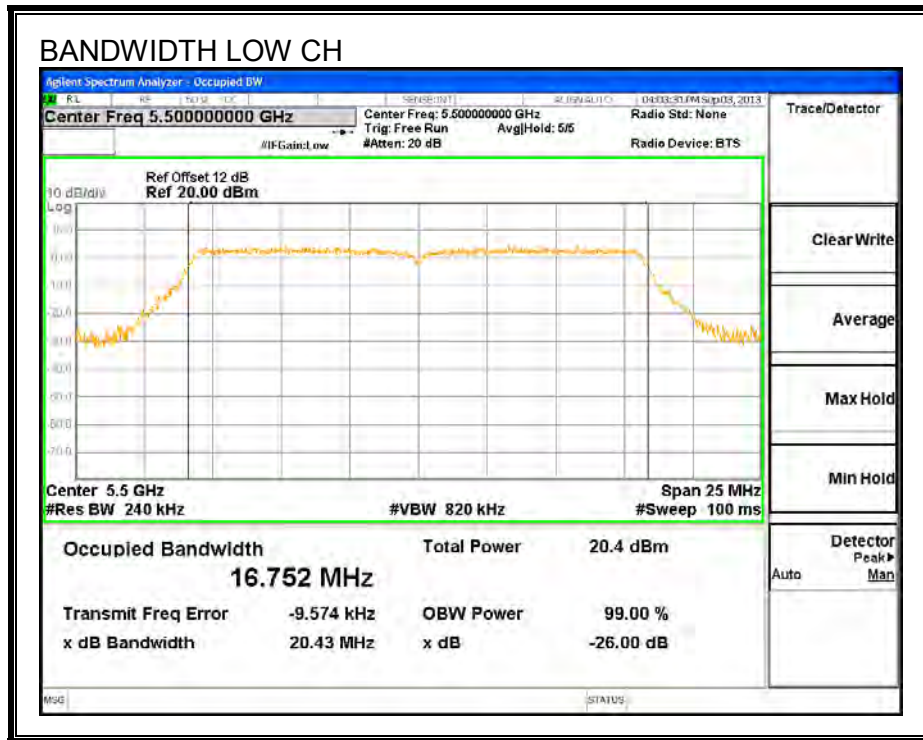

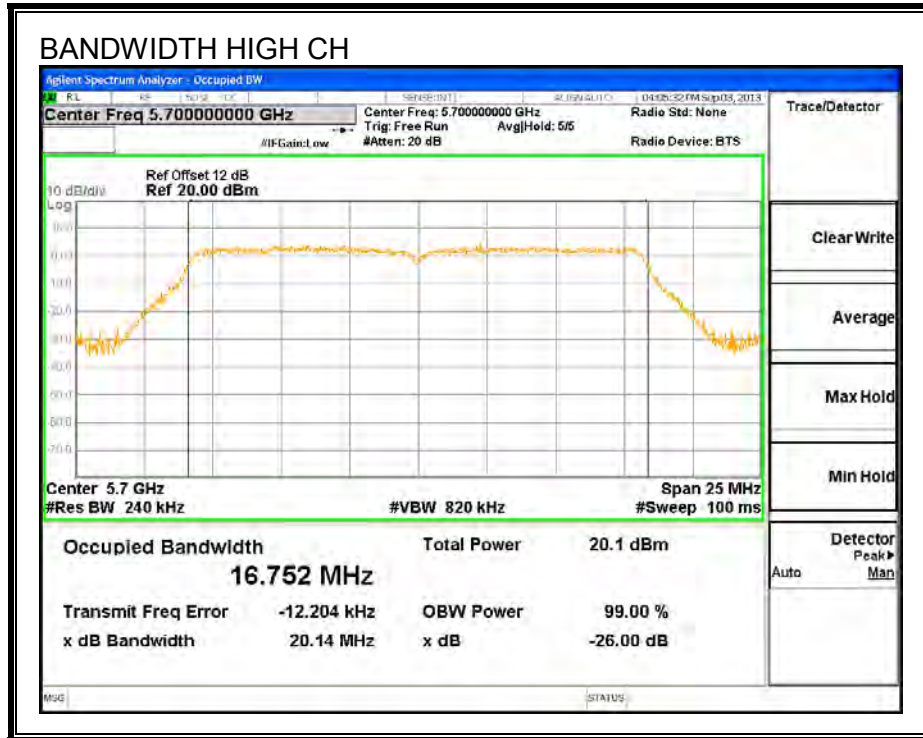

8.9.2. 99% BANDWIDTH

LIMITS

None; for reporting purposes only.

RESULTS

Channel	Frequency (MHz)	99% Bandwidth (MHz)
Low	5500	16.457
Mid	5580	16.609
High	5700	16.658

99% BANDWIDTH

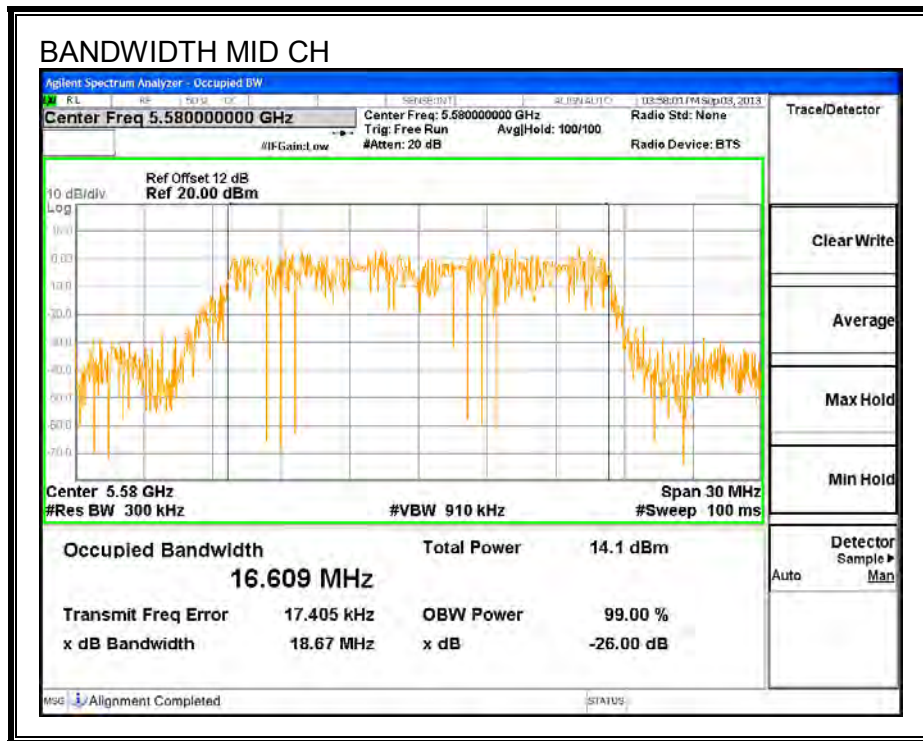
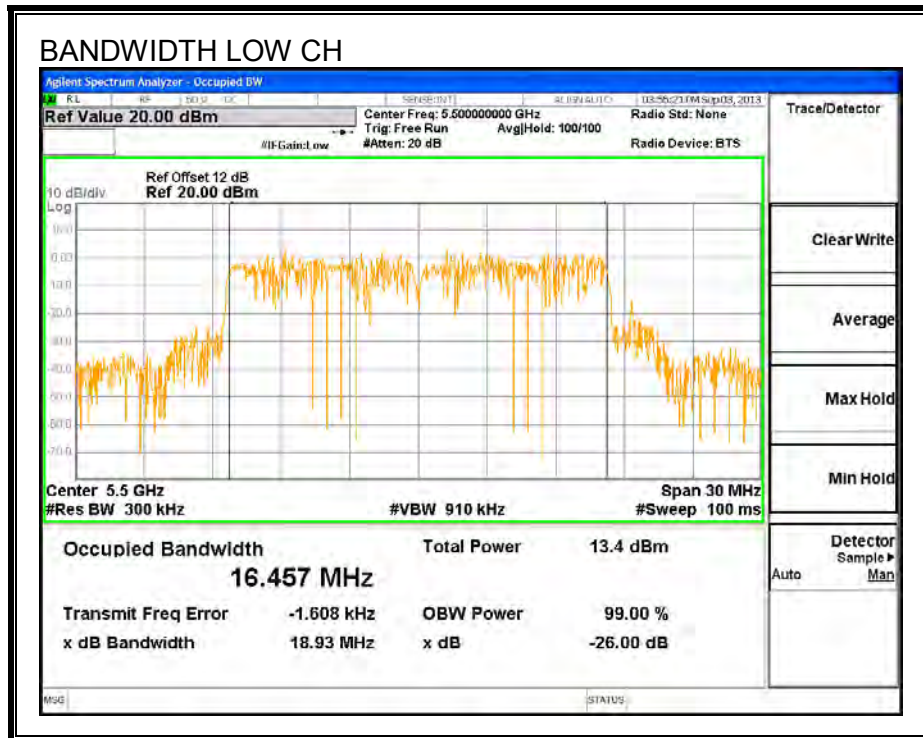

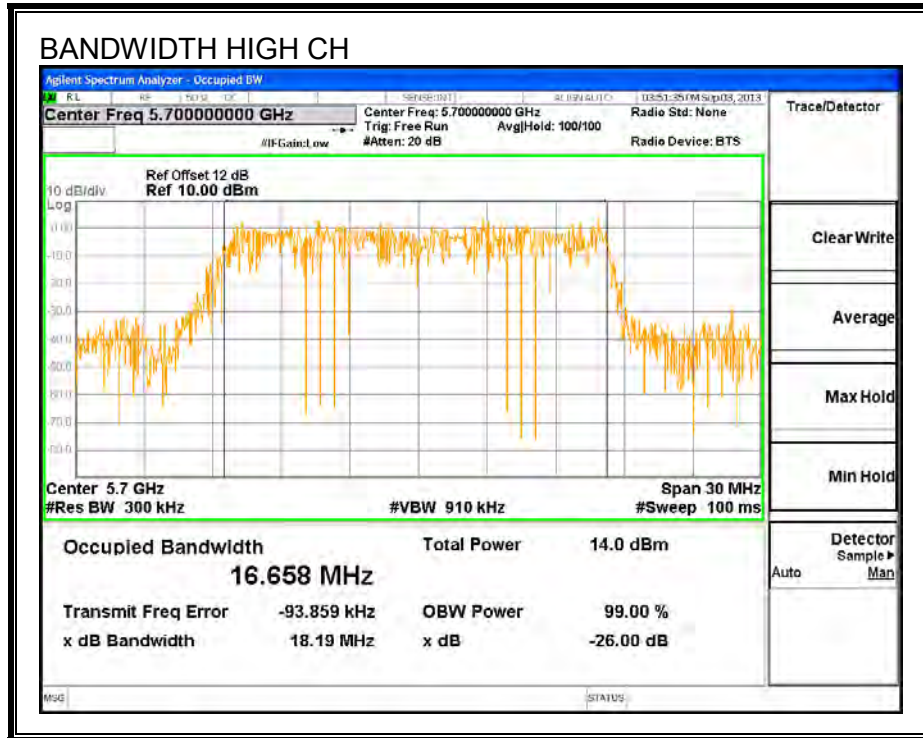

8.9.3. AVERAGE POWER

LIMITS

None; for reporting purposes only.

TEST PROCEDURE

The transmitter output is connected to a power meter.

The cable assembly insertion loss of 12 dB (including 10 dB pad and 2 dB cable) was entered as an offset in the power meter to allow for direct reading of power.

RESULTS

Channel	Frequency (MHz)	Power (dBm)
Low	5500	14.0
Mid	5580	15.0
High	5700	14.0

8.9.4. OUTPUT POWER AND PPSD

LIMITS

FCC §15.407 (a) (2)

For the band 5.47–5.725 GHz, the maximum conducted output power over the frequency band of operation shall not exceed the lesser of 250 mW or $11 \text{ dBm} + 10 \log B$, where B is the 26-dB emission bandwidth in MHz. In addition, the maximum power spectral density shall not exceed 11 dBm in any 1-MHz band. If transmitting antennas of directional gain greater than 6 dBi are used, both the maximum conducted output power and the peak power spectral density shall be reduced by the amount in dB that the directional gain of the antenna exceeds 6 dBi.

DIRECTIONAL ANTENNA GAIN

There is only one transmitter output therefore the directional gain is equal to the antenna gain.

RESULTS

Bandwidth and Antenna Gain

Channel	Frequency (MHz)	Min 26 dB BW (MHz)	Directional Gain (dBi)
Low	5500	20.4	4.29
Mid	5580	20.7	4.29
High	5700	20.1	4.29

Limits

Channel	Frequency (MHz)	FCC Power Limit (dBm)	FCC PPSD Limit (dBm)
Low	5500	24.00	11.00
Mid	5580	24.00	11.00
High	5700	24.00	11.00

Duty Cycle CF (dB)	0.00	Included in Calculations of Corr'd Power & PPSD
---------------------------	------	--

Output Power Results

Channel	Frequency (MHz)	Chain 0 Meas Power (dBm)	Total Corr'd Power (dBm)	Power Limit (dBm)	Power Margin (dB)
Low	5500	14.09	14.09	24.00	-9.91
Mid	5580	15.11	15.11	24.00	-8.89
High	5700	14.18	14.18	24.00	-9.82

PPSD Results

Channel	Frequency (MHz)	Chain 0 Meas PPSD (dBm)	Total Corr'd PPSD (dBm)	PPSD Limit (dBm)	PPSD Margin (dB)
Low	5500	2.84	2.84	11.00	-8.16
Mid	5580	3.82	3.82	11.00	-7.18
High	5700	3.20	3.20	11.00	-7.80

OUTPUT POWER AND PPSD, Chain 0

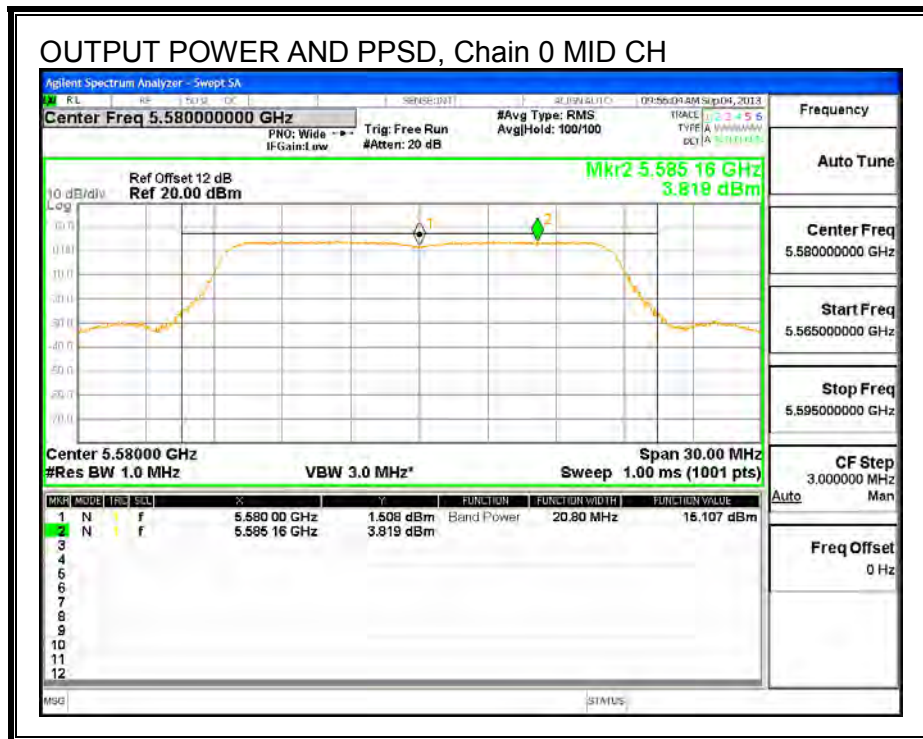
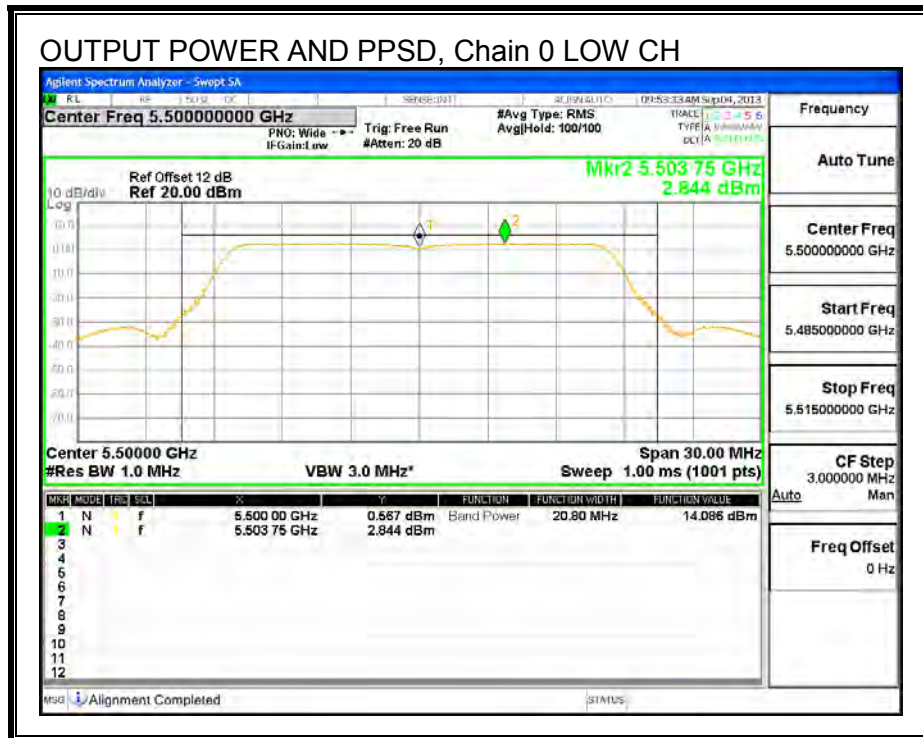

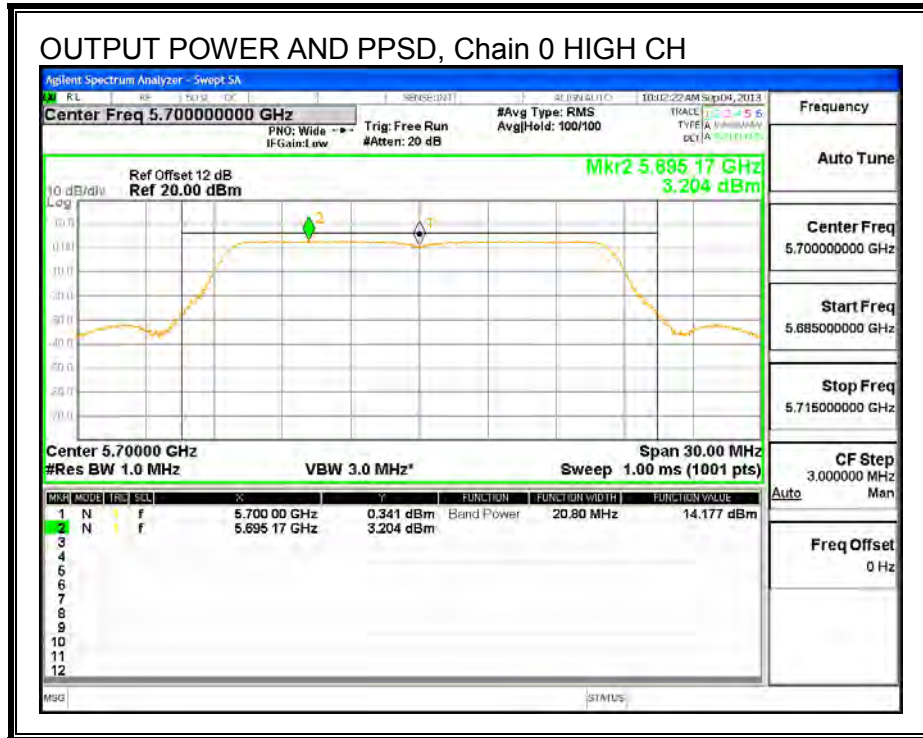

8.10. 802.11n HT20 2TX CDD MODE IN THE 5.6 GHZ BAND

8.10.1. 26 dB BANDWIDTH

LIMITS

None; for reporting purposes only.

RESULTS

Channel	Frequency (MHz)	26 dB BW Chain 0 (MHz)	26 dB BW Chain 1 (MHz)
Low	5500	20.19	20.12
Mid	5580	20.65	20.63
High	5700	20.53	20.51

26 dB BANDWIDTH, Chain 0

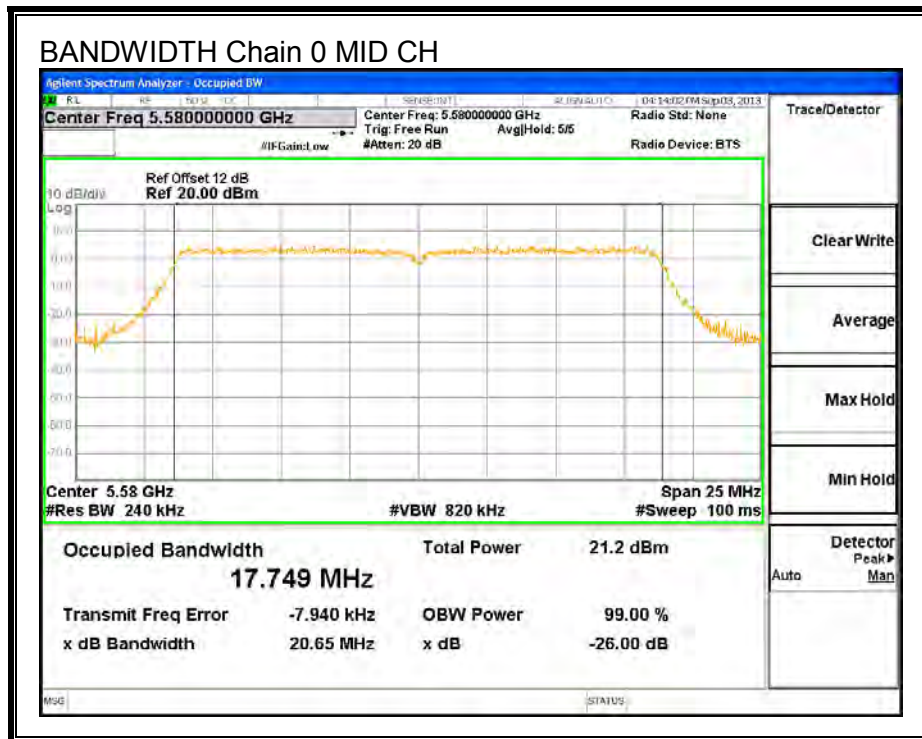
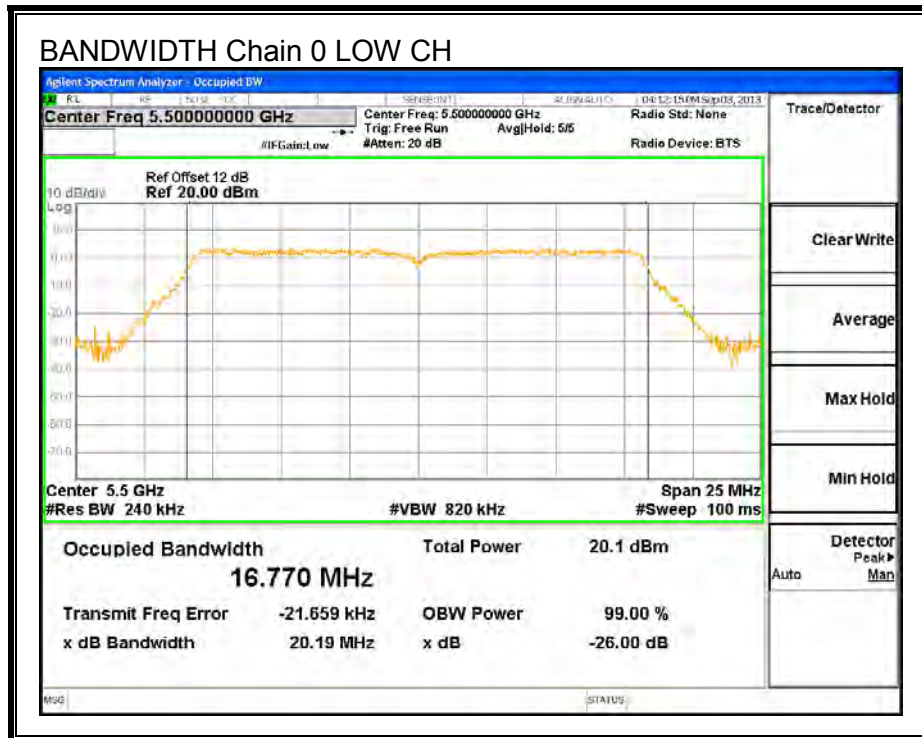

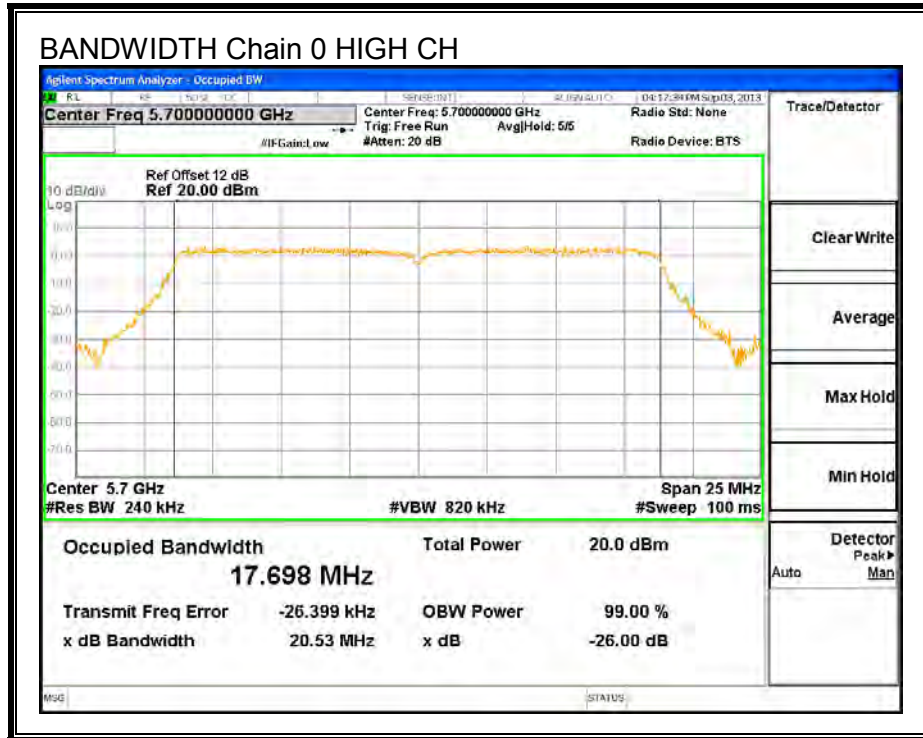

26 dB BANDWIDTH, Chain 1

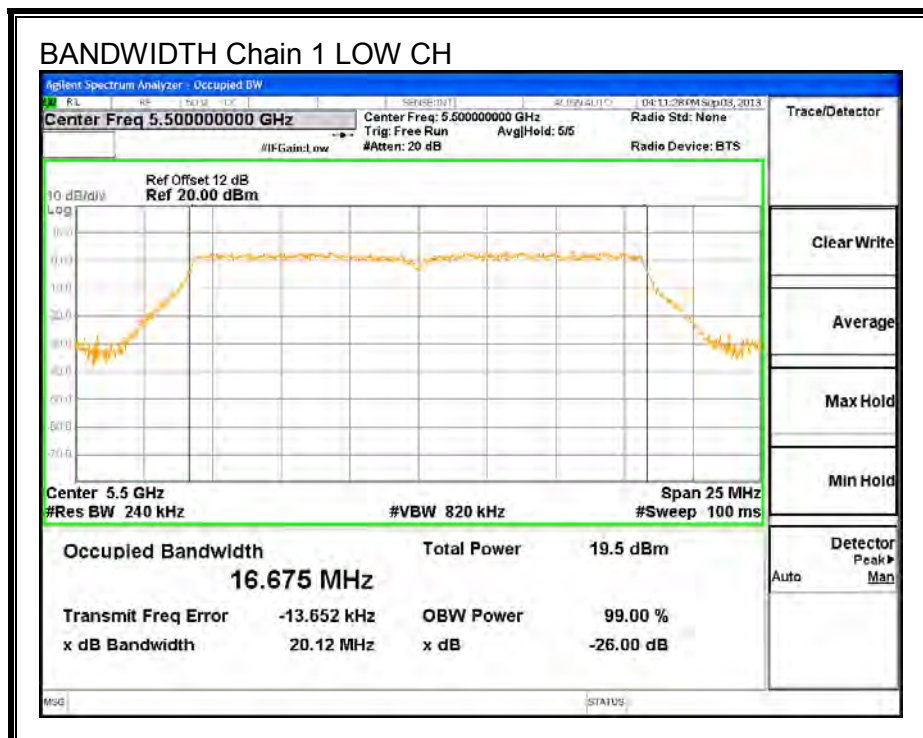

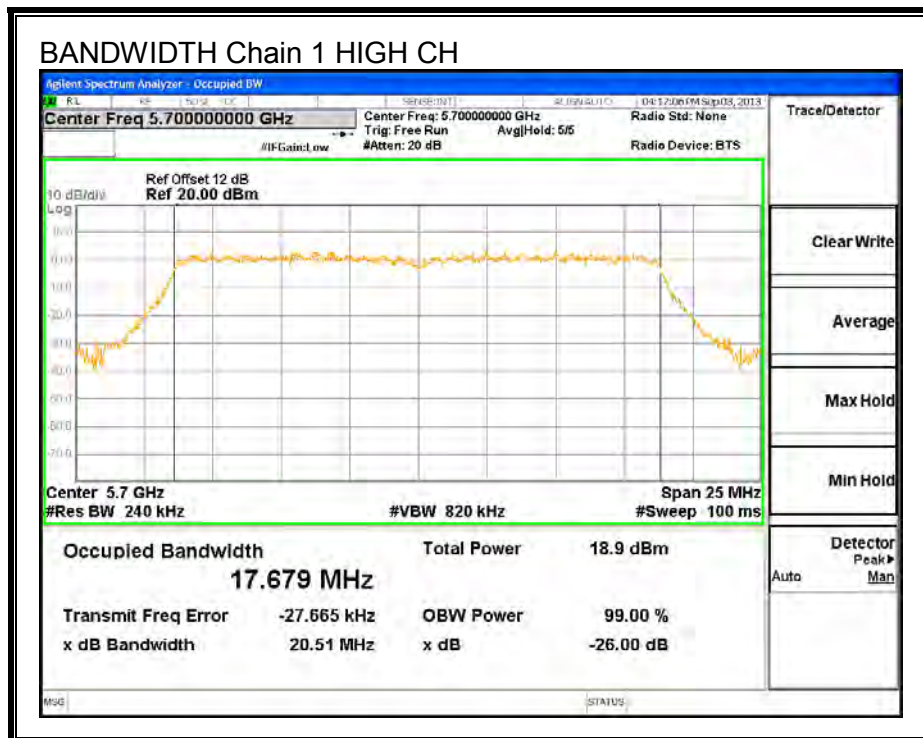
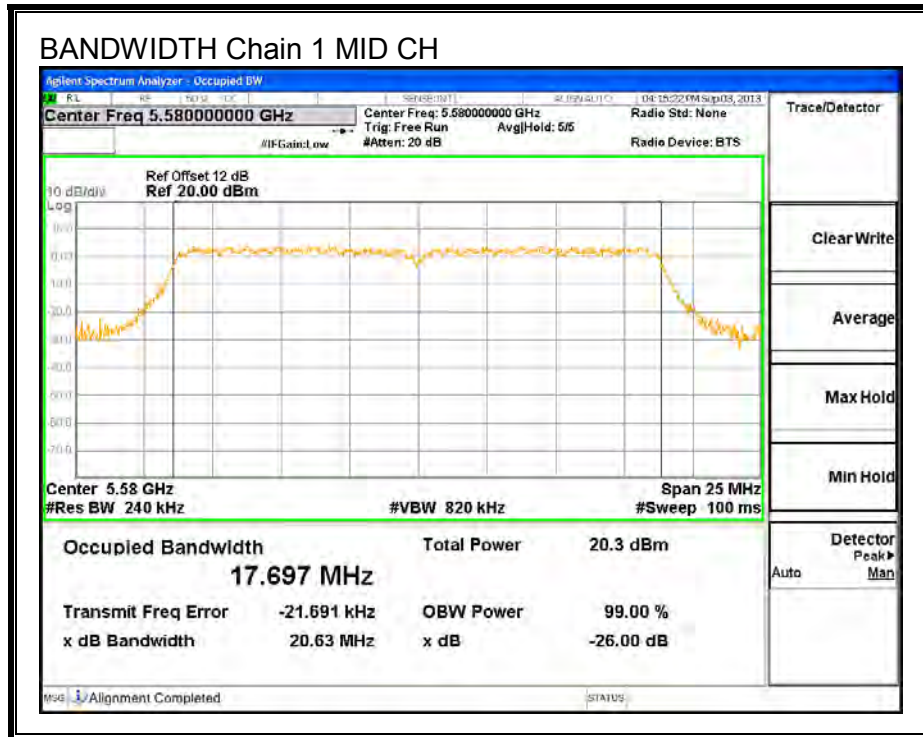

8.10.2. 99% BANDWIDTH

LIMITS

None; for reporting purposes only.

RESULTS

Channel	Frequency (MHz)	99% BW Chain 0 (MHz)	99% BW Chain 1 (MHz)
Low	5500	17.678	17.743
Mid	5580	17.622	17.642
High	5700	17.696	17.677

99% BANDWIDTH, Chain 0

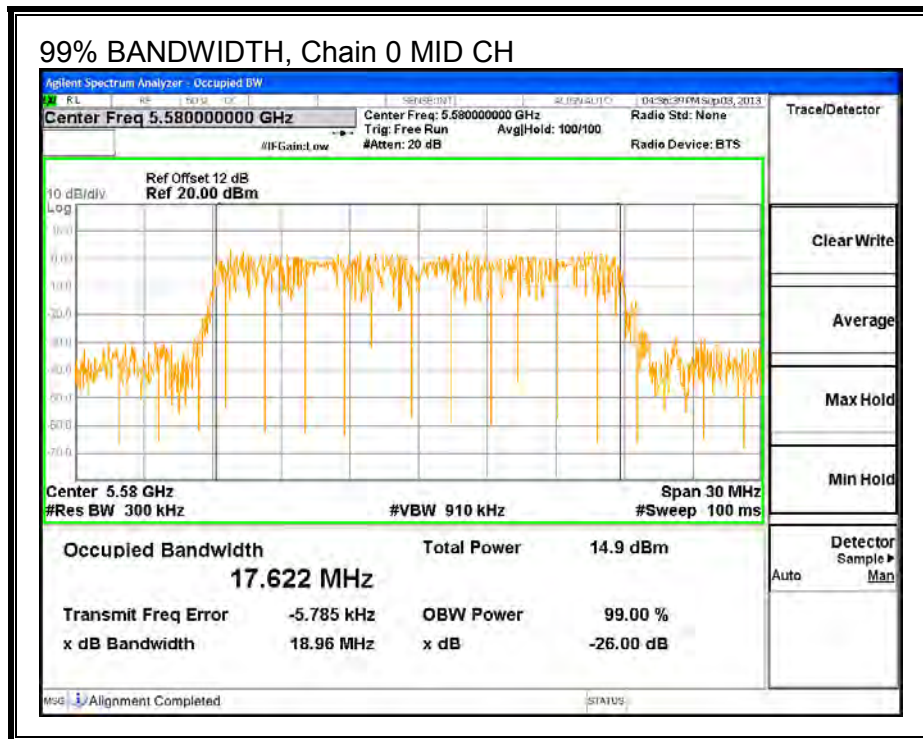
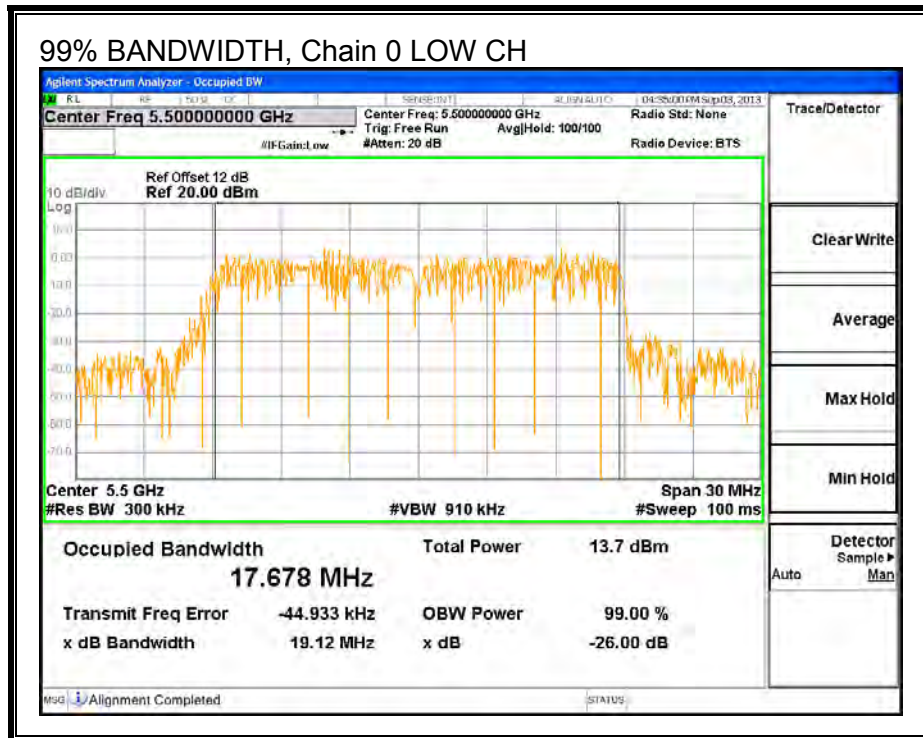

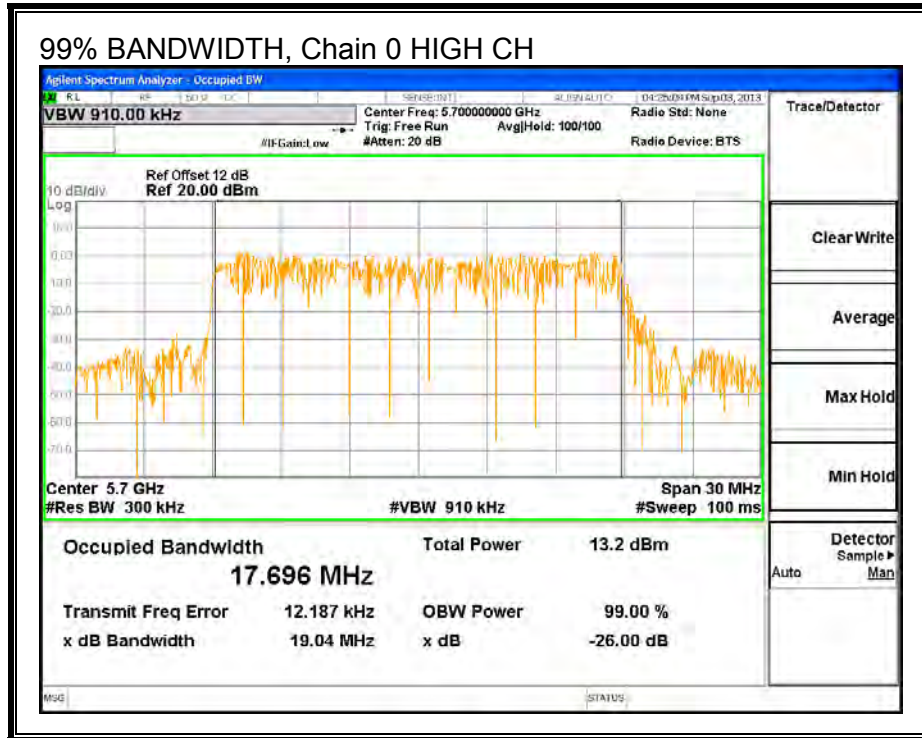

99% BANDWIDTH, Chain 1

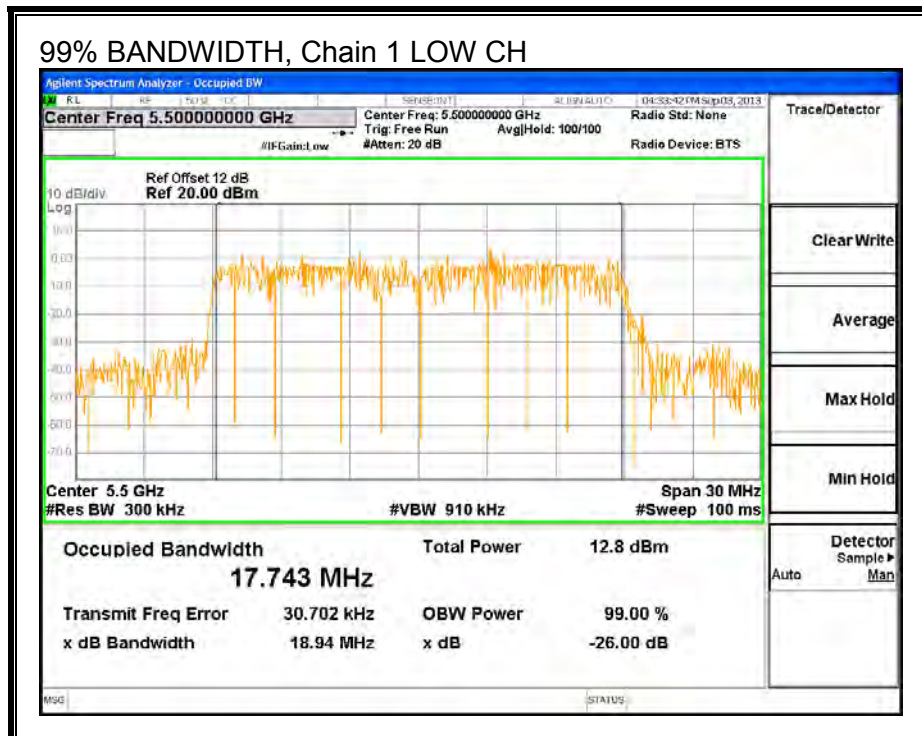

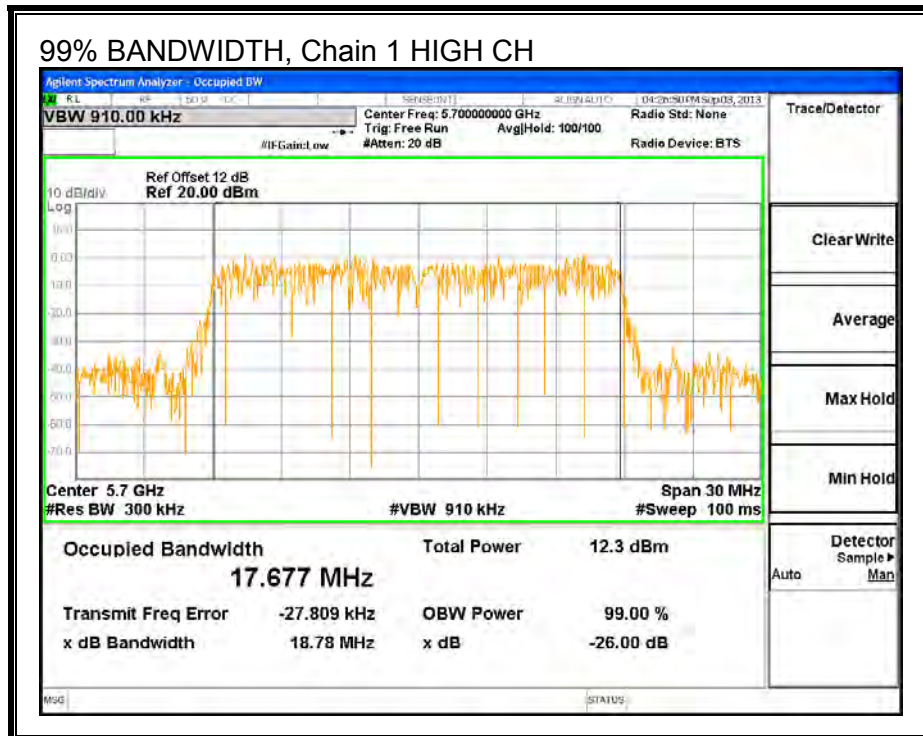
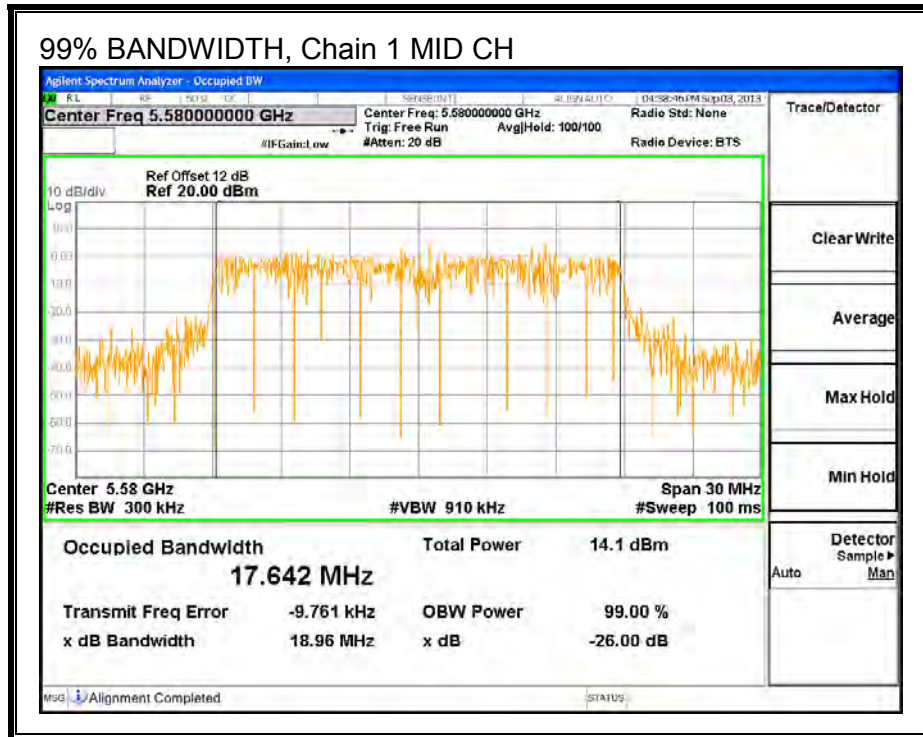

8.10.3. AVERAGE POWER

LIMITS

None; for reporting purposes only.

TEST PROCEDURE

The transmitter output is connected to a power meter.

The cable assembly insertion loss of 12 dB (including 10 dB pad and 2 dB cable) was entered as an offset in the power meter to allow for direct reading of power.

RESULTS

Average Power Results

Channel	Frequency (MHz)	Chain 0 Power (dBm)	Chain 1 Power (dBm)	Total Power (dBm)
Low	5500	13.50	13.40	16.46
Mid	5580	15.00	15.00	18.01
High	5700	13.00	13.00	16.01

8.10.4. OUTPUT POWER AND PPSD

LIMITS

FCC §15.407 (a) (2)

For the band 5.47–5.725 GHz, the maximum conducted output power over the frequency band of operation shall not exceed the lesser of 250 mW or 11 dBm + 10 log B, where B is the 26–dB emission bandwidth in MHz. In addition, the maximum power spectral density shall not exceed 11 dBm in any 1–MHz band. If transmitting antennas of directional gain greater than 6 dBi are used, both the maximum conducted output power and the peak power spectral density shall be reduced by the amount in dB that the directional gain of the antenna exceeds 6 dBi.

DIRECTIONAL ANTENNA GAIN

The TX chains are uncorrelated and the antenna gain is unequal among the chains. The directional gain is:

Chain 0 Antenna Gain (dBi)	Chain 1 Antenna Gain (dBi)	Uncorrelated Chains Directional Gain (dBi)
2.43	4.29	3.46

The TX chains are correlated and the antenna gain is unequal among the chains. The directional gain is:

Chain 0 Antenna Gain (dBi)	Chain 1 Antenna Gain (dBi)	Correlated Chains Directional Gain (dBi)
2.43	4.29	6.42

RESULTS

Bandwidth and Antenna Gain

Channel	Frequency (MHz)	Min 26 dB BW (MHz)	Uncorrelated Directional Gain (dBi)	Correlated Directional Gain (dBi)
Low	5500	20.1	3.46	6.42
Mid	5580	20.6	3.46	6.42
High	5700	20.5	3.46	6.42

Limits

Channel	Frequency (MHz)	FCC Power Limit (dBm)	FCC PPSD Limit (dBm)
Low	5500	24.00	10.58
Mid	5580	24.00	10.58
High	5700	24.00	10.58

Duty Cycle CF (dB)	0.00	Included in Calculations of Corr'd Power & PPSD
---------------------------	------	--

Output Power Results

Channel	Frequency (MHz)	Chain 0 Meas Power (dBm)	Chain 1 Meas Power (dBm)	Total Corr'd Power (dBm)	Power Limit (dBm)	Power Margi n (dB)
Low	5500	13.59	13.64	16.62	24.00	-7.38
Mid	5580	15.17	15.04	18.11	24.00	-5.89
High	5700	13.13	13.21	16.18	24.00	-7.82

PPSD Results

Channel	Frequency (MHz)	Chain 0 Meas PPSD (dBm)	Chain 1 Meas PPSD (dBm)	Total Corr'd PPSD (dBm)	PPSD Limit (dBm)	PPSD Margi n (dB)
Low	5500	2.18	1.78	5.00	10.58	-5.58
Mid	5580	3.36	3.37	6.37	10.58	-4.21
High	5700	1.44	1.28	4.37	10.58	-6.21

OUTPUT POWER AND PPSD, Chain 0

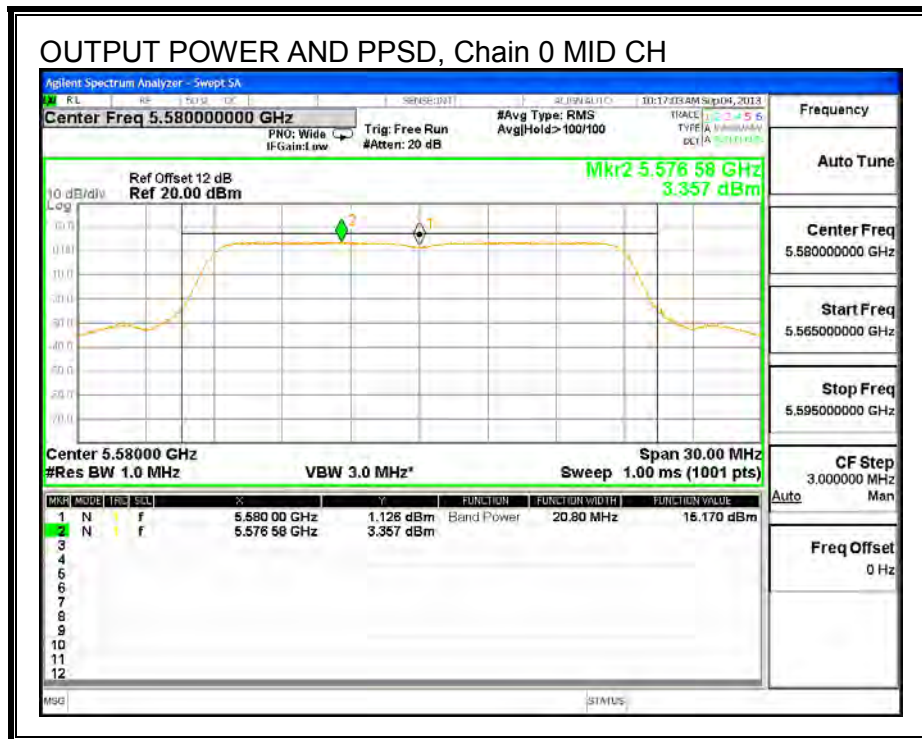
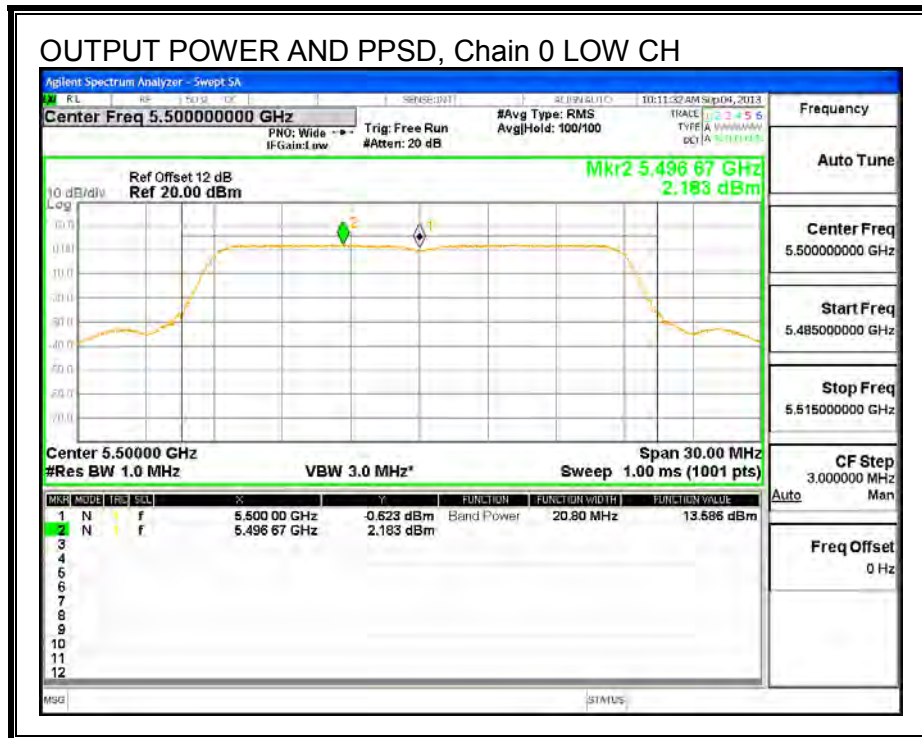

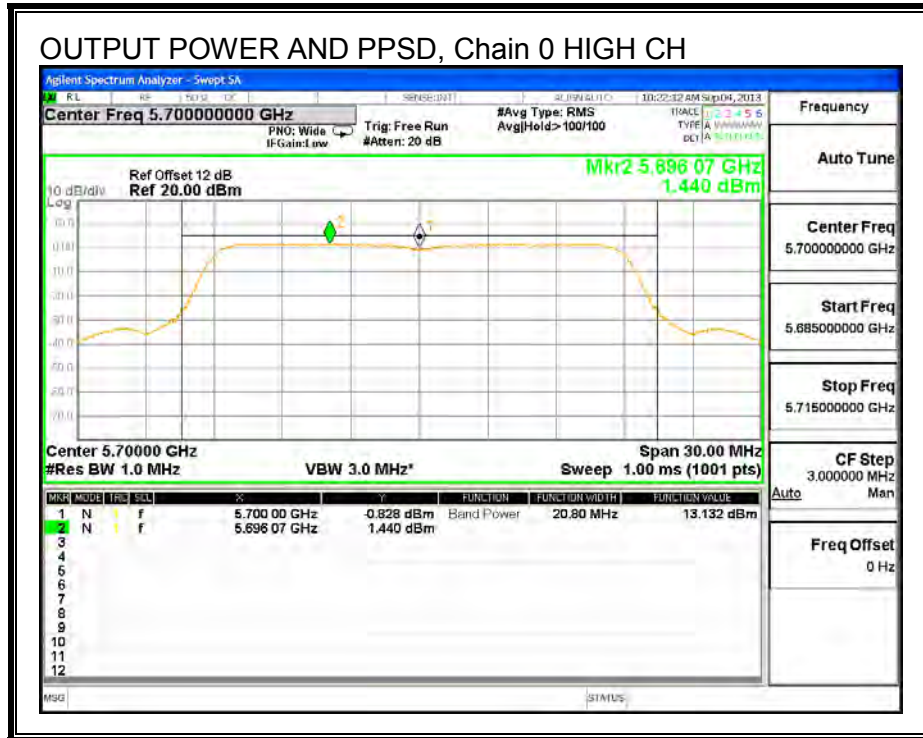

OUTPUT POWER AND PPSD, Chain 1

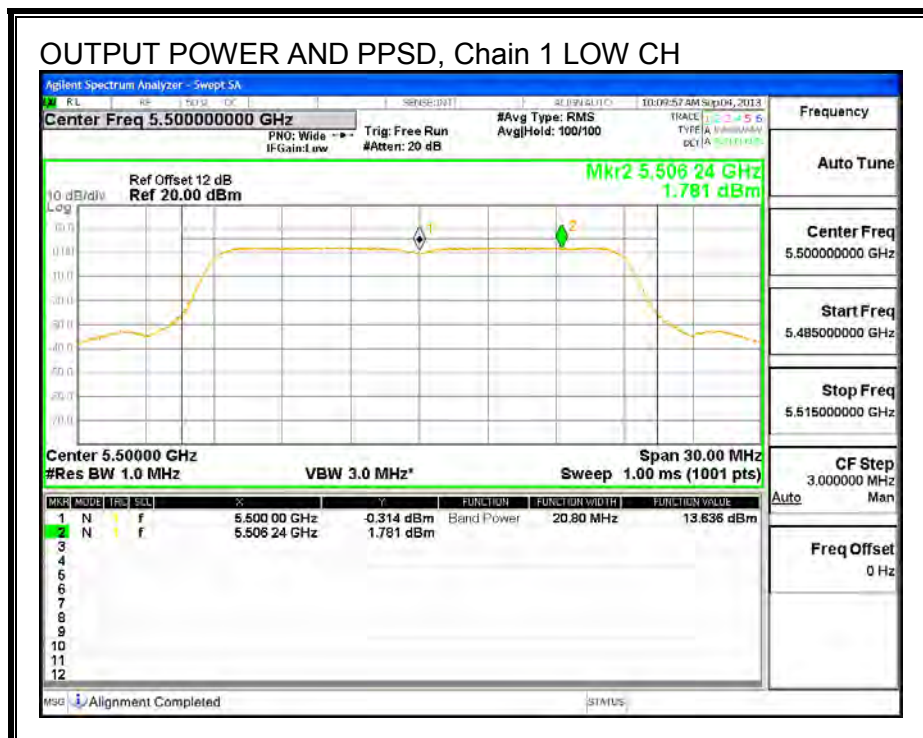

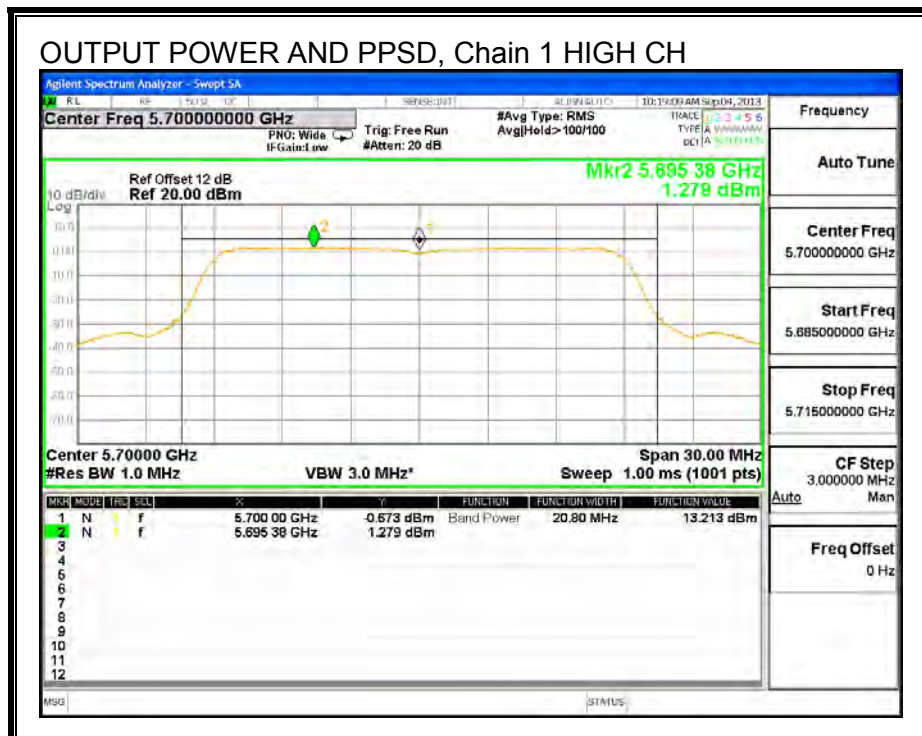
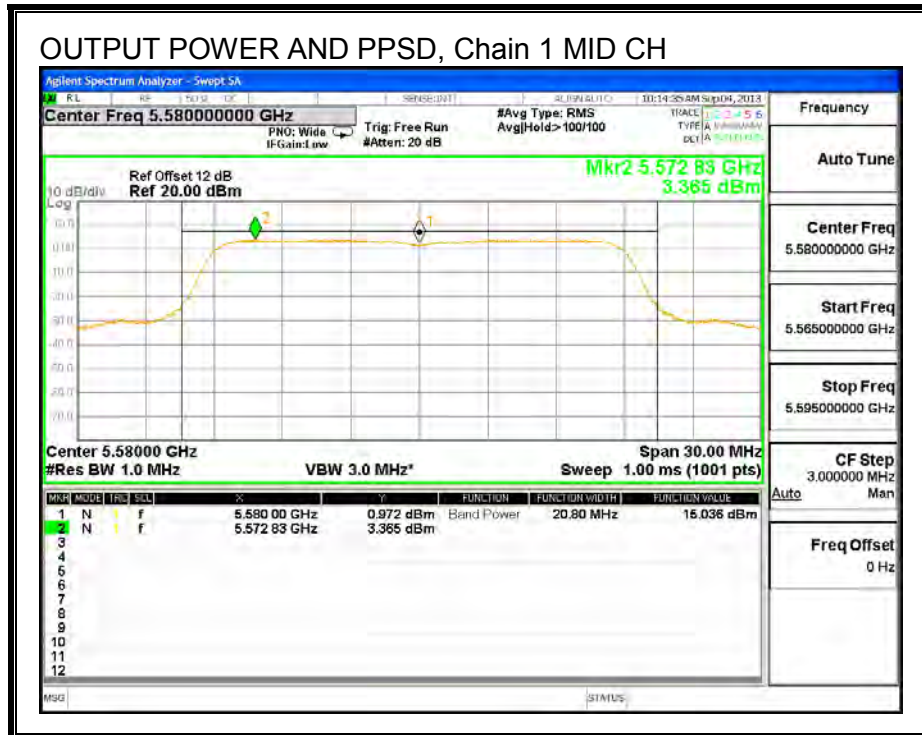

8.11. 802.11n HT40 SISO MODE IN THE 5.6 GHz BAND

8.11.1. 26 dB BANDWIDTH

LIMITS

None; for reporting purposes only.

RESULTS

Channel	Frequency (MHz)	26 dB Bandwidth (MHz)
Low	5510	39.88
Mid	5550	39.90
High	5670	39.74

26 dB BANDWIDTH

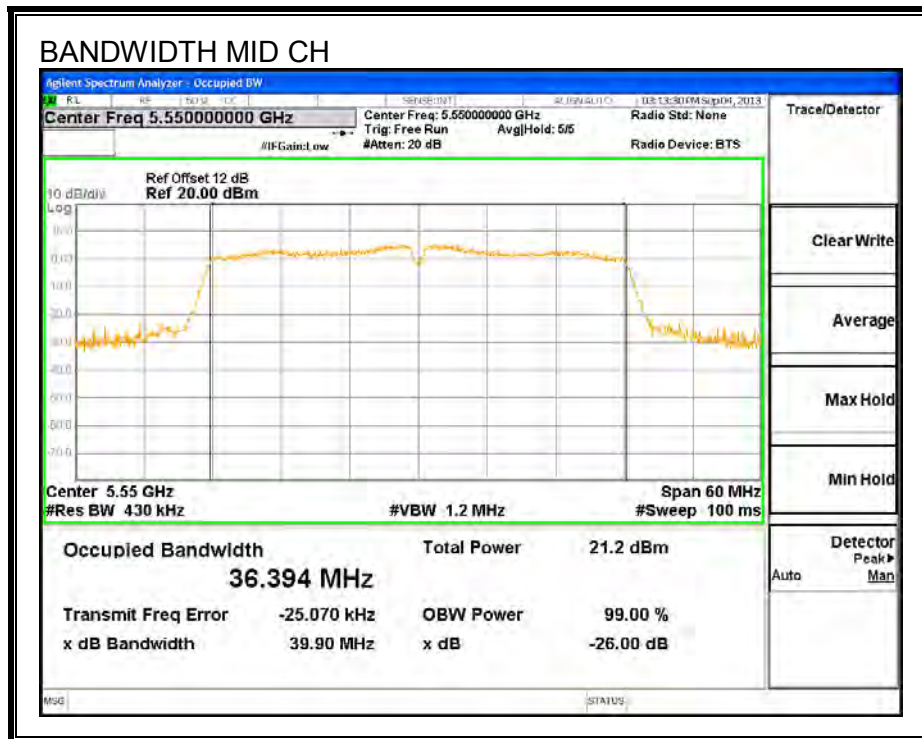
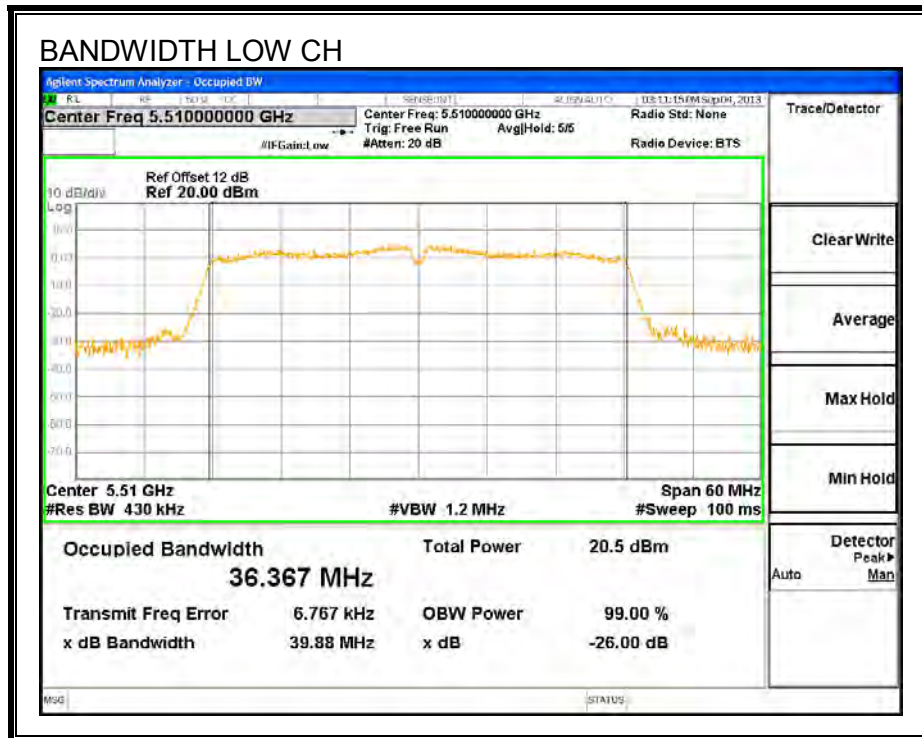

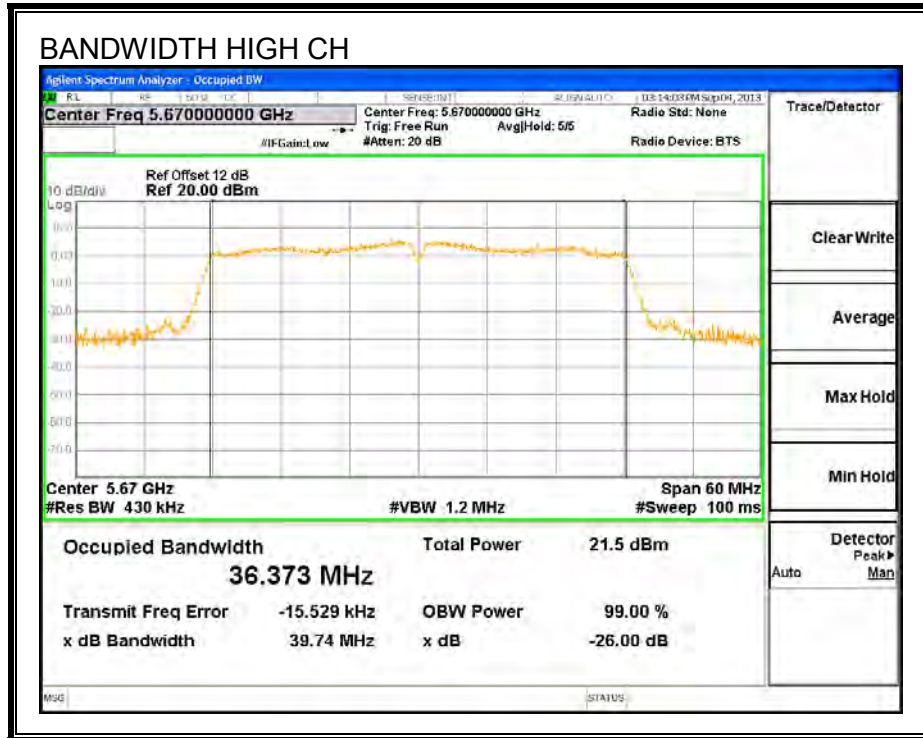

8.11.2. 99% BANDWIDTH

LIMITS

None; for reporting purposes only.

RESULTS

Channel	Frequency (MHz)	99% Bandwidth (MHz)
Low	5510	36.345
Mid	5550	36.226
High	5670	36.462

99% BANDWIDTH

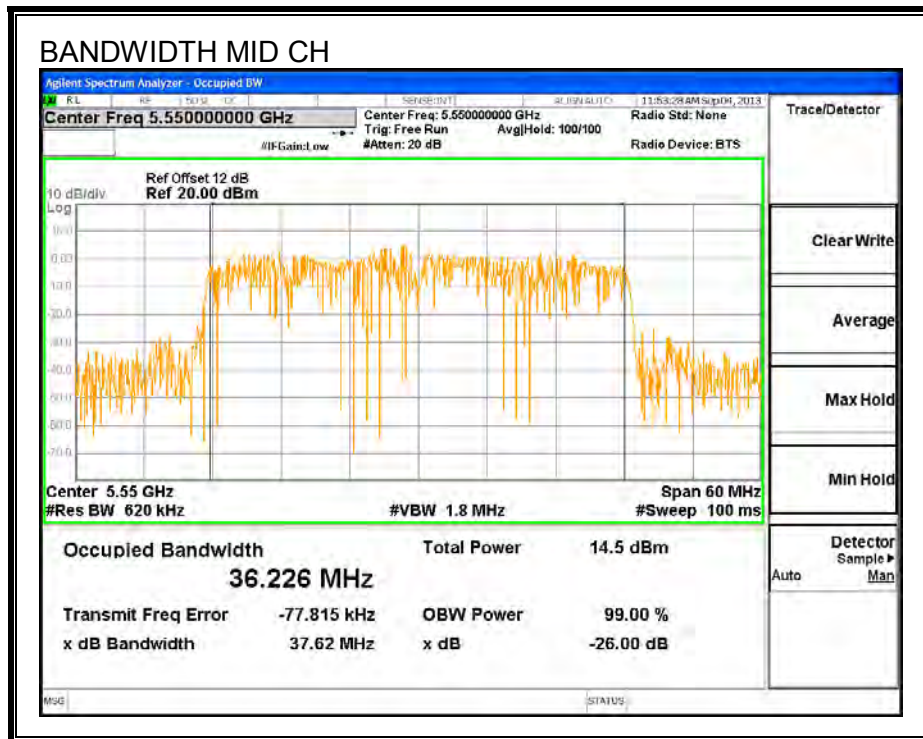
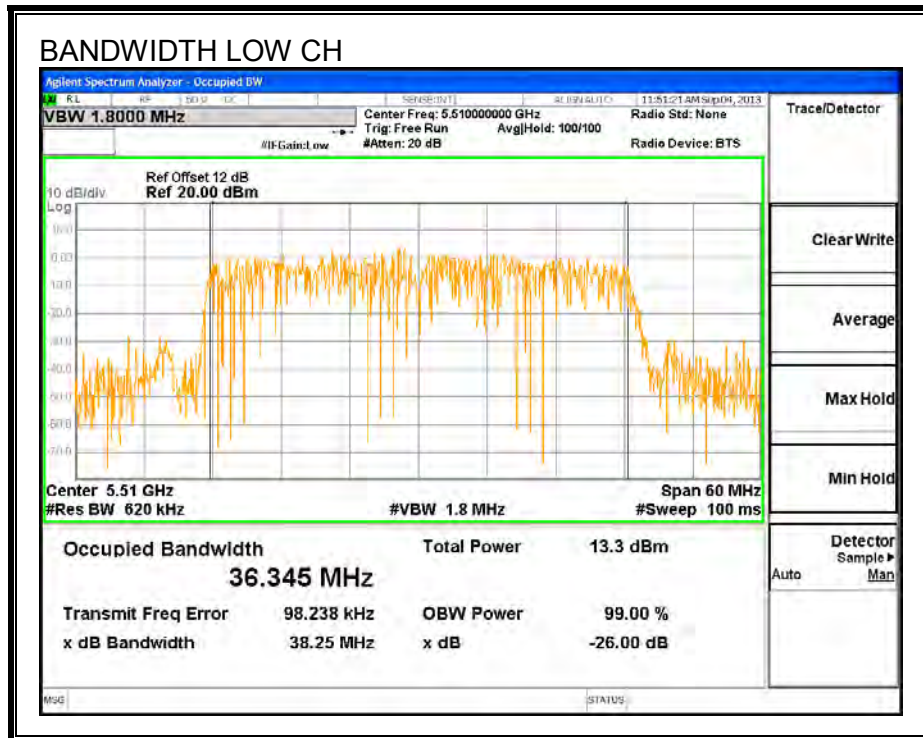

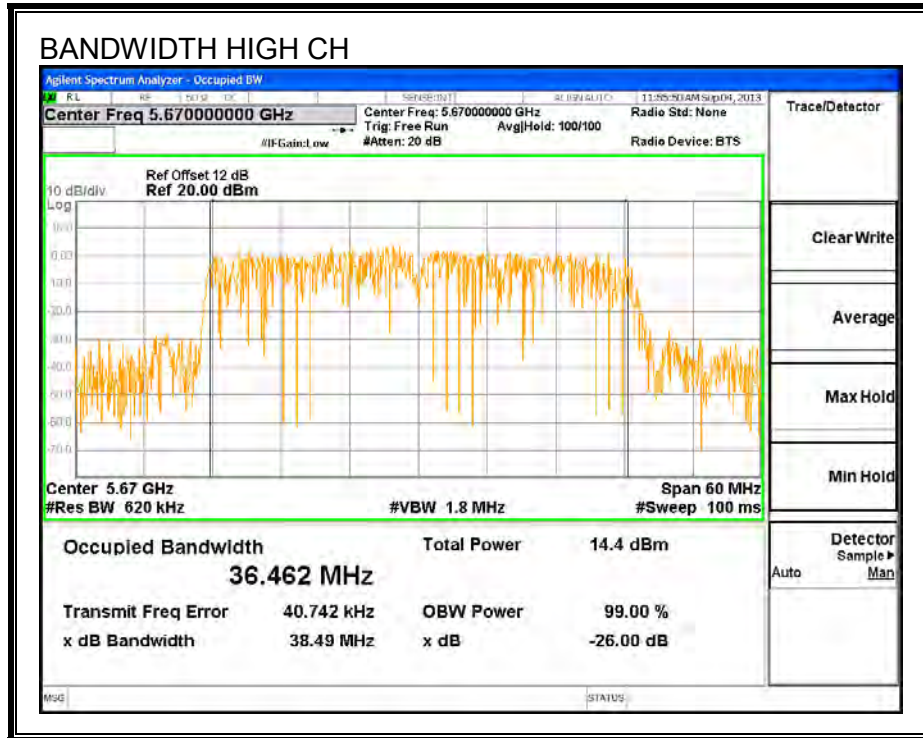

8.11.3. AVERAGE POWER

LIMITS

None; for reporting purposes only.

TEST PROCEDURE

The transmitter output is connected to a power meter.

The cable assembly insertion loss of 12 dB (including 10 dB pad and 2 dB cable) was entered as an offset in the power meter to allow for direct reading of power.

RESULTS

Channel	Frequency (MHz)	Power (dBm)
Low	5510	14.00
Mid	5550	14.95
High	5670	14.95

8.11.4. OUTPUT POWER AND PPSD

LIMITS

FCC §15.407 (a) (2)

For the band 5.47–5.725 GHz, the maximum conducted output power over the frequency band of operation shall not exceed the lesser of 250 mW or $11 \text{ dBm} + 10 \log B$, where B is the 26-dB emission bandwidth in MHz. In addition, the maximum power spectral density shall not exceed 11 dBm in any 1-MHz band. If transmitting antennas of directional gain greater than 6 dBi are used, both the maximum conducted output power and the peak power spectral density shall be reduced by the amount in dB that the directional gain of the antenna exceeds 6 dBi.

DIRECTIONAL ANTENNA GAIN

There is only one transmitter output therefore the directional gain is equal to the antenna gain.

RESULTS

Bandwidth and Antenna Gain

Channel	Frequency (MHz)	Min 26 dB BW (MHz)	Directional Gain (dBi)
Low	5510	39.9	4.29
Mid	5550	39.9	4.29
High	5670	39.7	4.29

Limits

Channel	Frequency (MHz)	FCC Power Limit (dBm)	FCC PPSD Limit (dBm)
Low	5510	24.00	11.00
Mid	5550	24.00	11.00
High	5670	24.00	11.00

Duty Cycle CF (dB)	0.00	Included in Calculations of Corr'd Power & PPSD
---------------------------	------	--

Output Power Results

Channel	Frequency (MHz)	Chain 0 Meas Power (dBm)	Total Corr'd Power (dBm)	Power Limit (dBm)	Power Margin (dB)
Low	5510	14.38	14.38	24.00	-9.62
Mid	5550	15.16	15.16	24.00	-8.84
High	5670	15.20	15.20	24.00	-8.80

PPSD Results

Channel	Frequency (MHz)	Chain 0 Meas PPSD (dBm)	Total Corr'd PPSD (dBm)	PPSD Limit (dBm)	PPSD Margin (dB)
Low	5510	1.40	1.40	11.00	-9.60
Mid	5550	2.09	2.09	11.00	-8.91
High	5670	1.93	1.93	11.00	-9.08

OUTPUT POWER AND PPSD, Chain 0

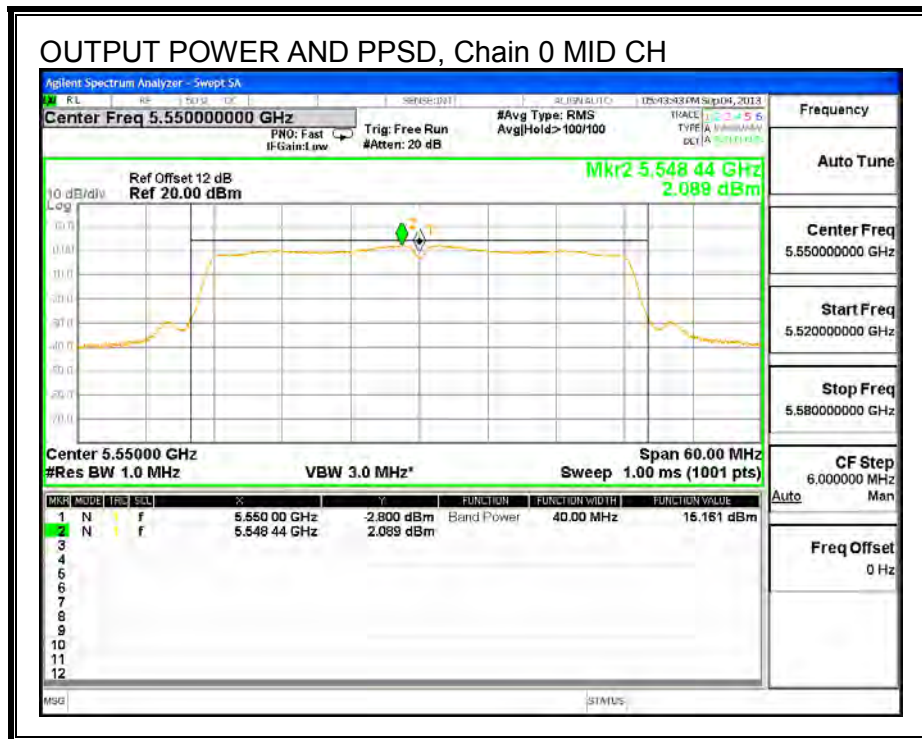
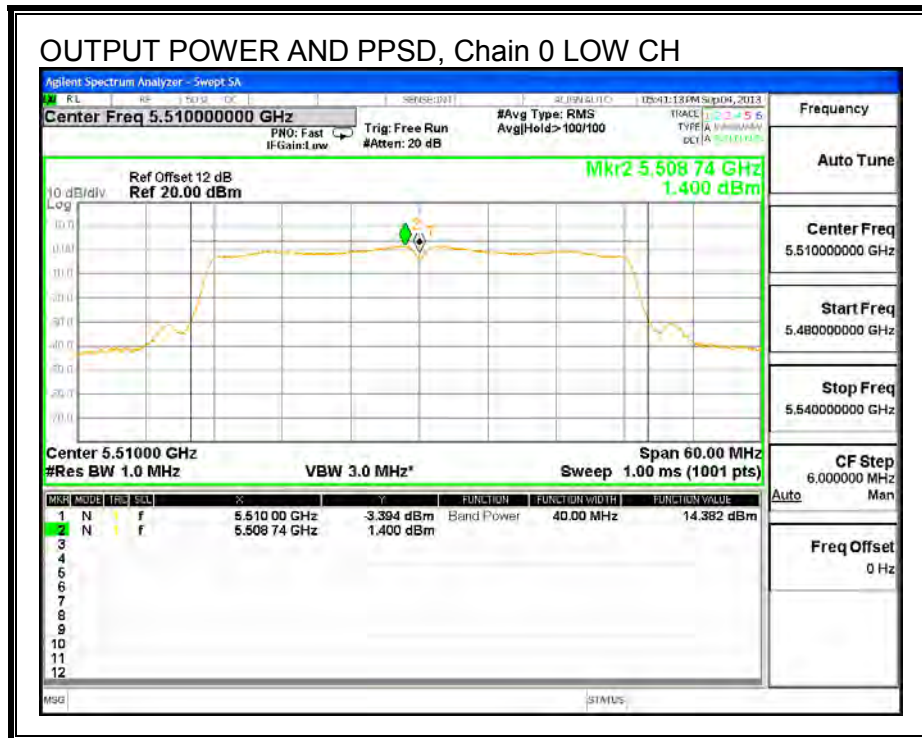

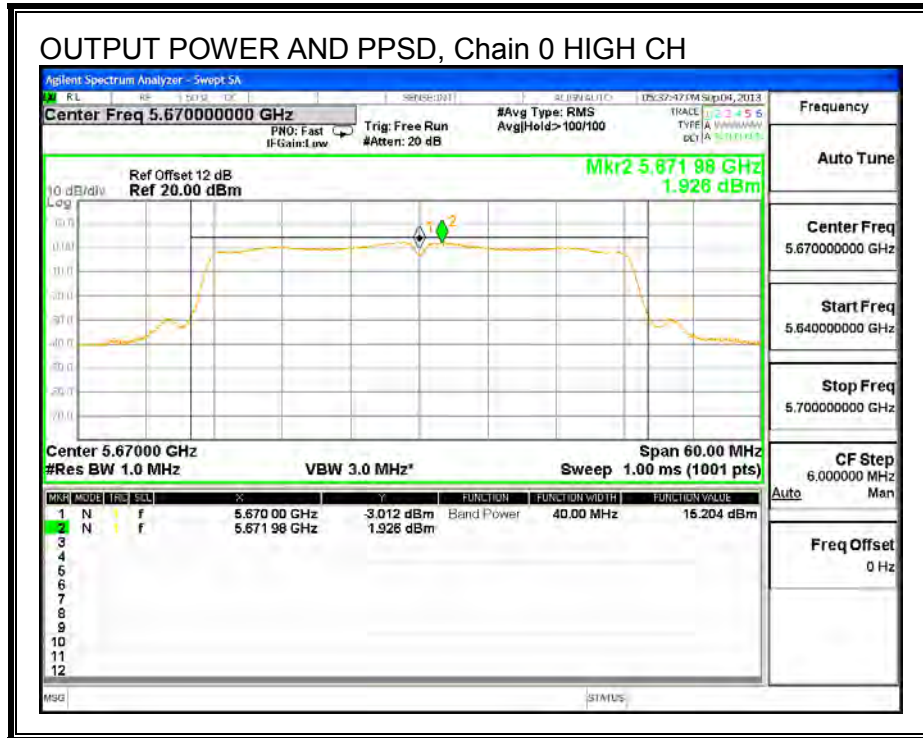

8.12. 802.11n 2TX HT40 CDD MODE IN THE 5.6 GHZ BAND

8.12.1. 26 dB BANDWIDTH

LIMITS

None; for reporting purposes only.

RESULTS

Channel	Frequency (MHz)	26 dB BW Chain 0 (MHz)	26 dB BW Chain 1 (MHz)
Low	5510	39.46	39.34
Mid	5550	39.89	39.28
High	5670	39.77	39.43

26 dB BANDWIDTH, Chain 0

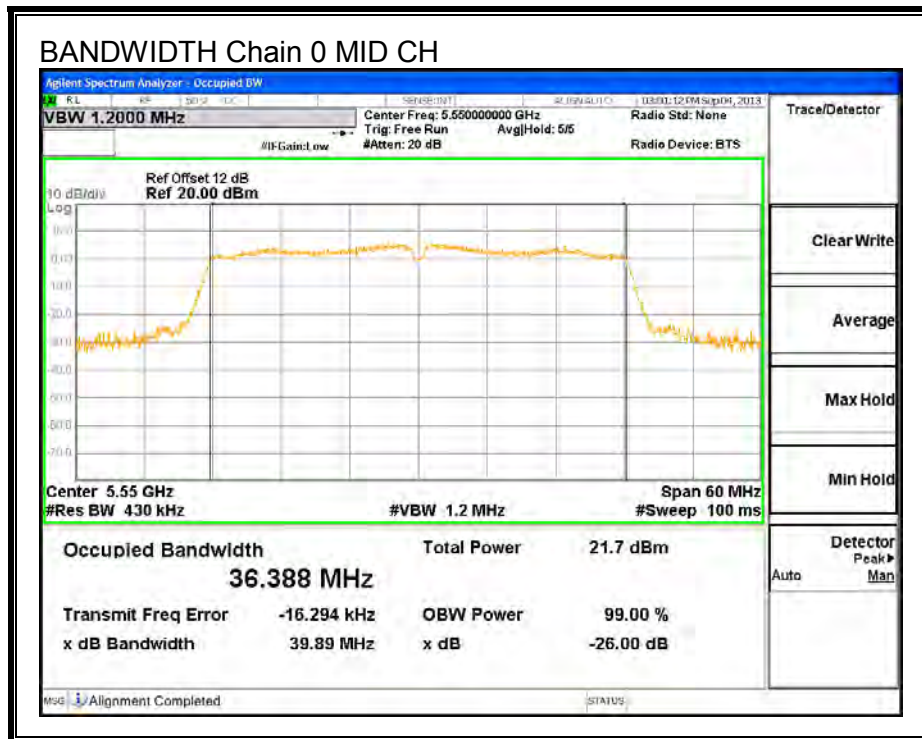
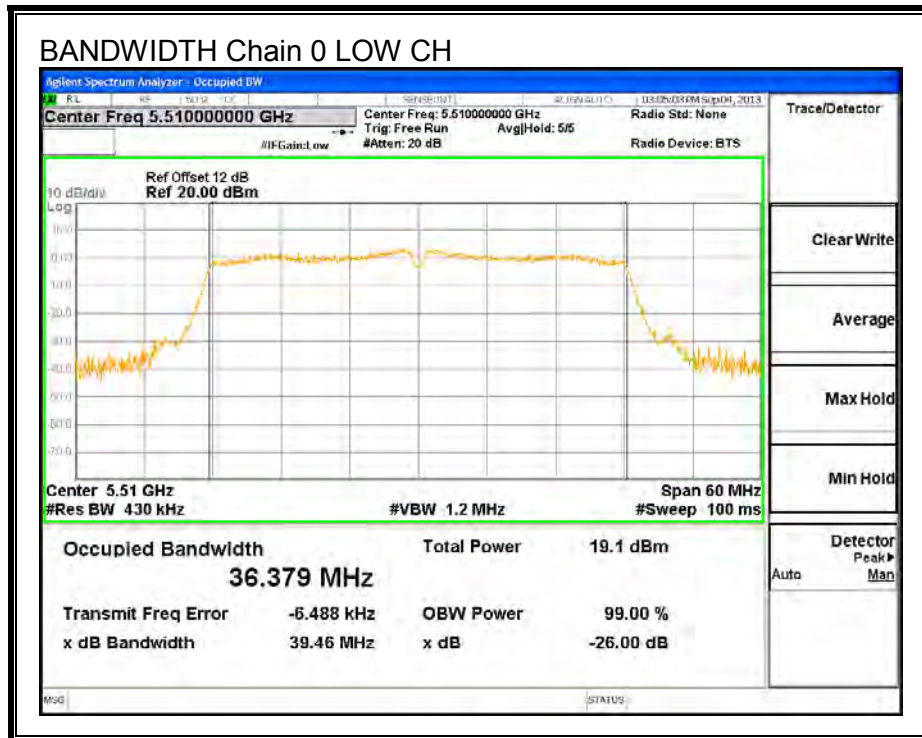

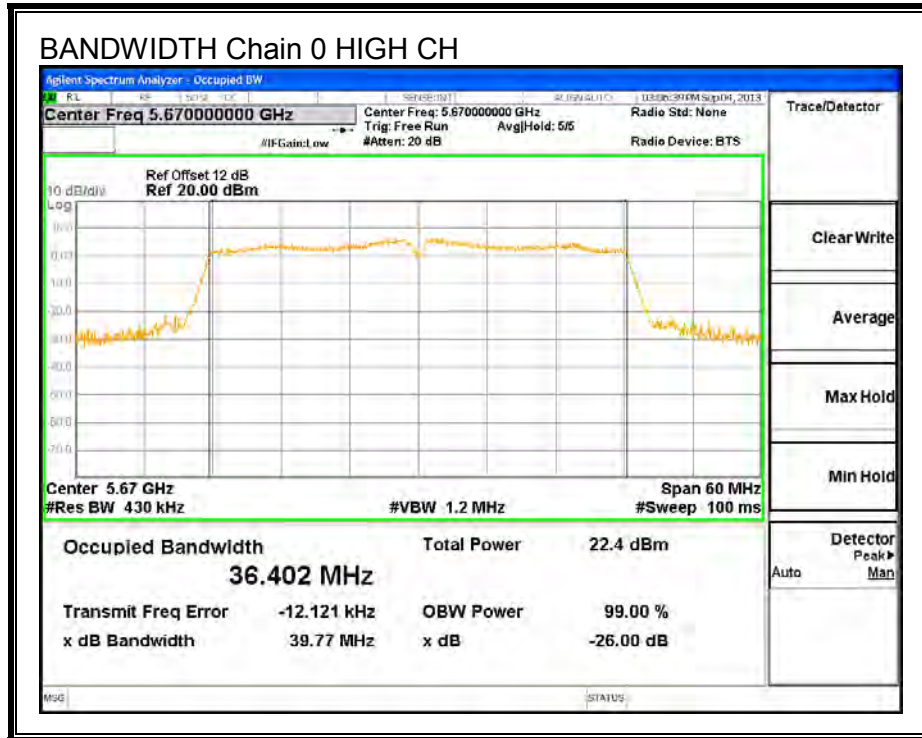

26 dB BANDWIDTH, Chain 1

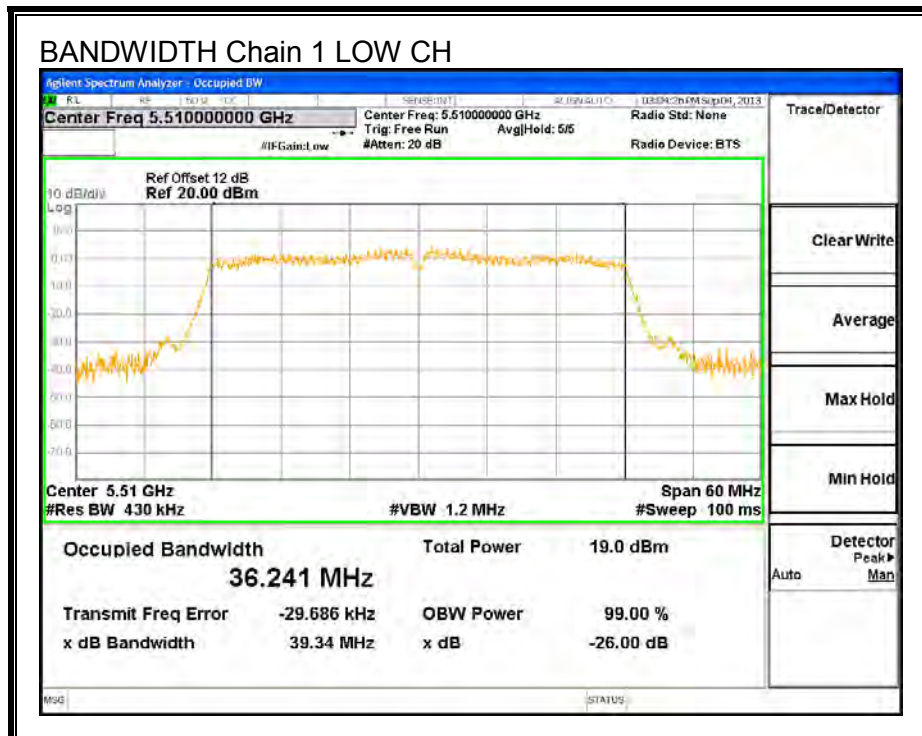

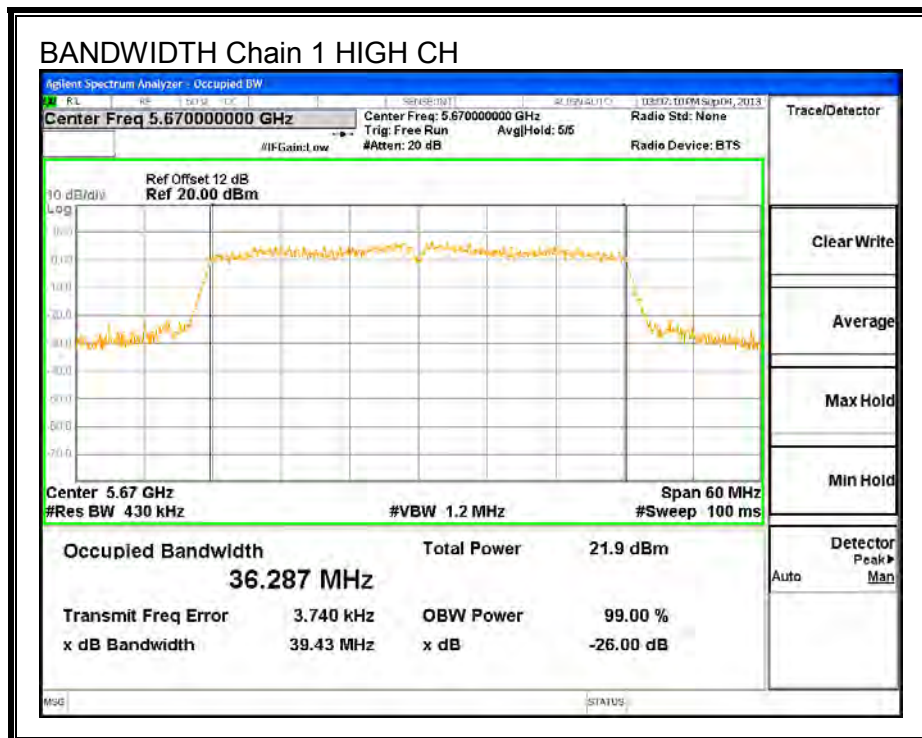
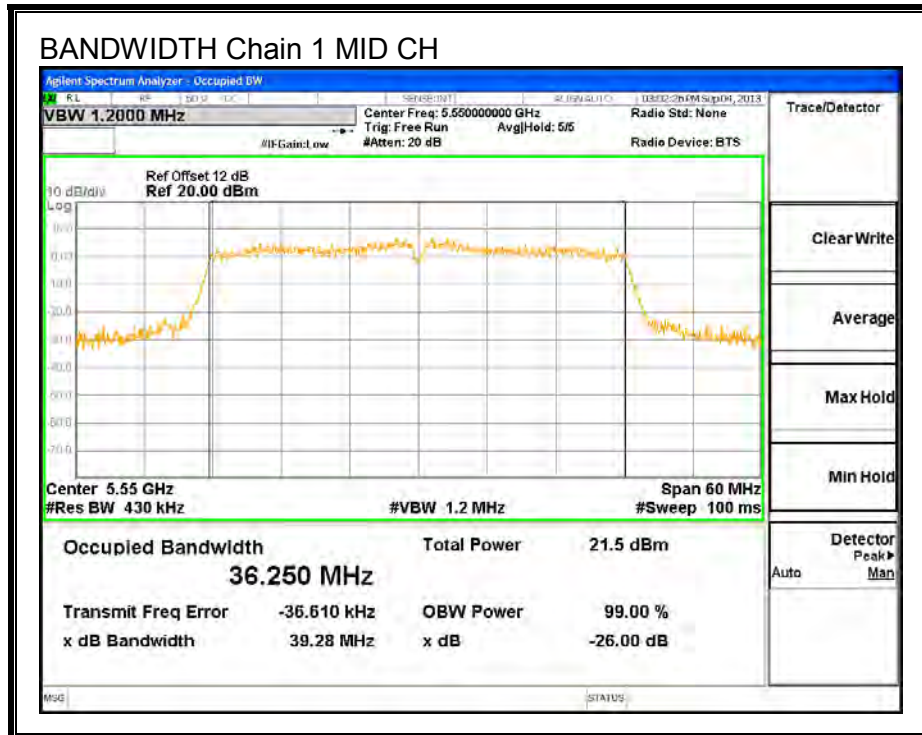

8.12.2. 99% BANDWIDTH

LIMITS

None; for reporting purposes only.

RESULTS

Channel	Frequency (MHz)	99% BW Chain 0 (MHz)	99% BW Chain 1 (MHz)
Low	5510	35.872	36.047
Mid	5550	36.289	36.511
High	5670	36.312	35.952

99% BANDWIDTH, Chain 0

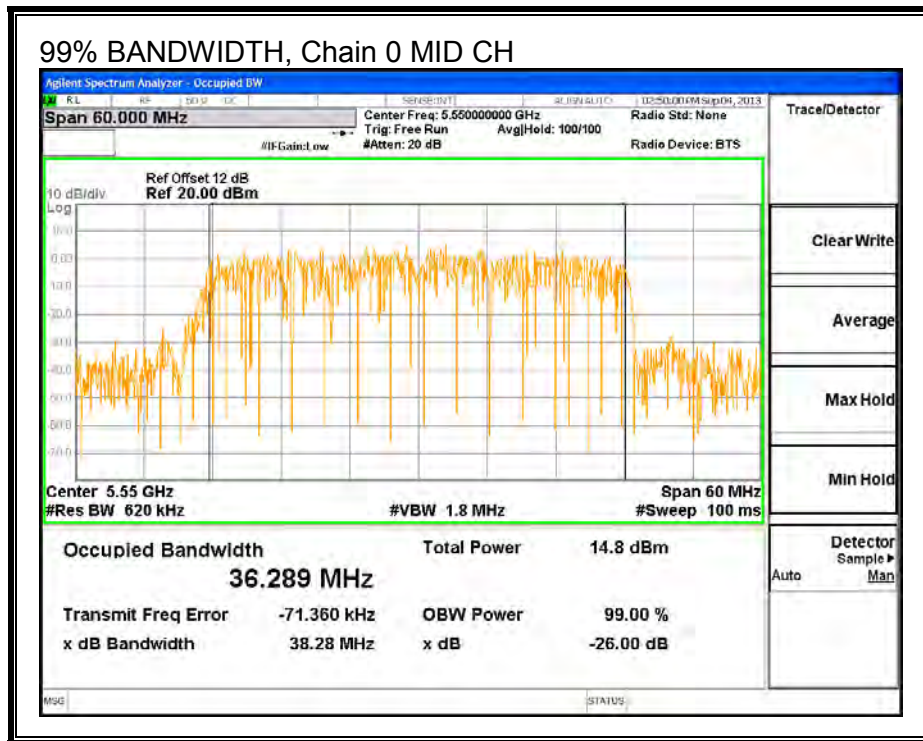
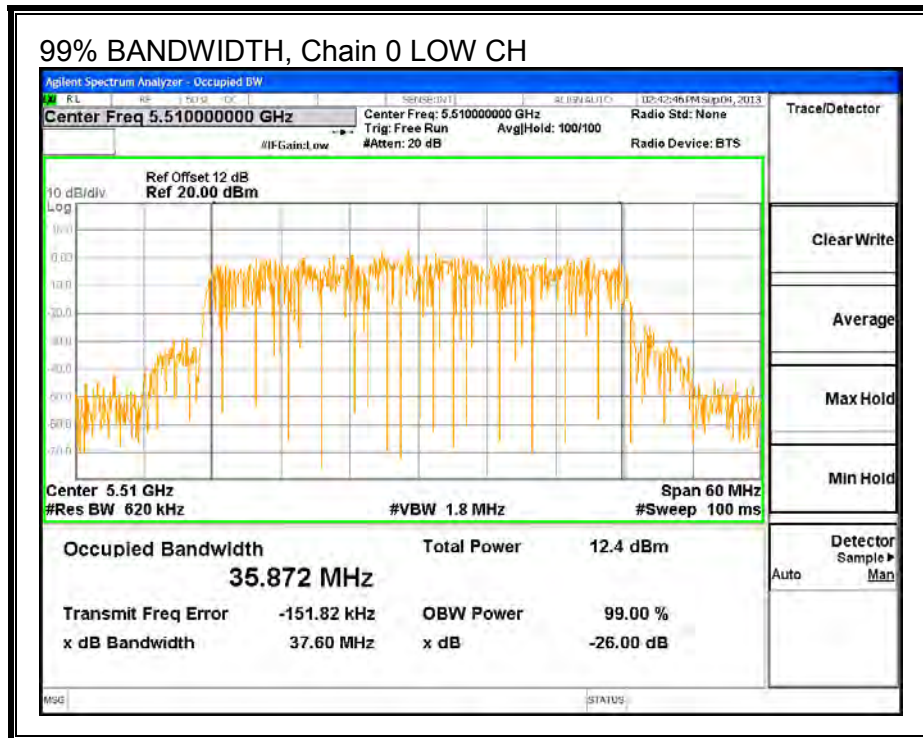

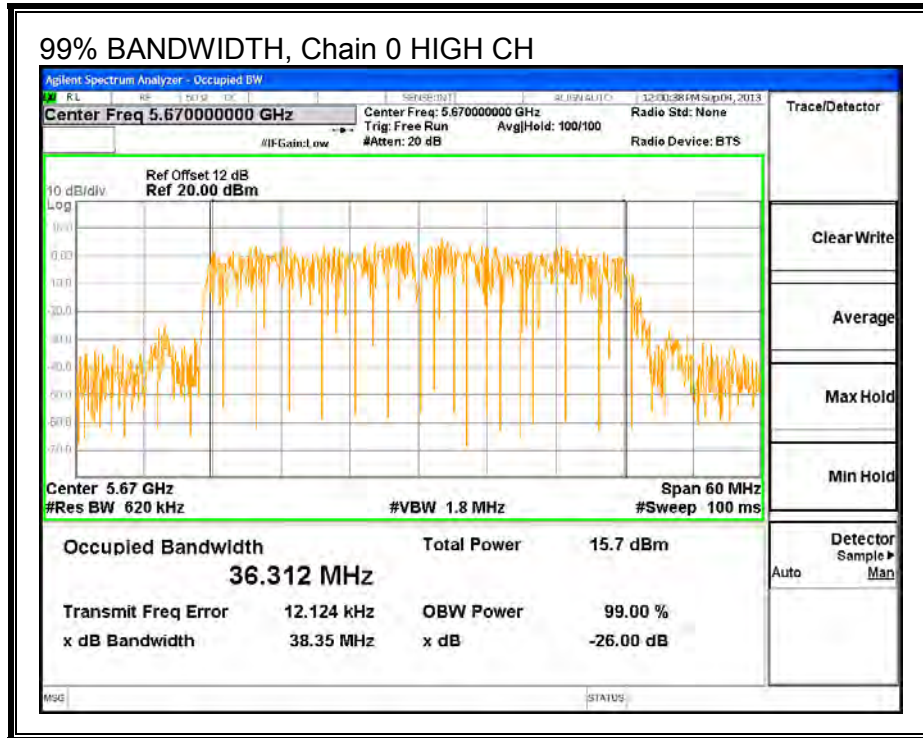

99% BANDWIDTH, Chain 1

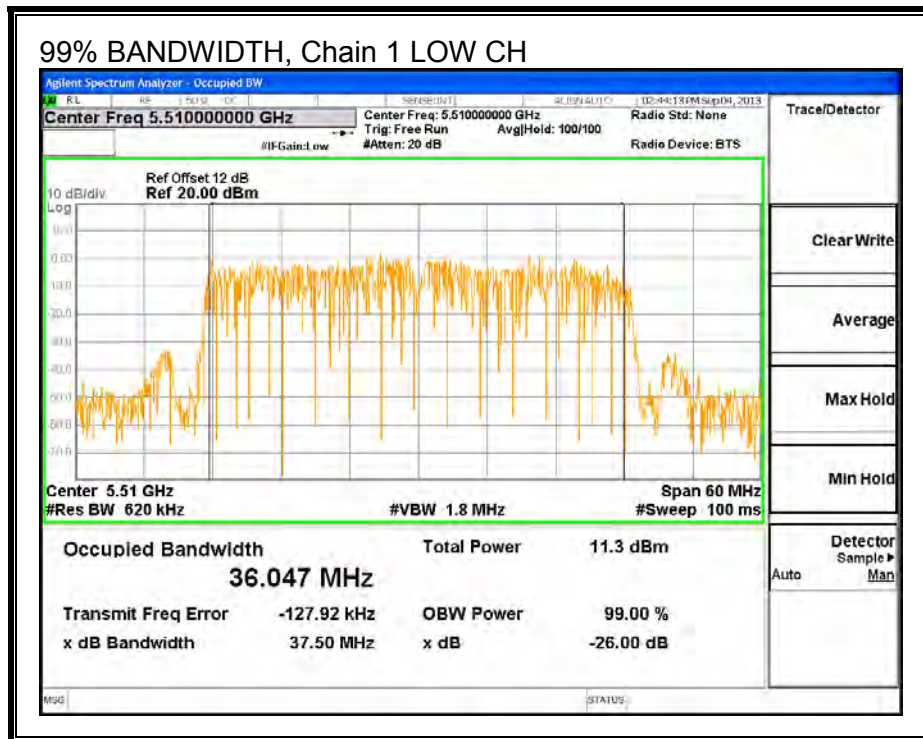

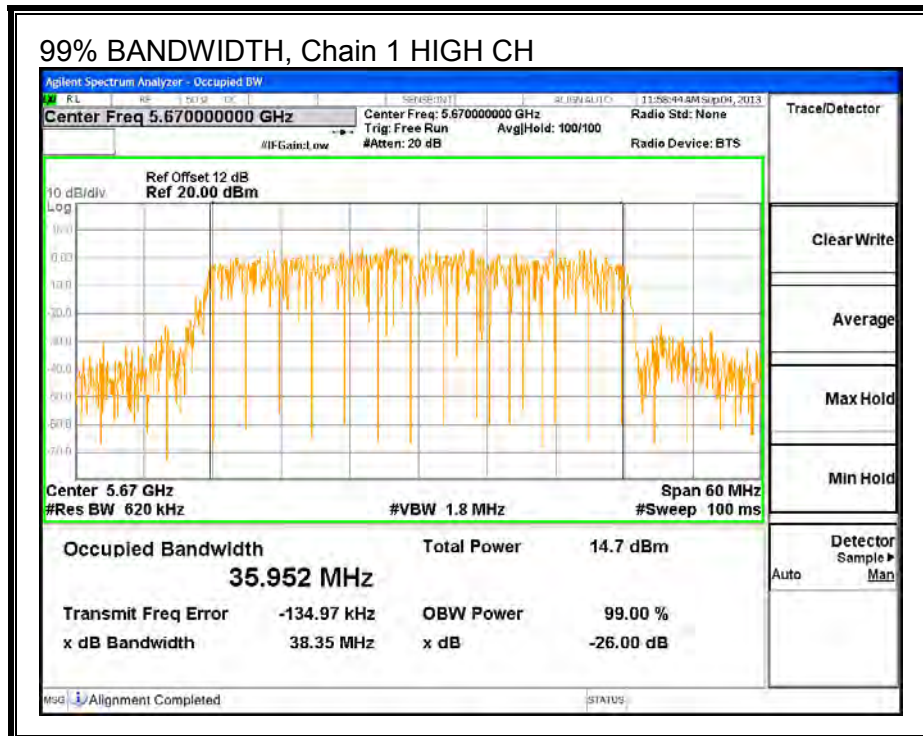
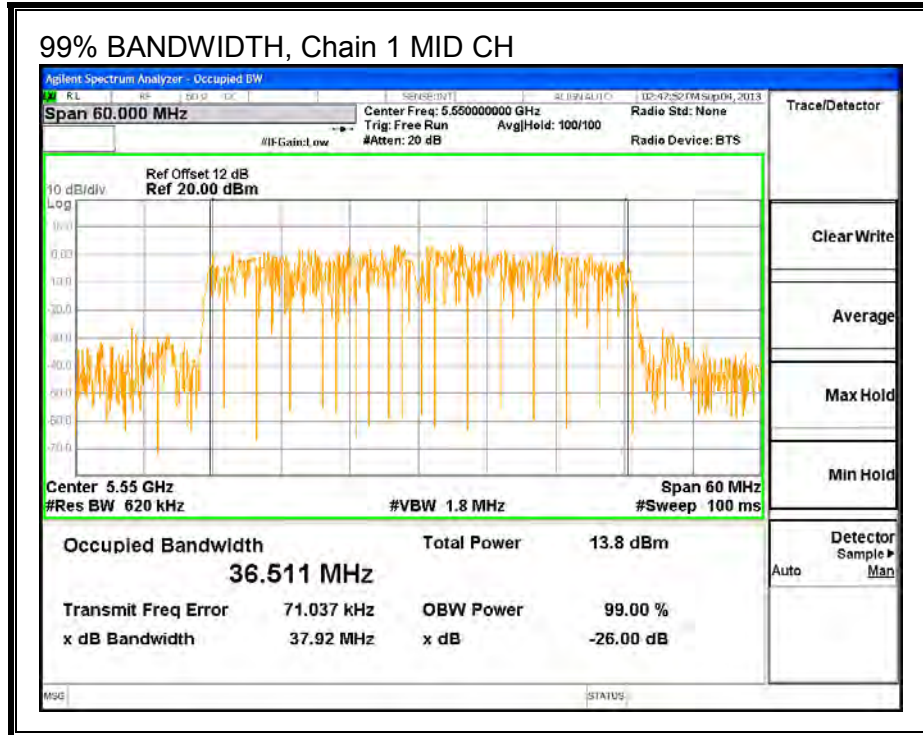

8.12.3. AVERAGE POWER

LIMITS

None; for reporting purposes only.

TEST PROCEDURE

The transmitter output is connected to a power meter.

The cable assembly insertion loss of 12 dB (including 10 dB pad and 2 dB cable) was entered as an offset in the power meter to allow for direct reading of power.

RESULTS

Average Power Results

Channel	Frequency (MHz)	Chain 0 Power (dBm)	Chain 1 Power (dBm)	Total Power (dBm)
Low	5510	11.95	12.00	14.99
Mid	5550	15.00	15.00	18.01
High	5670	15.00	14.95	17.99

8.12.4. OUTPUT POWER AND PPSD

LIMITS

FCC §15.407 (a) (2)

For the band 5.47–5.725 GHz, the maximum conducted output power over the frequency band of operation shall not exceed the lesser of 250 mW or 11 dBm + 10 log B, where B is the 26–dB emission bandwidth in MHz. In addition, the maximum power spectral density shall not exceed 11 dBm in any 1–MHz band. If transmitting antennas of directional gain greater than 6 dBi are used, both the maximum conducted output power and the peak power spectral density shall be reduced by the amount in dB that the directional gain of the antenna exceeds 6 dBi.

DIRECTIONAL ANTENNA GAIN

The TX chains are uncorrelated and the antenna gain is unequal among the chains. The directional gain is:

Chain 0 Antenna Gain (dBi)	Chain 1 Antenna Gain (dBi)	Uncorrelated Chains Directional Gain (dBi)
2.43	4.29	3.46

The TX chains are correlated and the antenna gain is unequal among the chains. The directional gain is:

Chain 0 Antenna Gain (dBi)	Chain 1 Antenna Gain (dBi)	Correlated Chains Directional Gain (dBi)
2.43	4.29	6.42

RESULTS

Bandwidth and Antenna Gain

Channel	Frequency (MHz)	Min 26 dB BW (MHz)	Uncorrelated Directional Gain (dBi)	Correlated Directional Gain (dBi)
Low	5510	39.3	3.46	6.42
Mid	5550	39.3	3.46	6.42
High	5670	39.4	3.46	6.42

Limits

Channel	Frequency (MHz)	FCC Power Limit (dBm)	FCC PPSD Limit (dBm)
Low	5510	24.00	10.58
Mid	5550	24.00	10.58
High	5670	24.00	10.58

Duty Cycle CF (dB)	0.00	Included in Calculations of Corr'd Power & PPSD
---------------------------	------	--

Output Power Results

Channel	Frequency (MHz)	Chain 0 Meas Power (dBm)	Chain 1 Meas Power (dBm)	Total Corr'd Power (dBm)	Power Limit (dBm)	Power Margi n (dB)
Low	5510	12.02	12.37	15.21	24.00	-8.79
Mid	5550	15.21	15.11	18.17	24.00	-5.83
High	5670	15.19	15.11	18.16	24.00	-5.84

PPSD Results

Channel	Frequency (MHz)	Chain 0 Meas PPSD (dBm)	Chain 1 Meas PPSD (dBm)	Total Corr'd PPSD (dBm)	PPSD Limit (dBm)	PPSD Margi n (dB)
Low	5510	-1.41	-0.69	1.98	10.58	-8.60
Mid	5550	2.02	2.12	5.08	10.58	-5.50
High	5670	2.25	2.25	5.26	10.58	-5.32

OUTPUT POWER AND PPSD, Chain 0

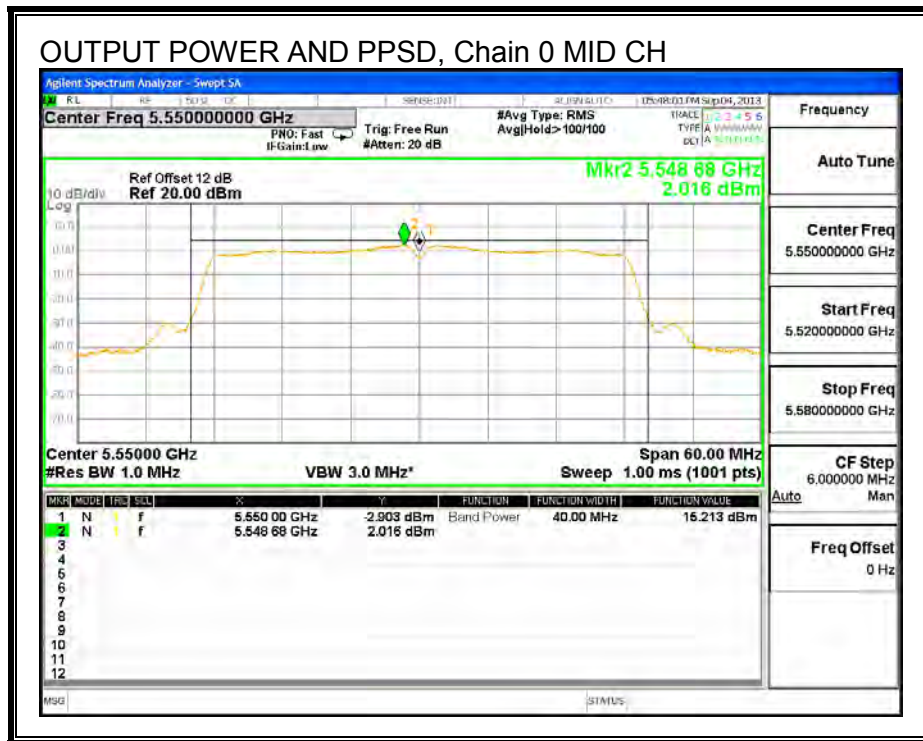
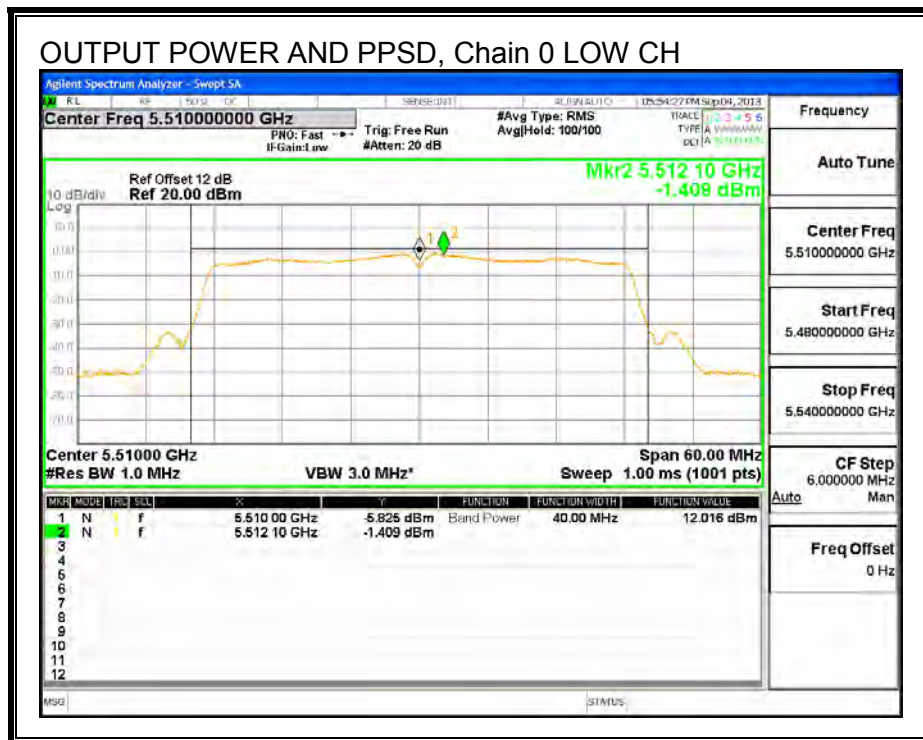

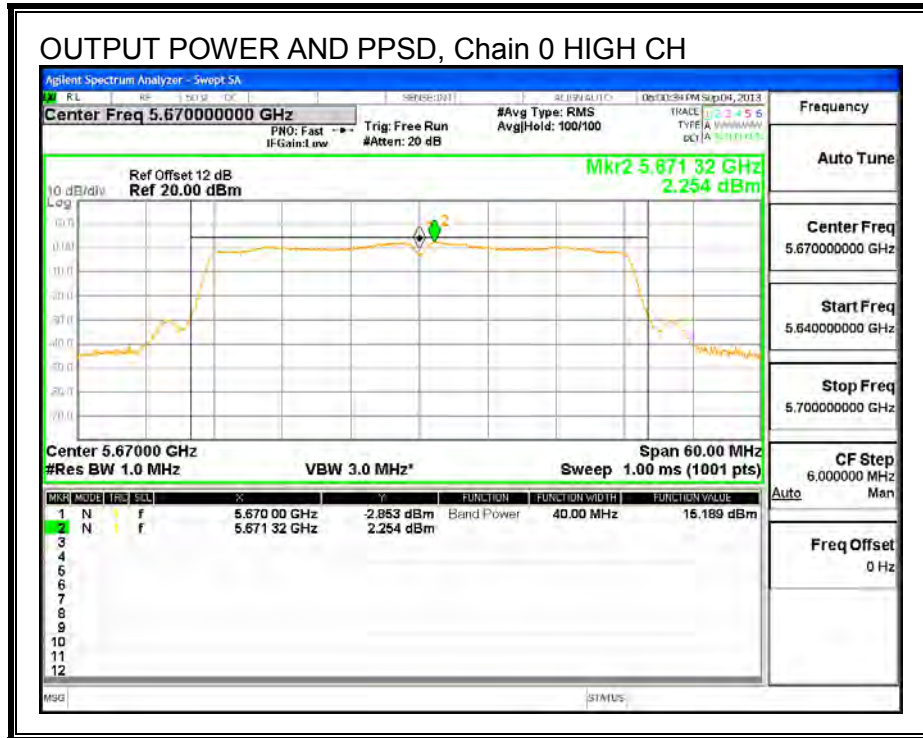

OUTPUT POWER AND PPSD, Chain 1

