

## 9. RADIATED TEST RESULTS

### 9.1. LIMITS AND PROCEDURE

#### LIMITS

FCC §15.205 and §15.209

Frequency Range (MHz)	Field Strength Limit (uV/m) at 3 m	Field Strength Limit (dBuV/m) at 3 m
30 - 88	100	40
88 - 216	150	43.5
216 - 960	200	46
Above 960	500	54

#### TEST PROCEDURE

The EUT is placed on a non-conducting table 80 cm above the ground plane. The antenna to EUT distance is 3 meters.

For measurements below 1 GHz the resolution bandwidth is set to 100 kHz for peak detection measurements or 120 kHz for quasi-peak detection measurements. Peak detection is used unless otherwise noted as quasi-peak.

For measurements above 1 GHz the resolution bandwidth is set to 1 MHz; the video bandwidth is set to 1 MHz for peak measurements and as applicable for average measurements.

The spectrum from 30 MHz to 40 GHz is investigated with the transmitter set to the lowest, middle, and highest channels in each applicable band.

The frequency range of interest is monitored at a fixed antenna height and EUT azimuth. The EUT is rotated through 360 degrees to maximize emissions received. The antenna is scanned from 1 to 4 meters above the ground plane to further maximize the emission. Measurements are made with the antenna polarized in both the vertical and the horizontal positions.

## 9.2. TRANSMITTER ABOVE 1 GHz

### 9.2.1. 802.11a SISO MODE IN THE 5.2 GHz BAND

#### RESTRICTED BANDEDGE (LOW CHANNEL)

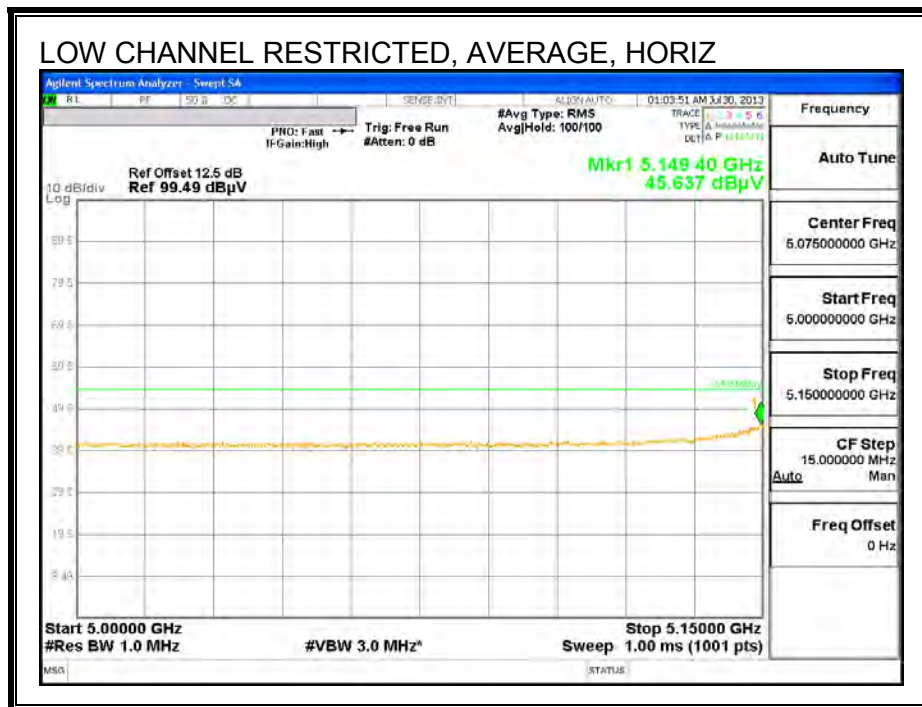
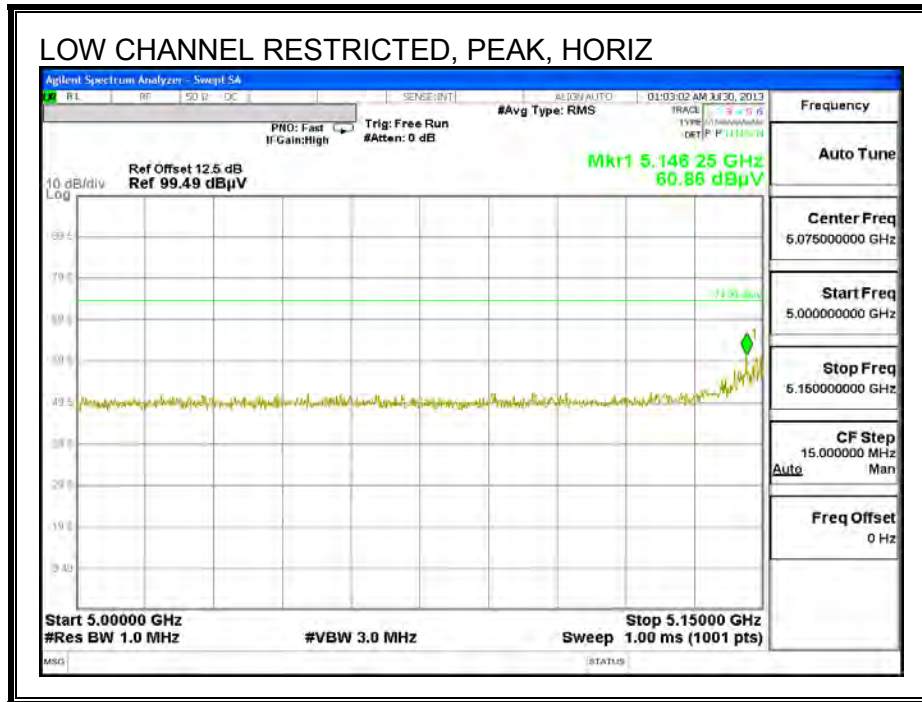

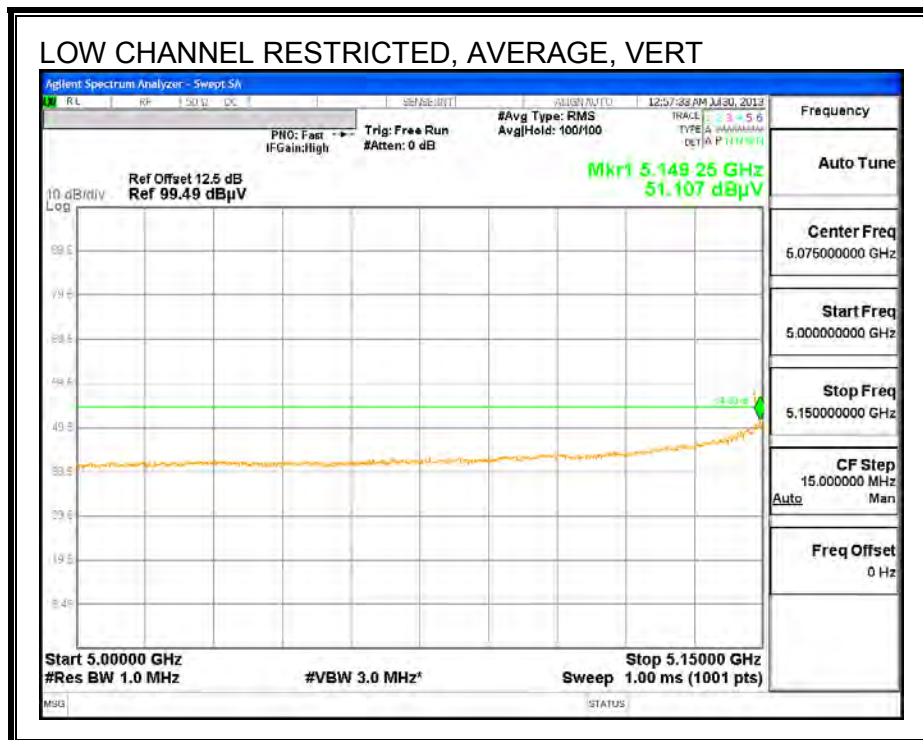
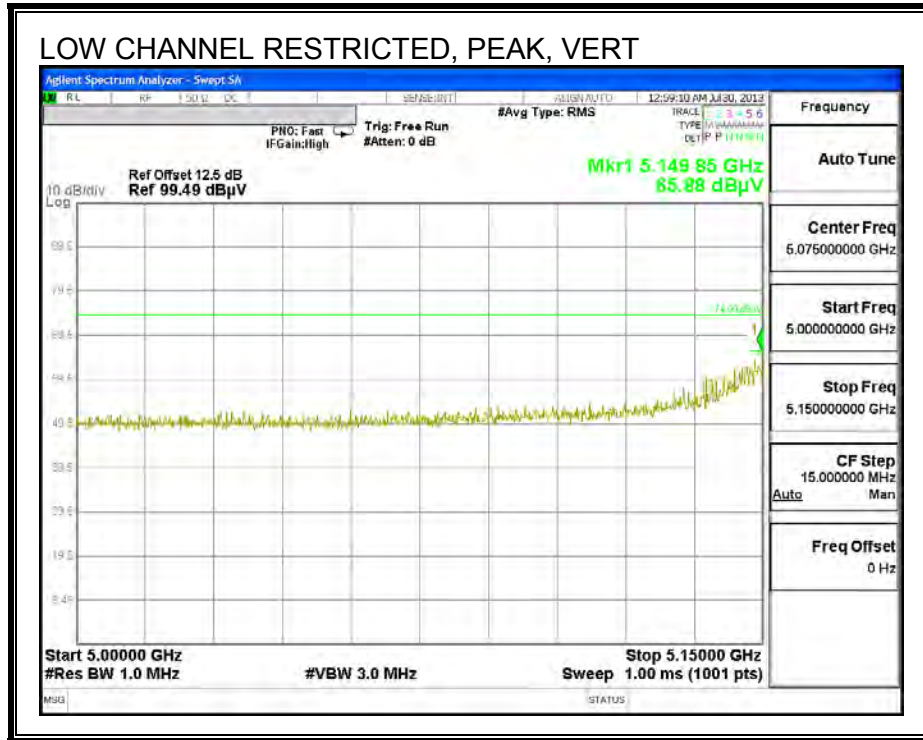

**HARMONICS AND SPURIOUS EMISSIONS**

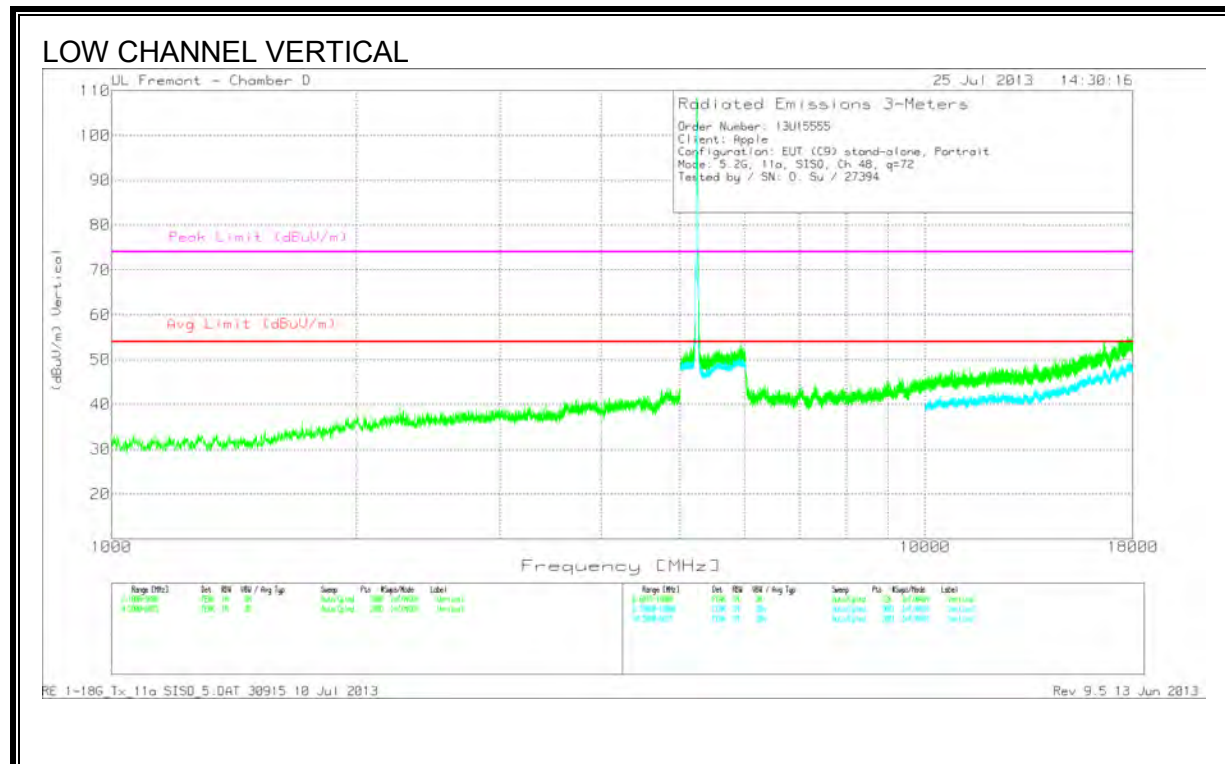
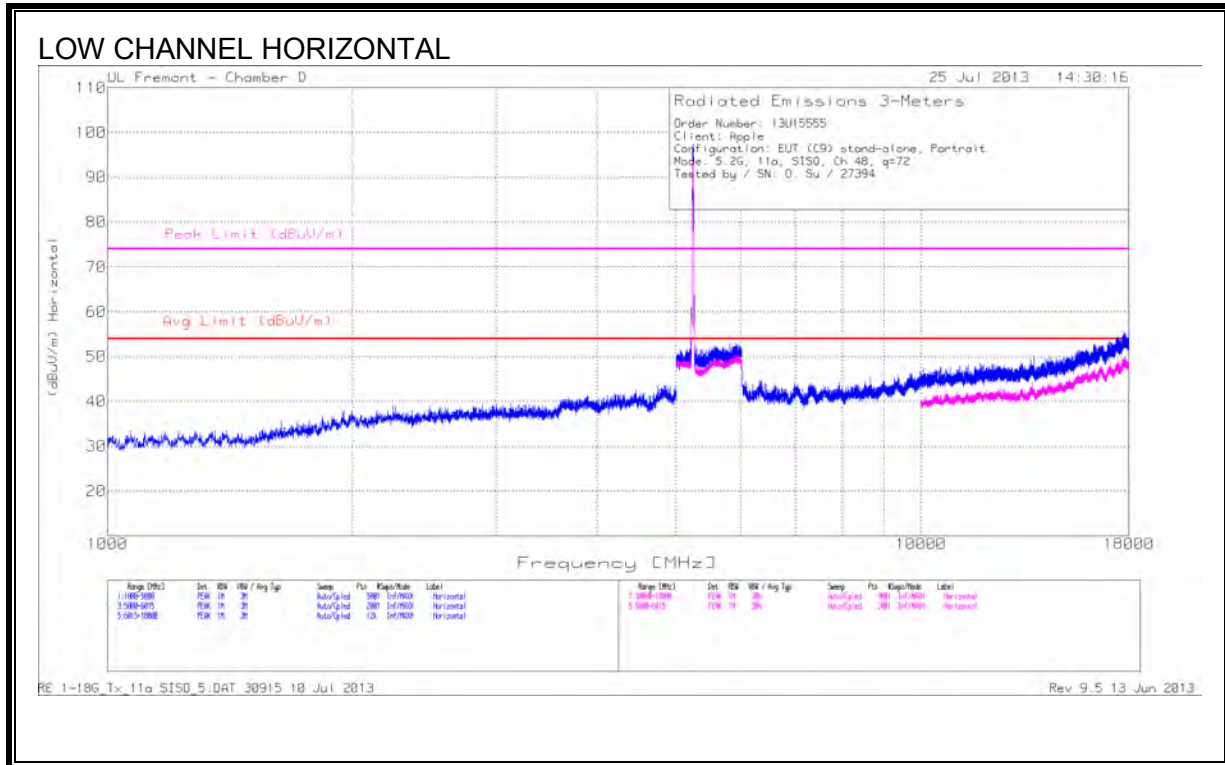

**HARMONICS AND SPURIOUS EMISSIONS**

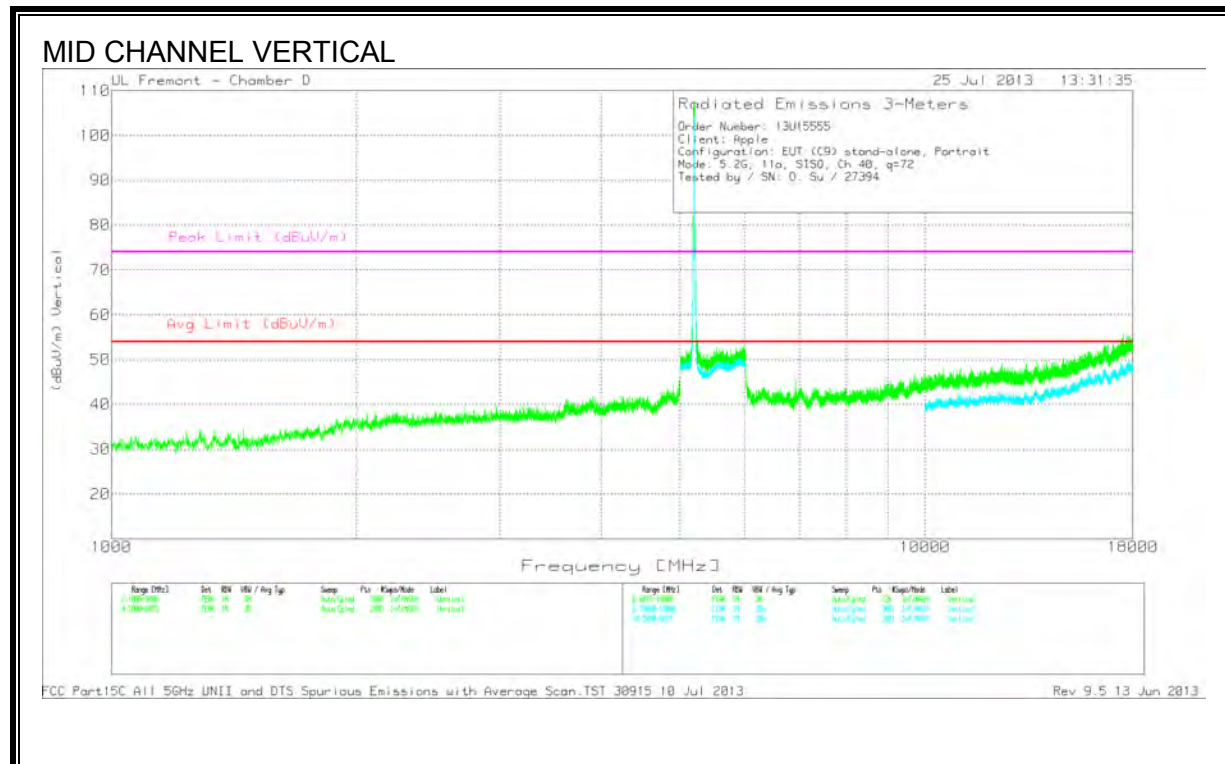
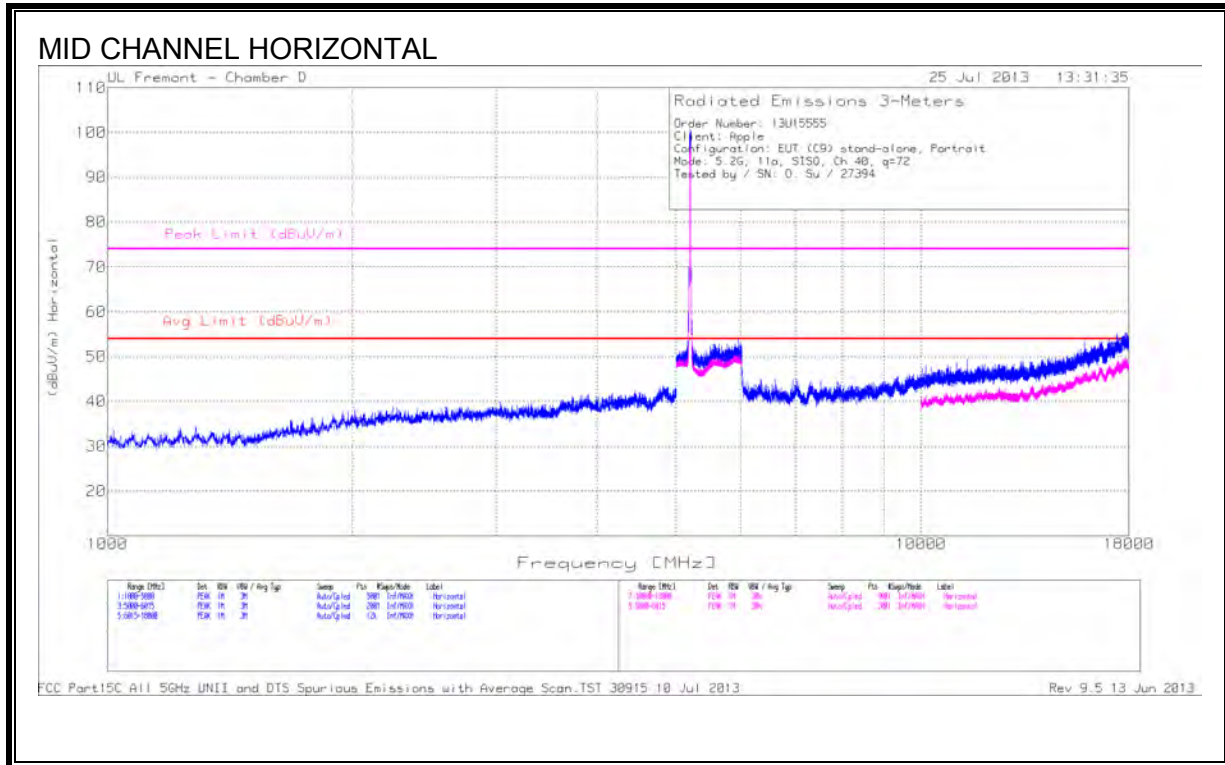

**HARMONICS AND SPURIOUS EMISSIONS**

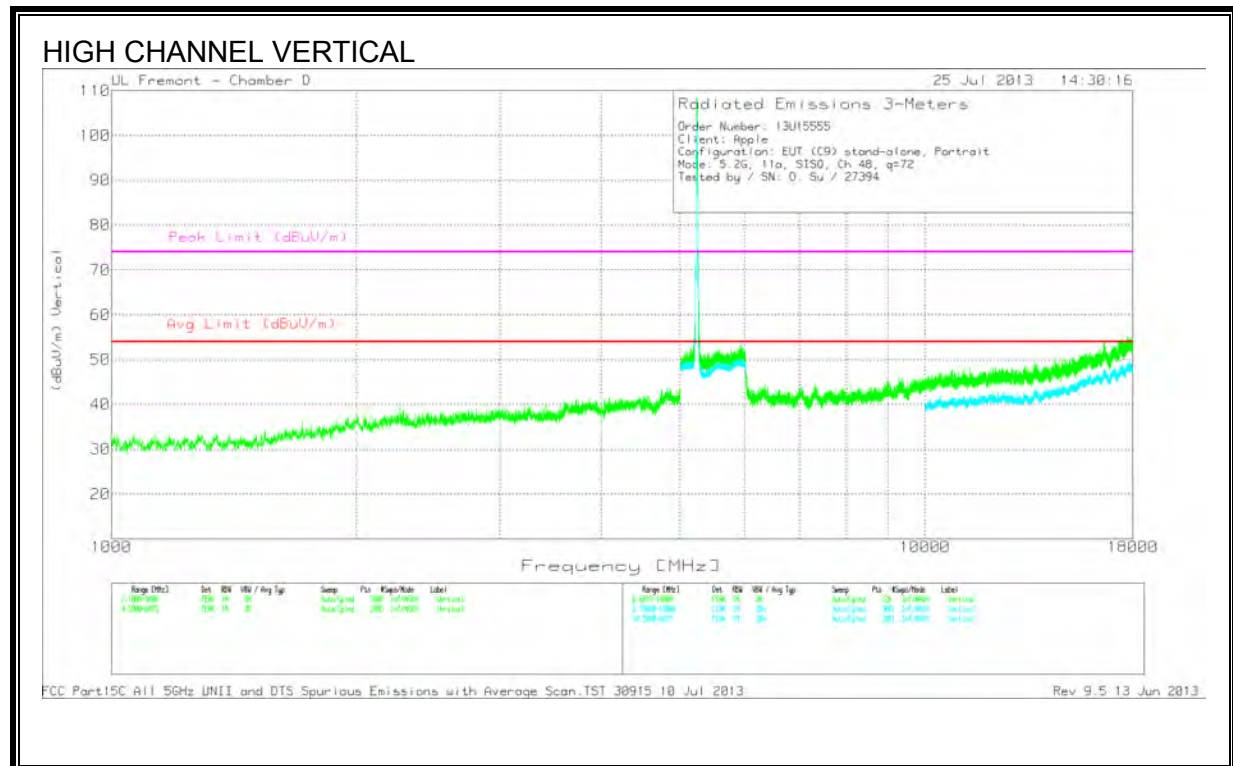
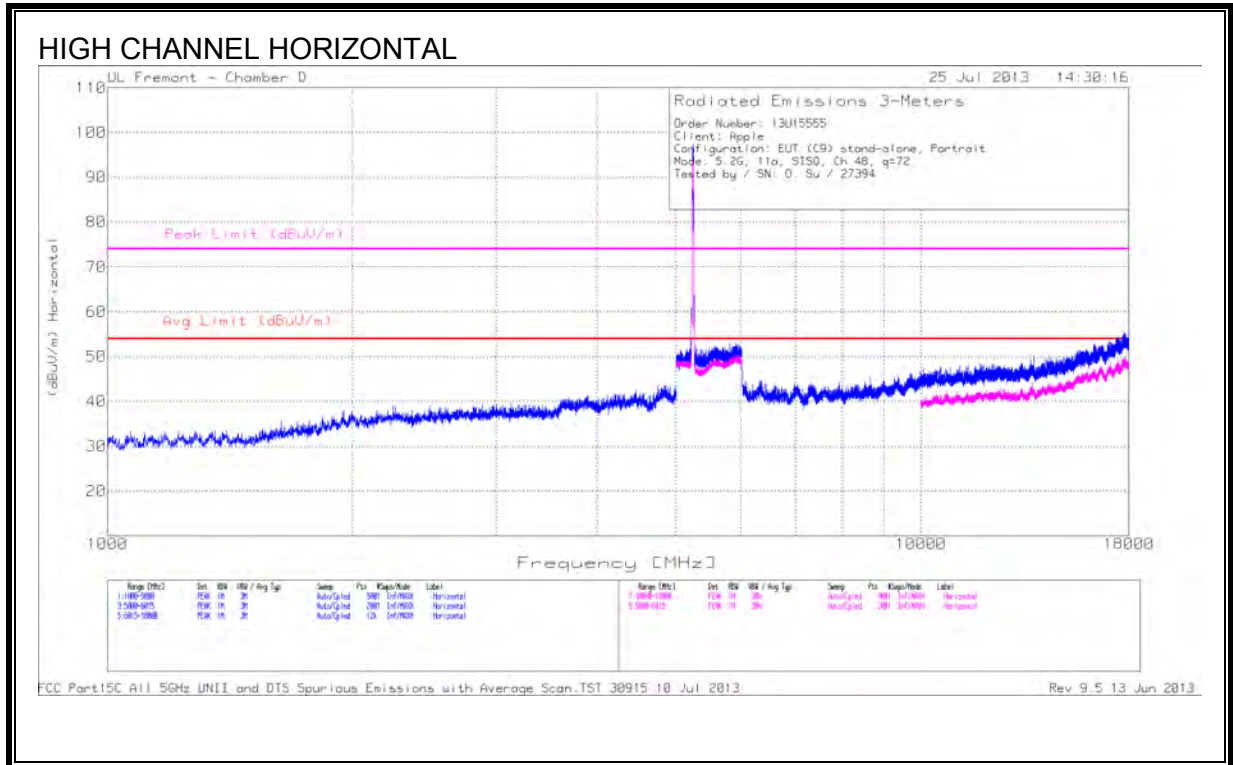

### 9.2.2. 802.11n HT20 2TX CDD MODE IN THE 5.2 GHz BAND

#### RESTRICTED BANDEDGE (LOW CHANNEL)

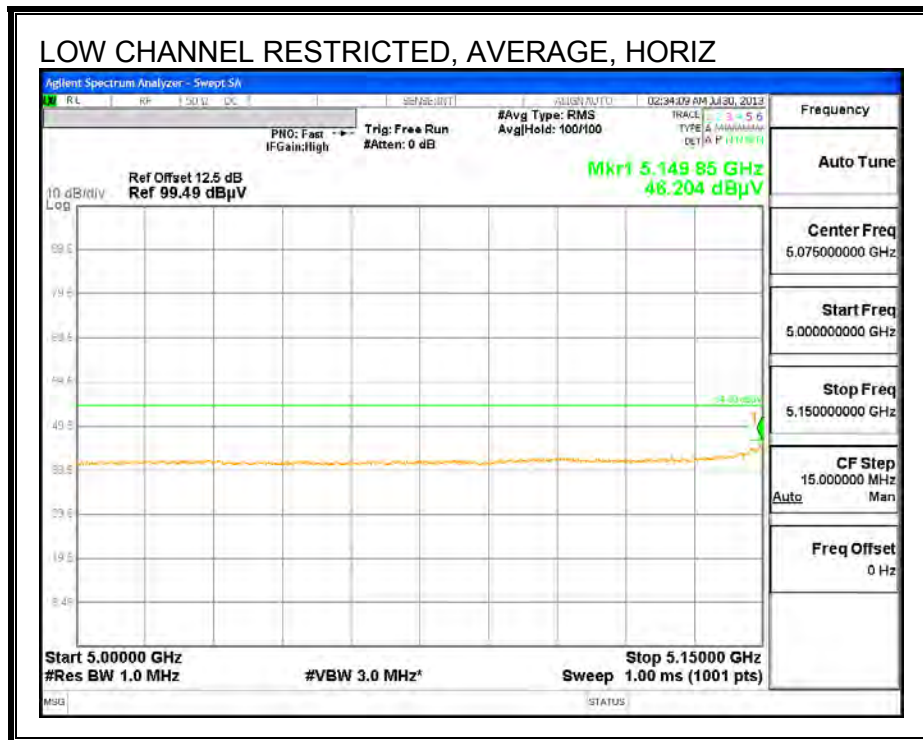
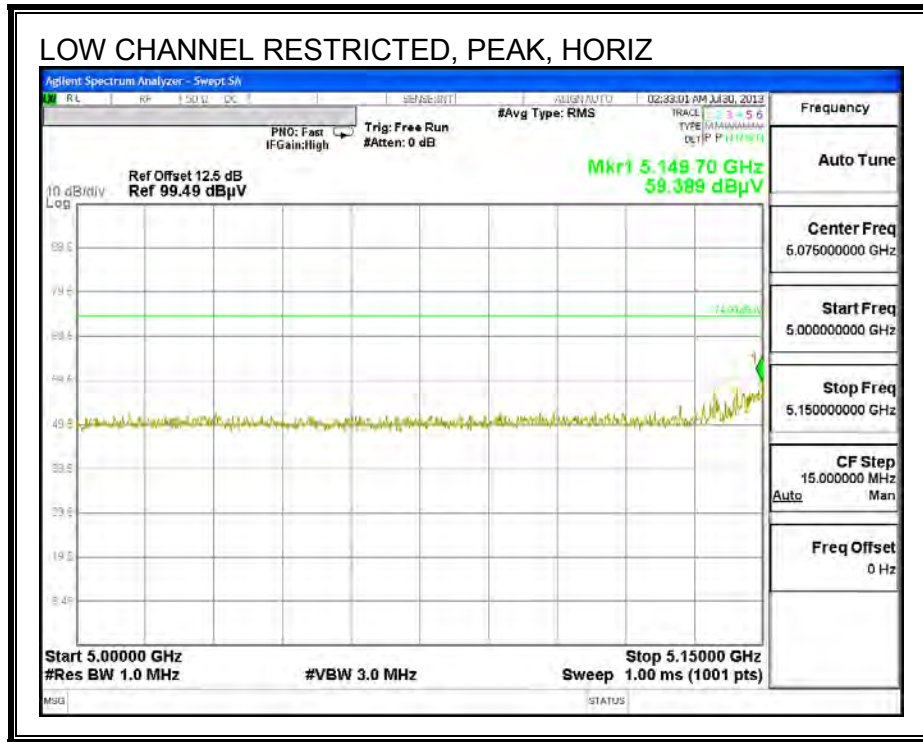

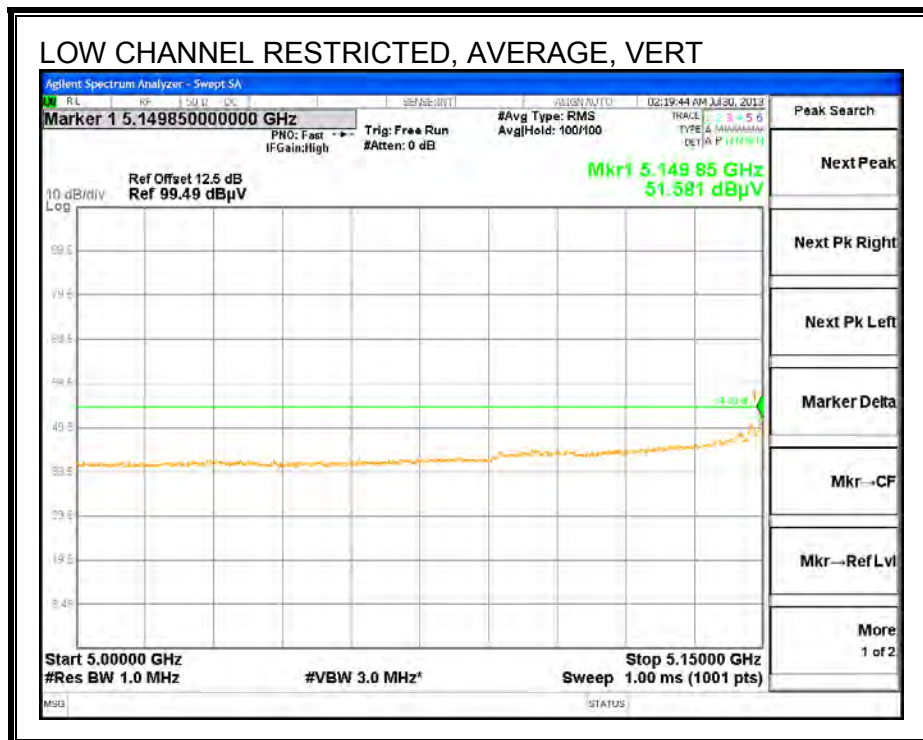
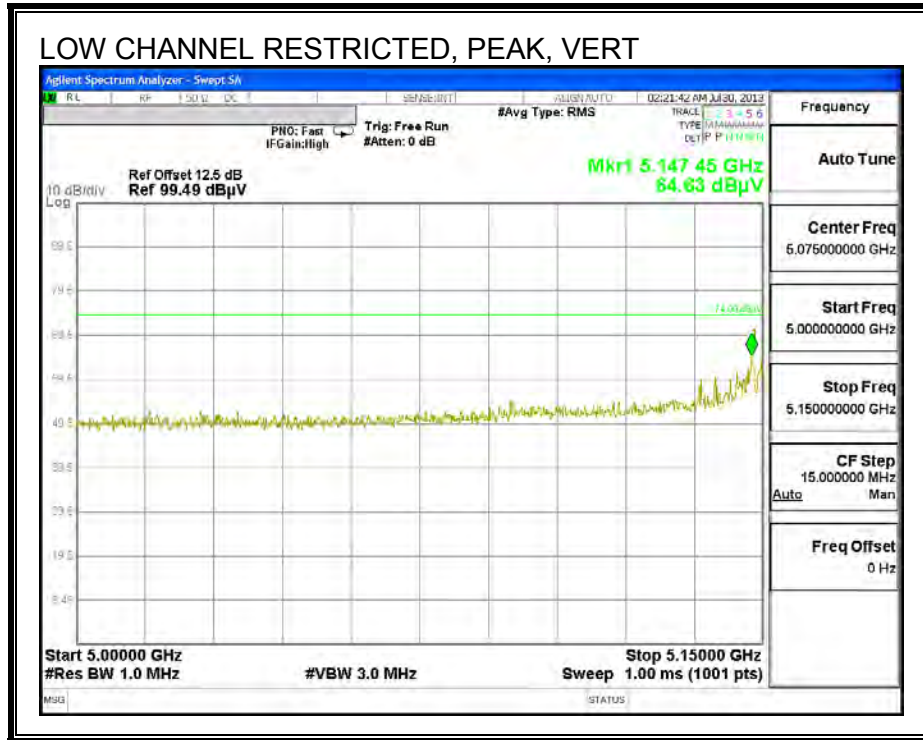



**HARMONICS AND SPURIOUS EMISSIONS**

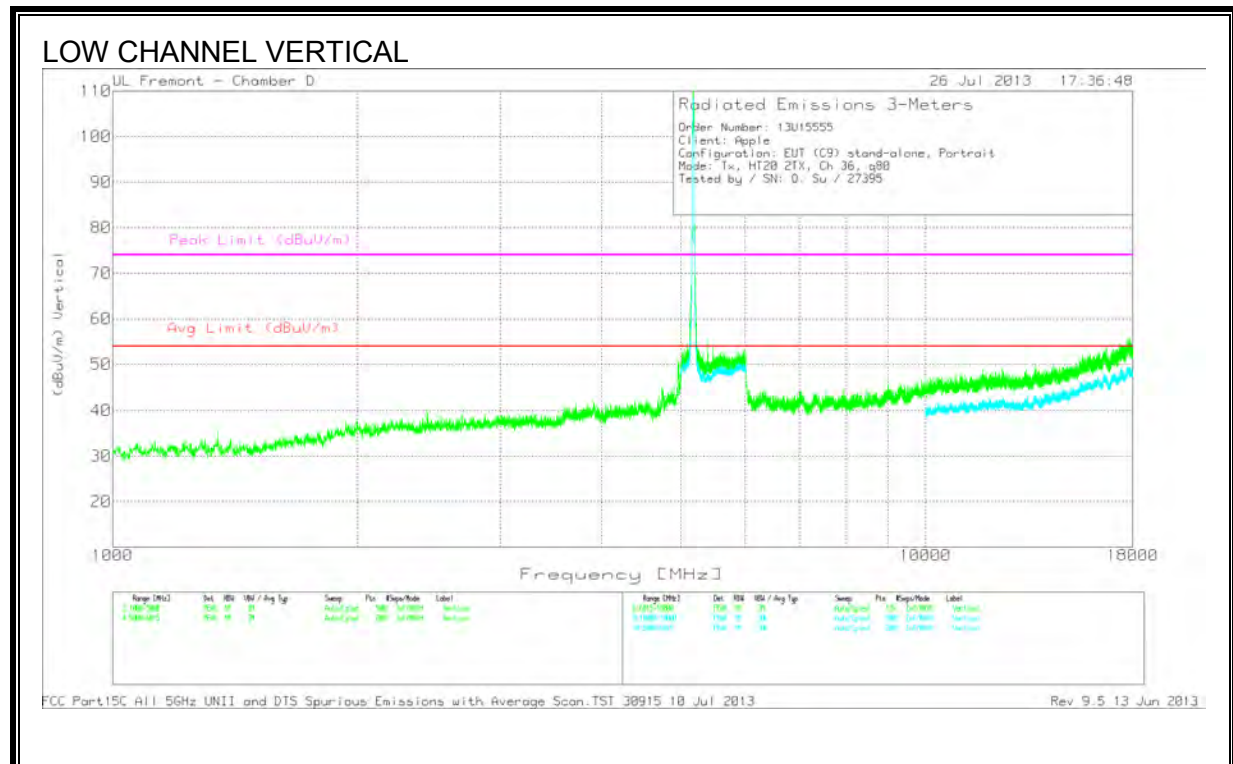
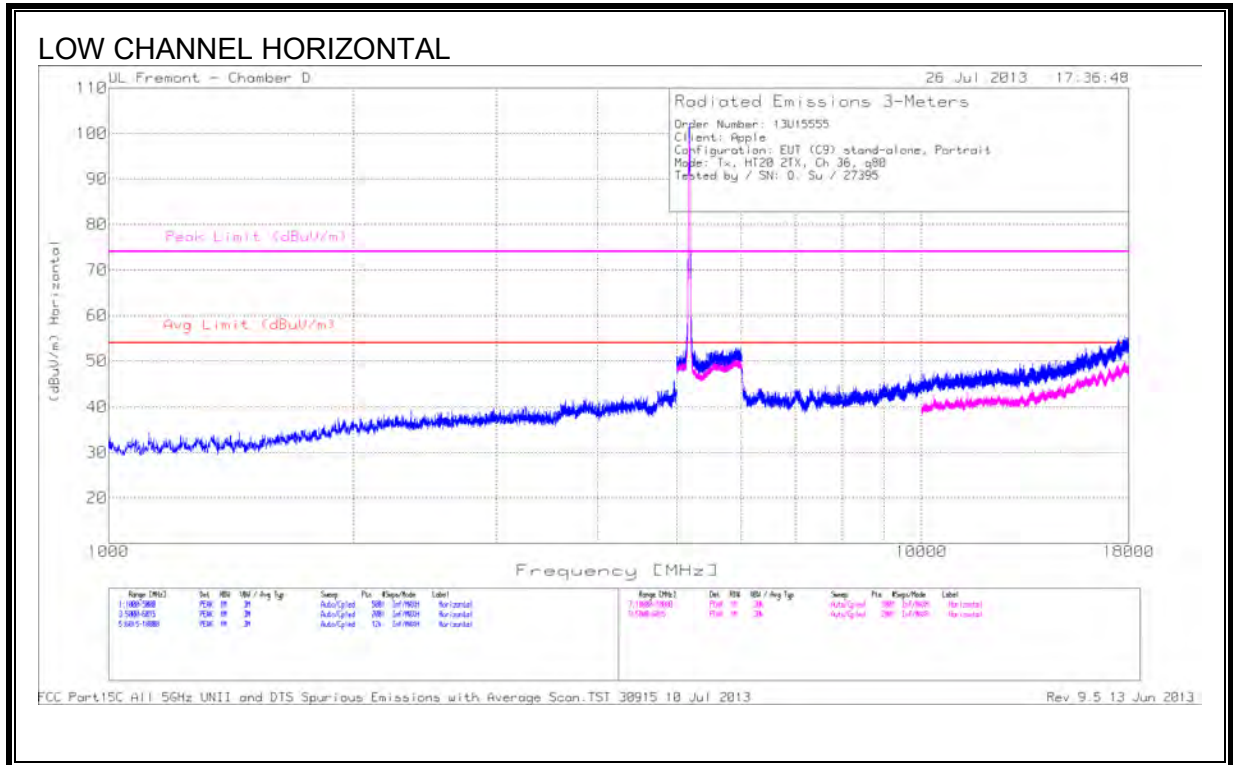

**DATA**

Frequency (GHz)	Meter Reading (dBuV)	Det	AF T344 (db/m)	Amp/Cbl/ Filtr/Pad (dB)	DC Corr [dB]	Corrected Reading (dBuV/m)	Avg Limit (dBuV/m)	Margin (dB)	Peak Limit (dBuV/m)	Margin (dB)	Height (cm)	Polarity
4.958	47.5	PK	34.3	-30.8	0	51	-	-	74	-23	201	V
5.099	41.98	PK	34.5	-21.8	0	54.68	-	-	74	-19.32	201	V
5.396	42.91	PK	34.8	-22.1	0	55.61	-	-	74	-18.39	201	V

PK - Peak detector

**Radiated Emissions**

Frequency (GHz)	Meter Reading (dBuV)	Det	AF T344 (db/m)	Amp/Cbl/ Filtr/Pad (dB)	DC Corr [dB]	Corrected Reading (dBuV/m)	Avg Limit (dBuV/m)	Margin (dB)	Peak Limit (dBuV/m)	Margin (dB)	Azimuth (Degs)	Height (cm)	Polarity
4.961	26.33	Av	34.3	-30.8	0	29.83	53.97	-24.14	74	-44.17	293	279	V
5.099	22.92	Av	34.5	-21.8	0	35.62	53.97	-18.35	74	-38.38	300	333	V
5.396	20.14	Av	34.8	-22.1	0	32.84	53.97	-21.13	74	-41.16	296	361	V

Av - average detection

**HARMONICS AND SPURIOUS EMISSIONS**

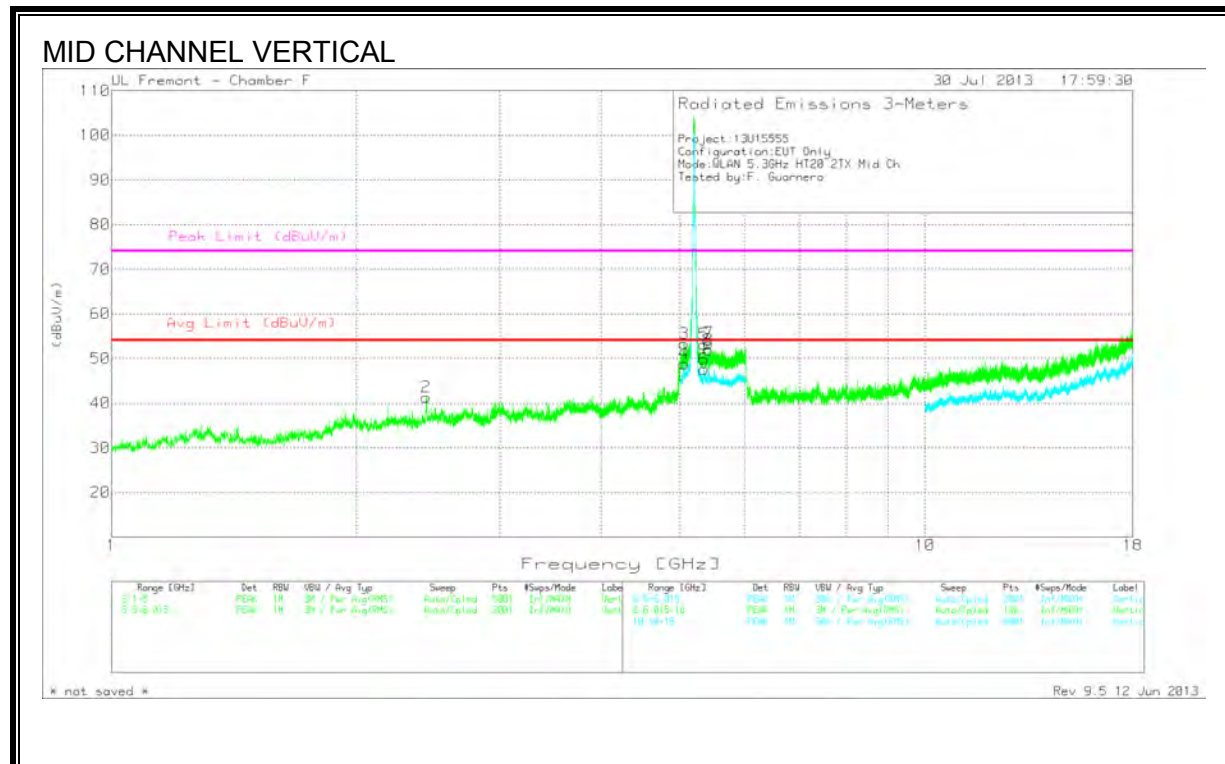
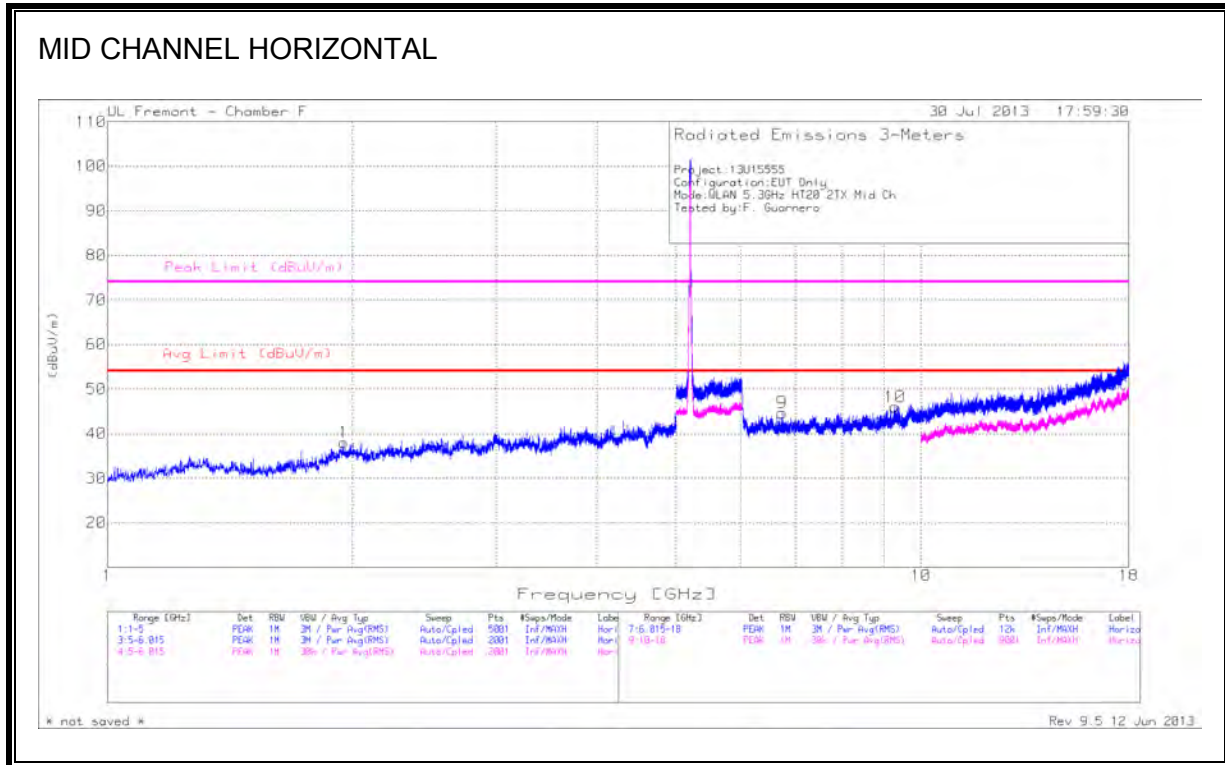

**DATA**

Marker	Frequency (GHz)	Meter Reading (dBuV)	Det	AF T120 (dB/m)	Amp/Cbl/ Filtr/Pad (dB)	Corrected Reading (dBuV/m)	Avg Limit (dBuV/m)	Margin (dB)	Peak Limit (dBuV/m)	Margin (dB)	Azimuth (Degs)	Height (cm)	Polarity
1	1.951	40.26	PK	31.4	-33.6	38.06	53.97	-15.91	74	-35.94	0-360	199	H
2	2.436	42.47	PK	32.3	-33.4	41.37	53.97	-12.6	74	-32.63	0-360	101	V
3	5.057	41.33	PK	34.1	-22.1	--	--	--	74	-20.67	0-360	201	V
4	5.057	36.82	PK (VB)	34.1	-22.1	48.82	53.97	-5.15	--	--	0-360	199	V
5	5.352	40.92	PK	34.5	-22.2	--	--	--	74	-20.78	0-360	101	V
6	5.349	35.35	PK (VB)	34.5	-22.2	47.65	53.97	-6.32	--	--	0-360	100	V
7	5.419	40.82	PK	34.6	-22	--	--	--	74	-20.58	0-360	201	V
8	5.416	39.33	PK (VB)	34.6	-22	51.93	53.97	-2.04	--	--	0-360	199	V
9	6.748	38.78	PK	35.8	-29.9	44.68	53.97	-9.29	74	-29.32	0-360	100	H
10	9.287	35.52	PK	36.7	-26.2	46.02	53.97	-7.95	74	-27.98	0-360	100	H

Notes: PK: Peak detector

**Radiated Emissions**

Frequency (GHz)	Meter Reading (dBuV)	Det	AF T120 (dB/m)	Amp/Cbl/ Filtr/Pad (dB)	Corrected Reading (dBuV/m)	Avg Limit (dBuV/m)	Margin (dB)	Peak Limit (dBuV/m)	Margin (dB)	Azimuth (Degs)	Height (cm)	Polarity
5.417	34.61	Av	34.6	-22	47.21	53.97	-6.76	74	-26.79	10	218	V

Av - Average detection

**HARMONICS AND SPURIOUS EMISSIONS**

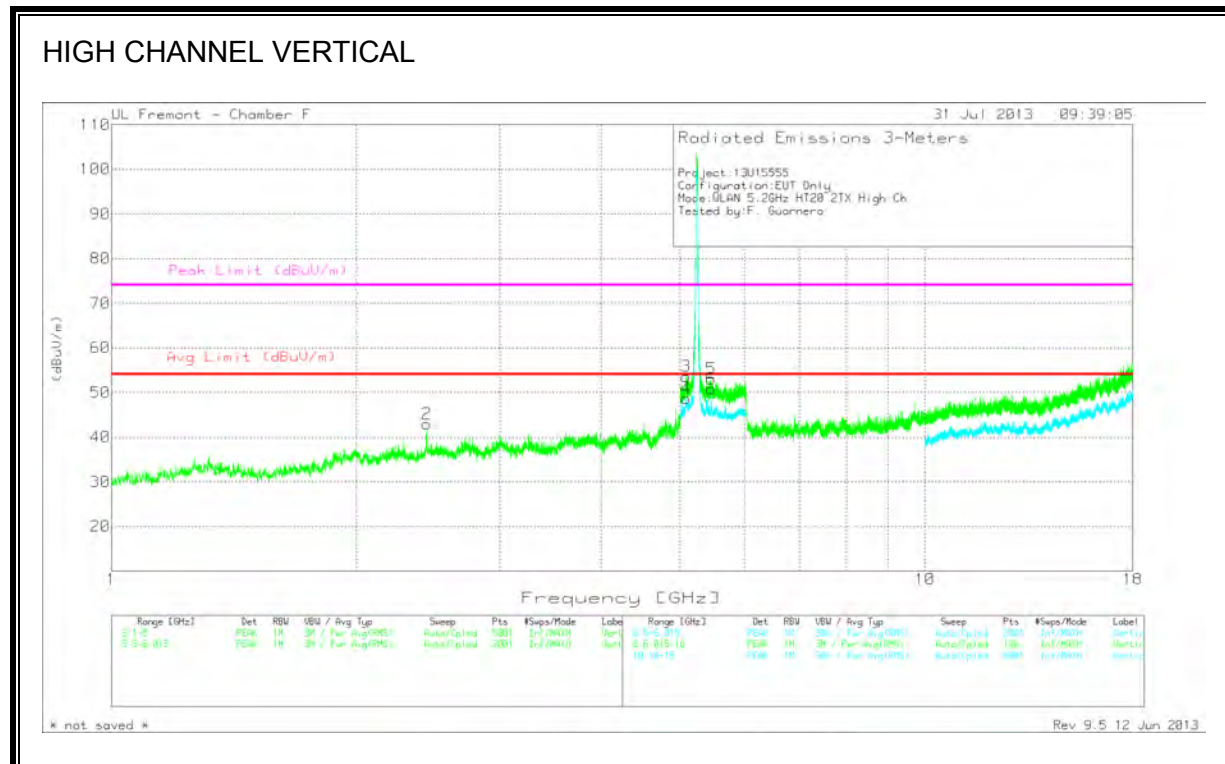
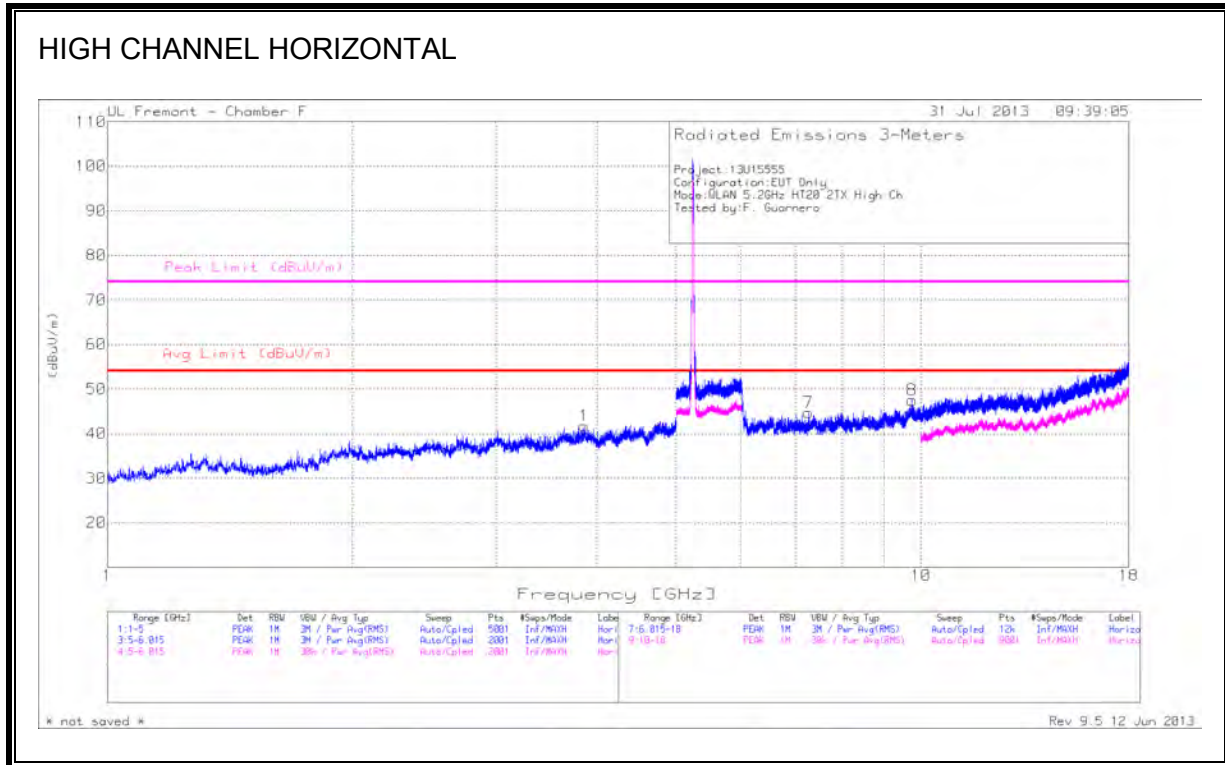

**DATA**

Marker	Frequency (GHz)	Meter Reading (dBuV)	Det	AF T120 (dB/m)	Amp/Cbl/ Fitr/Pad (dB)	Corrected Reading (dBuV/m)	Avg Limit (dBuV/m)	Margin (dB)	Peak Limit (dBuV/m)	Margin (dB)	Azimuth (Degs)	Height (cm)	Polarity
1	3.853	40.08	PK	33.5	-31.8	41.78	53.97	-12.19	74	-32.22	0-360	98	H
2	2.441	44.08	PK	32.3	-33.4	42.98	53.97	-10.99	74	-31.02	0-360	101	V
3	5.086	41.3	PK	34.1	-21.8	--	--	--	74	-20.4	0-360	199	V
4	5.087	36.35	PK (VB)	34.1	-21.8	48.65	53.97	-5.32	--	--	0-360	199	V
5	5.456	40.14	PK	34.7	-21.8	--	--	--	74	-20.96	0-360	199	V
6	5.458	37.94	PK (VB)	34.7	-21.8	50.84	53.97	-3.13	--	--	0-360	199	V
7	7.267	38.12	PK	35.7	-29.1	44.72	53.97	-9.25	74	-29.28	0-360	199	H
8	9.748	35.83	PK	37.4	-25.7	47.53	53.97	-6.44	74	-26.47	0-360	100	H

Notes: PK: Peak detector

Frequency (GHz)	Meter Reading (dBuV)	Det	AF T120 (dB/m)	Amp/Cbl/ Fitr/Pad (dB)	Corrected Reading (dBuV/m)	Avg Limit (dBuV/m)	Margin (dB)	Peak Limit (dBuV/m)	Margin (dB)	Azimuth (Degs)	Height (cm)	Polarity
5.458	33.86	RMS	34.7	-21.8	46.76	53.97	-7.21	74	-27.24	4	363	V

RMS - RMS detection

---

### **9.2.3. 802.11n HT20 2TX STBC MODE IN THE 5.2 GHz BAND**

Covered by testing 11n HT20 CDD 2TX, total power across the two chains is higher than the power level the device will operate at.

### 9.2.4. 802.11n HT40 SISO MODE IN THE 5.2 GHz BAND

#### RESTRICTED BANDEDGE (LOW CHANNEL)

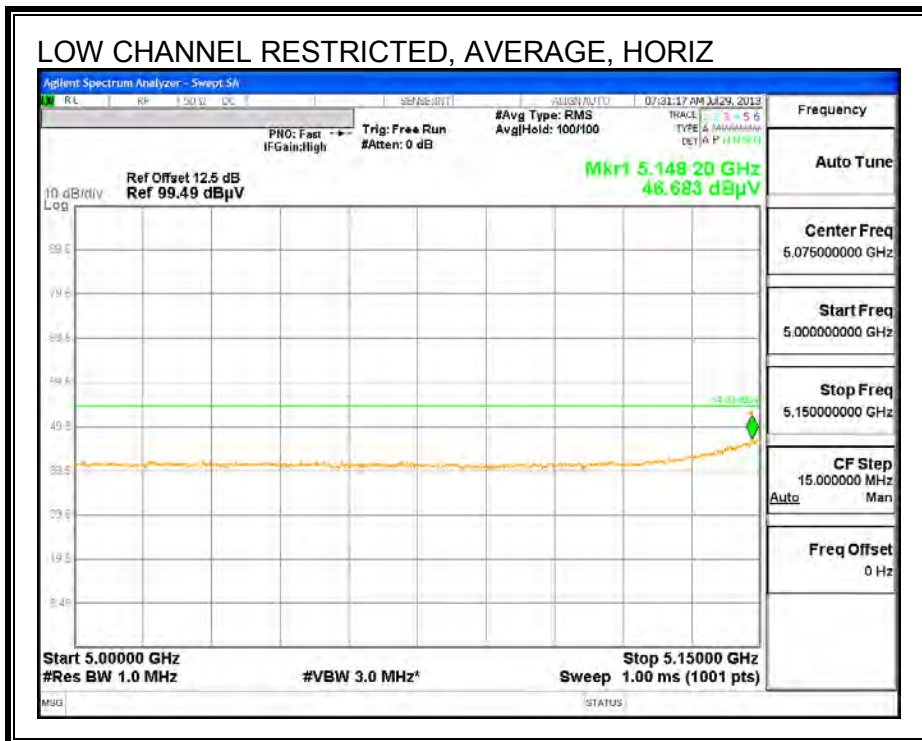
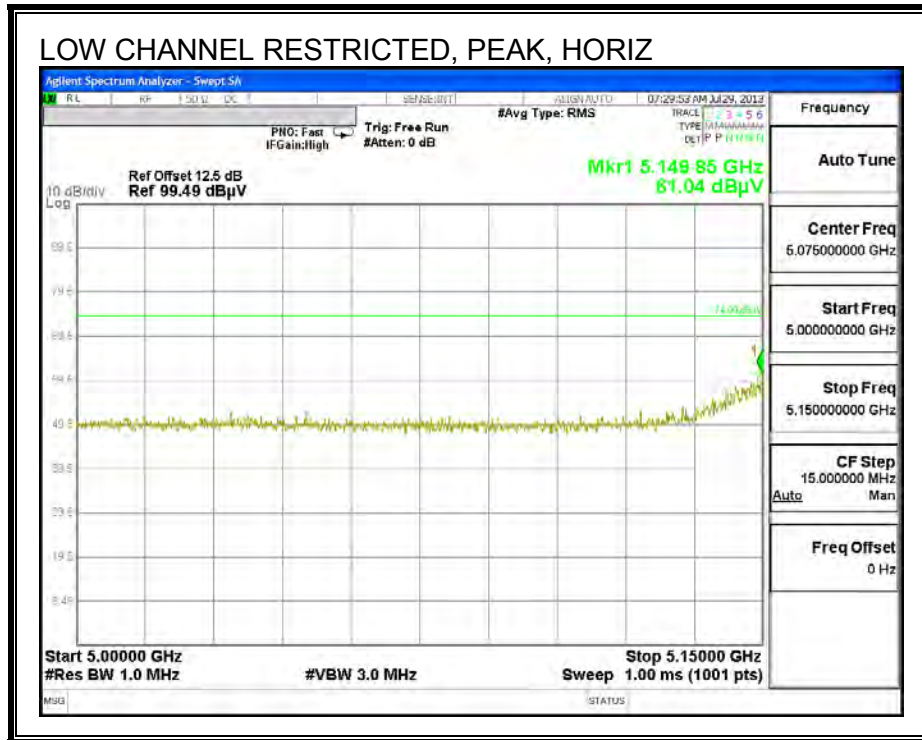



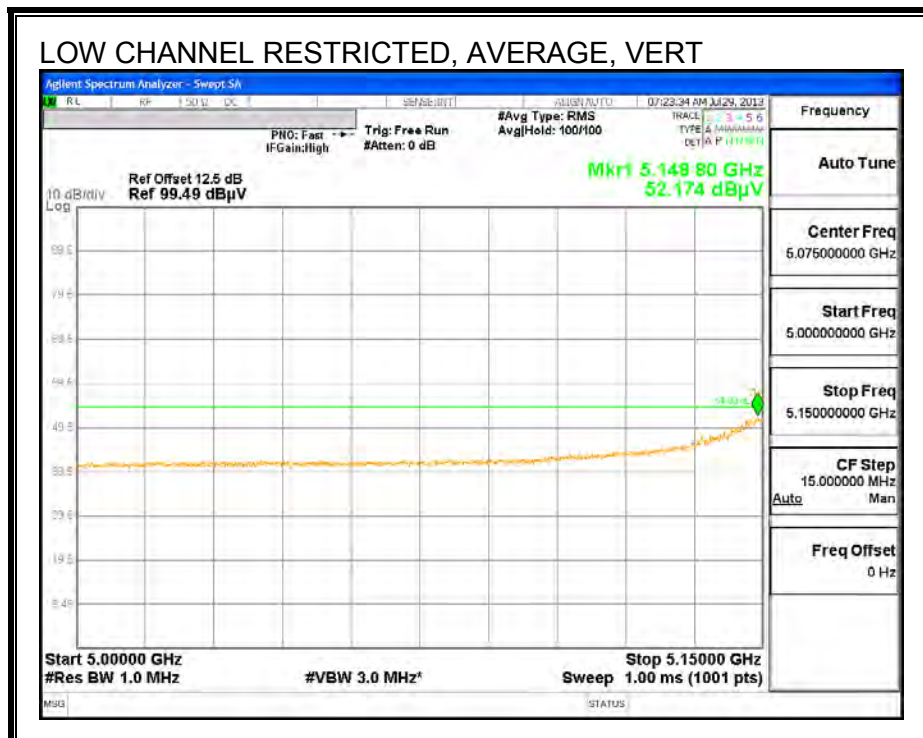
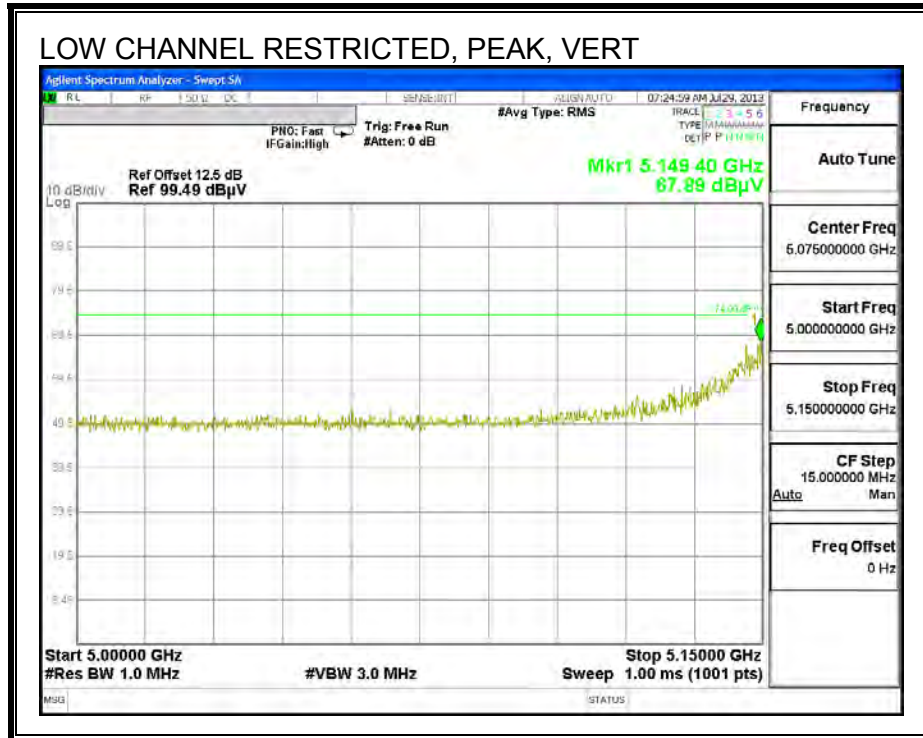

**HARMONICS AND SPURIOUS EMISSIONS**

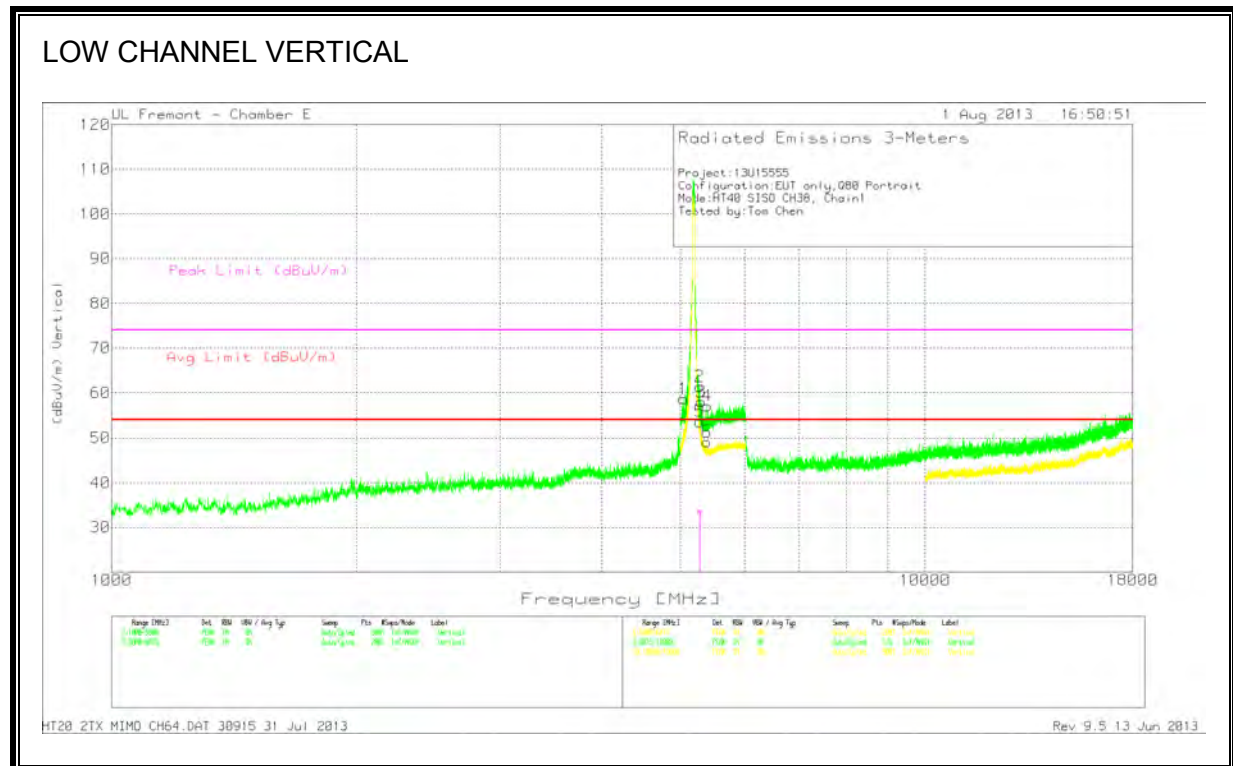
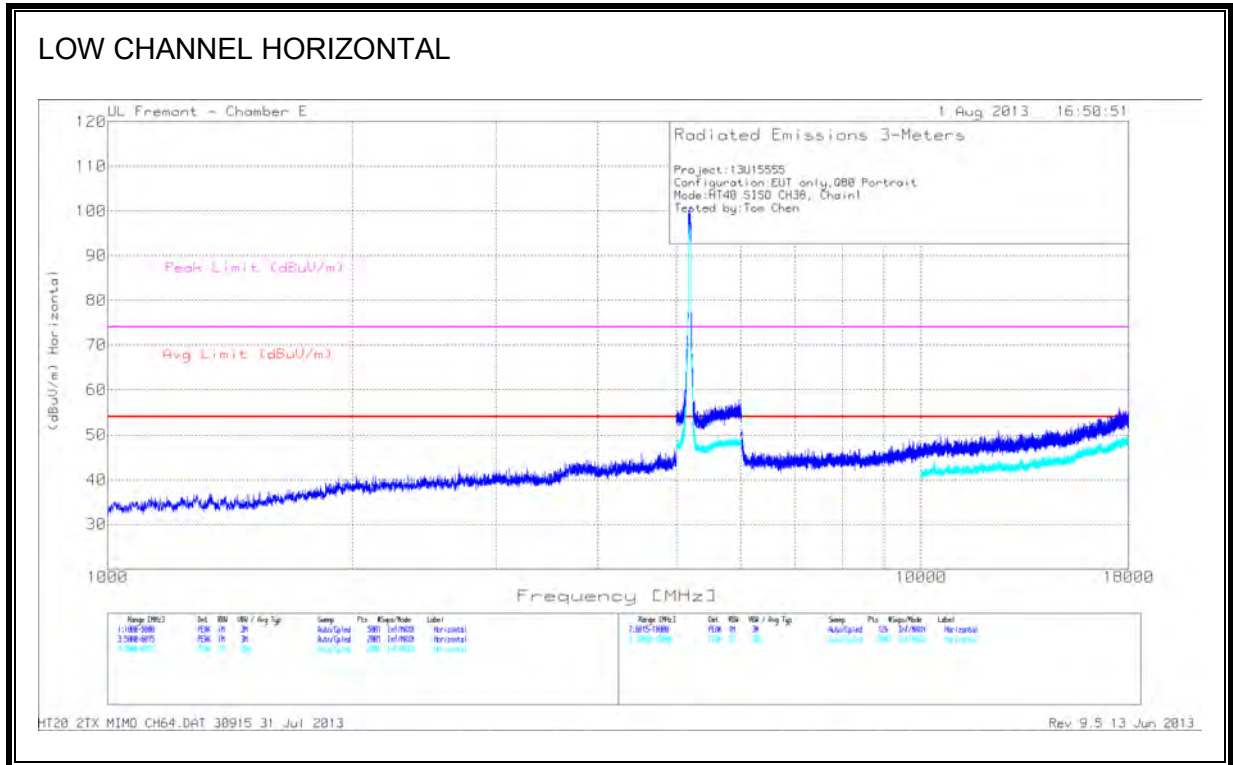

**DATA**

Marker	Frequency (GHz)	Meter Reading (dBuV)	Det	AF T346 (dB/m)	Amp/Cbl /10dB Pad (dB)	DC Corr [dB]	Corrected Reading (dBuV/m)	Avg Limit (dBuV/m)	Margin (dB)	Peak Limit (dBuV/m)	Margin (dB)	Height (cm)	Polarity
1	5.047	46.39	PK	34.5	-22.2	0	58.69	--	--	74	-15.31	100	V
	5.047	35.30	Av	34.5	-22.2	0	47.60	54	-6.40	--	--	100	V
*2	5.281	48.59	PK	34.7	-21.9	0	61.39	-	-	68.2	-6.8	200	V
*3	5.307	45.22	PK	34.7	-21.9	0	58.02	-	-	68.2	-10.2	100	V
4	5.396	44.39	PK	34.8	-22.1	0	57.09	-	-	74	-16.91	100	V
*5	5.285	40.78	PK (VB)	34.7	-21.9	0	53.58	--	--	--	--	100	V
6	5.394	36.42	PK (VB)	34.8	-22.1	0	49.12	54	-4.88	--	--	199	V

Notes: \* : Not in Restricted Band

PK: Peak detector

**HARMONICS AND SPURIOUS EMISSIONS**

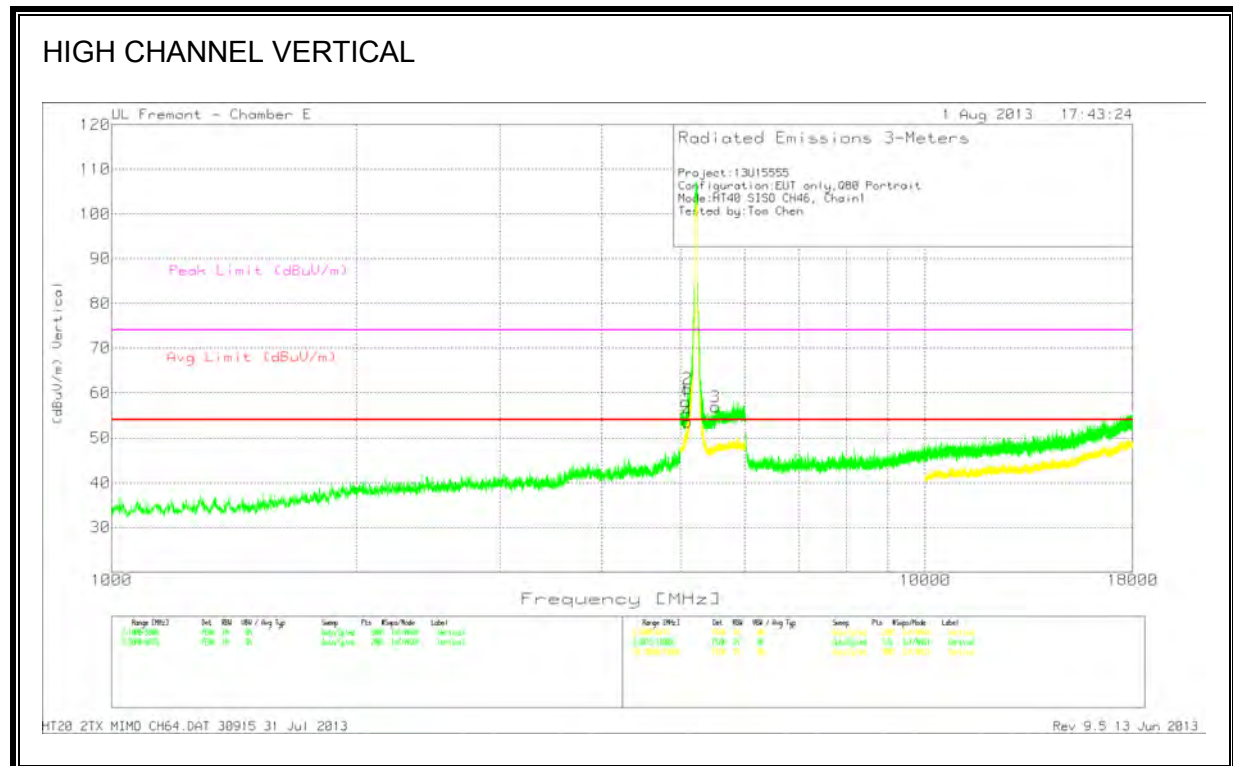
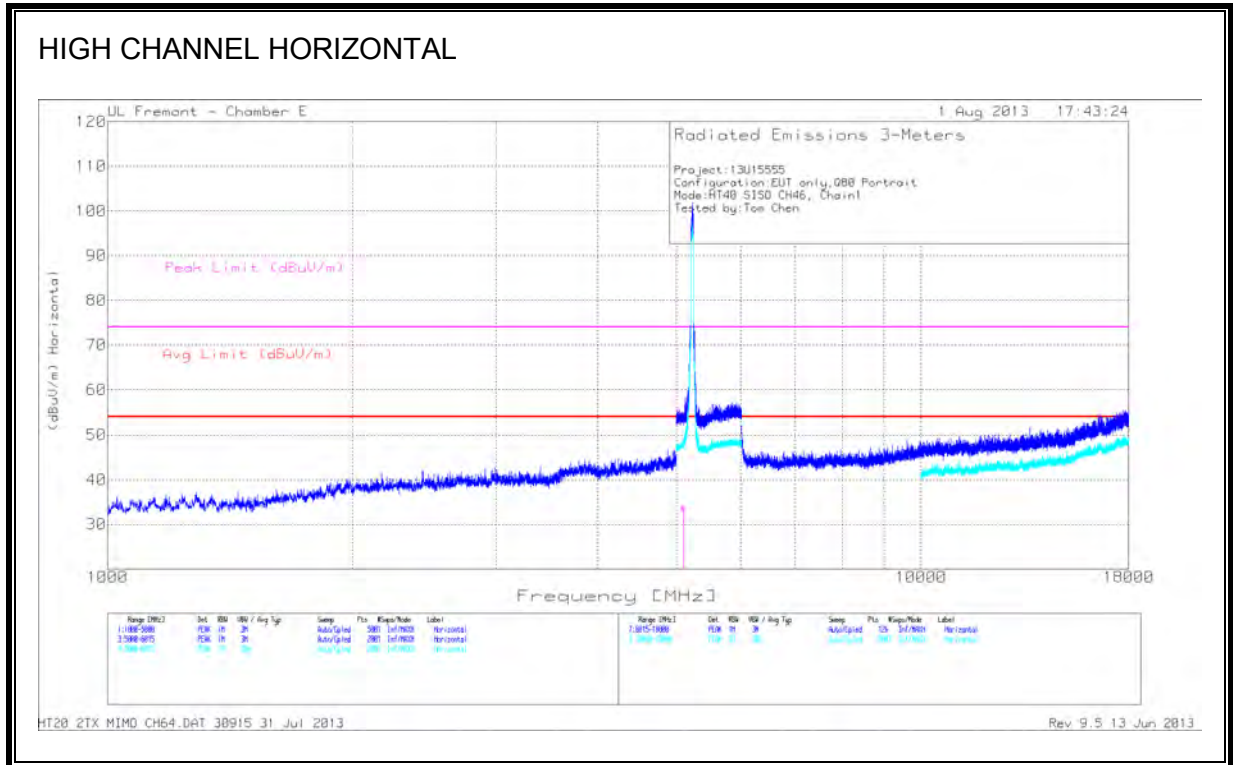

**DATA**

Marker	Frequency (GHz)	Meter Reading (dBuV)	Det	AF T346 (dB/m)	Amp/Cbl /10dB Pad (dB)	DC Corr [dB]	Corrected Reading (dBuV/m)	Avg Limit (dBuV/m)	Margin (dB)	Peak Limit (dBuV/m)	Margin (dB)	Height (cm)	Polarity
1	5.081	45.43	PK	34.5	-21.9	0	58.03	--	--	74	-15.97	199	V
	5.081	34.33	Av	34.5	-21.9	0	46.87	54	-7.13	--	--	199	V
2	5.104	48.17	PK	34.5	-21.8	0	60.87	--	--	74	-13.13	100	V
*3	5.528	43.33	PK	34.9	-21.4	0	56.83	-	-	68.2	-11.37	199	V
4	5.104	40.82	PK (VB)	34.5	-21.8	0	53.52	54	-0.48	--	--	200	V

Notes: \* : Not in Restricted Band

PK: Peak detector

**Radiated Emissions**

Frequency (GHz)	Meter Reading (dBuV)	Det	AF T346 (dB/m)	Amp/Cbl /10dB Pad (dB)	DC Corr [dB]	Corrected Reading (dBuV/m)	Avg Limit (dBuV/m)	Margin (dB)	Peak Limit (dBuV/m)	Margin (dB)	Azimuth (Degs)	Height (cm)	Polarity
5.104	20.72	Av	34.5	-21.8	.1	33.52	53.97	-20.45	--	--	195	303	V

Av - average detection

### 9.2.5. 802.11n HT40 2TX CDD MODE IN THE 5.2 GHz BAND

#### RESTRICTED BANDEDGE (LOW CHANNEL)

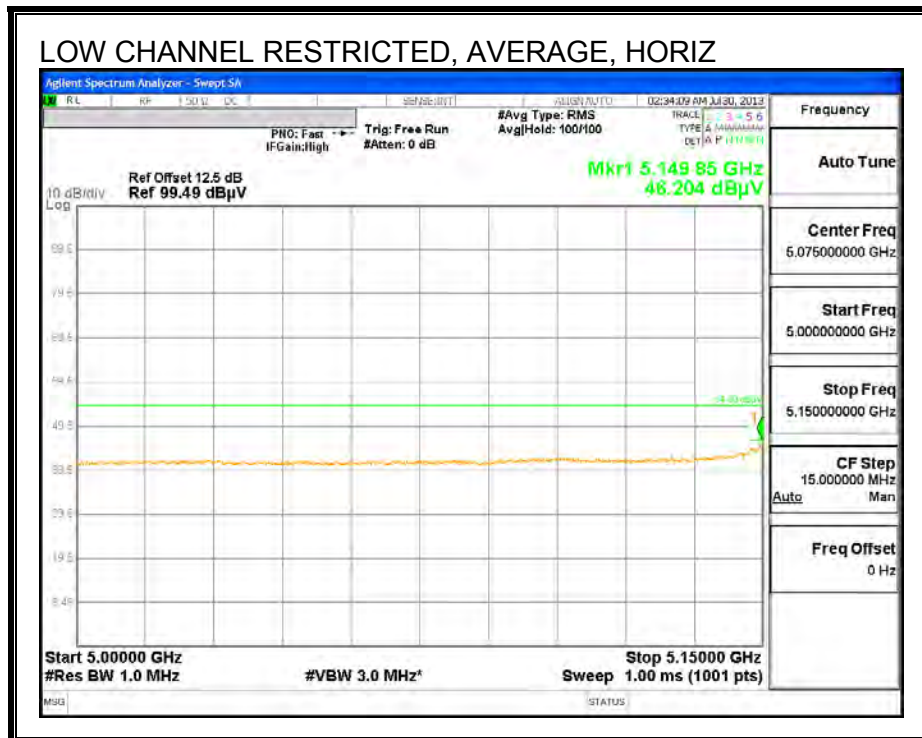
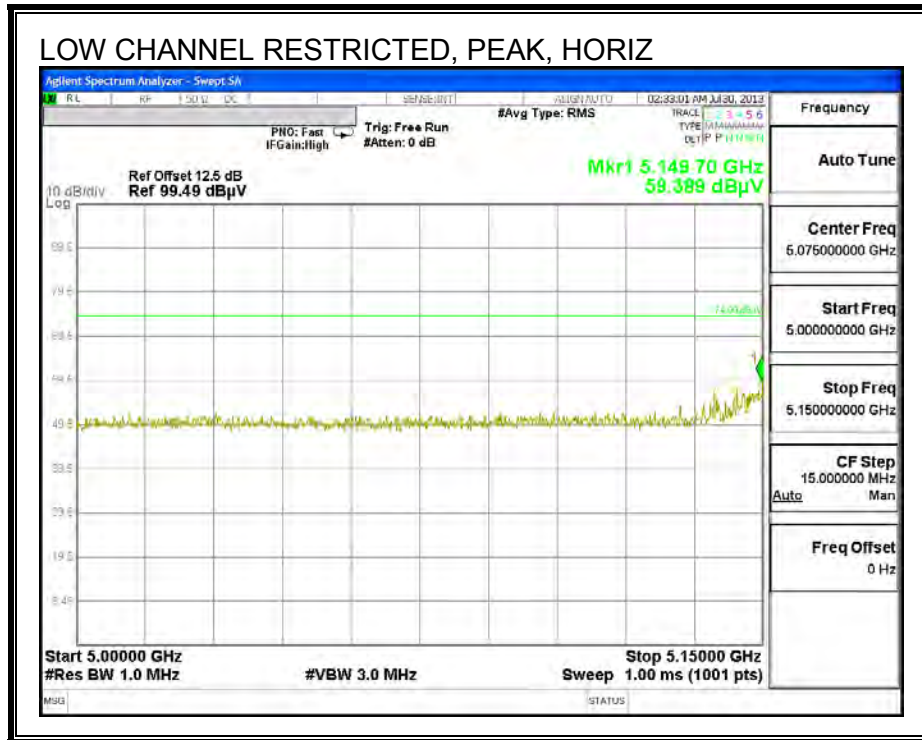

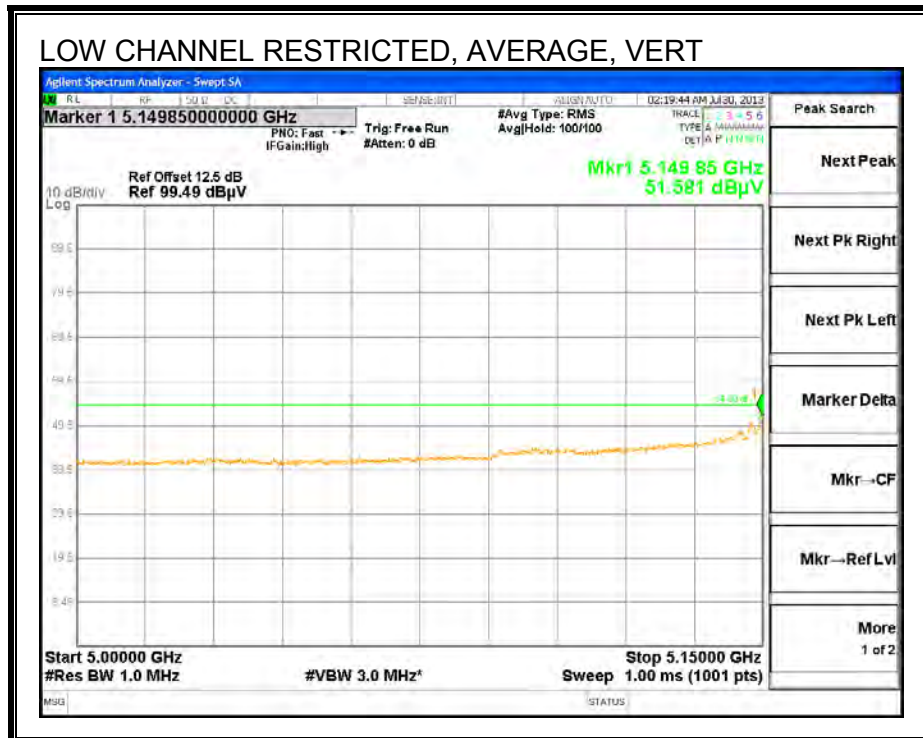
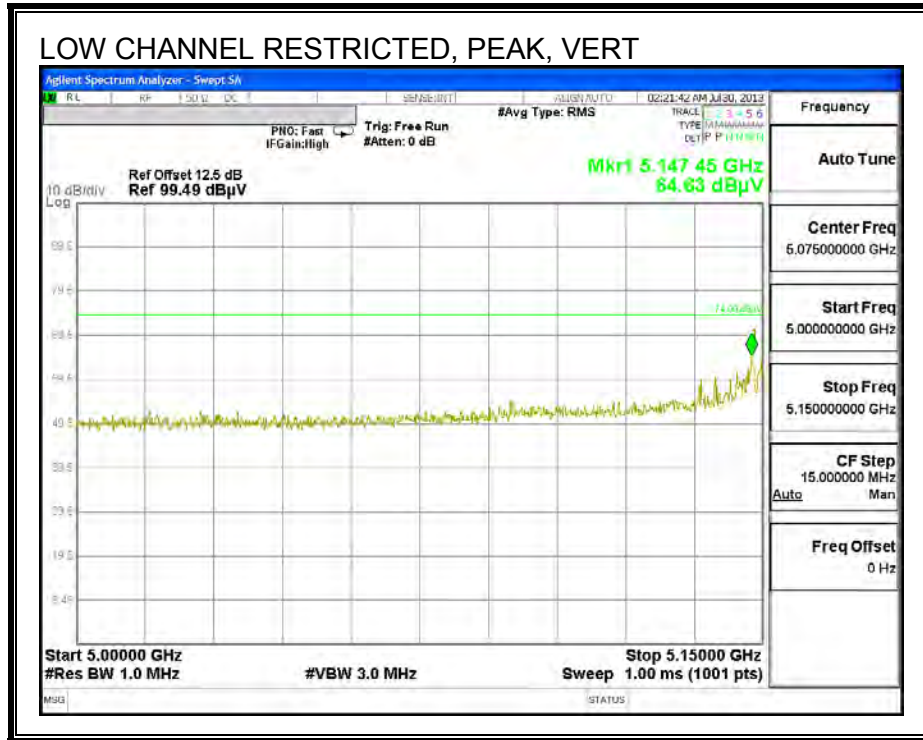

**HARMONICS AND SPURIOUS EMISSIONS**

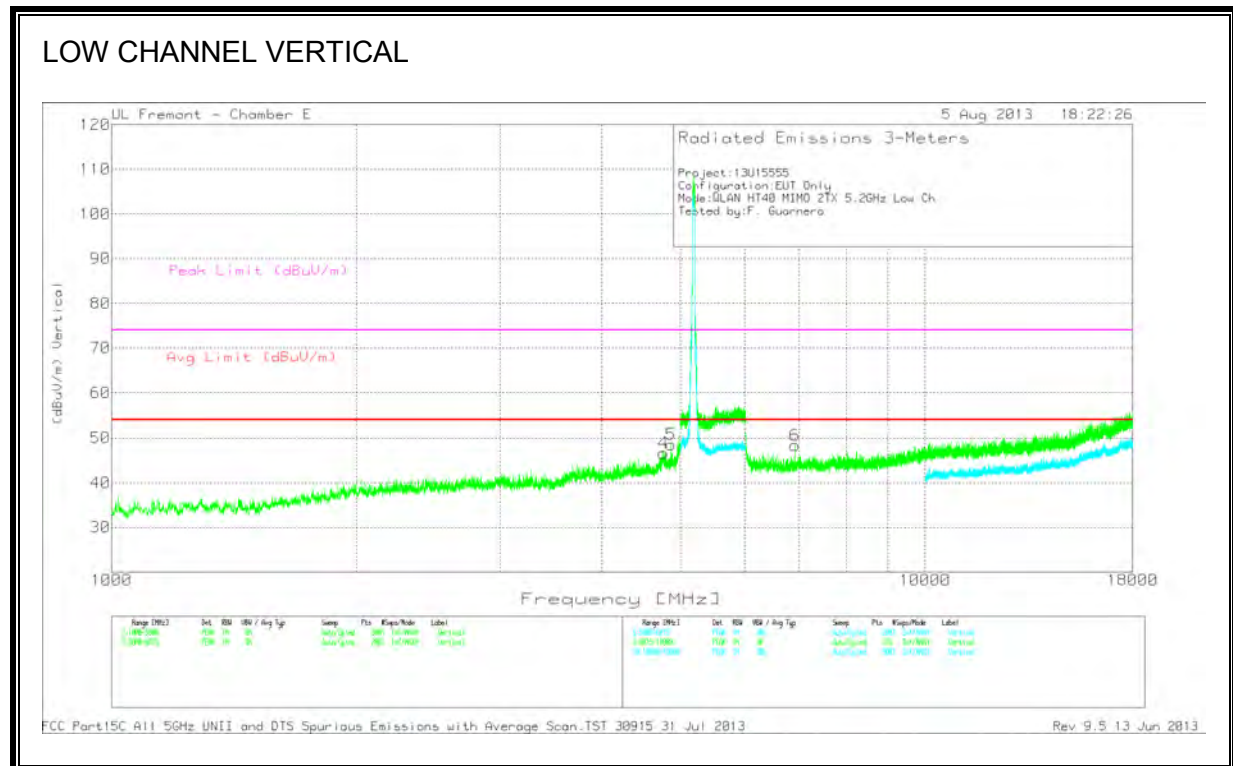
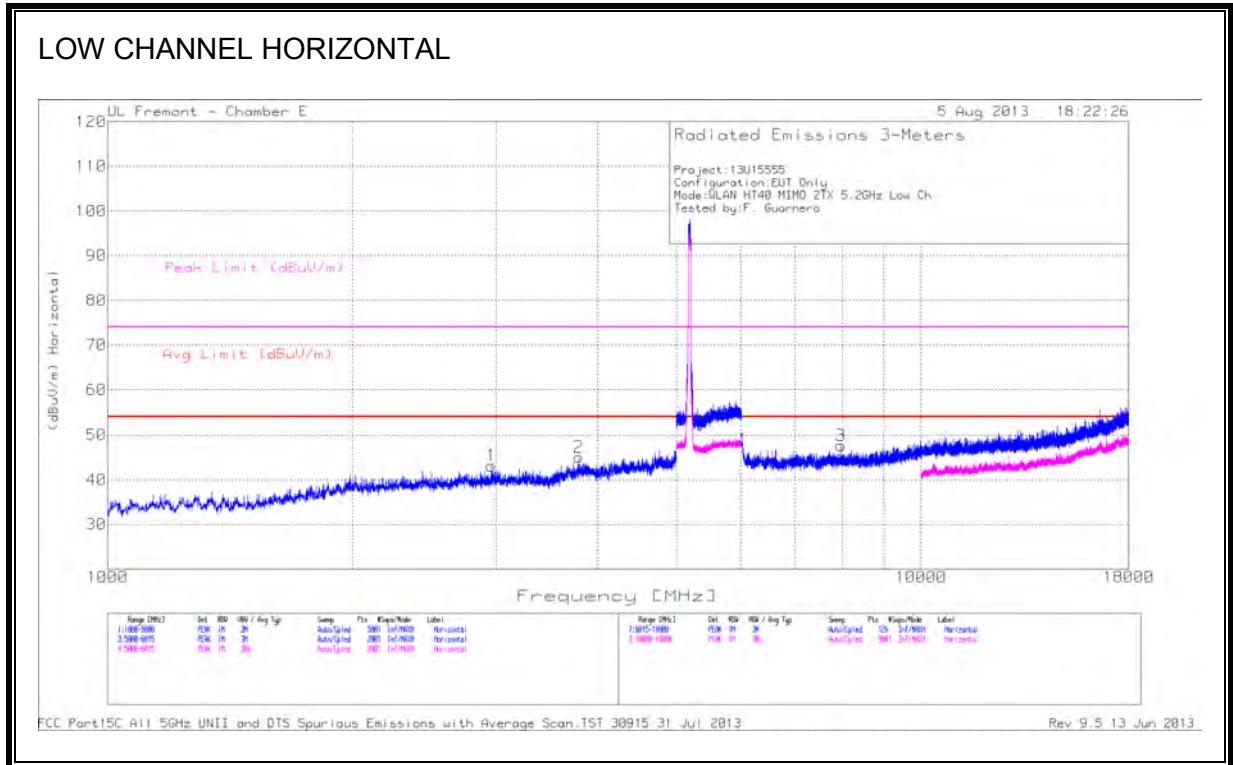



**DATA**

Marker	Frequency (GHz)	Meter Reading (dBuV)	Det	AF T346 (dB/m)	Amp/Cbl 5GHz LPF dB	DC Corr [dB]	Corrected Reading (dBuV/m)	Avg Limit (dBuV/m)	Margin (dB)	Peak Limit (dBuV/m)	Margin (dB)	Height (cm)	Polarity
1	2.964	42.63	PK	33.2	-32.7	0	43.13	53.97	-10.84	74	-30.87	100	H
2	3.796	43.86	PK	33.7	-32.5	0	45.06	53.97	-8.91	74	-28.94	199	H
3	7.966	39.67	PK	36.2	-28.2	0	47.67	53.97	-6.3	74	-26.33	199	H

PK - Peak detector

Marker	Frequency (GHz)	Meter Reading (dBuV)	Det	AF T346 (dB/m)	Amp/Cbl /6GHz HPF (dB)	DC Corr [dB]	Corrected Reading (dBuV/m)	Avg Limit (dBuV/m)	Margin (dB)	Peak Limit (dBuV/m)	Margin (dB)	Height (cm)	Polarity
4	4.769	42.94	PK	34.4	-30.7	0	46.64	53.97	-7.33	74	-27.36	100	V
5	4.872	45.04	PK	34.4	-30.9	0	48.54	53.97	-5.43	74	-25.46	100	V
*6	6.921	42	PK	35.9	-29.5	0	48.4	--	--	68.2	-19.8	100	V

Notes: \*: Not in Restricted Band

PK - Peak detector

**HARMONICS AND SPURIOUS EMISSIONS**

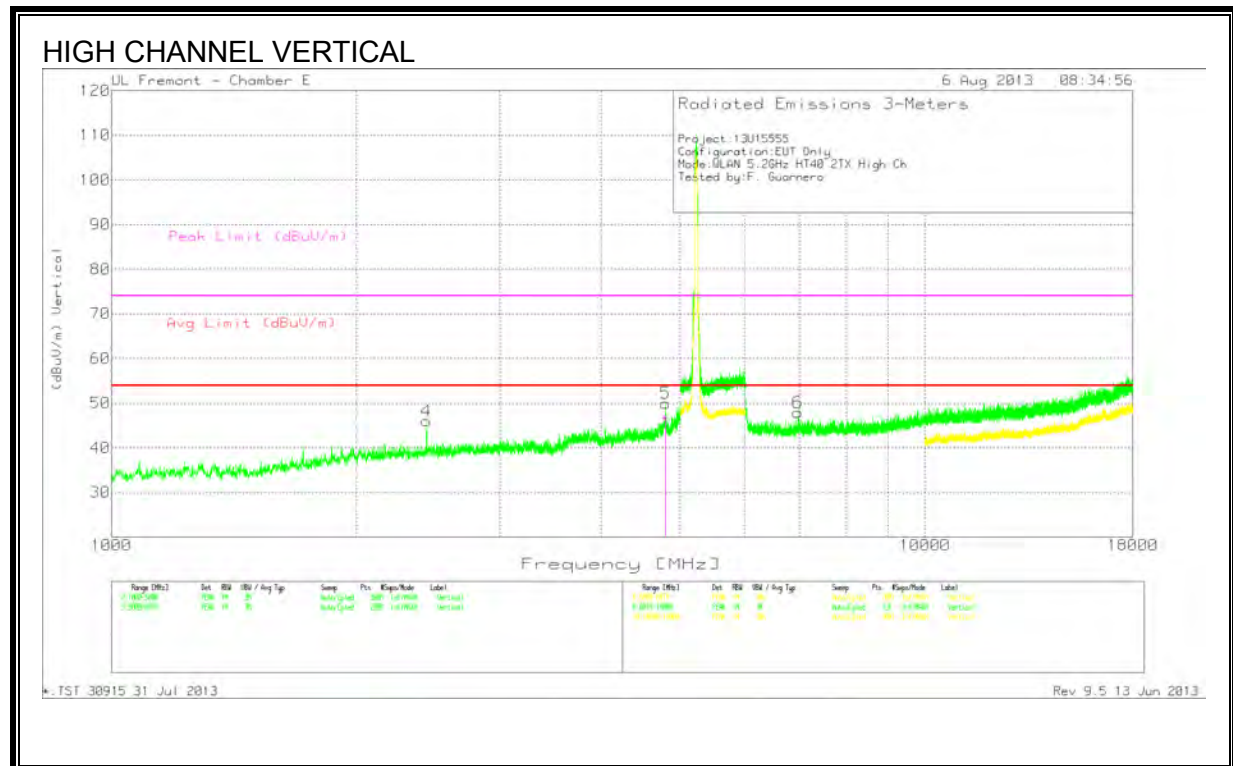
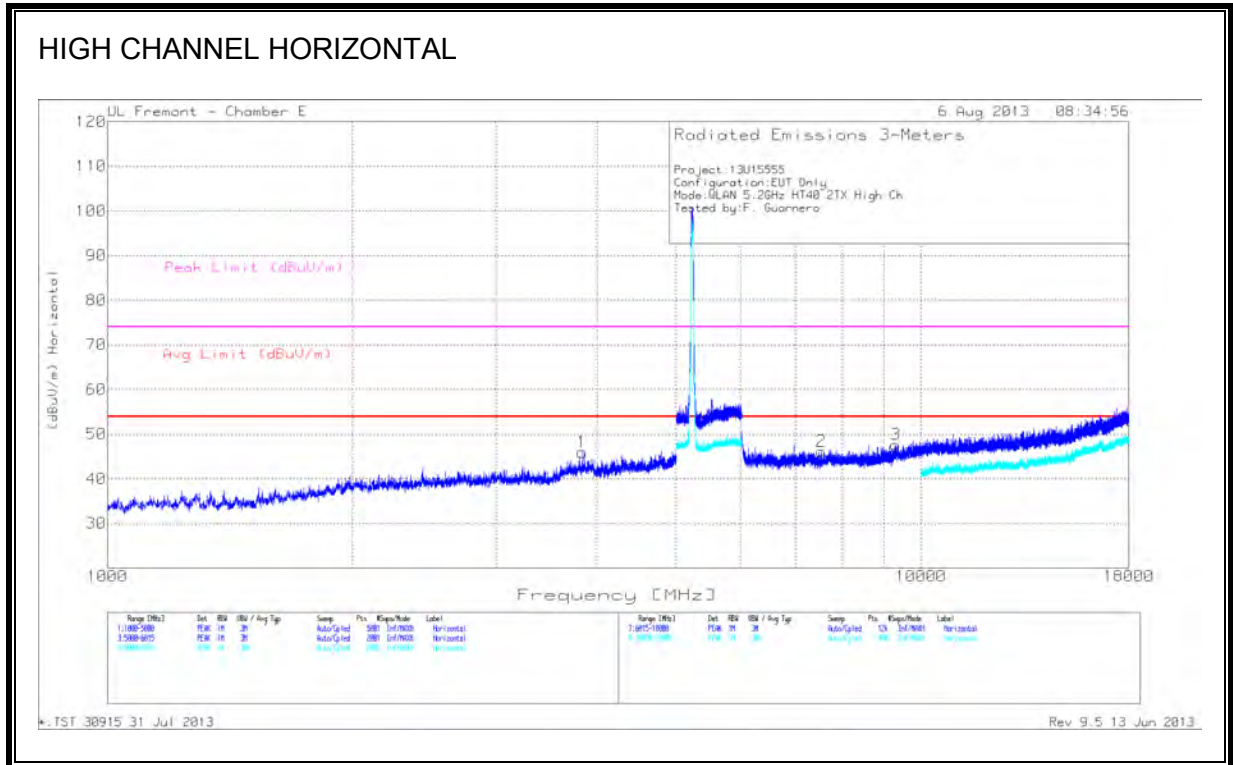

**DATA**

Marker	Frequency (GHz)	Meter Reading (dBuV)	Det	AF T346 (dB/m)	Amp/Cbl 5GHz LPF dB	DC Corr [dB]	Corrected Reading (dBuV/m)	Avg Limit (dBuV/m)	Margin (dB)	Peak Limit (dBuV/m)	Margin (dB)	Height (cm)	Polarity
1	3.833	44.28	PK	33.7	-32	0	45.98	53.97	-7.99	74	-28.02	199	H
2	7.542	39.05	PK	36.1	-29	0	46.15	53.97	-7.82	74	-27.85	100	H
3	9.31	36.6	PK	37.2	-26.1	0	47.7	53.97	-6.27	74	-26.3	199	H

PK - Peak detector

Marker	Frequency (GHz)	Meter Reading (dBuV)	Det	AF T346 (dB/m)	Amp/Cbl /6GHz HPF (dB)	DC Corr [dB]	Corrected Reading (dBuV/m)	Avg Limit (dBuV/m)	Margin (dB)	Peak Limit (dBuV/m)	Margin (dB)	Height (cm)	Polarity
4	2.438	46.81	PK	32.6	-33.4	0	46.01	53.97	-7.96	74	-27.99	199	V
5	4.795	46.39	PK	34.4	-30.8	0	49.99	53.97	-3.98	74	-24.01	100	V
6	6.974	41.05	PK	36	-29.1	0	47.95	53.97	-6.02	74	-26.05	100	V

PK - Peak detector

**Radiated Emissions**

Frequency (GHz)	Meter Reading (dBuV)	Det	AF T346 (dB/m)	Amp/Cbl 5GHz LPF dB	DC Corr [dB]	Corrected Reading (dBuV/m)	Avg Limit (dBuV/m)	Margin (dB)	Peak Limit (dBuV/m)	Margin (dB)	Azimuth (Degs)	Height (cm)	Polarity
4.794	42.96	RMS	34.4	-30.8	.1	46.66	53.97	-7.31	74	-27.34	210	218	V

RMS - RMS detection

---

### **9.2.6. 802.11n HT40 2TX STBC MODE IN THE 5.2 GHz BAND**

Covered by testing 11n HT40 CDD 2TX, total power across the two chains is higher than the power level the device will operate at.

### 9.2.7. 802.11a SISO MODE IN THE 5.3 GHz BAND

#### RESTRICTED BANDEDGE (HIGH CHANNEL)

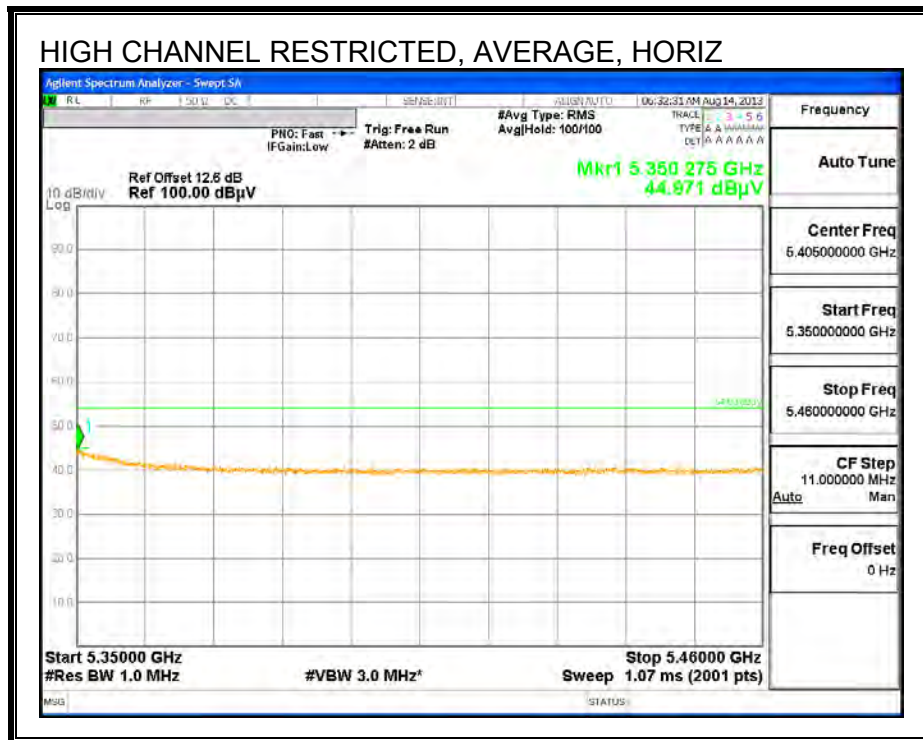
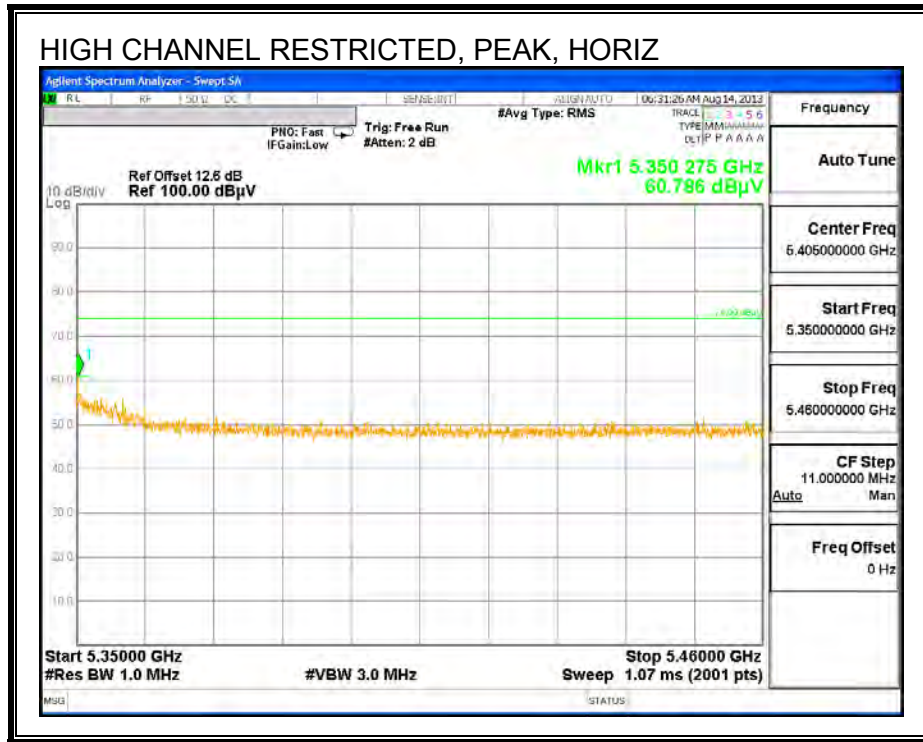

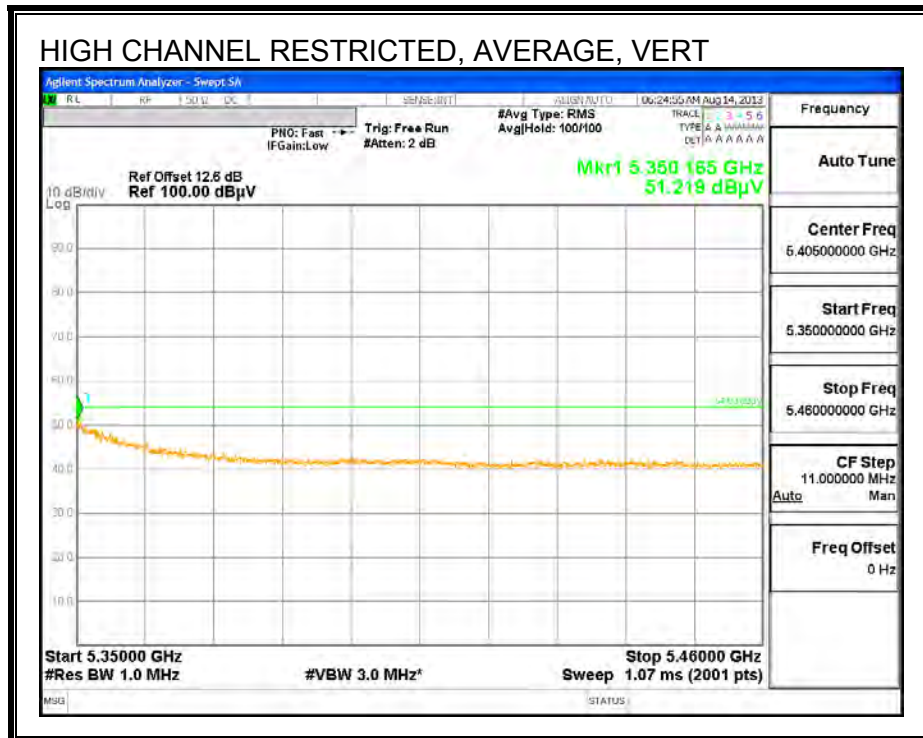
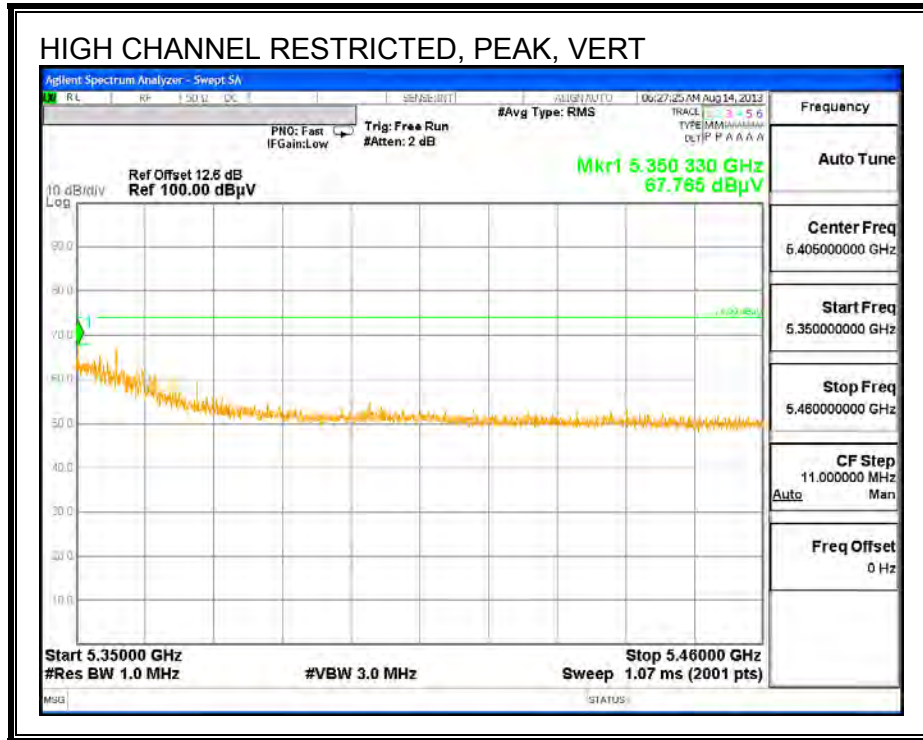

**HARMONICS AND SPURIOUS EMISSIONS**

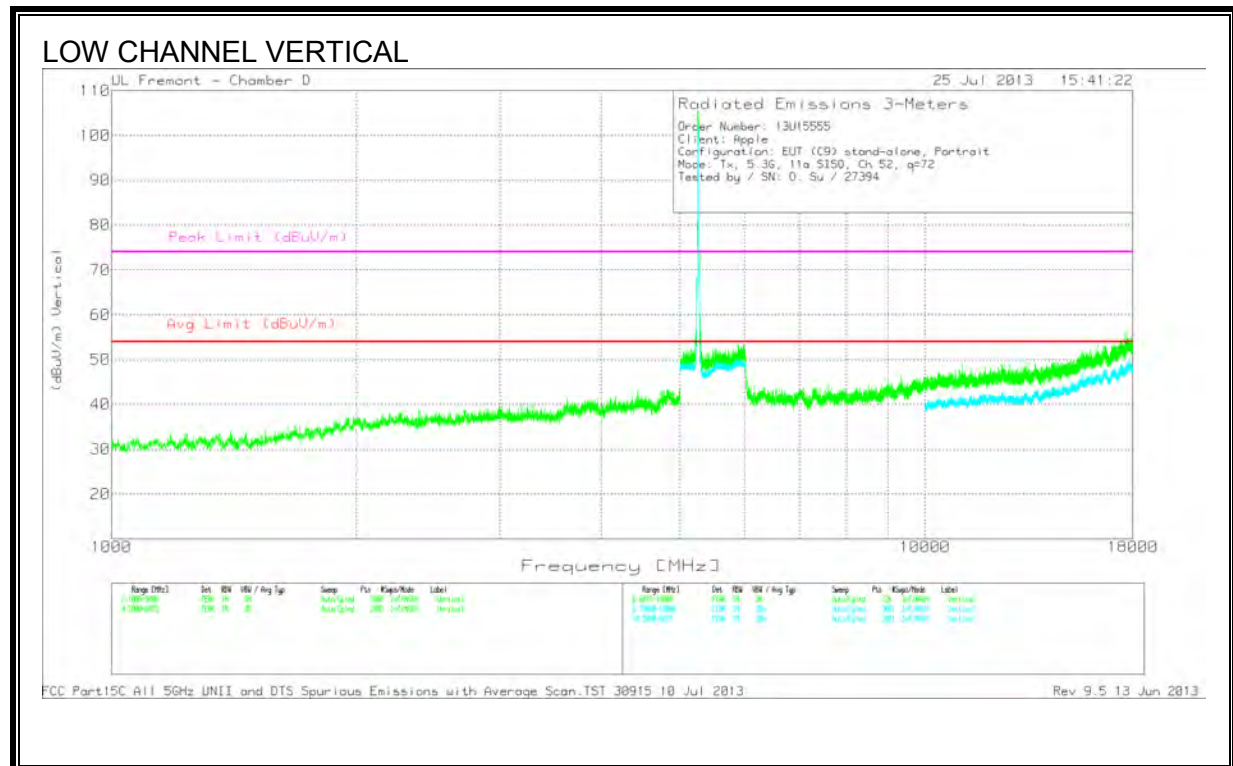
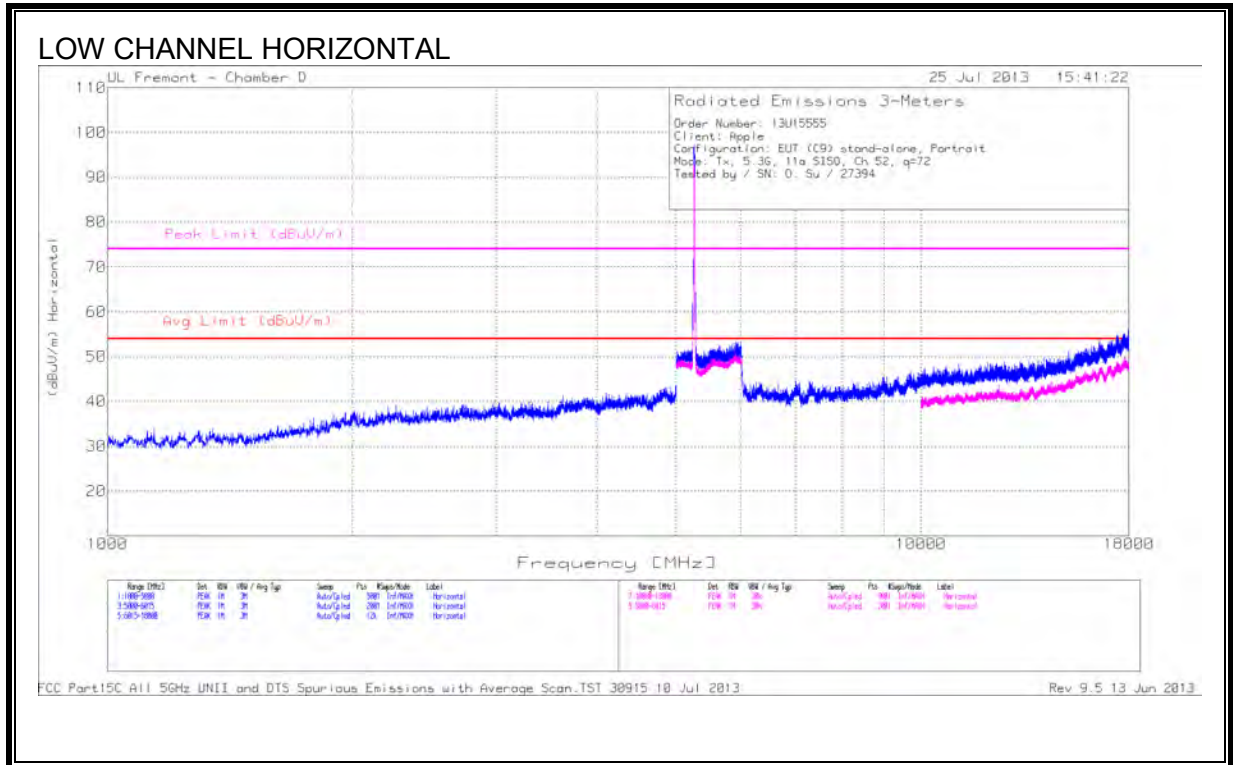

**DATA**

Frequency (GHz)	Meter Reading (dBuV)	Det	AF T344 (db/m)	Amp/Cbl/ Filtr/Pad (dB)	DC Corr [dB]	Corrected Reading (dBuV/m)	Avg Limit (dBuV/m)	Margin (dB)	Peak Limit (dBuV/m)	Margin (dB)	Height (cm)	Polarity
*5.889	39.15	PK	35.5	-21	0	53.65	-	-	68.2	-14.55	100	V

Notes: \* : Not in Restricted Band

PK - Peak detector



**HARMONICS AND SPURIOUS EMISSIONS**

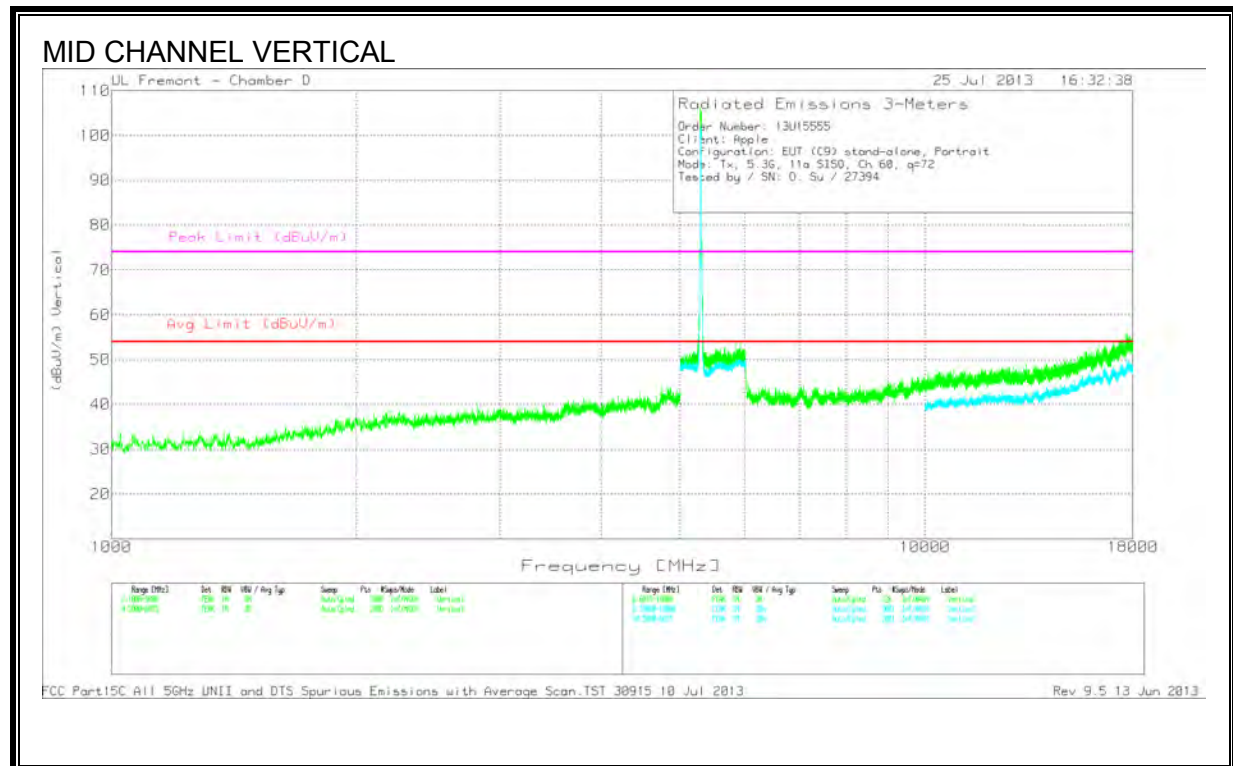
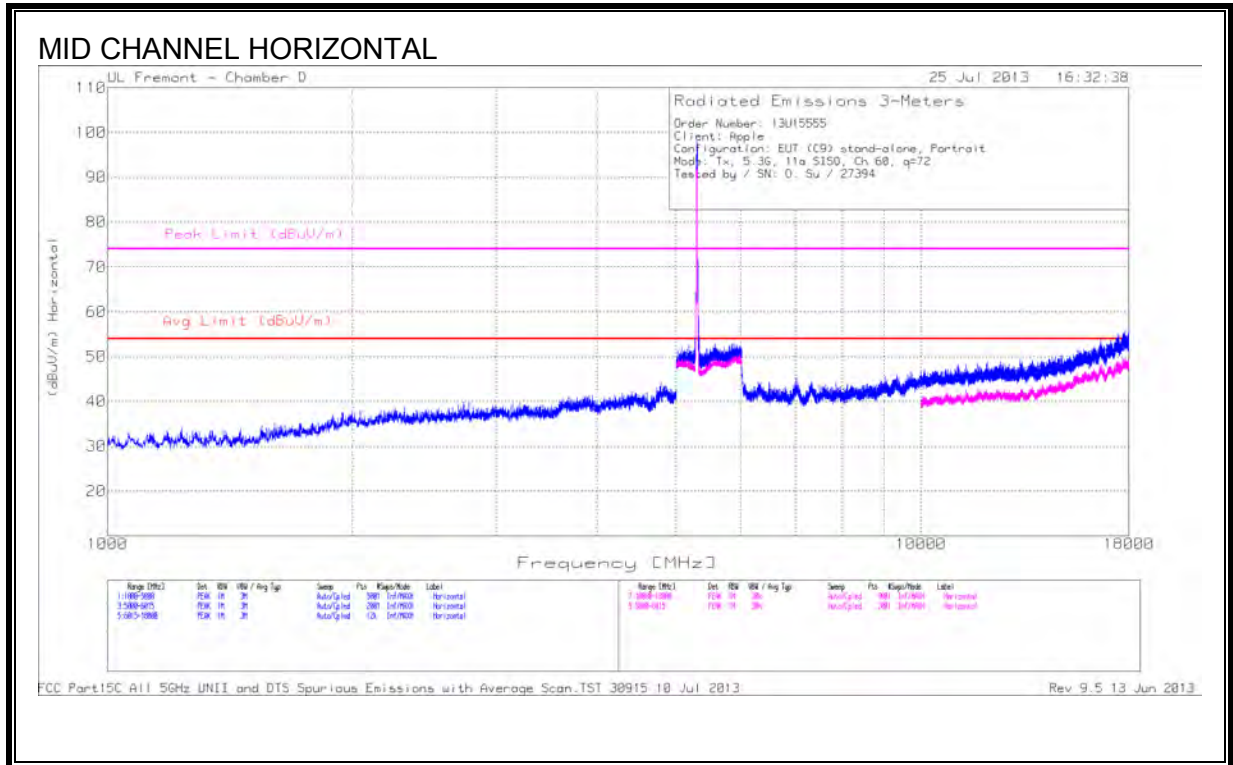

**DATA**

Frequency (GHz)	Meter Reading (dBuV)	Det	AF T344 (db/m)	Amp/Cbl/ Filtr/Pad (dB)	DC Corr [dB]	Corrected Reading (dBuV/m)	Avg Limit (dBuV/m)	Margin (dB)	Peak Limit (dBuV/m)	Margin (dB)	Height (cm)	Polarity
*5.929	39.4	PK	35.6	-21	0	54	-	-	68.2	-14.2	201	V

Notes: \* : Not in Restricted Band

PK - Peak detector

**HARMONICS AND SPURIOUS EMISSIONS**

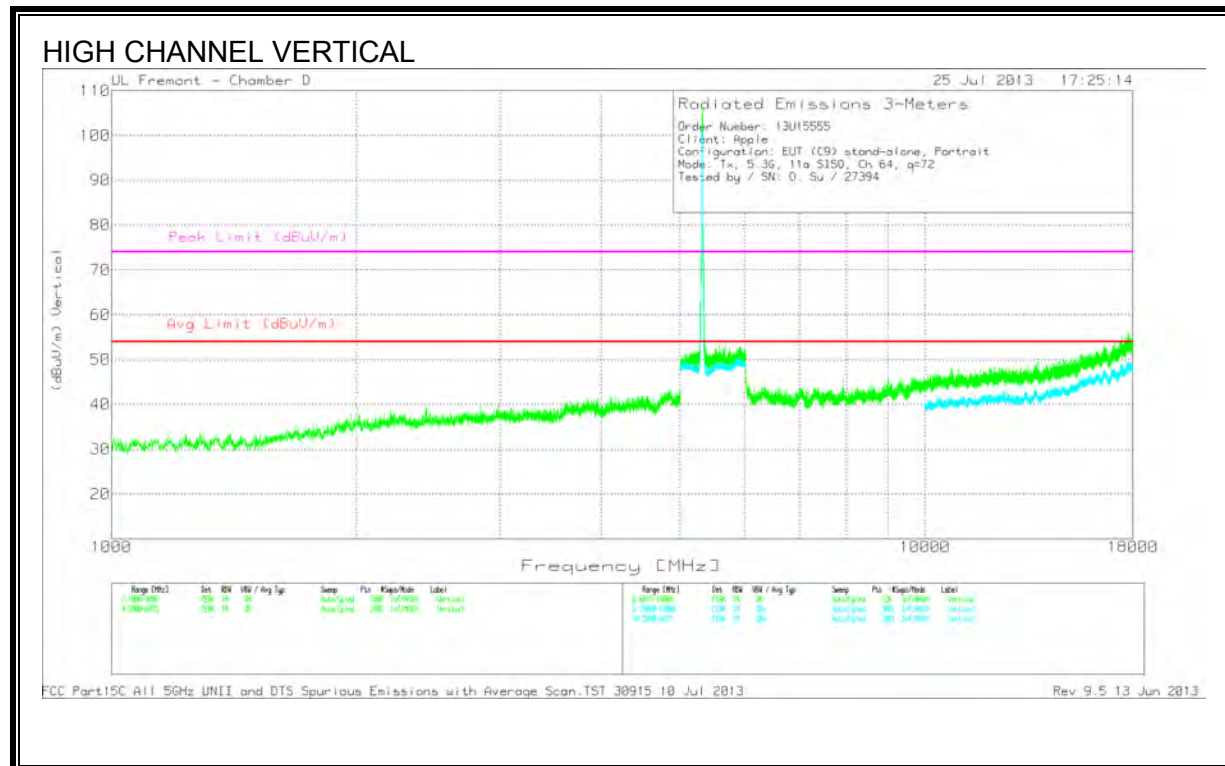
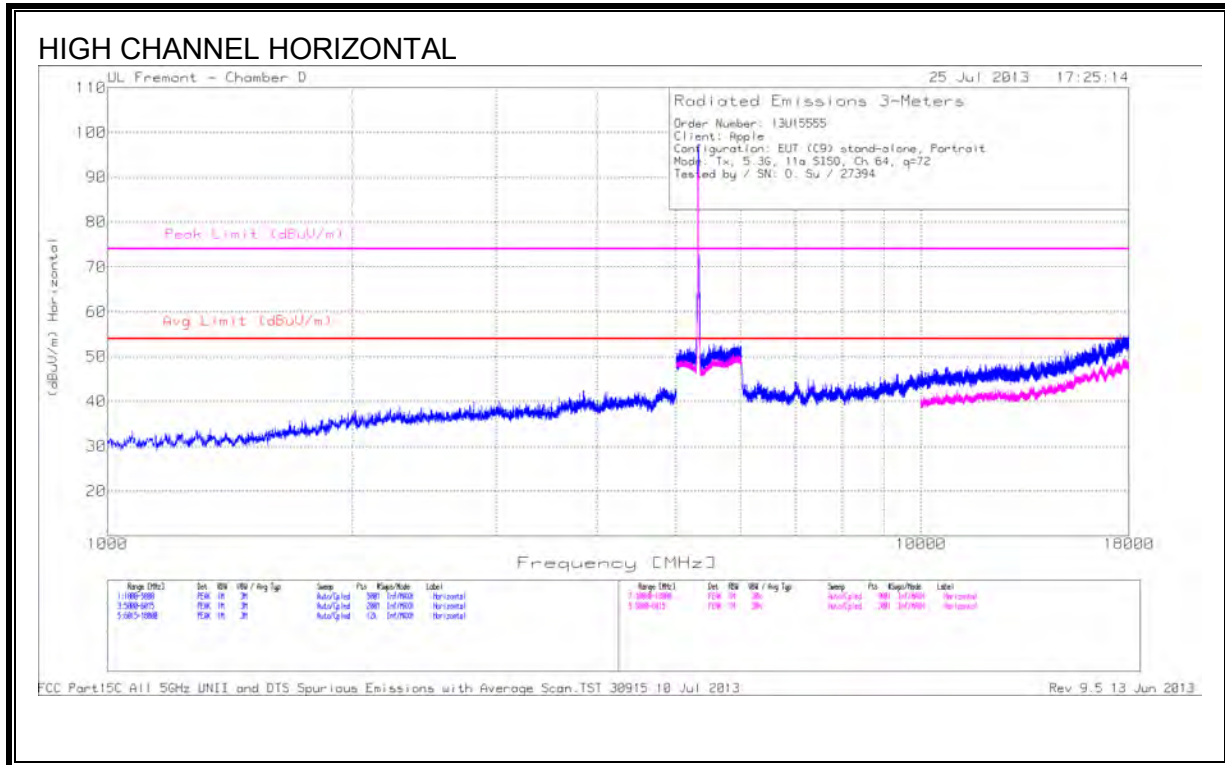

**DATA**

Frequency (GHz)	Meter Reading (dBuV)	Det	AF T344 (db/m)	Amp/Cbl/ Filtr/Pad (dB)	DC Corr [dB]	Corrected Reading (dBuV/m)	Avg Limit (dBuV/m)	Margin (dB)	Peak Limit (dBuV/m)	Margin (dB)	Height (cm)	Polarity
*5.678	39.67	PK	35.2	-21.6	0	53.27	-	-	68.2	-14.93	100	V

Notes: \* : Not in Restricted Band

PK - Peak detector

### 9.2.8. 802.11n HT20 2TX CDD MODE IN THE 5.3 GHz BAND

#### RESTRICTED BANDEDGE (HIGH CHANNEL)

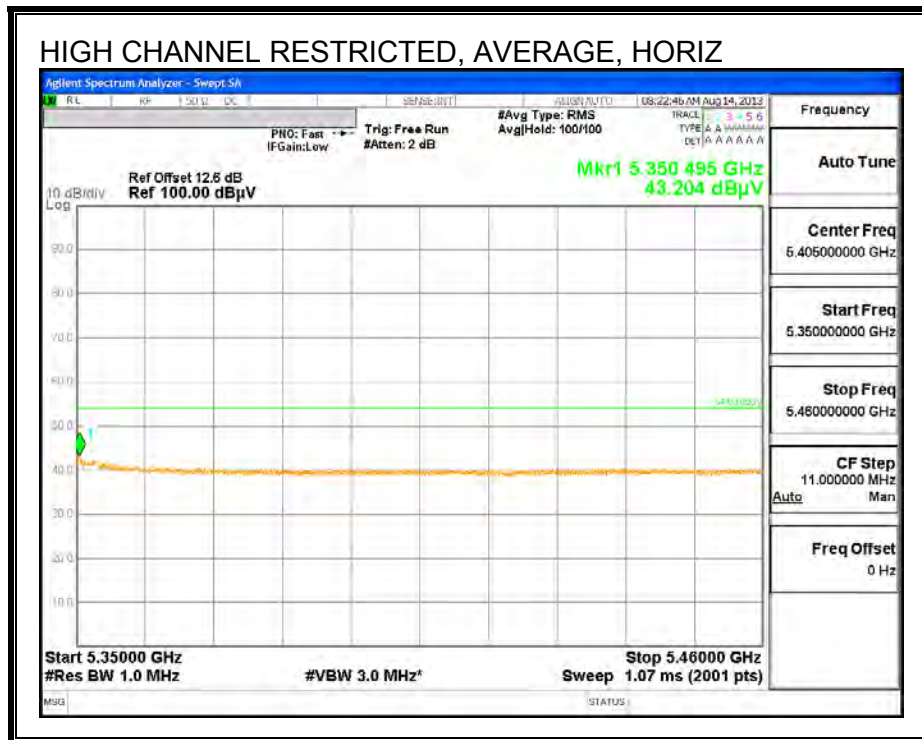
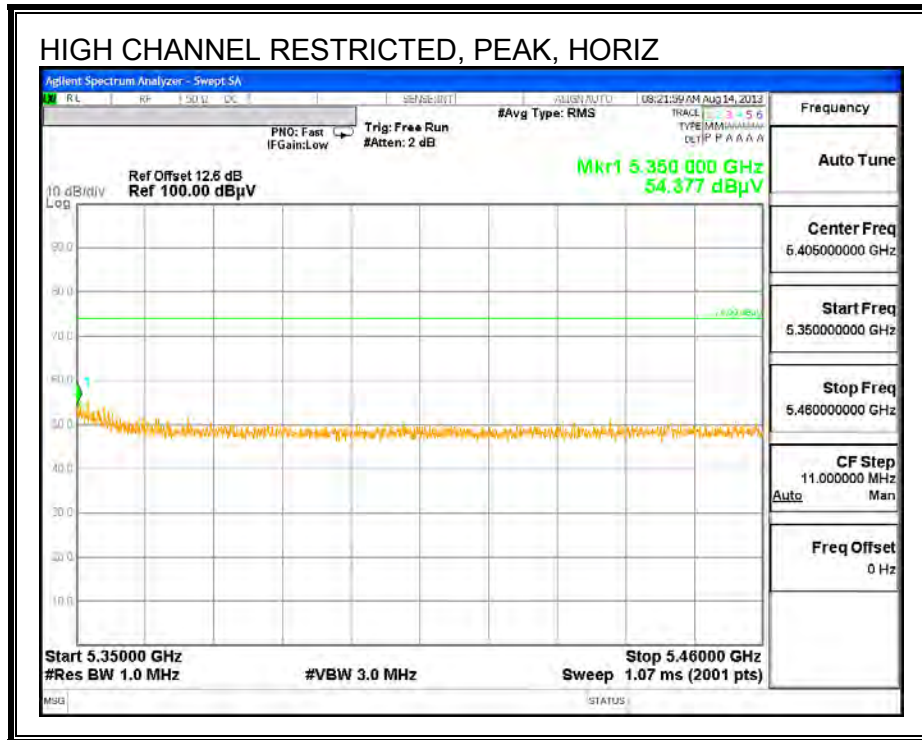

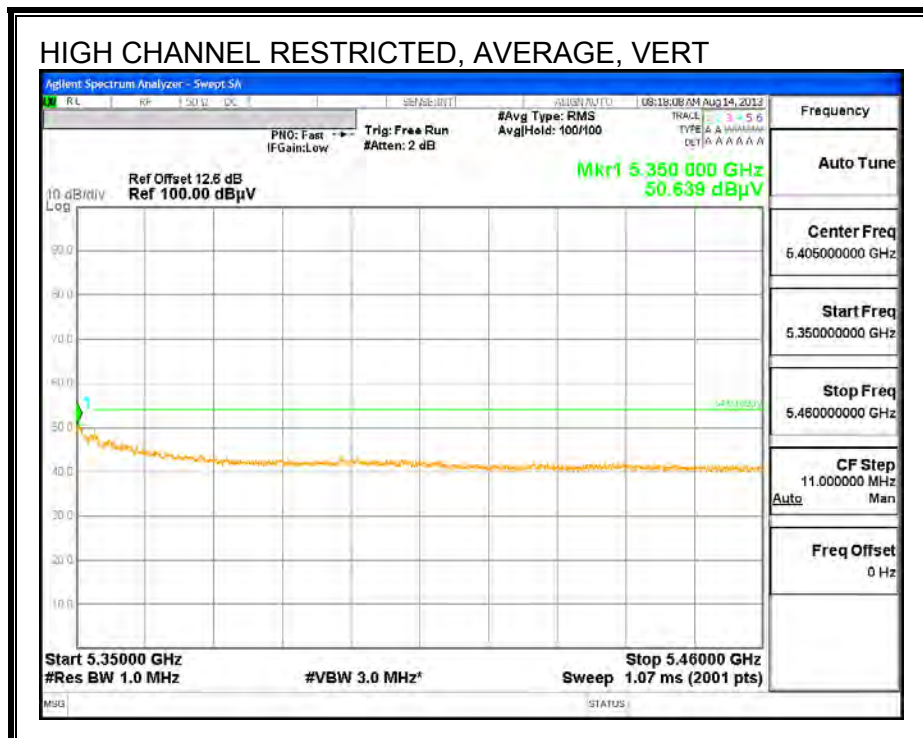
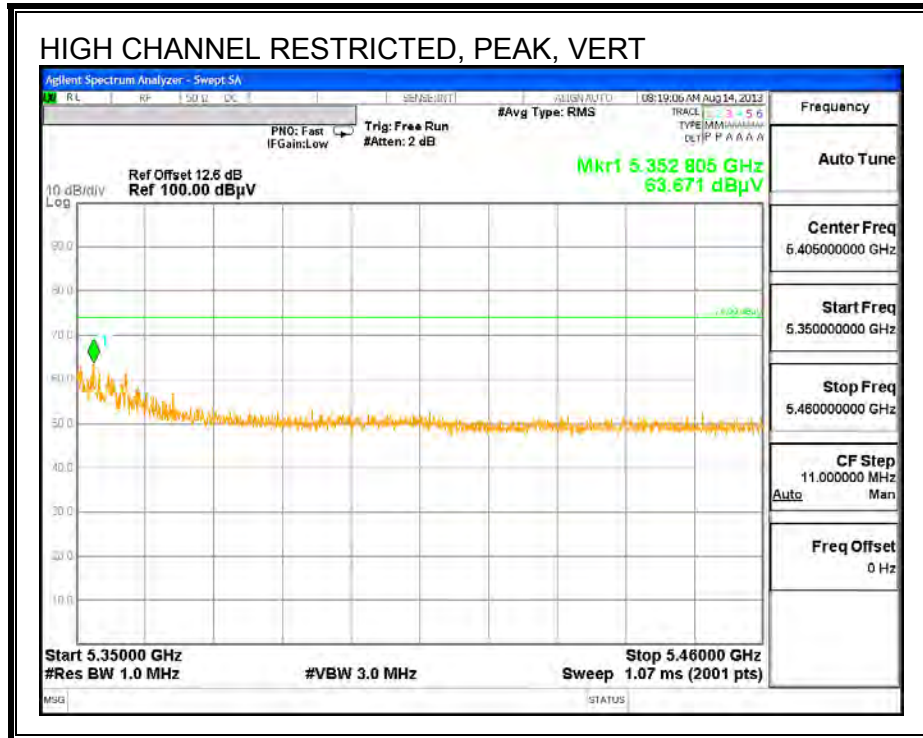

**HARMONICS AND SPURIOUS EMISSIONS**

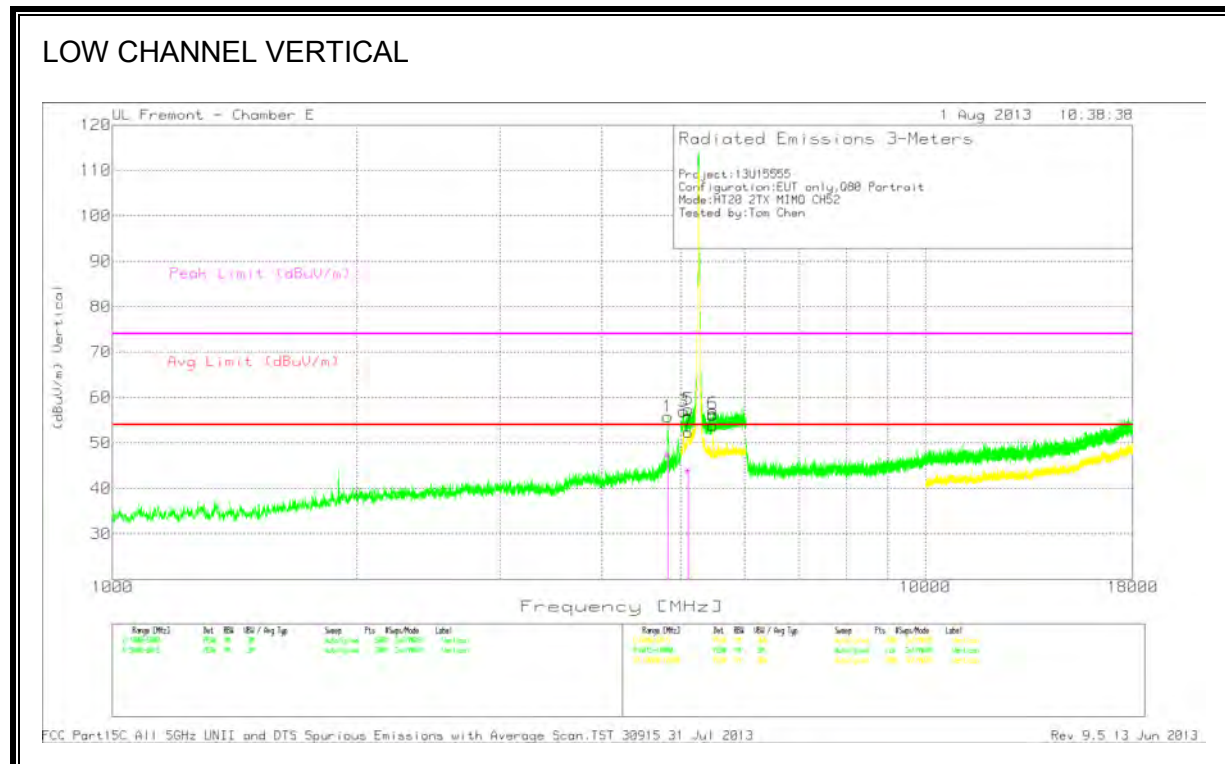
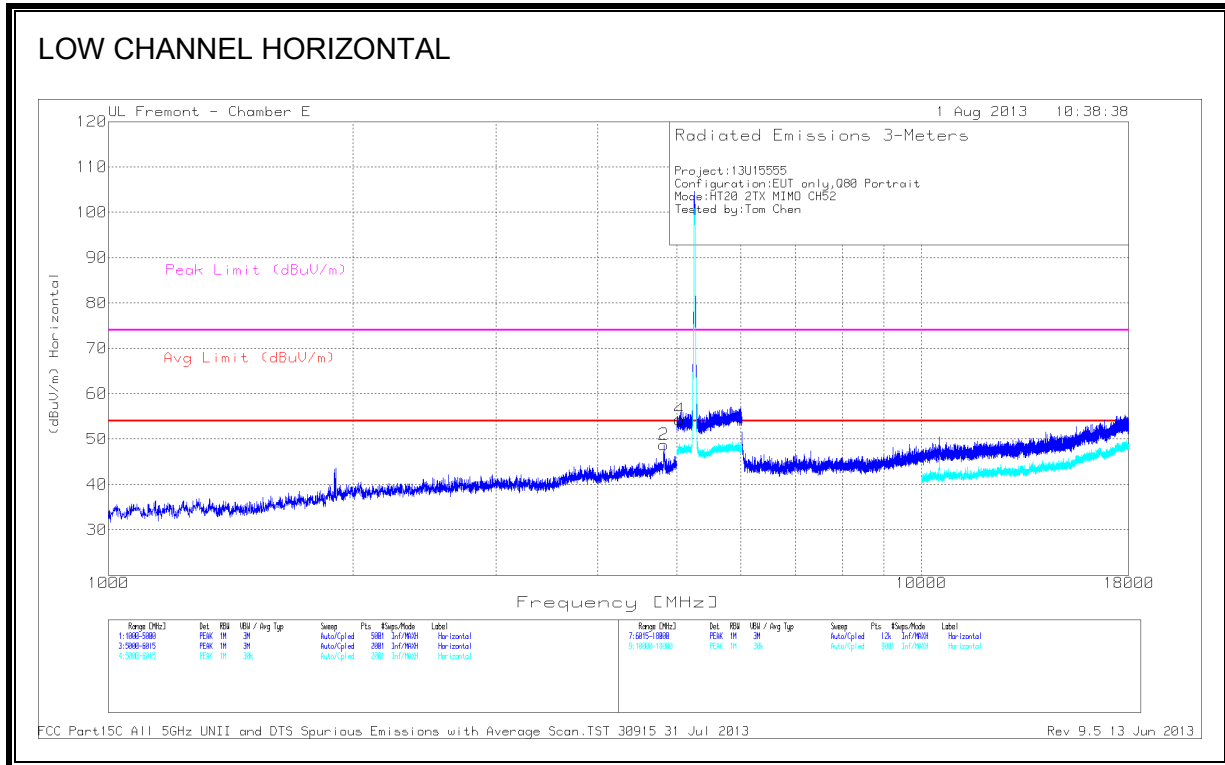

**DATA**

Marker	Frequency (GHz)	Meter Reading (dBuV)	Det	AF T346 (dB/m)	Amp/Cbl/1 0dB Pad (dB)	DC Corr [dB]	Corrected Reading (dBuV/m)	Avg Limit (dBuV/m)	Margin (dB)	Peak Limit (dBuV/m)	Margin (dB)	Height (cm)	Polarity
2	4.822	45.05	PK	34.4	-30.7	0	48.75	54	-5.25	74	-25.25	199	H
1	4.822	52.1	PK	34.4	-30.7	0	55.8	--	--	74	-18.2	200	V
4	5.041	42.13	PK	34.4	-22.2	0	54.33	--	--	74	-19.67	199	H
	5.041	31.03	Av	34.4	-22.2	0	43.23	54	-10.77	--	--	199	H
3	5.041	44.79	PK	34.4	-22.2	0	56.99	--	--	74	-17.01	199	V
	5.041	35.09	Av	34.4	-22.2	0	47.29	54	-6.71	--	--	199	V
5	5.111	44.72	PK	34.5	-21.8	0	57.42	--	--	74	-16.58	100	V
*6	5.479	43.37	PK	34.8	-21.7	0	56.47	--	--	68.2	-11.73	100	V
7	5.111	39.7	PK (VB)	34.5	-21.8	0	52.4	54	-1.60	--	--	199	V

Note: \* : Not in restricted band

PK: Peak detector

**Radiated Emissions**

Frequency (GHz)	Meter Reading (dBuV)	Det	AF T346 (dB/m)	Amp/Cbl 5GHz LPF dB	DC Corr [dB]	Corrected Reading (dBuV/m)	Avg Limit (dBuV/m)	Margin (dB)	Peak Limit (dBuV/m)	Margin (dB)	Azimuth (Degs)	Height (cm)	Polarity
4.822	43.52	Av	34.4	-30.7	.1	47.32	53.97	-6.65	--	--	202	335	V
5.105	31.12	Av	34.5	-21.8	.1	43.92	53.97	-10.05	--	--	239	367	V

Av - average detection



**HARMONICS AND SPURIOUS EMISSIONS**

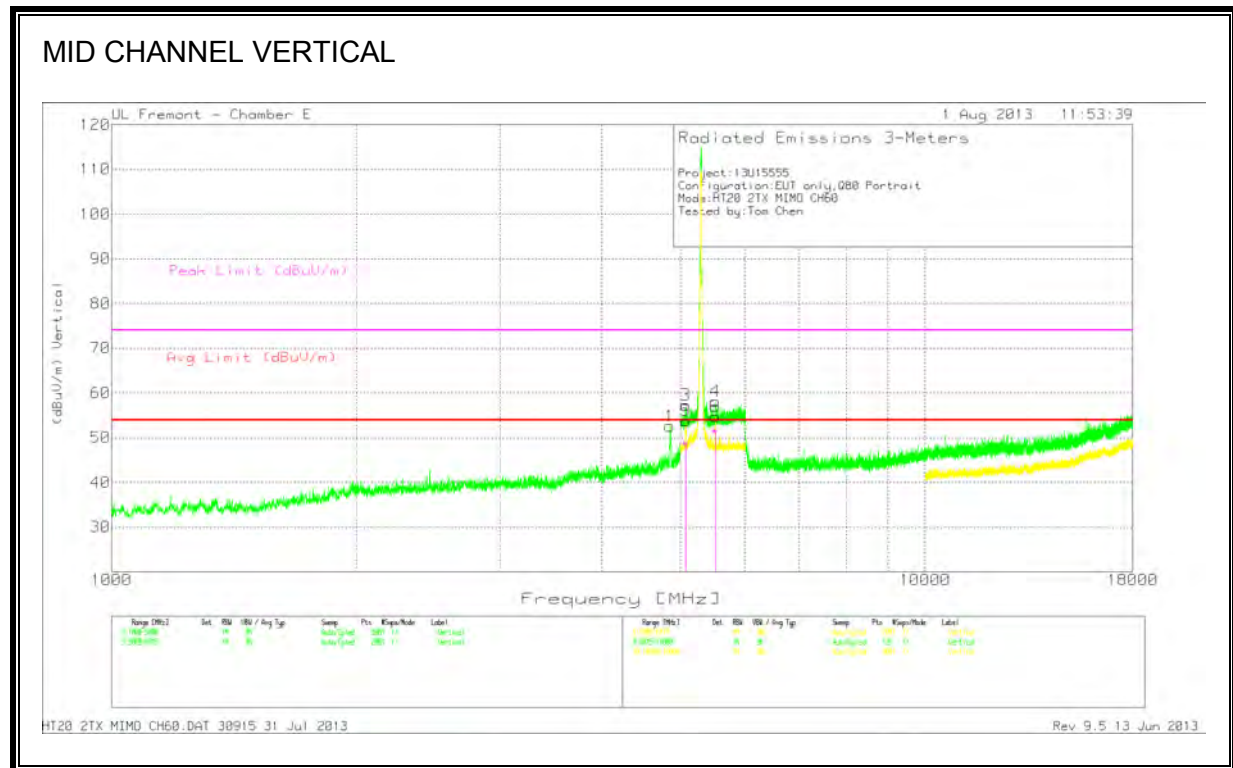
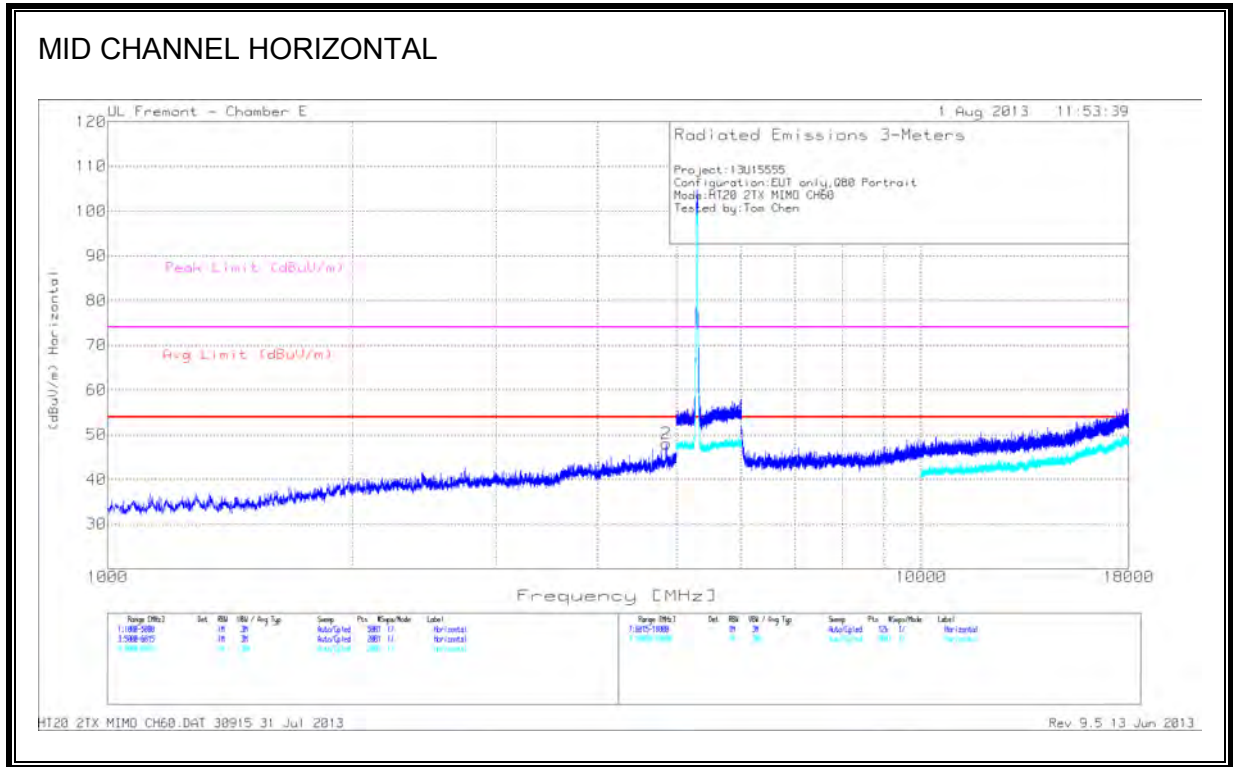

**DATA**

Marker	Frequency (GHz)	Meter Reading (dBuV)	Det	AF T346 (dB/m)	Amp/Cbl 5GHz LPF dB	DC Corr [dB]	Corrected Reading (dBuV/m)	Avg Limit (dBuV/m)	Margin (dB)	Peak Limit (dBuV/m)	Margin (dB)	Height (cm)	Polarity
2	4.859	44.73	PK	34.4	-31.1	0	48.03	54	-5.97	74	-25.97	335	H
1	4.852	49.32	PK	34.4	-31.1	0	52.62	54	-1.38	74	-21.38	200	V

Marker	Frequency (GHz)	Meter Reading (dBuV)	Det	AF T346 (dB/m)	Amp/Cbl /10dB Pad (dB)	DC Corr [dB]	Corrected Reading (dBuV/m)	Avg Limit (dBuV/m)	Margin (dB)	Peak Limit (dBuV/m)	Margin (dB)	Height (cm)	Polarity
3	5.079	44.68	PK	34.5	-21.9	0	57.28	-	-	74	-16.72	100	V
*4	5.522	44.74	PK	34.9	-21.5	0	58.14	-	-	68.2	-15.86	199	V
5	5.079	41.21	PK (VB)	34.5	-21.9	0	53.81	54	-0.19	--	--	199	V
*6	5.521	41.37	PK (VB)	34.9	-21.5	0	54.77	--	--	--	--	100	V

Notes: \* : Not in Restricted Band

PK: Peak detector

Frequency (GHz)	Meter Reading (dBuV)	Det	AF T346 (dB/m)	Amp/Cbl /10dB Pad (dB)	DC Corr [dB]	Corrected Reading (dBuV/m)	Avg Limit (dBuV/m)	Margin (dB)	Peak Limit (dBuV/m)	Margin (dB)	Azimuth (Degs)	Height (cm)	Polarity
5.079	36.04	Av	34.5	-21.9	.1	48.74	53.97	-5.23	74	-25.26	235	146	V

Av - average detection

**HARMONICS AND SPURIOUS EMISSIONS**

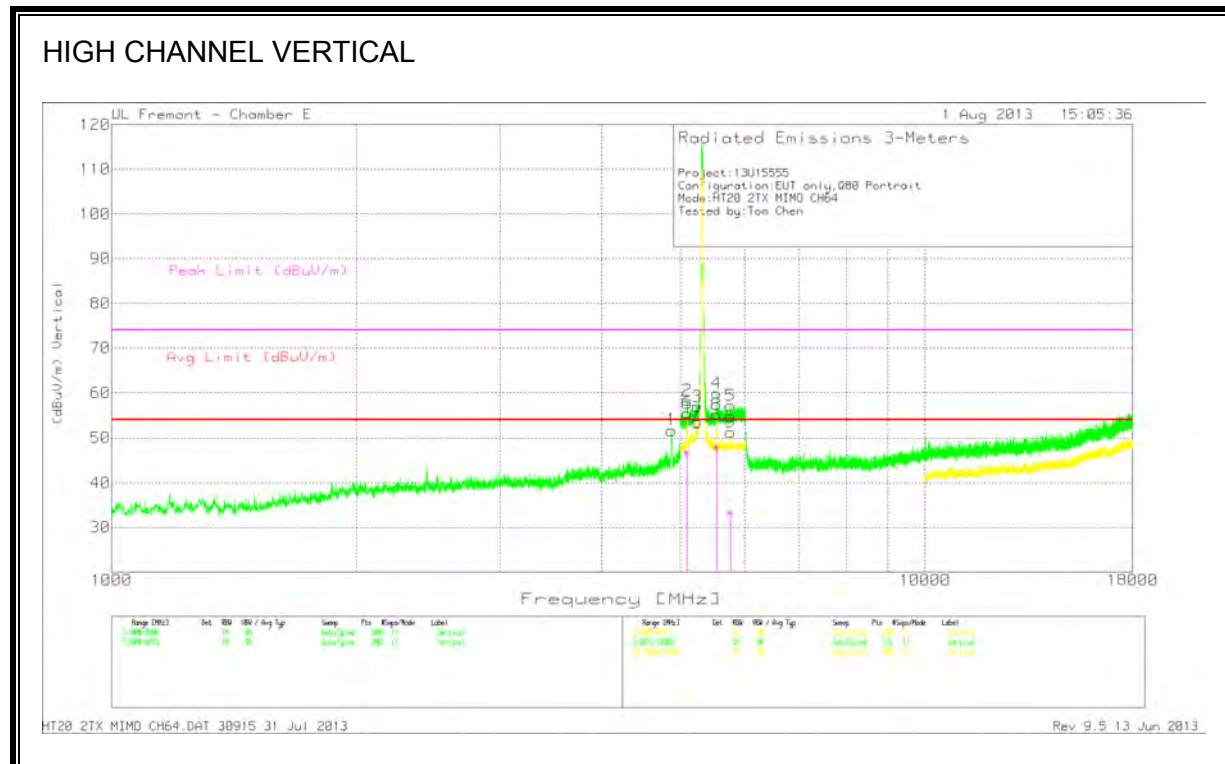
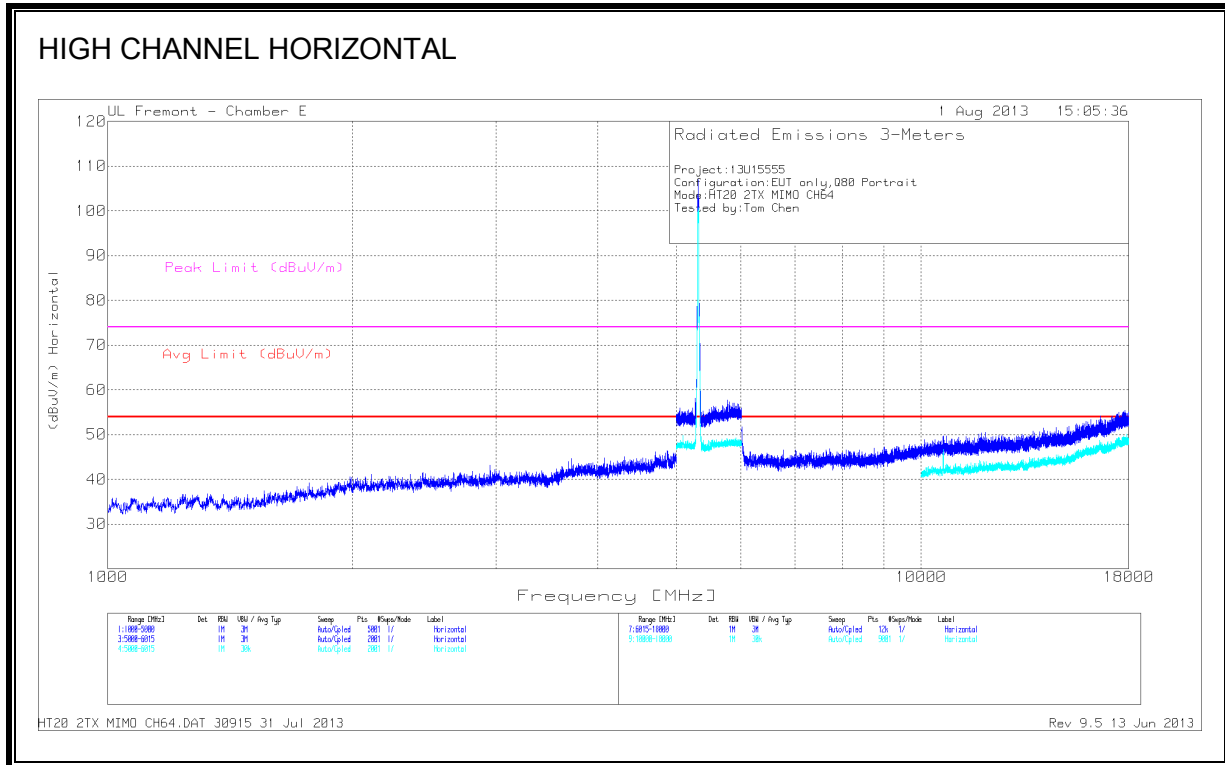

**DATA**

Marker	Frequency (GHz)	Meter Reading (dBuV)	Det	AF T346 (dB/m)	Amp/Cbl /10dB Pad (dB)	DC Corr [dB]	Correcte d Reading (dBuV/m )	Avg Limit (dBuV/m )	Margin (dB)	Peak Limit (dBuV/m )	Margin (dB)	Height (cm)	Polarity
1	4.877	48.28	PK	34.4	-31	0	51.68	54	-2.32	74	-22.32	100	V
2	5.098	45.57	PK	34.5	-21.8	0	58.27	--	--	74	-15.73	100	V
*3	5.248	43.82	PK	34.7	-21.6	0	56.92	--	--	68.2	-11.25	199	V
*4	5.543	46.32	PK	34.9	-21.3	0	59.92	--	--	68.2	-8.28	100	V
*5	5.763	43.4	PK	35.4	-21.7	0	57.1	--	--	68.2	-11.1	199	V
6	5.098	42.69	PK	34.5	-21.8	0	55.39	--	--	74	-18.61	100	V
*7	5.244	40.25	PK	34.7	-21.5	0	53.45	--	--	68.2	-14.75	100	V
*8	5.542	41.65	PK	34.9	-21.4	0	55.15	--	--	68.2	-13.05	199	V
*9	5.764	37.62	PK	35.4	-21.7	0	51.32	--	--	68.2	-16.88	199	V

Notes: \* : Not in Restricted Band

PK: Peak detector

Frequency (GHz)	Meter Reading (dBuV)	Det	AF T346 (dB/m)	Amp/Cbl /10dB Pad (dB)	DC Corr [dB]	Correcte d Reading (dBuV/m )	Avg Limit (dBuV/m )	Margin (dB)	Peak Limit (dBuV/m )	Margin (dB)	Azimuth (Degs)	Height (cm)	Polarity
5.097	33.89	Av	34.5	-21.8	.1	46.69	53.97	-7.28	--	--	191	170	V

Av - average detection

### 9.2.9. 802.11n HT40 SISO MODE IN THE 5.3 GHz BAND

#### RESTRICTED BANDEDGE (HIGH CHANNEL)

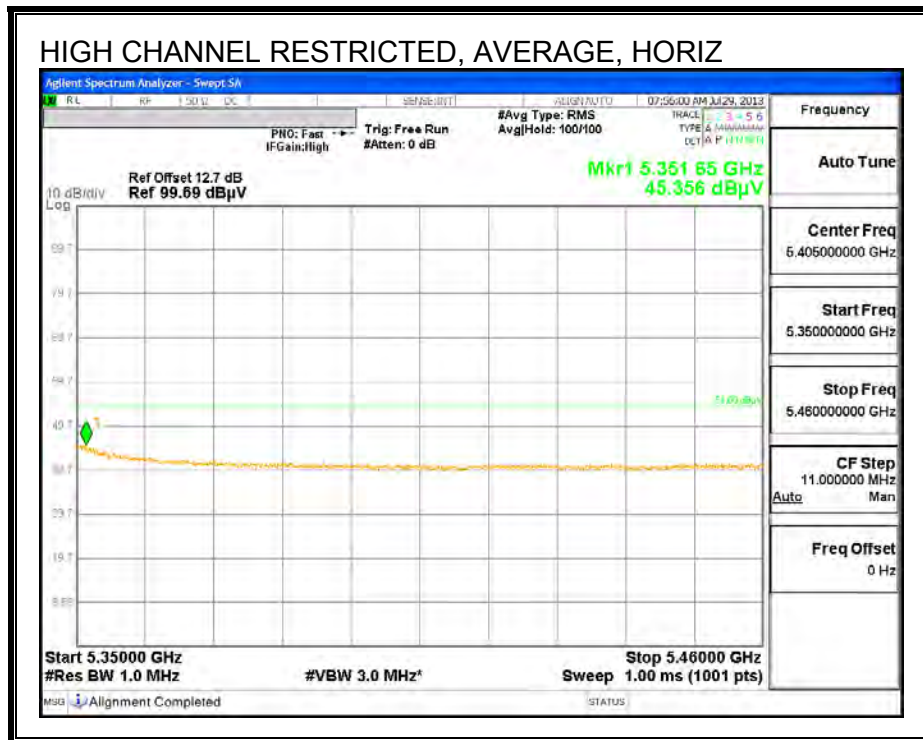
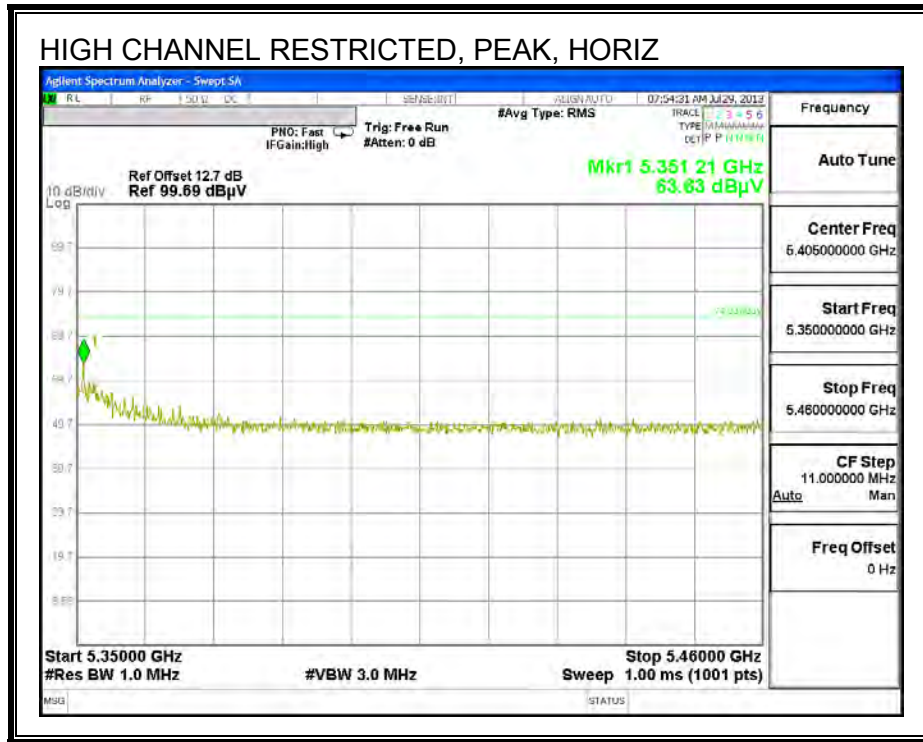

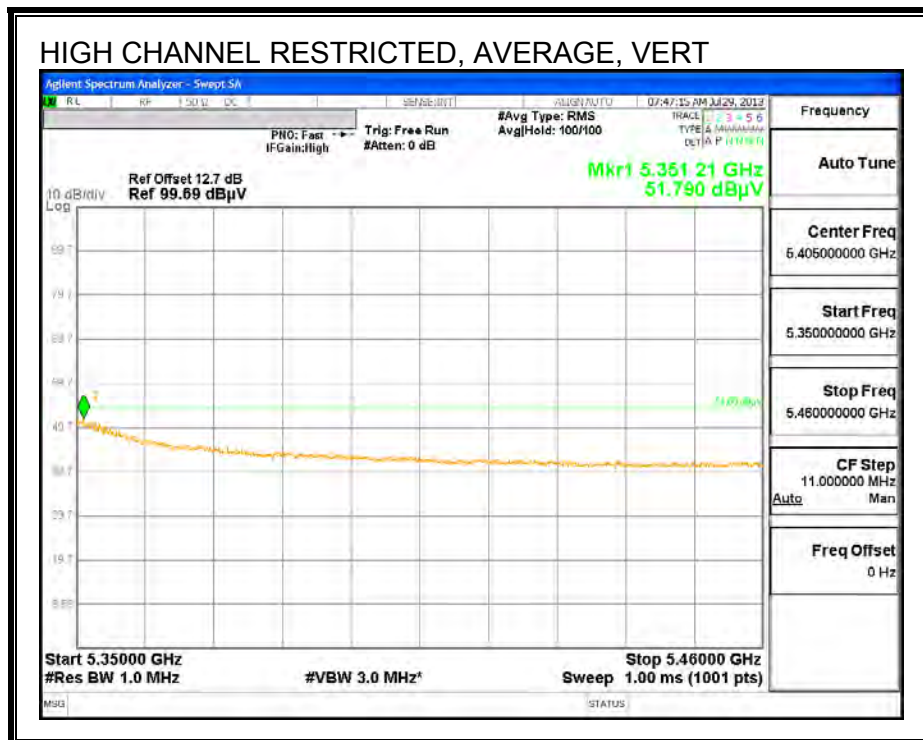
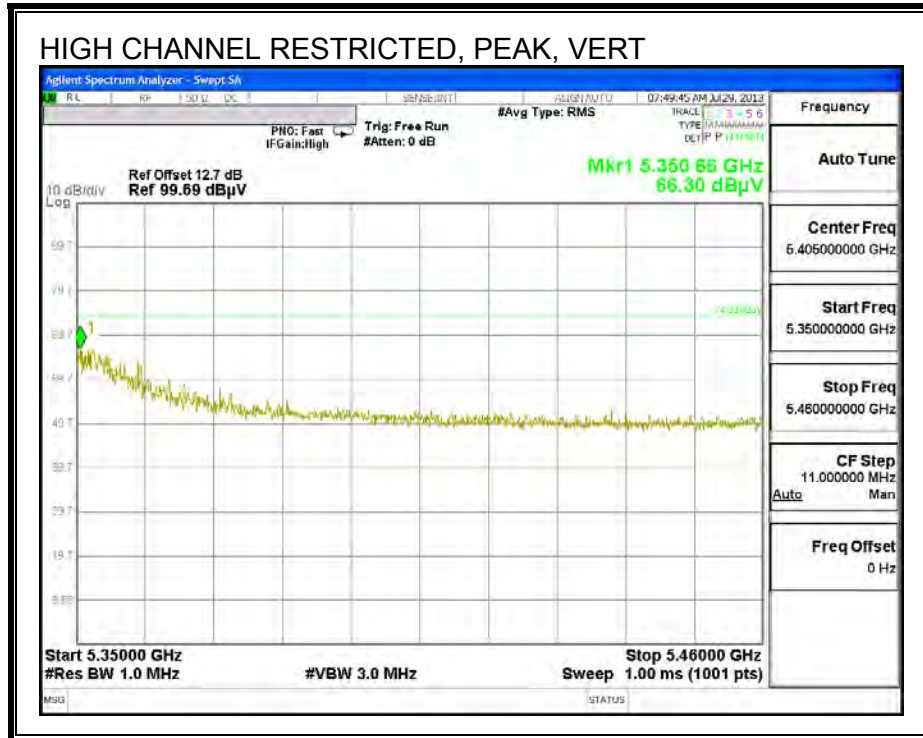

**HARMONICS AND SPURIOUS EMISSIONS**

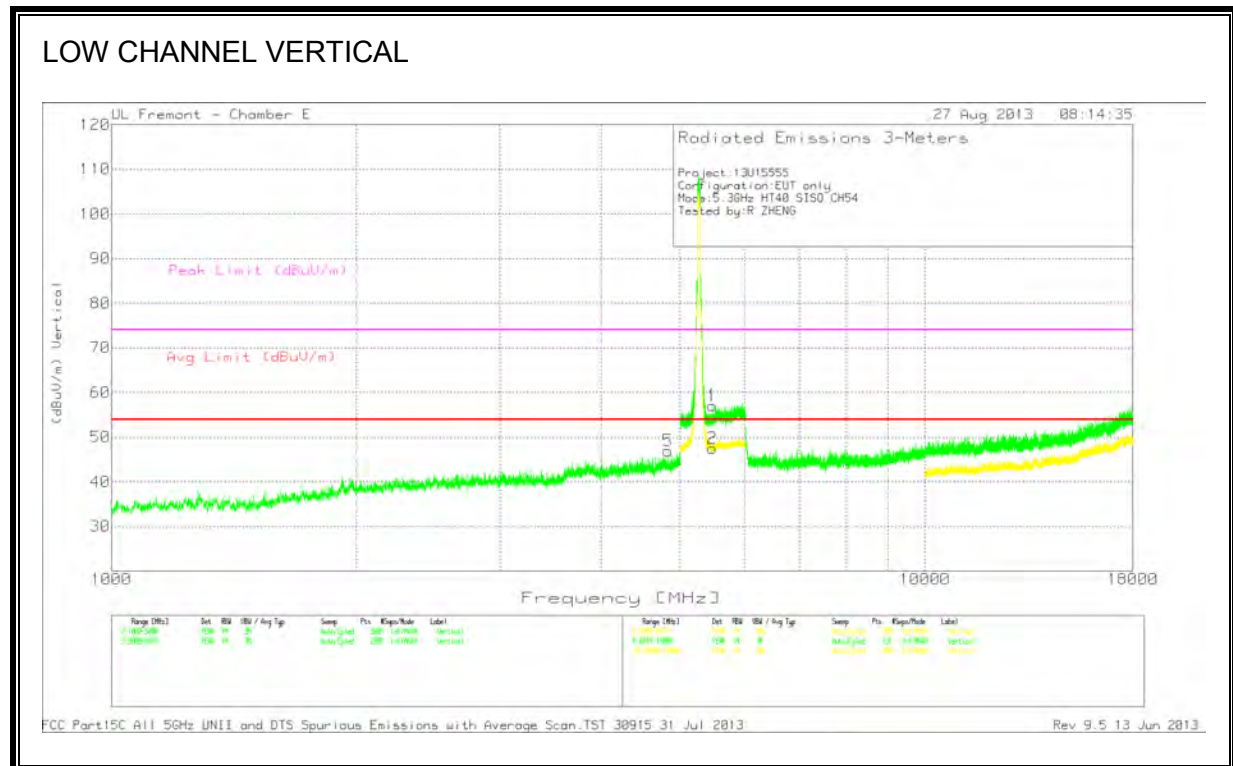
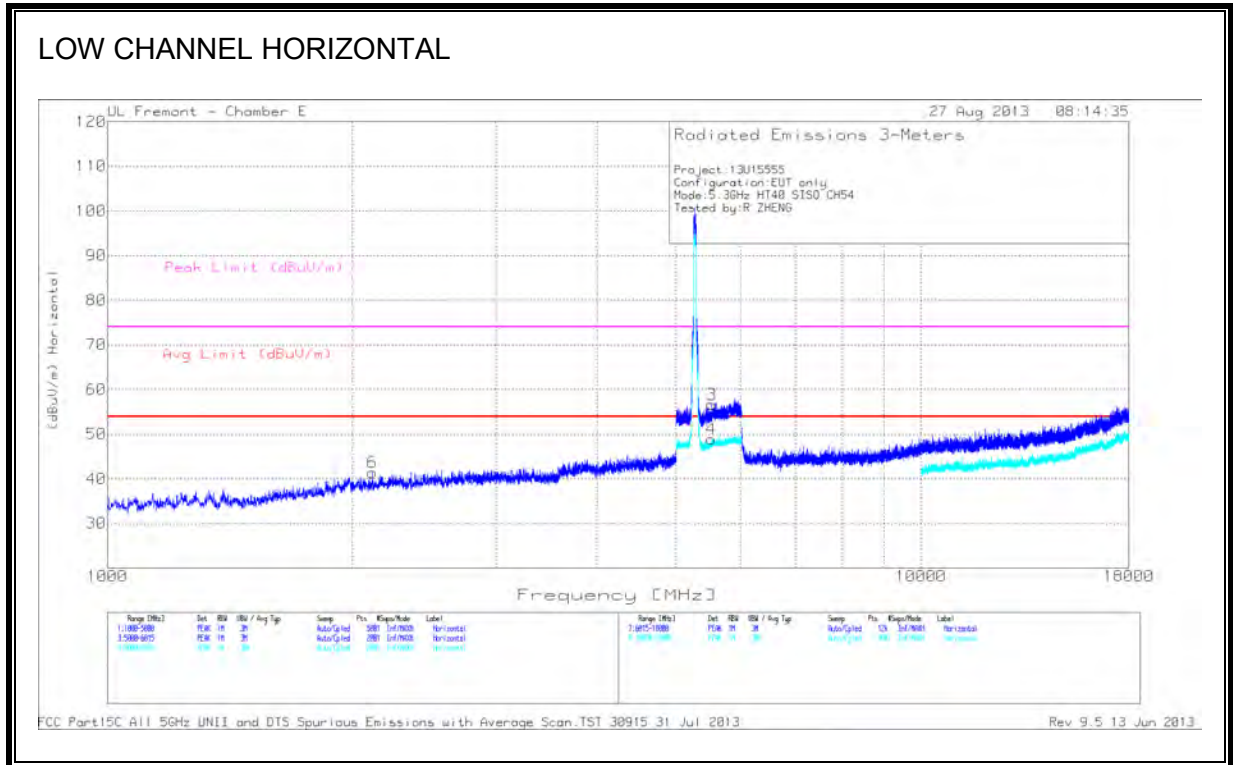

**DATA**

Marker	Frequenc y (GHz)	Meter Reading (dBuV)	Det	AF T346 (dB/m)	Amp/Cbl /5GHz LPF	DC Corr [dB]	Correcte d Reading (dBuV/m )	Avg Limit (dBuV/m )	Margin (dB)	Peak Limit (dBuV/m )	Margin (dB)	Height (cm)	Polarity
*6	2.116	43.14	PK	32.2	-33.9	0	41.44	--	--	68.2	-26.76	99	H
5	4.831	42.94	PK	34.4	-30.4	0	46.94	54	-7.06	74	-27.06	200	V

Marker	Frequenc y (GHz)	Meter Reading (dBuV)	Det	AF T346 (dB/m)	Amp/Cbl /10dB Pad	DC Corr [dB]	Correcte d Reading (dBuV/m )	Avg Limit (dBuV/m )	Margin (dB)	Peak Limit (dBuV/m )	Margin (dB)	Height (cm)	Polarity
*3	5.526	42.72	PK	34.9	-21	0	56.62	--	--	68.2	-11.94	100	H
*4	5.525	35.01	PK (VB)	34.9	-21	0	48.91	--	--	68.2	-19.29	200	H
*1	5.477	43.45	Pk	34.8	-21.2	0	57.05	--	--	68.2	-11.15	199	V
*2	5.476	33.94	Pk (VB)	34.8	-21.2	0	47.54	--	--	68.2	-20.66	100	V

Notes: \* : Not in Restricted Band

PK: Peak detector



**HARMONICS AND SPURIOUS EMISSIONS**

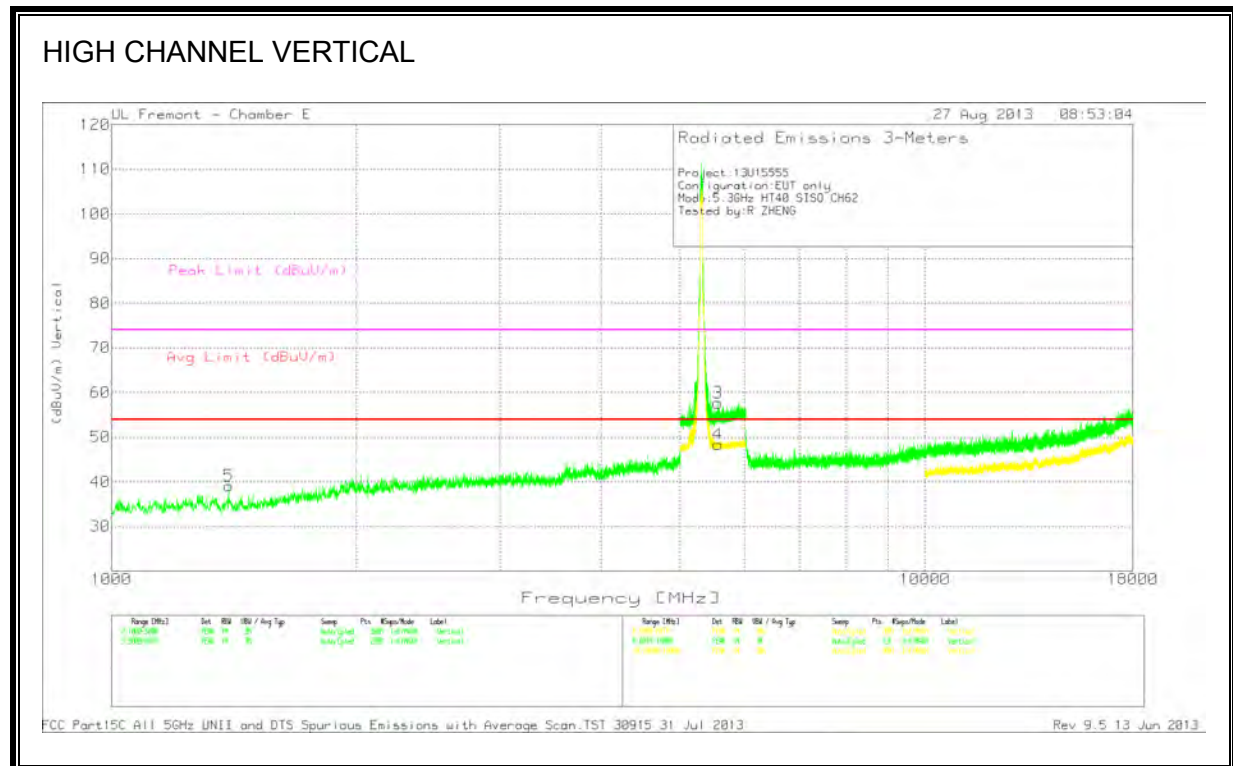
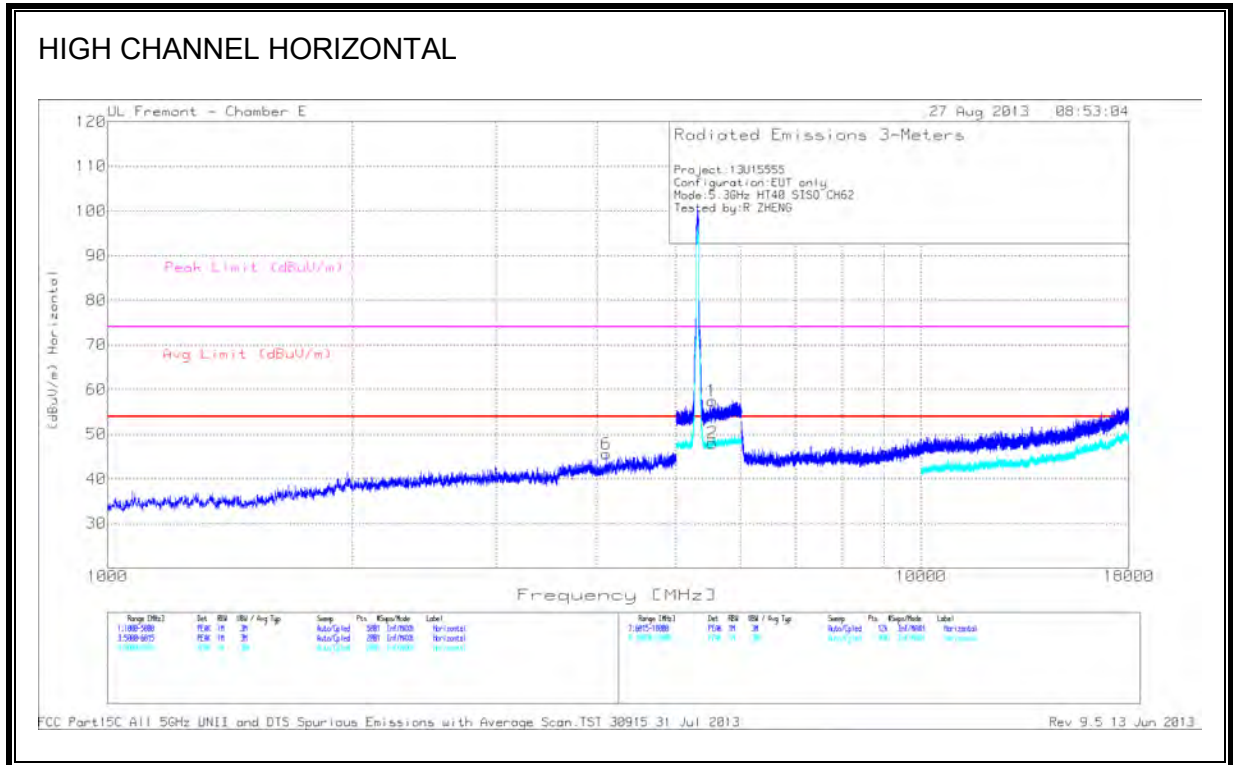

**DATA**

Marker	Frequenc y (GHz)	Meter Reading (dBuV)	Det	AF T346 (dB/m)	Amp/Cbl /5GHz LPF	DC Corr [dB]	Correcte d Reading (dBuV/m )	Avg Limit (dBuV/m )	Margin (dB)	Peak Limit (dBuV/m )	Margin (dB)	Height (cm)	Polarity
6	4.102	42.5	PK	33.9	-30.8	0	45.6	54	-8.4	74	-28.4	199	H
5	1.394	44.29	PK	29	-34.2	0	39.09	54	-14.91	74	-34.91	200	V

Marker	Frequenc y (GHz)	Meter Reading (dBuV)	Det	AF T346 (dB/m)	Amp/Cbl /10dB Pad	DC Corr [dB]	Correcte d Reading (dBuV/m )	Avg Limit (dBuV/m )	Margin (dB)	Peak Limit (dBuV/m )	Margin (dB)	Height (cm)	Polarity
*1	5.537	43.56	PK	34.9	-21	0	57.46	-	-	68.2	-10.74	100	H
*2	5.539	34.13	PK (VB)	34.9	-21	0	48.03	-	-	68.2	-20.17	100	H
*3	5.564	43.58	PK	35	-20.9	0	57.68	-	-	68.2	-10.52	199	V
*4	5.564	34.26	PK (VB)	35	-20.9	0	48.36	-	-	68.2	-19.84	200	V

Notes: \* : Not in Restricted Band

PK: Peak detector

**9.2.10. 802.11n HT40 2TX CDD MODE IN THE 5.3 GHz BAND**

**RESTRICTED BANDEDGE (HIGH CHANNEL)**

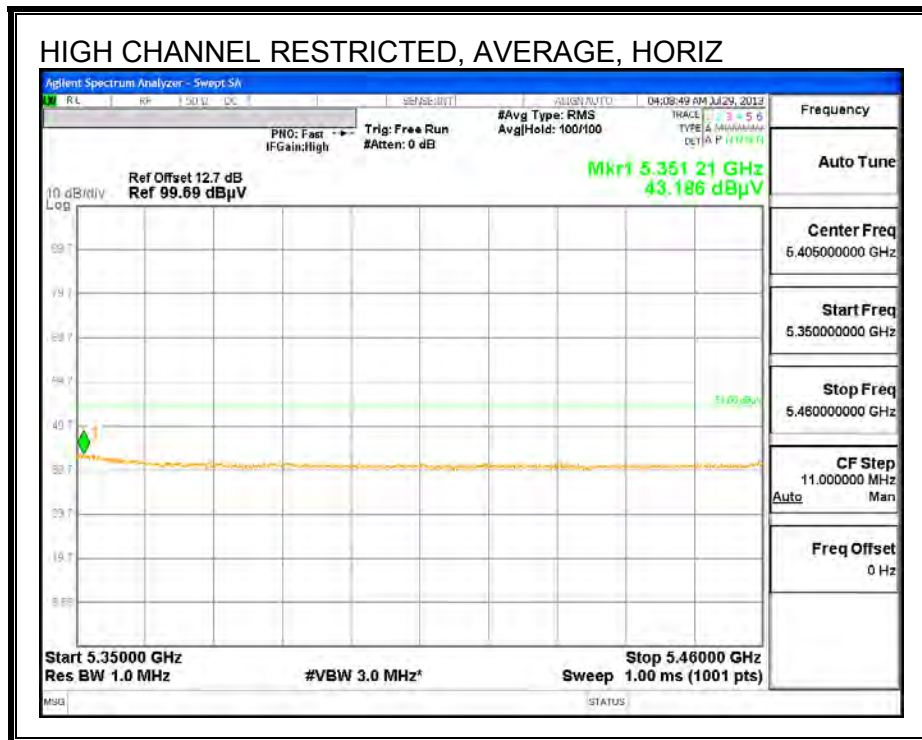
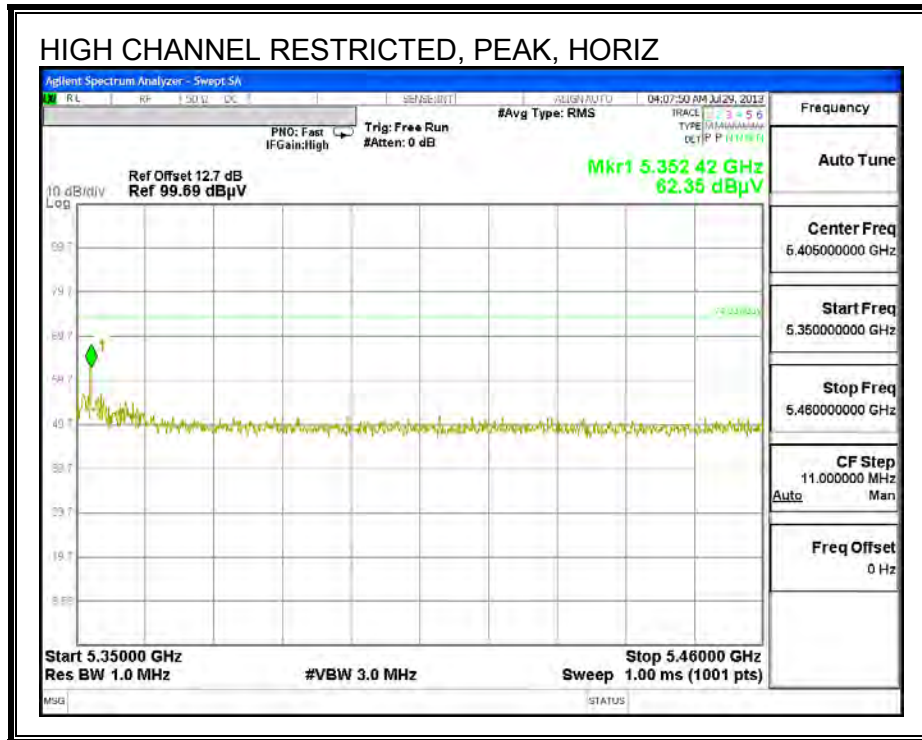

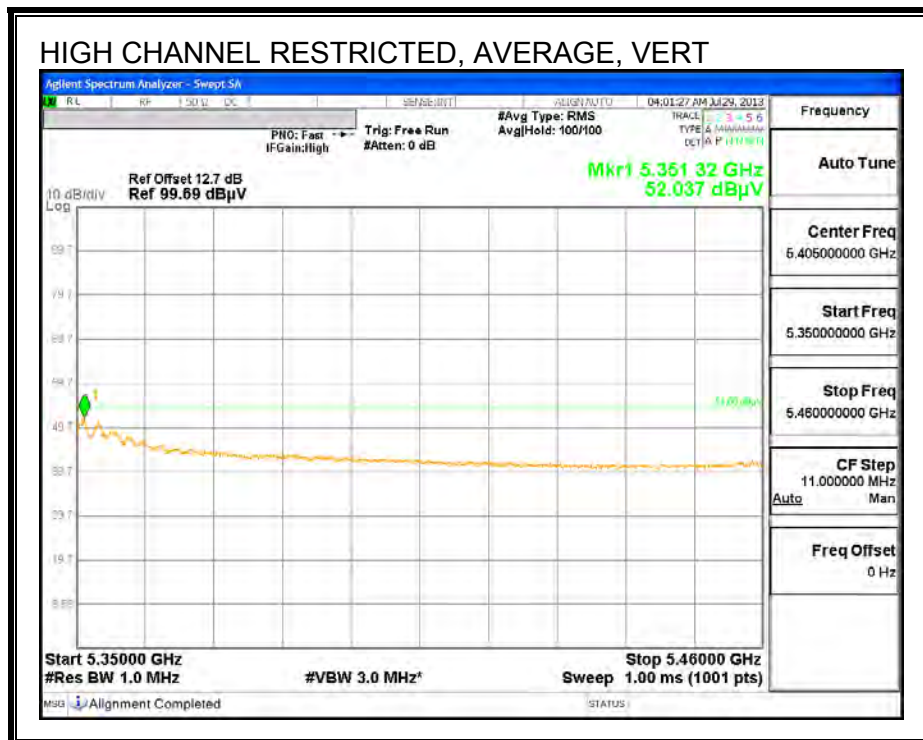
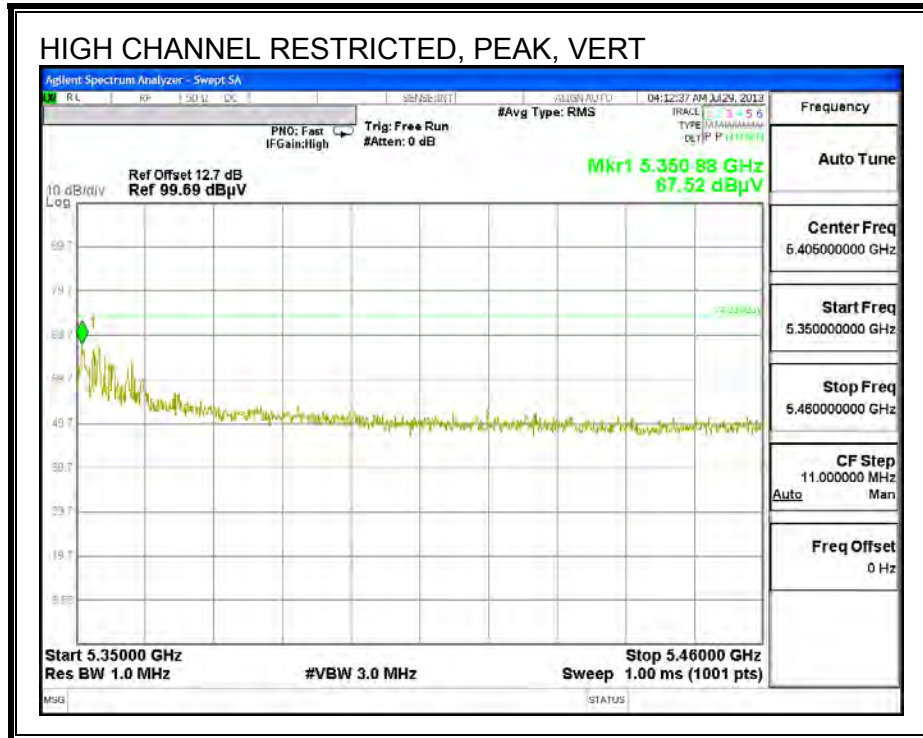

**HARMONICS AND SPURIOUS EMISSIONS**

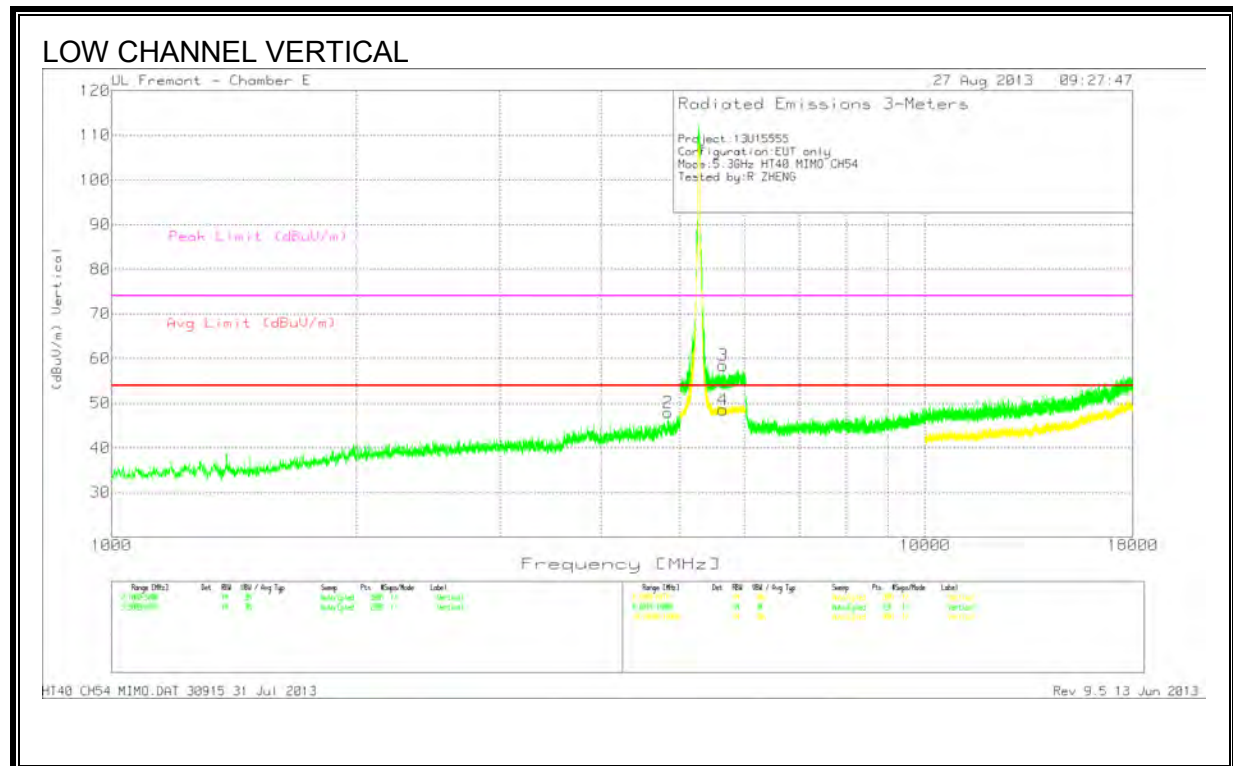
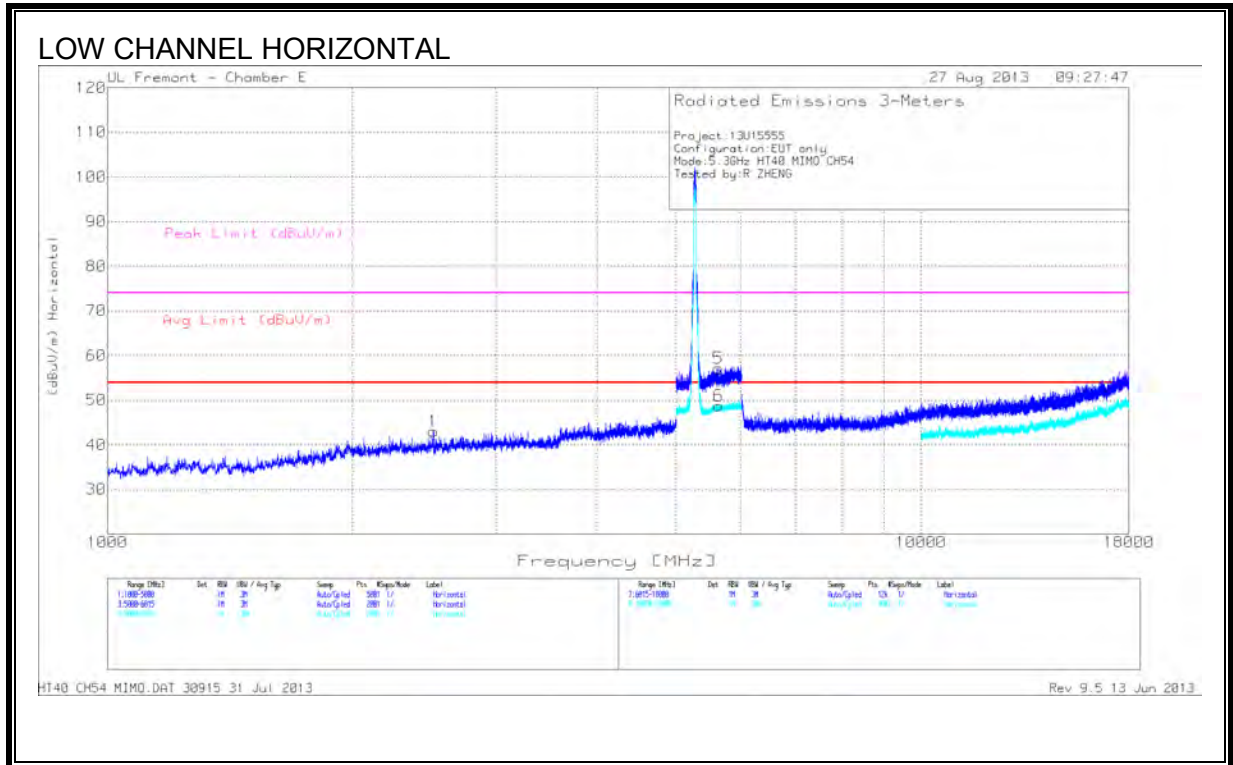

**DATA**

Marker	Frequenc y (GHz)	Meter Reading (dBuV)	Det	AF T346 (dB/m)	Amp/Cbl /5GHz LPF	DC Corr [dB]	Correcte d Reading (dBuV/m )	Avg Limit (dBuV/m )	Margin (dB)	Peak Limit (dBuV/m )	Margin (dB)	Height (cm)	Polarity
1	2.514	42.72	PK	32.7	-32.4	0	43.02	54	-10.98	74	-30.98	100	H
2	4.832	43.93	PK	34.4	-30.4	0	47.93	54	-6.07	74	-26.07	200	V

Marker	Frequenc y (GHz)	Meter Reading (dBuV)	Det	AF T346 (dB/m)	Amp/Cbl /10dB Pad	DC Corr [dB]	Correcte d Reading (dBuV/m )	Avg Limit (dBuV/m )	Margin (dB)	Peak Limit (dBuV/m )	Margin (dB)	Height (cm)	Polarity
*5	5.634	43.04	PK	35.1	-21	0	57.14			68.2	-11.06	199	H
*6	5.636	34.64	Pk (VB)	35.1	-21	0	48.74			68.2	-19.46	101	H
*3	5.644	44.5	PK	35.1	-21.1	0	58.5			68.2	-9.70	101	V
*4	5.643	34.54	(PK (VB)	35.1	-21.1	0	48.54			68.2	-19.66	100	V

Notes: \* : Not in Restricted Band

PK: Peak detector

**HARMONICS AND SPURIOUS EMISSIONS**

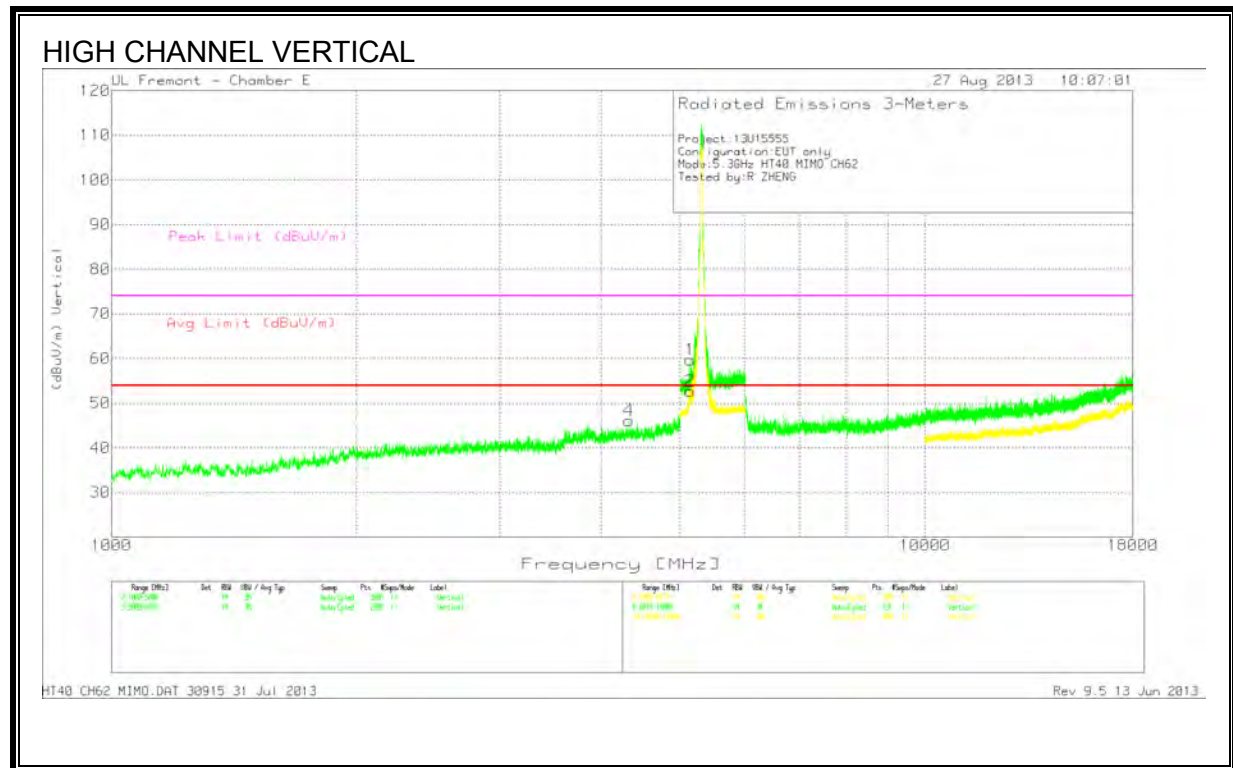
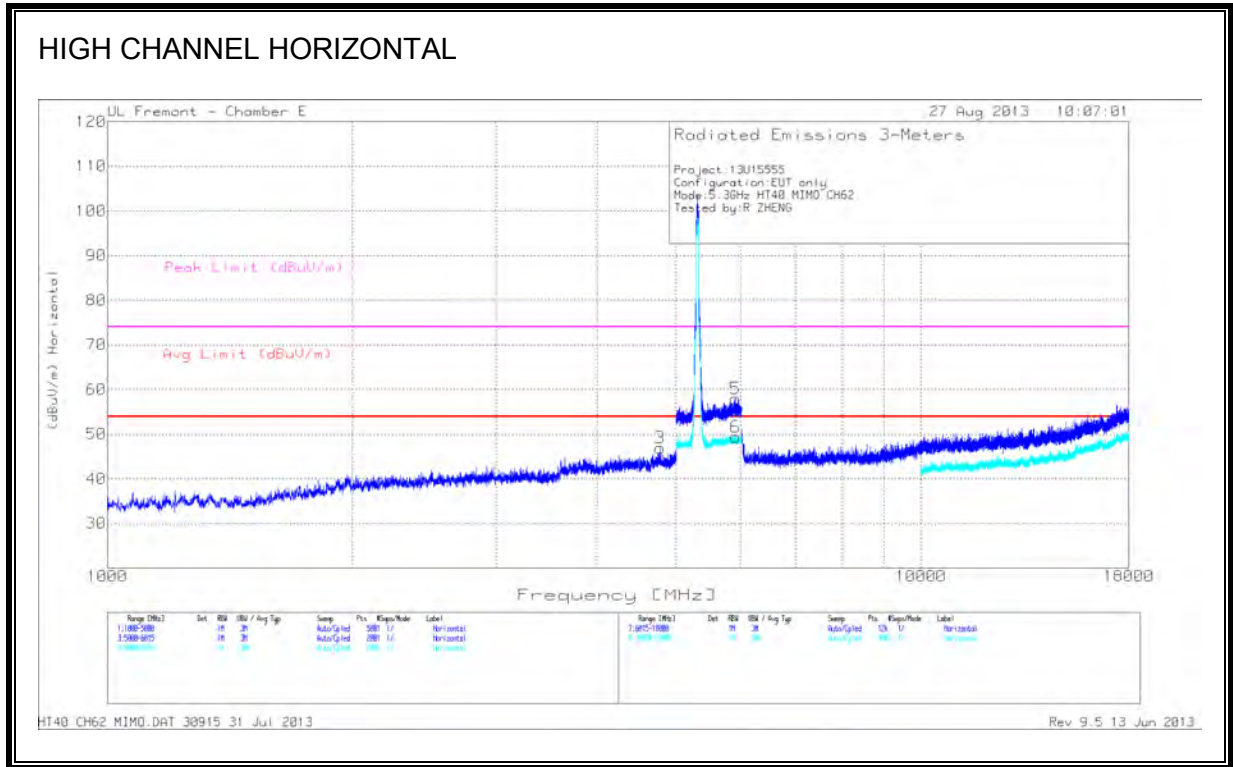

**DATA**

Marker	Frequenc y (GHz)	Meter Reading (dBuV)	Det	AF T346 (dB/m)	Amp/Cbl /5GHz LPF	DC Corr [dB]	Correcte d Reading (dBuV/m )	Avg Limit (dBuV/m )	Margin (dB)	Peak Limit (dBuV/m )	Margin (dB)	Height (cm)	Polarity
3	4.777	42.62	PK	34.4	-30.1	0	46.92	54	-7.08	74	-27.08	199	H
4	4.324	43	PK	34.1	-31	0	46.1	54	-7.9	74	-27.9	101	V

Marker	Frequenc y (GHz)	Meter Reading (dBuV)	Det	AF T346 (dB/m)	Amp/Cbl /10dB Pad	DC Corr [dB]	Correcte d Reading (dBuV/m )	Avg Limit (dBuV/m )	Margin (dB)	Peak Limit (dBuV/m )	Margin (dB)	Height (cm)	Polarity
*5	5.912	42.63	PK	35.7	-20.4	0	57.93			68.2	-10.27	199	H
*6	5.915	33.99	PK (VB)	35.7	-20.3	0	49.39			--	--	200	H
1	5.143	46.53	PK	34.6	-21.4	0	59.73	--	--	74	-14.27	199	V
2	5.143	39.51	PK	34.6	-21.4	0	52.71	54	-1.29	--	--	199	V

Notes: \* : Not in Restricted Band

PK: Peak detector

Horizontal 5000 - 6015MHz													
Test Frequency	Meter Reading (dBuV)	Detector	AF T346 (dB/m)	Amp/Cbl /10dB Pad	DC Corr [dB]	Corrected Reading (dBuV/m)	Avg Limit (dBuV/m)	Margin (dB)	Peak Limit (dBuV/m)	Margin (dB)	Azimuth [Degs]	Height [cm]	Polarity
5144.2095	32.57	Av	34.6	-21.4	0.1	45.87	53.97	-8.1	74	-28.13	360	166	H

Av - Average detector



**9.2.11. 802.11a SISO MODE IN THE 5.6 GHz BAND**

**RESTRICTED & AUTHORIZED BANDEDGE (LOW CHANNEL)**

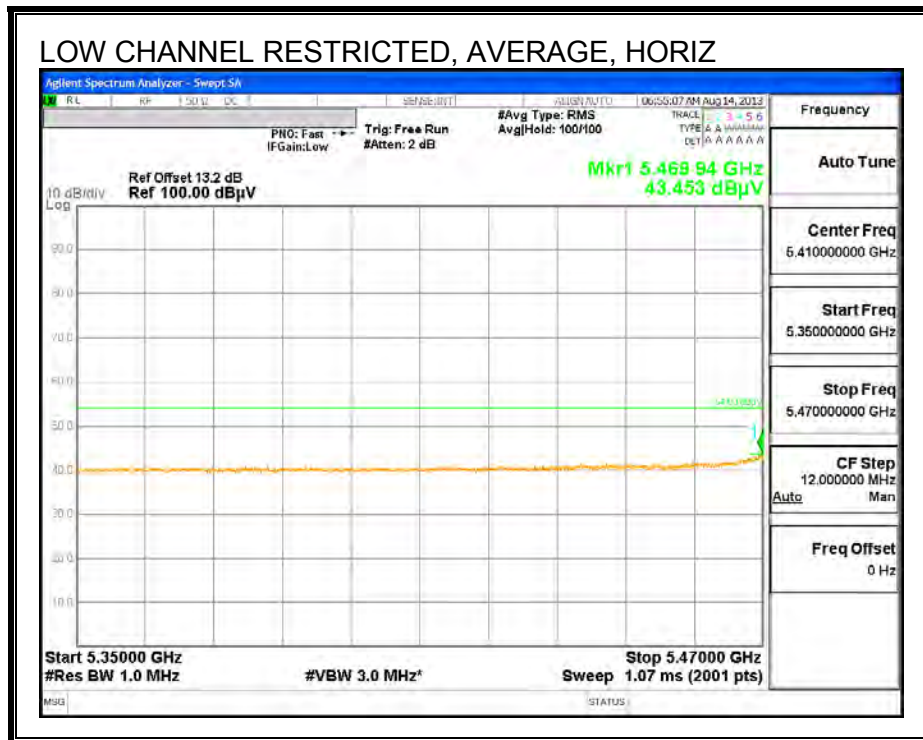
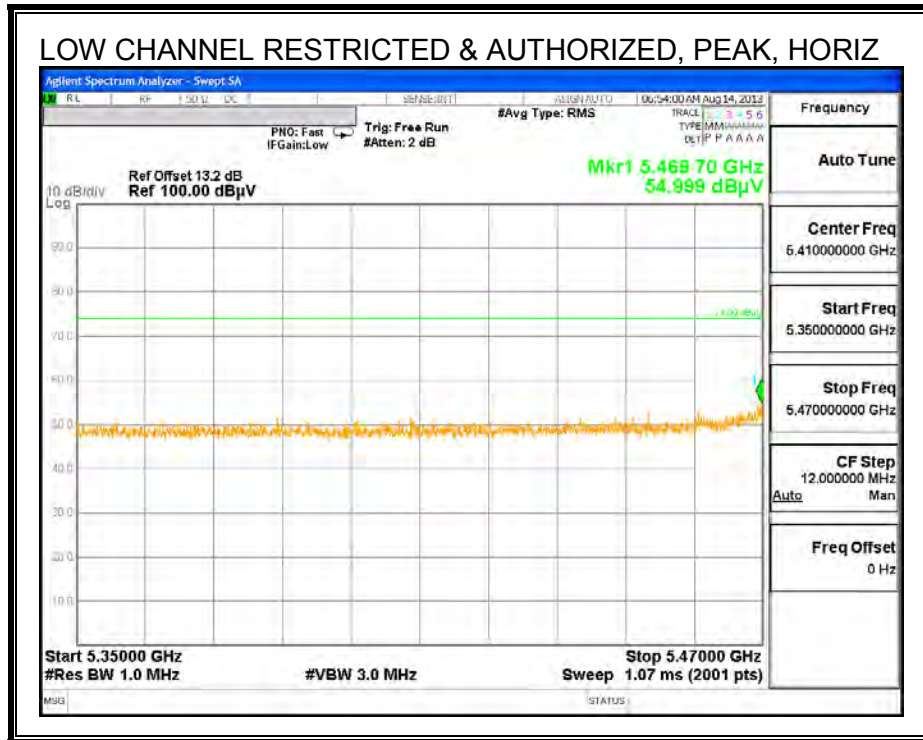

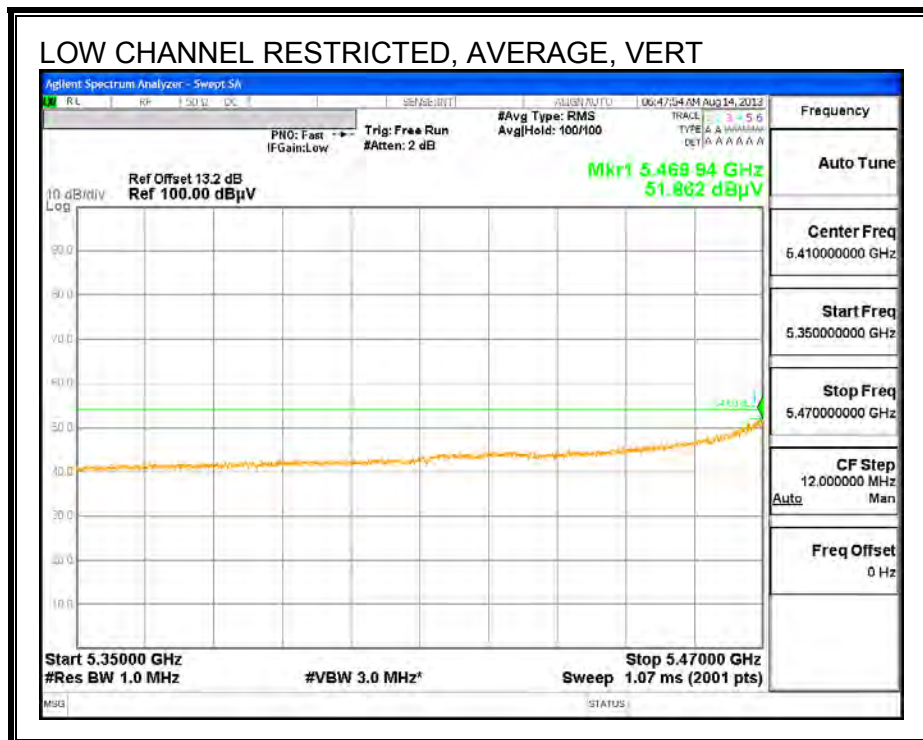
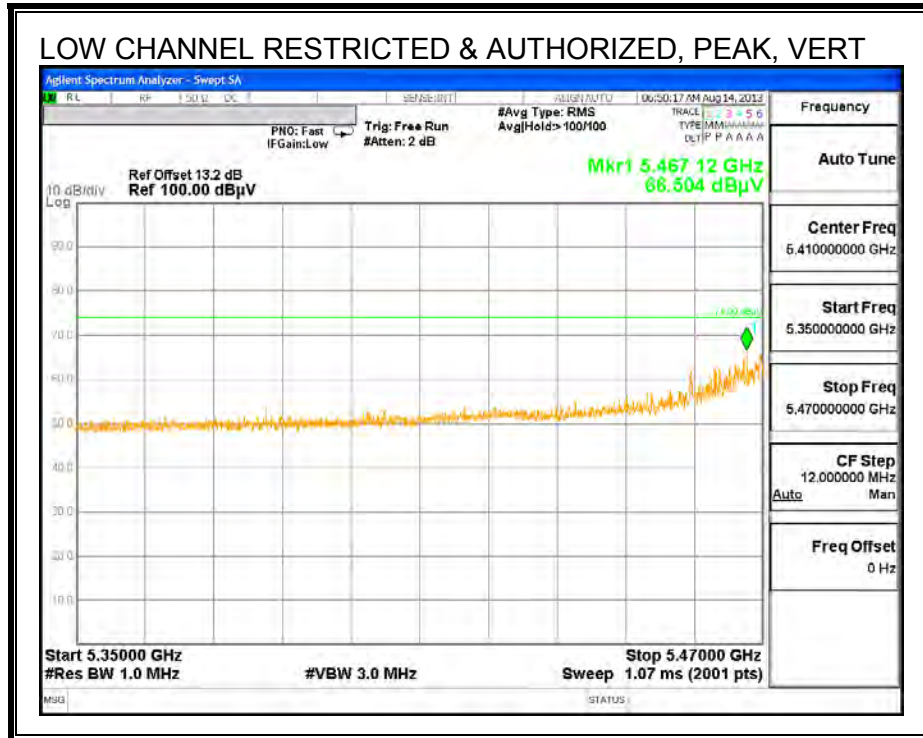

**AUTHORIZED BANDEDGE (HIGH CHANNEL)**

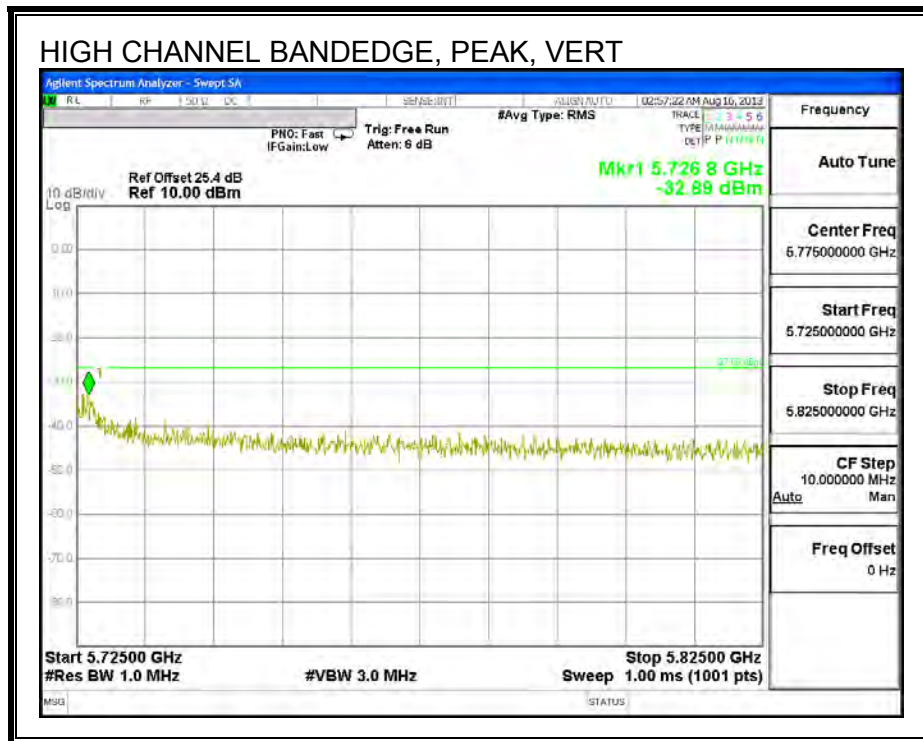
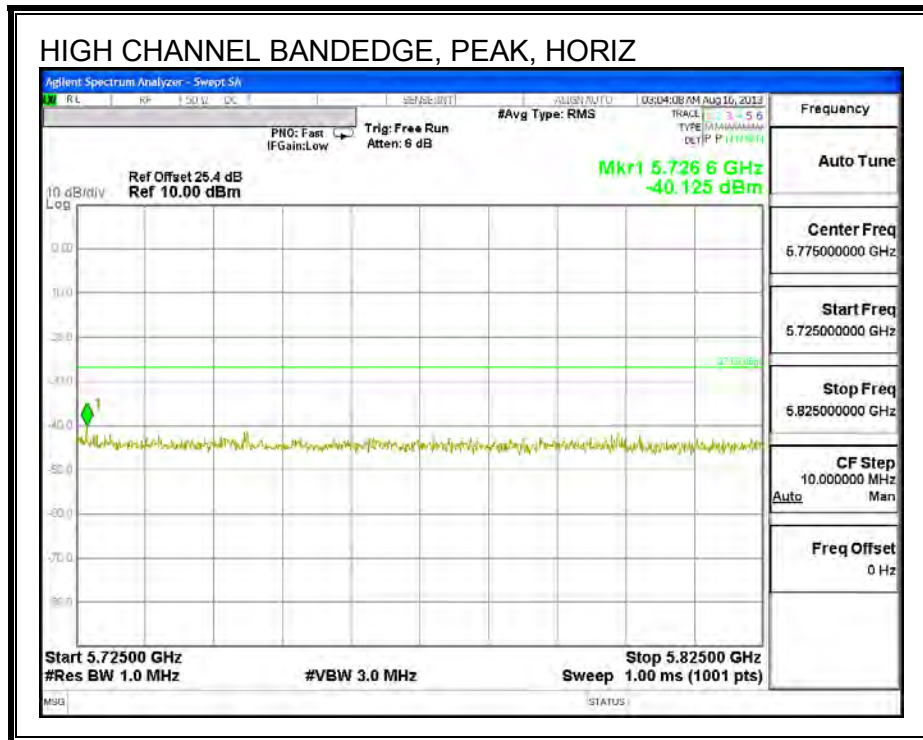

**HARMONICS AND SPURIOUS EMISSIONS**

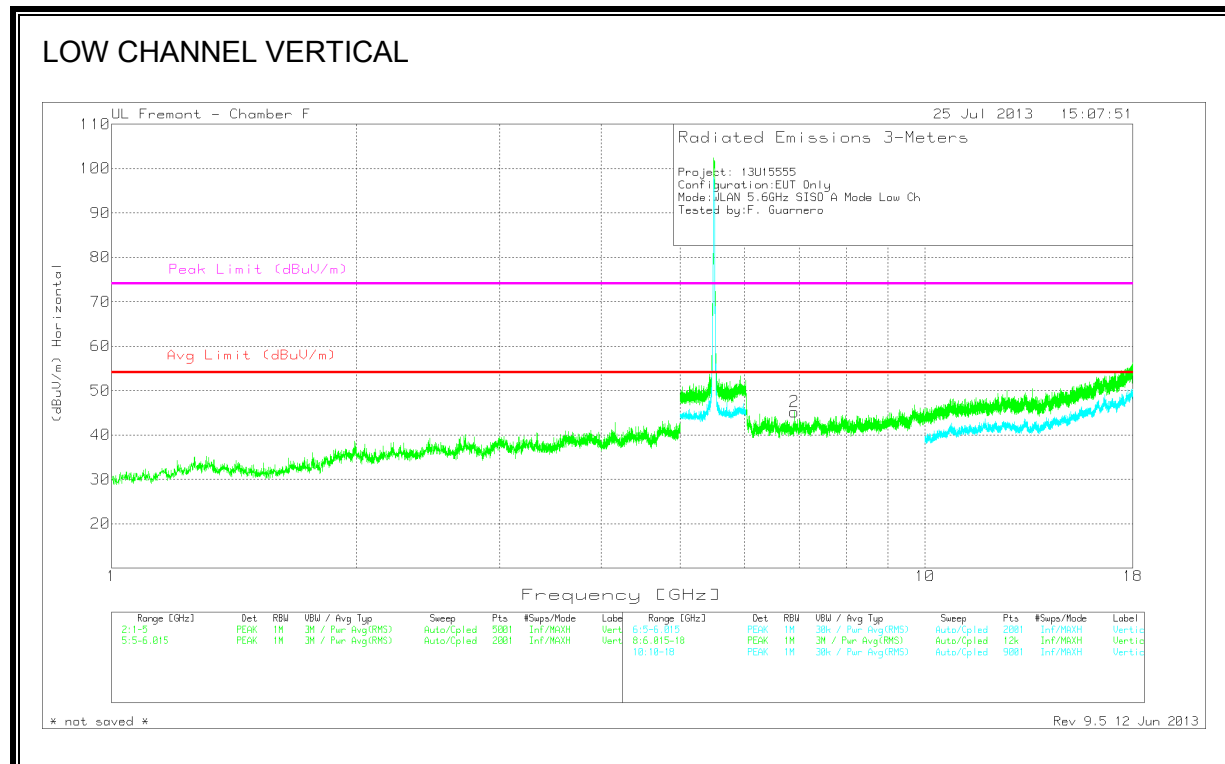
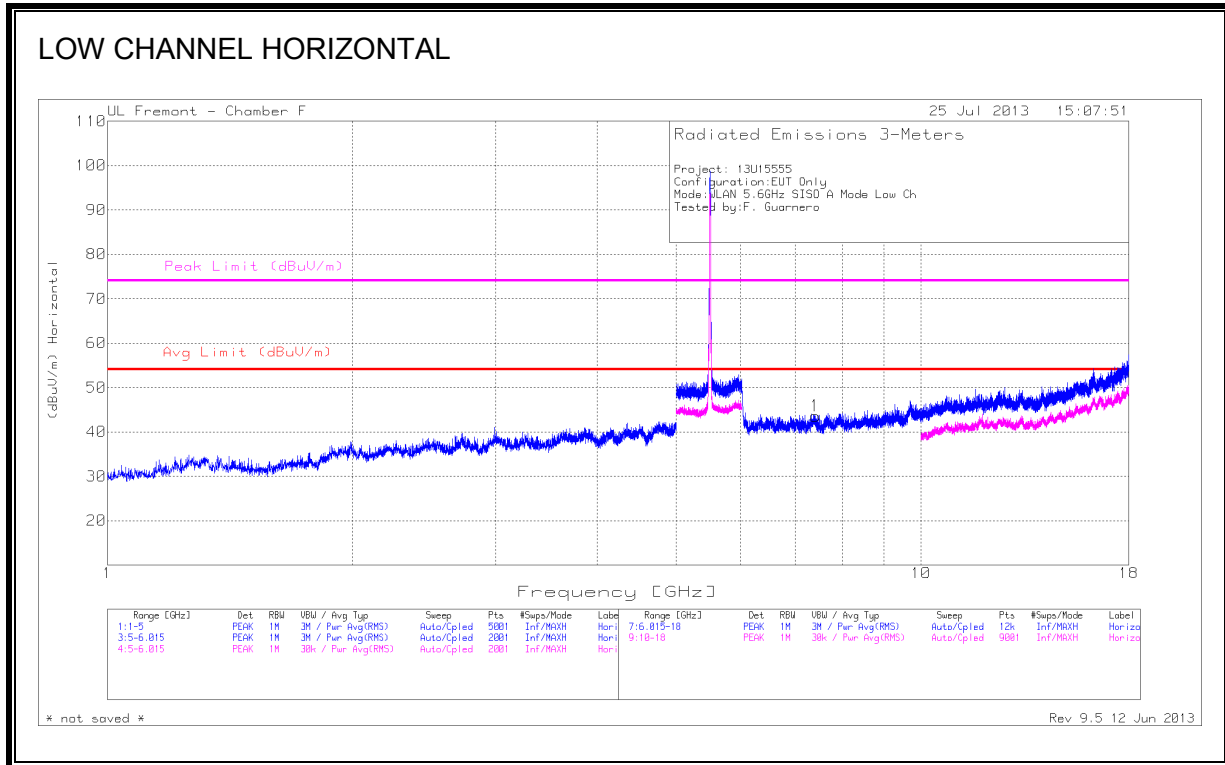

**DATA**

Marker	Frequency (GHz)	Meter Reading (dBuV)	Det	AF T120 (dB/m)	Amp/Cbl /Filtr/Pad (dB)	Corrected Reading (dBuV/m)	Avg Limit (dBuV/m)	Margin (dB)	Peak Limit (dBuV/m)	Margin (dB)	Azimuth (Degs)	Height (cm)	Polarity
1	7.415	37	PK	35.8	-29.2	43.6	53.97	-10.37	74	-30.4	0-360	201	H
2	6.905	39.31	PK	35.7	-29.8	45.21	53.97	-8.76	74	-28.79	0-360	199	V

PK - Peak detector

**HARMONICS AND SPURIOUS EMISSIONS**

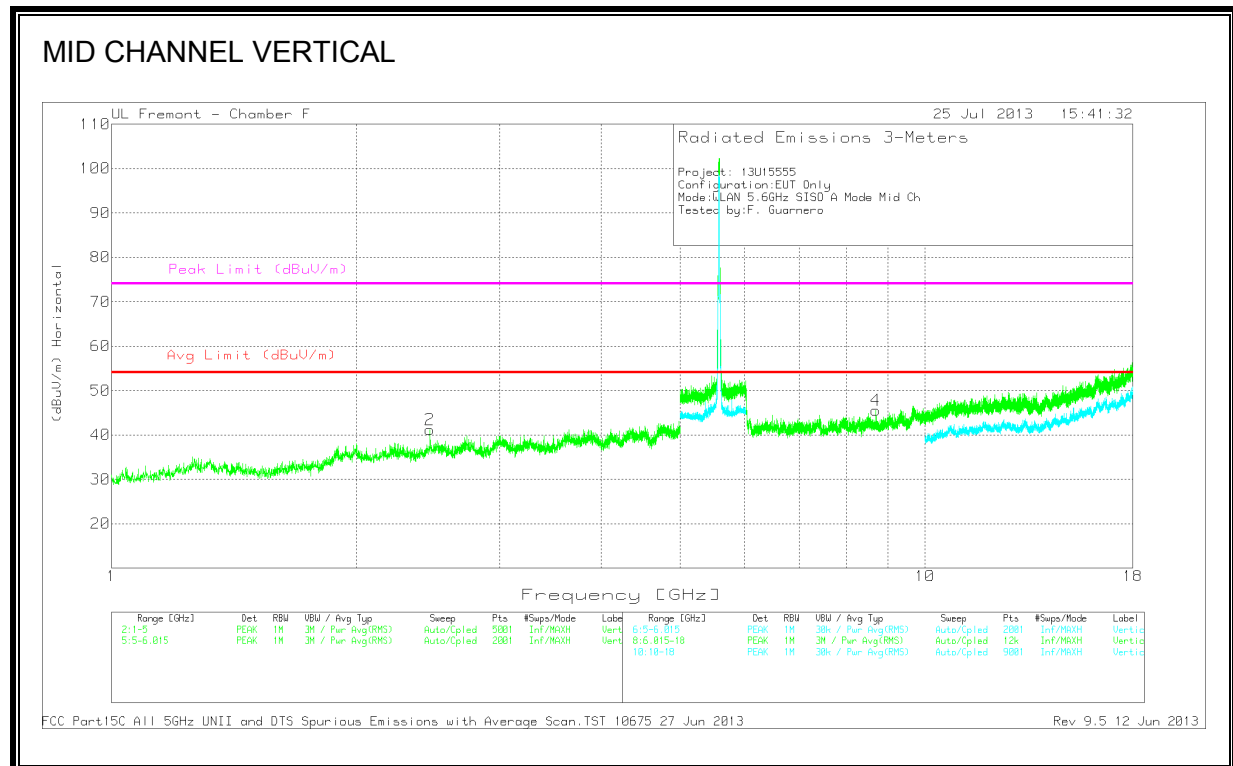
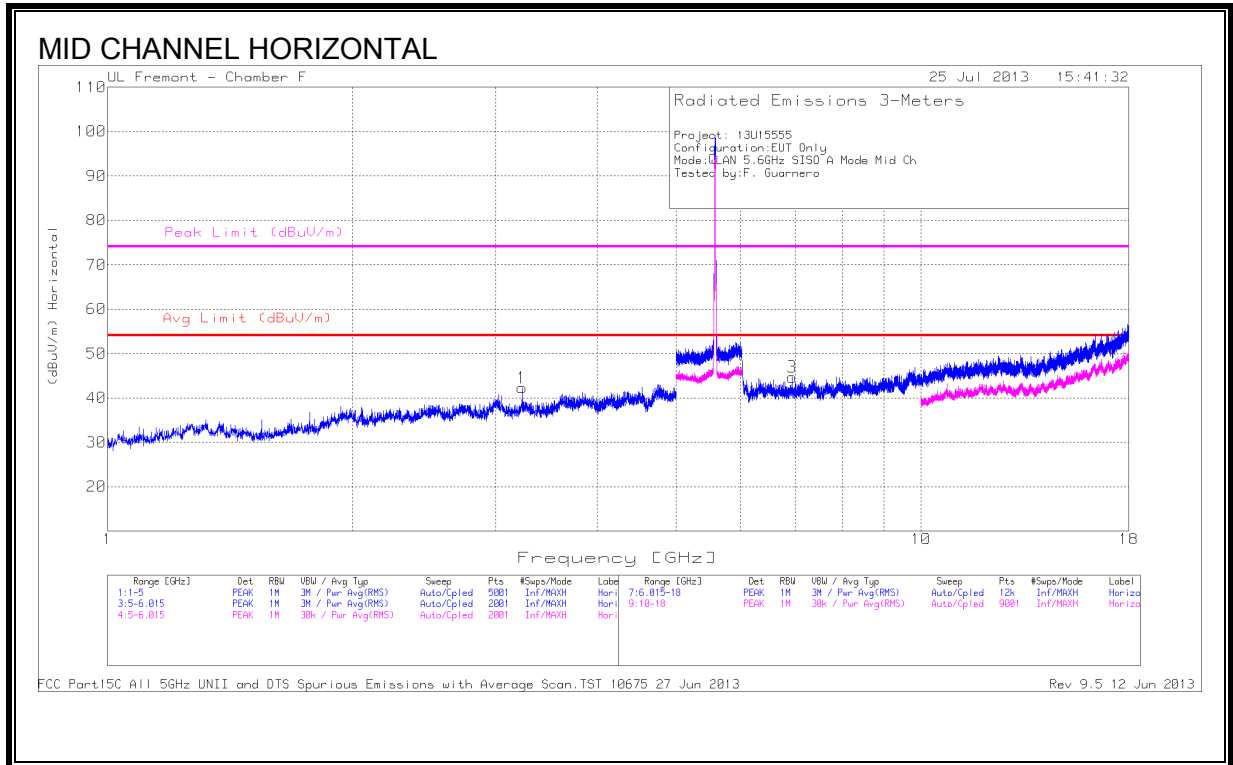

**DATA**

Marker	Frequency (GHz)	Meter Reading (dBuV)	Det	AF T120 (dB/m)	Amp/Cbl /Filtr/Pad (dB)	Corrected Reading (dBuV/m)	Avg Limit (dBuV/m)	Margin (dB)	Peak Limit (dBuV/m)	Margin (dB)	Azimuth (Degs)	Height (cm)	Polarity
1	3.233	41.8	PK	33.2	-32.7	42.3	53.97	-11.67	74	-31.7	0-360	98	H
2	2.462	42	PK	32.4	-33.2	41.2	53.97	-12.77	74	-32.8	0-360	101	V
3	6.942	38.37	PK	35.7	-29.4	44.67	53.97	-9.3	74	-29.33	0-360	199	H
4	8.693	36.66	PK	36.1	-27.2	45.56	53.97	-8.41	74	-28.44	0-360	201	V

PK - Peak detector

**HARMONICS AND SPURIOUS EMISSIONS**

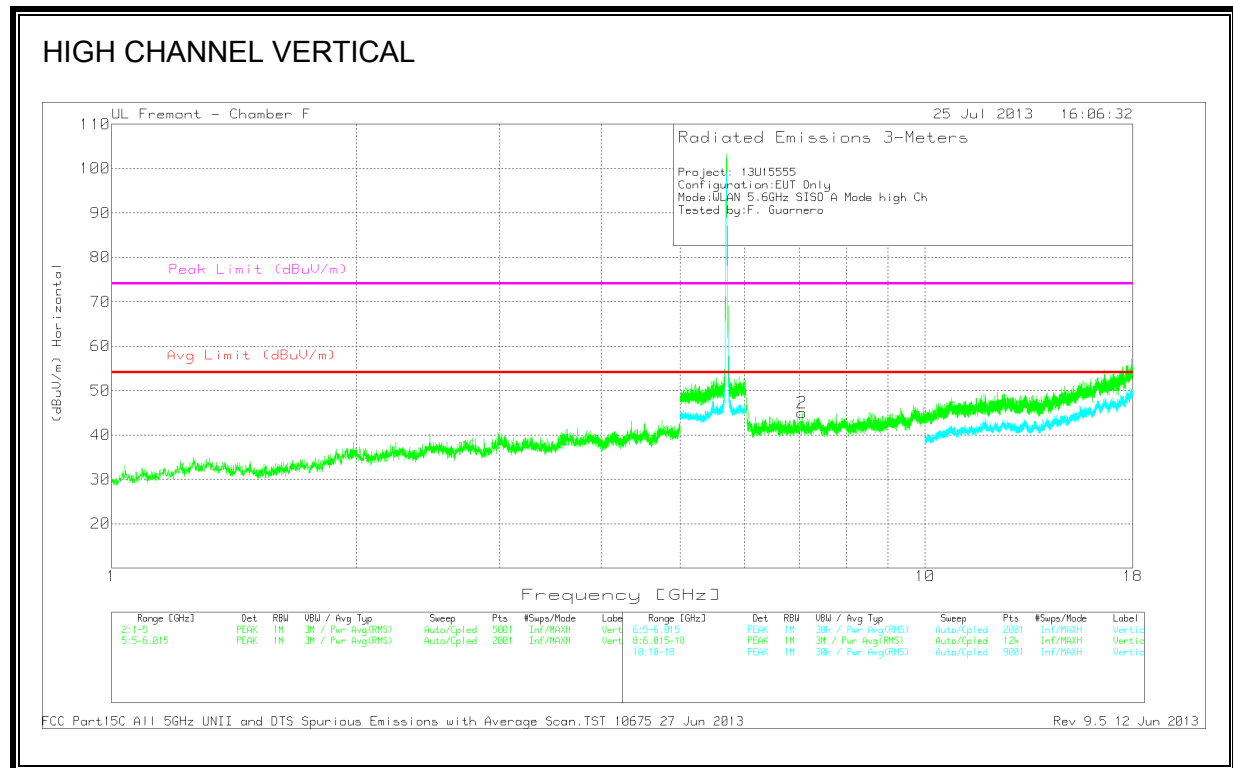
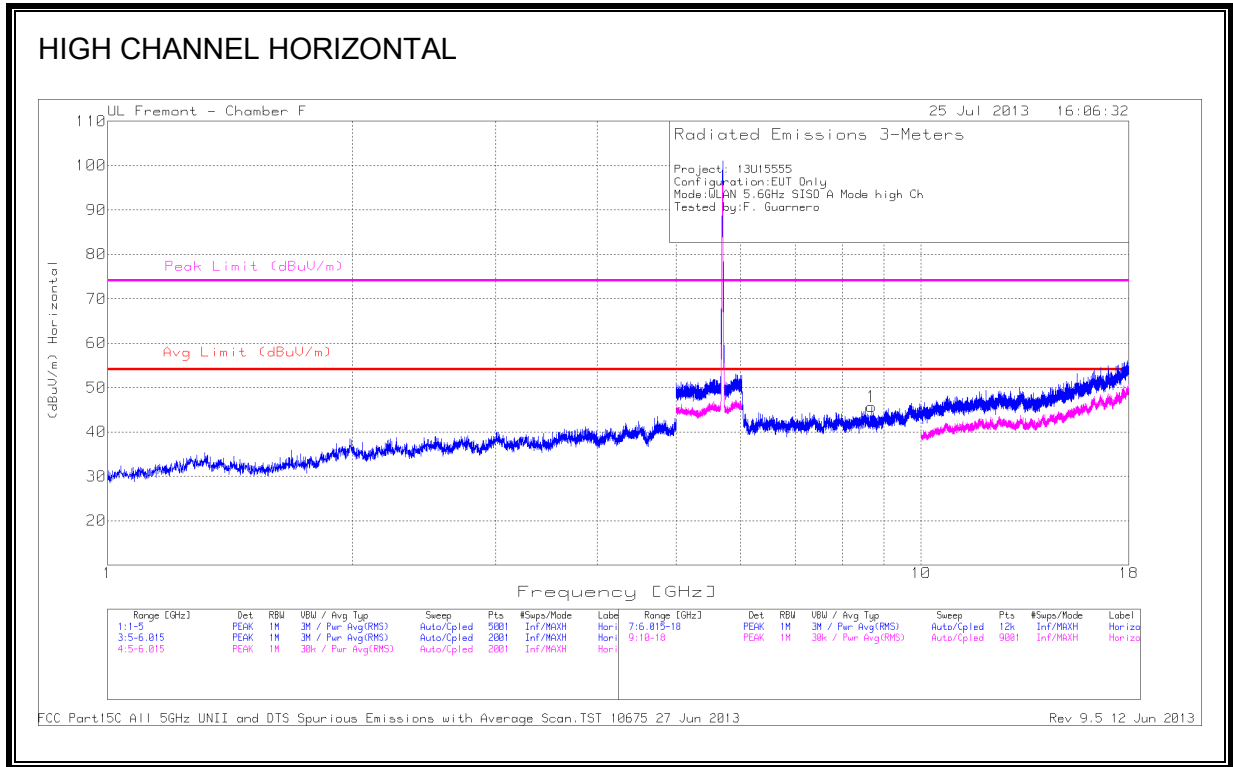



**DATA**

Marker	Frequency (GHz)	Meter Reading (dBuV)	Det	AF T120 (dB/m)	Amp/C bl/Filtr/ Pad (dB)	Corrected Reading (dBuV/m)	Avg Limit (dBuV/m)	Margin (dB)	Peak Limit (dBuV/m)	Margin (dB)	Azimuth (Degs)	Height (cm)	Polarity
1	8.689	36.88	PK	36.1	-27.3	45.68	53.97	-8.29	74	-28.32	0-360	100	H
2	7.06	38.41	PK	35.7	-29.1	45.01	53.97	-8.96	74	-28.99	0-360	100	V

PK - Peak detector

**9.2.12. 802.11n HT20 2TX CDD MODE IN THE 5.6 GHz BAND**

**RESTRICTED & AUTHORIZED BANDEDGE (LOW CHANNEL)**

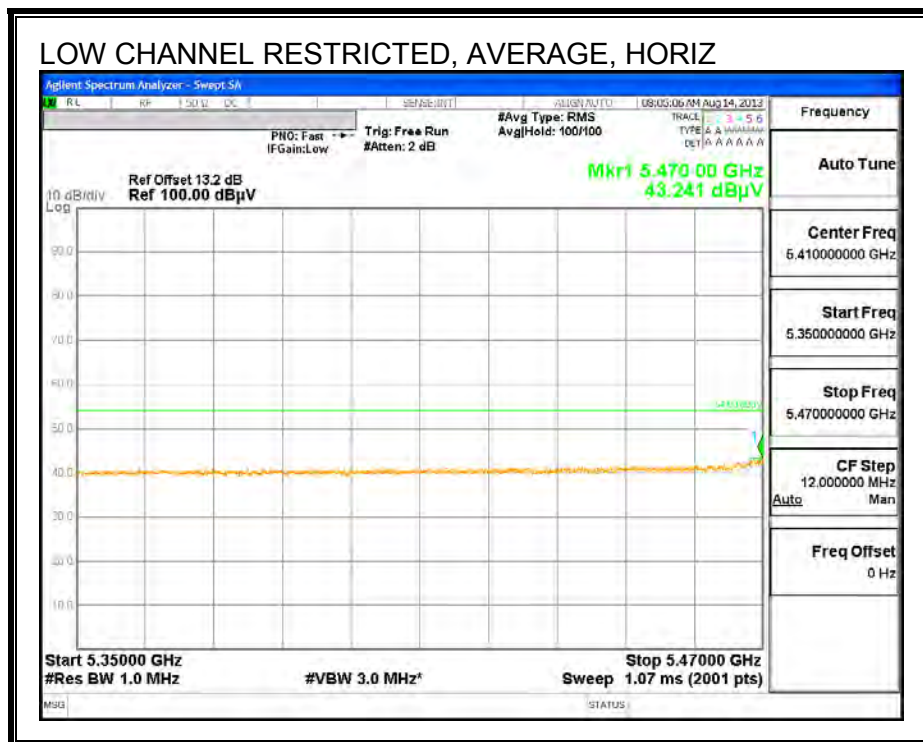
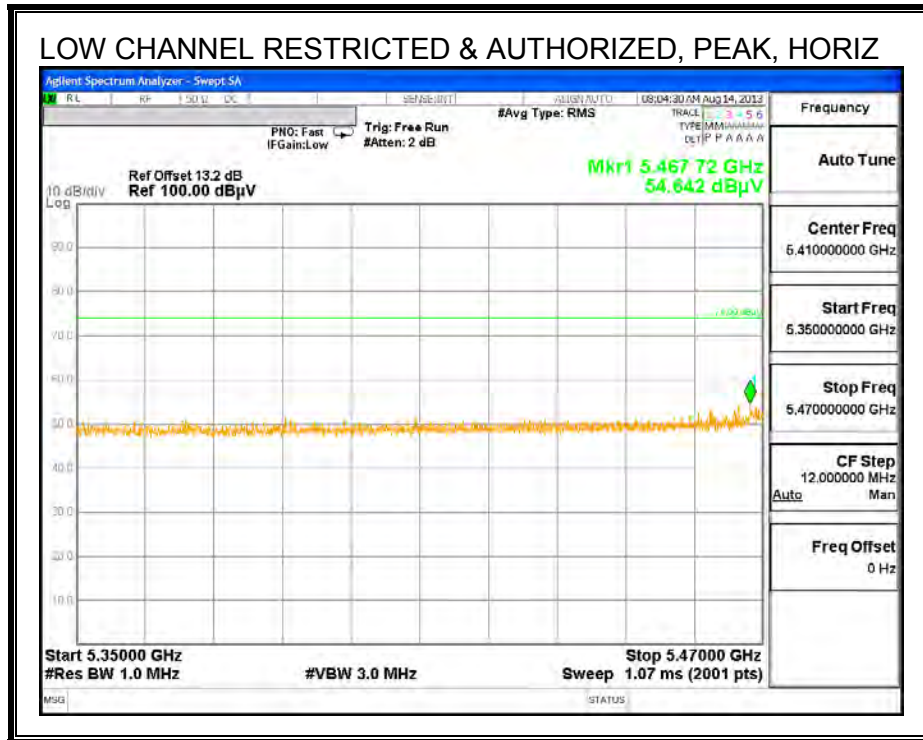

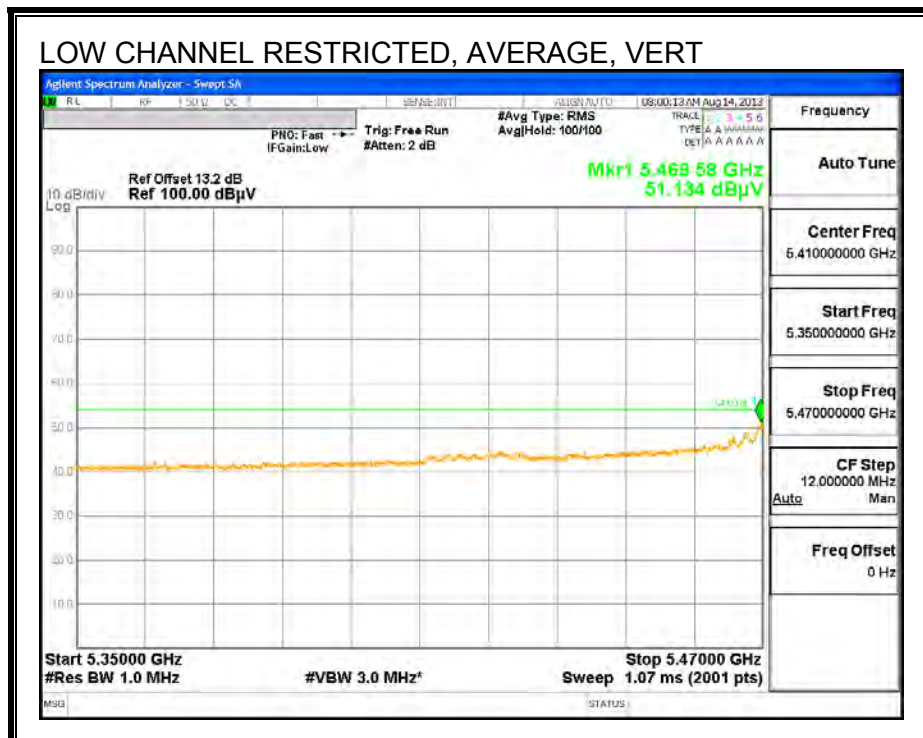
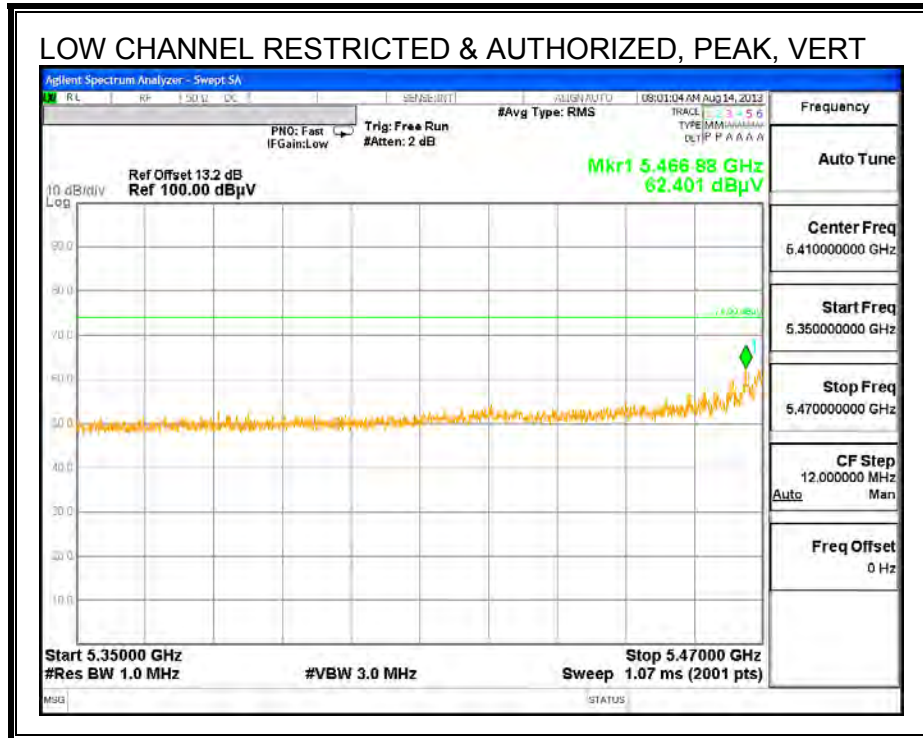

**AUTHORIZED BANDEDGE (HIGH CHANNEL)**

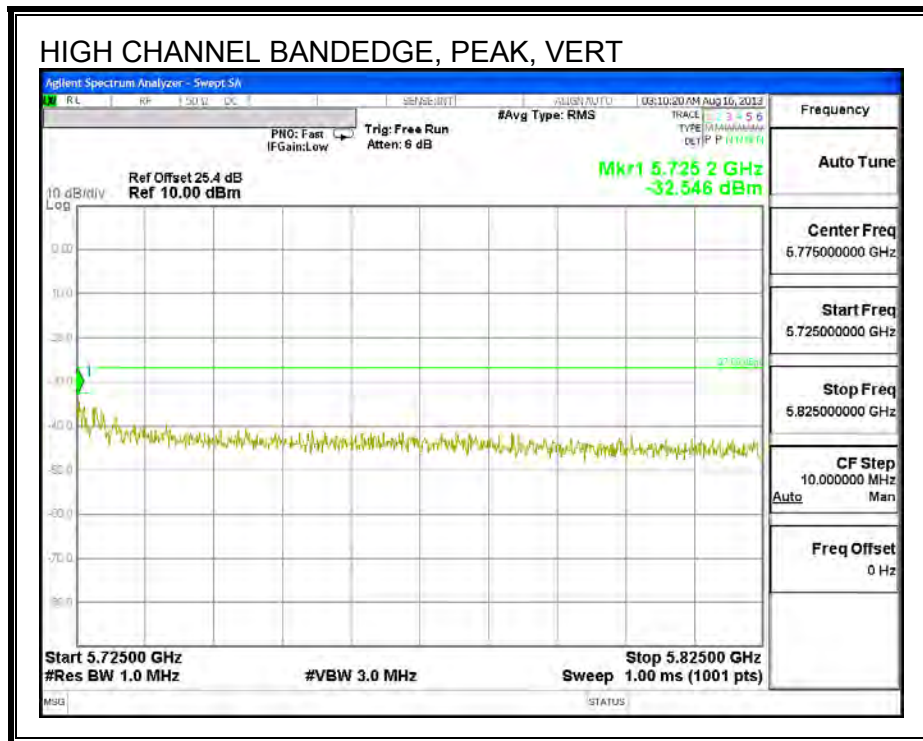
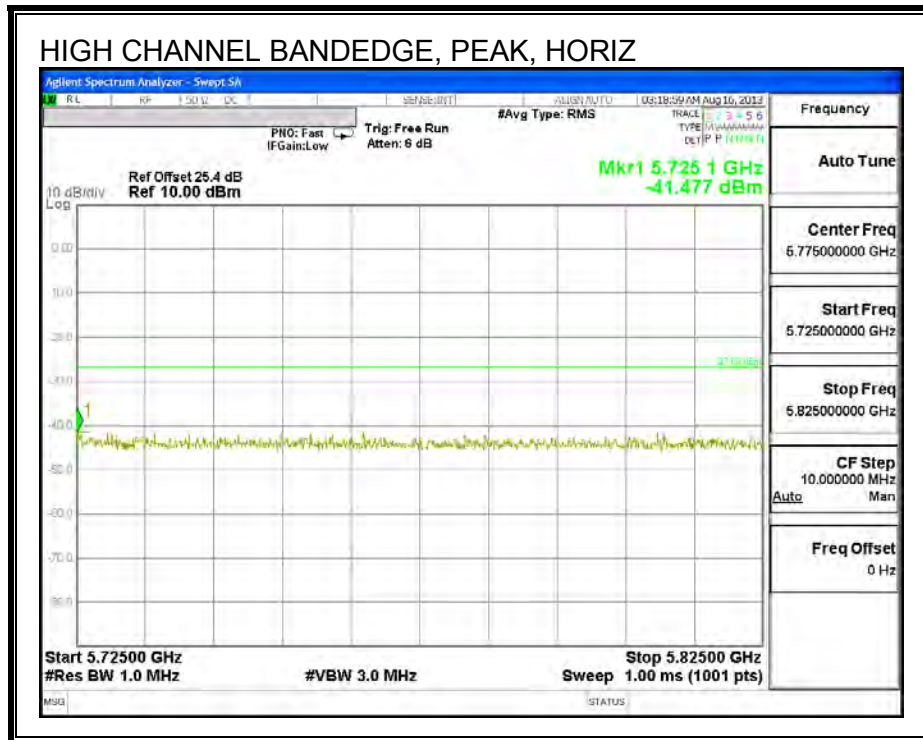

**HARMONICS AND SPURIOUS EMISSIONS**

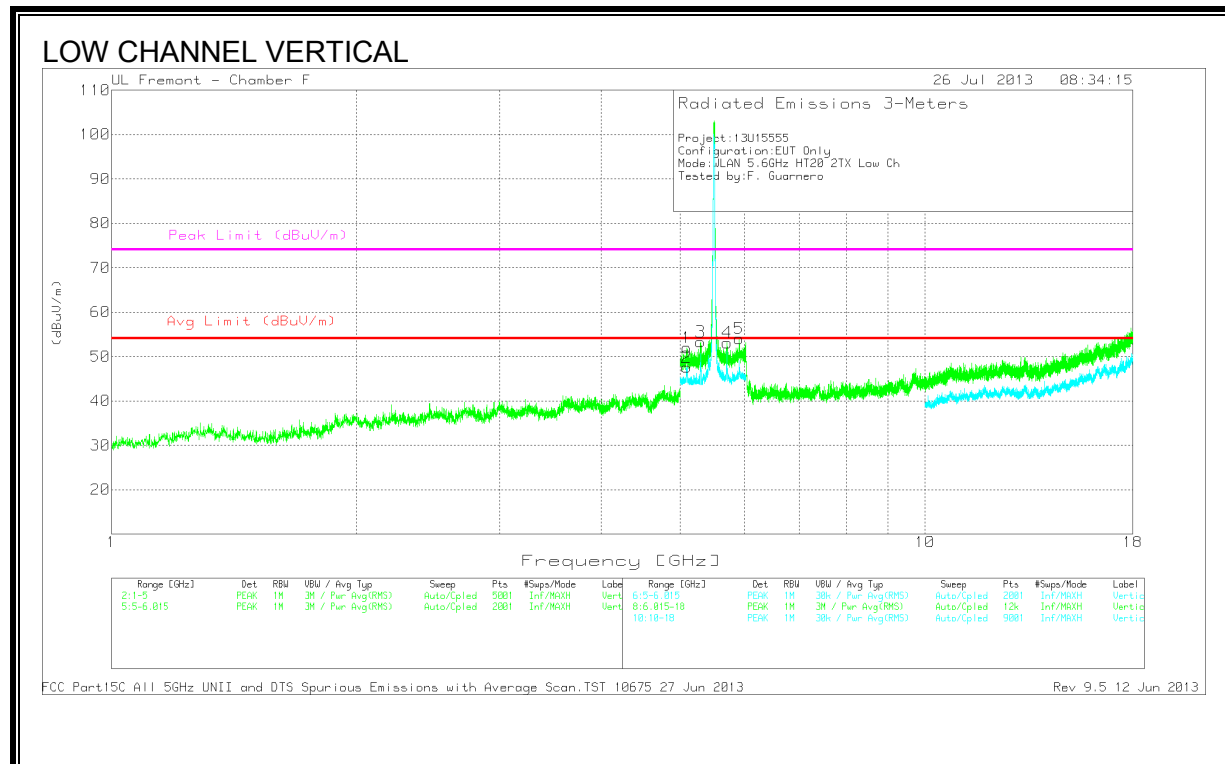
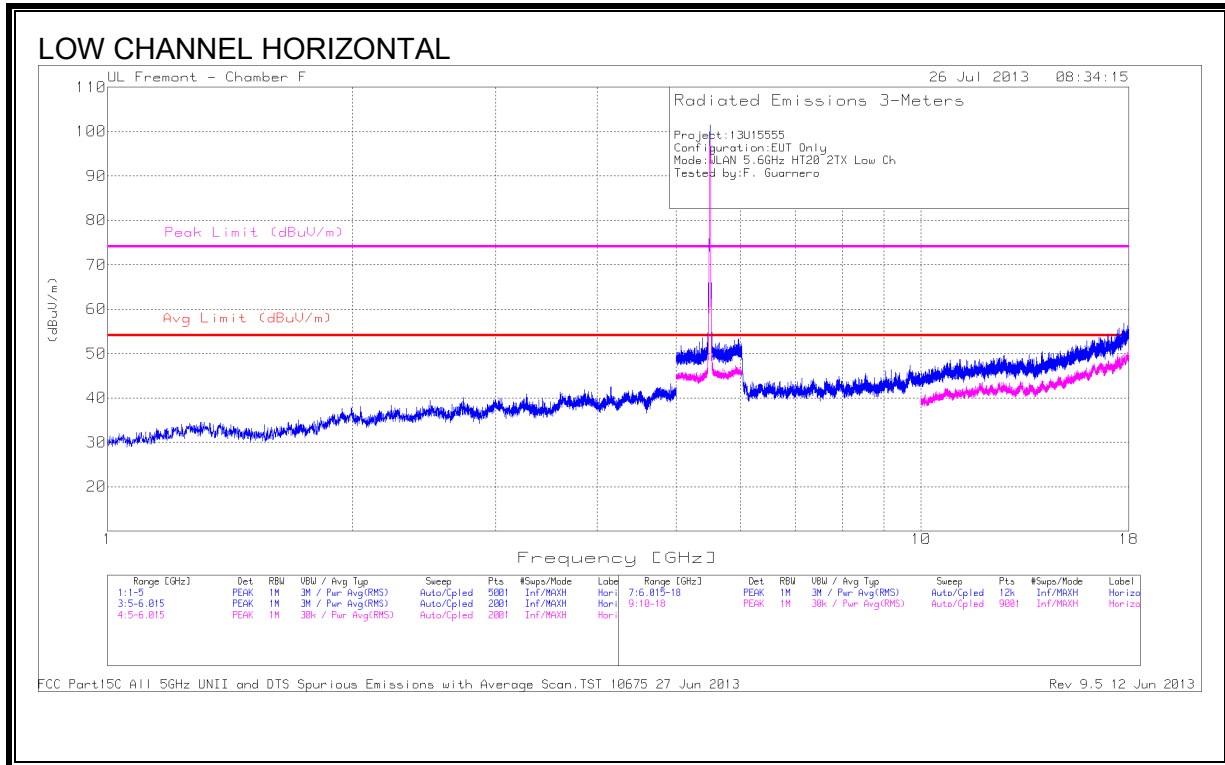

**DATA**

Marker	Frequency (GHz)	Meter Reading (dBuV)	Det	AF T120 (dB/m)	Amp/Cbl/ Filtr/Pad (dB)	Corrected Reading (dBuV/m)	Avg Limit (dBuV/m)	Margin (dB)	Peak Limit (dBuV/m)	Margin (dB)	Azimuth (Degs)	Height (cm)	Polarity
1	5.094	39.6	PK	34.2	-21.8	52	--	--	74	-22	0-360	200	V
2	5.092	35.26	PK (VB)	34.1	-21.8	47.56	53.97	-6.41	--	--	0-360	199	V
*3	5.296	40.78	PK	34.4	-21.9	53.28			68.2	-14.92	0-360	101	V
*4	5.711	39.93	PK	34.9	-21.7	53.13			68.2	-15.07	0-360	200	V
*5	5.909	39.64	PK	35.2	-20.8	54.04			68.2	-14.16	0-360	200	V

Note: \* : Not in restricted band

PK: Peak detector

**HARMONICS AND SPURIOUS EMISSIONS**

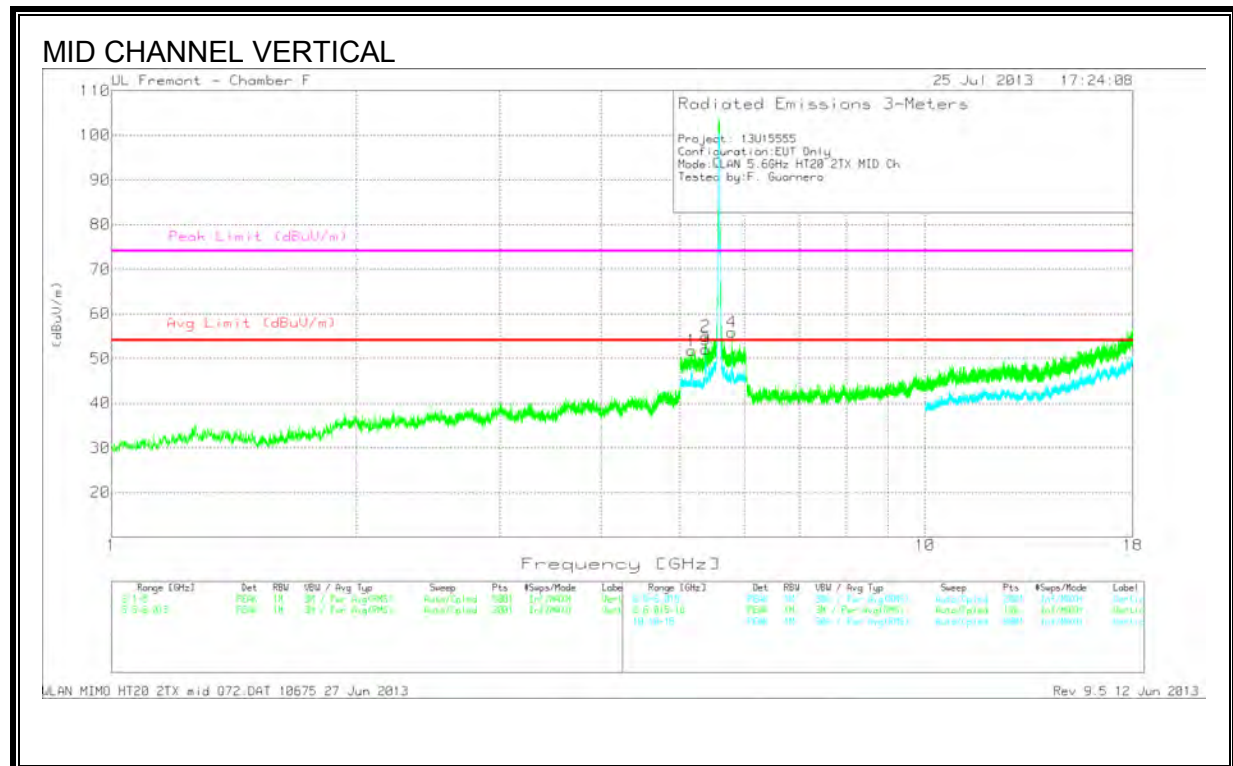
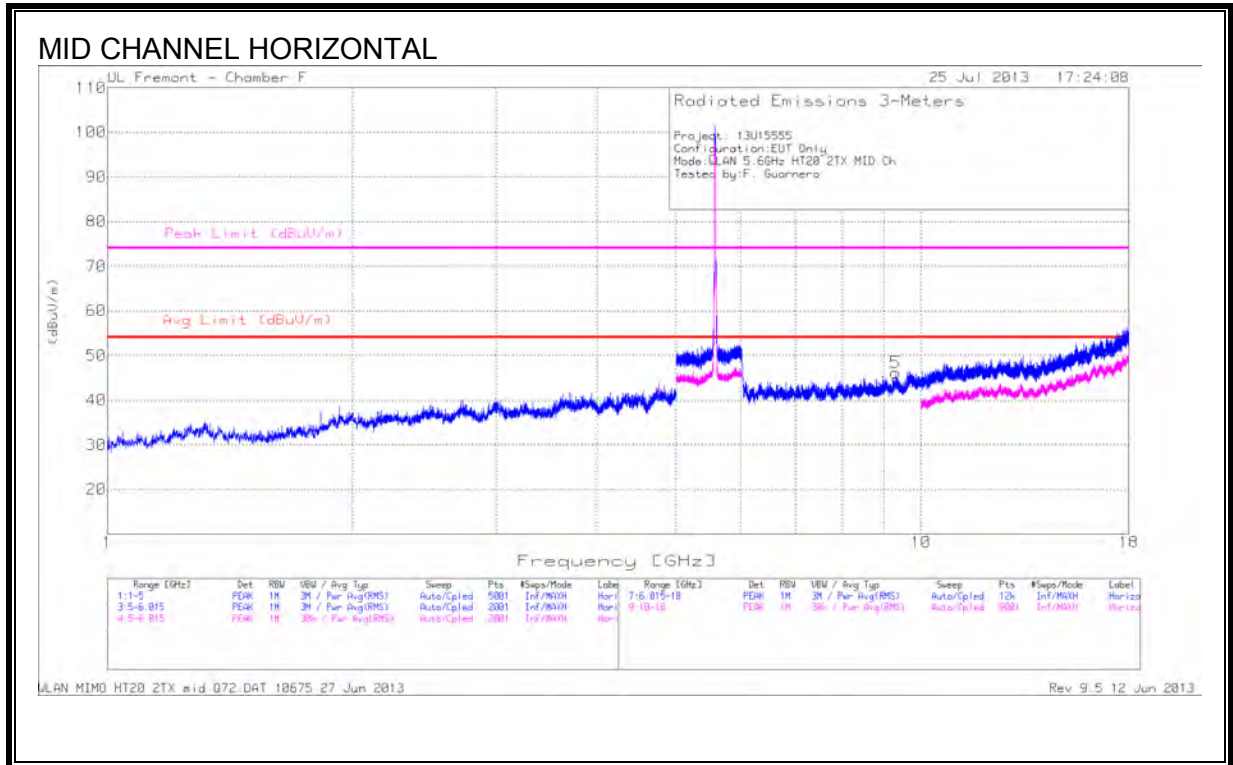

**DATA**

Marker	Frequency (GHz)	Meter Reading (dBuV)	Det	AF T120 (dB/m)	Amp/Cbl /Filtr/Pad (dB)	Corrected Reading (dBuV/m)	Avg Limit (dBuV/m)	Margin (dB)	Peak Limit (dBuV/m)	Margin (dB)	Azimuth (Degs)	Height (cm)	Polarity
*1	5.167	39.12	PK	34.3	-21.6	51.82			68.2	-16.38	0-360	100	V
2	5.373	42.45	PK	34.6	-22.1	54.95	--	--	74	-19.05	0-360	199	V
3	5.373	39.56	PK (VB)	34.6	-22.1	52.06	53.97	-1.91	--	--	0-360	200	V
*4	5.788	42.73	PK	35	-21.8	55.93			68.2	-12.27	0-360	199	V
5	9.309	35.57	PK	36.7	-26.1	46.17	53.97	-7.8	74	-27.83	0-360	100	H

Note: \* : Not in restricted band

PK: Peak detector

Frequency (GHz)	Meter Reading (dBuV)	Det	AF T120 (dB/m)	Amp/Cbl/ Filtr/Pad (dB)	Corrected Reading (dBuV/m)	Avg Limit (dBuV/m)	Margin (dB)	Peak Limit (dBuV/m)	Margin (dB)	Azimuth (Degs)	Height (cm)	Polarity
5.373	37.41	Av	34.6	-22.1	49.91	53.97	-4.06	74	-24.09	307	164	V

Av - average detection



**HARMONICS AND SPURIOUS EMISSIONS**

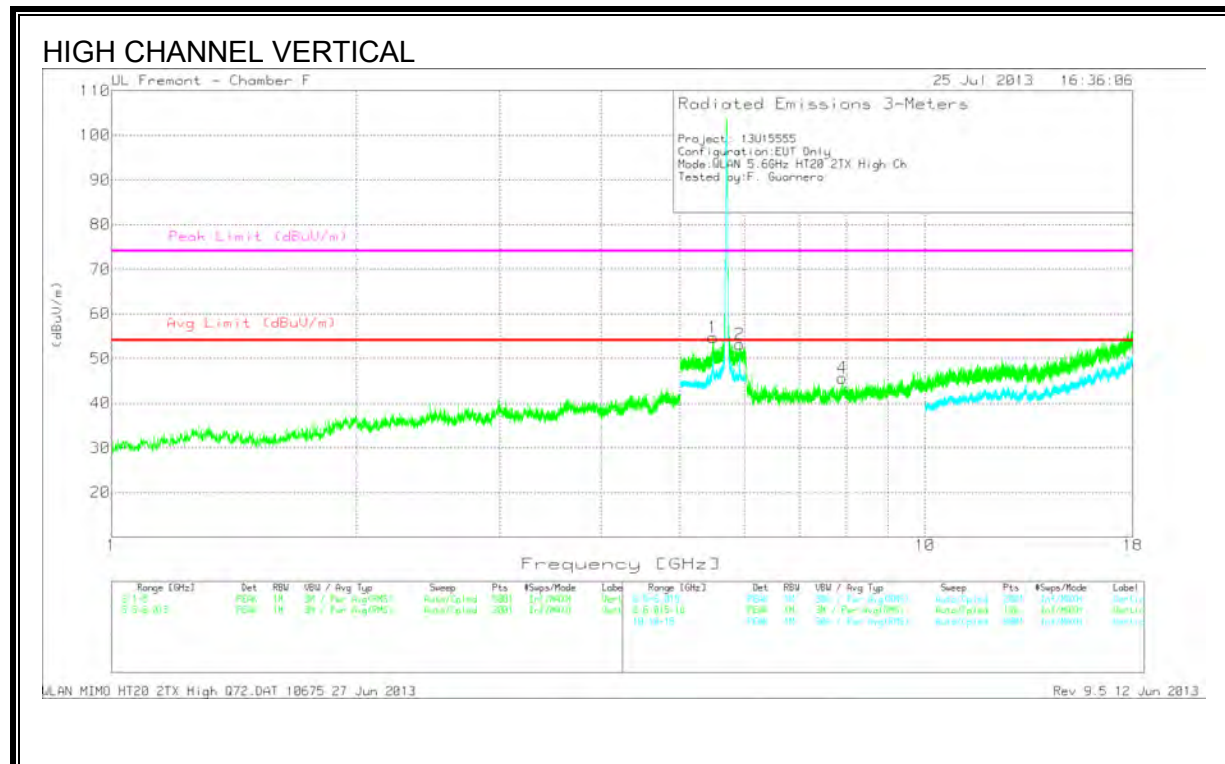
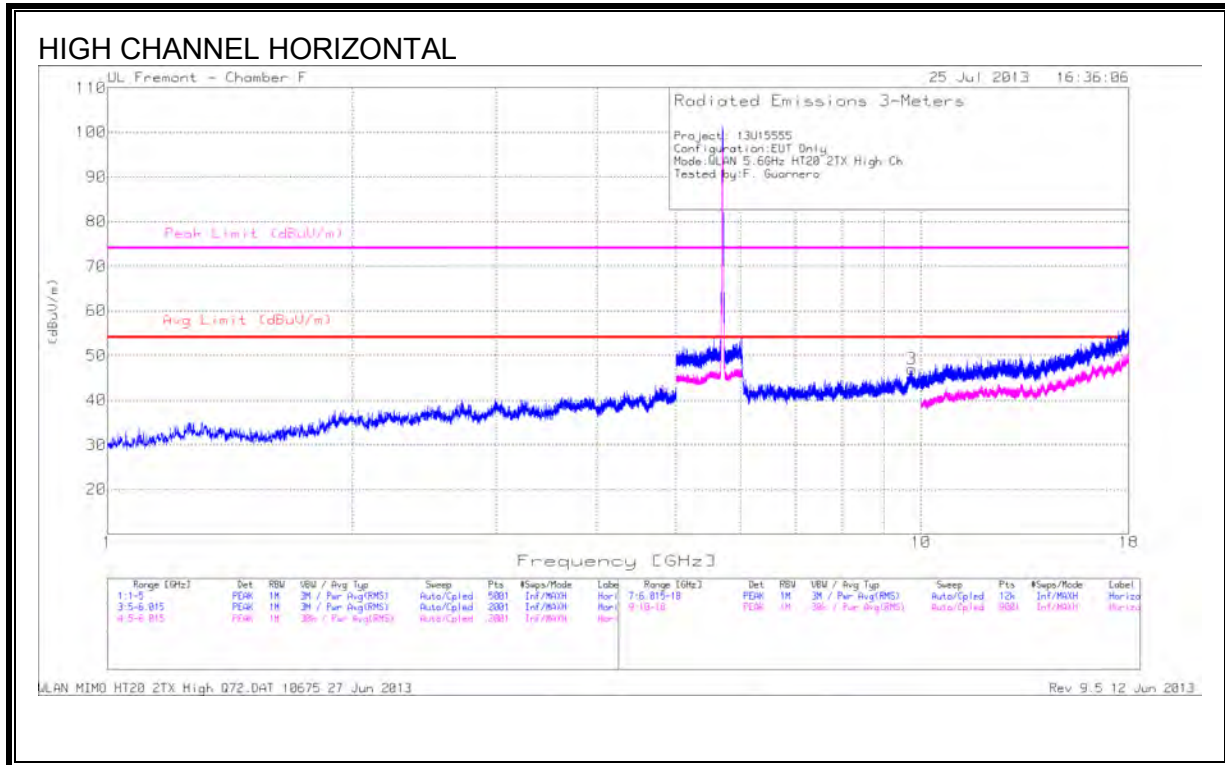

**DATA**

Marker	Frequency (GHz)	Meter Reading (dBuV)	Det	AF T120 (dB/m)	Amp/Cbl /Filtr/Pad (dB)	Corrected Reading (dBuV/m)	Avg Limit (dBuV/m)	Margin (dB)	Peak Limit (dBuV/m)	Margin (dB)	Azimuth (Degs)	Height (cm)	Polarity
*1	5.49	41.74	PK	34.7	-21.7	54.74	--	--	68.2	-13.46	0-360	199	V
*2	5.915	38.93	PK	35.2	-20.9	53.23	--	--	68.2	-21	0-360	100	V
3	9.738	35.29	PK	37.4	-25.7	46.99	53.97	-6.98	74	-27.01	0-360	199	H
4	7.913	37.93	PK	35.9	-28.2	45.63	53.97	-8.34	74	-28.37	0-360	201	V

Note: \* : Not in restricted band

PK: Peak detector

---

**9.2.13. 802.11n HT20 2TX STBC MODE IN THE 5.6 GHz BAND**

Covered by testing 11n HT20 CDD 2TX, total power across the two chains is higher than the power level the device will operate at

**9.2.14. 802.11n HT40 SISO MODE IN THE 5.6 GHz BAND**

**RESTRICTED & AUTHORIZED BANDEDGE (LOW CHANNEL)**

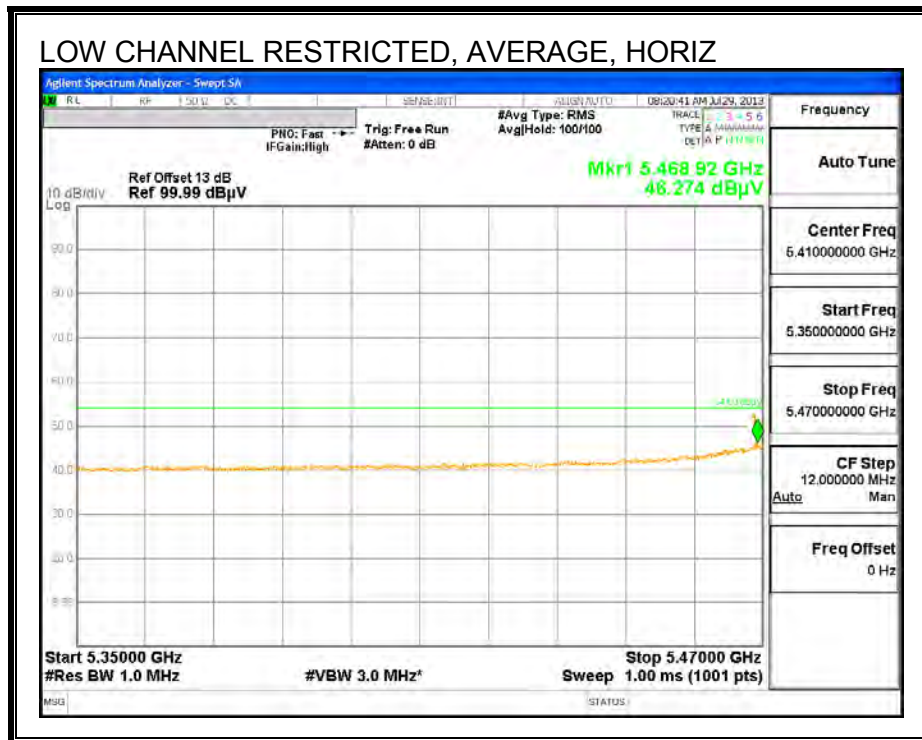
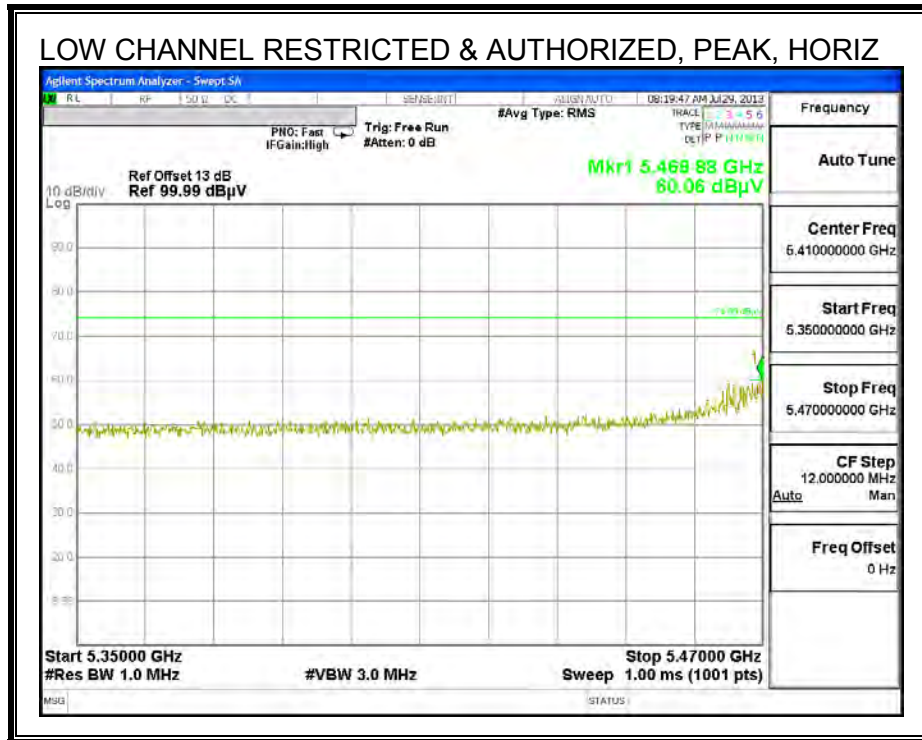

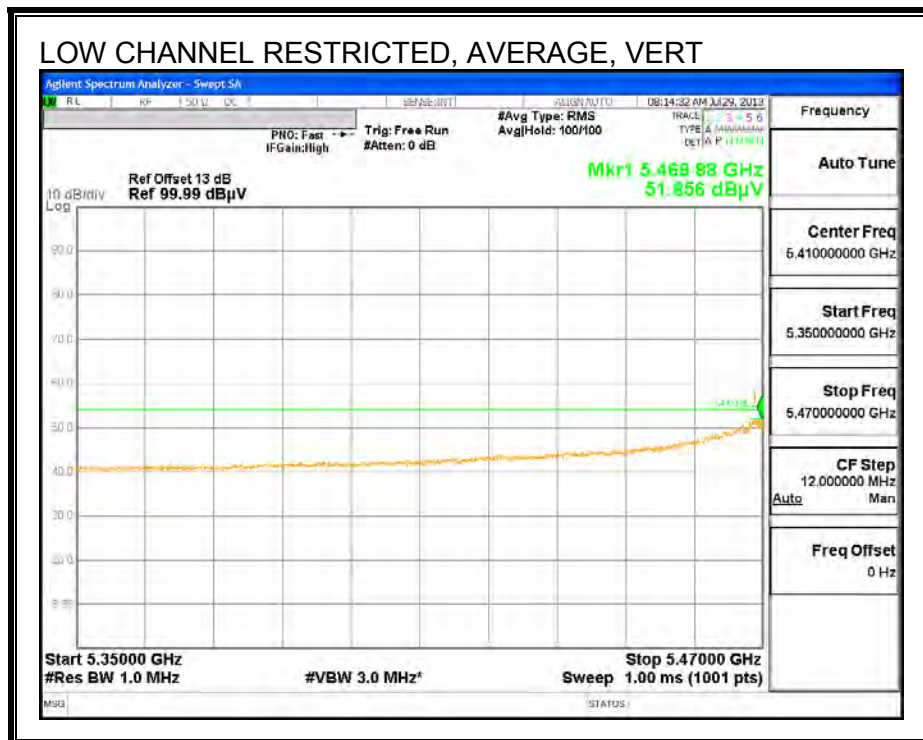
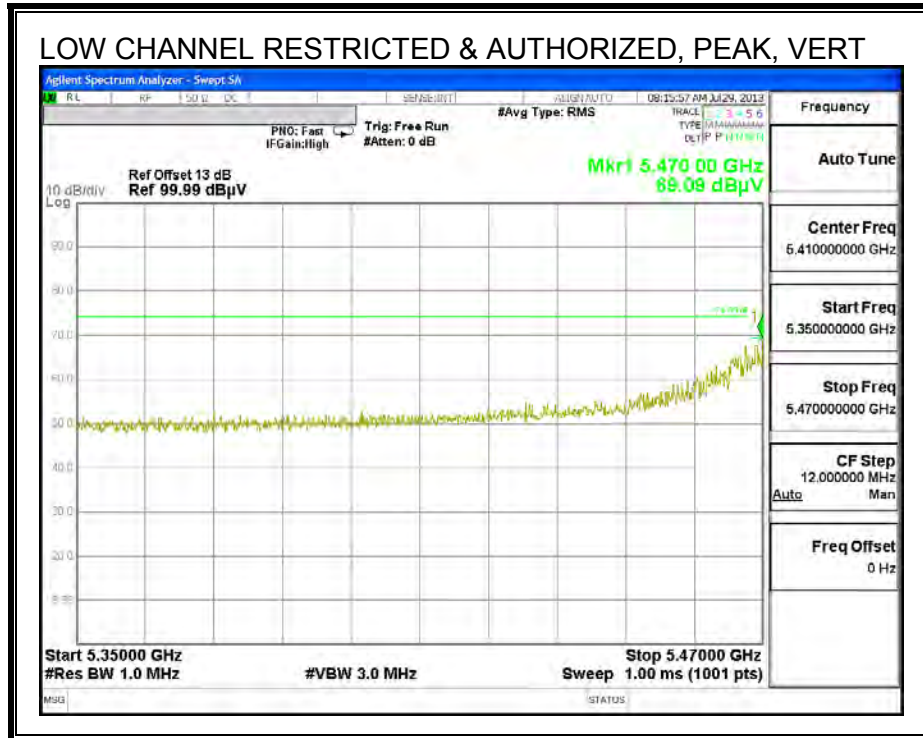

**AUTHORIZED BANDEDGE (HIGH CHANNEL)**

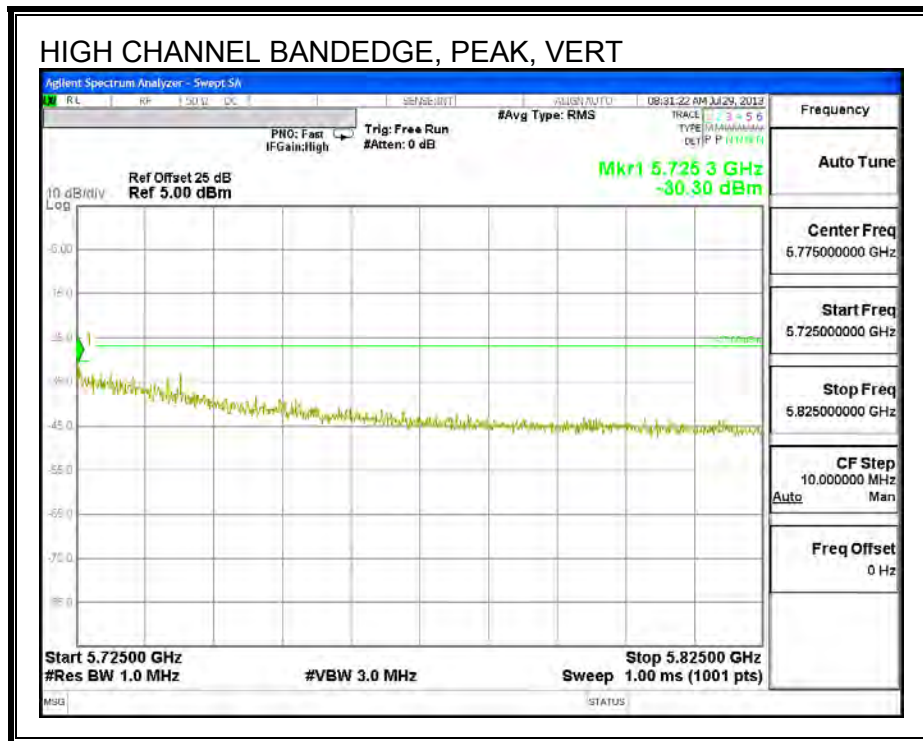
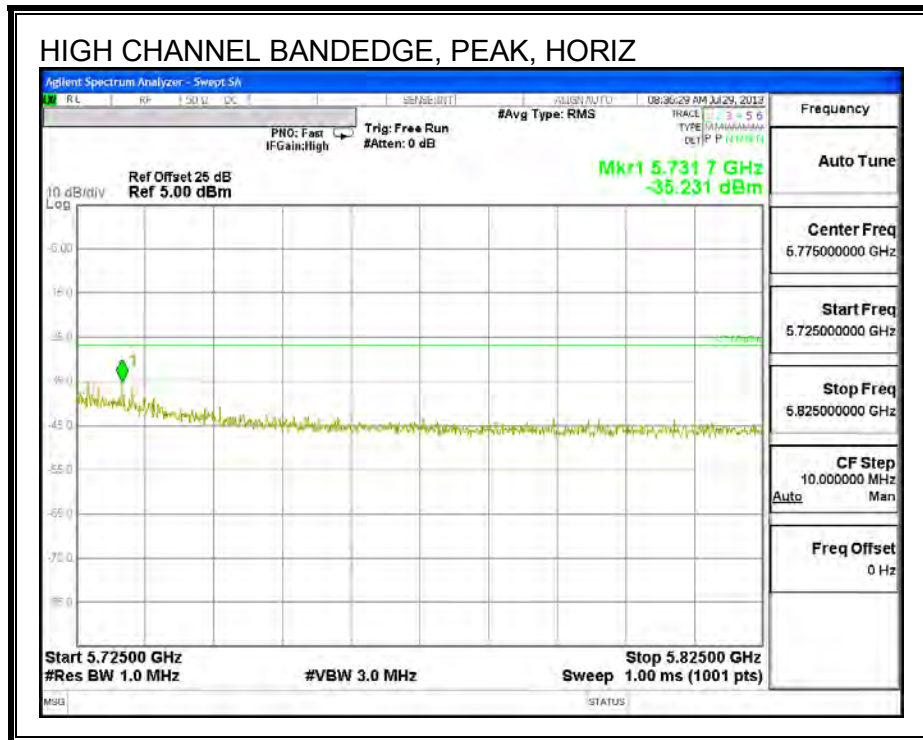

**HARMONICS AND SPURIOUS EMISSIONS**

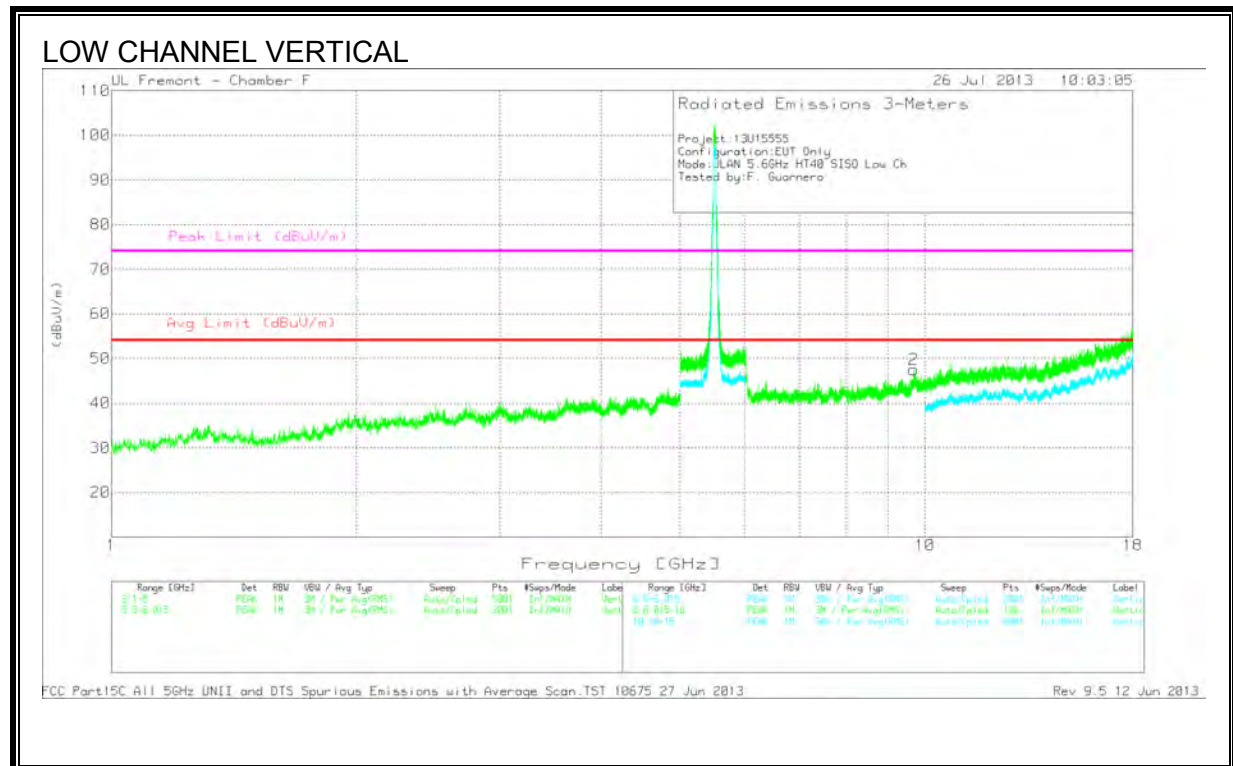
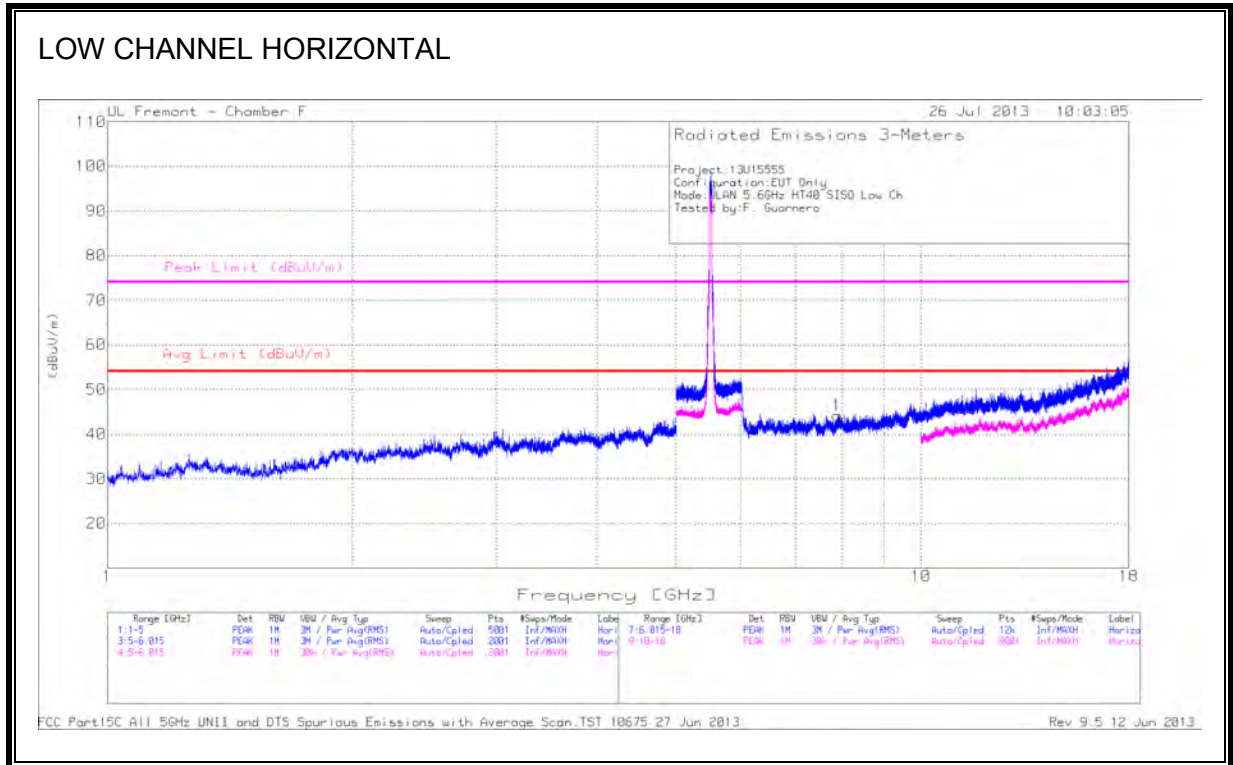

**DATA**

Marker	Frequency (GHz)	Meter Reading (dBuV)	Det	AF T120 (dB/m)	Amp/Cbl /Filtr/Pad (dB)	Corrected Reading (dBuV/m)	Avg Limit (dBuV/ m)	Margin (dB)	Peak Limit (dBuV/m)	Margin (dB)	Azimuth (Degs)	Height (cm)	Polarity
1	7.89	36.71	PK	35.9	-28.4	44.21	53.97	-9.76	74	-29.79	0-360	100	H
2	9.685	35.92	PK	37.4	-25.8	47.52	53.97	-6.45	74	-26.48	0-360	100	V

PK - Peak detector



**HARMONICS AND SPURIOUS EMISSIONS**

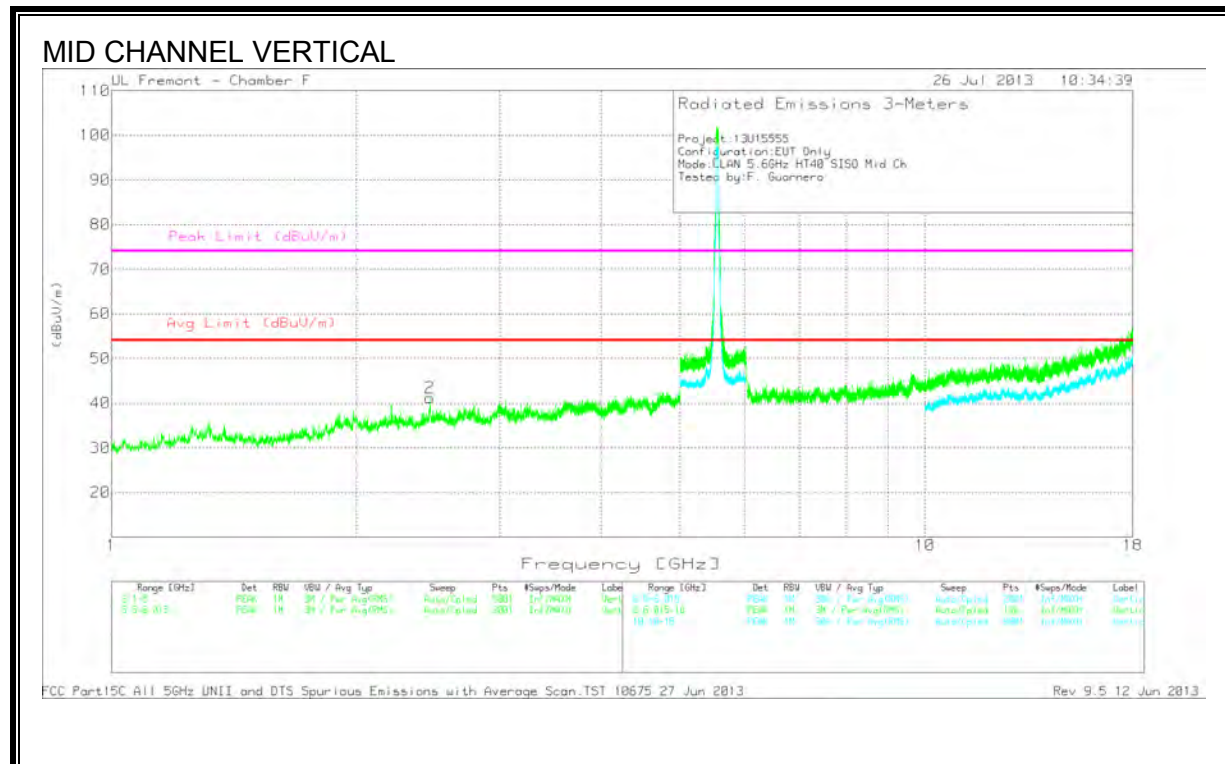
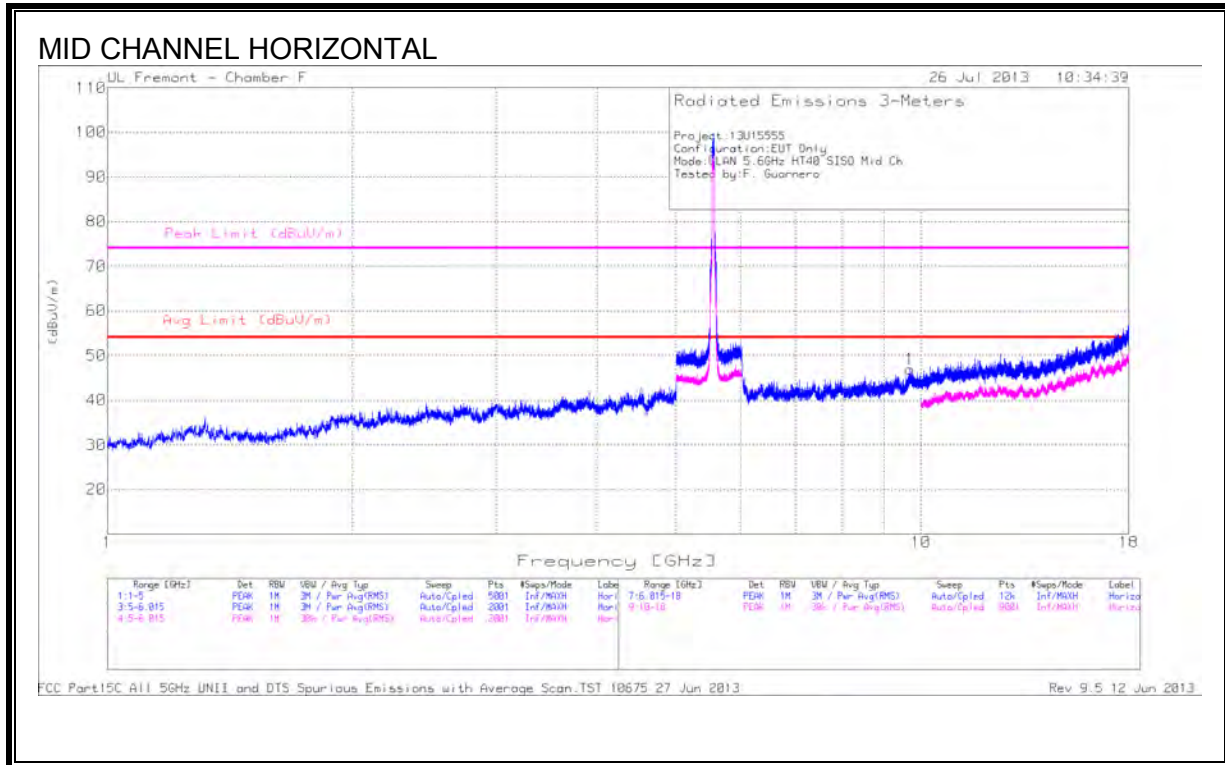

**DATA**

Marker	Frequency (GHz)	Meter Reading (dBuV)	Det	AF T120 (dB/m)	Amp/Cbl /Filtr/Pad (dB)	Corrected Reading (dBuV/m)	Avg Limit (dBuV/m)	Margin (dB)	Peak Limit (dBuV/m)	Margin (dB)	Azimuth (Degs)	Height (cm)	Polarity
2	2.462	41.99	PK	32.4	-33.2	41.19	53.97	-12.78	74	-32.81	0-360	101	V
1	9.691	35.1	PK	37.4	-25.6	46.9	53.97	-7.07	74	-27.1	0-360	199	H

PK - Peak detector

**HARMONICS AND SPURIOUS EMISSIONS**

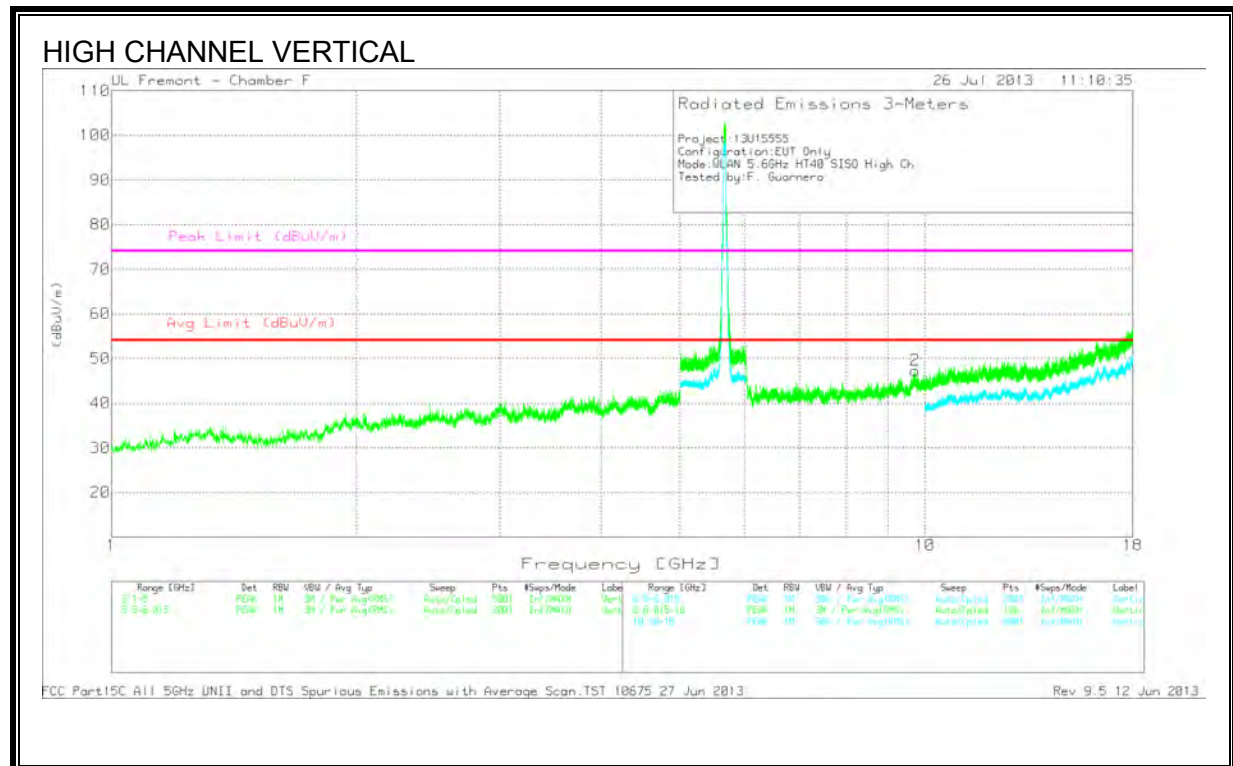
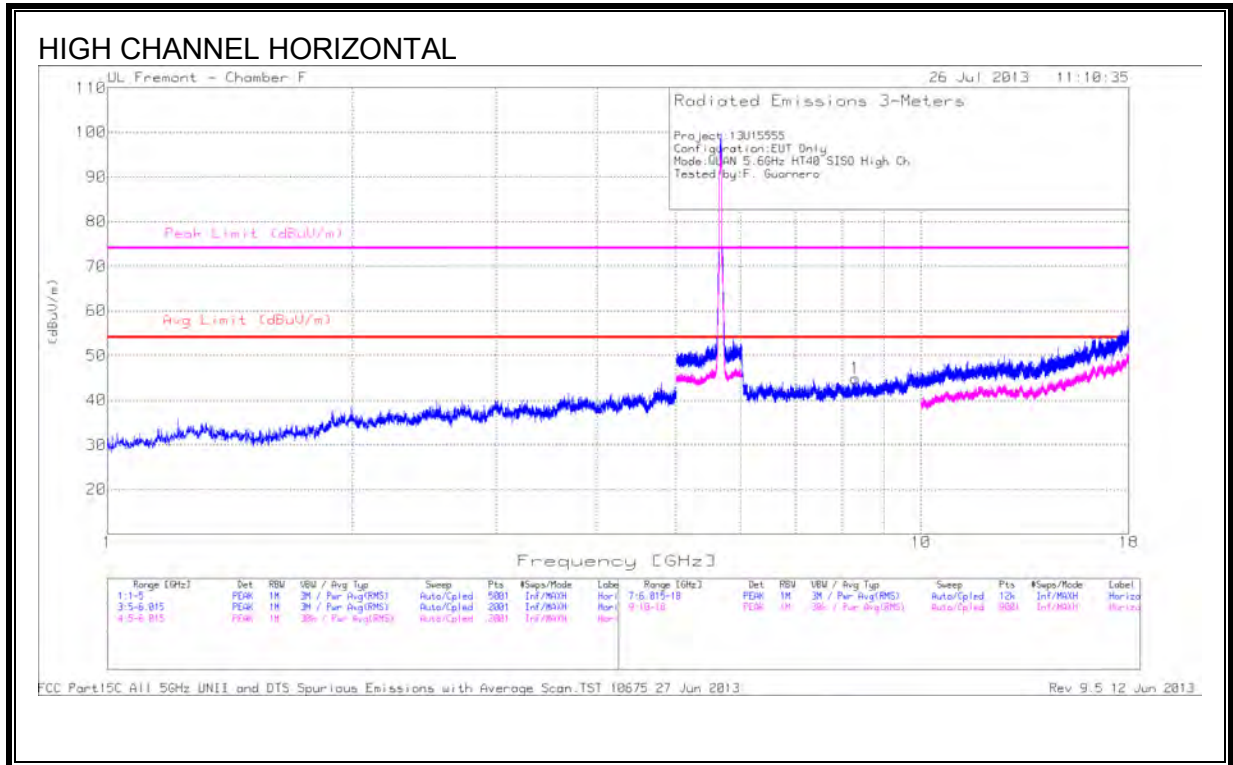

**DATA**

Marker	Frequency (GHz)	Meter Reading (dBuV)	Det	AF T120 (dB/m)	Amp/Cbl /Filtr/Pad (dB)	Corrected Reading (dBuV/m)	Avg Limit (dBuV/m)	Margin (dB)	Peak Limit (dBuV/m)	Margin (dB)	Azimuth (Degs)	Height (cm)	Polarity
1	8.302	36.7	PK	36	-27.8	44.9	53.97	-9.07	74	-29.1	0-360	199	H
2	9.722	35.54	PK	37.4	-25.6	47.34	53.97	-6.63	74	-26.66	0-360	201	V

PK - Peak detector

**9.2.15. 802.11n HT40 2TX CDD MODE IN THE 5.6 GHz BAND**

**RESTRICTED & AUTHORIZED BANDEDGE (LOW CHANNEL)**

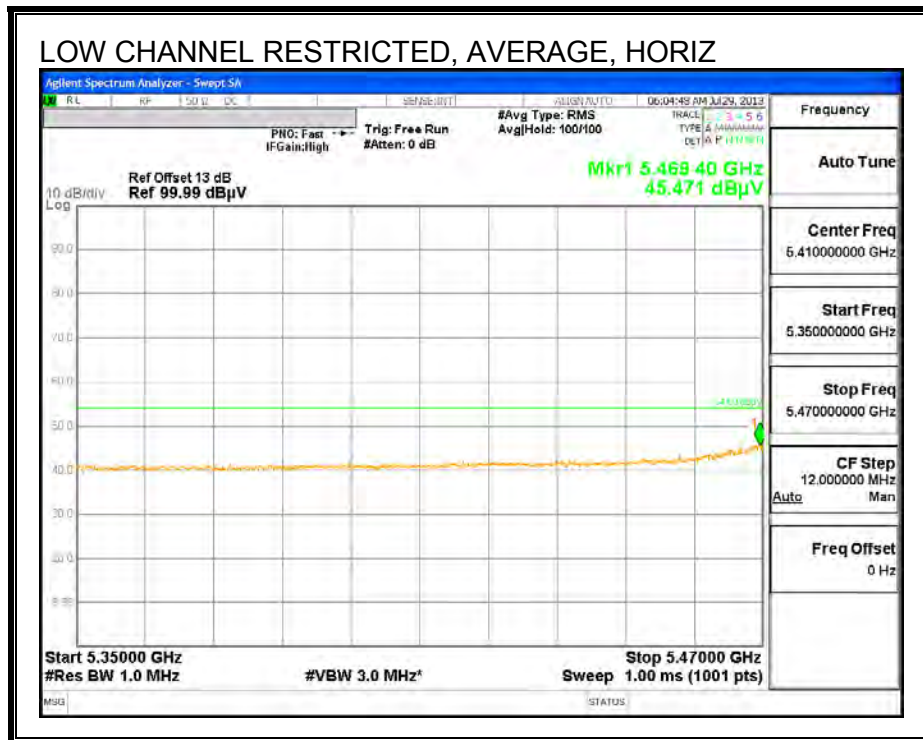
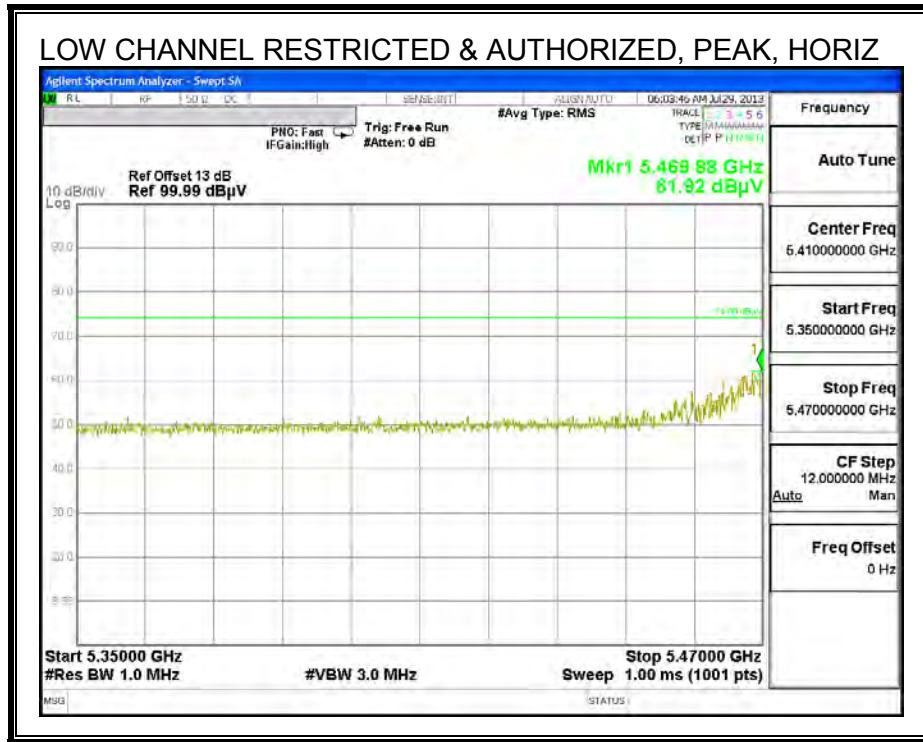

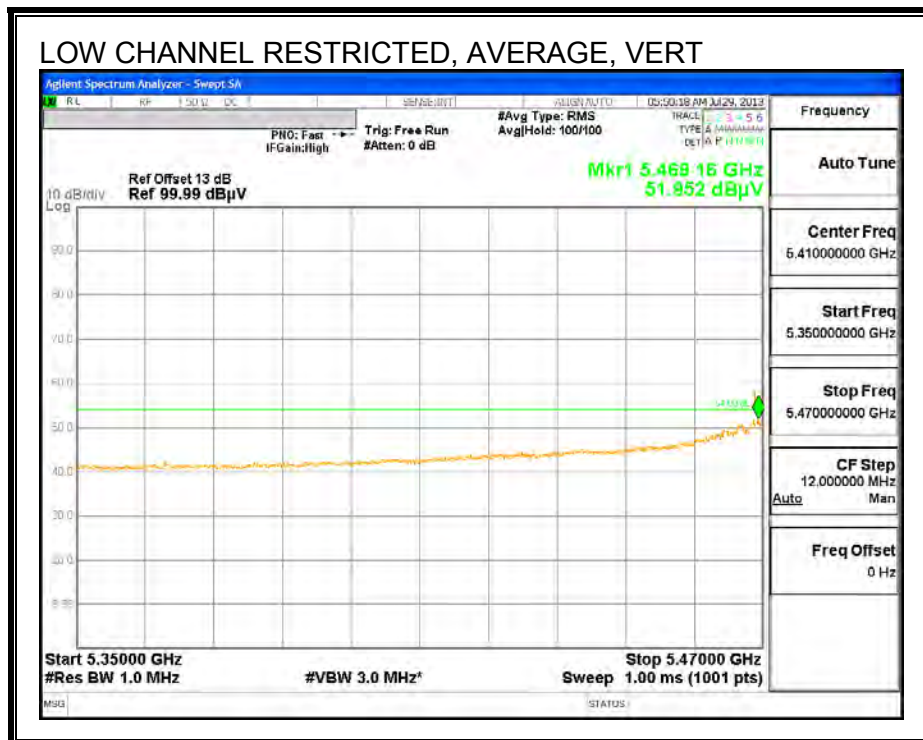
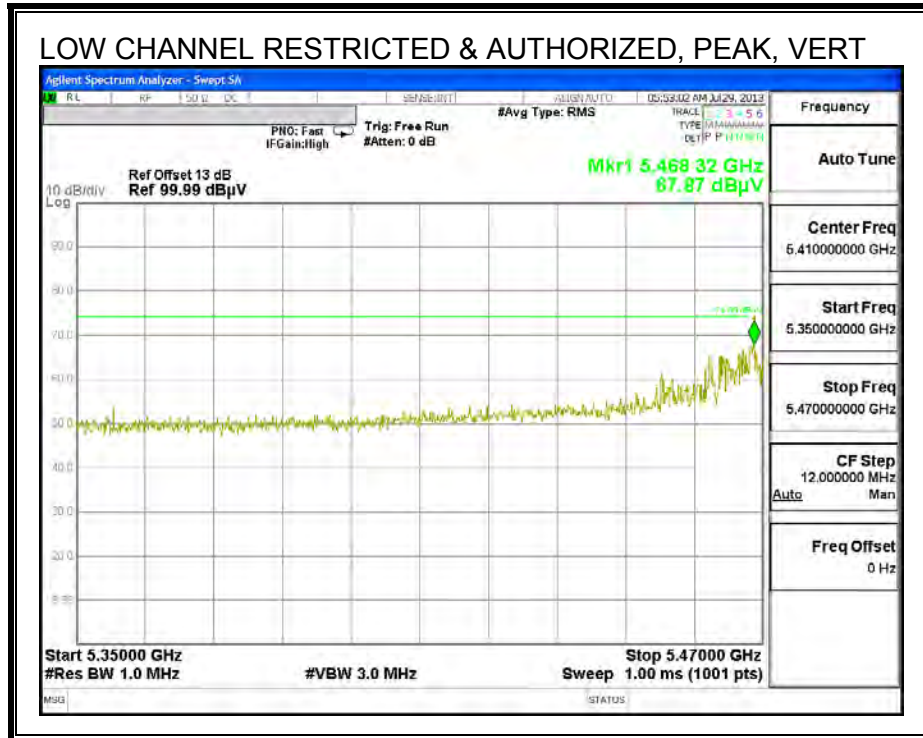

**AUTHORIZED BANDEDGE (HIGH CHANNEL)**

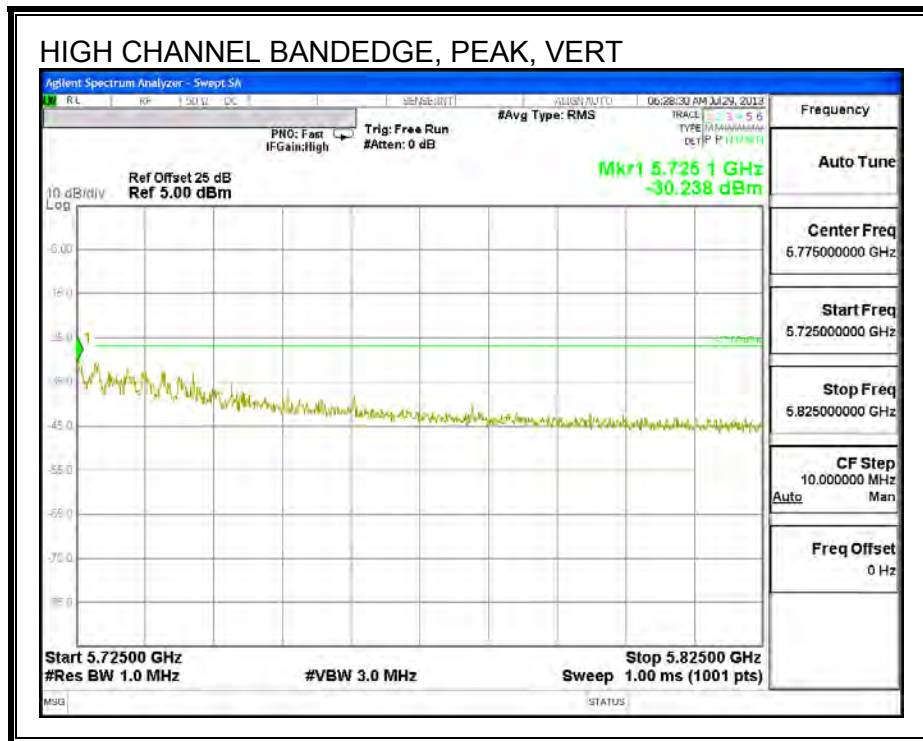
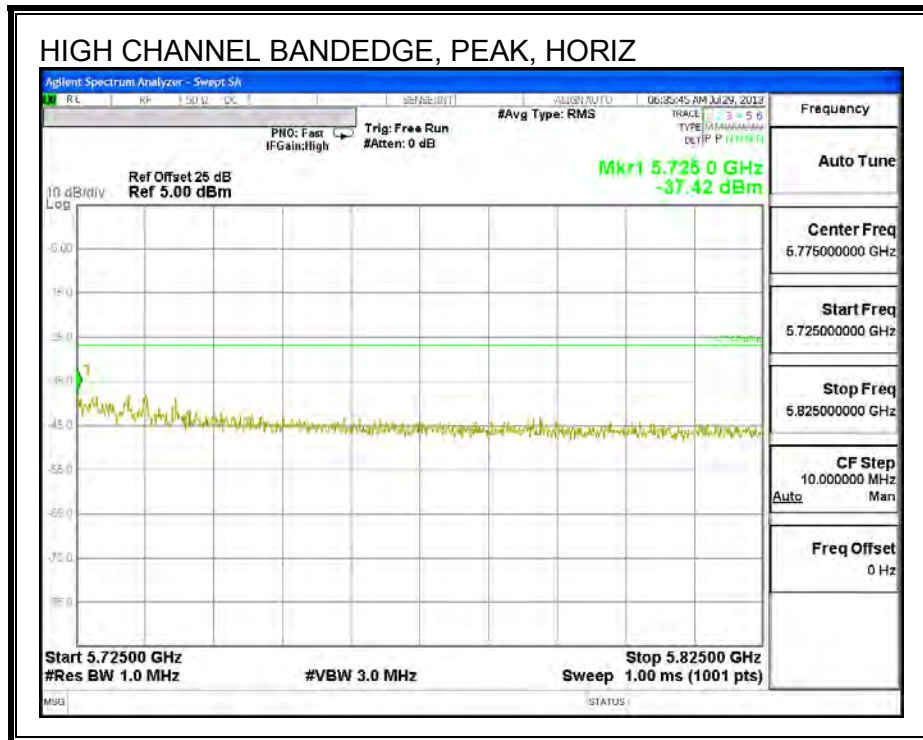

**HARMONICS AND SPURIOUS EMISSIONS**

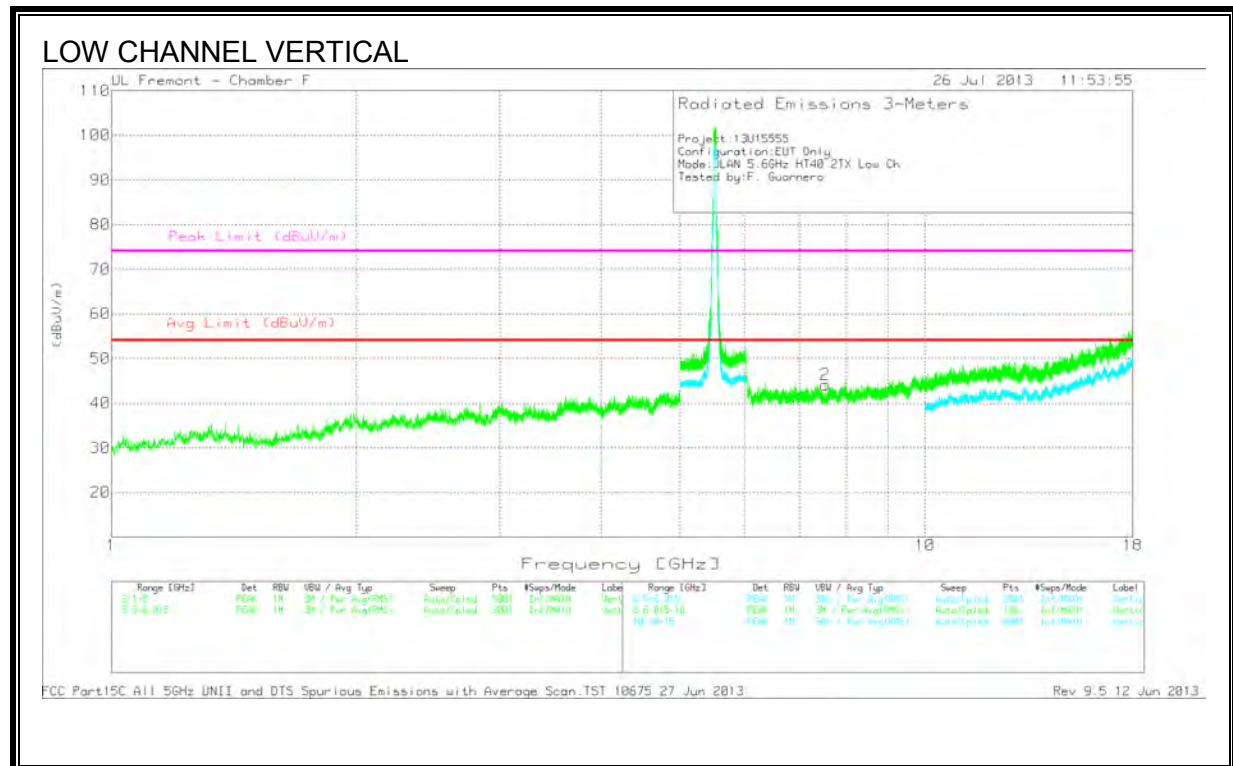
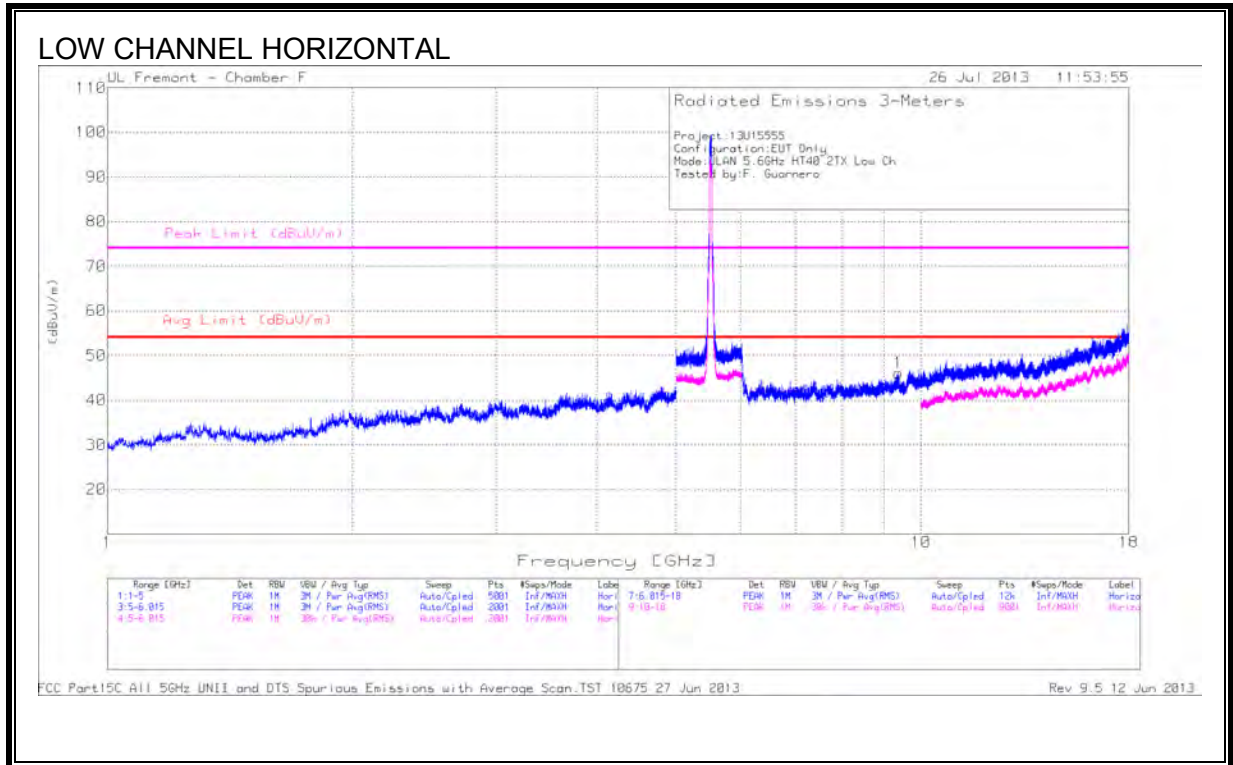



**DATA**

Marker	Frequency (GHz)	Meter Reading (dBuV)	Det	AF T120 (dB/m)	Amp/Cbl /Filtr/Pad (dB)	Corrected Reading (dBuV/m)	Avg Limit (dBuV/m)	Margin (dB)	Peak Limit (dBuV/m)	Margin (dB)	Azimuth (Degs)	Height (cm)	Polarity
1	9.377	35.53	PK	36.9	-26.3	46.13	53.97	-7.84	74	-27.87	0-360	199	H
2	7.541	37.32	PK	35.8	-29	44.12	53.97	-9.85	74	-29.88	0-360	100	V

PK - Peak detector

**HARMONICS AND SPURIOUS EMISSIONS**

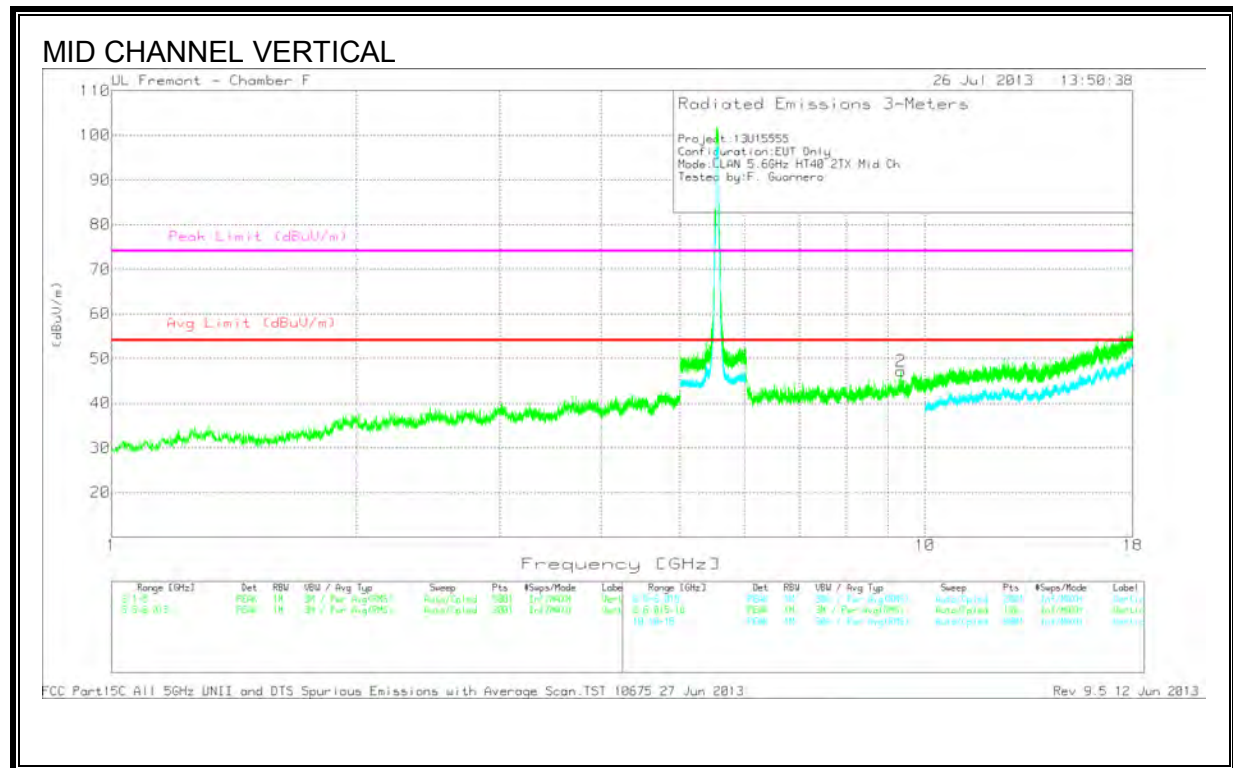
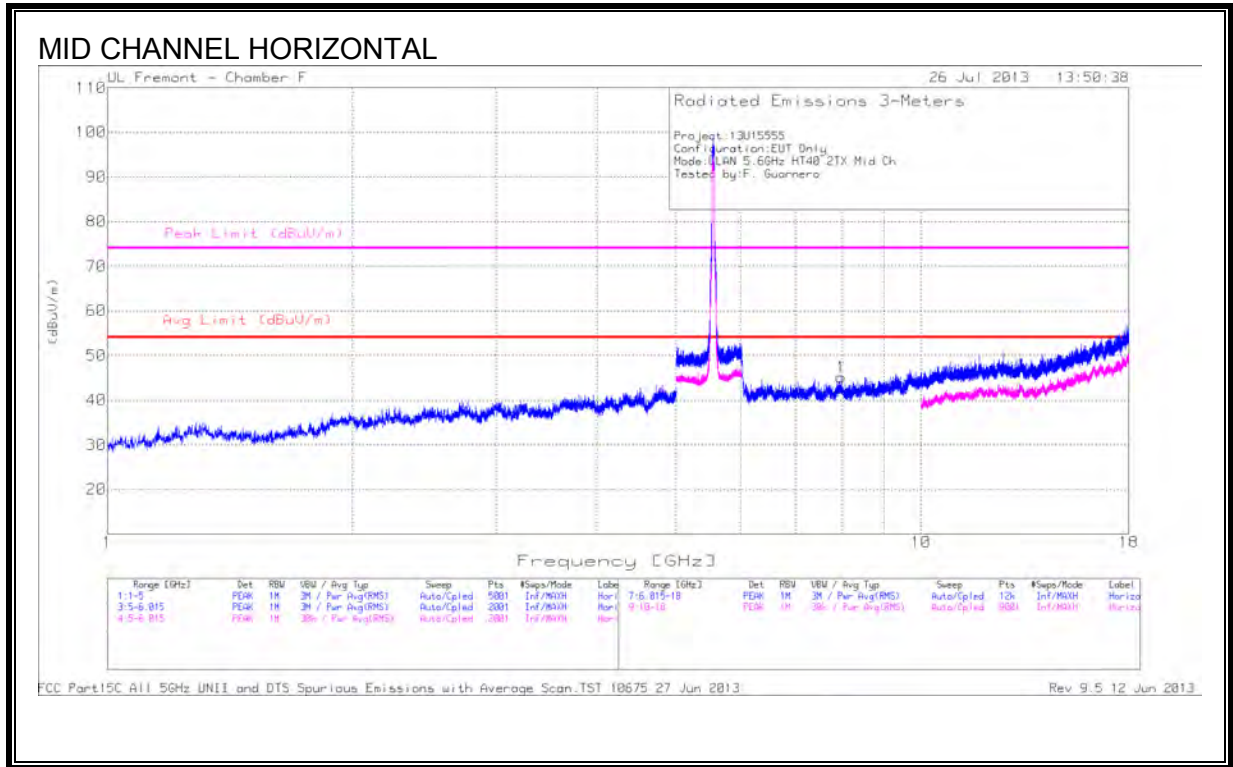

**DATA**

Marker	Frequency (GHz)	Meter Reading (dBuV)	Det	AF T120 (dB/m)	Amp/Cbl /Filtr/Pad (dB)	Corrected Reading (dBuV/m)	Avg Limit (dBuV/ m)	Margin (dB)	Peak Limit (dBuV/m)	Margin (dB)	Azimuth (Degs)	Height (cm)	Polarity
1	7.974	37.33	PK	36	-28.2	45.13	53.97	-8.84	74	-28.87	0-360	100	H
2	9.339	36.3	PK	36.8	-25.9	47.2	53.97	-6.77	74	-26.8	0-360	100	V

PK - Peak detector

**HARMONICS AND SPURIOUS EMISSIONS**

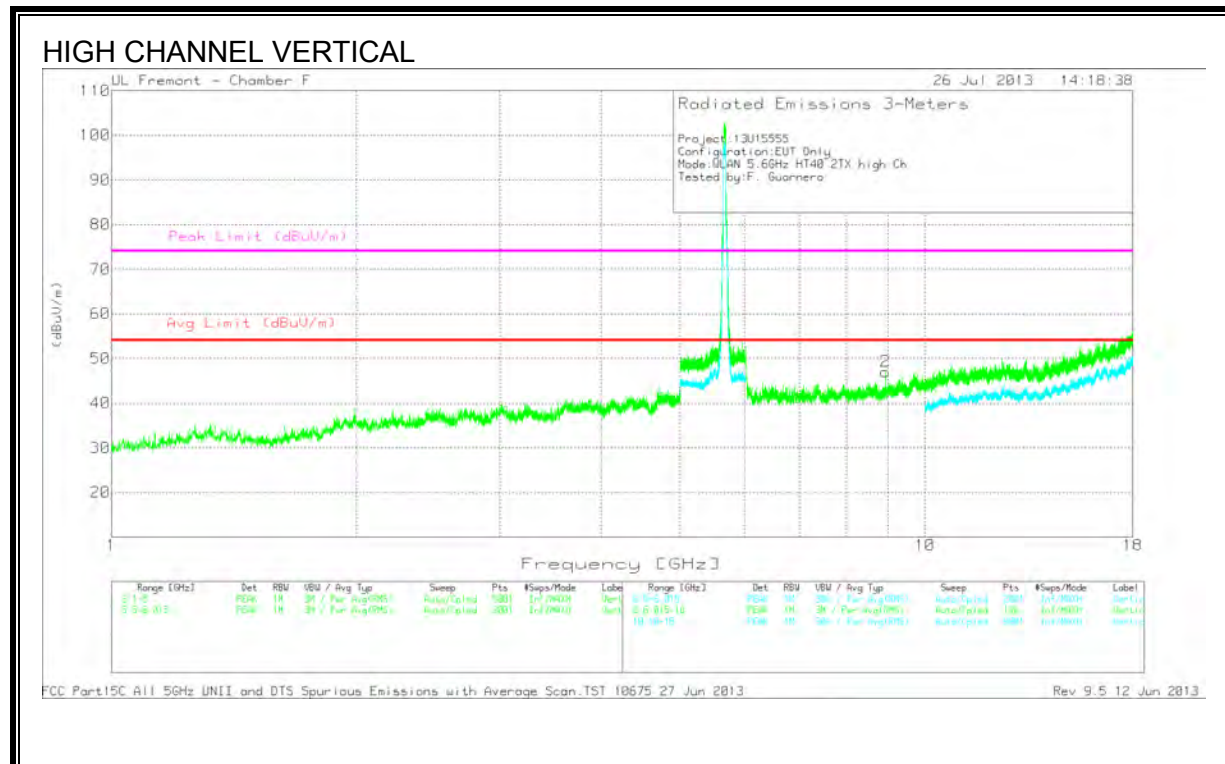
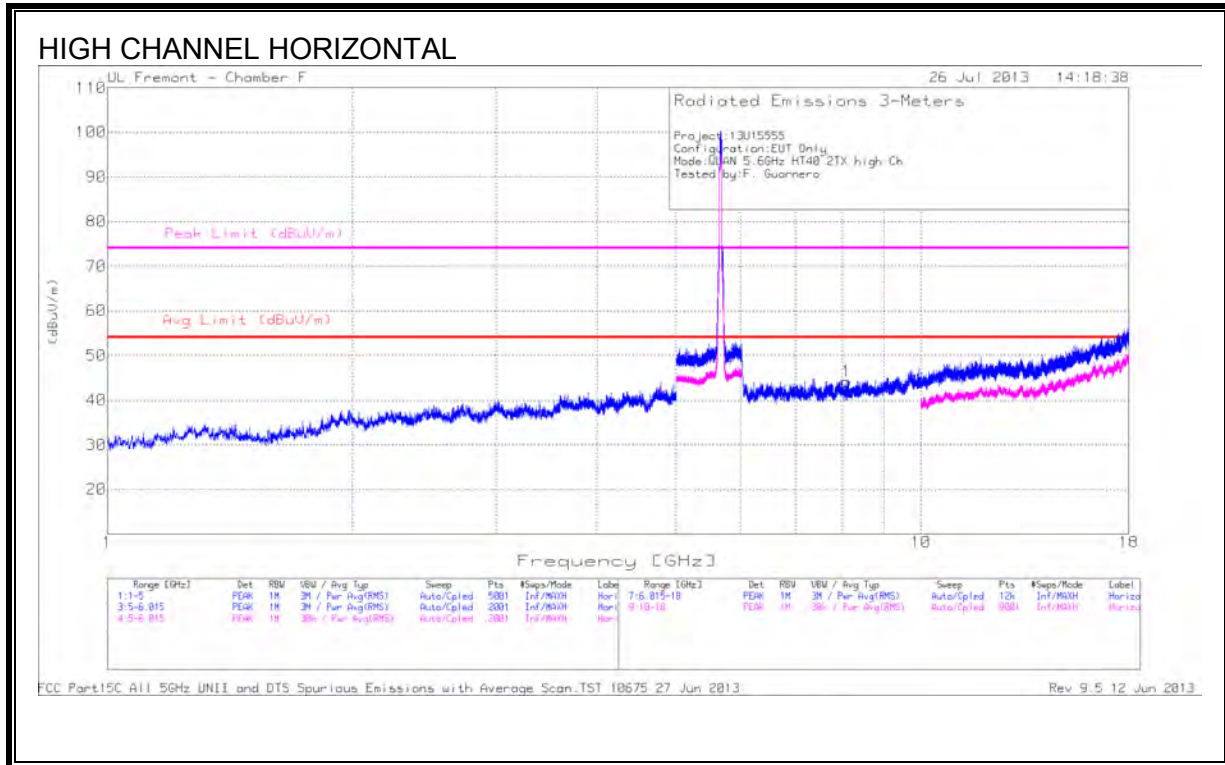

**DATA**

Marker	Frequency (GHz)	Meter Reading (dBuV)	Det	AF T120 (dB/m)	Amp/Cbl /Filtr/Pad (dB)	Corrected Reading (dBuV/m)	Avg Limit (dBuV/m)	Margin (dB)	Peak Limit (dBuV/m)	Margin (dB)	Azimuth (Degs)	Height (cm)	Polarity
1	8.107	36.75	PK	36	-28.6	44.15	53.97	-9.82	74	-29.85	0-360	199	H
2	8.937	38.09	PK	36.3	-27.3	47.09	53.97	-6.88	74	-26.91	0-360	101	V

PK - Peak detector

### 9.2.16. 2.4GHz and 5GHz Band Co-Location

#### BLUETOOTH ON

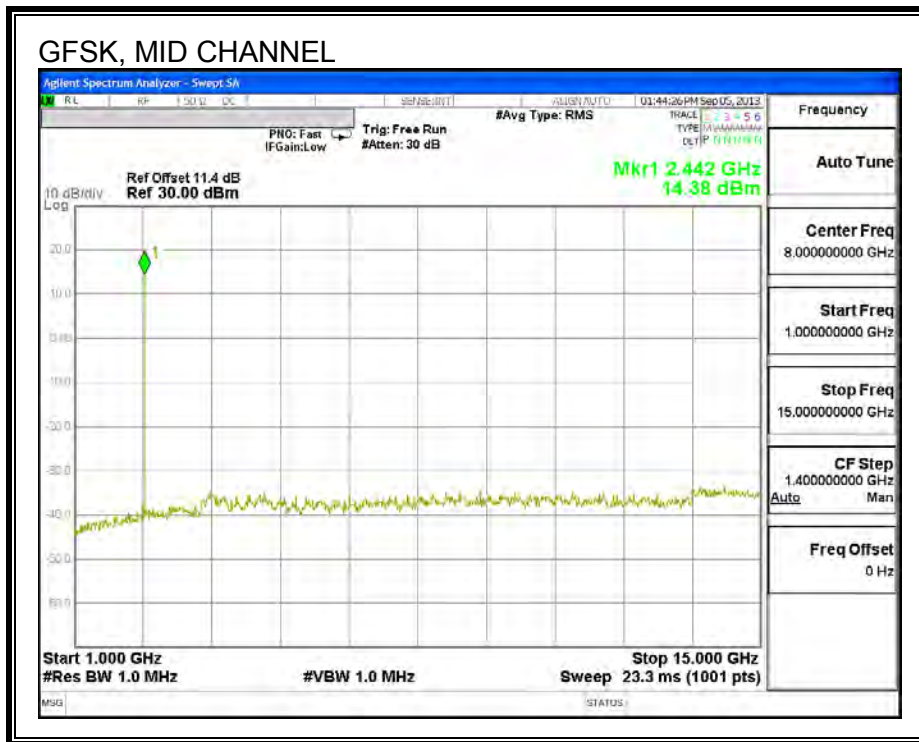

#### BLUETOOTH OFF WiFi ON

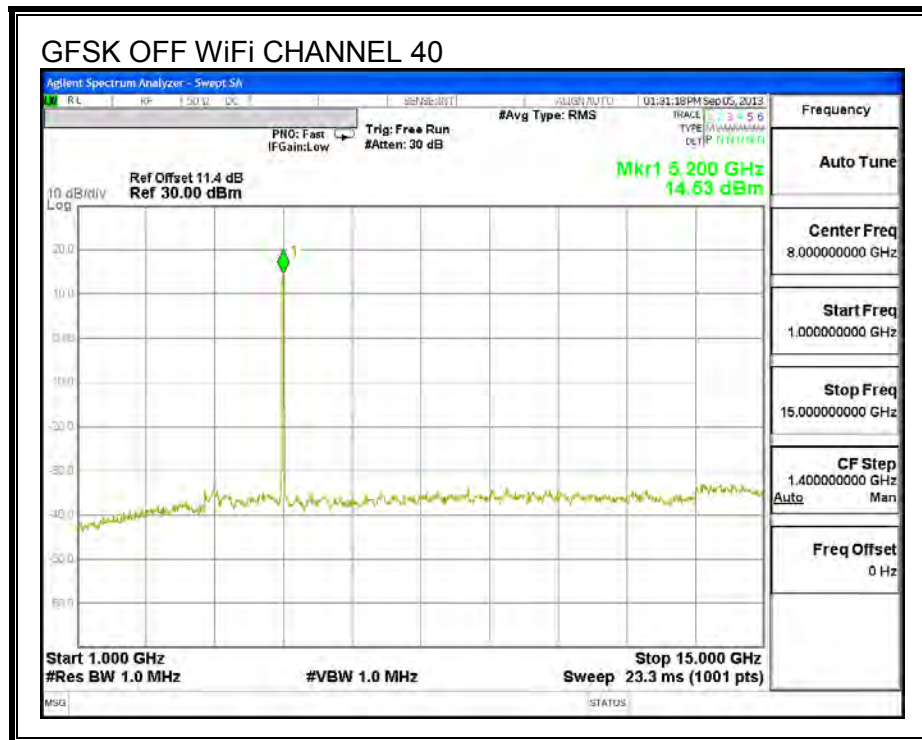

**BLUETOOTH AND WiFi CO-LOCATION**

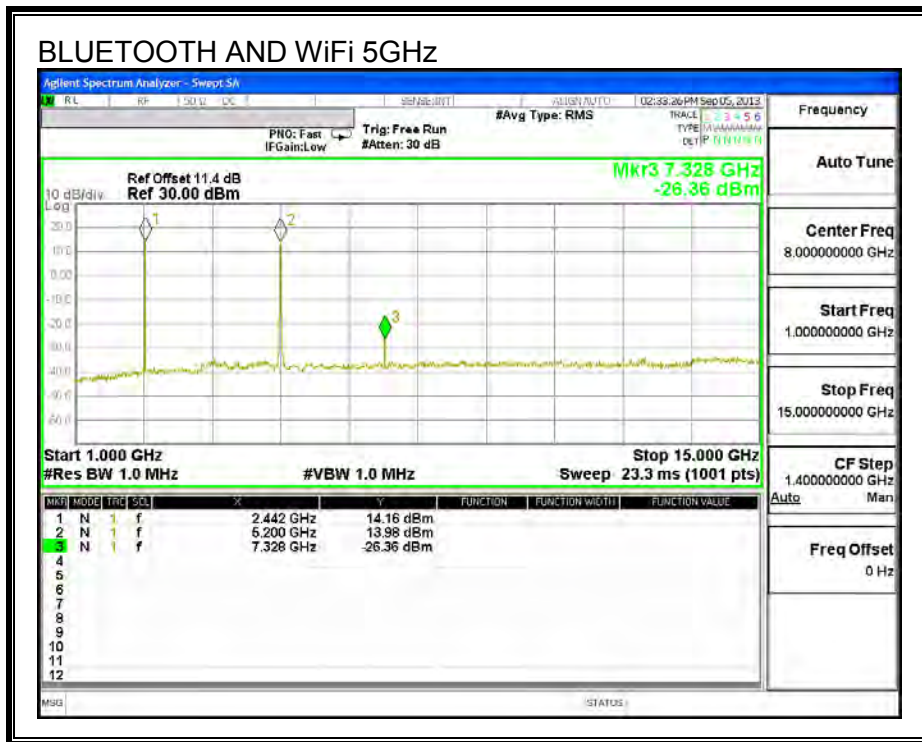

**HARMONICS AND SPURIOUS EMISSIONS**

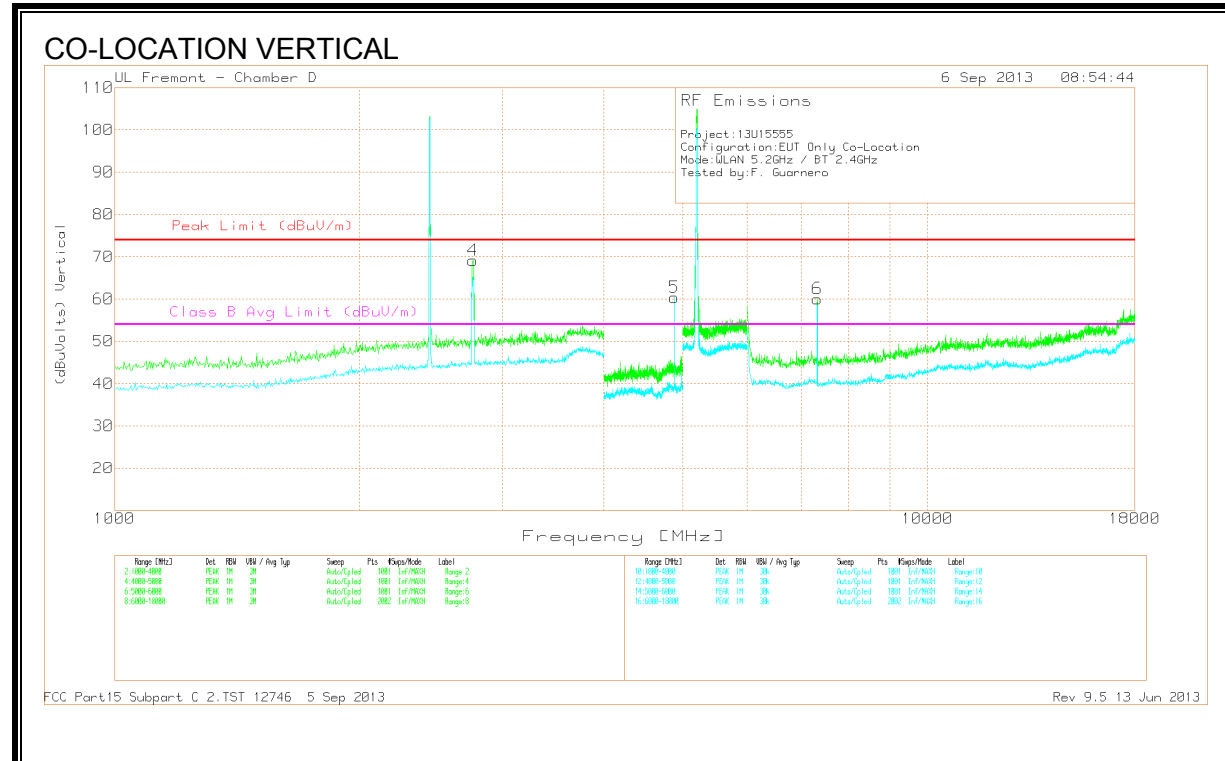
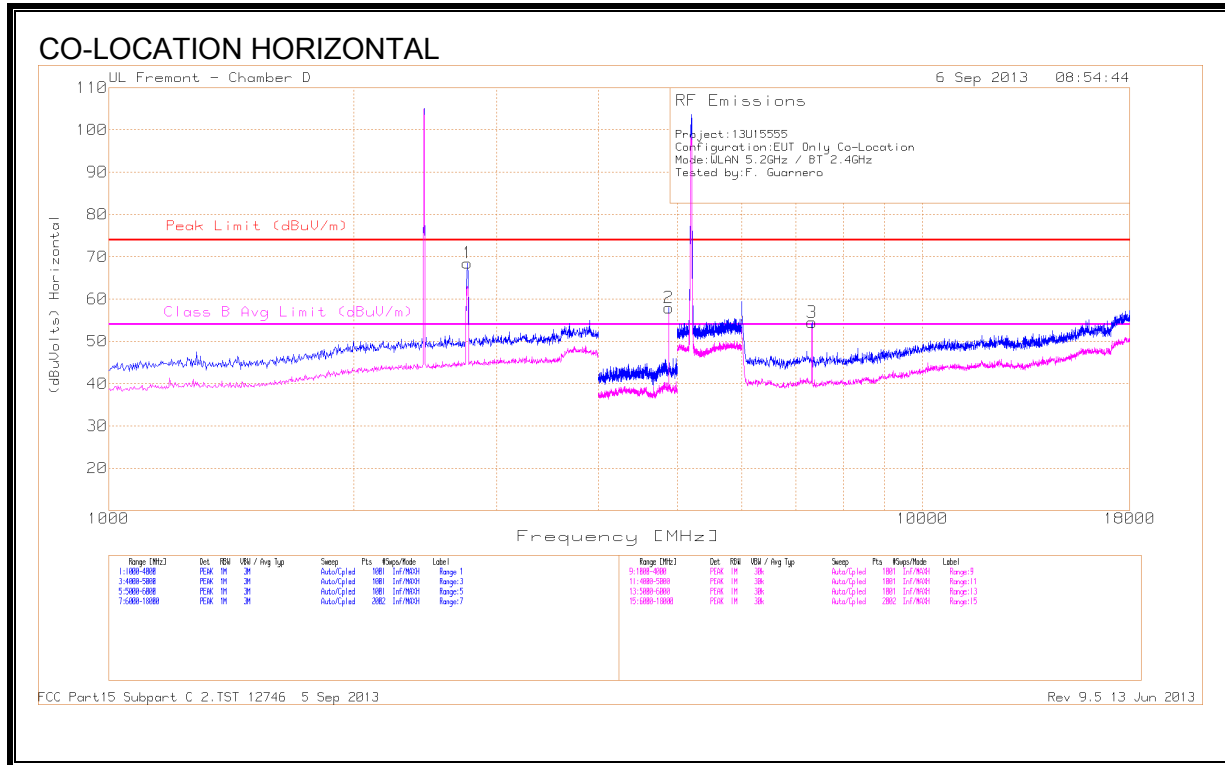



**DATA**

Marker	Frequency (GHz)	Meter Reading (dBuV)	Det	AF T344 (db/m)	Amp/Cbl/ Pad	Corrected Reading (dBuVolts)	Peak Limit (dBuV/m)	Margin (dB)	Class B Avg Limit (dBuV/m)	Margin (dB)	Height (cm)	Polarity
*1	2.761	56.19	PK	32.9	-20.6	68.49	74	-5.51	-	-	100	H
*2	4.883	50.96	PK	34.3	-27.3	57.96	74	-16.04	-	-	100	H
*3	7.325	44.97	PK	35.9	-26.4	54.47	74	-19.53	-	-	100	H

PK - Peak detector

Marker	Frequency (GHz)	Meter Reading (dBuV)	Det	AF T344 (db/m)	Amp/Cbl/ Filtr/Pad	Corrected Reading (dBuVolts)	Peak Limit (dBuV/m)	Margin (dB)	Class B Avg Limit (dBuV/m)	Margin (dB)	Height (cm)	Polarity
*4	2.761	56.84	PK	32.9	-20.6	69.14	74	-4.86	-	-	100	V
*5	4.883	53.39	PK	34.3	-27.3	60.39	74	-13.61	-	-	100	V
*6	7.325	50.52	PK	35.9	-26.4	60.02	74	-13.98	-	-	100	V

PK - Peak detector

\*For the Harmonics measurement, there is no need for the average reading since the peak reading passed with the peak limit. The average reading = peak reading – 20\*log (1/duty cycle), and the 20\*log (1/duty cycle) is greater than 20dB.

### 9.3. WORST-CASE ABOVE 18 GHz

#### SPURIOUS EMISSIONS 18 TO 26 GHz (WORST-CASE CONFIGURATION, HORIZONTAL & VERTICAL)

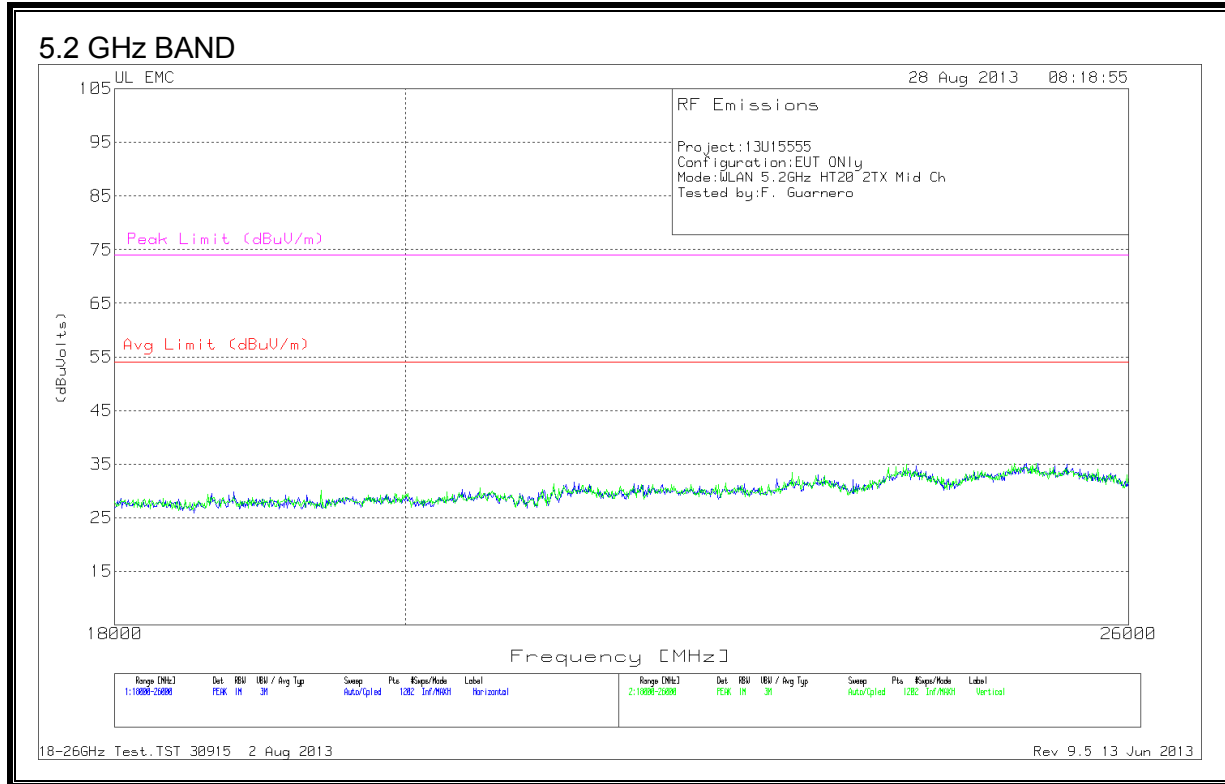

**SPURIOUS EMISSIONS 26 TO 40 GHz (WORST-CASE CONFIGURATION, HORIZONTAL & VERTICAL)**

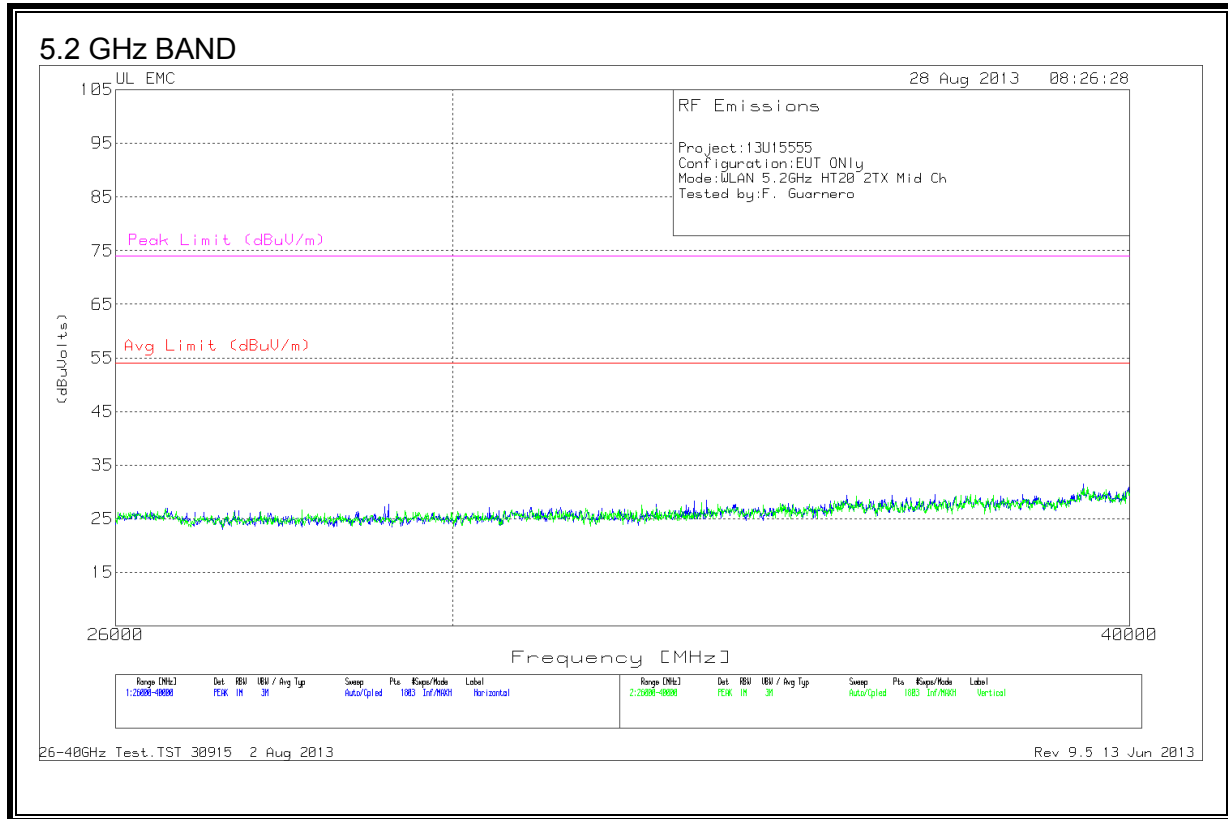

**SPURIOUS EMISSIONS 18 TO 26 GHz (WORST-CASE CONFIGURATION, HORIZONTAL & VERTICAL)**

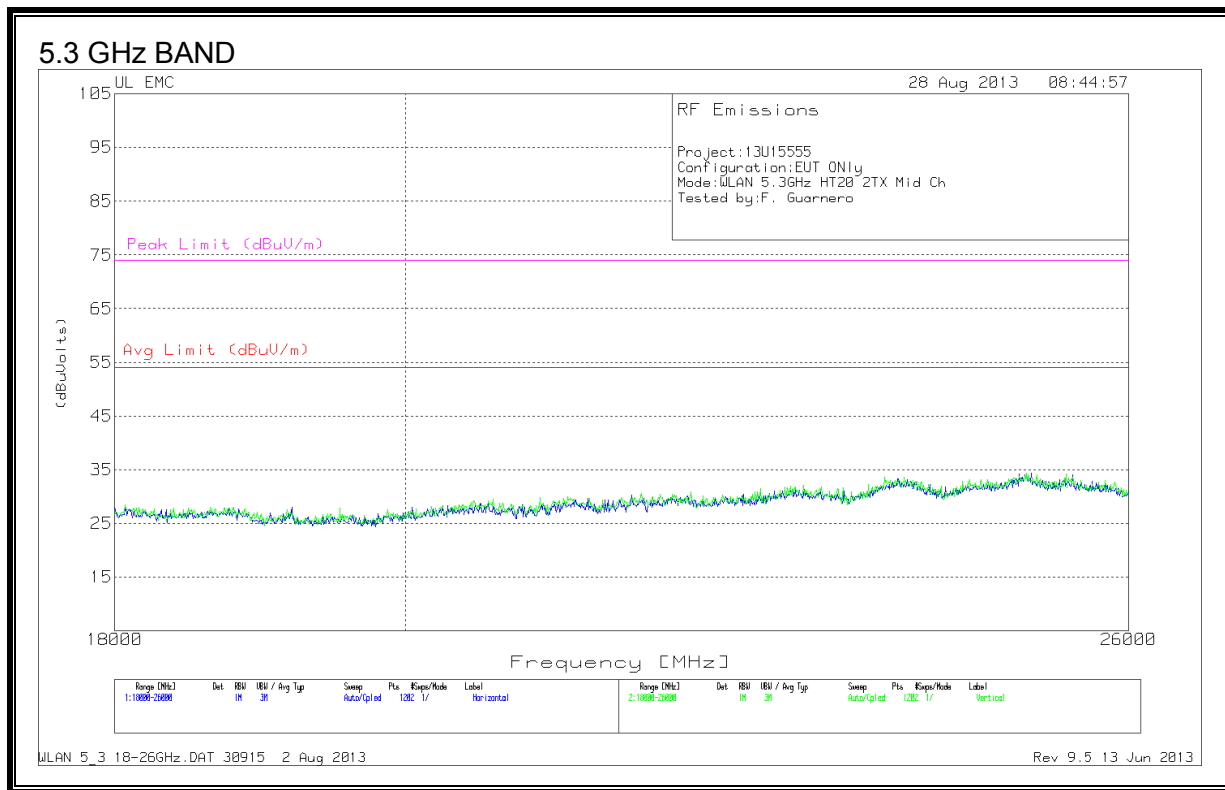

**SPURIOUS EMISSIONS 26 TO 40 GHz (WORST-CASE CONFIGURATION, HORIZONTAL & VERTICAL)**

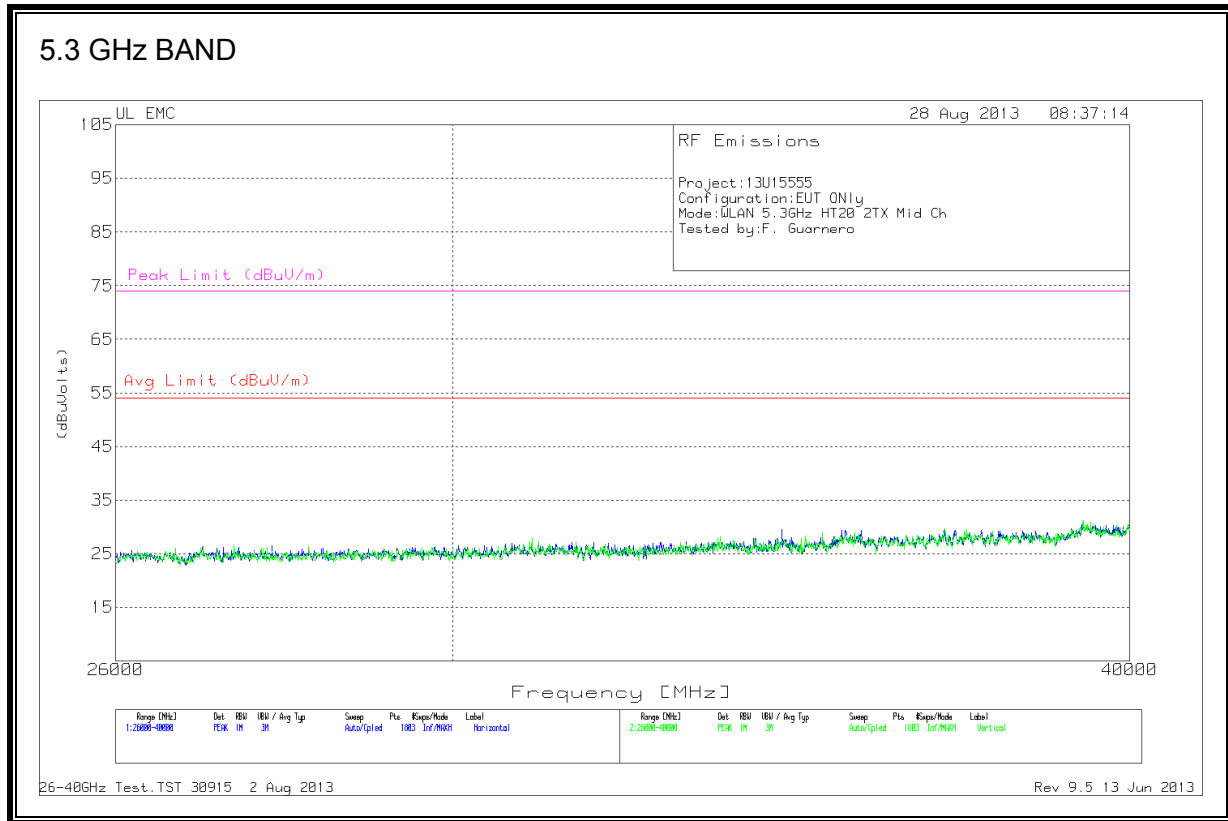

**SPURIOUS EMISSIONS 18 TO 26 GHz (WORST-CASE CONFIGURATION, HORIZONTAL & VERTICAL)**

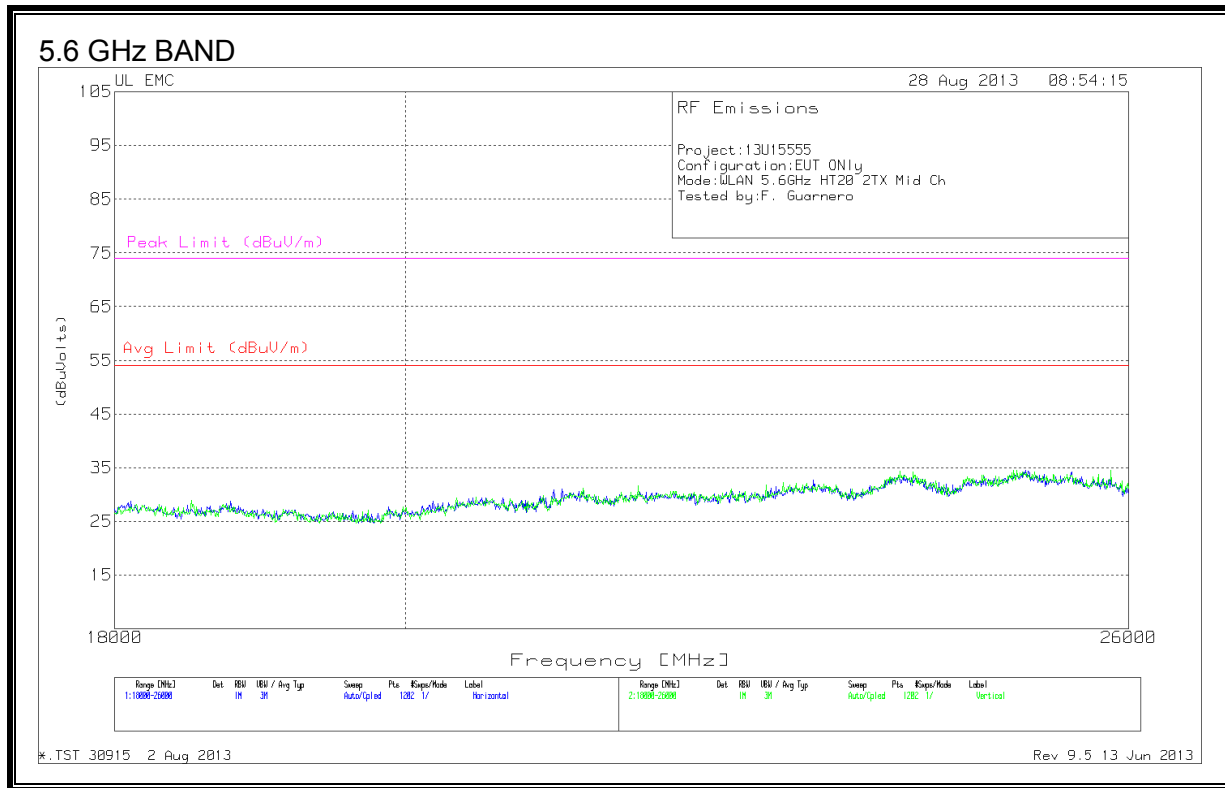

**SPURIOUS EMISSIONS 26 TO 40 GHz (WORST-CASE CONFIGURATION, HORIZONTAL & VERTICAL)**

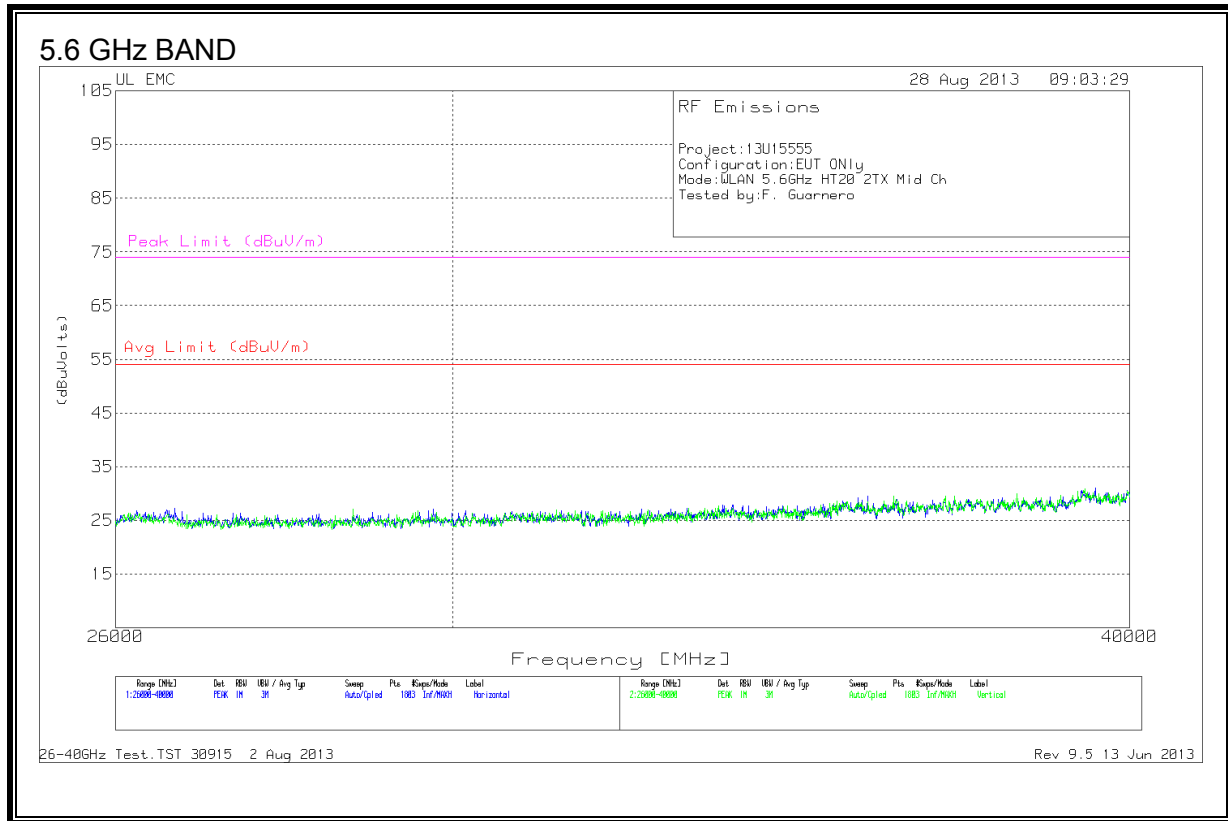

### 9.4. WORST-CASE BELOW 1 GHz

#### SPURIOUS EMISSIONS 30 TO 1000 MHz (WORST-CASE CONFIGURATION)

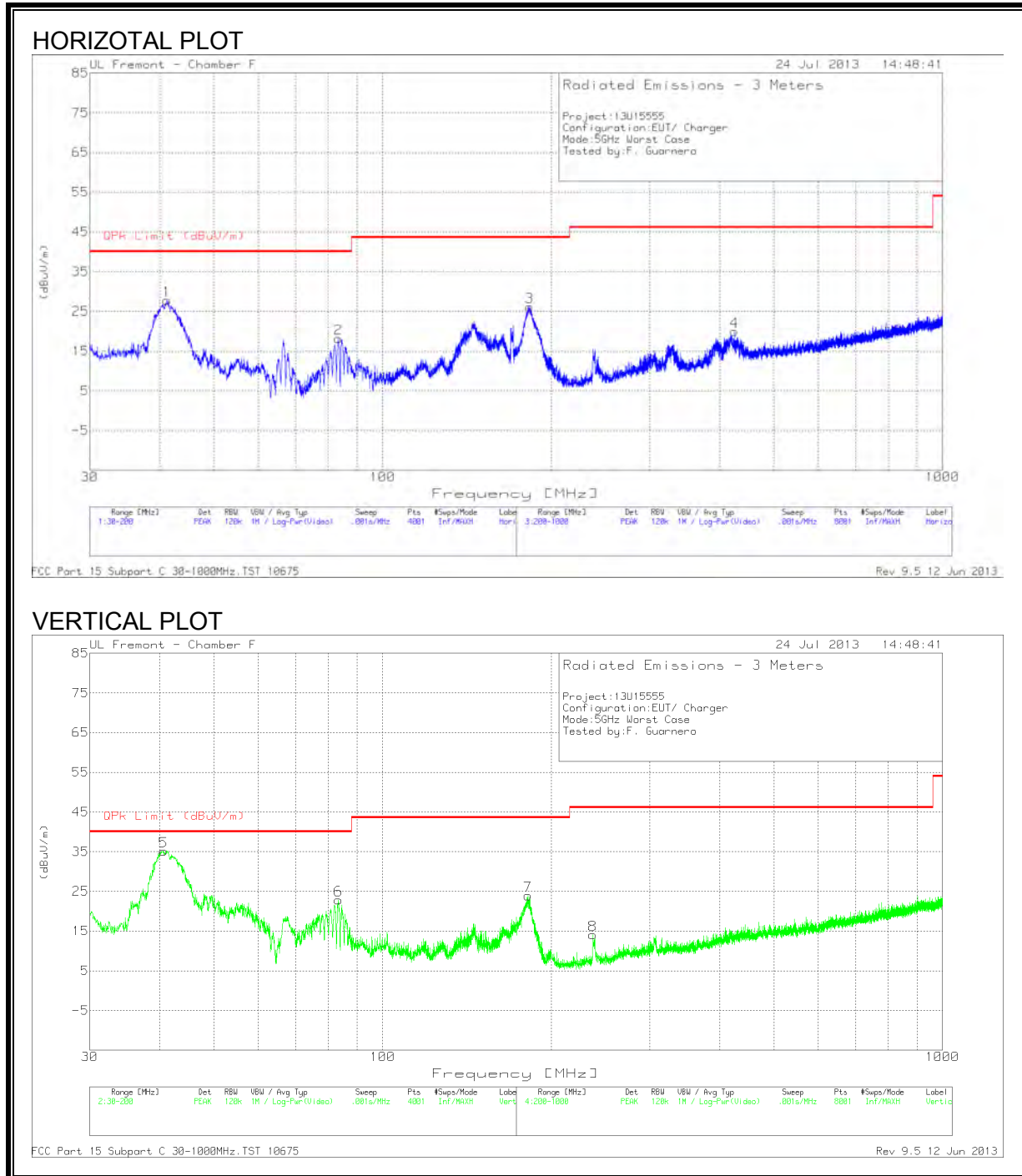



### Trace Markers

Marker	Frequency (MHz)	Meter Reading (dBuV)	Det	AF T122 (dB/m)	Amp/Cbl (dB)	Corrected Reading (dBuV/m)	QPk Limit (dBuV/m)	Margin (dB)	Azimuth (Degs)	Height (cm)	Polarity
1	41.22	46.91	PK	12.9	-32	27.81	40	-12.19	0-360	400	H
2	83.38	42.49	PK	7.4	-31.7	18.19	40	-21.81	0-360	200	H
3	183.1275	46.16	PK	11.1	-31.1	26.16	43.52	-17.36	0-360	200	H
5	40.625	53.73	PK	13.4	-32	35.13	40	-4.87	0-360	100	V
6	83.4225	47.16	PK	7.4	-31.7	22.86	40	-17.14	0-360	100	V
7	181.8525	44.05	PK	11.1	-31.2	23.95	43.52	-19.57	0-360	100	V
4	425.3	33.92	PK	16.4	-30.4	19.92	46.02	-26.1	0-360	100	H
8	237.4	33.56	PK	11.5	-31	14.06	46.02	-31.96	0-360	401	V

PK - Peak detector

### Radiated Emissions

Frequency (MHz)	Meter Reading (dBuV)	Det	AFT122 (dB/m)	Amp/Cbl (dB)	Corrected Reading (dBuV/m)	QPk Limit (dBuV/m)	Margin (dB)	Azimuth (Degs)	Height (cm)	Polarity
40.6027	48.8	QP	13.4	-32	30.2	40	-9.8	62	185	V

QP - Quasi-Peak detector

FCC Part 15 Subpart C 30-1000MHz.TST 10675 Rev 9.5 12 Jun 2013

## 10. AC POWER LINE CONDUCTED EMISSIONS

### LIMITS

FCC §15.207 (a)

Frequency of Emission (MHz)	Conducted Limit (dB $\mu$ V)	
	Quasi-peak	Average
0.15-0.5	66 to 56 *	56 to 46 *
0.5-5	56	46
5-30	60	50

\*Decreases with the logarithm of the frequency.

### TEST PROCEDURE

The EUT is placed on a non-conducting table 40 cm from the vertical ground plane and 80 cm above the horizontal ground plane. The EUT is configured in accordance with ANSI C63.4.

The receiver is set to a resolution bandwidth of 9 kHz. Peak detection is used unless otherwise noted as quasi-peak or average.

Line conducted data is recorded for both NEUTRAL and HOT lines.

### RESULTS

**LINE 1 RESULTS**

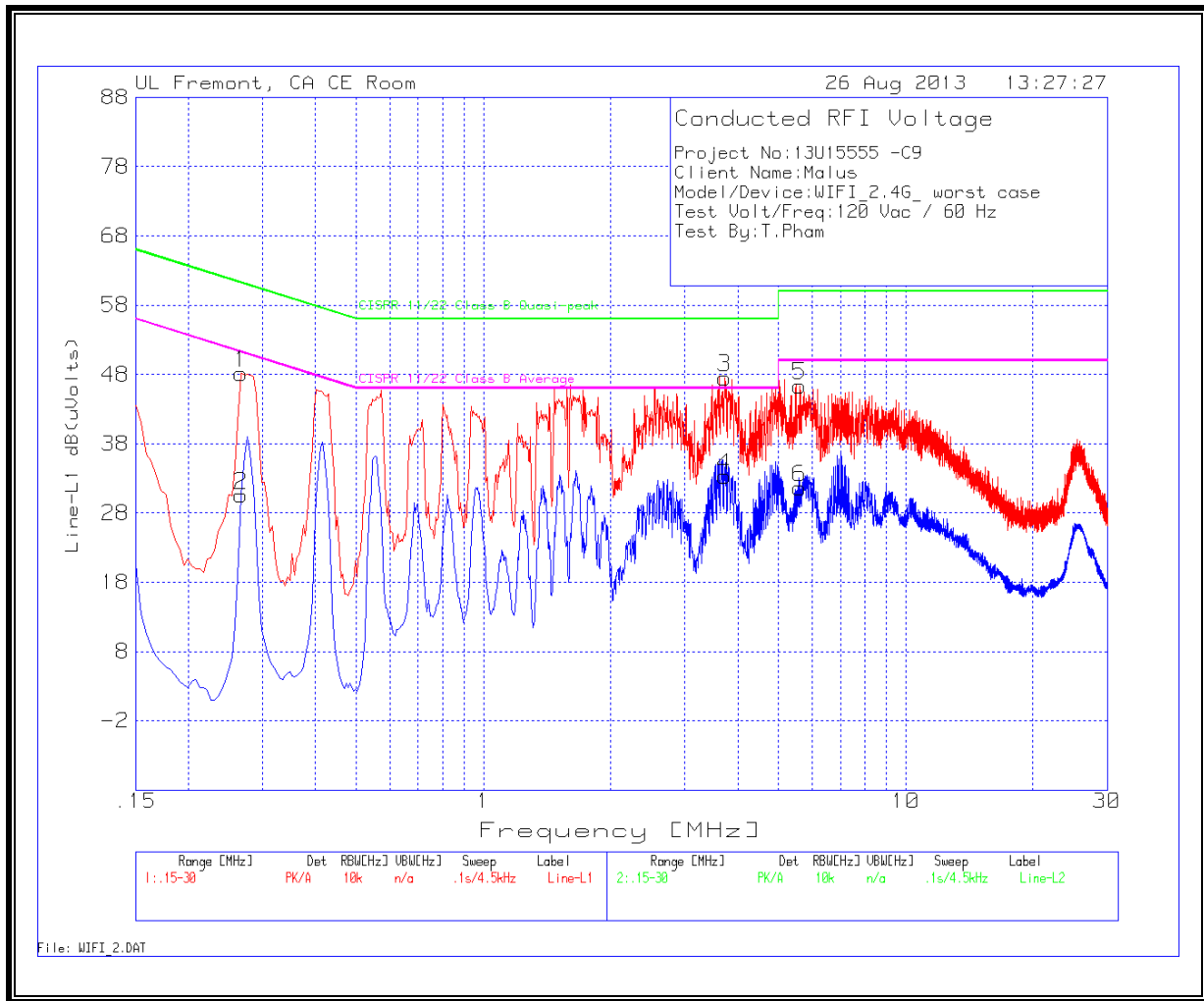

**WORST EMISSIONS**

Line-L1 .15 - 30MHz										
Trace Markers										
Marker	Frequency (MHz)	Meter Reading (dBuV)	Det	T24 IL L1 (dB)	LC Cables 1&3 (dB)	Corrected Reading dB(uVolts)	CISPR 11/22 Class B Quasi-peak	Margin to Limit (dB)	CISPR 11/22 Class B Average	Margin to Limit (dB)
1	0.267	48	PK	0.1	0	48.1	61.2	-13.1	-	-
2	0.267	30.46	Av	0.1	0	30.56	-	-	51.2	-20.64
3	3.732	47.28	PK	0.1	0.1	47.48	56	-8.52	-	-
4	3.732	33.07	Av	0.1	0.1	33.27	-	-	46	-12.73
5	5.6175	46.15	PK	0.1	0.1	46.35	60	-13.65	-	-
6	5.6175	31.4	Av	0.1	0.1	31.6	-	-	50	-18.4

PK - Peak detector  
 Av - average detection

**LINE 2 RESULTS**

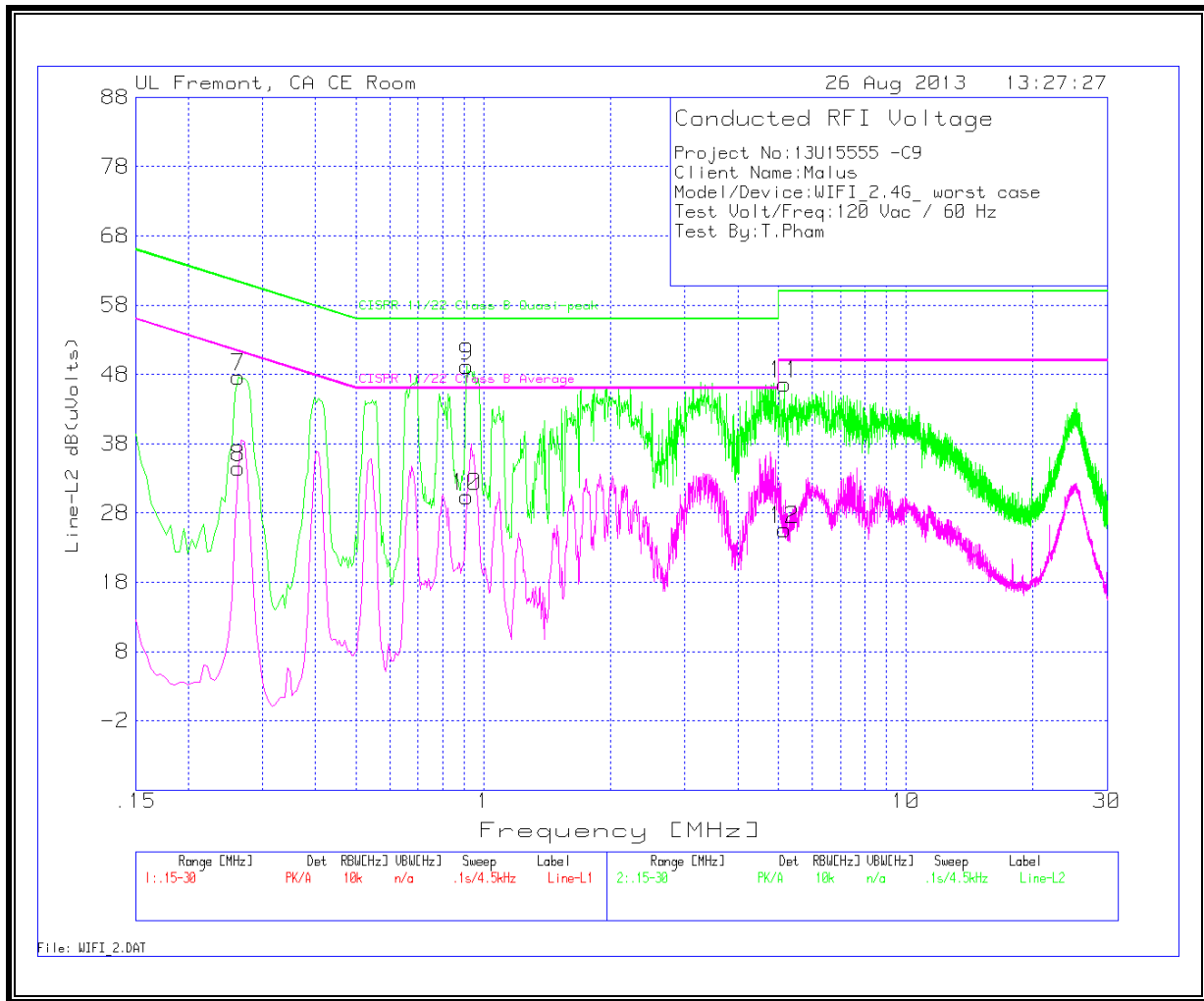

**WORST EMISSIONS**

Line-L2 .15 - 30MHz										
Trace Markers										
Marker	Frequency (MHz)	Meter Reading (dBuV)	Det	T24 IL L2 (dB)	LC Cables 2&3 (dB)	Corrected Reading dB(uVolts)	CISPR 11/22 Class B Quasi-peak	Margin to Limit (dB)	CISPR 11/22 Class B Average	Margin to Limit (dB)
7	0.2625	47.52	PK	0.1	0	47.62	61.4	-13.78	-	-
8	0.2625	34.36	Av	0.1	0	34.46	-	-	51.4	-16.34
9	0.315	43.08	PK	0.1	0	43.18	56	-6.82	-	-
10	0.315	30.27	Av	0.1	0	30.37	-	-	46	-15.63
11	5.163	46.33	PK	0.1	0.1	46.53	60	-13.41	-	-
12	5.163	25.35	Av	0.1	0.1	25.55	-	-	50	-24.45

PK - Peak detector  
 Av - average detection

---

## 11. DYNAMIC FREQUENCY SELECTION

### 11.1. OVERVIEW

#### 11.1.1. LIMITS

##### FCC

§15.407 (h) and FCC 06-96 APPENDIX "COMPLIANCE MEASUREMENT PROCEDURES FOR UNLICENSED-NATIONAL INFORMATION INFRASTRUCTURE DEVICES OPERATING IN THE 5250-5350 MHz AND 5470-5725 MHz BANDS INCORPORATING DYNAMIC FREQUENCY SELECTION".

**Table 1: Applicability of DFS requirements prior to use of a channel**

Requirement	Operational Mode		
	Master	Client (without radar detection)	Client (with radar detection)
Non-Occupancy Period	Yes	Not required	Yes
DFS Detection Threshold	Yes	Not required	Yes
Channel Availability Check Time	Yes	Not required	Not required
Uniform Spreading	Yes	Not required	Not required

**Table 2: Applicability of DFS requirements during normal operation**

Requirement	Operational Mode		
	Master	Client (without DFS)	Client (with DFS)
DFS Detection Threshold	Yes	Not required	Yes
Channel Closing Transmission Time	Yes	Yes	Yes
Channel Move Time	Yes	Yes	Yes

**Table 3: Interference Threshold values, Master or Client incorporating In-Service Monitoring**

Maximum Transmit Power	Value (see note)
≥ 200 milliwatt	-64 dBm
< 200 milliwatt	-62 dBm

Note 1: This is the level at the input of the receiver assuming a 0 dBi receive antenna  
 Note 2: Throughout these test procedures an additional 1 dB has been added to the amplitude of the test transmission waveforms to account for variations in measurement equipment. This will ensure that the test signal is at or above the detection threshold level to trigger a DFS response.

**Table 4: DFS Response requirement values**

Parameter	Value
<i>Non-occupancy period</i>	30 minutes
<i>Channel Availability Check Time</i>	60 seconds
<i>Channel Move Time</i>	10 seconds
<i>Channel Closing Transmission Time</i>	200 milliseconds + approx. 60 milliseconds over remaining 10 second period

The instant that the *Channel Move Time* and the *Channel Closing Transmission Time* begins is as follows:  
 For the Short pulse radar Test Signals this instant is the end of the *Burst*.  
 For the Frequency Hopping radar Test Signal, this instant is the end of the last radar burst generated.  
 For the Long Pulse radar Test Signal this instant is the end of the 12 second period defining the radar transmission.  
 The Channel Closing Transmission Time is comprised of 200 milliseconds starting at the beginning of the Channel Move Time plus any additional intermittent control signals required to facilitate channel changes (an aggregate of approximately 60 milliseconds) during the remainder of the 10 second period. The aggregate duration of control signals will not count quiet periods in between transmissions.

**Table 5 – Short Pulse Radar Test Waveforms**

Radar Type	Pulse Width (Microseconds)	PRI (Microseconds)	Pulses	Minimum Percentage of Successful Detection	Minimum Trials
1	1	1428	18	60%	30
2	1-5	150-230	23-29	60%	30
3	6-10	200-500	16-18	60%	30
4	11-20	200-500	12-16	60%	30
Aggregate (Radar Types 1-4)				80%	120

**Table 6 – Long Pulse Radar Test Signal**

Radar Waveform	Bursts	Pulses per Burst	Pulse Width (µsec)	Chirp Width (MHz)	PRI (µsec)	Minimum Percentage of Successful Detection	Minimum Trials
5	8-20	1-3	50-100	5-20	1000-2000	80%	30

**Table 7 – Frequency Hopping Radar Test Signal**

Radar Waveform	Pulse Width (µsec)	PRI (µsec)	Burst Length (ms)	Pulses per Hop	Hopping Rate (kHz)	Minimum Percentage of Successful Detection	Minimum Trials
6	1	333	300	9	.333	70%	30

### 11.1.2. TEST AND MEASUREMENT SYSTEM

#### RADIATED METHOD SYSTEM BLOCK DIAGRAM

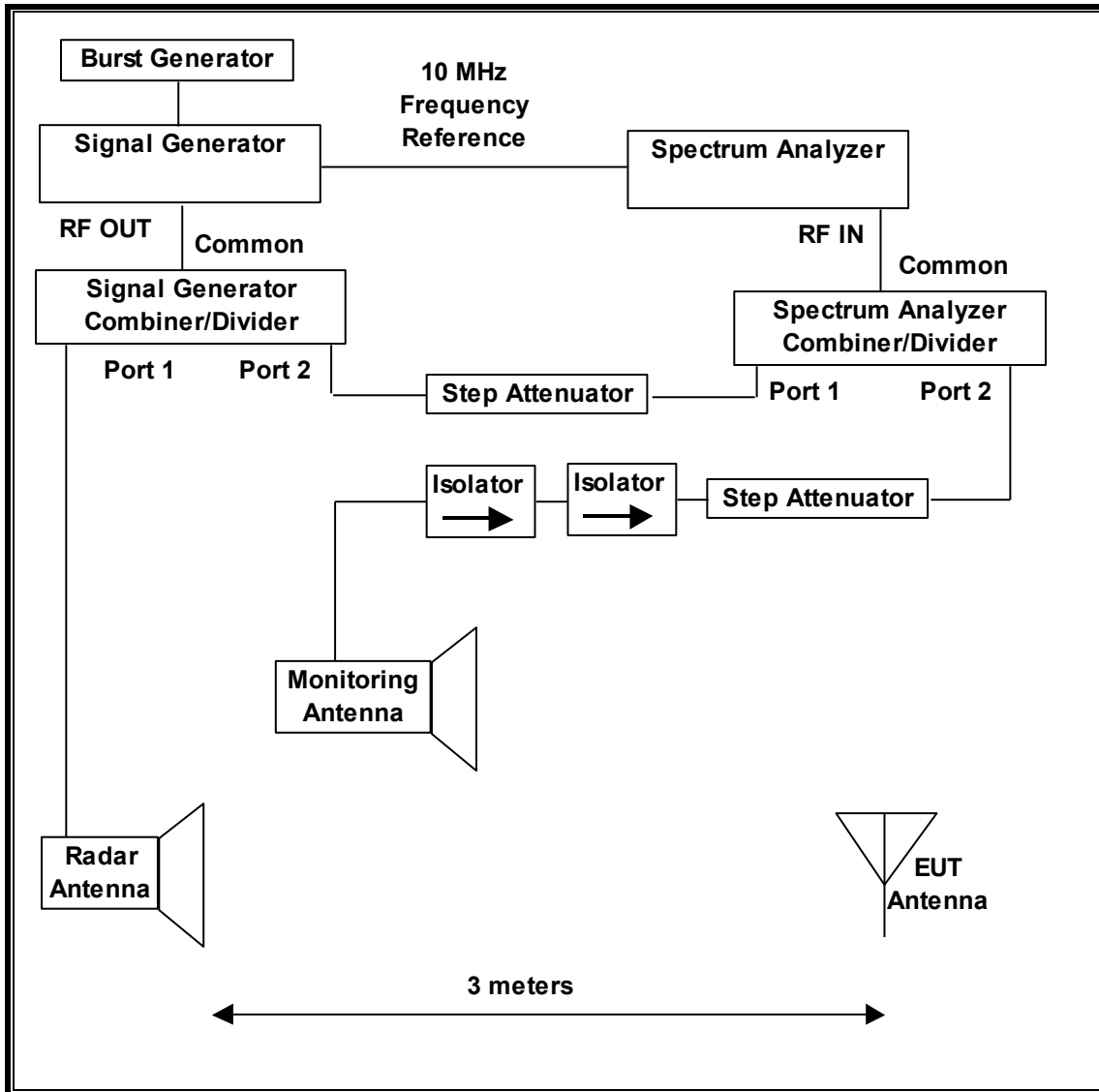



## **SYSTEM OVERVIEW**

The short pulse and long pulse signal generating system utilizes the NTIA software. The Vector Signal Generator has been validated by the NTIA. The hopping signal generating system utilizes the CCS simulated hopping method and system, which has been validated by the DoD, FCC and NTIA. The software selects waveform parameters from within the bounds of the signal type on a random basis using uniform distribution.

The short pulse types 2, 3 and 4, and the long pulse type 5 parameters are randomized at run-time.

The hopping type 6 pulse parameters are fixed while the hopping sequence is based on the August 2005 NTIA Hopping Frequency List. The initial starting point randomized at run-time and each subsequent starting point is incremented by 475. Each frequency in the 100-length segment is compared to the boundaries of the EUT Detection Bandwidth and the software creates a hopping burst pattern in accordance with Section 7.4.1.3 Method #2 Simulated Frequency Hopping Radar Waveform Generating Subsystem of FCC 06-96 APPENDIX. The frequency of the signal generator is incremented in 1 MHz steps from  $F_L$  to  $F_H$  for each successive trial. This incremental sequence is repeated as required to generate a minimum of 30 total trials and to maintain a uniform frequency distribution over the entire Detection Bandwidth.

The signal monitoring equipment consists of a spectrum analyzer. The aggregate ON time is calculated by multiplying the number of bins above a threshold during a particular observation period by the dwell time per bin, with the analyzer set to peak detection and max hold.

## **SYSTEM CALIBRATION**

A 50-ohm load is connected in place of the spectrum analyzer, and the spectrum analyzer is connected to a horn antenna via a coaxial cable, with the reference level offset set to (horn antenna gain – coaxial cable loss). The signal generator is set to CW mode. The amplitude of the signal generator is adjusted to yield a level of –64 dBm as measured on the spectrum analyzer.

Without changing any of the instrument settings, the spectrum analyzer is reconnected to the Common port of the Spectrum Analyzer Combiner/Divider. The Reference Level Offset of the spectrum analyzer is adjusted so that the displayed amplitude of the signal is –64 dBm.

The spectrum analyzer displays the level of the signal generator as received at the antenna ports of the Master Device. The interference detection threshold may be varied from the calibrated value of –64 dBm and the spectrum analyzer will still indicate the level as received by the Master Device.

**ADJUSTMENT OF DISPLAYED TRAFFIC LEVEL**

A link is established between the Master and Slave and the distance between the units is adjusted as needed to provide a suitable received level at the Master and Slave devices. The video test file is streamed to generate WLAN traffic. The monitoring antenna is adjusted so that the WLAN traffic level, as displayed on the spectrum analyzer, is at lower amplitude than the radar detection threshold.

**TEST AND MEASUREMENT EQUIPMENT**

The following test and measurement equipment was utilized for the DFS tests documented in this report:

TEST EQUIPMENT LIST				
Description	Manufacturer	Model	Asset Number	Cal Due
Spectrum Analyzer, 26.5 GHz	Agilent / HP	E4440A	C01178	09/18/13
Vector Signal Generator, 20GHz	Agilent / HP	E8267C	C01066	11/20/13

### 11.1.3. SETUP OF EUT

#### RADIATED METHOD EUT TEST SETUP

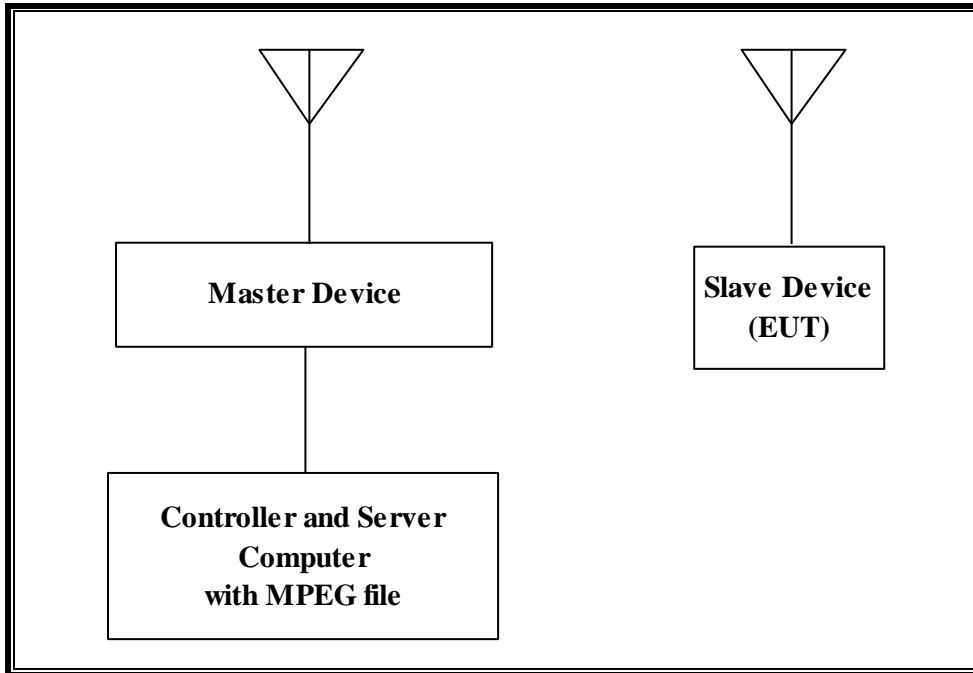

#### SUPPORT EQUIPMENT

The following support equipment was utilized for the DFS tests documented in this report:

PERIPHERAL SUPPORT EQUIPMENT LIST				
Description	Manufacturer	Model	Serial Number	FCC ID
Wireless Access Point (Master Device)	Cisco	AIR-AP1252AG-A-K9	FTX130390D9	LDK102061
AC Adapter (AP)	Delta Electronics	EADP-45BB B	DTH1049902N	DoC
Notebook PC (Controller/Server)	Apple	MacBook Pro A1150	AOU257941	DoC
AC Adapter (Controller/Server PC)	Delta Electronics	A1330	MV952157KAGKA	DoC

### 11.1.4. SETUP OF EUT (CLIENT-TO-CLIENT COMMUNICATIONS MODE)

#### RADIATED METHOD EUT TEST SETUP

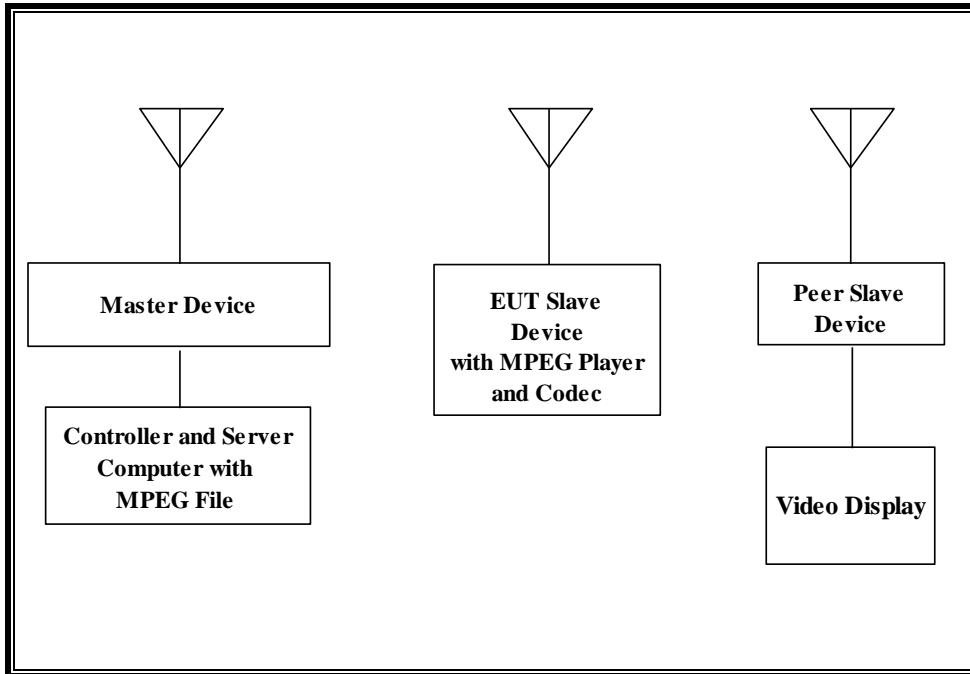

#### SUPPORT EQUIPMENT

The following support equipment was utilized for the DFS tests documented in this report:

PERIPHERAL SUPPORT EQUIPMENT LIST				
Description	Manufacturer	Model	Serial Number	FCC ID
Wireless Access Point (Master Device)	Cisco	AIR-AP1252AG-A-K9	FTX130390D9	LDK102061
AC Adapter (AP)	Delta Electronics	EADP-45BB B	DTH1049902N	DoC
Notebook PC (Controller/Server)	Apple	MacBook Pro A1150	AOU257941	DoC
AC Adapter (Controller/Server PC)	Delta Electronics	A1330	MV952157KAGKA	DoC
Apple TV (Peer Slave)	Apple	A1469	V07JV1Z7FF54	BCGA1469
Video Display	Dell	U2410f	CN-0FJ525N-72872-1B5-AGAL	DoC

### **11.1.5. DESCRIPTION OF EUT**

The EUT operates over the 5250-5350 MHz and 5470-5725 MHz ranges.

The EUT is a Slave Device without Radar Detection.

The highest power level within these bands is 22.18 dBm EIRP in the 5250-5350 MHz band and 23.57 dBm EIRP in the 5470-5725 MHz band.

The only antenna assembly consists of 2 antennas with individual gains of 2.60dBi, and 2.11 dBi in the 5250-5350 MHz band and 3.66 dBi and 3.99 dBi in the 5470-5725 MHz band.

The rated output power of the Master unit is > 23dBm (EIRP). Therefore the required interference threshold level is -64 dBm. After correction for procedural adjustments, the required radiated threshold at the antenna port is  $-64 + 1 = -63$  dBm.

The calibrated radiated DFS Detection Threshold level is set to -64 dBm. The tested level is lower than the required level hence it provides margin to the limit.

The EUT uses one transmitter/receiver chain connected to an antenna to perform radiated tests.

WLAN traffic is generated by streaming the video file TestFile.mp2 "6 ½ Magic Hours" from the Master to the Slave in full motion video mode using the media Safari web browser.

TPC is not required since the maximum EIRP is less than 500 mW (27 dBm).

The EUT utilizes the 802.11a/n architecture. Two nominal channel bandwidths are implemented: 20 MHz and 40 MHz.

The software installed in the EUT is 11B451.

### **UNIFORM CHANNEL SPREADING**

This requirement is not applicable to Slave radio devices

---

**OVERVIEW OF MASTER DEVICE WITH RESPECT TO §15.407 (h) REQUIREMENTS**

The Master Device is a Cisco Access Point, FCC ID: LDK102061. The minimum antenna gain for the Master Device is 3.5 dBi.

The rated output power of the Master unit is  $> 23\text{dBm}$  (EIRP). Therefore the required interference threshold level is  $-64\text{ dBm}$ . After correction for procedural adjustments, the required radiated threshold at the antenna port is  $-64 + 1 = -63\text{ dBm}$ .

The calibrated radiated DFS Detection Threshold level is set to  $-64\text{ dBm}$ . The tested level is lower than the required level hence it provides margin to the limit.

The software installed in the access point is 12.4(25d)JA1.

## 11.2. RESULTS FOR 20 MHz BANDWIDTH

### 11.2.1. TEST CHANNEL

All tests were performed at a channel center frequency of 5500 MHz.

### 11.2.2. RADAR WAVEFORM AND TRAFFIC

#### RADAR WAVEFORM

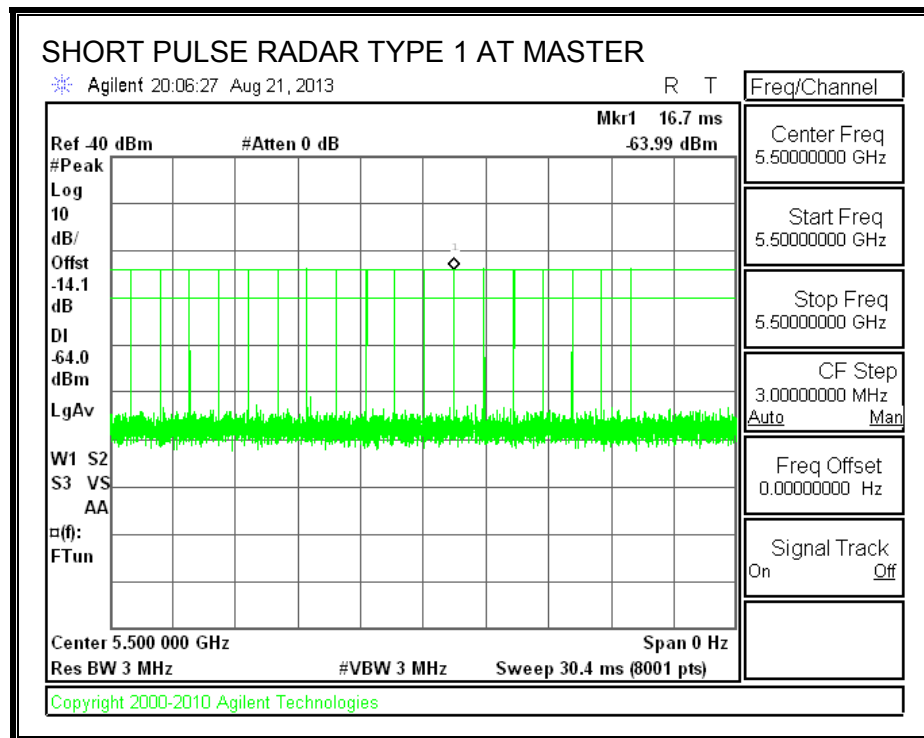

**TRAFFIC**

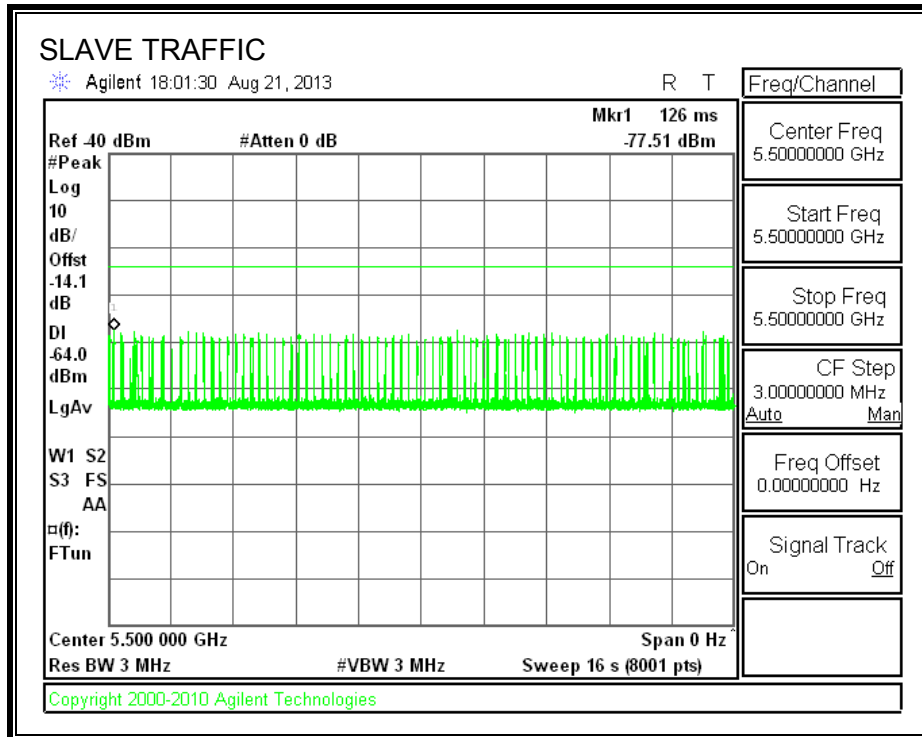



**11.2.3. OVERLAPPING CHANNEL TESTS**

**RESULTS**

These tests are not applicable.

**11.2.4. MOVE AND CLOSING TIME**

**REPORTING NOTES**

The reference marker is set at the end of last radar pulse.

The delta marker is set at the end of the last WLAN transmission following the radar pulse. This delta is the channel move time.

The aggregate channel closing transmission time is calculated as follows:

Aggregate Transmission Time =  
 (Number of analyzer bins showing transmission) \* (dwell time per bin)

The observation period over which the FCC aggregate time is calculated begins at (Reference Marker + 200 msec) and ends no earlier than (Reference Marker + 10 sec).

The observation period over which the IC aggregate time is calculated begins at (Reference Marker) and ends no earlier than (Reference Marker + 10 sec).

**RESULTS**

Agency	Channel Move Time (sec)	Limit (sec)
FCC / IC	0.158	10

Agency	Aggregate Channel Closing Transmission Time (msec)	Limit (msec)
FCC	0.0	60
IC	4.0	260

**MOVE TIME**

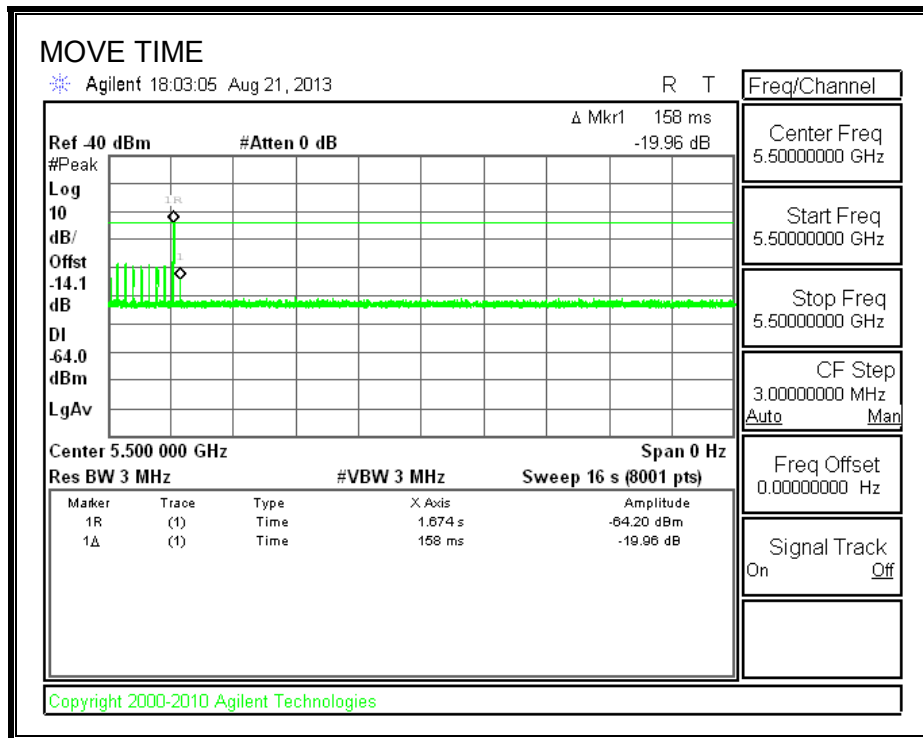

**CHANNEL CLOSING TIME**

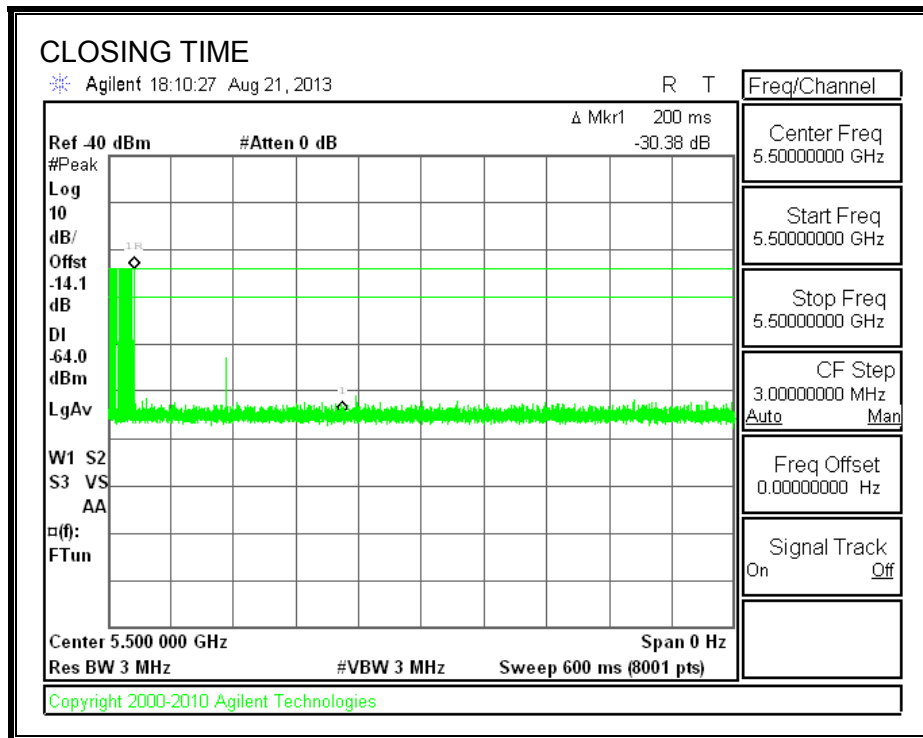

**AGGREGATE CHANNEL CLOSING TRANSMISSION TIME**

No transmission was observed during the FCC aggregate monitoring period.

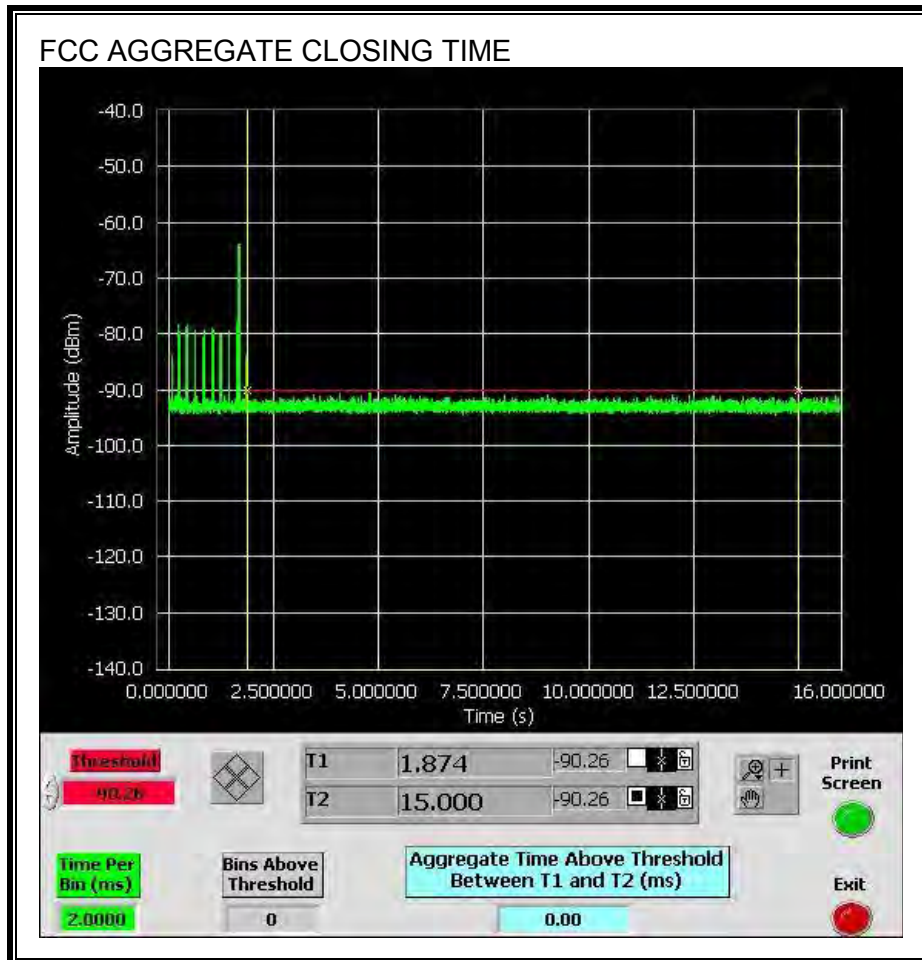

Only intermittent transmissions are observed during the IC aggregate monitoring period.

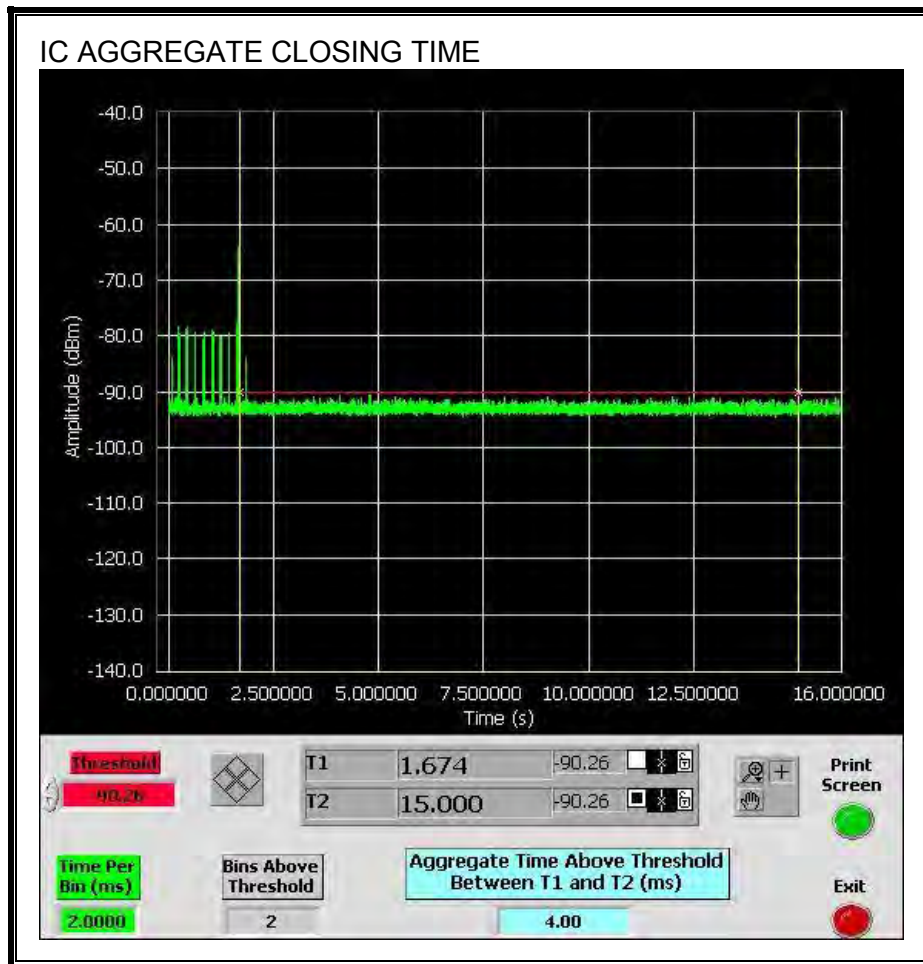

### 11.3. RESULTS FOR 40 MHz BANDWIDTH

#### 11.3.1. TEST CHANNEL

All tests were performed at a channel center frequency of 5510 MHz.

#### 11.3.2. RADAR WAVEFORM AND TRAFFIC

##### RADAR WAVEFORM

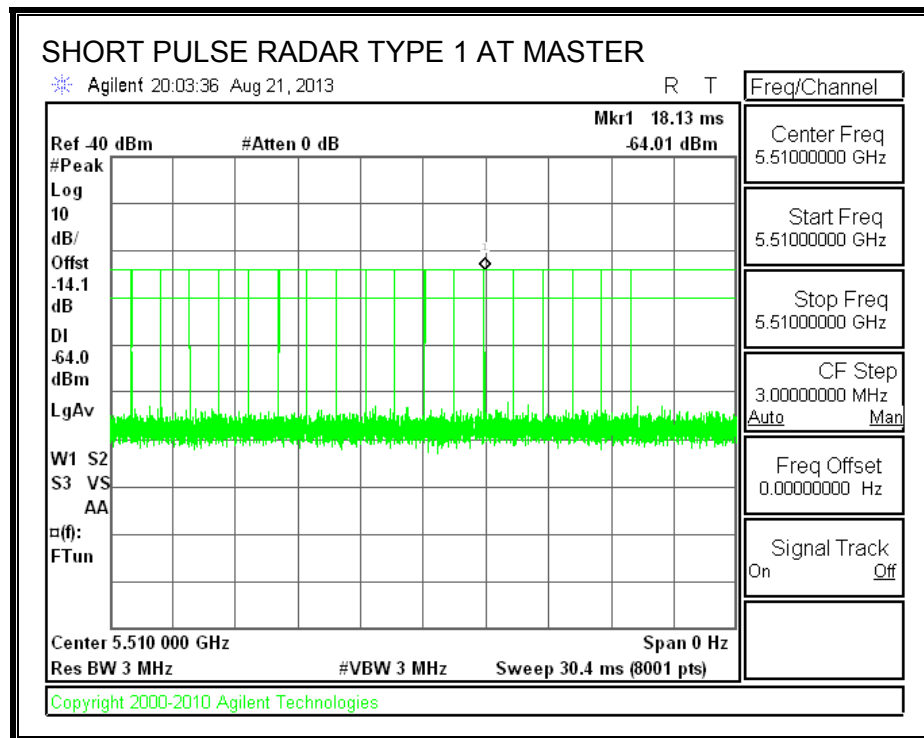

**TRAFFIC**

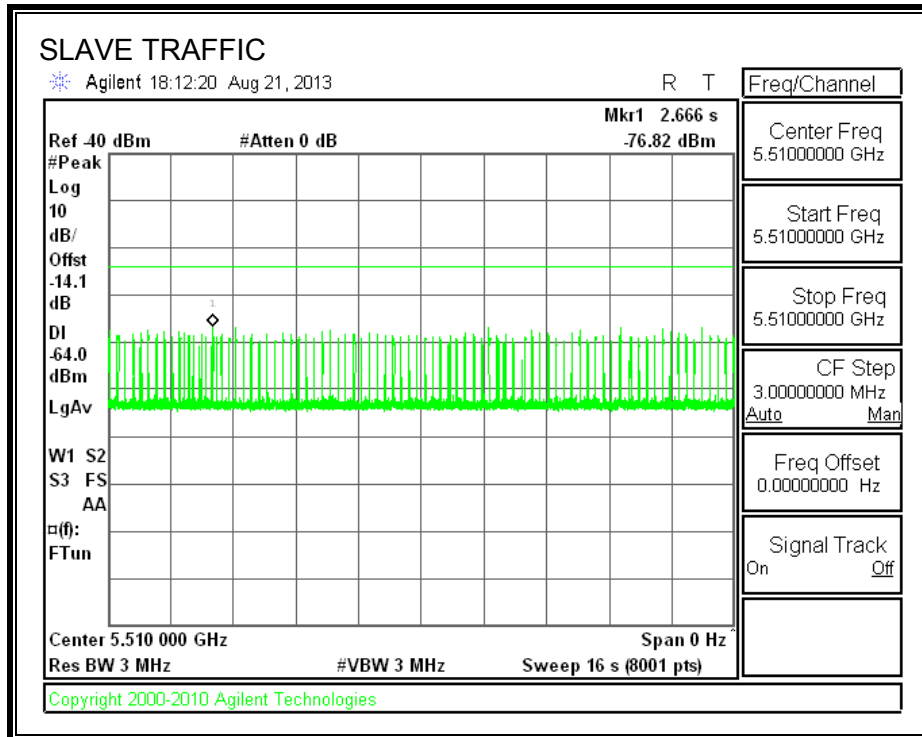

**11.3.3. OVERLAPPING CHANNEL TESTS**

**RESULTS**

These tests are not applicable.

**11.3.4. MOVE AND CLOSING TIME**

**REPORTING NOTES**

The reference marker is set at the end of last radar pulse.

The delta marker is set at the end of the last WLAN transmission following the radar pulse. This delta is the channel move time.

The aggregate channel closing transmission time is calculated as follows:

Aggregate Transmission Time =  
 (Number of analyzer bins showing transmission) \* (dwell time per bin)

The observation period over which the FCC aggregate time is calculated begins at (Reference Marker + 200 msec) and ends no earlier than (Reference Marker + 10 sec).

The observation period over which the IC aggregate time is calculated begins at (Reference Marker) and ends no earlier than (Reference Marker + 10 sec).

**RESULTS**

Agency	Channel Move Time (sec)	Limit (sec)
FCC / IC	0.040	10

Agency	Aggregate Channel Closing Transmission Time (msec)	Limit (msec)
FCC	0.0	60
IC	8.0	260



**MOVE TIME**

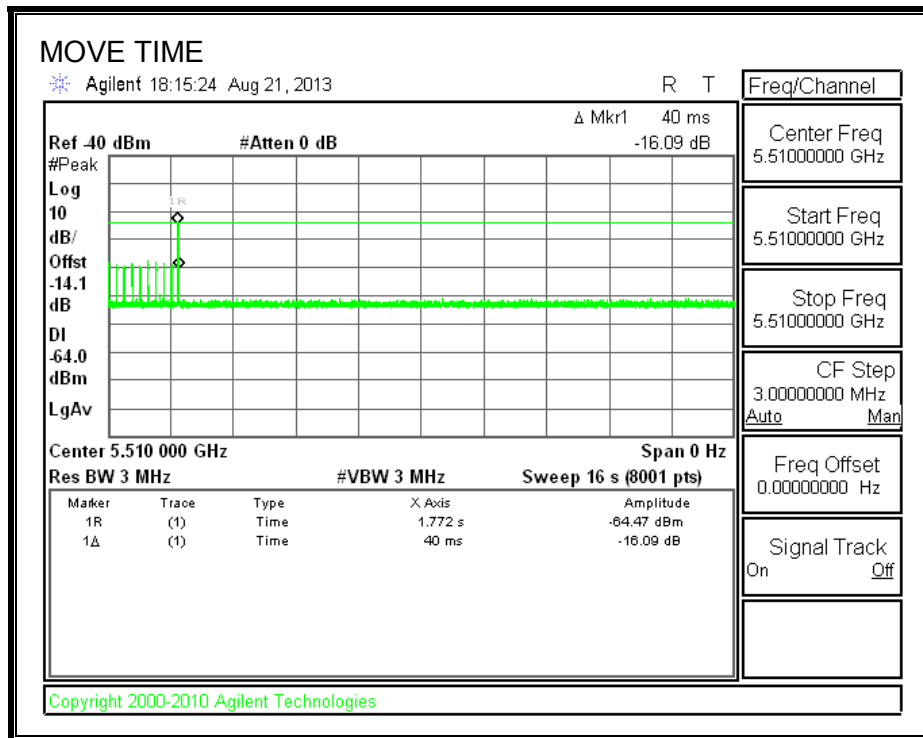

**CHANNEL CLOSING TIME**

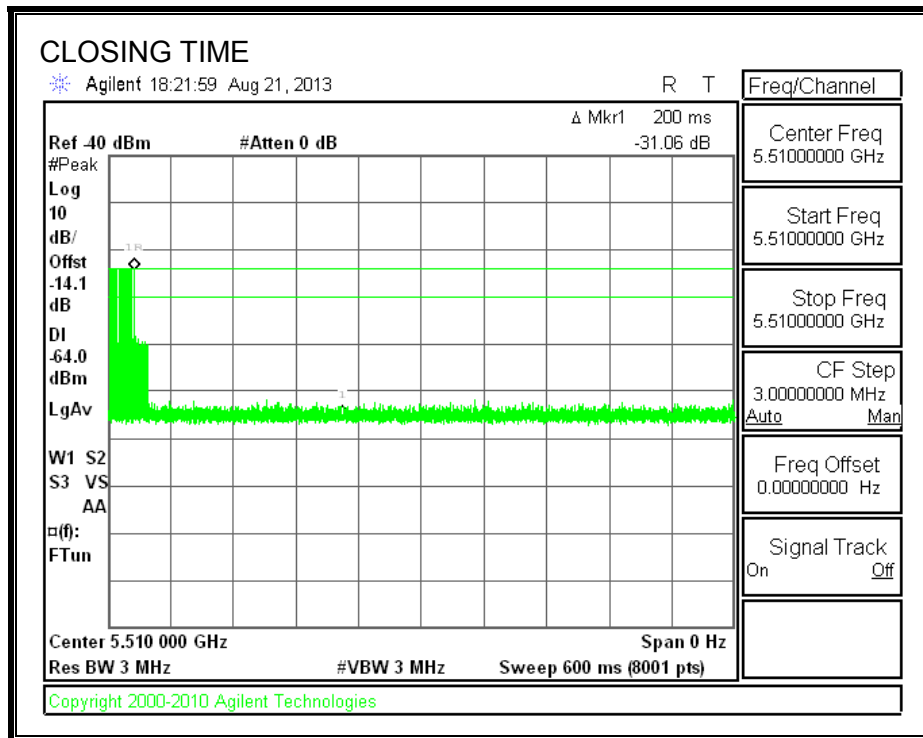

**AGGREGATE CHANNEL CLOSING TRANSMISSION TIME**

No transmission is observed during the FCC aggregate monitoring period.

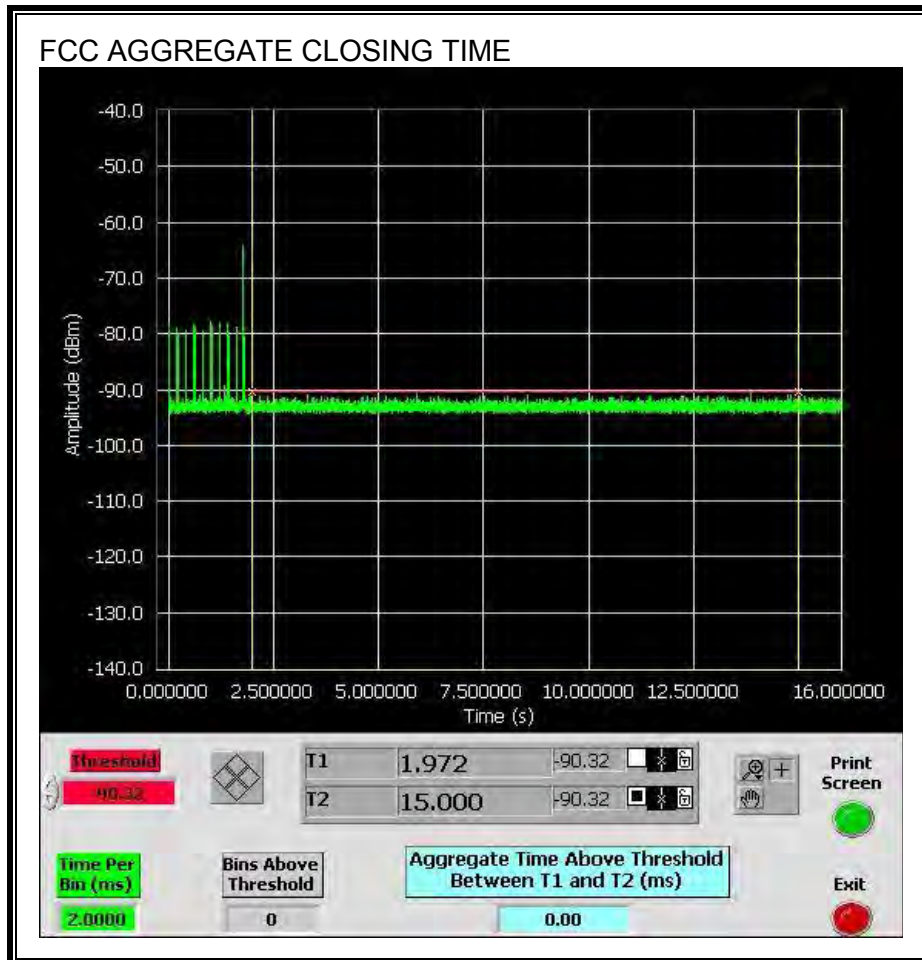

Only intermittent transmissions are observed during the IC aggregate monitoring period.

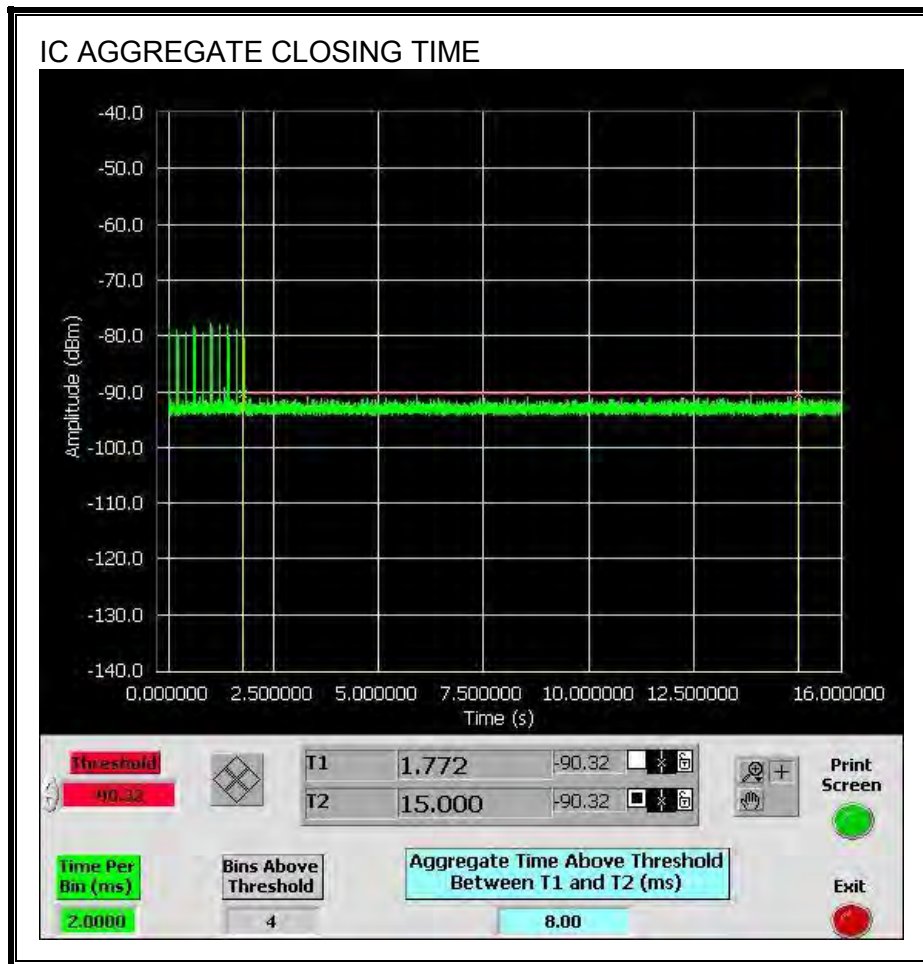

### 11.3.5. NON-OCCUPANCY PERIOD

#### RESULTS

No EUT transmissions were observed on the test channel during the 30-minute observation time.

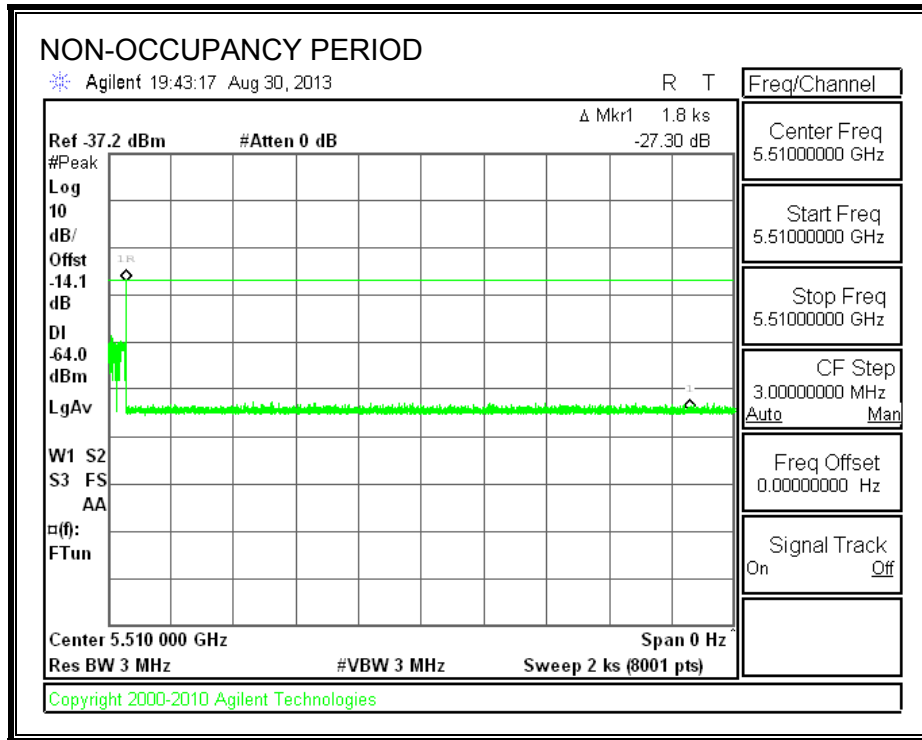

## 11.4. CLIENT-TO-CLIENT COMMUNICATIONS MODE RESULTS FOR 20 MHz BANDWIDTH

### 11.4.1. TEST CHANNEL

All tests were performed at a channel center frequency of 5500 MHz.

### 11.4.2. RADAR WAVEFORM AND TRAFFIC

#### RADAR WAVEFORM

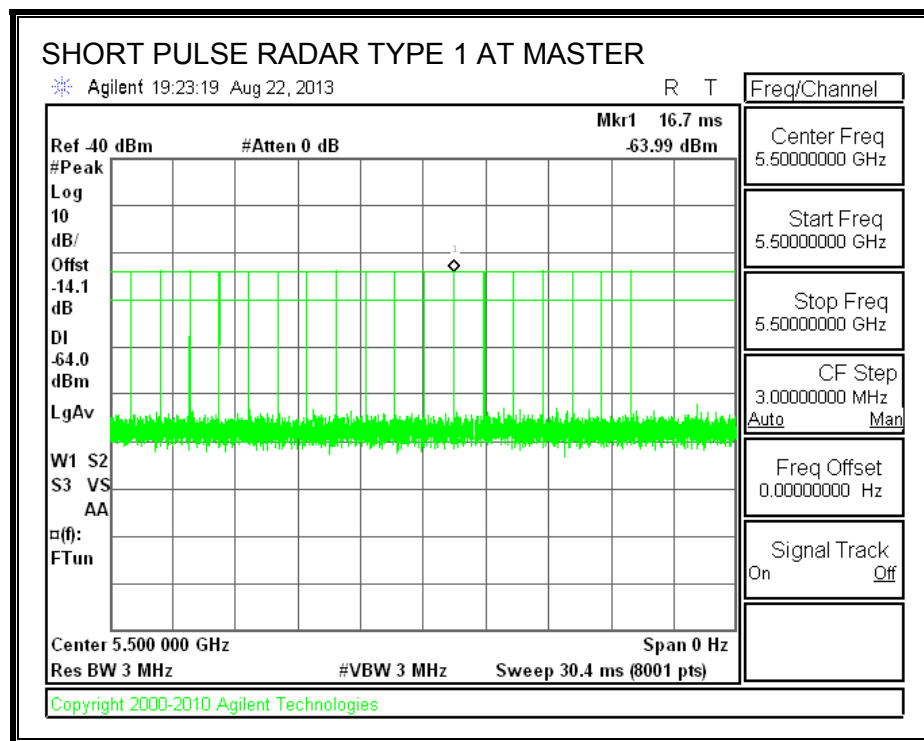

**TRAFFIC**

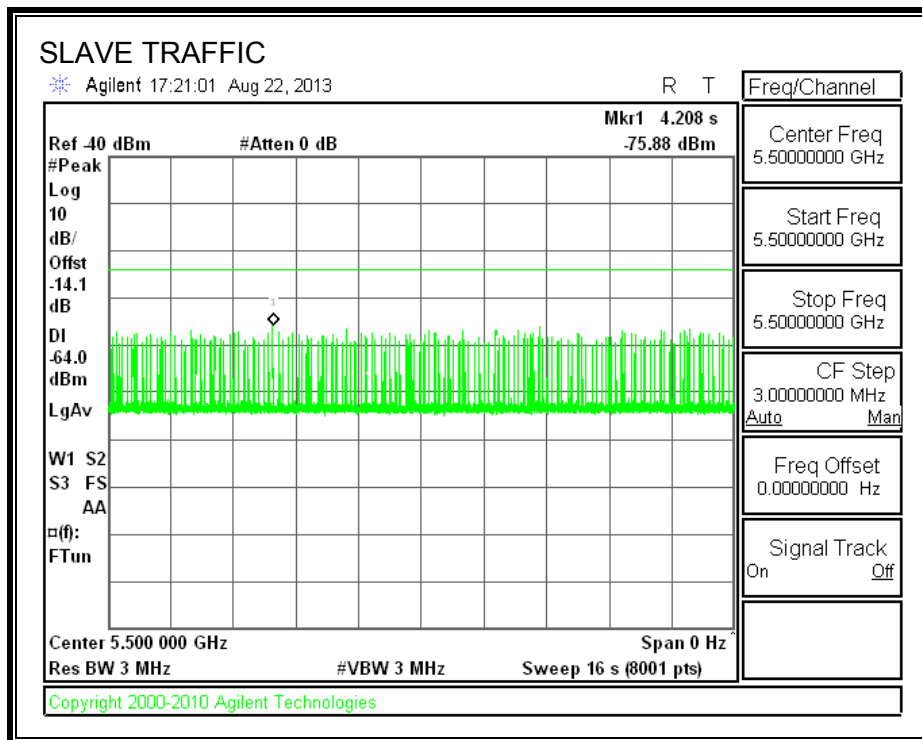

**11.4.3. OVERLAPPING CHANNEL TESTS**

**RESULTS**

These tests are not applicable.

**11.4.4. MOVE AND CLOSING TIME**

**REPORTING NOTES**

The reference marker is set at the end of last radar pulse.

The delta marker is set at the end of the last WLAN transmission following the radar pulse. This delta is the channel move time.

The aggregate channel closing transmission time is calculated as follows:

Aggregate Transmission Time =  
 (Number of analyzer bins showing transmission) \* (dwell time per bin)

The observation period over which the FCC aggregate time is calculated begins at (Reference Marker + 200 msec) and ends no earlier than (Reference Marker + 10 sec).

The observation period over which the IC aggregate time is calculated begins at (Reference Marker) and ends no earlier than (Reference Marker + 10 sec).

**RESULTS**

Agency	Channel Move Time (sec)	Limit (sec)
FCC / IC	0.040	10

Agency	Aggregate Channel Closing Transmission Time (msec)	Limit (msec)
FCC	0.0	60
IC	16.0	260



**MOVE TIME**

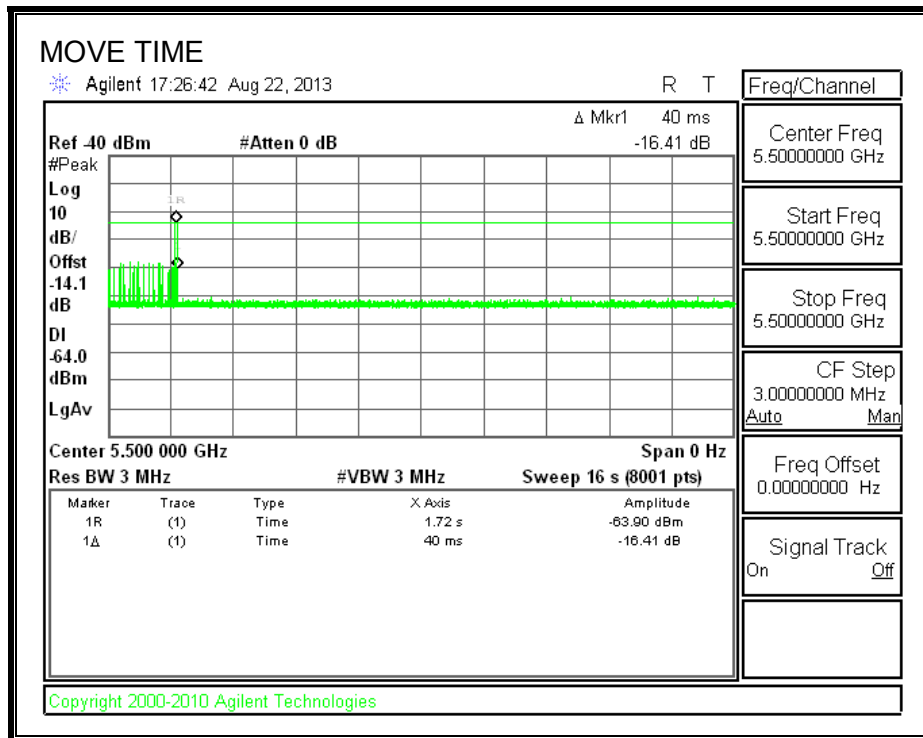

**CHANNEL CLOSING TIME**

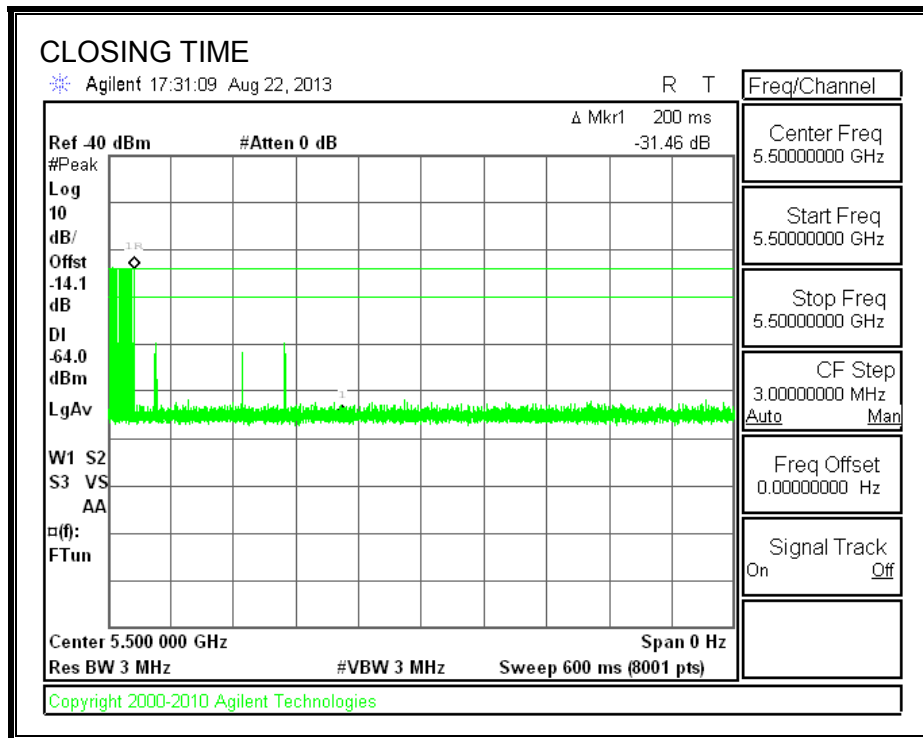

**AGGREGATE CHANNEL CLOSING TRANSMISSION TIME**

No transmissions are observed during the FCC aggregate monitoring period.

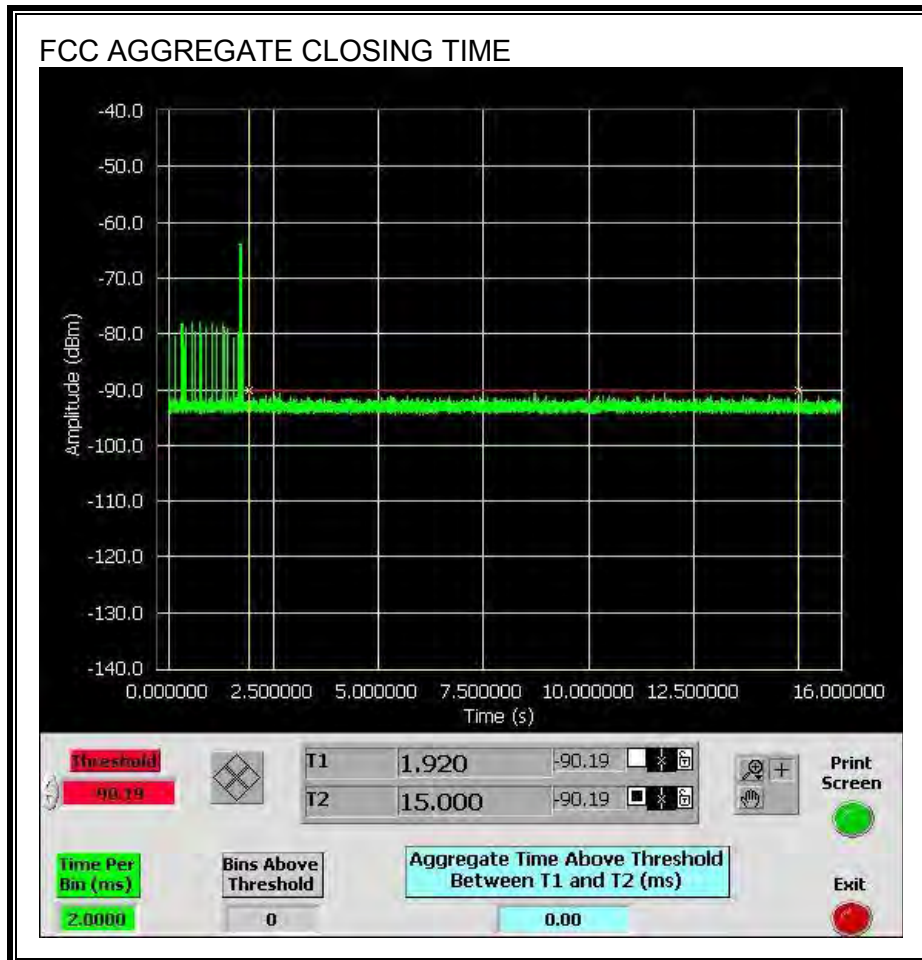

Only intermittent transmissions are observed during the IC aggregate monitoring period.

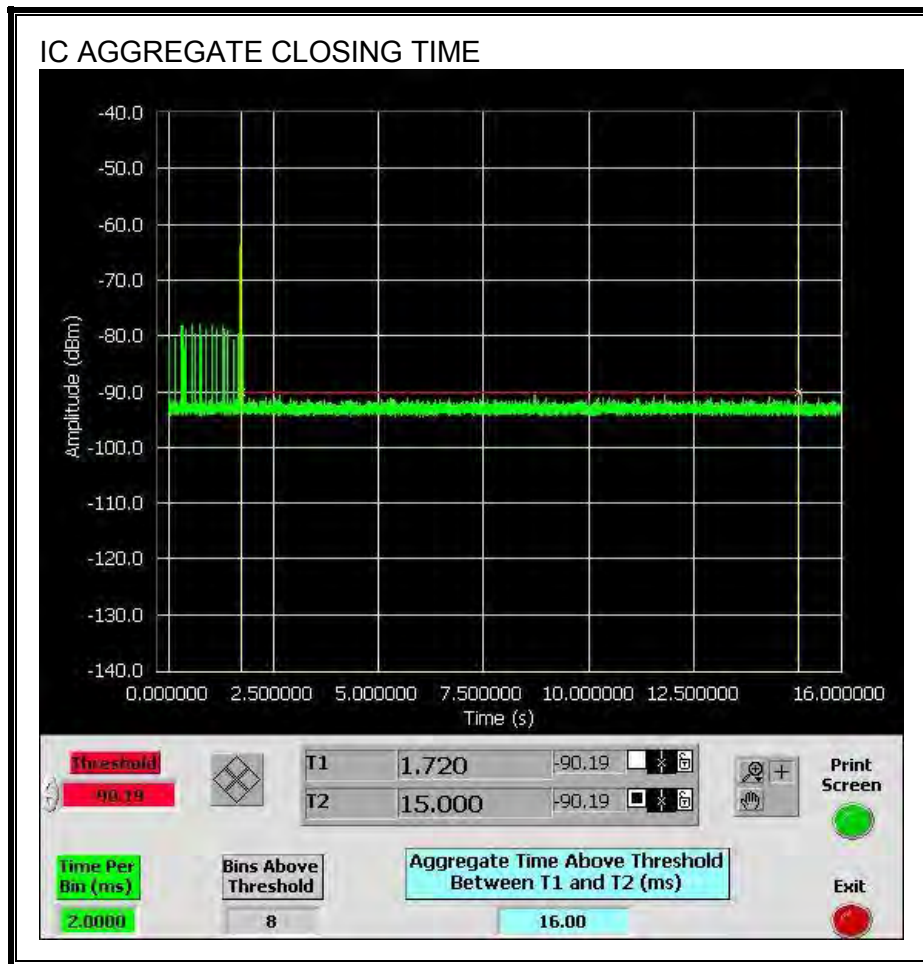

## 11.5. CLIENT-TO-CLIENT COMMUNICATIONS MODE RESULTS FOR 40 MHz BANDWIDTH

### 11.5.1. TEST CHANNEL

All tests were performed at a channel center frequency of 5510 MHz.

### 11.5.2. RADAR WAVEFORM AND TRAFFIC

#### RADAR WAVEFORM

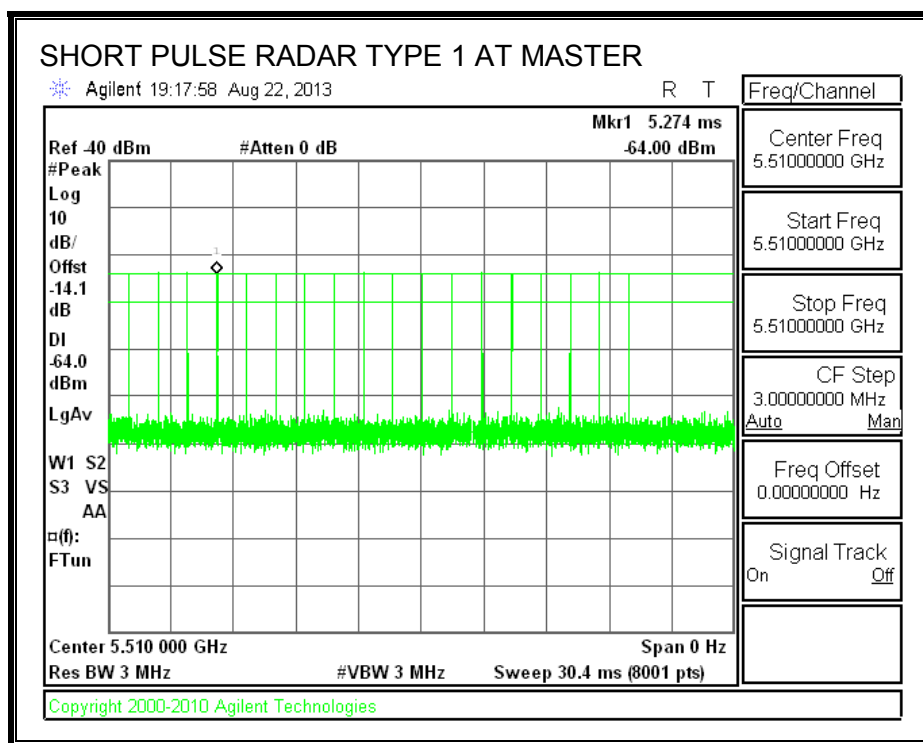

**TRAFFIC**

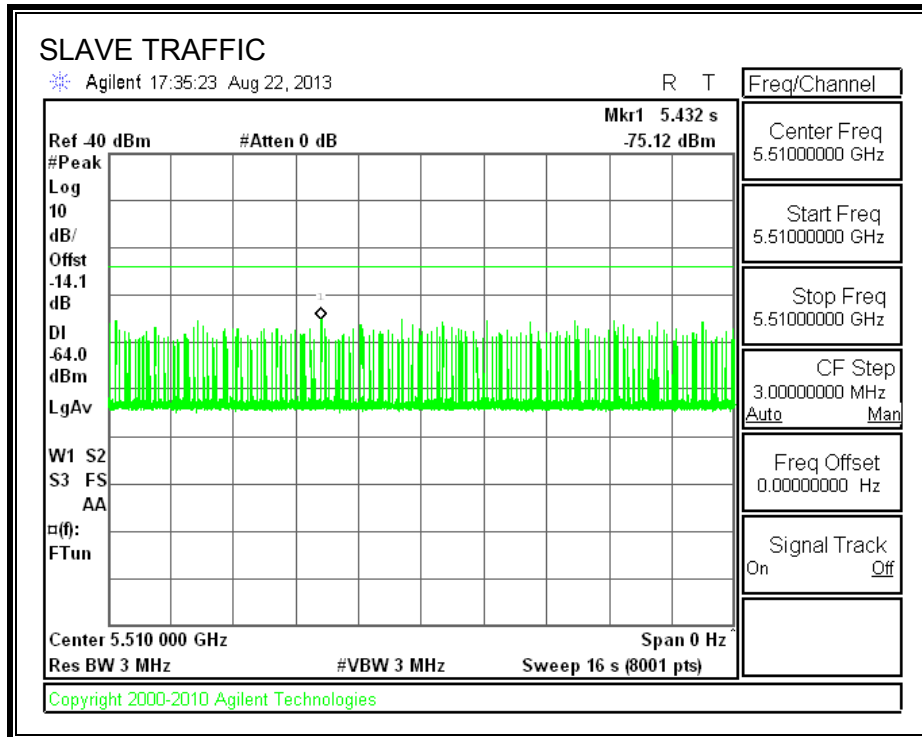

**11.5.3. OVERLAPPING CHANNEL TESTS**

**RESULTS**

These tests are not applicable.

**11.5.4. MOVE AND CLOSING TIME**

**REPORTING NOTES**

The reference marker is set at the end of last radar pulse.

The delta marker is set at the end of the last WLAN transmission following the radar pulse. This delta is the channel move time.

The aggregate channel closing transmission time is calculated as follows:

Aggregate Transmission Time =  
 (Number of analyzer bins showing transmission) \* (dwell time per bin)

The observation period over which the FCC aggregate time is calculated begins at (Reference Marker + 200 msec) and ends no earlier than (Reference Marker + 10 sec).

The observation period over which the IC aggregate time is calculated begins at (Reference Marker) and ends no earlier than (Reference Marker + 10 sec).

**RESULTS**

Agency	Channel Move Time (sec)	Limit (sec)
FCC / IC	0.206	10

Agency	Aggregate Channel Closing Transmission Time (msec)	Limit (msec)
FCC	2.0	60
IC	20.0	260

**MOVE TIME**

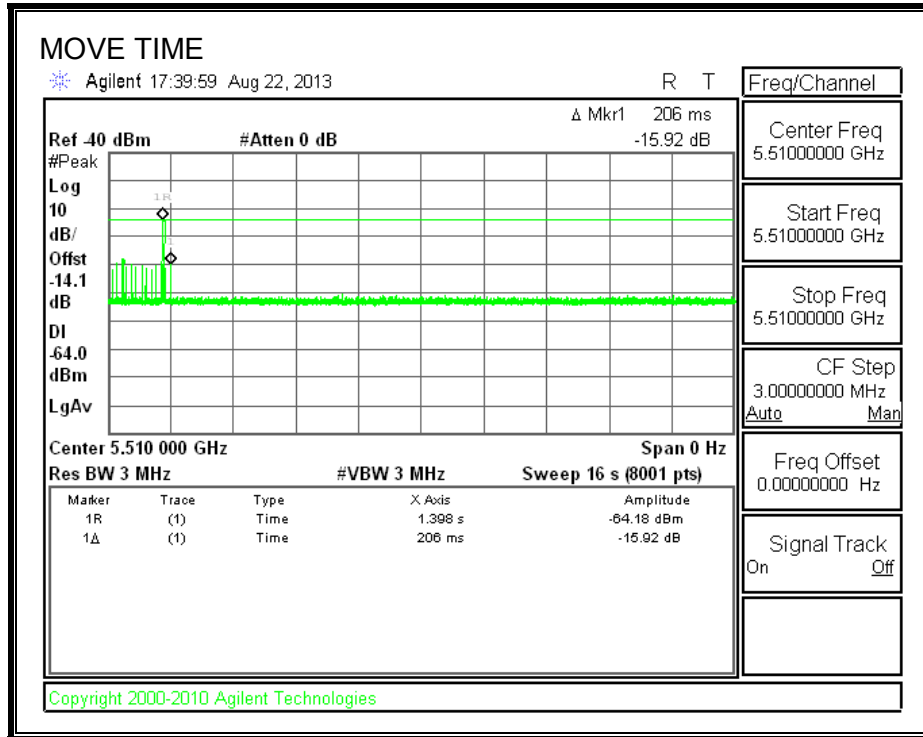



**CHANNEL CLOSING TIME**

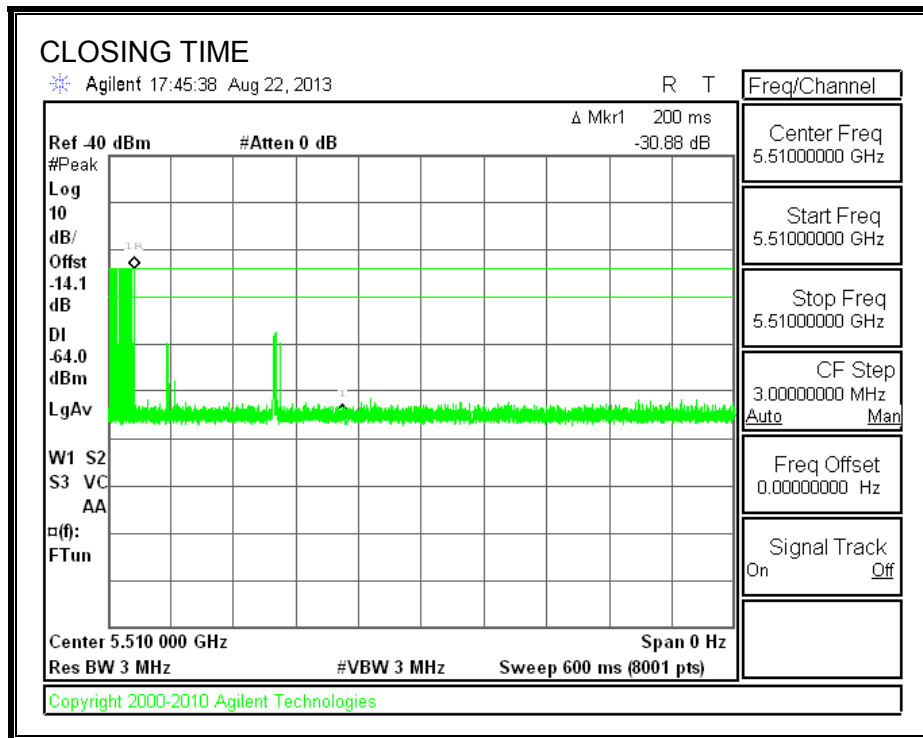

**AGGREGATE CHANNEL CLOSING TRANSMISSION TIME**

Only intermittent transmissions are observed during the FCC aggregate monitoring period.

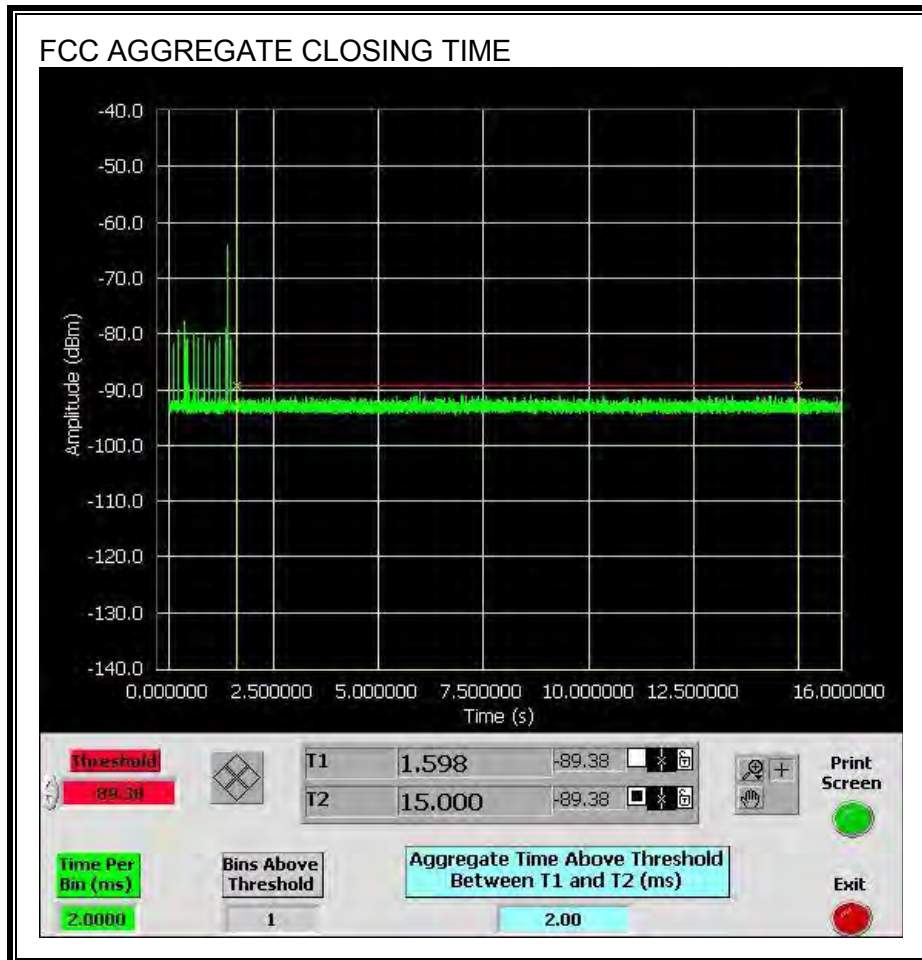

Only intermittent transmissions are observed during the IC aggregate monitoring period.

